

Rider's Manual

R 1200 RT



BMW Motorrad



The Ultimate
Riding Machine

Motorcycle data/dealership details

Motorcycle data

Model

Vehicle identification number

Colour code

Date of first registration

Registration number

Dealership details

Person to contact in Service department

Ms/Mr

Phone number

Dealership address/phone number (company stamp)

Details described or illustrated in this booklet may differ from the motorcycle's actual specification as purchased, the accessories fitted or the national-market specification. No claims will be entertained as a result of such discrepancies.

Dimensions, weights, fuel consumption and performance data are quoted to the customary tolerances.

The right to modify designs, equipment and accessories is reserved.

Errors and omissions excepted.

© 2010 BMW Motorrad

Not to be reproduced either wholly or in part without written permission from BMW Motorrad, After Sales.

Printed in Germany.

The most important data for a filling-station stop can be found in the following chart:

Fuel	
Recommended fuel grade	Premium plus unleaded 98 ROZ/RON 91 AKI
alternative fuel grade	Premium unleaded (slight power- and consumption-related restrictions) 95 ROZ/RON 89 AKI
Usable fuel capacity	approx. 25 l
Reserve fuel	approx. 4 l
Tyre pressures	
Tyre pressure, front	2.2 bar, one-up, tyre cold 2.5 bar, two-up and/or with luggage, tyre cold
Tyre pressure, rear	2.5 bar, one-up, tyre cold 2.9 bar, two-up and/or with luggage, tyre cold

BMW recommends 

Order No.: 01 41 8 521 971
04.2010, 2nd edition

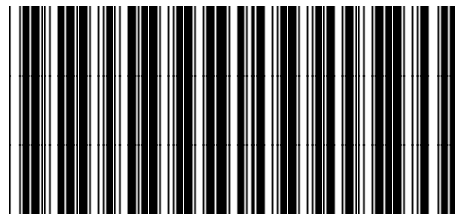

Welcome to BMW

We congratulate you on your choice of a motorcycle from BMW and welcome you to the community of BMW riders. Familiarise yourself with your new motorcycle so that you can ride it safely and confidently in all traffic situations.

Please read this Rider's Manual carefully before starting to use your new BMW motorcycle. It contains important information on how to operate the controls and how to make the best possible use of all your BMW's technical features.

In addition, it contains information on maintenance and care to help you maintain your motorcycle's reliability and safety, as well as its value.

If you have questions concerning your motorcycle, your authorised

BMW Motorrad dealer will gladly provide advice and assistance.

We hope that you will enjoy riding your BMW and that all your journeys will be pleasant and safe.

BMW Motorrad.

Table of Contents

You can also consult the index at the end of this Rider's Manual if you want to find a particular topic or item of information.

1 General instructions	5	3 Status indicators	23	4 Operation.....	47
Overview	6	Standard status indicators	24	Ignition switch and steering lock	49
Abbreviations and symbols	6	Status indicators with on-board computer	25	Electronic immobiliser	
Equipment	7	Status indicators with tyre pressure monitoring (RDC)	26	EWS	50
Technical data	7	Status indicators with grip heating	26	Clock.....	51
Currency	7	Status indicators with seat heating	26	Odometer and tripmeters	51
2 General views	9	Telltale light of cruise control	26	Multifunction display	53
General view, left side	11	Standard warnings	27	On-board computer	54
General view, right side	13	Warnings issued by the on-board computer	31	Tyre pressure monitoring	
Handlebar fitting, left	14	ABS warnings	34	RDC.....	57
Handlebar fitting, right	16	ASC warnings	36	Lights	58
Underneath the seat	19	RDC warnings.....	38	Turn indicators	58
Instrument panel	20	Anti-theft alarm warnings....	43	Hazard warning flashers	59
Headlight.....	21			Emergency off switch (kill switch)	60
				Grip heating	60
				Seat heating	61
				Automatic Stability Control	
				ASC.....	63
				Seat height.....	64
				Windscreen	64
				Cruise-control system.....	64

Stowage compartment	67	6 Engineering details.....	91	Wheels	117
Clutch	67	Brake system with BMW		Front-wheel stand.....	124
Brakes	67	Motorrad Integral ABS	92	Bulbs	125
Shift mechanism	68	Electronic engine manage-		Body panels	132
Mirrors	68	ment with BMW Motorrad		Jump starting	133
Spring preload	68	ASC.....	94	Battery	134
Damping	69	Tyre pressure monitoring		9 Care.....	139
Electronic Suspension Ad-		RDC.....	96	Care products	140
justment ESA	70	Electronic Suspension Ad-		Washing motorcycle.....	140
Tyres	72	justment ESA II	97	Cleaning easily damaged	
Headlight.....	73	7 Accessories	99	components.....	140
Front and rear seats.....	74	General instructions	100	Paint care	141
Helmet holder	76	Power sockets	100	Protective wax coating	142
5 Riding.....	79	Case	101	Laying up motorcycle	142
Safety instructions	80	topcase	103	Restoring motorcycle to	
Checklist	82	8 Maintenance	107	use	142
Starting.....	82	General instructions	108	10 Technical data	143
Running in	84	Toolkit.....	108	Troubleshooting chart.....	144
Brakes	85	Engine oil	109	Threaded fasteners	145
Parking your motorcycle	86	Brake system	110	Engine	147
Refuelling	87	Brake pads	111	Fuel	148
Secure the motorcycle for		Brake fluid.....	113	Engine oil	149
transportation	88	Clutch	115	Clutch	150
		Tyres.....	116	Transmission.....	150
		Rims	116	Rear-wheel drive	151

Running gear.....	151
Brakes	153
Wheels and tyres.....	153
Electrics	154
Frame	155
Dimensions	156
Weights	157
Riding specifications	157
11 Service	159
BMW Motorrad service....	160
BMW Motorrad service quality	160
BMW Motorrad mobility services - roadside assist- ance.....	160
BMW Motorrad service network	161
Maintenance work.....	161
Confirmation of mainten- ance work	162
Confirmation of service....	167

General instructions

Overview	6
Abbreviations and symbols	6
Equipment	7
Technical data	7
Currency	7

Overview

Chapter 2 of this Rider's Manual will provide you with an initial overview of your motorcycle. All maintenance and repair work on the motorcycle is documented in Chapter 11. This record of the maintenance work you have had performed on your motorcycle is a precondition for generous treatment of goodwill claims.

When the time comes to sell your BMW, please remember to hand over this Rider's Manual; it is an important part of the motorcycle.

Abbreviations and symbols

 Indicates warnings that you must comply with for reasons of your safety and the safety of others, and to protect your motorcycle against damage.

 Specific instructions on how to operate, control, adjust or look after items of equipment on the motorcycle.

◀ Indicates the end of an item of information.

• Instruction.

» Result of an activity.

 Reference to a page with more detailed information.

◁ Indicates the end of a passage relating to specific accessories or items of equipment.

 Tightening torque.

 Item of technical data.

OE Optional extra
The motorcycles are assembled complete with all the BMW optional extras originally ordered.

OA Optional accessory
You can obtain optional accessories through your authorised BMW Motorrad dealer; optional accessories have to be retrofitted to the motorcycle.

EWS Electronic immobiliser.

DWA Anti-theft alarm (Diebstahlwarnanlage)

ABS Anti-lock brake system

ASC Automatic Stability Control.

ESA Electronic Suspension Adjustment
Electronic Suspension Adjustment.

RDC Tyre pressure control
(ReifenDruck-Control)

Equipment

When you ordered your BMW motorcycle, you chose various items of custom equipment. This Rider's Manual describes optional extras (OE) offered by BMW and selected optional accessories (OA). This explains why the manual may also contain descriptions of equipment which you have not ordered. Please note, too, that your motorcycle might not be exactly as illustrated in this manual on account of country-specific differences.

If your BMW was supplied with equipment not described in this Rider's Manual, you will find these features described in separate manuals.

Technical data

All dimensions, weights and power ratings stated in the Rider's Manual are quoted to the standards and comply with the tolerance requirements of the Deutsches Institut für Normung e.V. (DIN). Versions for individual countries may differ.

Currency

The high safety and quality standards of BMW motorcycles are maintained by constant development work on designs, equipment and accessories. Because of this, your motorcycle may differ from the information supplied in the Rider's Manual. Nor can BMW Motorrad entirely

rule out errors and omissions. We hope you will appreciate that no claims can be entertained on the basis of the data, illustrations or descriptions in this manual.

General views

General view, left side.....	11
General view, right side	13
Handlebar fitting, left	14
Handlebar fitting, right	16
Underneath the seat	19
Instrument panel	20
Headlight	21

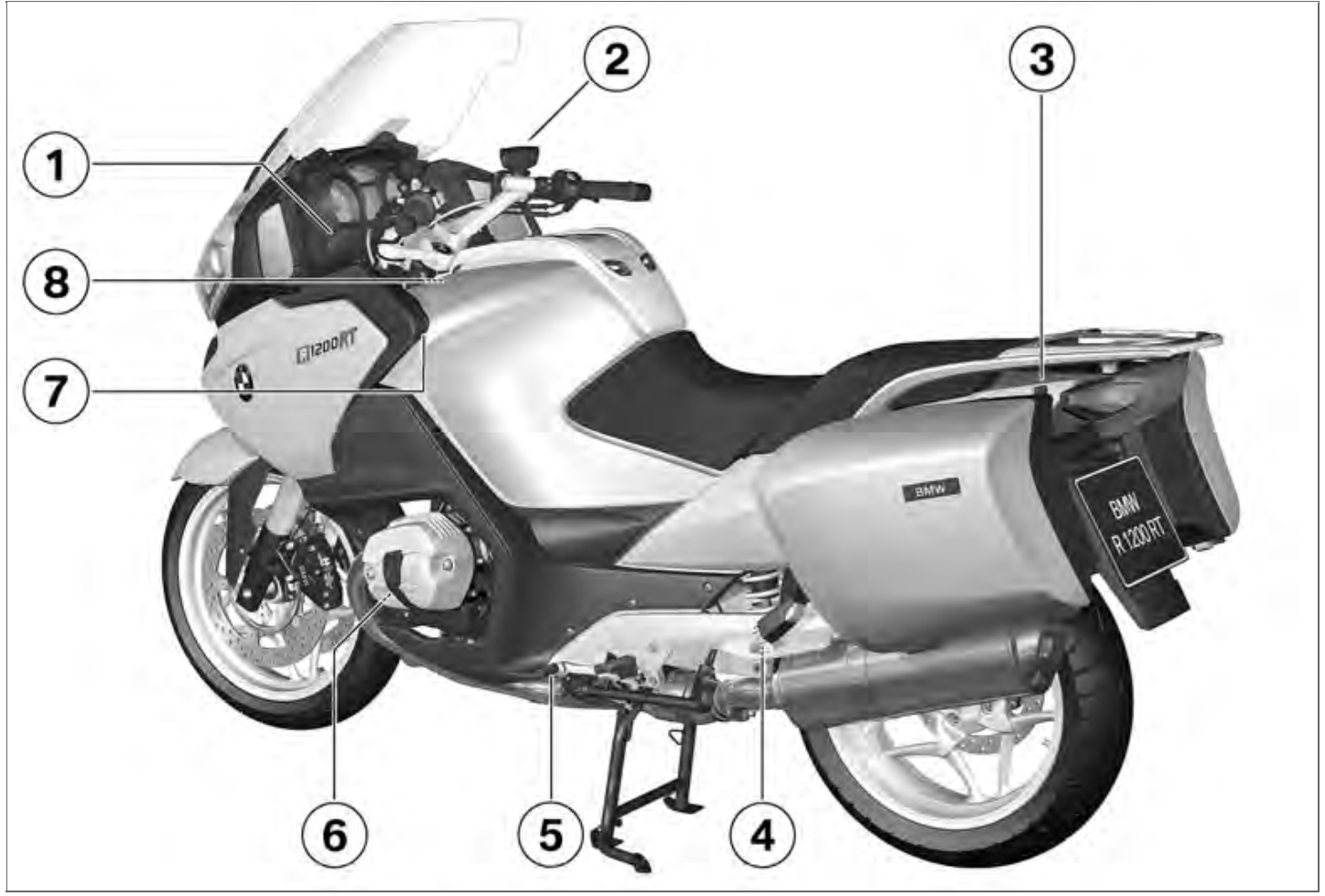

General view, left side

- 1** Headlight beam-throw adjustment (➡ 74)
- 2** Brake-fluid reservoir, front (➡ 113)
- 3** On-board socket (OE/OA) (➡ 100)
- 4** Adjuster for damping characteristic, rear suspension (➡ 69)
- 5** adjustable shift lever (➡ 68)
- 6** Engine oil level indicator (➡ 109)
- 7** Power socket (➡ 100)
- 8** Vehicle Identification Number (VIN) (on steering-head bearing)

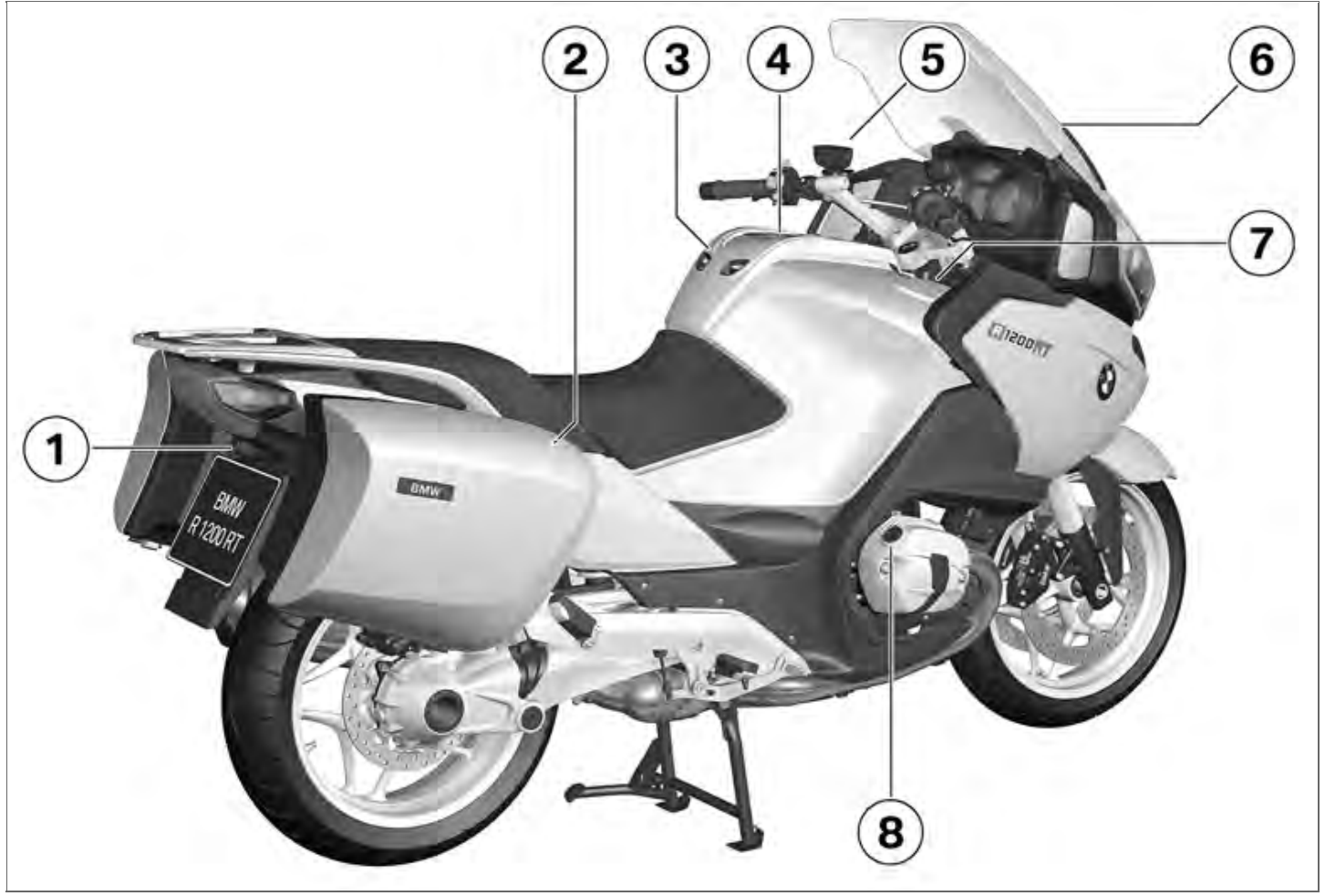

General view, right side

- 1 Seat lock (➡ 74)
- 2 – with seat heating^{OE}
Control for rear-seat heating (underneath rear seat) (➡ 62)
- 3 Tank rucksack adapter
- 4 Fuel filler neck (➡ 87)
- 5 Clutch-fluid reservoir
- 6 electrically adjustable wind-screen (➡ 64)
- 7 Storage compartment (➡ 67)
- 8 Engine-oil filler neck (➡ 110)

Handlebar fitting, left

- 1 Operation of the audio system (optional extra, see separate instructions for use)
- 2 High-beam headlight and headlight flasher (➔ 58)
- 3 – with cruise-control system^{OE}
Cruise control system control (➔ 65)
- 4 Hazard warning flashers (➔ 59)
- 5 Windscream control (➔ 64)
- 6 Operation of the flashing turn indicators (➔ 58)
- 7 Horn
- 8 – With Electronic Suspension Adjustment (ESA II)^{OE}
Operating ESA (➔ 70)
– with Automatic Stability Control (ASC)^{OE}
Operating ASC (➔ 63)
- 9
- 10

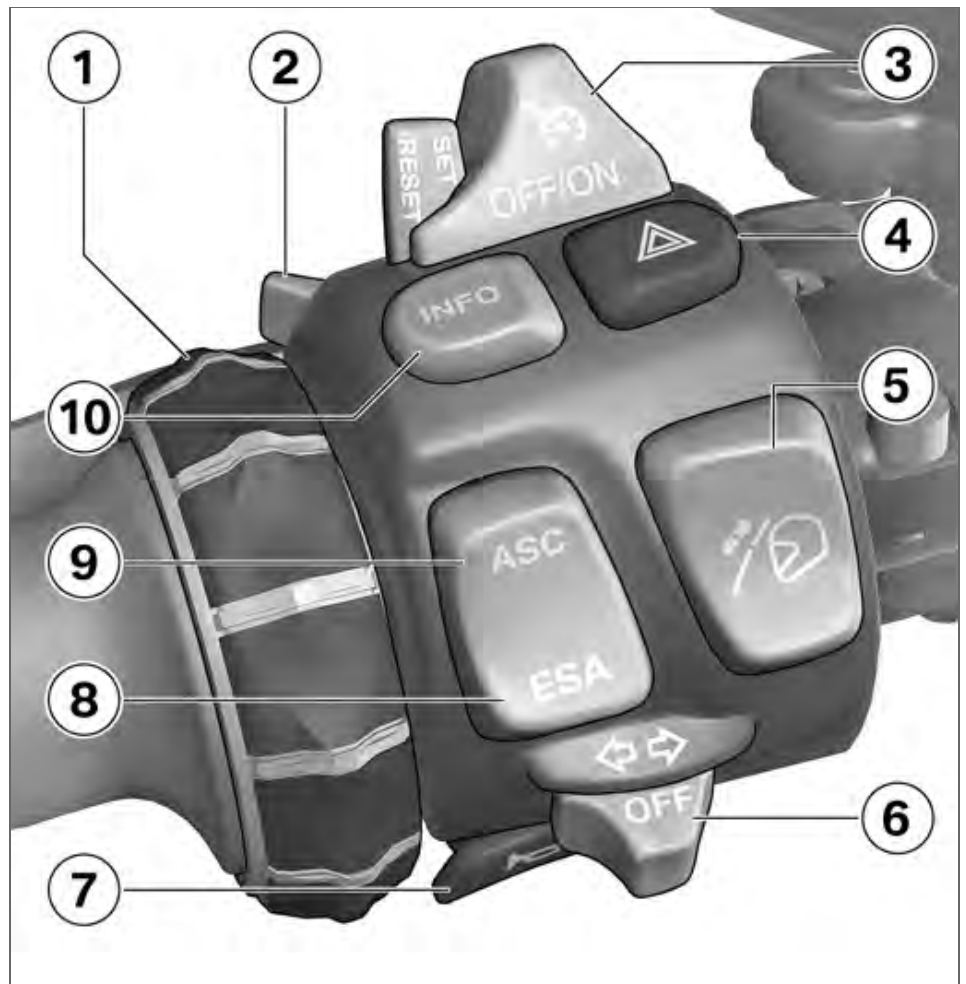

- 10** Control for the odometer
(➡ 51)
– with on-board com-
puter^{OE}
Operating the on-board
computer (➡ 54)

Handlebar fitting, right

- 1 – with heated handlebar grips^{OE}
Grip heating control (➔ 60)
- 2 – with seat heating^{OE}
Front seat heating control (➔ 61)
- 3 Emergency off switch (kill switch) (➔ 60)
- 4 Starter button (➔ 82)



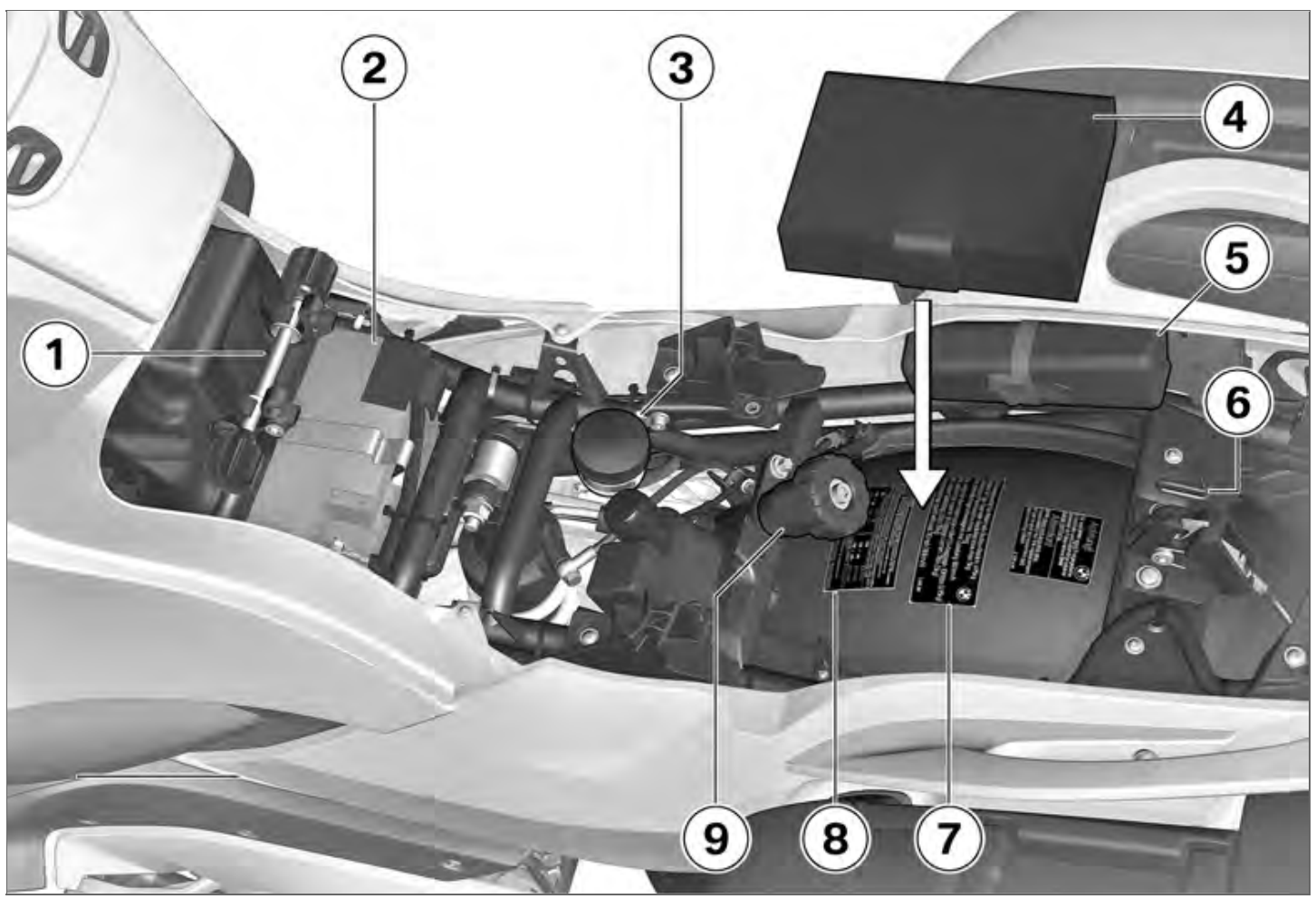

Underneath the seat

- 1 Front-seat height adjustment (➡ 64)
- 2 Battery (➡ 134)
- 3 Brake-fluid reservoir, rear (➡ 114)
- 4 Rider's Manual
- 5 Toolkit
- 6 Helmet holder (➡ 76)
- 7 Payload table
- 8 Table of tyre pressures
- 9 Adjuster for spring preload, rear (➡ 68)

Instrument panel

- 1 Speedometer
- 2 Telltale lights (→ 24)
- 3 Multifunction display (→ 24)
- 4 Rev. counter
- 5 Anti-theft alarm telltale light (OE, see separate instructions for use)
- 6 Operation of the clock (→ 51)
Adjust the dimmer (→ 53).
- 7 Control for the odometer (→ 51)
- 8 Ambient-light brightness sensor (for adapting the brightness of the instrument lighting)

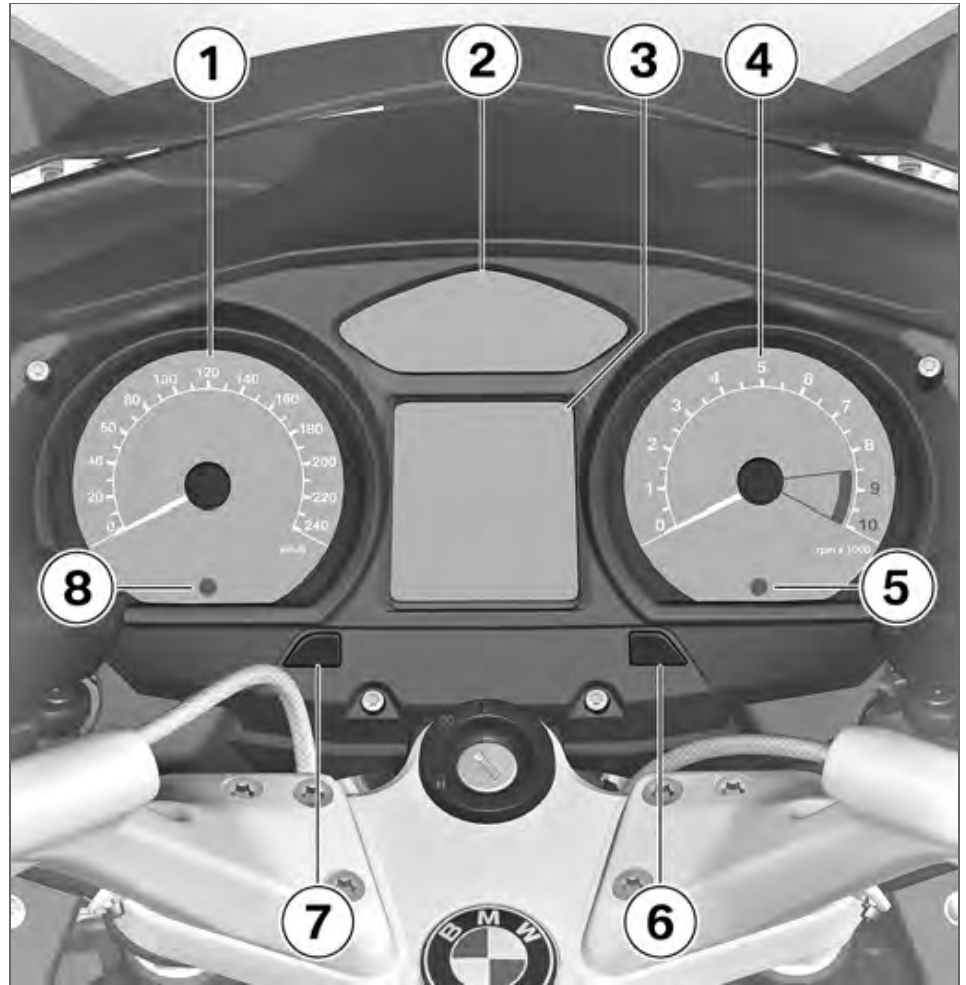

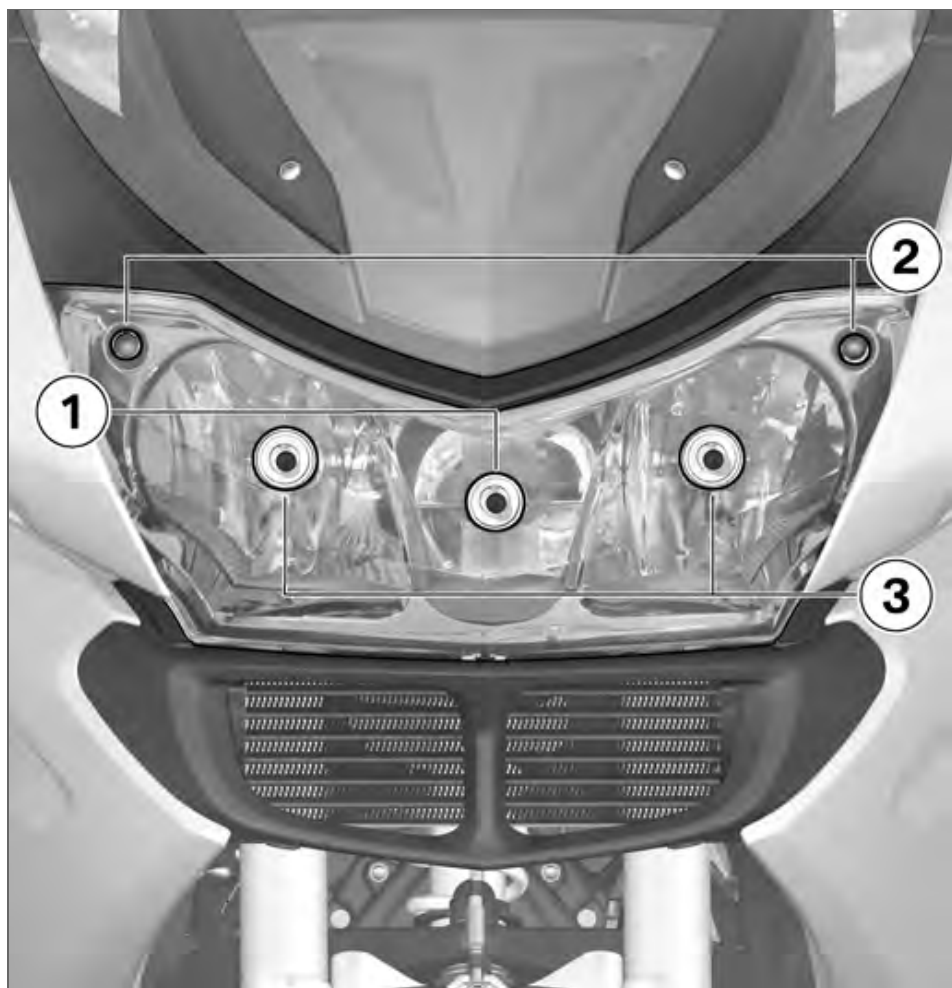

Headlight

- 1 High-beam headlight
- 2 Side light
- 3 Low-beam headlight

Status indicators

Standard status indicators	24	Anti-theft alarm warnings	43
Status indicators with on-board computer	25		
Status indicators with tyre pressure monitoring (RDC)	26		
Status indicators with grip heating	26		
Status indicators with seat heating	26		
Telltale light of cruise control	26		
Standard warnings	27		
Warnings issued by the on-board computer	31		
ABS warnings	34		
ASC warnings	36		
RDC warnings	38		

Standard status indicators

Multifunction display



- 1 Fuel capacity (→ 24)
- 2 Gear indicator (→ 24)
- 3 Engine temperature (→ 24)
- 4 Clock (→ 51)
- 5 Odometer
- 6 Trip meter (→ 51)

Telltale lights

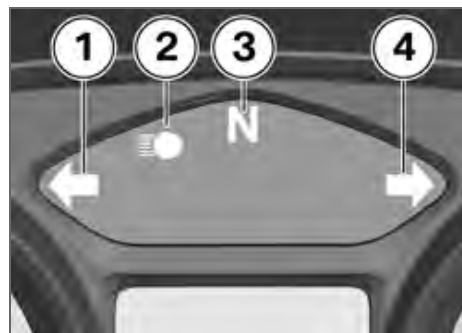

- 1 Flashing turn indicators, left
- 2 High-beam headlight
- 3 Idle
- 4 Flashing turn indicators, right

Fuel capacity

 The column below the fuel-pump symbol indicates the remaining quantity of fuel.

When the fuel in the tank is topped up the gauge briefly shows the original level, before the reading is updated.

Gear indicator

The gear engaged or N for neutral appears on the display.

 If no gear is engaged, the 'neutral' telltale light also lights up.

Engine temperature

 The column below the temperature symbol indicates the engine temperature.

Service-due indicator



If the next service is due in less than one month, the date for the next service **1** is shown briefly after the Pre-Ride Check com-

pletes. In this example the reading means "March 2010".



If the motorcycle covers long distances in the course of the year, under certain circumstances it might be necessary to have it serviced at a date in advance of the forecast due date. If the countdown distance to the odometer reading at which a service will be due is less than 1000 km, the distance is counted down in steps of 100 km **2** and is shown briefly after the Pre-Ride Check completes.

If service is overdue, the due date or the odometer reading at which service was due is accompanied by the 'General' warning light showing yellow. The word "Service" remains permanently visible.

 If the service-due indicator appears more than a month before the service date, the date saved in the instrument cluster must be adjusted. This situation can occur if the battery was disconnected for a prolonged period of time.

If you want to have the date set consult a specialist workshop, preferably an authorised BMW Motorrad dealer. ◀

Status indicators with on-board computer

– with on-board computer^{OE}



- 1** Status-indicator panel of the on-board computer (➡ 54)
- 2** The tripmeter readings alternate with the odometer reading.

Status indicators with tyre pressure monitoring (RDC)

– with tyre pressure monitoring (RDC)^{OE}



1 Tyre-pressure readout (→ 57)

The figures shown in the tyre-pressure readings are temperature-compensated (see the section entitled "Engineering details").

Status indicators with grip heating

– with heated handlebar grips^{OE}



1 Status indicator for heating stage (→ 60)

Status indicators with seat heating

– with seat heating^{OE}



1 Status indicator for heating stages (→ 61)

Telltale light of cruise control

– with cruise-control system^{OE}

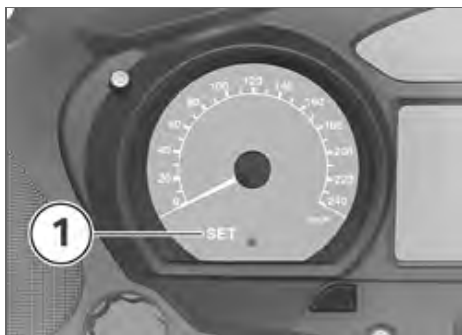

- 1** Telltale light of cruise control (→ 65)

Standard warnings Mode of presentation



Warnings are indicated by 'General' warning light **1** showing in combination with one of the warning symbols **2**. The 'General' warning light shows red or yellow, depending on the urgency of the warning.

If two or more warnings occur at the same time, all the appropriate warning lights and warning symbols appear. The status of the 'General' warning light matches the most urgent warning.















The possible warnings are listed on the next page.

Warnings, overview

Warning light

Status indicators

Meaning

	Lights up yellow		EWS ! appears on the display	Electronic immobiliser active (→ 29)
	Lights up yellow		Flashes	Fuel down to reserve (→ 29)
	Lights up yellow		Appears on the display	Engine in emergency-operation mode (→ 29)
	Flashes red		Appears on the display	Insufficient engine oil pressure (→ 30)
	Lights up red		Appears on the display	Insufficient battery charge current (→ 30)
	Lights up yellow		Appears on the display	Rear light bulb defective (→ 30)
			Appears on the display	Front light bulb defective (→ 31)
	Lights up yellow		Appears on the display	Bulbs defective (→ 31)

Electronic immobiliser active

 General warning light shows yellow.

EWS ! appears on the display.
Possible cause:

The key being used is not authorised for starting, or communication between key and engine electronics is disrupted.

- Remove all other vehicle keys from the same ring as the ignition key.
- Use the reserve key.
- Have the defective key replaced, preferably by an authorised BMW Motorrad dealer.

Fuel down to reserve

 General warning light shows yellow.

 Reserve fuel level symbol flashes.

 Lack of fuel can result in the engine misfiring and cutting out unexpectedly. Misfiring can damage the catalytic converter; a hazardous situation can result if the engine cuts out unexpectedly.

Do not run the fuel tank dry.◀

Possible cause:

The fuel tank contains no more than the reserve quantity of fuel.

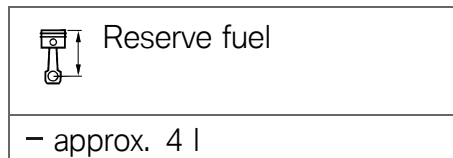

- Refuelling (➔ 87).

Engine in emergency-operation mode

 General warning light shows yellow.

 Engine symbol appears on the display.

 The engine is running in emergency operating mode.

Full engine power or full engine rpm might not be available and this can cause hazardous situations, particularly if you attempt to overtake other road users. Engine power level might be lower than normal: adapt your style of riding accordingly.◀

Possible cause:

The engine control unit has diagnosed a fault. In exceptional cases, the engine stops and refuses to start. Otherwise, the engine runs in emergency operating mode.

- You can continue to ride, but bear in mind that the usual engine power might not be available.
- Have the fault rectified as quickly as possible by a specialist workshop, preferably

an authorised BMW Motorrad dealer.

Insufficient engine oil pressure

 General warning light flashes red.

 Oil-can symbol appears on the display.

The oil pressure in the lube-oil system is too low. Stop immediately and switch off the engine.

 The insufficient oil pressure warning does not fulfil the function of an oil gauge. The only way of checking whether the oil level is correct is to check the oil level indicator. ◀

Possible cause:

The engine-oil level is too low.

- Checking engine oil level (➡ 109).

If the oil level is too low:

- Top up the engine oil.

Possible cause:

The engine-oil pressure is insufficient.

 Riding when engine-oil pressure is low can result in engine damage.

Do not continue your journey. ◀

- Have the fault rectified as quickly as possible by a specialist workshop, preferably an authorised BMW Motorrad dealer.

Insufficient battery charge current

 General warning light shows red.

 Battery symbol appears on the display.

 A discharged battery can render various systems unavailable, for example the lights,

the engine or the ABS. This can result in dangerous situations. If possible, do not continue your journey. ◀

Possible cause:

Alternator or alternator drive belt defective

- Have the fault rectified as quickly as possible by a specialist workshop, preferably an authorised BMW Motorrad dealer.

Rear light bulb defective

 General warning light shows yellow.

 Bulb symbol with arrow pointing to the rear appears on the display.

 A defective bulb places your safety at risk because it is easier for other users to oversee the motorcycle. Replace defective bulbs as soon as possible; always carry a

complete set of spare bulbs if possible.◀

Possible cause:

Rear light or brake light bulb defective.

- Replacing brake-light, rear-light and rear-indicator bulbs (⇒ 128).

Front light bulb defective



Bulb symbol with arrow pointing to the front appears on the display.



A defective bulb places your safety at risk because it is easier for other users to oversee the motorcycle.

Replace defective bulbs as soon as possible; always carry a complete set of spare bulbs if possible.◀

Possible cause:

Low-beam headlight, high-beam headlight, side light or turn indicator bulb defective.

- Replacing low-beam and high-beam headlight bulb (⇒ 125).
- Replacing parking-light bulb (⇒ 127).
- Replacing front turn indicator bulb (⇒ 130).
- Replacing brake-light, rear-light and rear-indicator bulbs (⇒ 128).

Bulbs defective



General warning light shows yellow.



Bulb symbol with two arrows appears on the display.



A defective bulb places your safety at risk because it is easier for other users to oversee the motorcycle.

Replace defective bulbs as

soon as possible; always carry a complete set of spare bulbs if possible.◀

Possible cause:

A combination of the bulb defects described above has occurred.

- See the fault descriptions above.

Warnings issued by the on-board computer

Mode of presentation

– with on-board computer^{OE}





Warnings issued by the on-board computer appear in panel **1**.
The possible warnings are listed on the next page.

Warnings, overview

Warning light

Status indicators

Meaning

	Oil appears on the display.	Engine-oil level too low (→ 34)
	Appears on the display	
	Ambient-temperature reading flashes.	Ice warning (→ 34)
	Flashes	

Engine-oil level too low

Oil appears on the display.

 Oil-level symbol appears on the display.

Possible cause:

The electronic oil-level sensor has registered an excessively low oil level. Check the engine-oil level at the oil-level indicator the next time you stop to refuel:

- Checking engine oil level (➔ 109).
- If the oil level is too low:
- Top up the engine oil (➔ 110).

Possible cause:

The oil sensor might be defective if the "Check oil level" message appears even though a check at the oil sight glass reveals that the oil level is correct.

- Seek the advice of a specialist workshop, preferably an authorised BMW Motorrad dealer.

Ice warning

The ambient-temperature reading flashes.

 Ice-crystal symbol flashes.

Possible cause:

The air temperature measured at the motorcycle is lower than 3 °C.

 The ice warning does not mean that there is no risk of black ice forming at measured temperatures above 3 °C.

Always take extra care when temperatures are low; remember that the danger of black ice forming is particularly high on bridges and where the road is in shade.◀

- Ride carefully and think well ahead.

ABS warnings

Mode of presentation



ABS warnings are indicated by ABS warning light **1**.

The way in which the ABS warning light indicates status can differ in some countries.

 Possible national variant.

The detailed descriptions relating to BMW Motorrad Integral ABS start on page (➔ 92), and you will find an overview listing the possible warnings on the next page.

Warnings, overview

Warning light

Status indicators

Meaning

	Flashes	Self-diagnosis not completed (→ 36)
	Lights up	ABS fault (→ 36)

Self-diagnosis not completed

 ABS warning light flashes.

Possible cause:

The ABS function is not available, because self-diagnosis did not complete. The motorcycle has to move forward a few metres for the wheel sensors to be tested.

- Pull away slowly. Bear in mind that the ABS function is not available until self-diagnosis has completed.

ABS fault

 ABS warning light shows.

Possible cause:

The ABS control unit has detected a fault. The ABS function is not available.

- You can continue to ride the motorcycle, but make due provision for the fact that the ABS function is not available. Bear in mind the more detailed information on situations that can lead to an ABS fault (➔ 93).
- Have the fault rectified as quickly as possible by a specialist workshop, preferably an authorised BMW Motorrad dealer.

ASC warnings

Mode of presentation

- with Automatic Stability Control (ASC)^{OE}

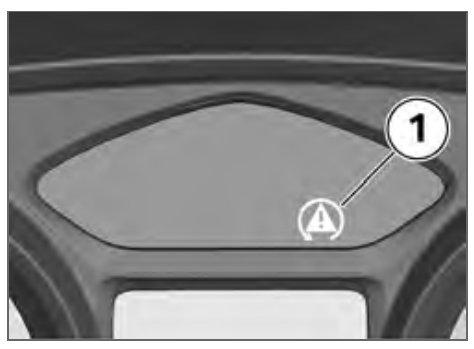





ASC warnings are indicated by ASC warning light **1**. The detailed descriptions relating to BMW Motorrad ASC start on page (➔ 94), and you will find an overview listing the possible warnings on the next page.

Warnings, overview

Warning light

Status indicators

Meaning

	Quick-flashes	ASC intervention (→ 38)
	Slow-flashes	Self-diagnosis not completed (→ 38)
	Lights up	ASC deactivated (→ 38)
	Lights up	ASC fault (→ 38)

ASC intervention



ASC warning light quick-flashes.

The ASC has detected a degree of instability at the rear wheel and has intervened to reduce torque. The warning light flashes for longer than ASC intervention lasts. This affords the rider visual feedback on control intervention even after the critical situation has been dealt with.

Self-diagnosis not completed



ASC warning light slow-flashes.

Possible cause:

Self-diagnosis did not complete, so the ASC function is not available. The engine must be running and the motorcycle must reach a speed of at least 5 km/h in order for ASC self-diagnosis to complete.

- Pull away slowly. Bear in mind that the ASC function is not available until self-diagnosis has completed.

ASC deactivated



ASC warning light shows.

Possible cause:

The rider has switched off the ASC system.

- with Automatic Stability Control (ASC)^{OE}
- Activating ASC function (➔ 63).

ASC fault



ASC warning light shows.

Possible cause:

The ASC control unit has detected a fault. The ASC function is not available.

- You can continue to ride. Bear in mind that the ASC function

is not available. Bear in mind the more detailed information on situations that can lead to an ASC fault (➔ 95).

- Have the fault rectified as quickly as possible by a specialist workshop, preferably an authorised BMW Motorrad dealer.

RDC warnings

Mode of presentation

- with tyre pressure monitoring (RDC)^{OE}

The tyre-pressure readings are based on a reference tyre temperature of 20 °C (➔ 97).<

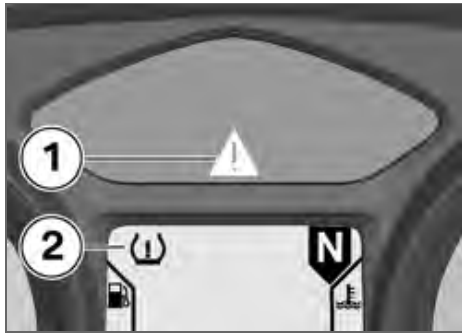

Warning symbol **2** indicates a critical tyre pressure, and the corresponding reading on the display flashes.

If the critical value is close to the limit of the permissible tolerance range, 'General' warning light **1** shows yellow. If the tyre pressure registered by the sensor is outside the permissible tolerance range, the general warning light **1** flashes red.

The tyre pressures for front wheel **3** and rear wheel **4** are shown. The graphic here indicates that the reading for the front wheel is flashing, which means that pressure in the front tyre has reached a critical value.









The detailed descriptions relating to BMW Motorrad RDC start on page (➔ 96), and you will find an overview listing the possible warnings on the next page.

Warnings, overview

Warning light

Status indicators

Meaning

	Lights up yellow		Appears on the display	Tyre pressure close to limit of permitted tolerance (→ 41)
			The critical pressure flashes.	
	Flashes red		Appears on the display	Tyre pressure outside permitted tolerance (→ 41)
			The critical pressure flashes.	
			"--" or "-- --" is displayed.	Signal transmission disrupted (→ 42)
	Lights up yellow		Appears on the display	Sensor defective or system error (→ 42)
			"--" or "-- --" is displayed.	
	Lights up yellow		RDC appears on the display	Tyre-pressure sensor battery weak (→ 43)
			Appears on the display	

Tyre pressure close to limit of permitted tolerance



General warning light shows yellow.



Tyre symbol appears on the display.

The critical pressure flashes.

Possible cause:

Measured tyre pressure is close to the limit of permitted tolerance.

- Correct the tyre pressure as stated on the inside cover of the Rider's Manual.



Before you adjust tyre pressure, read the information on temperature compensation and adjusting pressure in the section entitled "Engineering details".◀

Tyre pressure outside permitted tolerance



General warning light flashes red.



Tyre symbol appears on the display.

The critical pressure flashes.

Possible cause:

Measured tyre pressure is outside permitted tolerance.

- Check the tyre for damage and to ascertain whether the motorcycle can be ridden with the tyre in its present condition.

If the motorcycle can be ridden with the tyre in its present condition:



Incorrect tyre pressures impair the motorcycle's handling characteristics.

If tyre pressure is incorrect it is essential to adapt your style of riding accordingly.◀

- Correct the tyre pressure at the earliest possible opportunity.



Before you adjust tyre pressure, read the information on temperature compensation and adjusting pressure in the section entitled "Engineering details".◀

- Have the tyre checked for damage by a specialist workshop, preferably an authorised BMW Motorrad dealer.

If you are unsure whether the motorcycle can be ridden with the tyre in its present condition:

- Do not continue your journey.
- Notify the breakdown service.
- Have the tyre checked for damage by a specialist workshop, preferably an authorised BMW Motorrad dealer.

Signal transmission disrupted

"--" or "-- --" is displayed.
Possible cause:

The motorcycle has not yet accelerated past the threshold of approximately 30 km/h. The RDC sensors do not start transmitting signals until the motorcycle reaches a speed above this threshold for the first time (➔ 96).

- Increase speed above this threshold and observe the RDC readings. Assume that a permanent fault has not occurred unless the 'General' warning light comes on to accompany the symptoms. Under these circumstances:
- Have the fault rectified by a specialist workshop, preferably an authorised BMW Motorrad dealer.

Possible cause:
Wireless communication with the RDC sensors has been disrupted. Possible causes include radio-communication systems operating in the vicinity and interfering with the link between the RDC control unit and the sensors.

- Move to another location and observe the RDC readings. Assume that a permanent fault has not occurred unless the 'General' warning light comes on to accompany the symptoms. Under these circumstances:
- Have the fault rectified by a specialist workshop, preferably an authorised BMW Motorrad dealer.

Sensor defective or system error

 General warning light shows yellow.

 Tyre symbol appears on the display.

"--" or "-- --" is displayed.
Possible cause:

Motorcycle is fitted with wheels not equipped with RDC sensors.

- Fit wheels and tyres equipped with RDC sensors.

Possible cause:
One or two RDC sensors have failed.

- Have the fault rectified by a specialist workshop, preferably an authorised BMW Motorrad dealer.

Possible cause:
A system error has occurred.

- Have the fault rectified by a specialist workshop, preferably an authorised BMW Motorrad dealer.

Tyre-pressure sensor battery weak

 General warning light shows yellow.

RDC appears on the display.

 Battery symbol appears on the display.

 This error message appears only briefly after the pre-ride check completes. ◀

Possible cause:

The integral battery in the tyre-pressure sensor has lost a significant proportion of its original capacity. There is no assurance of how long the tyre pressure control system can remain operational.

- Seek the advice of a specialist workshop, preferably an authorised BMW Motorrad dealer.

Anti-theft alarm warnings

Mode of presentation

– with anti-theft alarm (DWA)^{OE}



Anti-theft alarm warnings **2** appear in combination with 'General' warning light **1** showing after the Pre-Ride Check and relate to the capacity of the internal battery that supplies power to the anti-theft alarm.



The possible warnings are listed on the next page.

Warnings, overview

Warning light

Status indicators

Meaning

Warning light	Status indicators	Meaning
	 Appears on the display	Anti-theft alarm battery weak (→ 45)
 Lights up yellow	 Appears on the display	Anti-theft alarm battery flat (→ 45)

Anti-theft alarm battery weak



Battery symbol appears on the display.



This error message appears only briefly after the pre-ride check completes.◀

Possible cause:

The integral battery in the anti-theft alarm has lost a significant proportion of its original capacity. There is no assurance of how long the anti-theft alarm can remain operational if the motorcycle's battery is disconnected.

- Seek the advice of a specialist workshop, preferably an authorised BMW Motorrad dealer.

Anti-theft alarm battery flat



General warning light shows yellow.



Battery symbol appears on the display.



This error message appears only briefly after the pre-ride check completes.◀

Possible cause:

The integral battery in the anti-theft alarm has lost its entire original capacity. There is no assurance that the anti-theft alarm will be operational if the motorcycle's battery is disconnected.

- Seek the advice of a specialist workshop, preferably an authorised BMW Motorrad dealer.

Operation

Ignition switch and steering lock	49	Seat height	64
Electronic immobiliser EWS	50	Windscreen	64
Clock	51	Cruise-control system	64
Odometer and tripmeters	51	Stowage compartment	67
Multifunction display	53	Clutch	67
On-board computer	54	Brakes	67
Tyre pressure monitoring RDC	57	Shift mechanism	68
Lights	58	Mirrors	68
Turn indicators	58	Spring preload	68
Hazard warning flashers	59	Damping	69
Emergency off switch (kill switch)	60	Electronic Suspension Adjustment ESA	70
Grip heating	60	Tyres	72
Seat heating	61	Headlight	73
Automatic Stability Control ASC	63	Front and rear seats	74

Helmet holder 76

Ignition switch and steering lock

Keys

You receive two master keys and one spare key. Please consult the information on the electronic immobiliser (EWS) if a key is lost or mislaid (➔ 50).

Ignition switch and steering lock, tank filler cap lock and the seat and case locks are all operated with the same key.

– with topcase^{OA}

If you wish you can arrange to have the topcase fitted with a lock that can be opened with this key as well. Consult a specialist workshop, preferably an authorised BMW Motorrad dealer.◁

Switching on ignition



- Turn the key to position **1**.
 - » Parking lights and all function circuits switched on.
 - » Engine can be started.
 - » Pre-ride check is performed. (➔ 83)
 - » ABS self-diagnosis is performed. (➔ 83)
- with Automatic Stability Control (ASC)^{OE}
 - » ASC self-diagnosis is performed. (➔ 84)

Switch off the ignition

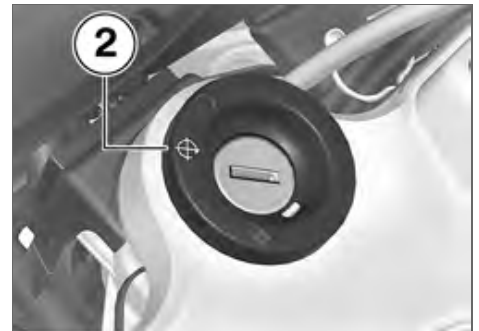

- Turn the key to position **2**.
 - » Lights switched off.
 - » Handlebars not locked.
 - » Key can be removed.
 - » Electrically powered accessories remain operational for a limited period of time.
 - » The battery can be recharged via the socket.

Locking handlebars

 If the motorcycle is on the side stand, the surface of the ground will determine whether it is better to turn the handle-

bars to the left or right. However, the motorcycle is more stable on a level surface with the handlebars turned to the left than with the handlebars turned to the right.

On level ground, always turn the handlebars to the left to set the steering lock.◀

- Turn the handlebars to the full left or right lock position.



- Turn the key to position **3**, while moving the handlebars slightly.

- » Ignition, lights and all function circuits switched off.
- » Handlebars locked.
- » Key can be removed.

Electronic immobiliser EWS

The motorcycle's electronics exchange certain continuously changing signals with the electronics in the key; these signals are specific to your motorcycle and they are transmitted via the ring aerial in the ignition lock. The ignition is not enabled for starting until the engine control unit has recognised the key as "authorised" for your motorcycle.

▶ A spare key attached to the same ring as the ignition key used to start the engine could "irritate" the electronics, in which case the enabling signal for starting is not issued.

The EWS warning appears in the multifunction display. Always keep the spare key separately from the ignition key.◀

If you mislay a key you can have the key in question barred by your authorised BMW Motorrad dealer. In order to have a key barred you must bring along all the other keys belonging to the motorcycle.

The engine cannot be started by a barred key, but a key that has been barred can subsequently be reactivated.

You can obtain replacement/extra keys only through an authorised BMW Motorrad dealer. The keys are part of an integrated security system, so the dealer is under an obligation to check the legitimacy of all applications for replacement/extra keys.

Clock

Setting clock

 Attempting to set the clock while riding the motorcycle can lead to accidents. Set the clock only when the motorcycle is stationary. ◀

- Switch on the ignition.



- Press and hold down button **1** until the hours number **2** flashes.
- Repeatedly press the button until the hours number is correct.

- Press and hold down the button until the minutes number **3** flashes.
- Repeatedly press the button until the minutes number is correct.
- Hold down the button until the minutes number stops flashing.
» This completes the process.

Odometer and tripmeters

Select the readings

- Switch on the ignition.



- Repeatedly press **1** until the desired value appears in panel **2**.



The following values can be displayed in panel **2**:

- Tripmeter 1 (Trip I)

- Tripmeter 2 (Trip II)
 - Residual range (RANGE, once fuel level is down to reserve)
 - with tyre pressure monitoring (RDC)^{OE}
- Tyre pressures (RDC)
- with on-board computer^{OE}



- Repeatedly press **1** until the desired value appears in panel **3**.



The following values can be displayed in panel **3**:

- Tripmeter 1 (Trip I)
- Tripmeter 2 (Trip II)
- Total distance travelled (DIST).<

Resetting tripmeter

- Switch on the ignition.
- Select the desired tripmeter.



- Press and hold down button **1** until the tripmeter reading is reset.

Residual range

- without on-board computer^{OE}



The residual-range readout **1** indicates how far you can ride with the fuel remaining in the tank. This reading is not displayed until fuel level has dropped to reserve. This distance is calculated on the basis of fuel level and average consumption.

When refuelling after running on reserve, make sure that you top up the tank to a level above reserve, as otherwise the sensor will not be able to register the new level. If the sensor cannot register the new level the residual-range readout cannot be updated.

 The calculated range is an approximate value. Consequently, BMW Motorrad recommends that you should not try to use the full residual range before refuelling.◀

Multifunction display

Adjust the dimmer

 Attempting to adjust the dimmer while riding the motorcycle can lead to accidents. Do not attempt to adjust the dimmer unless the motorcycle is at a standstill.◀

- Switch on the ignition.



- Press button **1**.
 - » The current level of dimming appears in display field **2**.
- Repeatedly press button **1** until the desired dimming level appears on the display.
 - » The brightness of the display increases one level each time you press the button. Each time you press the button after maximum brightness is reached, brightness is reduced by one level.

On-board computer

– with on-board computer^{OE}

Select the readings

- Switch on the ignition.



- Repeatedly press button **1** until the reading shows the value you want.



The following values can be displayed in panel **2**:

- Ambient temperature (°C)
- Range (km)
- Average speed (km/h)
- Average fuel consumption (l/100 km)
- Oil-level reminder (Oil)
- with tyre pressure monitoring (RDC)^{OE}

Tyre pressures (bar) <

Ambient temperature



When the motorcycle is at a standstill the heat of the engine can falsify ambient-temperature reading **1**. If the effect of the engine's heat becomes excessive, – temporarily appears on the display.



If ambient temperature drops below 3 °C this warning appears, drawing your attention to the risk of black ice forming. The display automatically switches from any other mode to the temperature reading when the temperature

drops below this threshold for the first time.<

Range



The description of the residual-range function (→ 52) also covers range readout **1**. You can also view the range before the fuel level drops to reserve. A special average-consumption figure is used to calculate range; this figure is not necessarily the same as the value you can call up for viewing on the display. When the motorcycle is propped on its side stand the slight angle of inclination means that the

sensor cannot register the fuel level correctly. This is the reason why the range is calculated only when the motorcycle is on the move.

 The calculated range is only an approximate reading. Consequently, BMW Motorrad recommends that you should not try to use the full range before refuelling.<

Average speed



Average speed **1** is calculated on the basis of the time elapsed since the last reset. Times

during which the engine was stopped are excluded from the calculation.

Resetting average speed

- Switch on the ignition.
- Select average speed.



- Press and hold down button **1** until the average-speed reading is reset.<

Average consumption



Average consumption **1** is calculated by dividing the distance covered since the last reset by the corresponding amount of fuel used.

Resetting average consumption

- Switch on the ignition.
- Select average consumption.



- Press and hold down button **1** until the average-consumption reading is reset.<

Oil level



Oil-level indicator **1** gives you an indication of the engine oil level. You can call up this reading only when the motorcycle is at a standstill.

The preconditions for the oil level check are as follows:

- Engine at operating temperature.
- Engine idling for at least 30 seconds.
- Side stand retracted.
- Make sure the motorcycle is upright.

The readings mean:

 Oil level is correct

 Check the oil level with the dipstick the next time you stop for fuel. If you call up another reading on the on-board computer, this symbol remains visible until the sensor again registers a correct oil level.

 Oil level cannot be measured (conditions as stated above not satisfied).

The most recently measured level is displayed for five seconds when you next switch on the ignition.

 The oil-level sensor might be defective if the "Check oil level" message appears even though the oil level in the oil sight glass is correct. In this case, consult your authorised BMW Motorrad dealer. ◀

Tyre pressure monitoring RDC

– with tyre pressure monitoring (RDC)^{OE}

Viewing tyre-pressure readings

- Switch on the ignition.



- Repeatedly press button **1** until the tyre-pressure readings appear on the display.



Tyre-pressure readings **2** are based on a reference tyre temperature of 20 °C. The front tyre pressure is on the left; the reading on the right is the rear tyre pressure. --- appears directly after the ignition is switched on, because the sensors do not transmit tyre pressures until the motorcycle accelerates to 30 km/h. ◀

Lights

Side light

The side lights switch on automatically when the ignition is switched on.

▶ The side lights place a strain on the battery. Do not switch the ignition on for longer than absolutely necessary.◀

Low-beam headlight

The low-beam headlight switches on automatically when you start the engine.

▶ When the engine is not running you can switch on the lights by switching on the ignition and either switching on the high-beam headlight or operating the headlight flasher.◀

High-beam headlight



- Push switch **1** forward to switch on the high-beam headlight.
- Pull switch **1** back to operate the headlight flasher.◀

Parking light

- Switch off the ignition.

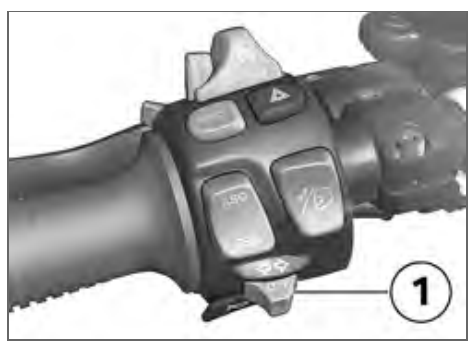

- Immediately after switching off the ignition, push button **1** to the left and hold it in this position until the parking lights come on.
- Switch the ignition on and off again to switch off the parking lights.◀

Turn indicators

Operating flashing turn indicators

- Switch on the ignition.

▶ The turn indicators are cancelled automatically after you have ridden for approximately 10 seconds, or covered a distance of about 200 m.◀

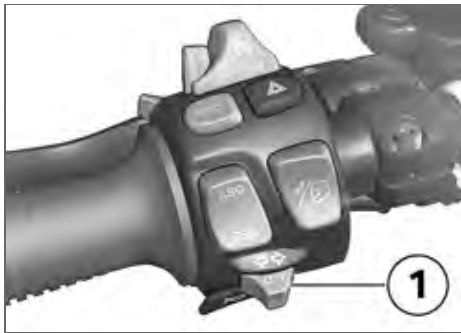

- Push button **1** to the left to switch on the left flashing turn indicators.
- Push button **1** to the right to switch on the right flashing turn indicators.
- Centre button **1** to cancel the flashing turn indicators.◀

Hazard warning flashers

Operating hazard warning flashers

- Switch on the ignition.

▶ The hazard warning flashers place a strain on the battery. Do not use the hazard warning flashers for longer than absolutely necessary.◀

▶ If you press a turn-indicator button with the ignition switched on, the turn-indicator function is activated instead of the hazard warning flashers, and remains active until you release the button. The hazard warning flashers recommence flashing as soon as the button is released.◀



- Press button **1** to switch on the hazard warning flashers.
 - » Ignition can be switched off.
- Press button **1** again to switch off the hazard warning flashers.◀

Emergency off switch (kill switch)



1 Emergency off switch (kill switch)

! Operating the kill switch when riding can cause the rear wheel to lock and thus cause a fall.

Do not operate the kill switch when riding. ◀

The emergency off switch is a kill switch for switching off the engine quickly and easily.

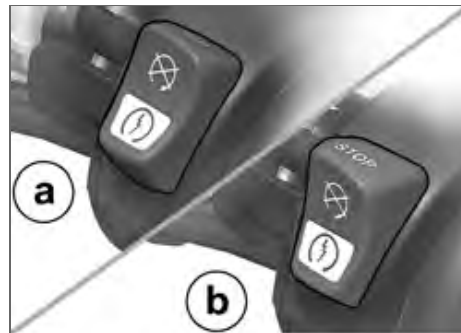

a Engine switched off
b Normal operating position (run)

Grip heating

– with heated handlebar grips ^{OE}

Operating grip heating

- Start the engine.

▶ Grip heating can be activated only when the engine is running. ◀

▶ The increase in power consumption caused by the grip heating can drain the battery if you are riding at low en-

gine speeds. If the charge level is low, grip heating is switched off to ensure the battery's starting capability. ◀



- Repeatedly press button 1 until the desired heating stage appears on the display.

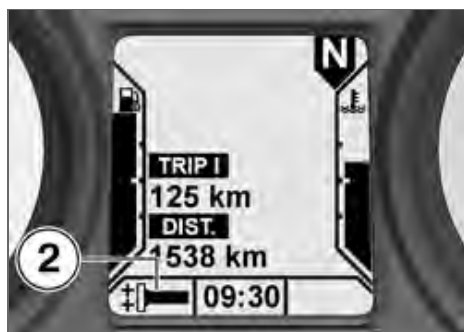

The handlebar grips have two-stage heating. Stage two is for heating the grips quickly: it is advisable to switch back to stage one as soon as the grips are warm. The heating stage you have selected is indicated by the symbol in the multifunction display **2**.

 50 % heating power

 100 % heating power

» The selected heating stage will be saved if you allow a certain

length of time to pass without making further changes.◀

Seat heating

– with seat heating^{OE}

Front-seat heating

- Start the engine.

 Seat heating can be activated only when the engine is running.◀

 The increase in power consumption caused by the seat heating can drain the battery if you are riding at low engine speeds. If the charge level is low, seat heating is switched off to ensure the battery's starting capability.◀





- Repeatedly press button **1** until the desired heating stage appears on the display.



The front seat has two-stage heating. Stage two is for heating the seat quickly: it is advisable to switch back to stage one as

soon as the seat is warm. The heating stage you have selected is indicated by the symbol in the multifunction display **2**.

-  50 % heating power
-  100 % heating power

Rear seat heating

- Start the engine.

 Seat heating can be activated only when the engine is running.◀

 The increase in power consumption caused by the seat heating can drain the battery if you are riding at low engine speeds. If the charge level is low, seat heating is switched off to ensure the battery's starting capability.◀

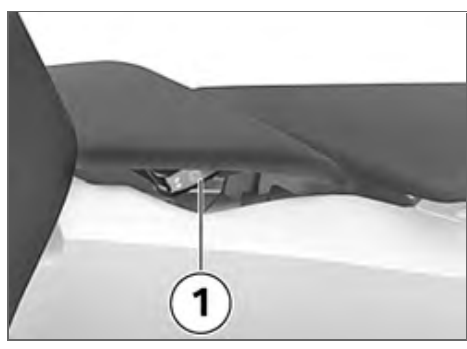

- Set switch **1** to the desired heating stage.

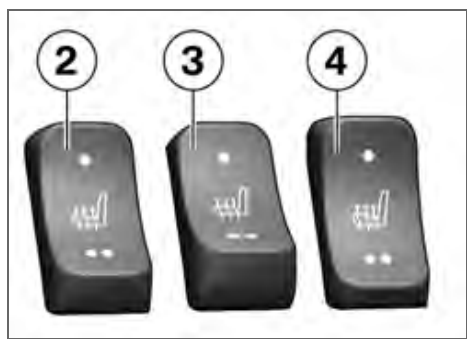

The rear seat has two-stage heating. Stage two is for heating the seat quickly: it is advisable to

switch back to stage one as soon as the seat is warm.

- **2** Switch centred: Heating off.
- **3** Switch pushed back: 50 % heating power.
- **4** Switch pushed forward: 100 % heating power.



The heating stage you have selected is indicated by the symbol in the multifunction display **5**.

-  50 % heating power

 100 % heating power

Automatic Stability Control ASC

– with Automatic Stability Control (ASC)^{OE}

Deactivating ASC function

- Switch on the ignition.

 You have the option of deactivating the ASC function while the motorcycle is on the move. ◀



- Press and hold down button **1** until the ASC warning light changes status.

 ASC warning light shows.

- Release button **1** within two seconds.

 ASC warning light remains ON.

» The ASC function is deactivated.

Activating ASC function



- Press and hold down button **1** until the ASC warning light changes status.

 ASC warning light goes out; if self-diagnosis has not completed it starts flashing.

- Release button **1** within two seconds.

 The ASC warning light remains off or continues to flash.

» The ASC function is activated.

- You also have the option of switching the ignition off and then on again.

 An ASC fault has occurred if the ASC warning light shows when the motorcycle accelerates to a speed in excess of 5 km/h after the ignition was switched off and then on again.◀◀

Seat height

Adjusting seat height

- Remove the front seat (➡ 75).



- Remove seat supporting rod **1** and reinsert it at the desired height.
- Install the front seat (➡ 75).

Windscreen

Adjusting windscreen

- Switch on the ignition.



- Press top section of button **1** to raise the windscreen.
- Press bottom section of button **1** to lower the windscreen.◀

Cruise-control system

– with cruise-control system^{OE}

Switching on cruise control

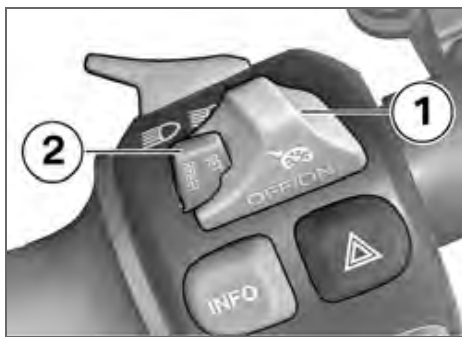

- Slide switch **1** to the right.
» Button **2** is operational.

Set the road speed

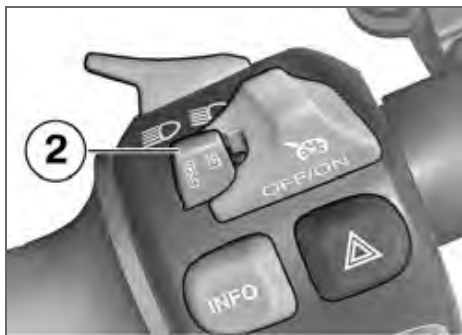

- Briefly push button **2** forward.

 Cruise control can be used in the speed range from 50 km/h to 180 km/h.◀

SET Telltale light for cruise control shows.

» The motorcycle maintains your current cruising speed and the setting is saved.

Accelerating

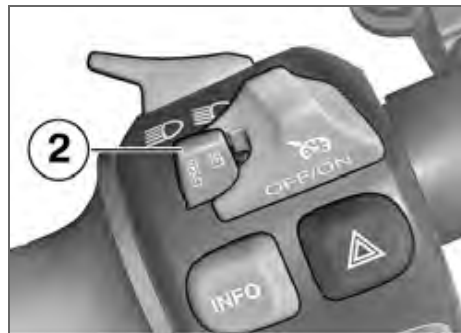

- Briefly push button **2** forward.
» Speed is increased by approx. 2 km/h each time you push the button.◀

- Push button **2** forward and hold it in this position.
» The motorcycle accelerates steplessly.
» The current speed is maintained and saved if button **2** is not pushed again.

Decelerating



- Briefly push button **2** back.
» Speed is reduced by approx. 2 km/h each time you push the button.◀



- Push button **2** back and hold it in this position.
 - » The motorcycle decelerates steplessly.
 - » The current speed is maintained and saved if button **2** is not pushed again.

Deactivating cruise control

- Brake, pull the clutch lever or turn the throttle twistgrip (close the throttle by turning the twistgrip back past the idle position) to deactivate the cruise-control system.

» Telltale light for cruise-control goes out.

Resuming former cruising speed



- Briefly push button **2** back to return to the speed saved beforehand.

 Opening the throttle does not deactivate the cruise-control system. If you release the twistgrip the motorcycle will decelerate only to the cruising speed saved in memory, even though you might have intended slowing to a lower speed.◀

SET Telltale light for cruise control shows.

Switch off cruise control

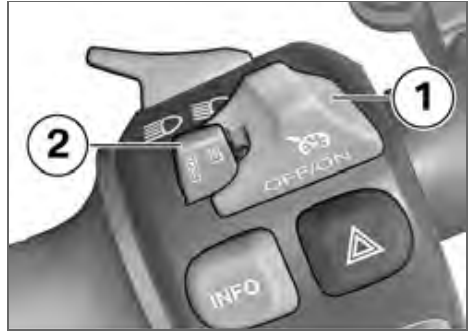

- Slide switch **1** to the left.
 - » The system is deactivated.
 - » Button **2** is disabled.

Stowage compartment

Opening stowage compartment

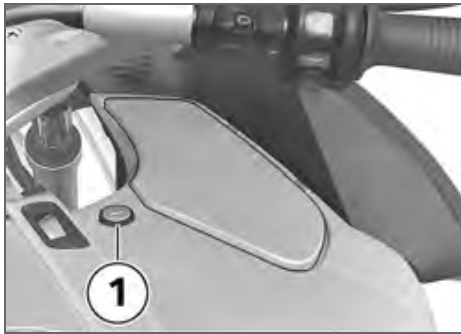

- Open lock barrel **1** with the ignition key.
- To open the lid, push the unlocked lock barrel downwards.

Clutch

Adjusting clutch lever

 If the position of the clutch fluid reservoir is changed, air can enter the clutch system. Do not twist the handlebar fitting or the handlebars.◀

 Attempting to adjust the clutch lever while riding the motorcycle can lead to accidents. Do not attempt to adjust the clutch lever unless the motorcycle is at a standstill.◀

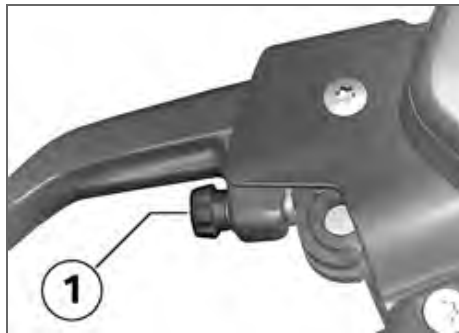

- Turn adjusting screw **1** clockwise to increase the span between the clutch lever and the handlebar grip.
- Turn adjusting screw **1** counter-clockwise to reduce the span between the clutch lever and the handlebar grip.

 The adjusting screw is easier to turn if you push the clutch lever forward.◀

Brakes

Adjust the handbrake lever

 Changing the position of the brake-fluid reservoir can allow air to penetrate the brake system.

Do not twist the handlebar fitting or the handlebars.◀

 Attempting to adjust the handbrake lever while riding the motorcycle can lead to accidents.

Do not attempt to adjust the handbrake lever unless the motorcycle is at a standstill.◀

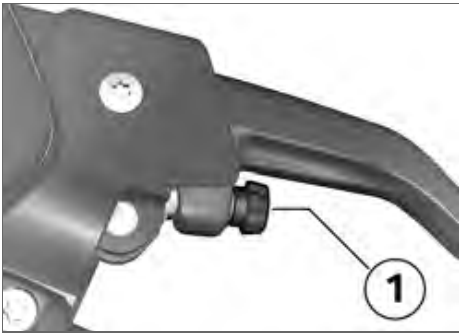

- Turn adjusting screw **1** clockwise to increase the span between the brake lever and the handlebar grip.
- Turn adjusting screw **1** counter-clockwise to reduce the span between the brake lever and the handlebar grip.

 The adjusting screw is easier to turn if you push the handbrake lever forward. ◀

Shift mechanism Adjusting shift lever

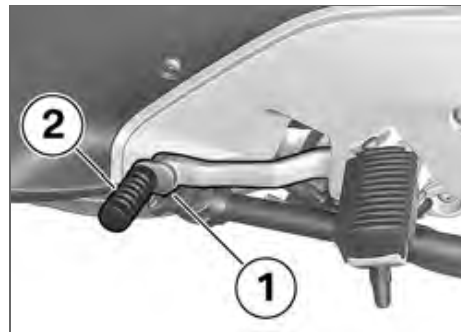

- Slacken screw **1**.
- Turn peg **2** to the desired position.
- Tighten screw **1** to the specified tightening torque.

	Selector lever to selector shaft
– 8 Nm	

Mirrors Adjust the mirrors



- Pivot the mirror to the correct position by pressing gently at the edge.

Spring preload

Setting

It is essential to set spring preload of the rear suspension to suit the load carried by the motorcycle. Increase spring preload when the motorcycle is heavily loaded and reduce spring preload

accordingly when the motorcycle is lightly loaded.

Adjusting spring preload for rear wheel

 Your motorcycle's handling will suffer if you do not match the spring-preload and damping-characteristic settings. Adjust the damping characteristic to suit spring preload. ◀

- Remove the rear seat (➔ 74).



- Adjust spring preload by turning knob **1**.

- If you want to increase spring preload, turn the knob in the direction indicated by the HIGH arrow.
- If you want to reduce spring preload, turn the knob in the direction indicated by the LOW arrow.



 Basic setting of spring preload, rear

– without Electronic Suspension Adjustment (ESA II)^{SA}

 Basic setting of spring preload, rear

- Turn the knob as far as it will go in the LOW direction, then preload the spring by 10 clicks. (Full load of fuel, with rider 85 kg) ◀

- Install the rear seat (➔ 76).

Damping Setting

Damping must be adapted to suit the surface on which the motorcycle is ridden and to suit spring preload.

- An uneven surface requires softer damping than a smooth surface.
- An increase in spring preload requires firmer damping, a reduction in spring preload requires softer damping.

Adjusting damping for rear wheel

- Make sure the ground is level and firm and place the motorcycle on its stand.



! There is a risk of injury by burns if you adjust the damping characteristic while the silencer is hot.

Use a screwdriver extension and wear protective gloves. ◀

- Adjust the damping characteristic, using the tool from the on-board toolkit to turn adjusting screw **1**.

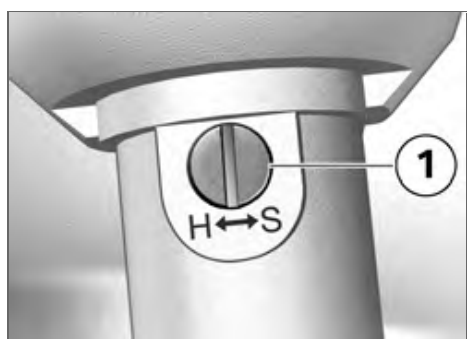

- If you want a harder damping characteristic, use a screwdriver to turn adjusting screw **1** in the direction indicated by the H arrow.
- If you want a softer damping characteristic, use a screwdriver to turn adjusting screw **1** in the direction indicated by the S arrow.

	Basic setting of rear-suspension damping characteristic
– without Electronic Suspension Adjustment (ESA II) ^{SA}	

	Basic setting of rear-suspension damping characteristic
– Turn the adjusting screw as far as it will go in the direction indicated by the H arrow and then turn it back three quarters of a turn in the direction indicated by the S arrow (Full load of fuel, with rider 85 kg)◀	

Electronic Suspension Adjustment ESA

- With Electronic Suspension Adjustment (ESA II)^{OE}

Possible settings

Electronic Suspension Adjustment ESA provides a convenient way of adapting the motorcycle to the load it carries and the surface over which you intend riding. In order for this to happen, the

load status must be set and the desired riding mode selected. Three load statuses can be set, with any of the three riding modes available for each one. The detailed description of the ESA II Electronic Suspension Adjustment system is on page (➔ 97).

Calling up settings

- Switch on the ignition.



- Press button **1** to view the current setting.



The selected riding mode is displayed in panel **1** of the multifunction display and the load status is displayed in panel **2**.

» The setting shows briefly, then disappears automatically.

Setting riding mode

- Start the engine.

 The riding mode can be set while the motorcycle is in motion.◀



- Press button **1** to view the current setting.
- Repeatedly press button **1** until the setting you want to use appears on the display.

The display field starts at the current status and cycles through the following sequence:

- COMF: comfort mode
- NORM: normal mode
- SPORT: sport mode
- » The setting shown on the display is automatically accepted as the riding mode if you allow a certain length of time to pass without making fur-

ther changes. The ESA setting then automatically disappears from the display.

Set the load status

- Starting engine

 The load status cannot be set while the motorcycle is in motion.◀



- Press button **1** to view the current setting.
- Repeatedly press button **1** until the setting you want to use appears on the display.

The display field starts at the current status and cycles through the following sequence:

 One-up

 One-up with luggage

 Two-up (with luggage)

- The settings shown on the display are automatically accepted as the spring preload and, if applicable, the damping characteristic if you allow a certain length of time to pass without pressing button **1**. The reading flashes while spring preload adjustment is in progress. The ESA setting then automatically disappears from the display.

Tyres



Checking tyre pressure

 Incorrect tyre pressures impair the motorcycle's handling characteristics and increase the rate of tyre wear. Always check that the tyre pressures are correct.◀

 At high road speeds, tyre valves installed perpendicular to the wheel rim have a tendency to open as a result of centrifugal force. In order to avoid a sudden loss of tyre pressure, fit a valve cap with rubber sealing ring to the rear tyre and make sure that the cap is screwed on firmly.◀

- Make sure the ground is level and firm and place the motorcycle on its stand.

- Check tyre pressures against the data below.

 Tyre pressure, front
– 2.2 bar (one-up, tyre cold)
– 2.5 bar (two-up and/or with luggage, tyre cold)
 Tyre pressure, rear
– 2.5 bar (one-up, tyre cold)
– 2.9 bar (two-up and/or with luggage, tyre cold)

If tyre pressure is too low:

- Correct tyre pressure.

Headlight

Adjusting headlight for driving on left/driving on right

If the motorcycle is ridden in a country where the opposite rule of the road applies, its asymmetric low-beam headlight will tend to dazzle oncoming traffic. Have the headlight set accordingly by a specialist workshop, preferably an authorised BMW Motorrad dealer.



Commercially available adhesive tape will damage the plastic lens of the light. Consult a specialist workshop, preferably an authorised BMW Motorrad dealer, in order to avoid damaging the plastic lens of the light.◀

Headlight beam throw and spring preload

Headlight beam throw is generally kept constant when spring preload is adjusted to suit load. Spring preload adjustment might not suffice only if the motorcycle is very heavily loaded. Under these circumstances, headlight beam throw has to be adjusted to suit the weight carried by the motorcycle.



Consult a specialist workshop, preferably an authorised BMW Motorrad dealer, if you are unsure whether the headlight basic setting is correct.◀

Headlight beam-throw adjustment

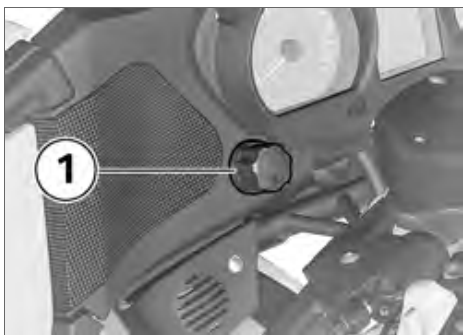

1 Headlight beam-throw adjustment

Spring preload adjustment might not suffice if the motorcycle is very heavily loaded. Headlight beam throw can be adjusted by means of the knob so as not to dazzle oncoming traffic.

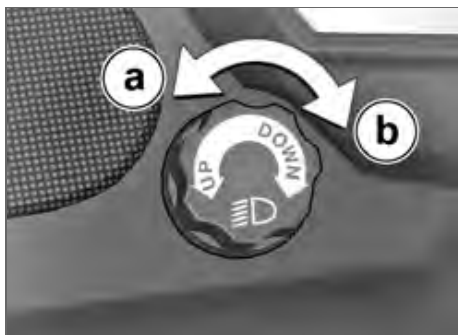

- a** Turn the knob as far as it will go in the UP direction: Neutral position.
- b** Turn the knob in the DOWN direction until the headlight beam no longer dazzles oncoming traffic.



- Turn the key to unlatch seat lock **1** and hold it in this position while pressing down the rear part of the rear seat.
- Lift the rear seat at the rear and release the key.

Front and rear seats

Remove the rear seat

- Make sure the ground is level and firm and place the motorcycle on its stand.

– with seat heating^{OE}

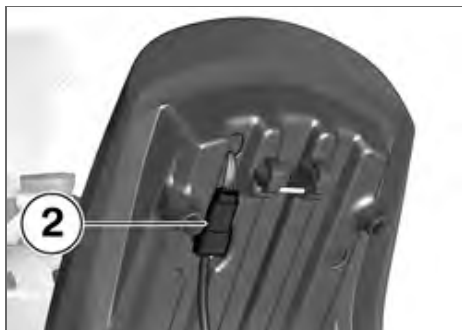

- Disengage the latch and disconnect plug **2**.<
- Remove the rear seat and place it, upholstered side down, on a clean surface.

Remove the front seat

- Remove the rear seat (→ 74).
- Lift the rear of the front seat.

– with seat heating^{OE}



- Disengage the latch and disconnect plug **3**.<
- Remove the front seat and place it, upholstered side down, on a clean surface.

Install the front seat

– with seat heating^{OE}



- Connect plug **3**.<

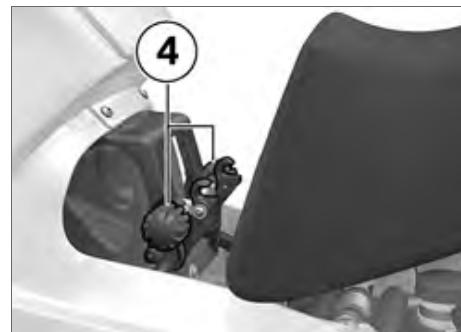

- Push the front seat into seat supporting rod **4**. Make sure

that the seat is correctly located.

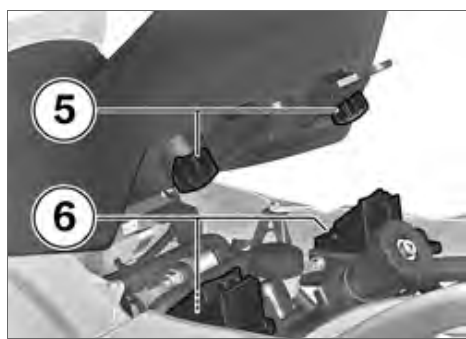

- If you install the seat in the low position, check that the seat's rubber buffers **5** are in the bottom positions in mounts **6**.
- Firmly press the front seat into the mounts.
- Install the rear seat (➡ 76).

Install the rear seat

- Install the front seat (➡ 75).

– with seat heating^{OE}

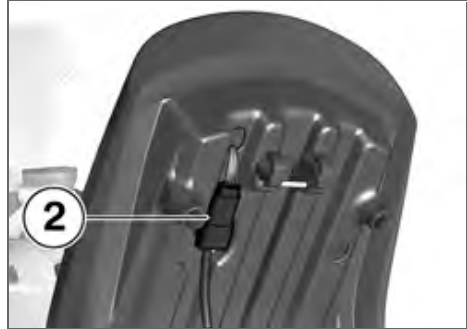

- Connect plug **2**.<



- Slide the rear seat underneath the front seat and push it down firmly at the rear.

» The rear seat engages with an audible click.

Helmet holder Securing helmet to motorcycle

- Remove the rear seat (➡ 74).



- Use a plastic-sheathed steel cable to secure the helmet to helmet holder **1**.

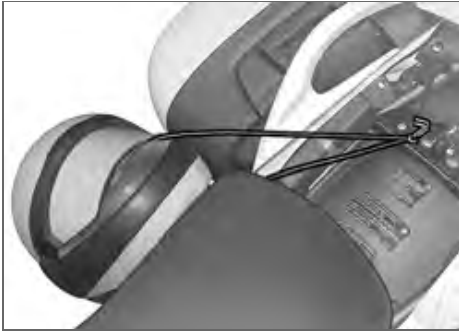

 The helmet catch can scratch the panelling. Make sure the lock is out of the way when you hook the helmet into position.◀

- Pass the steel cable through the helmet and the holder and position cable and helmet as shown here.
- Install the rear seat (➡ 76).

Riding

Safety instructions	80
Checklist.....	82
Starting	82
Running in	84
Brakes	85
Parking your motorcycle	86
Refuelling	87
Secure the motorcycle for transportation	88

Safety instructions

Rider's equipment

Do not ride without the correct clothing. Always wear:

- Helmet
- Motorcycling jacket and trousers
- Gloves
- Boots

This applies even to short journeys, and to every season of the year. Your authorised BMW Motorrad dealer will be glad to advise you on the correct clothing for every purpose.

Restricted angle of heel

- with lowered suspension^{OE}

A motorcycle with lowered suspension has less ground clearance and cannot corner at angles of heel as extreme as those achievable by a

counterpart motorcycle with standard-height suspension.



Risk of accident by unexpectedly early contact with the ground.

Bear in mind that lowered suspension limits the motorcycle's angle of heel and ground clearance.◀

Test your motorcycle's angle of heel in situations that do not involve risk. When riding over kerbs and similar obstacles, bear in mind that your motorcycle's ground clearance is limited.

Lowering the motorcycle's suspension shortens suspension travel (see the section entitled "Technical Data"). Ride comfort might be restricted as a result. Be sure to adjust spring preload accordingly, particularly for riding two-up.

Correct loading



Overloading and imbalanced loads can adversely affect the motorcycle's handling. Do not exceed the permissible gross weight and be sure to comply with the instructions on loading.◀

- Set spring preload, damping characteristic and tyre pressures to suit total weight.
- Ensure that the case volumes on the left and right are equal.
- Make sure that the weight is uniformly distributed between right and left.
- Pack heavy items at the bottom and toward the inboard side.
- Note the maximum permissible payload and the speed limit for riding with cases fitted, as stated on the label inside the case.

- with topcase^{OA}
- Note the maximum permissible payload and the speed limit for riding with topcase fitted, as stated on the label inside the topcase.◀
- with tank rucksack^{OA}
- Note the maximum permissible payload of the tank rucksack.



Payload of tank rucksack

- ≤5 kg◀

Speed

If you ride at high speed, always bear in mind that various boundary conditions can adversely affect the handling of your motorcycle:

- Settings of the spring-strut and shock-absorber system
- Imbalanced load
- Loose clothing

- Insufficient tyre pressure
- Poor tyre tread
- Etc.

Risk of poisoning

Exhaust fumes contain carbon monoxide, which is colourless and odourless but highly toxic.



Inhaling the exhaust fumes therefore represents a health hazard and can even cause loss of consciousness with fatal consequences.

Do not inhale exhaust fumes.

Do not run the engine in an enclosed space.◀

Catalytic converter

If misfiring causes unburned fuel to enter the catalytic converter, there is a danger of overheating and damage.

For this reason, observe the following points:

- Do not run the fuel tank dry.
- Do not attempt to start or run the engine with a spark-plug cap disconnected.
- Stop the engine immediately if it misfires.
- Use only unleaded fuel.
- Comply with all specified maintenance intervals.



Unburned fuel will destroy the catalytic converter. Note the points listed for protection of the catalytic converter.◀

Risk of overheating



Cooling would be inadequate if the engine were allowed to idle for a lengthy period with the motorcycle at a standstill: overheating would result. In extreme cases, the motorcycle could catch fire. Do not allow the engine to idle unnecessarily. Ride away immediately after starting the engine.◀

Tampering

! Tampering with motorcycle settings (e.g. electronic engine management unit, throttle valves, clutch) can cause damages to the components in question and lead to failure of safety-relevant functions. Damage caused in this way is not covered by the warranty.

Do not tamper with the motorcycle in any way that could result in tuned performance. ◀

Checklist

Use the following checklist to check important functions, settings and wear limits before you ride off.

- Brakes
- Brake-fluid levels, front and rear
- Clutch
- Clutch fluid level
- Damping-characteristic setting and spring preload

- Tyre-tread depth and tyre pressures
- Cases correctly installed and luggage secured

At regular intervals:

- Engine oil level (every refuelling stop)
- Brake-pad wear (every third refuelling stop)

Starting

Side stand

You cannot start the motorcycle with the side stand extended and a gear engaged. The engine will switch itself off if you start it with the gearbox in neutral and then engage a gear before retracting the side stand.

Gearbox

You can start the engine when the gearbox is in neutral or if you pull the clutch with a gear engaged. Do not pull the clutch un-

til after you have switched on the ignition, as otherwise the engine will refuse to start.

Starting engine

- Switch on the ignition.
 - » Pre-ride check is performed. (➡ 83)
 - » ABS self-diagnosis is performed. (➡ 83)
- with Automatic Stability Control (ASC)^{OE}
 - » ASC self-diagnosis is performed. (➡ 84)



- Press starter button **1**.

 If ambient temperatures are very low, you might find it necessary to open the throttle slightly when starting the engine. At ambient temperatures below 0 °C, disengage the clutch after switching on the ignition.◀

 The start attempt is automatically interrupted if battery voltage is too low. Recharge the battery before you start the engine, or use jump leads and a donor battery to start.◀

- » The engine starts.
- » If the engine refuses to start, consult the troubleshooting chart in the section entitled "Technical data". (➡ 144)

Pre-ride check

The instrument panel runs a test of the 'General' warning light when the ignition is switched on: this is the "Pre-Ride-Check. The

test is aborted if you start the engine before it completes.

Phase 1

 General warning light shows red.

– CHECK ! appears on the display.

Phase 2

 General warning light shows yellow.

– CHECK ! appears on the display.

 with cruise-control system: SET light shows.

If the 'General' warning light does not show:

 Some malfunctions cannot be indicated if the 'General' warning light cannot be displayed.

Check that the 'General' warning

light comes on, and that it shows red and yellow.◀

- Have the fault rectified as quickly as possible by a specialist workshop, preferably an authorised BMW Motorrad dealer.

ABS self-diagnosis

BMW Motorrad Integral ABS performs self-diagnosis to ensure its operability. Self-diagnosis is performed automatically when you switch on the ignition. The motorcycle has to move forward a few metres for the wheel sensors to be tested.

Phase 1

- » Test of the diagnosis-compatible system components with the motorcycle at a standstill.

 ABS warning light flashes.

Phase 2

» Test of the wheel sensors as the motorcycle pulls away from rest.



ABS warning light flashes.

ABS self-diagnosis completed

» The ABS warning light goes out.

If an indicator showing an ABS fault appears when ABS self-diagnosis completes:

- You can continue to ride. Bear in mind that neither the ABS function nor the integral braking function is available.
- Have the fault rectified as quickly as possible by a specialist workshop, preferably an authorised BMW Motorrad dealer.

ASC self-diagnosis

– with Automatic Stability Control (ASC)^{OE}

BMW Motorrad ASC performs self-diagnosis to ensure its operability. Self-diagnosis is performed automatically when you switch on the ignition. The engine must be running and the motorcycle must reach a speed of at least 5 km/h in order for ASC self-diagnosis to complete.

Phase 1

» Test of the diagnosis-compatible system components with the motorcycle at a standstill.



ASC warning light slow-flashes.

Phase 2

» Test of the diagnosis-compatible system components while the motorcycle is on the move.



ASC warning light slow-flashes.

ASC self-diagnosis completed

» The ASC warning light goes out.

If an indicator showing an ASC fault appears when ASC self-diagnosis completes:

- You can continue to ride. Bear in mind that the ASC function is not available.
- Have the fault rectified as quickly as possible by a specialist workshop, preferably an authorised BMW Motorrad dealer.

Running in

The first 1000 km

- While running in the motorcycle, vary the throttle opening and engine-speed range frequently; avoid riding at constant

engine rpm for prolonged periods.

- Try to do most of your riding during this initial period on twisting, fairly hilly roads.
- Comply with the rpm limits for running in.



Running-in speeds

– 5500 min^{-1} (Odometer reading 0...200 km)

– 6500 min^{-1} (Odometer reading 200...400 km)

– 7500 min^{-1} (Odometer reading 400...600 km)

– maximum engine rpm for short bursts (Odometer reading 600...900 km)

- Do not omit the first inspection after 500 - 1200 km.

Brake pads

New brake pads have to bed down before they can achieve their optimum friction levels. You can compensate for this initial reduction in braking efficiency by exerting greater pressure on the levers.



New brake pads can extend stopping distance by a significant margin. Apply the brakes in good time. ◀

Tyres

New tyres have a smooth surface. This must be roughened by riding in a restrained manner at various heel angles until the tyres are run in. This running in procedure is essential if the tyres are to achieve maximum grip.



Tyres do not have their full grip when new and there is a risk of accidents at extreme angles of heel.

Avoid extreme angles of heel. ◀

Brakes

How can stopping distance be minimised?

Each time the brakes are applied, a load distribution shift takes place with the load shifting forward from the rear to the front wheel. The sharper the motorcycle decelerates, the more load is shifted to the front wheel. The higher the wheel load, the more braking force can be transmitted without the wheel locking.

To optimise stopping distance, apply the front brakes rapidly and keep on increasing the force you apply to the brake lever. This makes the best possible use of the dynamic increase in load at the front wheel. Remember to pull the clutch at the same time. In the "panic braking situations" that are trained so frequently braking force is applied

as rapidly as possible and with the rider's full force exerted on the brake levers; under these circumstances the dynamic shift in load distribution cannot keep pace with the increase in deceleration and the tyres cannot transmit the full braking force to the surface of the road. ABS has to intervene to keep the front wheel from locking; this increases stopping distance.

Descending mountain passes

 There is a danger of the brakes fading if you use only the rear brakes when descending mountain passes. Under extreme conditions, the brakes could overheat and suffer severe damage.

Use both front and rear brakes, and make use of the engine's braking effect as well. ◀

Wet and dirty brakes

Wetness and dirt on the brake discs and the brake pads diminish braking efficiency.

Delayed braking action or poor braking efficiency must be reckoned with in the following situations:

- Riding in the rain or through puddles of water.
- After the motorcycle has been washed.
- Riding on salted or gritted roads.
- After work has been carried on the brakes, due to traces of oil or grease.
- Riding on dirt-covered surfaces or off-road.

 Wetness and dirt result in poor braking efficiency. Apply the brakes lightly while riding to remove wetness and dirt, or dismount and clean the brakes.

Think ahead and brake in good time until full braking efficiency is restored. ◀

Parking your motorcycle

Side stand

- Switch off the engine.

 If the ground is soft or uneven, there is no guarantee that the motorcycle will rest firmly on the stand.

Always check that the ground under the stand is level and firm. ◀

- Extend the side stand and prop the motorcycle on the stand.

 The side stand is designed to support only the weight of the motorcycle.

Do not lean or sit on the motorcycle with the side stand extended. ◀

- If the camber of the roadway permits, turn the handlebars all the way to the left.
- On a gradient, the motorcycle should always face uphill; select 1st gear.

Centre stand

- Switch off the engine.

 If the ground is soft or uneven, there is no guarantee that the motorcycle will rest firmly on the stand. Always check that the ground under the stand is level and firm. ◀

 Excessive movements could cause the centre stand to retract, and the motorcycle would topple in consequence.

Do not lean or sit on the motorcycle with the centre stand extended. ◀

- Extend the centre stand and lift the motorcycle onto the stand.

Refuelling

 Fuel is highly flammable. A naked flame close to the fuel tank can cause a fire or explosion.

Do not smoke. Never bring a naked flame near the fuel tank. ◀

 Fuel attacks plastics, which become dull or unsightly.

Wipe off plastic parts immediately if they come into contact with fuel. ◀

- Make sure the ground is level and firm and place the motorcycle on its stand.
- Open the protective cap.



- Use the ignition key to unlock the fuel filler cap and pop the cap open.



 Fuel expands when hot. Fuel escaping from an overfilled tank could make its way





onto the road surface. This could cause a fall.

Do not overfill the fuel tank. ◀

! Leaded fuel will destroy the catalytic converter. Use only unleaded fuel. ◀

- Refuel with fuel of the grade stated below; do not fill the tank past the bottom edge of the filler neck.

▶ When refuelling after running on reserve, make sure that you top up the tank to a level above reserve, as otherwise the sensor will not be able to register the new level. If the sensor cannot register the new level neither the fuel-level reading nor the range readout can be updated. ◀

	Recommended fuel grade
	– Premium plus unleaded – 98 ROZ/RON – 91 AKI
	alternative fuel grade
	– Premium unleaded (slight power- and consumption-related restrictions) – 95 ROZ/RON – 89 AKI
	Usable fuel capacity
	– approx. 25 l
	Reserve fuel
	– approx. 4 l

- Press the fuel tank cap down firmly to close.

- Remove the key and close the protective cap.

Secure the motorcycle for transportation

- Make sure that all components that might come into contact with straps used to secure the motorcycle are adequately protected against scratching. Use adhesive tape or soft cloths, for example, for this purpose.



! The motorcycle can topple and fall on its side. Make sure that the motorcycle cannot topple sideways. ◀

- Push the motorcycle onto the transportation flat and hold it in position: do not place it on the side stand or centre stand.◀

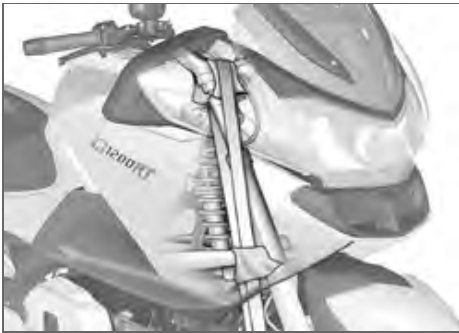

- At the rear, secure the straps to the rear footrests on both sides and tighten the straps.◀
- Tighten all the straps uniformly; the motorcycle's suspension should be compressed as tightly as possible front and rear.

 Risk of damaging components.

Take care not to trap components such as brake lines or wires.◀

- At the front, secure the straps to the top fork bridge on both sides.
- Pass the straps through the leading link and tighten the straps.

Engineering details

Brake system with BMW Motorrad Integral ABS	92
Electronic engine management with BMW Motorrad ASC.....	94
Tyre pressure monitoring RDC	96
Electronic Suspension Adjustment ESA II.....	97

Brake system with BMW Motorrad Integral ABS

Partially integral brakes

Your motorcycle is equipped with partially integral brakes. Both front and rear brakes are applied when you pull the handbrake lever. The footbrake lever acts only on the rear brake.

While the brakes are slowing the motorcycle, the BMW Motorrad Integral ABS adapts braking-force distribution between front and rear brakes to suit the load on the motorcycle.

 The integral braking function makes it very difficult to spin the rear wheel by opening the throttle with the front brake applied to keep the motorcycle stationary (burn-out). Attempted burn-outs can result in damage to the rear brake and the clutch. Do not attempt burn-outs.◀

How does ABS work?

The amount of braking force that can be transferred to the road depends on factors that include the coefficient of friction of the road surface. Loose stones, ice and snow or a wet road all have much lower coefficients of friction than a clean, dry asphalt surface. The lower the coefficient of friction, the longer the braking distance.

If the rider increases braking pressure to the extent that braking force exceeds the maximum transferrable limit, the wheels start to lock and the motorcycle loses its directional stability; a fall is imminent. Before this situation can occur, ABS intervenes and adapts braking pressure to the maximum transferrable braking force, so the wheels continue to turn and directional stability is maintained irrespective of the condition of the road surface.

What are the effects of surface irregularities?

Humps and surface irregularities can cause the wheels to lose contact temporarily with the road surface; if this happens the braking force that can be transmitted to the road can drop to zero. If the brakes are applied under these circumstances the ABS has to reduce braking force to ensure that directional stability is maintained when the wheels regain contact with the road surface. At this instant the BMW Motorrad Integral ABS must assume an extremely low coefficient of friction, so that the wheels will continue to rotate under all imaginable circumstances, because this is the precondition for ensuring directional stability. As soon as it registers the actual circumstances, the system reacts instantly and adjusts brak-

ing force accordingly to achieve optimum braking.

What feedback does the rider receive from the BMW Motorrad Integral ABS?

If the ABS system has to reduce braking force on account of the circumstances described above, vibration is perceptible through the handbrake lever.

When the handbrake lever is pulled, brake pressure is also built up at the rear wheel by the integral function. If the brake pedal is depressed after the handbrake lever is pulled, the brake pressure built up beforehand is perceptible as counter-pressure sooner than is the case when the brake pedal is depressed either before or at the same time as the brake lever is pulled.

Rear wheel lift

Under very severe and sudden deceleration, however, under certain circumstances it is possible that the BMW Motorrad Integral ABS will be unable to prevent the rear wheel from lifting clear of the ground. If this happens the outcome can be a highside situation in which the motorcycle can flip over.



Severe braking can cause the rear wheel to lift off the ground.

When you brake, bear in mind that ABS control cannot be relied on in all circumstances to prevent the rear wheel from lifting clear of the ground. ◀

What is the design baseline for BMW Motorrad Integral ABS?

Within the limits imposed by physics, the BMW Motorrad Integral ABS ensures directional stability on any surface. The system is not optimised for special requirements that apply under extreme competitive situations off-road or on the track.

Special situations

The speeds of the front and rear wheels are compared as one means of detecting a wheel's incipient tendency to lock. If the system registers implausible values for a lengthy period the ABS function is deactivated for safety reasons and an ABS fault message is issued. Self-diagnosis has to complete before fault messages can be issued.

In addition to problems with the BMW Motorrad Integral ABS,

exceptional riding conditions can lead to a fault message being issued.

Exceptional riding conditions:

- Heating up with the motorcycle on the centre stand or an auxiliary stand, engine idling or with a gear engaged.
- Rear wheel locked by the engine brake for a lengthy period, for example while descending on a loose or slippery surface.

If a fault message is issued on account of exceptional riding conditions as outlined above, you can reactivate the ABS function by switching the ignition off and on again.

What significance devolves on regular maintenance?



Invariably, a technical system cannot perform beyond the abilities dictated by its level of maintenance.

In order to ensure that the BMW Motorrad Integral ABS is always maintained in optimum condition, it is essential for you to comply strictly with the specified inspection intervals. ◀

Reserves for safety

The potentially shorter braking distances which BMW Motorrad Integral ABS permits must not be used as an excuse for careless riding. ABS is primarily a means of ensuring a safety margin in genuine emergencies.

Take care when cornering. When you apply the brakes on a corner, the motorcycle's weight and

momentum take over and even BMW Motorrad Integral ABS is unable to counteract their effects.

Electronic engine management with BMW Motorrad ASC

- with Automatic Stability Control (ASC)^{OE}

How does ASC work?

The BMW Motorrad ASC compares the speed of rotation of the front wheel and the rear wheel. The differential is used to compute slip as a measure of the reserves of stability available at the rear wheel. If slip exceeds a certain limit the electronic engine management system intervenes, adapting engine torque accordingly.

What is the design baseline for BMW Motorrad ASC?

BMW Motorrad ASC is designed as an assistant system for the rider and for use on public roads. The extent to which the rider affects ASC control can be considerable (weight shifts when cornering, items of luggage loose on the motorcycle), especially when style of riding takes rider and machine close to the limits imposed by physics.

The system is not optimised for special requirements that apply under extreme competitive situations off-road or on the track. You have the option of deactivating the BMW Motorrad ASC system for these circumstances.

 Even ASC is constrained by the laws of physics. Invariably, the rider bears responsibility for assessing road and traffic

conditions and adopting his or her style of riding accordingly. Do not take risks that would negate the additional safety offered by this system.◀

Special situations

In accordance with the laws of physics, the ability to accelerate is restricted more and more as the angle of heel increases. Consequently, there can be a perceptible lag in acceleration out of very tight bends.

The speeds of the front and rear wheels are compared as one means of detecting the rear wheel's incipient tendency to spin or slip sideways. If the system registers implausible values for a lengthy period the ASC function is deactivated for safety reasons and an ASC fault message is issued. Self-diagnos-

is has to complete before fault messages can be issued.

The BMW Motorrad ASC can shut down automatically under the exceptional riding conditions outlined below.

Exceptional riding conditions:

- Riding for a lengthy period with the front wheel lifted off the ground (wheelie) and ASC deactivated.
- Rear wheel rotating with the motorcycle held stationary by applying the front brake (burn-out).
- Heating up with the motorcycle on the centre stand or an auxiliary stand, engine idling or with a gear engaged.

Accelerating the motorcycle to a speed in excess of 5 km/h after switching the ignition off and then on again reactivates the ASC.◀

If the front wheel lifts clear of the ground under severe acceleration, the ASC reduces engine torque until the front wheel regains contact with the ground.

Under these circumstances, BMW Motorrad recommends rolling the throttle slightly closed so as to restore stability with the least possible delay.

When riding on a slippery surface, never snap the throttle twistgrip fully closed without pulling the clutch at the same time. Engine braking torque can cause the rear wheel to lock, with a corresponding loss of stability. The BMW Motorrad ASC is unable to control a situation of this nature.

Tyre pressure monitoring RDC

- with tyre pressure monitoring (RDC)^{OE}

Function

A sensor integrated into each tyre measures the air temperature and the air pressure inside the tyre and transmits this information to the control unit.

Each sensor has a centrifugal-force tripswitch that does not enable transmission of the measured values until the motorcycle has accelerated to about 30 km/h. The display shows -- for each tyre until the tyre-pressure signal is received for the first time. The sensors continue to transmit the measured-value signals for approximately 15 minutes after the motorcycle comes to a stop.<

The control unit can administer four sensors, so two different sets of wheels with RDC sensors can be alternated on the motorcycle. An error message is issued if wheels without sensors are fitted to a motorcycle equipped with an RDC control unit.

Tyre-pressure ranges

The RDC control unit differentiates between three tyre-pressure ranges, all of which are parameterised for the motorcycle:

- Tyre pressure within permitted tolerance.
- Tyre pressure close to limit of permitted tolerance.
- Tyre pressure outside permitted tolerance.

A warning is also issued if tyre pressure drops sharply but stays within the permitted tolerance.

Temperature compensation

Tyre pressure is a temperature-sensitive variable: pressure increases as tyre temperature rises and decreases as tyre temperature drops. Tyre temperature depends on ambient temperature, on the style of riding and the duration of the ride.

The tyre-pressure readings shown by the multifunction display are temperature-compensated; the reference tyre temperature for these readings is always 20 °C. The air lines available to the public in petrol stations and motorway service areas have gauges that do not compensate for temperature; the reading shown by a gauge of this nature is the temperature-dependent tyre pressure. In most instances, therefore, these gauge readings will not tally with

the pressures shown by the multifunction display.<1

Pressure adaptation

Compare the RDC readings on the multifunction display with the value in the table on the inside cover of the Rider's Manual. Then use the air line to compensate for the difference between the RDC reading and the value in the table.

Example: According to the Rider's Manual, tyre pressure should be 2.5 bar, but the reading in the multifunction display is 2.3 bar. The gauge on the air line shows 2.4 bar. You must now increase tyre pressure by the 0.2 bar difference between the value in the table and the RDC reading; when the air-line gauge shows 2.6 bar, the tyre is inflated to the correct pressure.<1

Electronic Suspension Adjustment ESA II

– With Electronic Suspension Adjustment (ESA II)^{SA}

Suspension adjustments

Depending on the load on the motorcycle, the appropriate load status must first be selected when the motorcycle is stationary. The damping characteristics on both spring struts and the spring mount and the spring rate on the rear spring strut are adjusted on the basis of the riding mode that is then selected. If the selected driving mode is changed, the damping characteristics on both spring struts and the spring rate on the rear spring strut are also adjusted. This allows the suspension to be very accurately adapted to all riding conditions, even when the motorcycle is in motion.

- The combination of spring mount, suspension and spring rate ensure that the suspension geometry is always perfectly adjusted.
- The static normal position is almost maintained even while riding.
- The different riding conditions and load statuses are compensated, so that the handling of the motorcycle remains constant.

It is possible to change the spring rate electronically by combining a conventional coil spring and a plastic element (Elastogran), the lateral expansion of which can be restricted electro-hydraulically using a displaceable sleeve. The more the sleeve encloses the plastic element, the more the expansion of the plastic element is restricted, causing the spring

rate to increase. The maximum spring rate is achieved when the sleeve completely encloses the plastic element and rests on the steel spring. By the same token, the spring rate decreases when the sleeve allows the plastic element to expand further.

Accessories

General instructions.....	100
Power sockets	100
Case	101
topcase	103

General instructions

BMW Motorrad recommends the use of parts and accessories for your motorcycle that are approved by BMW for this purpose. Genuine BMW parts and accessories and other products which BMW has approved can be obtained from your authorised BMW Motorrad dealer, together with expert advice on their installation and use.

These parts and products have been tested by BMW for safety, function and suitability. BMW accepts product liability for them. Conversely, BMW is unable to accept any liability whatsoever for parts and accessories which it has not approved.

Also bear in mind the information on the effect of wheel size on suspension-control systems (➔ 117).



BMW Motorrad cannot assess each non-BMW product to determine whether it can be used on or in connection with BMW motorcycles without constituting a safety hazard. Country-specific official authorisation does not suffice as assurance. Tests conducted by these instances cannot make provision for all operating conditions experienced by BMW motorcycles and, consequently, they are not sufficient in some circumstances.

Use only parts and accessories approved by BMW for your motorcycle. ◀

Whenever you are planning modifications, comply with all the legal requirements. Make sure that the motorcycle does not infringe the national road-vehicle construction and use regulations applicable in your country.

Power sockets

Notes on use of power sockets:

automatic shutdown

Power sockets are shut down automatically under the following circumstances:

- If battery charge state is too low to maintain the motorcycle's start capability
 - If maximum load capability as stated in the technical data is exceeded
 - When the engine is being cranked on the starter
 - with (extra) on-board socket^{OE}
- If more than one socket is used, total current must not exceed the maximum load capability. ◀

Operating electrical accessories

You can start using electrical accessories only when the ignition is switched on. The accessory

remains operational if the ignition is subsequently switched off. The power sockets are switched off approximately 15 after the ignition is switched off, in order to prevent overloading of the on-board electrics.

Cable routing

The cables from the power sockets to the auxiliary devices must be routed in such a way that they:

- Do not impede the rider
- Do not restrict the steering angle or obstruct handling
- Cannot be trapped

Case

Opening cases



- Turn the key to the OPEN position in the case lock.



- Push lock barrel **1** down.

- » Lever **2** pops up.
- Pull the release lever all the way up.
- The lid of the case opens.

Closing cases



- Pull release lever **2** all the way up.
- Close the lid of the case and press it down. Check that nothing is trapped between the lid and the case.



- Push release lever **2** down until it engages.
- Turn the key in the case lock to the LOCK position and remove the key from the lock.

Remove the cases



- Turn the key to the RELEASE position in the case lock.
 - » The handle pops out.



- Pull handle **3** out and then pull it up as far as it will go.

» The case is released and can be removed.

Installing cases

- Pull the case handle up as far as it will go.



- Seat the case in holders **4**.

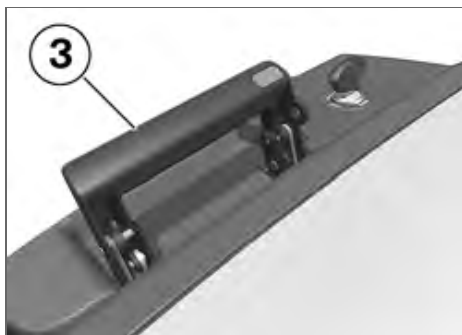

- Push case handle **3** down until it engages.
- Turn the key in the case lock to the LOCK position and remove the key from the lock.

topcase

– with topcase^{OA}

Opening topcase



- Turn the key to the OPEN position in the topcase lock.



- Push lock barrel **1** forward.
» Lever **2** pops up.

- Pull the release lever all the way up.
» The lid of the topcase opens.

Close the topcase



- Pull release lever **2** all the way up.
- Close the lid of the topcase and hold it down. Check that nothing is trapped between the lid and the case.



- Push release lever **2** down until it engages.
- Turn the key in the topcase lock to the LOCK position and remove the key from the lock.

Removing topcase



- Turn the key to the RELEASE position in the topcase lock.
» The handle pops out.



- Pull handle **3** up as far as it will go.

- Lift the topcase at the rear and remove it from the luggage carrier.

Installing topcase

- Pull the handle up as far as it will go.

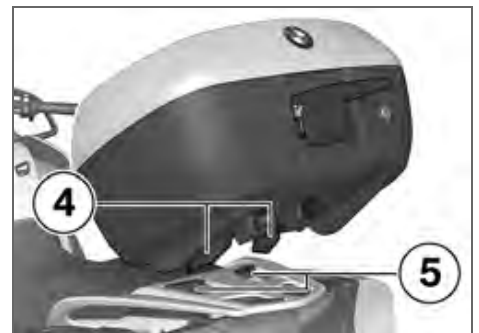

- Hook the topcase into position on the luggage carrier. Make sure that hooks **4** are securely seated in the corresponding keepers **5**.



- Push handle **3** down until it engages.
- Turn the key in the topcase lock to the LOCK position and remove the key from the lock.

Maintenance

General instructions.....	108
Toolkit	108
Engine oil	109
Brake system	110
Brake pads	111
Brake fluid	113
Clutch	115
Tyres	116
Rims	116
Wheels	117
Front-wheel stand	124
Bulbs	125
Body panels	132
Jump starting	133
Battery.....	134

General instructions

The "Maintenance" chapter describes straightforward procedures for checking and replacing certain wear parts.

Special tightening torques are listed as applicable. The tightening torques for the threaded fasteners on your motorcycle are listed in the section entitled "Technical data".

You will find information on more extensive maintenance and repair work in the Repair Manual on DVD for your motorcycle, which is available from your authorised BMW Motorrad dealer.

Some of the work calls for special tools and a thorough knowledge of motorcycle technology. If you are in doubt consult a specialist workshop, preferably your authorised BMW Motorrad dealer.

Toolkit

Standard toolkit

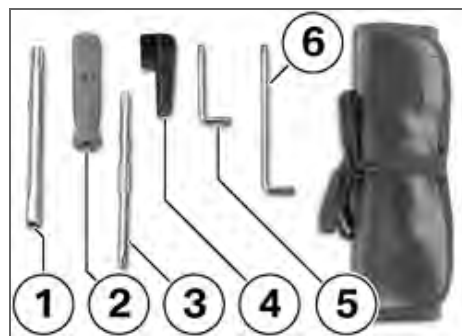

- 1** Extension for screwdriver blade
 - Adjusting damping for rear wheel (➔ 70).
- 2** Screwdriver handle

- 3** Reversible-blade screwdriver with star-head and plain tips
 - Adjusting damping for rear wheel (➔ 70).
 - Replacing brake-light, rear-light and rear-indicator bulbs (➔ 128).
 - Removing battery (➔ 136).
- 4** Tool for oil cap
 - Top up the engine oil (➔ 110).
- 5** Torx bit, T25
- 6** Torx wrench, T30
 - Remove the flashing turn indicator with fairing panel (➔ 132).

Tools service set



BMW Motorrad has assembled a tools service set that is ideal for carrying out extended service work (e.g. removing and installing wheels) on this motorcycle. You can obtain the tools set from your authorised BMW Motorrad dealer.

Engine oil

Checking engine oil level

 The oil level varies with the temperature of the oil. The higher the temperature, the higher the level of oil in the sump.

Checking the oil level with the engine cold or after no more than a short ride will lead to misinterpretation; this in turn, means that the engine will be operated with the incorrect quantity of oil. In order to ensure that the engine oil level is read correctly, check the oil level only after a lengthy trip. ◀

- Switch off the engine when it is at operating temperature.
- Make sure the ground is level and firm and place the motorcycle on its centre stand.
- Wait five minutes for the oil to drain into the oil pan.



- Check the oil level in oil-level indicator **1**.

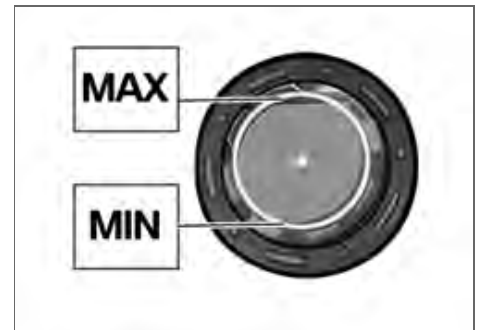

Engine oil, specified level

– Between MIN and MAX marks

If the oil level is below the MIN mark:

- Top up the engine oil (➡ 110).

If the oil level is above the MAX mark:

- Have the oil level corrected by a specialist workshop, preferably an authorised BMW Motorrad dealer.

Top up the engine oil

- Make sure the ground is level and firm and place the motorcycle on its stand.



- Wipe the area around the filler neck clean.
- Use the tool from the toolkit to remove cap **1** from the engine-oil filler neck.

 Damage to the engine can result if it is operated without enough oil, but the same also applies if the oil level is too high.

Always make sure that the oil level is correct.◀

- Top up the engine oil to the specified level.
- Checking engine oil level (➡ 109).

- Use the tool from the toolkit to install the cap in the engine-oil filler neck.

Brake system

Reliability

A fully functional brake system is a basic requirement for the road safety of your motorcycle.

Do not ride the motorcycle if you have any doubts about the dependability of the brake system. Under these circumstances have the brake system checked by a specialist workshop, preferably an authorised BMW Motorrad dealer.

 Incorrect working practices endanger the reliability of the brakes.

Have all work on the brake system undertaken by trained and qualified specialists.◀

Checking operation of brakes

- Pull the handbrake lever.
 - » The pressure point must be clearly perceptible.
- Press the footbrake lever.
 - » The pressure point must be clearly perceptible.

If pressure points are not clearly perceptible:

- Have the brakes checked by a specialist workshop, preferably an authorised BMW Motorrad dealer.

Brake pads

Check the front brake pad thickness

- Make sure the ground is level and firm and place the motorcycle on its stand.



- Visually inspect the left and right brake pads to ascertain their thickness. Viewing direction: Between wheel and front suspension toward the brake calipers.



 Brake-pad wear limit, front

– 1.0 mm (Friction pad only, without backing plate. The wear indicators (grooves) must be clearly visible.)

If the wear indicating marks are no longer clearly visible:

 Brake pads worn past the minimum permissible thickness can cause a reduction in braking efficiency and under certain circumstances they can

cause damage to the brake system.

In order to ensure the dependability of the brake system, do not permit the brake pads to wear past the minimum permissible thickness. ◀

- Have the brake pads replaced by a specialist workshop, preferably an authorised BMW Motorrad dealer.

Checking rear brake pad thickness

- Make sure the ground is level and firm and place the motorcycle on its stand.

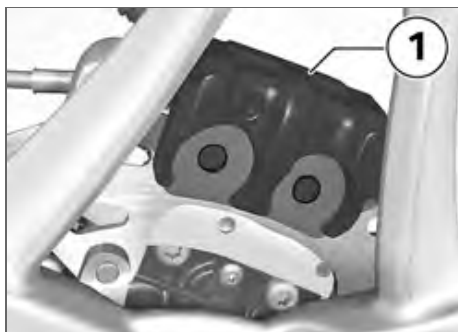

- Visually inspect the brake pads to ascertain their thickness. Viewing direction: From the left toward brake caliper **1**.

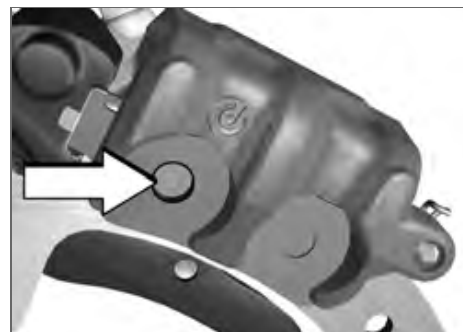

 Brake-pad wear limit, rear

– 1.0 mm (Friction pad only, without backing plate. Make sure that the brake disc is not visible through the bore in the inboard brake block.)

If the brake disc is visible:

 Brake pads worn past the minimum permissible thickness can cause a reduction in braking efficiency and under certain circumstances they can cause damage to the brake system.

In order to ensure the dependability of the brake system, do not permit the brake pads to wear past the minimum permissible thickness.◀

- Have the brake pads replaced by a specialist workshop, preferably an authorised BMW Motorrad dealer.

Brake-pad wear

The rear brake has a brake-pad wear indicator.

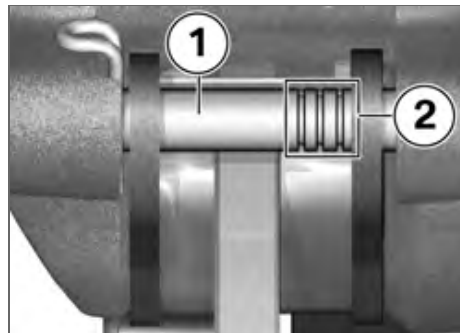

Shaft **1** with three marker rings **2** is between the brake pads.

How to interpret the marks:

- Three rings visible: brake-pad thickness is at least 75 %
- Two rings visible: brake-pad thickness is at least 50 %
- One ring visible: brake-pad thickness is at least 25 %
- No rings visible: brake pads worn to wear limit; check as described above

Brake fluid

Check the brake-fluid level, front brakes

 A low fluid level in the brake reservoir can allow air to penetrate the brake system. This significantly reduces braking efficiency.

Check the brake-fluid level at regular intervals.◀

- Make sure the ground is level and firm and place the motorcycle on its centre stand.

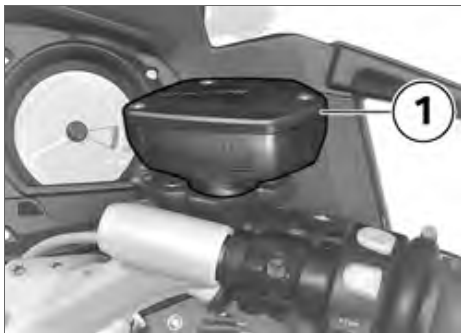

- Check the brake fluid level in front reservoir **1**.

 Wear of the brake pads causes the brake fluid level in the reservoir to sink. The drop in fluid level is compensated by a clearly visible black rubber diaphragm. ◀



	Brake fluid level, front
– DOT4 brake fluid	
– Do not permit the brake fluid level to drop below the MIN mark. (Brake-fluid reservoir horizontal)	

If the brake fluid level drops below the permitted level:

- Have the defect rectified as quickly as possible by a specialist workshop, preferably an authorised BMW Motorrad dealer.

If the bottom edge of the black diaphragm in the brake-fluid reservoir is below the MAX mark:

- Check the front brake pad thickness (➔ 111).

Check the brake-fluid level, rear brakes

 A low fluid level in the brake reservoir can allow air to penetrate the brake system. This significantly reduces braking efficiency.

Check the brake-fluid level at regular intervals. ◀

- Make sure the ground is level and firm and place the motorcycle on its centre stand.
- Remove the front seat (➔ 75).



- Check the brake fluid level in rear reservoir **1**.

 Wear of the brake pads causes the brake fluid level in the reservoir to sink.◀

 Brake fluid level, rear

- DOT4 brake fluid
- Do not permit the brake fluid level to drop below the MIN mark. (Brake-fluid reservoir horizontal, motorcycle upright)

If the brake fluid level drops below the permitted level:

- Have the defect rectified as quickly as possible by a specialist workshop, preferably an authorised BMW Motorrad dealer.

- Install the front seat (➔ 75).

Clutch

Checking clutch operation

- Pull the clutch lever.
 - » The pressure point must be clearly perceptible.
- If the pressure point is not clearly perceptible:

- Have the clutch checked by a specialist workshop, preferably an authorised BMW Motorrad dealer.

Checking clutch fluid level

- Make sure the ground is level and firm and place the motorcycle on its centre stand.
- Move the handlebars to the straight-ahead position.



- Check the clutch fluid level in reservoir **1**.

 Wear of the clutch causes the fluid level in the clutch fluid reservoir to rise.◀

	Clutch-fluid level (visual inspection)
– It is impermissible for the clutch fluid level to drop.	

If the clutch-fluid level drops:

 Unsuitable hydraulic fluids could cause damage to the clutch system.

Do not attempt to top up the system with fluids of any kind.◀

- Have the defect rectified as quickly as possible by a specialist workshop, preferably an authorised BMW Motorrad dealer.

Tyres

Checking tyre tread depth

 Your motorcycle's handling and grip can be impaired even before the tyres wear to the minimum tyre tread depth permitted by law. Have the tyres changed in good time before they wear to the minimum permissible tread depth.◀

- Make sure the ground is level and firm and place the motorcycle on its stand.

- Measure the tyre tread depth in the main tread grooves with wear marks.

 Tyres have wear indicators integrated into the main tread grooves. The tyre is worn out when the tyre tread has worn down to the level of the marks. The locations of the marks are indicated on the edge of the tyre, e.g. by the letters TI, TWI or by an arrow.◀

If the tyre tread is worn to minimum:

- Replace tyre or tyres, as applicable.

Rims

Checking rims

- Make sure the ground is level and firm and place the motorcycle on its stand.
- Visually inspect the rims for defects.

- Have damaged rims checked and, if necessary, replaced by a specialist workshop, preferably an authorised BMW Motorrad dealer.

Wheels

Tyre recommendation

For each size of tyre BMW Motorrad tests and classifies as roadworthy certain makes. BMW Motorrad cannot assess the suitability or provide any guarantee of road safety for other tyres.

BMW Motorrad recommends using only tyres tested by BMW Motorrad.

You can obtain detailed information from your authorised BMW Motorrad dealer or on the Internet at www.bmw-motorrad.com.

Effect of wheel size on suspension-control systems

Wheel size is very important as a parameter for the suspension-control systems ABS and ASC. In particular, the diameter and the width of a motorcycle's wheels are programmed into the control unit and are fundamental to all calculations. Any change in these influencing variables, caused for example by a switch to wheels other than those installed ex-works, can have serious effects on the performance of the control systems.

The sensor rings are essential for correct road-speed calculation, and they too must match the motorcycle's control systems and consequently cannot be changed.

If you decide that you would like to fit non-standard wheels to your motorcycle, it is very import-

ant to consult a specialist workshop beforehand, preferably an authorised BMW Motorrad dealer. In some cases, the data programmed into the control units can be changed to suit the new wheel sizes.

RDC label

- with tyre pressure monitoring (RDC)^{OE}



 Incorrect tyre-removal procedures can result in damage to the RDC sensors. Be sure to notify the authorised BMW Motorrad dealer or spe-

specialist workshop that the wheel is fitted with an RDC sensor. ◀

If the motorcycle is equipped with RDC, each wheel rim bears an adhesive label indicating the position of the RDC sensor. When changing the tyre, take care not to damage the RDC sensor. Be sure to draw the attention of the authorised BMW Motorrad dealer or specialist workshop to the fact that the wheel is fitted with an RDC sensor.

Remove the front wheel

- Make sure the ground is level and firm and place the motorcycle on its centre stand.



- Remove screws **1** on left and right.
- Work the front-wheel cover forward to remove, pulling the two sides slightly apart.

- Mask off the parts of the wheel rim that could be scratched in the process of removing the brake calipers.



- Unclip two clips **1** holding the sensor cable to the brake line.

⚠ Once the calipers have been removed, there is a risk of the brake pads being pressed together to the extent that they cannot be slipped back over the brake disc on reassembly. Do not operate the handbrake lever when the brake calipers have been removed. ◀

- Remove screws **2** of the brake calipers on left and right.

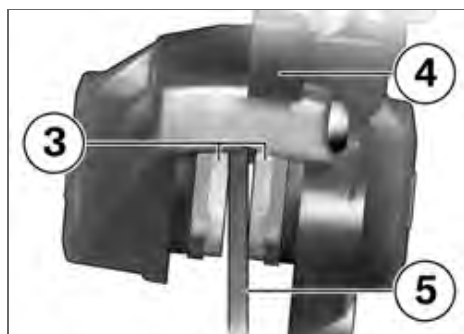

- Force the brake pads **3** slightly apart by rocking brake caliper **4** back and forth against brake disc **5**.
- Carefully pull the brake calipers back and out until clear of the brake discs.
- Raise front of motorcycle until the front wheel can turn freely. BMW Motorrad recommends the BMW Motorrad front-wheel stand for lifting the motorcycle.

- Install the front-wheel stand (→ 124).

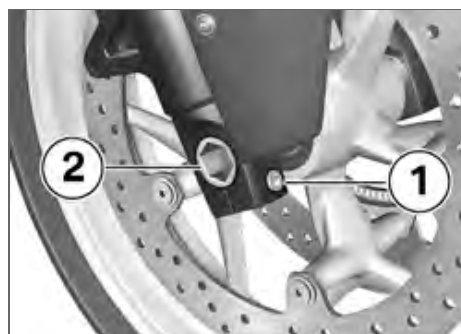

- Release axle clamping screw **1**.
- Remove quick-release axle **2**, while supporting the wheel.
- Do not remove the grease from the quick-release axle.
- Roll the front wheel forward and clear of the forks, noting the ABS sensor on the left-hand side.
- Remove the spacing bushing from the left-hand side of the front-wheel hub.

Installing front wheel

⚠ Possible malfunctions when ABS and ASC systems intervene if non-standard wheels are installed.

See the information on the effect of wheel size on the ABS and ASC systems at the start of this chapter. ◀

⚠ Threaded fasteners not tightened to the specified torque can work loose or their threads can suffer damage. Always have the security of the fasteners checked by a specialist workshop, preferably an authorised BMW Motorrad dealer. ◀

- Slip the spacing bushing into the left-hand side of the wheel hub.

⚠ The front wheel must be installed right way round to rotate in the correct direction. Note the direction-of-rotation ar-

rows on the tyre or the wheel rim.◀

- Roll the front wheel into position between the forks, noting the ABS sensor on the left-hand side.

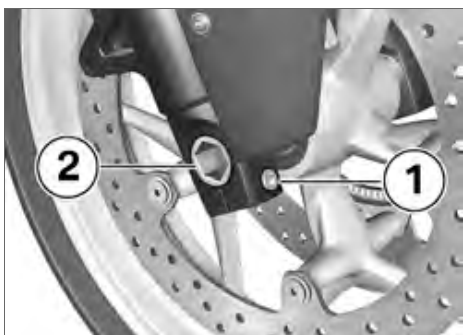

- Raise the front wheel, insert quick-release axle **2** and tighten to specified torque.

 Quick-release axle in axle holder
– 50 Nm

- Tighten axle clamping screw **1** to the specified torque.

 Quick-release axle clamp screws
– 20 Nm

- Remove the front-wheel stand.
- Ease the brake calipers on to the brake discs.



- Tighten screws **2** on left and right to the specified tightening torque.

 Brake caliper to slider tube
– 30 Nm



- Clip on two clips **1** holding the sensor cable to the brake line.

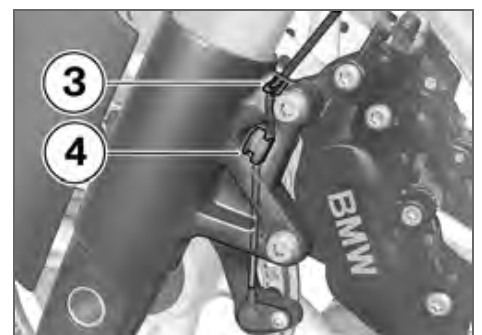

- Make sure that the sensor cable is seated in holders **3** and **4**.

- Remove the adhesive tape from the wheel rim.

! Braking efficiency is impaired if the brake pads are not correctly bedded against the discs.

Before riding off, always check that the brakes bite as soon as the brake lever is pulled or the brake pedal depressed.◀

- Operate the brake several times until the brake pads are bedded.



- Hold the front-wheel cover in position and install bolts **1** on left and right.

Removing rear wheel

- Make sure the ground is level and firm and place the motorcycle on its centre stand.
- If applicable, remove the cases.

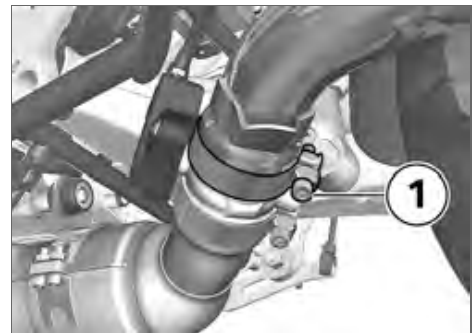

! Parts of the exhaust system can be hot. Do not touch hot parts of the exhaust system.◀

- Slacken screw **1** of the clamp and slip the clamp to the rear.
- Do not remove the sealing grease from the clamp.



- Remove screw **2** for the bracket of the end silencer from the rear footrest.
- Work the end silencer to the rear to remove and lay it on a padded rest.
- Engage first gear.

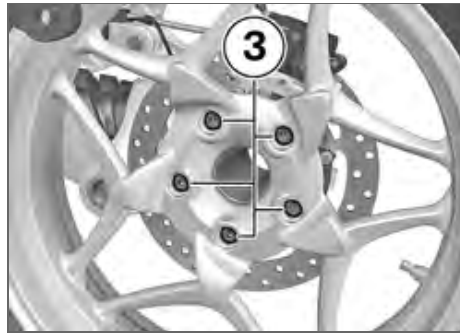

- Remove studs **3** from the rear wheel, while supporting the wheel.
- Lower the rear wheel to the ground and roll it out to the rear.

Install the rear wheel

 Possible malfunctions when ABS and ASC systems intervene if non-standard wheels are installed.

See the information on the effect of wheel size on the ABS and ASC systems at the start of this chapter. ◀

 Threaded fasteners not tightened to the specified torque can work loose or their threads can suffer damage. Always have the security of the fasteners checked by a specialist workshop, preferably an authorised BMW Motorrad dealer. ◀

- Seat the rear wheel on the rear-wheel adapter.

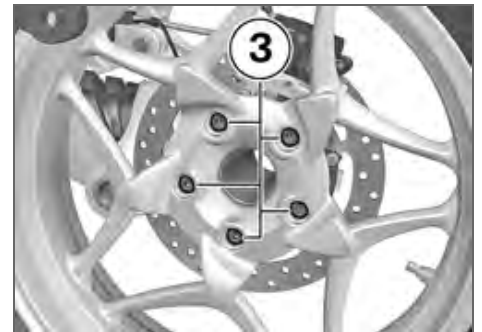

- Install screws **3** and tighten to the specified tightening torque.

 Rear wheel to wheel carrier
– Tightening sequence: tighten in diagonally opposite sequence
– 60 Nm

- Push the end silencer onto the pipe at the exhaust-flow control valve and turn it to its initial position.

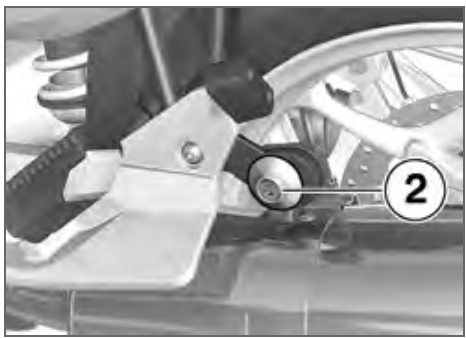

 If the gap between the rear wheel and the silencer is

too small, the rear wheel can overheat.
The gap between the rear wheel and the silencer must be at least 20 mm. ◀

- Align the silencer, install screw **2** and tighten to the specified torque.

 Silencer to rear frame
– 19 Nm

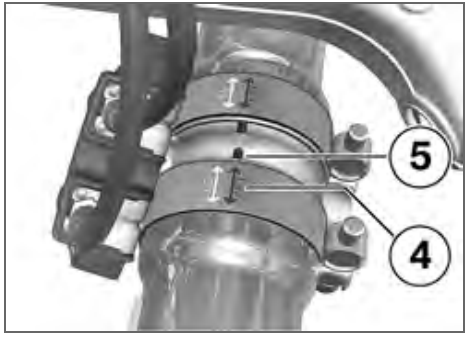

- Slip the clamp forward as far as it will go and turn it so that R/

RT mark **4** on the clamp is in line with mark **5**.

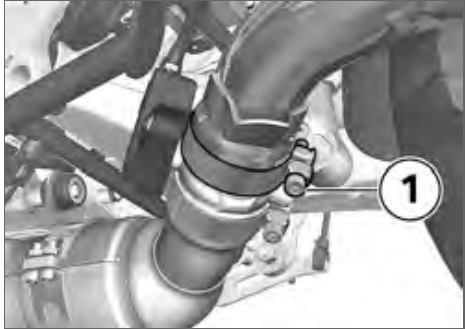

- Tighten screw **1** to the specified tightening torque.

 Clamp to silencer and manifold
– 28 Nm

- If applicable, install the cases.

Front-wheel stand Install the front-wheel stand

! The BMW Motorrad front wheel stand is not designed to support motorcycles not fitted with a centre stand or without other auxiliary stands. A motorcycle resting only on the front wheel stand and the rear wheel can topple.

Place the motorcycle on its centre stand or another auxiliary stand before lifting the front wheel with the BMW Motorrad front-wheel stand.◀

- Make sure the ground is level and firm and place the motorcycle on its centre stand.
- Use basic stand with tool number (0 402 241) in combination with front-wheel adapter (0 402 242).

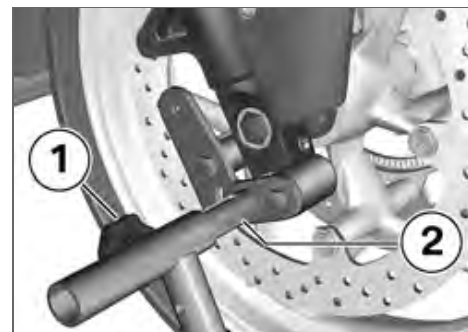
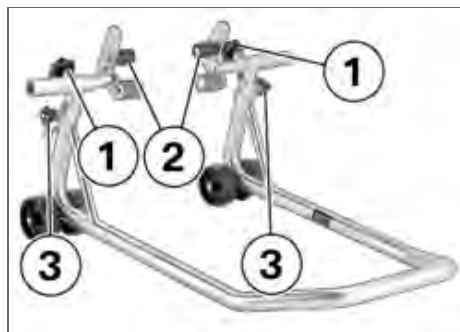

- Slacken adjusting screws **1**.
- Push the two adapters **2** apart until the front forks fit between them.
- Use locating pins **3** to set the front-wheel stand to the desired height.
- Centre the front-wheel stand relative to the front wheel and push it against the front axle.
- Align the two adapters **2** so that the front forks are securely seated.
- Tighten adjusting screws **1**.



Bulbs

General instructions

A warning appears in the multi-function display if a bulb is defective. If the brake or rear light fails, the symbol is accompanied by the 'General' warning light, which lights up yellow. If the rear light fails the second filament of the brake light shines at reduced brightness to double as a rear light. Even though you have this substitute rear light, the indicators on the display tell you that a bulb defect has occurred.

 A defective bulb places your safety at risk because it is easier for other users to oversee the motorcycle. Replace defective bulbs as soon as possible; always carry a complete set of spare bulbs if possible.◀

 If the motorcycle is on the centre stand and is raised too far, the centre stand will lift clear of the ground and the motorcycle could topple to one side. When raising the motorcycle, make sure that the centre stand remains on the ground.◀

- Apply uniform pressure to push the front-wheel stand down and raise the motorcycle.

 The bulb is pressurised and can cause injury if damaged.

Wear protective goggles and gloves when changing bulbs.◀

 The types of bulb fitted to your motorcycle are listed in the section entitled "Technical data".◀

Replacing low-beam and high-beam headlight bulb

 The positions of the plug, the spring retainer and the bulb might not be as illustrated below.◀

- Make sure the ground is level and firm and place the motorcycle on its stand.
- Switch off the ignition.

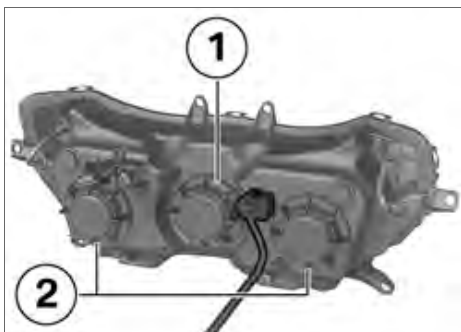

- Remove cover **1** for the high-beam headlight or covers **2** for the low-beam headlight.



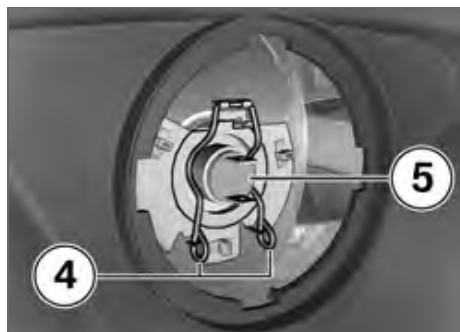

- Disconnect plug **3**.



- Release spring clip **4** at left and right and swing it up.
- Remove bulb **5**.
- Replace the defective bulb.

 Do not touch the glass of new bulbs with your fingers. Use a clean, dry cloth to hold the bulbs when handling them. Dirt deposits, in particular oil and grease, interfere with heat radiation from the bulb. This leads to overheating and shortens the bulb's operating life.◀

	Bulbs for the low-beam headlight
- H7 / 12 V / 55 W	
	Bulb for high-beam headlight
- H7 / 12 V / 55 W	

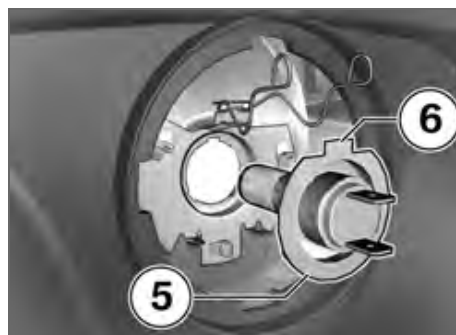

- Install bulb **5**, making sure that tab **6** is correctly positioned.



- Engage spring clip **4** in the catch on left and right.



- Close plug **3**.

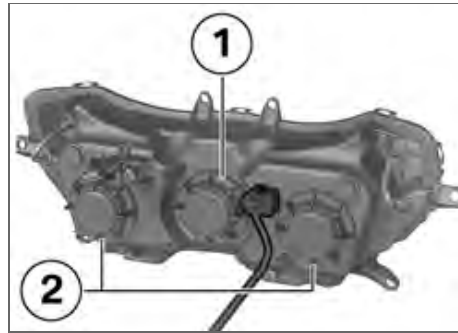

- Install cover **1** for the high-beam headlight or cover **2** for the low-beam headlight.

Replacing parking-light bulb

- Remove the flashing turn indicator with fairing panel (→ 132).

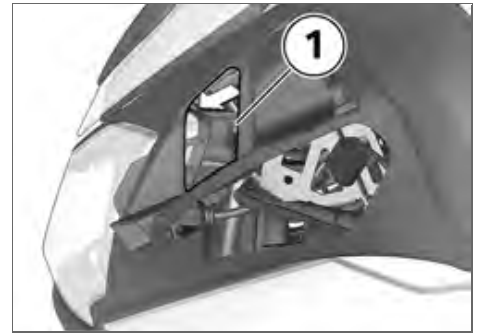

- Remove the side-light bulb through opening **1**.

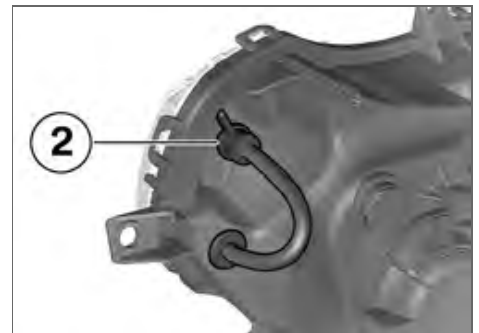

- Remove the bulb holder from the headlight housing by turning lever **2** counter-clockwise.

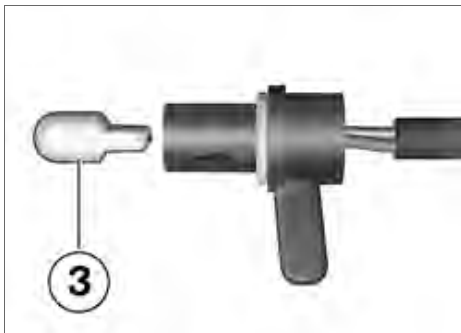

- Remove bulb **3** from the bulb holder.
- Replace the defective bulb.

▶ Do not touch the glass of new bulbs with your fingers. Use a clean, dry cloth to hold the bulbs when handling them. Dirt deposits, in particular oil and grease, interfere with heat radiation from the bulb. This leads to overheating and shortens the bulb's operating life.◀

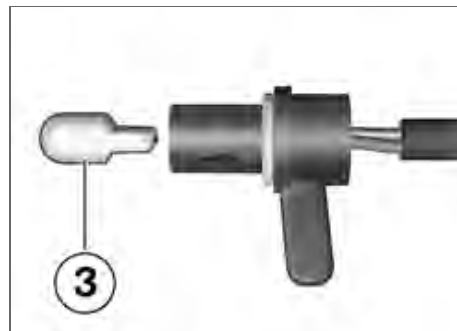
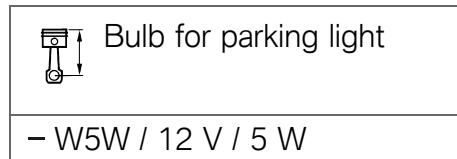

- Fit the bulb **3** in the bulb holder.

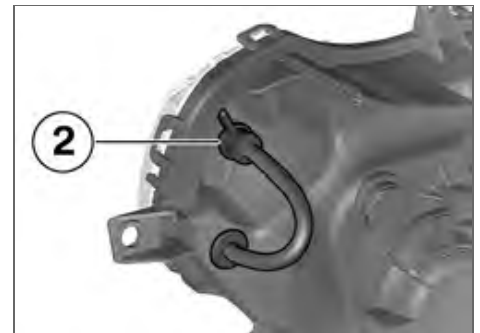

- Insert the bulb holder into the headlight housing and turn lever **2** clockwise to latch it in position.
- Installing flashing turn indicator with fairing panel (➔ 133).

Replacing brake-light, rear-light and rear-indicator bulbs

⚠ If it is not standing firmly, the motorcycle could topple in the course of the operations described below. Always make sure that the

motorcycle is stable and firmly supported.◀

- Make sure the ground is level and firm and place the motorcycle on its stand.
- Switch off the ignition.
- If applicable, remove the cases.



- Remove screws **1** on left and right and work the bulb housing to the rear to remove.

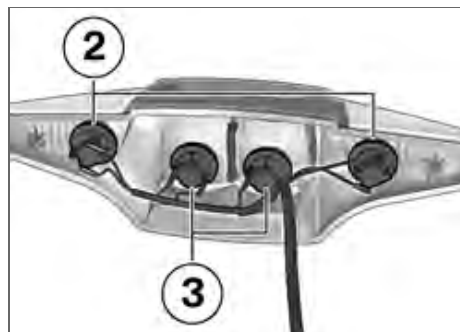

- Turn bulb holders **2** for the indicator bulbs or bulb holders **3** for the brake-light/rear-light bulbs counter-clockwise to remove them from the bulb housing.

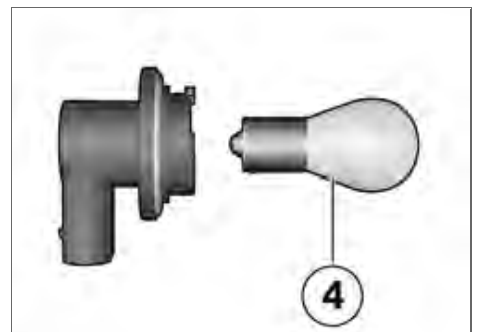

- Press bulb **4** into its socket and turn it counter-clockwise to remove.
- Replace the defective bulb.

 Do not touch the glass of new bulbs with your fingers. Use a clean, dry cloth to hold the bulbs when handling them. Dirt deposits, in particular oil and grease, interfere with heat radiation from the bulb. This leads to overheating and shortens the bulb's operating life.◀

 Bulb for tail light/brake light

- P21W / 12 V / 21 W

 Bulbs for flashing turn indicators, rear

- PY21W / 12 V / 21 W

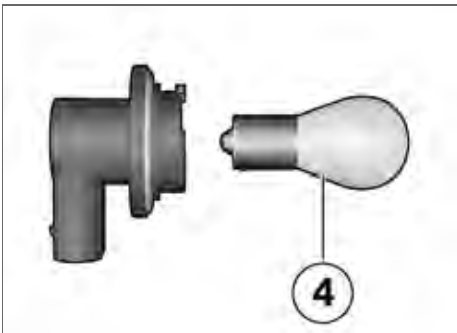

- Press bulb **4** into its socket and turn it clockwise to install.
- Insert the bulb holder removed beforehand into the bulb housing and turn the bulb holder clockwise to latch it in position.

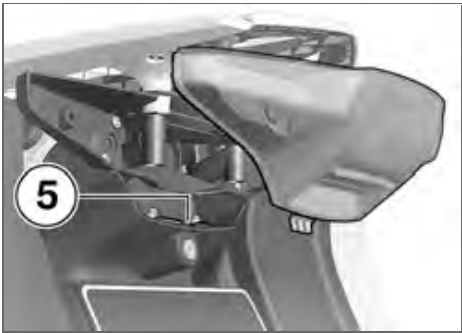

- Engage the bulb housing at position **5**.



- Install screws **1** on left and right.

Replacing front turn indicator bulb

- Remove the flashing turn indicator with fairing panel (➡ 132).



- Turn bulb holder **1** counter-clockwise to remove it from the bulb housing.

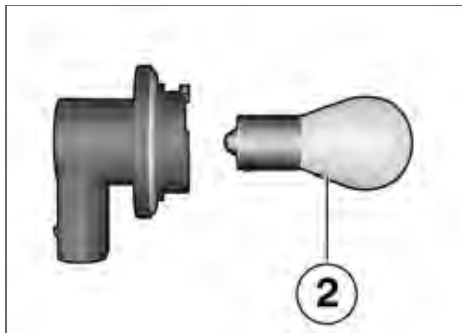

 Bulbs for flashing turn indicators, front
- PY21W / 12 V / 21 W

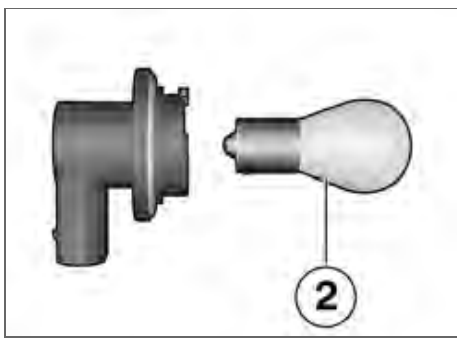

- Press bulb **2** into its socket and turn it counter-clockwise to remove.
- Replace the defective bulb.

 Do not touch the glass of new bulbs with your fingers. Use a clean, dry cloth to hold the bulbs when handling them. Dirt deposits, in particular oil and grease, interfere with heat radiation from the bulb. This leads to overheating and shortens the bulb's operating life.◀

- Press bulb **2** into its socket and turn it clockwise to install.



- Insert bulb holder **1** into the bulb housing and turn the bulb holder clockwise to latch it in position.
- Installing flashing turn indicator with fairing panel (→ 133).

Body panels

Removing flashing turn indicator with fairing panel



- Press the mirror down and out.

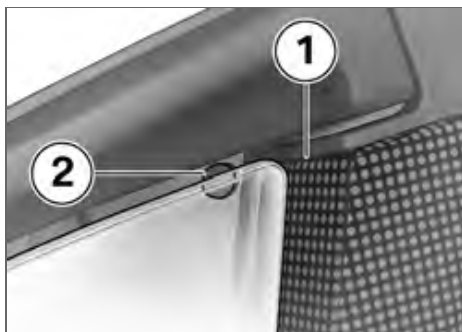

- Guide tool from toolkit parallel to edge **1** of the speaker grille and through aperture **2**.

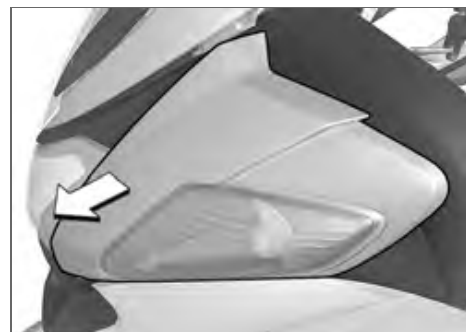

- Work the flashing turn indicator and the fairing panel forward to remove.



- Remove screw **3** inside the aperture, while holding the fairing panel in position.



- Disconnect plug **4**.
- Lay the fairing panel on a padded rest.

Installing flashing turn indicator with fairing panel



- Connect plug **4**.

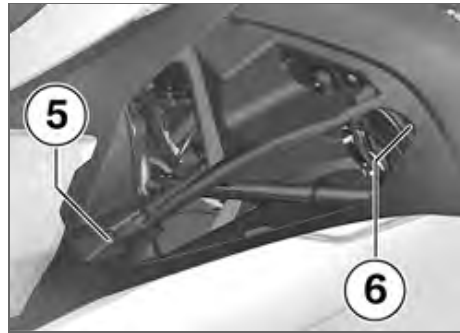

- Work the flashing turn indicator with fairing panel into place at positions **5** and **6**.



- Install screw **3** while holding the fairing panel in position.
- Adjust the mirror.

Jump starting

! The wires leading to the power socket do not have a load-capacity rating adequate for jump-starting the engine. Excessively high current can lead to a cable fire or damage to the vehicle electronics.

Do not use the on-board socket to jump-start the engine of the motorcycle. ◀

! Touching live parts of the ignition system with the engine running can cause electric shock.

Do not touch parts of the ignition system when the engine is running. ◀

! A short-circuit can result if the crocodile clips of the jump leads are accidentally brought into contact with the motorcycle.

Use only jump leads fitted with

fully insulated crocodile clips at both ends. ◀

 Jump-starting with a donor-battery voltage higher than 12 V can damage the vehicle electronics.

Make sure that the battery of the donor vehicle has a voltage rating of 12 V. ◀

- Make sure the ground is level and firm and place the motorcycle on its stand.
- Remove the front seat (➡ 75).
- When jump-starting the engine, do not disconnect the battery from the on-board electrical system.
- Remove the protective cap from the battery's positive terminal.
- Begin by connecting one end of the red jump lead to the positive terminal of the discharged battery and the other

end to the positive terminal of the donor battery.

- Then connect one end of the black jump lead to the negative terminal of the donor battery, and the other end to the negative terminal of the discharged battery.
- Run the engine of the donor vehicle during jump-starting.
- Start the engine of the vehicle with the discharged battery in the usual way; if the engine does not start, wait a few minutes before repeating the attempt in order to protect the starter motor and the donor battery.
- Allow both engines to idle for a few minutes before disconnecting the jump leads.
- Disconnect the jump lead from the negative terminals first, then disconnect the second lead from the positive terminals.

- Reinstall the protective cap on the battery positive terminal.

 Do not use proprietary start-assist sprays or other products to start the engine. ◀

- Install the front seat (➡ 75).

Battery

Maintenance instructions

Correct upkeep, recharging and storage will prolong the life of the battery and are essential if warranty claims are to be considered.

Compliance with the points below is important in order to maximise battery life:

- Keep the surface of the battery clean and dry
- Do not open the battery
- Do not top up with water
- Be sure to read and comply with the instructions for char-

ging the battery on the following pages

- Do not turn the battery upside down



If the battery is not disconnected, the on-board electronics (e.g. clock, etc.) gradually drain the battery. This can cause the battery to run flat. If this happens, warranty claims will not be accepted.

If the motorcycle is to be out of use for more than four weeks, disconnect the battery or connect a suitable trickle charger to the battery.◀



BMW Motorrad has developed a float charger specially designed for compatibility with the electronics of your motorcycle. Using this charger, you can keep the battery charged during long periods of disuse, without having to disconnect the battery from the motorcycle's

on-board systems. You can obtain additional information from your authorised BMW Motorrad dealer.◀

Charge the battery when connected



Charging the connected battery directly at the battery terminals can damage the vehicle electronics.

Always disconnect the battery from the on-board circuits before recharging it with a charger connected directly to the battery posts.◀



If you switch on the ignition and the multifunction display and telltale lights fail to light up, the battery is completely flat. Attempting to charge a completely flat battery via the on-board socket can cause damage to the motorcycle's electronics. If a battery has discharged to the

extent that it is completely flat, it has to be disconnected from the on-board circuits and charged with the charger connected directly to the battery posts.◀



Only chargers suitable for this mode of charging can be used to recharge the battery via the on-board socket. Unsuitable chargers could cause damage to the motorcycle's on-board electrics.

Use BMW chargers with the part numbers 71 60 7 688 864 (220 V) or, as applicable, 71 60 7 688 865 (110 V). If

you are in doubt, disconnect the battery from the on-board systems and connect the charger directly to the battery.◀

- Charge via the power socket, with the battery connected to the motorcycle's on-board electrical system.

▶ The motorcycle's on-board electronics know when the battery is fully charged. The on-board socket is switched off when this happens.◀

- Comply with the operating instructions of the charger.

▶ If you are unable to charge the battery through the on-board socket, you may be using a charger that is not compatible with your motorcycle's electronics. If this happens, disconnect the battery from the on-board systems and connect the charger directly to the battery.◀◀

Charging battery when disconnected

- Charge the battery using a suitable charger.
- Comply with the operating instructions of the charger.
- Once the battery is fully charged, disconnect the

charger's terminal clips from the battery terminals.

▶ The battery has to be recharged at regular intervals in the course of a lengthy period of disuse. See the instructions for caring for your battery. Always fully recharge the battery before restoring it to use◀

Removing battery

- Make sure the ground is level and firm and place the motorcycle on its stand.
- with anti-theft alarm (DWA)^{OE}
- If applicable, switch off the anti-theft alarm.◀
- Switch off the ignition.
- Remove the front seat (➡ 75).

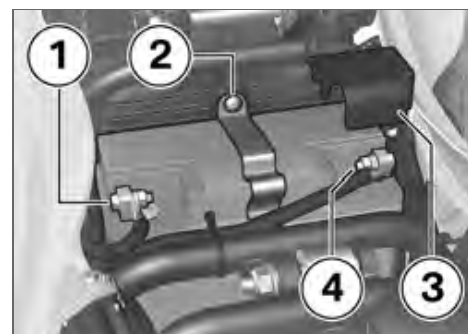

! Disconnection in the wrong sequence increases the risk of short-circuits. Always proceed in the correct sequence.◀

- Disconnect negative battery lead **1** first.
- Then pull back protective cap **3** and disconnect battery positive lead **4**.
- Remove screw **2**, disengage the retaining strap at the bottom and remove.
- Lift the battery up and out; work it slightly back and forth if it is difficult to remove.

Installing battery

- Place the battery in the battery compartment, positive terminal on the right in the forward direction of travel.

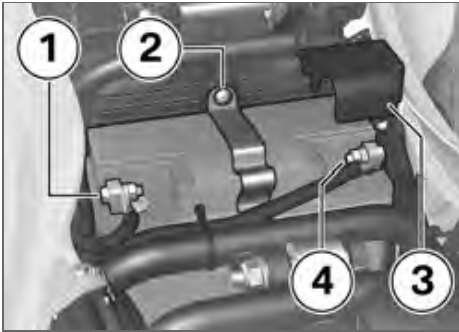

- Engage the retainer at the bottom, push it over the battery and install screw **2**.

! Installation in the wrong sequence increases the risk of short-circuits.

Always proceed in the correct sequence.

Never install the battery without the protective cap.◀

- Connect battery positive lead **4** first.
- Fit protective cap **3** to the positive terminal of the battery.
- The connect battery negative lead **1**.

▶ If the battery was disconnected from the motorcycle for a prolonged period of time it will be necessary to enter the current date in the instrument panel, in order to ensure that the service-due indicator functions correctly.

If you want to have the date set consult a specialist workshop, preferably an authorised BMW Motorrad dealer.◀

- Install the front seat (➡ 75).
- Setting clock (➡ 51).

Care

Care products	140
Washing motorcycle	140
Cleaning easily damaged components.....	140
Paint care	141
Protective wax coating	142
Laying up motorcycle	142
Restoring motorcycle to use	142

Care products

BMW Motorrad recommends that you use the cleaning and care products you can obtain from your authorised BMW Motorrad dealer. The substances in BMW CareProducts have been tested in laboratories and in practice; they provide optimised care and protection for the materials used in your vehicle.

 The use of unsuitable cleaning and care products can damage vehicle components. Do not use solvents such as cellulose thinners, cold cleaners, fuel or the like, and do not use cleaning products that contain alcohol. ◀

Washing motorcycle

BMW Motorrad recommends that you use BMW insect remover to soften and wash off insects and stubborn dirt on

painted parts prior to washing the motorcycle.

To prevent stains, do not wash the motorcycle immediately after it has been exposed to strong sunlight and do not wash it in the sun.

Make sure that the motorcycle is washed frequently, especially during the winter months.

To remove road salt, clean the motorcycle with cold water immediately after every trip.

 After the motorcycle has been washed, ridden through water or ridden in the rain, the brake discs and pads might be wet and the brakes might not take effect immediately.

Apply the brakes in good time until the brake discs and brake pads have dried out. ◀

 Warm water intensifies the effect of salt.

Use only cold water to wash off road salt. ◀

 The high pressure of steam cleaners can damage seals, the hydraulic brake system, the electrical system, and the seat. Do not use a steam jet or high-pressure cleaning equipment. ◀

Cleaning easily damaged components

Body panels

Clean the trim panels with water and BMW plastic care emulsion.

 If plastic parts are cleaned using unsuitable cleaning agents, the surfaces can be damaged.

Do not use cleaning agents that contain alcohol, solvents or abrasives to clean plastic parts.

Even fly-remover pads or cleaning pads with hard surfaces can produce scratches. ◀

 Soften stubborn dirt and insects by covering the affected areas with a wet cloth. ◀

Windscreen and headlight lens plastic

Clean off dirt and insects with a soft sponge and plenty of water.

 Fuel and chemical solvents attack the material of the windscreen; the windscreen becomes opaque or dull. Do not use cleaning agents. ◀

Chrome

Use plenty of water and BMW shampoo to clean chrome, particularly if it has been exposed to road salt. Use chrome polish for additional treatment.

Radiator

Clean the radiator regularly to prevent overheating of the engine due to inadequate cooling. For example, use a garden hose with low water pressure.

 Cooling fins can be bent easily. Take care not to bend the fins when cleaning the radiator. ◀

Rubber

Treat rubber components with water or BMW rubber-care products.

 Using silicone sprays for the care of rubber seals can cause damage. Do not use silicone sprays or other care products that contain silicon. ◀

Paint care

Washing the motorcycle regularly will help counteract the long-term effects of substances that damage the paint, especially if your motorcycle is ridden in areas with high air pollution or natural sources of dirt, for example tree resin or pollen.

Remove particularly aggressive substances immediately, however, as otherwise the paint can be affected or become discoloured. Substances of this nature include spilt fuel, oil, grease, brake fluid and bird droppings. We recommend BMW vehicle polish or BMW paint cleaner for this purpose.

Marks on the paintwork are particularly easy to see after the motorcycle has been washed. Remove stains of this kind immediately, using cleaning-grade benzene or petroleum spirit on a clean cloth or ball of cotton wool.

BMW Motorrad recommends BMW tar remover for removing specks of tar. Remember to wax the parts treated in this way.

Protective wax coating

BMW Motorrad recommends applying only BMW car wax or products containing carnauba wax or synthetic wax.

It is time to rewax the paint-work when water "puddles" on the surface, instead of forming beads.

Laying up motorcycle

- Clean the motorcycle.
- Removing battery (➡ 136).
- Spray the brake and clutch lever pivots and the main and side stand pivots with a suitable lubricant.
- Coat bright metal and chrome-plated parts with an acid-free grease (e.g. Vaseline).

- Stand the motorcycle in a dry room in such a way that there is no load on either wheel. Authorised BMW Motorrad dealers can provide suitable auxiliary stands.

 Before laying the vehicle up out of use, have the engine oil and the oil filter element changed by a specialist workshop, preferably an authorised BMW Motorrad dealer. Combine work for laying up/restoring to use with a BMW service or inspection.◀

Restoring motorcycle to use

- Remove the protective wax coating.
- Clean the motorcycle.
- Install a charged battery.
- Before starting: work through the checklist.

Technical data

Troubleshooting chart	144	Riding specifications	157
Threaded fasteners	145		
Engine	147		
Fuel.....	148		
Engine oil	149		
Clutch	150		
Transmission	150		
Rear-wheel drive	151		
Running gear	151		
Brakes	153		
Wheels and tyres	153		
Electrics	154		
Frame	155		
Dimensions	156		
Weights.....	157		

Troubleshooting chart

Engine does not start at all or is difficult to start.

Possible cause	Remedy
Emergency off switch (kill switch)	Kill switch in operating position
Side stand	Retract the side stand. (➡ 82)
Gear engaged and clutch not disengaged	Select neutral or pull clutch lever (➡ 82)
Clutch pulled before ignition was switched on	Switch on the ignition, then pull the clutch lever
No fuel in tank	Refuelling (➡ 87).
Battery flat	Charge the battery when connected (➡ 135).

Threaded fasteners

Front wheel		Value	Valid
Brake caliper to slider tube			
M8 x 32 - 10.9		30 Nm	
Quick-release axle clamp screws			
M8 x 40		20 Nm	
Quick-release axle in axle holder			
M24 x 1.5		50 Nm	
Rear wheel		Value	Valid
Clamp to silencer and manifold			
M8 x 40 - 10.9		28 Nm	
Silencer to rear frame			
M8 x 35		19 Nm	
Rear wheel to wheel carrier			
M10 x 1.25 x 40		tighten in diagonally opposite sequence	
		60 Nm	

Shift lever	Value	Valid
Selector lever to selector shaft		
M6 x 25	8 Nm	

Engine

Engine design	Four-stroke opposed twin, air-cooled with oil-cooled exhaust ports, installed longitudinally, two overhead camshafts and four radially positioned valves per cylinder, electronic engine management.
Displacement	1170 cm ³
Cylinder bore	101 mm
Piston stroke	73 mm
Compression ratio	12.0 : 1
Nominal output	81 kW, - at engine speed: 7750 min ⁻¹
- with power reduction ^{OE}	72 kW, - at engine speed: 7750 min ⁻¹
Torque	120 Nm, - at engine speed: 6000 min ⁻¹
- with power reduction ^{OE}	120 Nm, - at engine speed: 6000 min ⁻¹
Maximum engine speed	max 8500 min ⁻¹
Idle speed	1150 ^{±50} min ⁻¹ , Engine at regular operating temperature

Fuel

Recommended fuel grade	Premium plus unleaded 98 ROZ/RON 91 AKI
alternative fuel grade	Premium unleaded (slight power- and consumption-related restrictions) 95 ROZ/RON 89 AKI
Usable fuel capacity	approx. 25 l
Reserve fuel	approx. 4 l

BMW recommends BP fuels

Engine oil

Engine oil, capacity	max 4.0 l, with filter change
of products recommended by BMW Motorrad and generally admissible viscosity classes	
Castrol GPS SAE 10W-40, API SG / JASO MA	≥ -20 °C
SAE 5W-40, API SF / ACEA A2, or better	≥ -20 °C
SAE 5W- ≥ 50 , API SF / ACEA A2, or better	≥ -20 °C
SAE 10W-40, API SF / ACEA A2, or better	≥ -10 °C
SAE 10W- ≥ 50 , API SF / ACEA A2, or better	≥ -20 °C
SAE 15W- ≥ 40 , API SF / ACEA A2, or better	≥ 0 °C

BMW recommends 

Clutch

Clutch type	Single-plate dry clutch
-------------	-------------------------

Transmission

Gearbox type	Helical 6-speed gearbox with integral reaction damper, claw-action shift by sliding sleeves
Gearbox transmission ratios	1.737 (19:33 teeth), Primary transmission ratio 2.375 (38:16 teeth), 1st gear 1.696 (39:23 teeth), 2nd gear 1.296 (35:27 teeth), 3rd gear 1.065 (33:31 teeth), 4th gear 0.939 (31:33 teeth), 5th gear 0.848 (28:33 teeth), 6th gear

Rear-wheel drive

Type of final drive	Shaft drive with bevel gears
Type of rear suspension	Cast-aluminium single swinging arm with BMW Motorrad Paralever
Gear ratio of final drive	2.620 (34:13 teeth)

Running gear

Front wheel

Type of front suspension	BMW Telelever, with anti-dive top fork bridge, leading link pivot-mounted on engine and telescopic forks, central spring strut supported by leading link and front frame
Spring strut, front, type	Central spring strut with coil spring
– With Electronic Suspension Adjustment (ESA II) ^{SA}	Central spring strut with electrically adjustable rebound-stage damping.
Spring travel, front	120 mm, At wheel
– with lowered suspension ^{OE}	94 mm, At wheel

Rear wheel	
Type of rear suspension	Cast-aluminium single swinging arm with BMW Motorrad Paralever
Type of rear suspension	Central spring strut with coil spring and single-tube gas-filled shock absorber, steplessly adjustable rebound-stage damping and hydraulically adjustable spring preload
– With Electronic Suspension Adjustment (ESA II) ^{SA}	Central spring strut with coil and elastomeric springs and single-tube gas-filled shock absorber, electrically adjustable rebound-stage damping and electro-hydraulically adjustable spring preload
Spring travel at rear wheel	135 mm, At wheel
– with lowered suspension ^{OE}	109 mm, At wheel

Brakes

Type of front brake	Hydraulically operated twin disc brake with 4-piston fixed calipers and floating brake discs
Brake-pad material, front	Sintered metal
Type of rear brake	Hydraulically operated disc brake with 2-piston floating caliper and fixed disc
Brake-pad material, rear	Sintered metal

Wheels and tyres

Recommended tyre sets	You can obtain an up-to-date list of approved tyres from your authorised BMW Motorrad dealer or on the Internet at " www.bmw-motorrad.com ".
-----------------------	--

Front wheel

Front wheel, type	Cast aluminium, MT H2
Front wheel rim size	3.50" x 17"
Tyre designation, front	120 / 70 ZR 17

Rear wheel

Rear wheel type	Cast aluminium, MT H2
Rear wheel rim size	5.50" x 17"
Tyre designation, rear	180 / 55 ZR 17

Tyre pressures

Tyre pressure, front	2.2 bar, one-up, tyre cold 2.5 bar, two-up and/or with luggage, tyre cold
Tyre pressure, rear	2.5 bar, one-up, tyre cold 2.9 bar, two-up and/or with luggage, tyre cold

Electrics

Electrical rating of on-board socket	max 10 A, all sockets
electronic fuse	Electronic fuses protect all the circuits. If an electronic fuse trips and de-energises a circuit, the circuit is active as soon as the ignition is switched on after the fault has been rectified.

Battery

Battery type	Gel battery
Battery rated voltage	12 V
Battery rated capacity	19 Ah

Spark plugs

Spark plugs, manufacturer and designation	NGK MAR8B-JDS
Electrode gap of spark plug	0.8 \pm 0.1 mm

Lighting

Bulb for high-beam headlight	H7 / 12 V / 55 W
Bulbs for the low-beam headlight	H7 / 12 V / 55 W
Bulb for parking light	W5W / 12 V / 5 W
Bulb for tail light/brake light	P21W / 12 V / 21 W
Bulbs for flashing turn indicators, front	PY21W / 12 V / 21 W
Bulbs for flashing turn indicators, rear	PY21W / 12 V / 21 W

Frame

Frame type	Tubular steel front frame with tubular steel rear frame, load-bearing drive unit
Type plate location	underneath rear seat
VIN location	Front frame top centre

Dimensions

Length of motorcycle	2230 mm
Height of motorcycle	1430 mm, To top of windscreen when lowered, at DIN unladen weight
– with lowered suspension ^{OE}	1410 mm, To top of windscreen when lowered, at DIN unladen weight
Width of motorcycle	905 mm, with mirrors
Front-seat height	820...840 mm, At unladen weight
– with low front seat ^{OE}	780...800 mm, At unladen weight
– with lowered suspension ^{OE}	750 mm, At unladen weight
Rider's inside-leg arc, heel to heel	1880...1920 mm
– with low front seat ^{OE}	1800...1840 mm
– with lowered suspension ^{OE}	1750 mm

Weights

Unladen weight	259 kg, DIN unladen weight, ready for road 90 % load of fuel, without optional extras
Permissible gross weight	495 kg
Maximum payload	236 kg

Riding specifications

Top speed	>200 km/h
-----------	-----------

Service

BMW Motorrad service	160
BMW Motorrad service quality	160
BMW Motorrad mobility services - roadside assistance	160
BMW Motorrad service network	161
Maintenance work	161
Confirmation of maintenance work	162
Confirmation of service	167

BMW Motorrad service

Advanced technology requires specially adapted methods of maintenance and repair.

 If maintenance and repair work is performed inexpertly, it could result in consequential damage and thus constitute a safety risk.

BMW Motorrad recommends you to have all the associated work on your motorcycle carried out by a specialist workshop, preferably an authorised BMW Motorrad dealer. ◀

Your authorised BMW Motorrad dealer can provide information on BMW services and the work undertaken as part of each service. Have all maintenance and repair work carried out confirmed in the "Service" chapter in this manual. Authorised BMW Motorrad dealers are supplied with the latest technical information and have

the necessary technical know-how. BMW Motorrad recommends that you contact your authorised BMW Motorrad dealer if you have questions regarding your motorcycle.

BMW Motorrad service quality

Along with its reputation for engineering quality and high reliability, BMW Motorrad is a byword for excellent quality of service.

To ensure that your BMW is always in optimum condition, BMW Motorrad recommends that you have the maintenance work required for your motorcycle carried out regularly, preferably by your authorised BMW Motorrad dealer. For generous treatment of claims submitted after the warranty period has expired, evidence of regular maintenance is essential.

Certain signs of wear, moreover, may otherwise not be noticed until it is too late to put them right at moderate cost. Your authorised BMW Motorrad dealer's mechanics know every detail of your motorcycle and can take remedial action if necessary before minor faults develop into serious problems. By having the necessary repairs done properly and in good time, you save time and money in the long run.

BMW Motorrad mobility services - roadside assistance

In the event of a breakdown, the BMW Motorrad mobility services available for each new BMW motorcycle enable you to access an extensive range of services such as breakdown assistance, motorcycle transportation etc. (details can differ from country to country). In the event of a breakdown,

contact the Mobile Service organisation of BMW Motorrad. The specialists will provide the necessary advice and assistance. You will find important country-specific contact addresses and the after-sales service organisation phone numbers in the "Service Kontakt / Service Contact" brochures, along with information on Mobile Service and the dealership network.

BMW Motorrad service network

BMW Motorrad has an extensive after-sales service network in place to look after you and your motorcycle in more than 100 countries. In Germany alone, you have the best possible access to approximately 200 authorised BMW Motorrad dealers. All information concerning the international dealership network can be found in the brochure

"Service Contact Europe" or "Service Contact Africa, America, Asia, Australia, Oceania".

Maintenance work

BMW Pre-delivery Check

Your authorised BMW Motorrad dealer conducts the BMW pre-delivery check before handing over the motorcycle to you.

BMW Running-in Check

The BMW running-in check has to be performed when the motorcycle has covered between 500 km and 1200 km

BMW Service

The BMW Service is carried out once a year; the extent of servicing can vary, depending on the age of the motorcycle and the distance it has covered. Your authorised BMW Motorrad dealer confirms that the service work has been carried out and enters

the date when the next service will be due.

Riders who cover long distances in a year might have to bring in their motorcycles for service before the next scheduled date. It is to allow for these cases that a maximum odometer reading is entered as well in the confirmation of service. Servicing has to be brought forward if this odometer reading is reached before the next scheduled date for the service.

The service-due indicator in the multifunction display reminds you about one month or 1000 km in advance when the time for a service is approaching, on the basis of the programmed values.

Confirmation of maintenance work

BMW Pre-delivery Check

Completed

on _____

Stamp, signature

BMW Running-in Check

Completed

on _____

Odometer reading _____

Next service
at the latest

on _____

or, if logged beforehand,

Odometer reading _____

Stamp, signature

BMW Service

Completed

on _____

Odometer reading _____

Next service
at the latest

on _____

or, if logged beforehand,

Odometer reading _____

Stamp, signature

BMW Service

Completed

on _____

Odometer reading _____

Next service
at the latest

on _____

or, if logged beforehand,

Odometer reading _____

Stamp, signature

BMW Service

Completed

on _____

Odometer reading _____

Next service
at the latest

on _____

or, if logged beforehand,

Odometer reading _____

Stamp, signature

BMW Service

Completed

on _____

Odometer reading _____

Next service
at the latest

on _____

or, if logged beforehand,

Odometer reading _____

Stamp, signature

BMW Service

Completed

on _____

Odometer reading _____

Next service
at the latest

on _____

or, if logged beforehand,

Odometer reading _____

Stamp, signature

BMW Service

Completed

on _____

Odometer reading _____

Next service
at the latest

on _____

or, if logged beforehand,

Odometer reading _____

Stamp, signature

BMW Service

Completed

on _____

Odometer reading _____

Next service
at the latest

on _____

or, if logged beforehand,

Odometer reading _____

Stamp, signature

BMW Service

Completed

on _____

Odometer reading _____

Next service
at the latest

on _____

or, if logged beforehand,

Odometer reading _____

Stamp, signature

BMW Service

Completed

on _____

Odometer reading _____

Next service
at the latest

on _____

or, if logged beforehand,

Odometer reading _____

Stamp, signature

BMW Service

Completed

on _____

Odometer reading _____

Next service
at the latest

on _____

or, if logged beforehand,

Odometer reading _____

Stamp, signature

BMW Service

Completed

on _____

Odometer reading _____

Next service
at the latest

on _____

or, if logged beforehand,

Odometer reading _____

Stamp, signature

BMW Service

Completed

on _____

Odometer reading _____

Next service
at the latest

on _____

or, if logged beforehand,

Odometer reading _____

Stamp, signature

Confirmation of service

The table is intended as a record of maintenance and repair work, the installation of optional accessories and, if appropriate, special campaign (recall) work.

Item	Odometer reading	Date

Item	Odometer reading	Date

- A**
- Abbreviations and symbols, 6
 - ABS
 - Engineering details, 92
 - Self-diagnosis, 83
 - Warnings, 34
 - Accessories
 - General instructions, 100
 - Anti-theft alarm
 - Telltale light, 20
 - Warnings, 43
 - ASC
 - Control, 14
 - Operation, 63
 - Self-diagnosis, 84
 - Warnings, 36
 - Audio system
 - Control, 14
- B**
- Battery
 - Charging battery when connected, 135
 - Charging battery when disconnected, 136
 - Installation, 137
 - Maintenance instructions, 134
 - Removal, 136
 - Stowage, 19
 - Warning, battery charge current, 30
 - BMW Motorrad service, 160
 - Brake fluid
 - Reservoir, front, 11
 - Reservoir, rear, 19
 - Test, 113
 - Brake pads
 - Checking brake-pad thickness, 111
 - Running in, 85
 - Brakes
 - Adjust the handbrake lever, 67
 - Checking operation, 110, 111
 - Safety instructions, 85
 - Technical data, 153
 - Wear indicator, 113
 - Bulbs
 - General instructions, 125
 - Overview, headlights, 21
 - Replacing brake-light bulb, 128
 - Replacing front turn indicator bulb, 130
 - Replacing high-beam headlight bulb, 125
 - Replacing low-beam headlight bulb, 125
 - Replacing parking-light bulb, 127
 - Replacing rear light bulb, 128
 - Replacing rear turn indicator bulb, 128
 - Technical data, 155
 - Warning, bulb failure, 30, 31
- C**
- Case
 - Operation, 101
 - Checklist, 82
 - Clock, 24
 - Adjusting, 51
 - Control, 20

- Clutch
 - Adjusting clutch lever, 67
 - Checking fluid level, 115
 - Fluid reservoir, 13
 - Technical data, 150
- Confirmation of maintenance work, 162
- Cruise-control system
 - Control, 14
 - Operation, 64
 - Telltale light, 26
- Currency, 7
- D**
- Damping
 - Adjuster, rear, 11
 - Adjusting, 69
- Dimensions
 - Technical data, 156
- E**
- Electrics
 - Technical data, 154
- Emergency off switch (kill switch), 16, 60
- Engine
 - Control, 16
 - Starting, 82
 - Technical data, 147
 - Temperature gauge, 24
 - Warning, engine electronics, 29
- Engine oil
 - Checking fill level, 109
 - Filler neck, 13
 - Fill-level indicator, 11
 - Technical data, 149
 - Temperature gauge, 24
 - Topping up, 110
 - Warning, engine oil level, 34
 - Warning, engine oil pressure, 30
- Equipment, 7
- ESA
 - Control, 14
 - Engineering details, 97
 - Operation, 70
- F**
- Frame
 - Technical data, 155
- Front-wheel stand
 - Installing, 124
- Fuel
 - Filler neck, 13
 - Fill-level indicator, 24
 - Refuelling, 87
 - Technical data, 148
 - Warning, fuel down to reserve, 29
- Fuses, 154
- G**
- Gear indicator, 24
- General views
 - Headlight, 21
 - Left handlebar fitting, 14
 - Left side of motorcycle, 11
 - Multifunction display, 24
 - Right handlebar fitting, 16
 - Right side of motorcycle, 13
 - Underneath the seat, 19
- Grip heating, 60
 - Control, 16

- H**
- Handlebar fittings
 - General view, left side, 14
 - General view, right side, 16
- Hazard warning flashers
 - Control, 14
 - Operation, 59
- Headlight
 - Beam throw, 73
 - Driving on right/driving on left, 73
 - Headlight beam-throw adjustment, 11
 - Overview, 21
- Helmet holder, 19, 76
- High-beam headlight
 - Switching on, 58
 - Telltale light, 24
- Horn, 14
- I**
- Idle
 - Telltale light, 24
- Ignition
 - Switching off, 49
 - Switching on, 49
- Immobiliser, 50
 - Warning, 29
- Instrument cluster
 - Ambient-light brightness sensor, 20
 - Overview, 20
- J**
- Jump starting, 133
- K**
- Keys, 49
- L**
- Lights
 - Control, 14
 - Headlight flasher, 14, 58
 - High-beam headlight, 14
 - Parking light, 58
 - Switch on the high-beam headlight, 58
 - Switching on low-beam headlight, 58
 - Switching on the side lights, 58
- Low-beam headlight
 - Switching on, 58
- Lowered suspension
 - Restrictions, 80
- M**
- Maintenance
 - General instructions, 108
- Maintenance intervals, 161
- Mirrors
 - Adjusting, 68
- Mobility services, 160
- Motorcycle
 - Laying up, 142
 - Restoring to use, 142
- Multifunction display, 20
 - Adjust the dimmer, 53
 - Overview, 24
- O**
- Odometer and tripmeters, 24
 - Control, 14, 20
 - Operation, 51
- On-board computer
 - Ambient temperature, 54
 - Average consumption, 56
 - Average speed, 55
 - Control, 14

Oil level, 56
Operation, 54
Range, 55
Status indicators, 25
Warnings, 31

P

Parking, 86
Parking light, 58
Power socket, 11
 Notes on use, 100
Pre-ride check, 83

R

Rear-wheel drive
 Technical data, 151
Refuelling, 87
Reserve volume
 Warning, 29
Residual range, 52
Rev. counter, 20
Rider's Manual
 Stowage, 19
Running gear
 Technical data, 151
Running in, 84

S

Safety instructions
 Brakes, 85
 General, 80
Seat
 Adjusting seat height, 19, 64
 Installation, 74
 Lock, 13
 Removal, 74
Seat heating, 61
 Control, 13, 16
Service, 24, 160
Shift lever
 Adjusting, 68
Side light
 Switching on, 58
Spark plugs
 Technical data, 154
Speedometer, 20
Spring preload
 Adjuster, rear, 19
 Adjusting, 68
Starting, 82

Status indicators
 See also warnings, 24
 Standard status indicators, 24
 Warnings, 27
 With on-board computer, 25
 With RDC, 26
Steering lock, 49
Stowage compartment, 13, 67

T

Technical data
 Brakes, 153
 Bulbs, 155
 Clutch, 150
 Dimensions, 156
 Electrics, 154
 Engine, 147
 Engine oil, 149
 Frame, 155
 Fuel, 148
 Rear-wheel drive, 151
 Running gear, 151
 Spark plugs, 154
 Standards, 7
 Transmission, 150

- Weights, 157
- Wheels and tyres, 153
- Telltale lights, 20
 - Overview, 24
- Toolkit
 - Contents, 108
 - Stowage, 19
- Topcase
 - Closing, 103
 - Installing, 104
 - Opening, 103
 - Operation, 103
 - Removing, 104
- Torques, 145
- Transmission
 - Technical data, 150
- Transportation
 - Lashing, 88
- Troubleshooting chart, 144
- Turn indicators
 - Control, 14
 - Installation, 133
 - Operation, 58
 - Removal, 132
 - Telltale light, 24

- Tyre pressure monitoring RDC
 - Adhesive label for rim, 117
 - Operation, 57
 - Status indicators, 26
 - Warnings, 38
- Tyres
 - Checking inflation pressure, 72
 - Checking tread depth, 116
 - Recommendation, 117
 - Running in, 85
 - Table of tyre pressures, 19
 - Technical data, 153

V

- Vehicle identification number, 11

W

- Warnings, 27
 - DWA, 43
 - With ABS, 34
 - With ASC, 36
 - With on-board computer, 31
 - With RDC, 38
- Warnings, overview, 28, 33, 35, 37, 40, 44

- Weights
 - Payload table, 19
 - Technical data, 157
- Wheels
 - Change of size, 117
 - Checking rims, 116
 - Install the rear wheel, 122
 - Installing front wheel, 119
 - Remove the front wheel, 118
 - Removing rear wheel, 121
 - Technical data, 153
- Windscreen
 - Adjusting, 64
 - Control, 14