

Rider's Manual

F 650 GS



BMW Motorrad



The Ultimate
Riding Machine

<http://www.motorcycle.in.th>

Motorcycle data/dealership details

Motorcycle data

Model

Vehicle identification number

Colour code

Date of first registration

Registration number

Dealership details

Person to contact in Service department

Ms/Mr

Phone number

Dealership address/phone number (company stamp)

Welcome to BMW

We congratulate you on your choice of a motorcycle from BMW and welcome you to the community of BMW riders.

Familiarise yourself with your new motorcycle so that you can ride it safely and confidently in all traffic situations.

Please read this Rider's Manual carefully before starting to use your new BMW motorcycle. It contains important information on how to operate the controls and how to make the best possible use of all your BMW's technical features.

In addition, it contains information on maintenance and care to help you maintain your motorcycle's reliability and safety, as well as its value.

If you have questions concerning your motorcycle, your authorised

BMW Motorrad dealer will gladly provide advice and assistance.

We hope that you will enjoy riding your BMW and that all your journeys will be pleasant and safe.

BMW Motorrad.

Table of Contents

You can also consult the index at the end of this Rider's Manual if you want to find a particular topic or item of information.

1 General instructions 5

Overview 6

Abbreviations and symbols 6

Equipment 7

Technical data 7

Currency 7

2 General views 9

General view, left side 11

General view, right side 13

Underneath the seat 14

Underneath the trim panel 15

Multifunction switch, left 16

Multifunction switch, right 17

Instrument panel 18

3 Status indicators 21

Multifunction display 22

Meaning of symbols..... 23

Warning and telltale lights 24

Service-due indicator 25

Kilometres travelled after fuel down to reserve..... 25

Ambient temperature..... 26

Tyre pressures 26

Warnings 26

4 Operation..... 37

Ignition switch/steering lock 38

Electronic immobiliser EWS 39

Clock..... 39

Reading 40

Stopwatch..... 41

Lights 43

Turn indicators 44

Hazard warning flashers 44

Emergency off switch (kill switch) 45

Grip heating 45

BMW Motorrad ABS 46

Clutch 47

Brakes 47

Mirrors 48

Spring preload 49

Damping 50

Tyres..... 50

Headlight..... 51

Seat..... 52

Helmet holder 53

5 Riding..... 55

Safety instructions 56

Checklist 58

Starting..... 59

Running in 61

speed 61

Off-roading 62

Brakes 63

Parking your motorcycle 64

Refuelling 65

Securing motorcycle for transportation 66

6 Engineering details	69	Jump starting	111	Frame	132
Brake system with BMW		Battery	113	Dimensions	133
Motorrad ABS.....	70	9 Care	117	Weights	134
Tyre pressure monitoring		Care products.....	118	Riding specifications	134
RDC.....	72	Washing motorcycle.....	118	11 Service	135
7 Accessories	75	Cleaning easily damaged		BMW Motorrad Service ...	136
General instructions	76	components.....	118	BMW Motorrad Mobility	
Power sockets	76	Paint care	119	services	136
Luggage	77	Protective wax coating ...	120	Maintenance work.....	136
Cases	77	Laying up motorcycle	120	Confirmation of mainten-	
Topcase.....	80	Restoring motorcycle to		ance work	138
8 Maintenance	85	use	120	Confirmation of service....	143
General instructions	86	10 Technical data	121	12 Index	145
Toolkit.....	86	troubleshooting chart.....	122		
Engine oil	87	Threaded fasteners	123		
Brake system	88	Engine	125		
Coolant.....	92	Fuel	126		
Clutch.....	93	Engine oil	126		
Rims and tyres	94	Clutch.....	127		
Chain.....	95	Transmission	127		
Wheels	97	Rear-wheel drive	128		
Front-wheel stand.....	103	Running gear.....	128		
Bulbs.....	104	Brakes	129		
Body panels.....	109	Wheels and tyres.....	129		
Air filter.....	111	Electrics	131		

General instructions

Overview	6
Abbreviations and symbols	6
Equipment	7
Technical data	7
Currency	7

Overview

Chapter 2 of this Rider's Manual will provide you with an initial overview of your motorcycle. All maintenance and repair work on the motorcycle is documented in Chapter 11. This record of the maintenance work you have had performed on your motorcycle is a precondition for generous treatment of goodwill claims.

When the time comes to sell your BMW, please remember to hand over this Rider's Manual; it is an important part of the motorcycle.

Abbreviations and symbols



Indicates warnings that you must comply with for reasons of your safety and the safety of others, and to protect your motorcycle against damage.

 Specific instructions on how to operate, control, adjust or look after items of equipment on the motorcycle.

◀ Indicates the end of an item of information.

• Instruction.

» Result of an activity.

 Reference to a page with more detailed information.

◁ Indicates the end of a passage relating to specific accessories or items of equipment.



Tightening torque.



Item of technical data.

OE Optional extra
The motorcycles are assembled complete with all the BMW optional extras originally ordered.

OA Optional accessory
You can obtain optional accessories through your authorised BMW Motorrad dealer; optional accessories have to be retrofitted to the motorcycle.

EWS Electronic immobiliser.

DWA Anti-theft alarm (Diebstahlwarnanlage)

ABS Anti-lock brake system

RDC Tyre pressure monitoring (ReifenDruck-Control)

Equipment

When you ordered your BMW motorcycle, you chose various items of custom equipment. This Rider's Manual describes optional extras (OE) offered by BMW and selected optional accessories (OA). This explains why the manual may also contain descriptions of equipment which you have not ordered. Please note, too, that your motorcycle might not be exactly as illustrated in this manual on account of country-specific differences. If your BMW was supplied with equipment not described in this Rider's Manual, you will find these features described in separate manuals.

Technical data

All dimensions, weights and power ratings stated in the Rider's Manual are quoted to the standards and comply with the tolerance requirements of the Deutsches Institut für Normung e.V. (DIN). Versions for individual countries may differ.

Currency

The high safety and quality standards of BMW motorcycles are maintained by constant development work on designs, equipment and accessories. Because of this, your motorcycle may differ from the information supplied in the Rider's Manual. Nor can BMW Motorrad entirely rule out errors and omissions. We hope you will appreciate that no claims can be entertained on the basis of the data, illustrations or descriptions in this manual.

General views

General view, left side	11
General view, right side	13
Underneath the seat	14
Underneath the trim panel	15
Multifunction switch, left	16
Multifunction switch, right	17
Instrument panel	18



General view, left side

- 1 Power socket (→ 76)
- 2 Seat lock (→ 52)
- 3 Engine-oil filler neck and oil dipstick (→ 87)



General view, right side

- 1 Fuel filler neck (➡ 65)
- 2 Brake-fluid reservoir, rear (➡ 91)
- 3 VIN, type plate (on steering-head bearing)
- 4 Brake-fluid reservoir, front (➡ 90)
- 5 Coolant level indicator (behind side panel) (➡ 92)
- 6 Adjuster, spring preload (➡ 49)
- 7 Adjuster for damping characteristic (➡ 50)

Underneath the seat

- 1 Stowage
– with first-aid kit ^{OA}
Location of the first-aid kit
- 2 Standard toolkit (➔ 86)
- 3 Payload table
- 4 Table of tyre pressures
- 5 Helmet holder (➔ 53)
- 6 Rider's Manual
- 7 Tool for adjusting spring preload (➔ 49)

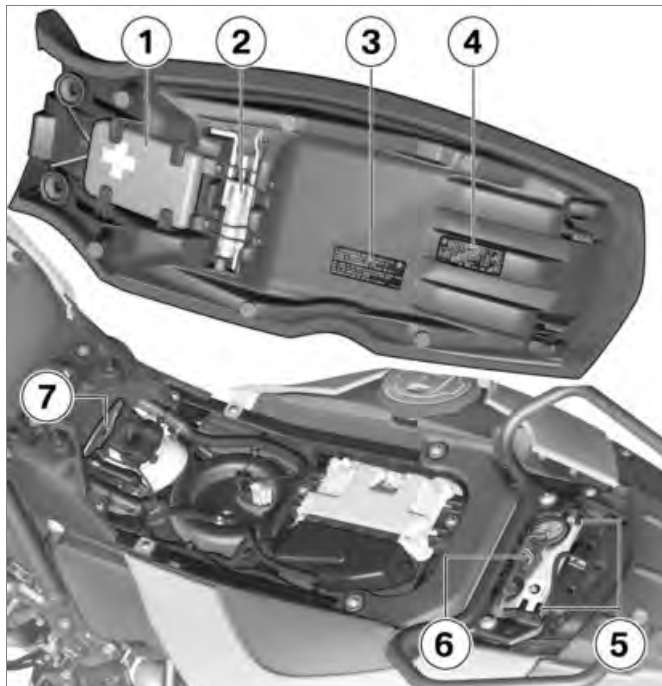

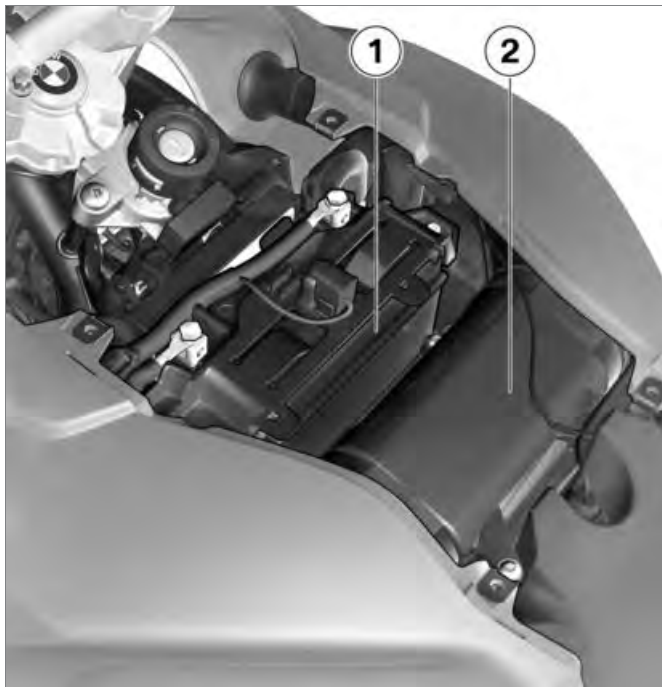

Underneath the trim panel

- 1 Battery (➔ 113)
- 2 Air-filter housing (➔ 111)

Multifunction switch, left

- 1 Selecting reading in extended area (→ 40)
- 2 – with BMW Motorrad ABS^{OE}
Operating the ABS (→ 46)
- 3 Horn
- 4 Flashing turn indicators, left (→ 44)
Hazard warning flashers (→ 44)
- 5 High-beam headlight and headlight flasher (→ 43)

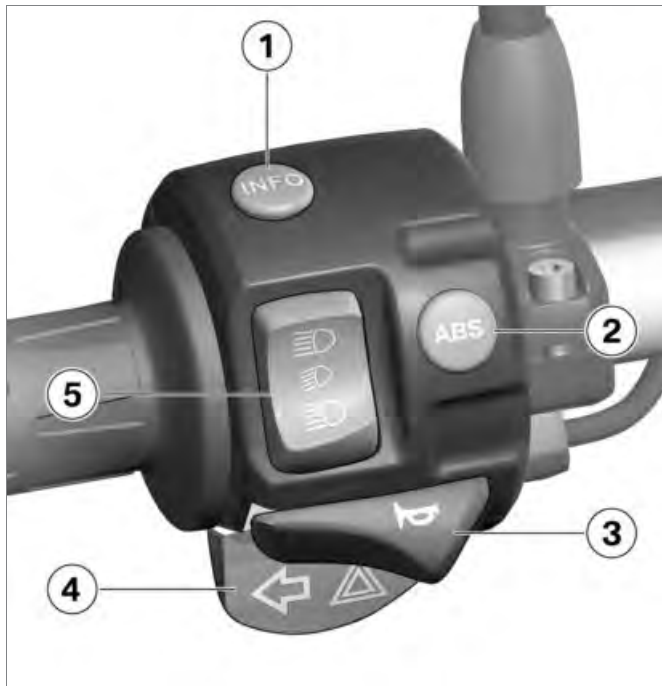

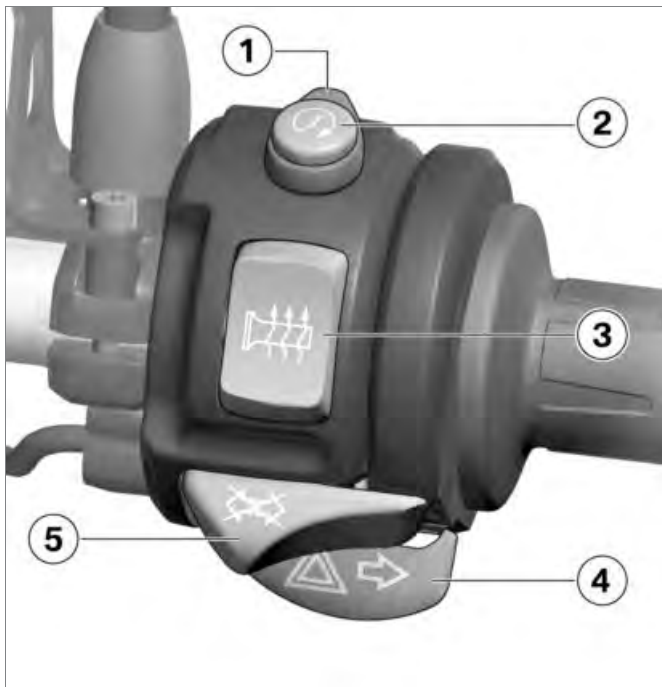

Multifunction switch, right

- 1 Emergency off switch (kill switch) (→ 45)
- 2 Starter button (→ 59)
- 3 – with heated handlebar grips^{OE}
Grip heating control (→ 45)
- 4 Flashing turn indicators, right (→ 44)
Hazard warning flashers (→ 44)
- 5 Cancel button, flashing turn indicators (→ 44)
Pushbutton, cancel hazard warning flashers (→ 44)

Instrument panel

- 1 Warning and telltale lights (➡ 24)
- 2 Speedometer
- 3 Setting clock (➡ 39).
– with on-board computer^{OE}
Operation of the stopwatch (➡ 41)
- 4 Multifunction display (➡ 22)
- 5 Select the readings (➡ 40).
Reset the tripmeter (➡ 41).



- 6** Ambient-light brightness sensor (for adapting the brightness of the instrument lighting)
- with anti-theft alarm^{OE}
- Anti-theft alarm telltale light (see the instructions for use for the anti-theft alarm)
- with on-board computer^{OE}
- Redline warning ( 62)
- 7** Rev. counter

Status indicators

Multifunction display	22
Meaning of symbols	23
Warning and telltale lights.....	24
Service-due indicator	25
Kilometres travelled after fuel down to reserve	25
Ambient temperature	26
Tyre pressures.....	26
Warnings	26

Multifunction display

- 1 Trip meter (➡ 40)
- 2 Warning for engine electronics (➡ 31)
- 3 – with on-board computer^{OE}
Stopwatch (➡ 41)
- 4 Time (➡ 39)
- 5 – with tyre pressure monitoring (RDC)^{OE}
Tyre pressures (➡ 26)
- 6 Warning for coolant temperature (➡ 30)
- 7 Service due (➡ 25)
- 8 Values area (➡ 40)
- 9 – with on-board computer^{OE}
Symbols explaining the readings shown in the values area (➡ 23)
- 10 – with on-board computer (OE)
The horizontal bars indicate the level of the coolant temperature.

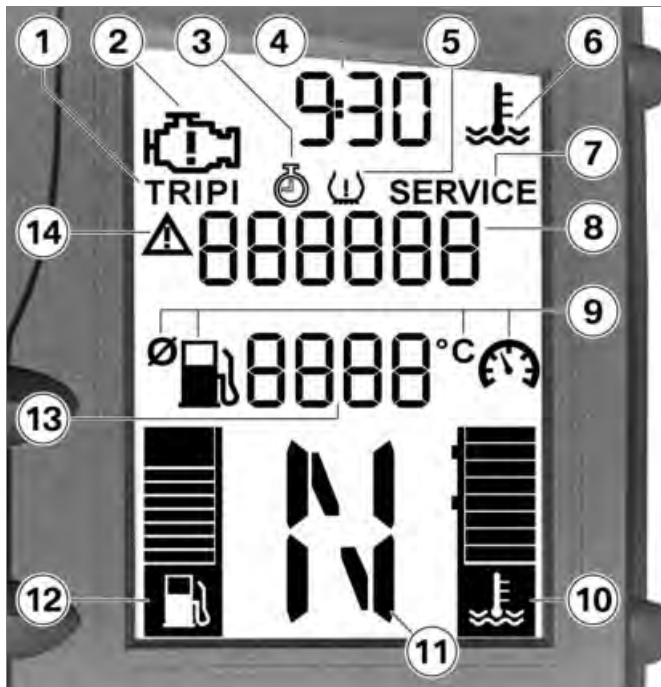

11 – with on-board computer (OE)

Gear indicator; "N" indicates neutral

12 – with on-board computer (OE)

Fuel level

The horizontal bars above the fuel-pump symbol indicate the remaining quantity of fuel. The top bar is larger than the others and the quantity of fuel it represents is significantly larger.

13 – with on-board computer (OE)

Values area (⇒ 40)

14 a warning is shown in the values area (⇒ 26)

Meaning of symbols

– with on-board computer^{OE}



distance travelled after fuel down to reserve in km (⇒ 25)



Average consumption in l/100 km



Average speed in km/h



Current consumption in l/100 km



Ambient temperature in °C (⇒ 26)◁

Warning and telltale lights

- 1 Oil-pressure warning light (➡ 31)
- 2 – with BMW Motorrad ABS^{OE}
- 3 ABS warning light (➡ 33)
- 4 Warning light for fuel down to reserve (➡ 30)
- 5 General warning light, in combination with warnings in the display (➡ 26)
- 6 High-beam headlight telltale light
- 7 Telltale light for right turn indicators
- 8 Telltale light for left turn indicators

▶ The ABS symbol might differ, depending on the specifics of national regulations.◀



Service-due indicator



If the next service is due in less than one month, the date for the next service **1** is shown briefly after the Pre-Ride Check completes. The month is shown as a two-digit number and the year as a four-digit number, with a colon as separator, so in this example the next service is due in March 2011.



If the motorcycle covers long distances in the course of the year, under certain circumstances it might be necessary to have it serviced at a date in advance of the forecast due date. If the countdown distance to the odometer reading at which a service will be due is less than 1000 km, the distance is counted down in steps of 100 km **2** and is shown briefly after the Pre-Ride Check completes.



If service is overdue, the due date or the odometer reading at which service was due

is accompanied by the 'General' warning light showing yellow. The word "Service" remains permanently visible.



If the service-due indicator appears more than a month before the service date, the date saved in the instrument cluster must be adjusted. This situation can occur if the battery was disconnected for a prolonged period of time.

If you want to have the date set consult a specialist workshop, preferably an authorised BMW Motorrad dealer. ◀

Kilometres travelled after fuel down to reserve

– with on-board computer^{OE}



Once the fuel has dropped to the reserve level, the reading shows the kilometres

travelled since then. This counter is reset as soon as refuelling brings the total quantity of fuel on board back above the reserve level.

Ambient temperature

– with on-board computer^{OE}

 When the motorcycle is at a standstill the heat of the engine can falsify the ambient-temperature reading. If the effect of the engine's heat becomes excessive, -- temporarily appears on the display.

If ambient temperature drops below 3 °C the temperature display flashes to draw your attention to the risk of black ice forming. The display automatically switches from any other mode to the temperature reading when the temperature drops below this threshold for the first time.<

Tyre pressures

– with tyre pressure monitoring (RDC)^{OE}



The tyre-pressure readings are based on a reference tyre temperature of 20 °C. The front tyre pressure is on the left **1**; the reading on the right **2** is the rear tyre pressure. "-- --" appears directly after the ignition is switched on, because the sensors do not transmit tyre pressures until the first time the motorcycle accelerates to more than 30 km/h.<



If warning triangle **3** also shows, the reading is a warning. The critical pressure flashes.

If the critical value is close to the limit of the permissible tolerance range, the 'General' warning light shows yellow. If the tyre pressure registered by the sensor is outside the permissible tolerance range, the 'General' warning light flashes red.

The detailed description of BMW Motorrad RDC starts on page (➔ 72).

Warnings

Mode of presentation

Warnings are indicated by the corresponding warning lights.

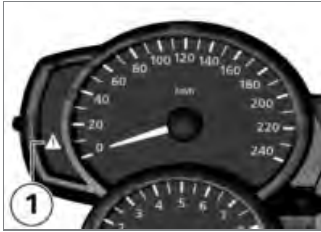

Warnings that do not have warning lights of their own are indicated by 'General' warning light **1** showing in combination with a text warning or a warning symbol in the multifunction display. The 'General' warning light shows red or yellow, depending on the urgency of the warning.



A reading in values area **2** that constitutes a warning is accompanied by warning triangle **3**. These warnings can alternate with the odometer readings (➡ 40).

The status of the 'General' warning light matches the most urgent warning.













The possible warnings are listed on the next page.





















Warnings, overview

Warning light

Status indicators

Meaning

	Lights up yellow	 + "EWS" appears on the display	Electronic immobiliser active (➡ 30)
	Lights up		Fuel down to reserve (➡ 30)
	Lights up red	 Flashes	Coolant temperature too high (➡ 30)
	Lights up yellow	 Appears on the display	Engine in emergency-operation mode (➡ 31)
	Flashes		Insufficient engine oil pressure (➡ 31)
	Lights up yellow	 + "LAMP" appears on the display	Bulb defective (➡ 31)
		"x . x °C" flashes	Ice warning (➡ 32)
	Lights up yellow	 + "dWA" appears on the display	Anti-theft alarm battery flat (➡ 32)

Warning light	Status indicators	Meaning
 Flashes		ABS self-diagnosis not completed ( 33)
 Lights up		ABS deactivated ( 33)
 Lights up		ABS fault ( 33)
 Lights up yellow	 + "x . x" flashes	Tyre pressure close to limit of permitted tolerance ( 33)
 Flashes red	 + "x . x" flashes	Tyre pressure outside permitted tolerance ( 34)
	 + "--" or "-- --" appears on the display.	Signal transmission disrupted ( 34)
 Lights up yellow	 + "--" or "-- --" appears on the display.	Sensor defective or system error ( 35)
 Lights up yellow	 + "RdC" appears on the display.	Battery of tyre-pressure sensor weak ( 35)

Electronic immobiliser active



General warning light shows yellow.



+ "EWS" appears on the display.

Possible cause:

The key being used is not authorised for starting, or communication between key and engine electronics is disrupted.

- Remove all other vehicle keys from the same ring as the ignition key.
- Use the reserve key.
- Have the defective key replaced, preferably by an authorised BMW Motorrad dealer.

Fuel down to reserve



Warning light for fuel down to reserve shows.



Lack of fuel can result in the engine misfiring and cutting out unexpectedly. Misfiring can damage the catalytic converter; a hazardous situation can result if the engine cuts out unexpectedly.

Do not run the fuel tank dry. ◀

Possible cause:

The fuel tank contains no more than the reserve quantity of fuel.



Reserve fuel

– approx. 4 l

- Refuelling (➡ 65).

Coolant temperature too high



General warning light shows red.



The temperature symbol flashes.



Continuing to ride when the engine is overheated could result in engine damage.

Compliance with the information set out below is essential. ◀

Possible cause:

If the coolant level is too low.

- Check the coolant level (➡ 92).

If the coolant level is too low:

- Topping up coolant (➡ 93).

Possible cause:

The coolant temperature is too high.

- If possible, ride in the part-load range to cool down the engine.
- In traffic jams, switch off the engine, but leave the ignition switched on so that the radiator fan continues to operate.
- If the coolant temperature is frequently too high, have the fault rectified as soon as possible by a specialist workshop,

preferably an authorised BMW Motorrad dealer.

Engine in emergency-operation mode



General warning light shows yellow.



Engine symbol appears on the display.



The engine is running in emergency operating mode.

Unusual engine response is a possibility.

Adapt your style of riding accordingly. Avoid accelerating sharply and overtaking.◀

Possible cause:

The engine control unit has diagnosed a fault. In exceptional cases, the engine stops and refuses to start. Otherwise, the engine runs in emergency operating mode.

- You can continue to ride, but bear in mind that the usual en-

gine power might not be available.

- Have the fault rectified as quickly as possible by a specialist workshop, preferably an authorised BMW Motorrad dealer.

Insufficient engine oil pressure



Warning light for engine-oil pressure flashes.

The oil pressure in the lube-oil system is too low. Stop immediately and switch off the engine.



The insufficient oil pressure warning does not fulfil the function of an oil gauge. The only way of checking whether the oil level is correct is to check with the oil dipstick.◀

Possible cause:

The engine-oil level is too low.

- Check the engine oil level (➡ 87).

If the oil level is too low:

- Top up the engine oil (➡ 88).

Possible cause:

The engine-oil pressure is insufficient.



Riding when engine-oil pressure is low can result in engine damage.

Do not continue your journey.◀

- Have the fault rectified as quickly as possible by a specialist workshop, preferably an authorised BMW Motorrad dealer.

Bulb defective



General warning light shows yellow.



+ "LAMP" appears on the display.



A defective bulb places your safety at risk because it is easier for other users to oversee the motorcycle. Replace defective bulbs as soon as possible; always carry a complete set of spare bulbs if possible. ◀

Possible cause:

Bulb defective.

- Visually inspect to ascertain which bulb is defective.
- Replacing low-beam and high-beam headlight bulb (➡ 104).
- Replacing parking-light bulb (➡ 105).
- Replacing brake light and rear light bulb (➡ 107).
- Replacing turn indicator bulbs, front and rear (➡ 107).

Ice warning

– with on-board computer^{OE}

"x . x °C" (ambient temperature) flashes.

Possible cause:

The air temperature measured at the motorcycle is lower than 3 °C.



The ice warning does not mean that there is no risk of black ice forming at measured temperatures above 3 °C. Always take extra care when temperatures are low; remember that the danger of black ice forming is particularly high on bridges and where the road is in shade. ◀

- Ride carefully and think well ahead.

Anti-theft alarm battery flat

– with anti-theft alarm^{OE}



General warning light shows yellow.



+ "dWA" appears on the display.



This error message appears only briefly after the pre-ride check completes. ◀

Possible cause:

The integral battery in the anti-theft alarm has lost its entire original capacity. There is no assurance that the anti-theft alarm will be operational if the motorcycle's battery is disconnected.

- Seek the advice of a specialist workshop, preferably an authorised BMW Motorrad dealer.

ABS self-diagnosis not completed

– with BMW Motorrad ABS^{OE}



ABS warning light flashes.

Possible cause:

The ABS function is not available, because self-diagnosis did not complete. The motorcycle has to move forward a few metres for the wheel sensors to be tested.

- Pull away slowly. Bear in mind that the ABS function is not available until self-diagnosis has completed.

ABS deactivated

– with BMW Motorrad ABS^{OE}



ABS warning light shows.

Possible cause:

The rider has switched off the ABS system.

– with BMW Motorrad ABS^{OE}

- Activate the ABS function (➡ 47).

ABS fault

– with BMW Motorrad ABS^{OE}



ABS warning light shows.

Possible cause:

The ABS control unit has detected a fault. The ABS function is not available.

- You can continue to ride. Bear in mind that the ABS function is not available. Bear in mind the more detailed information on situations that can lead to an ABS fault (➡ 71).
- Have the fault rectified as quickly as possible by a specialist workshop, preferably

an authorised BMW Motorrad dealer.

Tyre pressure close to limit of permitted tolerance

– with tyre pressure monitoring (RDC)^{OE}



General warning light shows yellow.



+ "x . x" (critical pressure) flashes.

Possible cause:

Measured tyre pressure is close to the limit of permitted tolerance.

- Correct the tyre pressure as stated on the inside cover of the Rider's Manual.



Before you adjust tyre pressure, read the information on temperature compensation and adjusting pressure in the

section entitled "Engineering details". ◀

Tyre pressure outside permitted tolerance

– with tyre pressure monitoring (RDC)^{OE}



General warning light flashes red.



+ "x . x" (critical pressure) flashes.

Possible cause:

Measured tyre pressure is outside permitted tolerance.

- Check the tyre for damage and to ascertain whether the motorcycle can be ridden with the tyre in its present condition.

If the motorcycle can be ridden with the tyre in its present condition:



Incorrect tyre pressures impair the motorcycle's handling characteristics.

If tyre pressure is incorrect it is essential to adapt your style of riding accordingly. ◀

- Correct the tyre pressure at the earliest possible opportunity.
- Have the tyre checked for damage by a specialist workshop, preferably an authorised BMW Motorrad dealer.

If you are unsure whether the motorcycle can be ridden with the tyre in its present condition:

- Do not continue your journey.
- Notify the breakdown service.
- Have the tyre checked for damage by a specialist workshop, preferably an authorised BMW Motorrad dealer.

Signal transmission disrupted

– with tyre pressure monitoring (RDC)^{OE}



+ "---" or "-- --" appears on the display.

Possible cause:

The motorcycle has not yet accelerated past the threshold of approximately 30 km/h. The RDC sensors do not start transmitting signals until the motorcycle reaches a speed above this threshold (➡ 72).

- Increase speed above this threshold and observe the RDC readings. Assume that a permanent fault has not occurred unless the 'General' warning light comes on to accompany the symptoms. Under these circumstances:
- Have the fault rectified by a specialist workshop, preferably

an authorised BMW Motorrad dealer.

Possible cause:

Wireless communication with the RDC sensors has been disrupted. Possible causes include radio-communication systems operating in the vicinity and interfering with the link between the RDC control unit and the sensors.

- Move to another location and observe the RDC readings. Assume that a permanent fault has not occurred unless the 'General' warning light comes on to accompany the symptoms. Under these circumstances:
- Have the fault rectified by a specialist workshop, preferably an authorised BMW Motorrad dealer.

Sensor defective or system error

- with tyre pressure monitoring (RDC)^{OE}



General warning light shows yellow.



+ "---" or "--- ---" appears on the display.

Possible cause:

Motorcycle is fitted with wheels not equipped with RDC sensors.

- Fit wheels and tyres equipped with RDC sensors.

Possible cause:

One or two RDC sensors have failed.

- Have the fault rectified by a specialist workshop, preferably an authorised BMW Motorrad dealer.

Possible cause:

A system error has occurred.

- Have the fault rectified by a specialist workshop, preferably an authorised BMW Motorrad dealer.

Battery of tyre-pressure sensor weak

- with tyre pressure monitoring (RDC)^{OE}



General warning light shows yellow.



+ "RdC" appears on the display.

 This error message appears only briefly after the pre-ride check completes. ◀

Possible cause:

The integral battery in the tyre-pressure sensor has lost a significant proportion of its original capacity. There is no assurance of how long the tyre pressure

control system can remain operational.

- Seek the advice of a specialist workshop, preferably an authorised BMW Motorrad dealer.

Operation

Ignition switch/steering lock	38	Spring preload	49
Electronic immobiliser EWS.....	39	Damping	50
Clock	39	Tyres	50
Reading.....	40	Headlight	51
Stopwatch	41	Seat	52
Lights.....	43	Helmet holder	53
Turn indicators.....	44		
Hazard warning flashers.....	44		
Emergency off switch (kill switch).....	45		
Grip heating.....	45		
BMW Motorrad ABS.....	46		
Clutch	47		
Brakes	47		
Mirrors.....	48		

Ignition switch/steering lock

Keys

You receive two master keys and one emergency key. The emergency key is small and light so that it can always be kept in a wallet or purse, for example. It is designed for occasional use, for example when no master key is available; it is not intended for constant use.

Please consult the information on the electronic immobiliser (EWS) if a key is lost or mislaid (►► 39). Ignition switch/steering lock, tank filler cap lock and seat lock are all operated with the same key.

- with cases^{OE}
- with topcase^{OA}

If you wish you can arrange to have the cases and the topcase fitted with locks that can be opened with this key as well.

Consult a specialist workshop, preferably an authorised BMW Motorrad dealer.◁

Switching on ignition

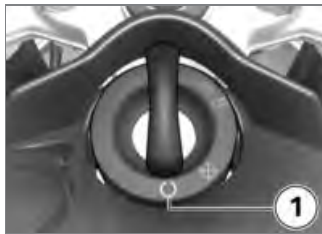

- Turn the key to position **1**.
 - » Parking lights and all function circuits switched on.
 - » Engine can be started.
 - » Pre-ride check is performed. (►► 60)
- with BMW Motorrad ABS^{OE}
 - » ABS self-diagnosis is performed. (►► 60)

Switch off the ignition



- Turn the key to position **2**.
 - » Lights switched off.
 - » Handlebars not locked.
 - » Key can be removed.
 - » Electrically powered accessories remain operational for a limited period of time.
 - » The battery can be recharged via the on-board socket.

Locking handlebars

- Turn the handlebars all the way to left



as "authorised" for your motorcycle.

 A spare key attached to the same ring as the ignition key used to start the engine could "irritate" the electronics, in which case the enabling signal for starting is not issued. The EWS warning appears in the multifunction display.

Always keep the spare key separately from the ignition key. ◀

If you mislay a key you can have the key in question barred by your authorised BMW Motorrad dealer. In order to have a key barred you must bring along all the other keys belonging to the motorcycle.

The engine cannot be started by a barred key, but a key that has been barred can subsequently be reactivated.

You can obtain replacement/extra keys only through an authorised

BMW Motorrad dealer. The keys are part of an integrated security system, so the dealer is under an obligation to check the legitimacy of all applications for replacement/extra keys.

Clock

Setting clock

 Attempting to set the clock while riding the motorcycle can lead to accidents.

Set the clock only when the motorcycle is stationary. ◀

- Switch on the ignition.

- Turn the key to position **3**, while moving the handlebars slightly.
- » Ignition, lights and all function circuits switched off.
- » Handlebars locked.
- » Key can be removed.

Electronic immobiliser EWS

The on-board electronics access the data saved in the ignition key via a ring aerial in the ignition lock. The ignition is not enabled for starting until the engine control unit has recognised the key



- Press and hold down button **1** until the hours number **3** flashes.
- Repeatedly press the button until the hours number is correct.
- Press and hold down the button until the minutes number **4** flashes.
- Repeatedly press the button until the minutes number is correct.
- Hold down the button until the minutes number stops flashing.
- » This completes the process.

Reading

Selecting readings

- Switch on the ignition.



- Press button **2** to select the reading in values area **3**.
The following values can be displayed:

- Total kilometres (shown)
- Tripmeter 1 (Trip I)
- Tripmeter 2 (Trip II)

- with tyre pressure monitoring (RDC)^{OE}



Tyre pressures

- Warnings, if applicable
- with on-board computer^{OE}



- Press button **4** to select the reading in values area **5**.
The following values can be displayed:

- Ambient temperature (°C)



Average speed in km/h



Average consumption in l / 100 km



Current consumption in l / 100 km



distance travelled after fuel down to reserve in km

Resetting tripmeter

- Switch on the ignition.
- Select the desired tripmeter.



- Press and hold down button **2** until the tripmeter reading is reset.

Resetting average values

– with on-board computer^{OE}

- Switch on the ignition.
- Select average consumption or average speed.



- Press and hold down button **1** until the value shown is reset.

Stopwatch

– with on-board computer^{OE}

Stopwatch



You can switch from the odometer reading to a stopwatch **3**. The readout is in hours, minutes, seconds and tenths of a second, with dots as separators.

By swapping the functions of button **2** and the INFO button on the handlebar fitting you can make the stopwatch easier to use (as a lap timer) as you ride. If you swap the functions in this way the stopwatch and the odometer are operated by means of the INFO button and you must

use button **2** to operate the on-board computer.

The stopwatch continues to time in the background if you switch back temporarily to the odometer reading. Similarly, the stopwatch continues timing if you temporarily switch off the ignition.

Operating stopwatch



- If necessary, use button **1** to switch from the odometer to the stopwatch.

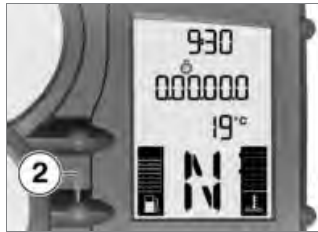

- When the stopwatch is stopped, press button **2** to start timing with the stopwatch.
- When the stopwatch is running, press button **2** to stop timing with the stopwatch.
- Press and hold down button **2** to reset the stopwatch.

Changing button functions

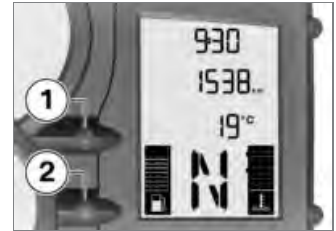

- Press button **1** and button **2** at the same time and hold them down until the reading changes.
 - » FLASH (redline warning) appears, along with ON or OFF.
- Press button **2**.
 - » LAP (Lap-Timer) and ON or OFF appear.
- Repeatedly press button **1** until the reading shows the mode you want.

- » ON: Stopwatch operated by means of the INFO button on the handlebar fitting.
- » OFF: Stopwatch operated by means of button **2** in the instrument panel.
- To save the setting, press button **1** and button **2** at the same time and hold them down until the reading changes.

Lights

Side light

The side lights switch on automatically when the ignition is switched on.

- ▶ The side lights place a strain on the battery. Do not switch the ignition on for longer than absolutely necessary.◀

Low-beam headlight

The low-beam headlight switches on automatically when you start the engine.

- ▶ When the engine is not running you can switch on the lights by switching on the ignition and either switching on the high-beam headlight or operating the headlight flasher.◀

High-beam headlight and headlight flasher



- Press top section of switch **1** to switch on the high-beam headlight.

- Centre switch **1** to switch off the high-beam headlight.
- Press bottom section of switch **1** to operate the headlight flasher.◀

Parking light

- Switch off the ignition.



- Immediately after switching off the ignition, push button **1** and hold it in this position until the parking lights come on.
- Switch the ignition on and off again to switch off the parking lights.◀

Turn indicators

Operating flashing turn indicators

- Switch on the ignition.

▶ The turn indicators are cancelled automatically after you have ridden for approximately 10 seconds and covered a distance of about 300 m.◀



- Press button **1** to switch on the left flashing turn indicator.



- Press button **2** to switch on the right flashing turn indicator.



- Press button **3** to switch off the flashing turn indicators.◀

Hazard warning flashers

Operating hazard warning flashers

- Switch on the ignition.

▶ The hazard warning flashers place a strain on the battery. Do not use the hazard warning flashers for longer than absolutely necessary.◀

▶ If you press a turn-indicator button with the ignition switched on, the turn-indicator function is activated instead of the hazard warning flashers, and remains active until you release the button. The hazard warning flashers recommence flashing as soon as the button is released.◀

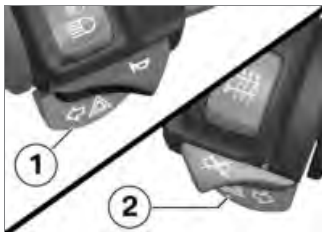

- Press buttons **1** and **2** at the same time to switch on the hazard warning flashers.
» Ignition can be switched off.

Emergency off switch (kill switch)



- 1** Emergency off switch (kill switch)

! Operating the kill switch when riding can cause the rear wheel to lock and thus cause a fall.
Do not operate the kill switch when riding. ◀

The emergency off switch is a kill switch for switching off the engine quickly and easily.



- Press button **3** to switch off the hazard warning flashers. ◀



- a** Normal operating position (run)
b Engine switched off.

Grip heating

– with heated handlebar grips^{OE}



1 Grip-heating switch

The handlebar grips have two-stage heating. Stage two is for heating the grips quickly: it is advisable to switch back to stage one as soon as the grips are warm. Grip heating can be activated only when the engine is running.

▶ The increase in power consumption caused by the grip heating can drain the battery if you are riding at low engine speeds. If the charge level is low, grip heating is switched

off to ensure the battery's starting capability. ◀

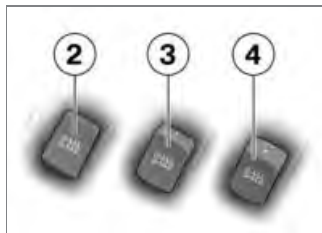

- 2** Heating off.
- 3** 50 % heat output (one dot visible)
- 4** 100 % heat output (three dots visible)

BMW Motorrad ABS

– with BMW Motorrad ABS^{OE}

Deactivating ABS function

- Bring the motorcycle to a stop or, if the motorcycle is at a standstill, switch on the ignition.



- Press and hold down button **1** until the ABS warning light changes status.



ABS warning light shows.

- Release button **1** within two seconds.



ABS warning light remains ON.

» The ABS function is deactivated. ◀

Activating ABS function



- Press and hold down button **1** until the ABS warning light changes status.

 ABS warning light goes out; if self-diagnosis has not completed it starts flashing.

- Release button **1** within two seconds.

 The ABS warning light remains off or continues to flash.

- » The ABS function is activated.
- You also have the option of switching the ignition off and then on again.

 If you switch the ignition off then on again and the ABS light comes back on, there is a fault in the ABS. ◀◀

Clutch

Adjusting clutch lever

 Attempting to adjust the clutch lever while riding the motorcycle can lead to accidents. Do not attempt to adjust the clutch lever unless the motorcycle is at a standstill. ◀

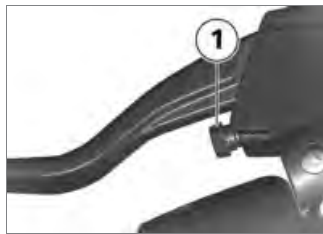

- Turn adjusting screw **1** clockwise to increase the span

between the clutch lever and the handlebar grip.

- Turn adjusting screw **1** counter-clockwise to reduce the span between the clutch lever and the handlebar grip.

 The adjusting screw is easier to turn if you push the clutch lever forward. ◀

Brakes

Adjust the handbrake lever

 Changing the position of the brake-fluid reservoir can allow air to penetrate the brake system.

Do not twist the handlebar fitting or the handlebars. ◀

 Attempting to adjust the handbrake lever while riding the motorcycle can lead to accidents.

Do not attempt to adjust the

handbrake lever unless the motorcycle is at a standstill. ◀

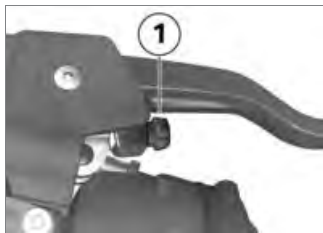

- Turn adjusting screw **1** clockwise to increase the span between the brake lever and the handlebar grip.
- Turn adjusting screw **1** counter-clockwise to reduce the span between the brake lever and the handlebar grip.

▷ The adjusting screw is easier to turn if you push the handbrake lever forward. ◀

Mirrors

Adjust the mirrors



- Turn the mirror to the correct position.

Adjusting mirror arm

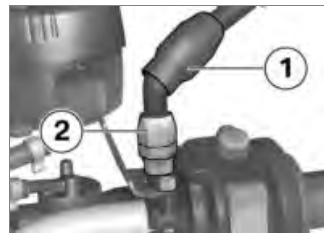

- Push protective cap **1** up over the threaded fastener on the mirror arm. ◀
- Slacken nut **2**.
- Turn the mirror arm to the appropriate position.
- Tighten the nut to the specified tightening torque, while holding the mirror arm to ensure that it does not move out of position.

 Locknut (mirror) to clamping piece

– 20 Nm

- Push the protective cap over the threaded fastener.

Spring preload

Setting

It is essential to set spring preload of the rear suspension to suit the load carried by the motorcycle. Increase spring preload when the motorcycle is heavily loaded and reduce spring preload accordingly when the motorcycle is lightly loaded.

Adjusting spring preload for rear wheel

- Remove the seat ( 52).



- Remove on-board toolkit **1**.



 Your motorcycle's handling will suffer if you do not match the spring-preload and damping-characteristic settings.

Adjust the damping characteristic to suit spring preload. ◀

- If you want to increase spring preload, use the tool from the on-board toolkit to turn knob **2** clockwise.
- If you want to reduce spring preload, use the tool from the on-board toolkit to turn knob **2** counter-clockwise.

 Basic setting of spring preload, rear

– Turn the adjusting screw counter-clockwise as far as it will go (Full load of fuel, with rider 85 kg)

– with lowered suspension^{OE}

– Turn adjusting screw as far as it will go counter-clockwise, then pretension the spring 5 clicks. (Full load of fuel, with rider 85 kg) ◀

- Stow the on-board toolkit in its correct position.

- Install the seat (➡ 53).

Damping Setting

Damping must be adapted to suit the surface on which the motorcycle is ridden and to suit spring preload.

- An uneven surface requires softer damping than a smooth surface.
- An increase in spring preload requires firmer damping, a reduction in spring preload requires softer damping.

Adjusting damping for rear wheel

- Make sure the ground is level and firm and place the motorcycle on its stand.



- You adjust the damping characteristic by turning adjusting screw **1**.

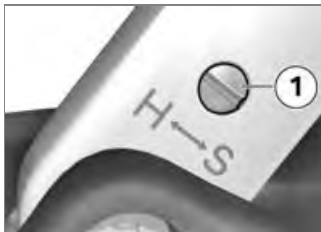

- If you want a harder damping characteristic, use a screwdriver to turn adjusting screw **1**

in the direction indicated by the H arrow.

- If you want a softer damping characteristic, use a screwdriver to turn adjusting screw **1** in the direction indicated by the S arrow.



Basic setting of rear-suspension damping characteristic

- Turn adjusting screw as far as it will go clockwise, then back it off 2 turns. (Full load of fuel, with rider 85 kg)

Tyres

Checking tyre pressure



Incorrect tyre pressures impair the motorcycle's handling characteristics and increase the rate of tyre wear.

Always check that the tyre pressures are correct.◀



At high road speeds, tyre valves installed perpendicular to the wheel rim have a tendency to open as a result of centrifugal force.

In order to avoid sudden deflation, fit valves installed perpendicular to the rim with valve caps complete with rubber seals and make sure the valve caps are screwed firmly on to the valves. ◀

- Make sure the ground is level and firm and place the motorcycle on its stand.
- Check tyre pressures against the data below.

	Tyre pressure, front
	– 2.2 bar (one-up, at tyre temperature 20 °C)
	– 2.4 bar (two-up and/or with luggage, at tyre temperature 20 °C)

	Tyre pressure, rear
	– 2.4 bar (one-up, at tyre temperature 20 °C)
	– 2.8 bar (two-up and/or with luggage, at tyre temperature 20 °C)

If tyre pressure is too low:

- Correct tyre pressure.

Headlight

Adjusting headlight for driving on left/driving on right

If the motorcycle is ridden in a country where the opposite rule of the road applies, its asymmetric low-beam headlight will tend to dazzle oncoming traffic.

Have the headlight set accordingly by a specialist workshop, preferably an authorised BMW Motorrad dealer.

Headlight beam throw and spring preload

Headlight beam throw is generally kept constant when spring preload is adjusted to suit load. Spring preload adjustment might not suffice only if the motorcycle is very heavily loaded. Under these circumstances, headlight beam throw has to be adjusted to suit the weight carried by the motorcycle.

▶ Consult a specialist workshop, preferably an authorised BMW Motorrad dealer, if you are unsure whether the headlight beam-throw setting is correct. ◀

Adjusting headlight beam throw



- Slacken screws **1** on left and right.
- Adjust beam throw by tilting the headlight slightly about its horizontal axis.
- Tighten screws **1** on left and right.

Beam-throw basic setting

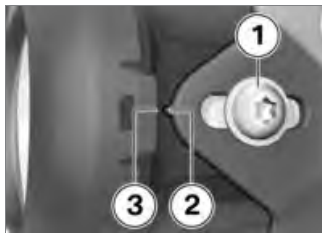

- Slacken screws **1** on left and right.
- Tilt the headlight slightly about its horizontal axis until arrowhead **2** is pointing toward marker **3**.
- Tighten screws **1** on left and right.

Seat

Removing seat

- Make sure the ground is level and firm and place the motorcycle on its stand.



- Turn the key to the left in seat lock **1** and hold it in this position while pressing down the front part of the seat.

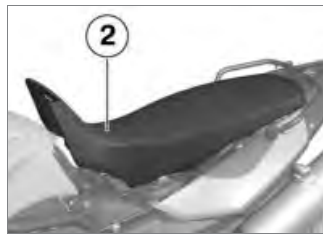

- Lift seat **2** at the front and release the key.

- Remove the seat and place it, rubber buffers down, on a clean surface.

Installing seat



- Engage the seat in holders **3**.
- Firmly press down on the seat at the front.
- » The seat engages with an audible click.

Helmet holder

Securing helmet to motorcycle

- Remove the seat (→ 52).



- Use a plastic-sheathed steel cable to secure the helmet to helmet holder **1** on left or right.



- ⚠ If it is attached on the left side of the motorcycle, there is a possibility of the hel-

met being damaged by the hot end silencer.

If possible, attach the helmet on the right-hand side of the motorcycle.◀



The helmet catch can scratch the panelling.

Make sure the lock is out of the way when you hook the helmet into position.◀

- Pass the steel cable through the helmet and the holder and position cable and helmet as shown here.
- Install the seat (→ 53).

Riding

Safety instructions	56
Checklist.....	58
Starting	59
Running in	61
speed.....	61
Off-roading	62
Brakes	63
Parking your motorcycle	64
Refuelling	65
Securing motorcycle for transportation	66

Safety instructions

Rider's equipment

Do not ride without the correct clothing. Always wear:

- Helmet
- Motorcycling jacket and trousers
- Gloves
- Boots

This applies even to short journeys, and to every season of the year. Your authorised BMW Motorrad dealer will be glad to advise you on the correct clothing for every purpose.

Restricted angle of heel

- with lowered suspension^{OE}

A motorcycle with lowered suspension has less ground clearance and cannot corner at angles of heel as extreme as those achievable by a counterpart motorcycle with

standard-height suspension (see the section entitled "Technical data").



Risk of accident by unexpectedly early contact with the ground.

Bear in mind that lowered suspension limits the motorcycle's angle of heel and ground clearance.◀

Test your motorcycle's angle of heel in situations that do not involve risk. When riding over kerbs and similar obstacles, bear in mind that your motorcycle's ground clearance is limited.

Lowering the motorcycle's suspension shortens suspension travel. Ride comfort might be restricted as a result. Be sure to adjust spring preload accordingly, particularly for riding two-up.

Correct loading



Overloading and imbalanced loads can adversely affect the motorcycle's handling. Do not exceed the permissible gross weight and be sure to comply with the instructions on loading.◀

- Set spring preload, damping characteristic and tyre pressures to suit total weight.
- with cases^{OE}
- Ensure that the case volumes on the left and right are equal.
- Make sure that the weight is uniformly distributed between right and left.
- Pack heavy items at the bottom of the cases and toward the inboard side.
- Note the maximum permissible payload and the speed limit for riding with cases fitted, as

stated on the label inside the case.◀

– with topcase^{OA}

- Note the maximum permissible payload and the speed limit for riding with topcase fitted, as stated on the label inside the topcase.◀

– with tank rucksack^{OA}

- Note the maximum permissible payload of the tank rucksack and the speed limit for riding with a tank rucksack on the motorcycle.

 Payload of tank rucksack

– max 5 kg

 Maximum permissible speed for riding with the tank rucksack fitted to the motorcycle

– max 130 km/h◀

– with rear softbag^{OA}

- Note the maximum permissible payload of the rear softbag and the speed limit for riding with a rear softbag on the motorcycle.

 Payload of rear softbag

– max 1.5 kg

 Maximum permissible speed for riding with the rear softbag fitted to the motorcycle

– max 130 km/h◀

Speed

If you ride at high speed, always bear in mind that various boundary conditions can adversely affect the handling of your motorcycle:

- Settings of the spring-strut and shock-absorber system
- Imbalanced load
- Loose clothing
- Insufficient tyre pressure
- Poor tyre tread
- Etc.

Risk of poisoning

Exhaust fumes contain carbon monoxide, which is colourless and odourless but highly toxic.



Inhaling the exhaust fumes therefore represents a health hazard and can even cause loss of consciousness with fatal consequences.

Do not inhale exhaust fumes. Do not run the engine in an enclosed space.◀

Risk of burn injury



Engine and exhaust system become very hot when the motorcycle is in use. There is a risk of burn injuries by contact with hot surfaces, particularly at the silencer.

When you park the motorcycle make sure that no-one comes into contact with the engine and exhaust system. ◀

Catalytic converter

If misfiring causes unburned fuel to enter the catalytic converter, there is a danger of overheating and damage.

For this reason, observe the following points:

- Do not run the fuel tank dry.
- Do not attempt to start or run the engine with a spark-plug cap disconnected.
- Stop the engine immediately if it misfires.

- Use only unleaded fuel.
- Comply with all specified maintenance intervals.



Unburned fuel will destroy the catalytic converter. Note the points listed for protection of the catalytic converter. ◀

Risk of overheating



Cooling would be inadequate if the engine were allowed to idle for a lengthy period with the motorcycle at a standstill: overheating would result. In extreme cases, the motorcycle could catch fire. Do not allow the engine to idle unnecessarily. Ride away immediately after starting the engine. ◀

Tampering



Tampering with motorcycle settings (e.g. electronic engine management unit, throttle valves, clutch) can cause

damages to the components in question and lead to failure of safety-relevant functions. Damage caused in this way is not covered by the warranty. Do not tamper with the motorcycle in any way that could result in tuned performance. ◀

Checklist

Use the following checklist to check important functions, settings and wear limits before you ride off.

- Brakes
- Brake-fluid levels, front and rear
- Clutch
- Damping-characteristic setting and spring preload
- Tyre-tread depth and tyre pressures
- Cases correctly installed and luggage secured

At regular intervals:

- Engine oil level (every refuelling stop)
- Brake-pad wear (every third refuelling stop)
- Tension and lubrication of the drive chain

Starting

Starting engine



- Kill switch in run position **a**.

! Gearbox lubrication is ensured only when the engine is running. Inadequate lubrication can result in damage to the gearbox.

Do not allow the motorcycle to

roll for a lengthy period of time or push it a long distance with the engine switched off. ◀

- Switch on the ignition.
 - » Pre-ride check is performed. (➡ 60)
- with BMW Motorrad ABS^{OE}
 - » ABS self-diagnosis is performed. (➡ 60)
- Select neutral or, if a gear is engaged, pull the clutch lever.

▷ You cannot start the motorcycle with the side stand extended and a gear engaged. The engine will switch itself off if you start it with the gearbox in neutral and then engage a gear before retracting the side stand. ◀

- When starting a cold engine at low ambient temperatures: disengage the clutch and turn the twistgrip slightly to open the throttle.



- Press starter button **1**.

▷ The start attempt is automatically interrupted if battery voltage is too low. Recharge the battery before you start the engine, or use jump leads and a donor battery to start. ◀

- » The engine starts.
- » If the engine refuses to start, consult the troubleshooting chart in the section entitled "Technical data". (➡ 122) ◀

Pre-ride check

The instrument panel runs a test of the instruments and the telltale and warning lights when the ignition is switched on: this is the Pre-Ride-Check. The test is aborted if you start the engine before it completes.

Phase 1

The rev. counter and speedometer needles both swing to the limit values on their scales. At the same time, all the warning lights and telltale lights are switched on in succession.

Phase 2

» The 'General' warning light changes from yellow to red.

Phase 3

The rev. counter and speedometer needles both swing back to rest. At the same time, all the warning lights and telltale lights switched on in the initial phase

are switched off in reverse sequence.

If a needle did not move or if a warning light or telltale light did not show:



Some malfunctions cannot be indicated if one of the warning lights fails to show.

Make sure that all the warning and telltale lights come on in the pre-ride check. ◀

- Have the fault rectified as quickly as possible by a specialist workshop, preferably an authorised BMW Motorrad dealer.

ABS self-diagnosis

– with BMW Motorrad ABS^{OE}

BMW Motorrad ABS performs self-diagnosis to ensure its operability. Self-diagnosis is performed automatically when you switch on the ignition. The mo-

torcycle has to move forward a few metres for the wheel sensors to be tested.

Phase 1

» Test of the diagnosis-compatible system components with the motorcycle at a standstill.



ABS warning light flashes.

Phase 2

» Test of the wheel sensors as the motorcycle pulls away from rest.



ABS warning light flashes.

ABS self-diagnosis completed

» The ABS warning light goes out.

If an indicator showing an ABS fault appears when ABS self-diagnosis completes:

- You can continue to ride. Bear in mind that the ABS function is not available.
- Have the fault rectified as quickly as possible by a specialist workshop, preferably an authorised BMW Motorrad dealer.

Running in

The first 1000 km

- While running in the motorcycle, vary the throttle opening and engine-speed range frequently; avoid riding at constant engine rpm for prolonged periods.
- Try to do most of your riding during this initial period on twisting, fairly hilly roads, avoiding high-speed main roads and highways if possible.

- Comply with the rpm limits for running in.

 Running-in speed
– <5000 min ⁻¹

- Do not omit the first inspection after 500 - 1200 km.

Brake pads

New brake pads have to bed down before they can achieve their optimum friction levels. You can compensate for this initial reduction in braking efficiency by exerting greater pressure on the levers.

 New brake pads can extend stopping distance by a significant margin.

Apply the brakes in good time.◀

Tyres

New tyres have a smooth surface. This must be roughened by riding in a restrained manner at various heel angles until the tyres are run in. This running in procedure is essential if the tyres are to achieve maximum grip.

 Tyres do not have their full grip when new and there is a risk of accidents at extreme angles of heel.

Avoid extreme angles of heel.◀

speed

– with on-board computer^{OE}

Redline warning



The redline warning indicates that engine revolutions have reached the rev. counter's red segment. The anti-theft alarm telltale light **1** flashes red to indicate that the engine is redlining.

The signal remains active until you shift up or reduce engine speed. You can activate or deactivate the redline warning.

Activating redline warning



- Press button **1** and button **2** at the same time and hold them down until the reading changes.
 - » FLASH (redline warning) appears, along with ON or OFF.
- Repeatedly press button **1** until the reading shows the mode you want.
 - » ON: Redline warning activated.
 - » OFF: Redline warning deactivated.
- To save the setting, press button **1** and button **2** at the same time and hold

them down until the reading changes.

Off-roading

After off-roading

BMW Motorrad recommends checking the following after riding the motorcycle off-road:

Tyre pressure



Tyre pressures reduced for off-road riding impair the motorcycle's handling characteristics on surfaced roads and can lead to accidents. Always check that the tyre pressures are correct. ◀

Brakes



When riding on loose surfaces or muddy roads, the brakes may fail to take effect immediately because of dirt or moisture on the discs or brake pads.

Apply the brakes in good time until the brakes have been cleaned.◀



The brake pads will wear more rapidly if you ride frequently on unsurfaced tracks or poor roads.

Check the thickness of the brake pads more frequently and replace the brake pads in good time.◀

Spring preload and shock-absorber settings



The off-road settings for spring preload and shock absorber damping characteristic will impair the motorcycle's handling characteristics on surfaced roads.

If you have been off-roading, remember to correct spring preload and shock-absorber damping characteristics before you return to surfaced roads.◀

Rims

BMW Motorrad recommends checking the rims for damage after off-roading.

Air filter element



Engine damage due to clogged air filter element. If you ride in dusty terrain check the air filter element for clogging at shorter intervals; clean or replace as necessary.◀

Operation in very dusty conditions (desert, steppes, or the like) necessitates the use of air filter elements specially designed for conditions of this nature.

Brakes

How can stopping distance be minimised?

Each time the brakes are applied, a load distribution shift takes place with the load shifting forward from the rear to the front wheel. The sharper the motorcycle decelerates, the more load is shifted to the front wheel. The higher the wheel load, the more braking force can be transmitted without the wheel locking.

To optimise stopping distance, apply the front brakes rapidly and keep on increasing the force you apply to the brake lever. This makes the best possible use of the dynamic increase in load at the front wheel. Remember to pull the clutch at the same time. In the "panic braking situations" that are trained so frequently braking force is applied as rapidly as possible and with the

rider's full force exerted on the brake levers; under these circumstances the dynamic shift in load distribution cannot keep pace with the increase in deceleration and the tyres cannot transmit the full braking force to the surface of the road. Under these circumstances the front wheel can lock up.

– with BMW Motorrad ABS^{OE} BMW Motorrad ABS prevents the front wheel from locking up.◀

Descending mountain passes

 There is a danger of the brakes fading if you use only the rear brakes when descending mountain passes. Under extreme conditions, the brakes could overheat and suffer severe damage.

Use both front and rear brakes,

and make use of the engine's braking effect as well.◀

Wet and dirty brakes

Wetness and dirt on the brake discs and the brake pads diminish braking efficiency.

Delayed braking action or poor braking efficiency must be reckoned with in the following situations:

- Riding in the rain or through puddles of water.
- After the motorcycle has been washed.
- Riding on salted or gritted roads.
- After work has been carried on the brakes, due to traces of oil or grease.
- Riding on dirt-covered surfaces or off-road.

 Wetness and dirt result in poor braking efficiency. Apply the brakes lightly while

riding to remove wetness and dirt, or dismount and clean the brakes.

Think ahead and brake in good time until full braking efficiency is restored.◀

Parking your motorcycle

Side stand

- Switch off the engine.

 If the ground is soft or uneven, there is no guarantee that the motorcycle will rest firmly on the stand.

Always check that the ground under the stand is level and firm.◀

- Extend the side stand and prop the motorcycle on the stand.

 The side stand is designed to support only the weight of the motorcycle.

Do not lean or sit on the motorcycle with the side stand extended.◀

- If the camber of the roadway permits, turn the handlebars all the way to the left.
- On a gradient, the motorcycle should always face uphill; select 1st gear.

Centre stand

– with centre stand^{OE}

- Switch off the engine.

 If the ground is soft or uneven, there is no guarantee that the motorcycle will rest firmly on the stand.

Always check that the ground under the stand is level and firm.◀

 Excessive movements could cause the centre stand to retract, and the

motorcycle would topple in consequence.

Do not lean or sit on the motorcycle with the centre stand extended.◀

- Extend the centre stand and lift the motorcycle onto the stand.

Refuelling

 Fuel is highly flammable. A naked flame close to the fuel tank can cause a fire or explosion.

Do not smoke. Never bring a naked flame near the fuel tank.◀

 Fuel expands when hot. Fuel escaping from an overfilled tank could make its way onto the road surface. This could cause a fall.

Do not overfill the fuel tank.◀

 Fuel attacks plastics, which become dull or unsightly. Wipe off plastic parts immediately if they come into contact with fuel.◀

 Leaded fuel will destroy the catalytic converter. Use only unleaded fuel.◀

- Make sure the ground is level and firm and place the motorcycle on its side stand.

 The volume of the tank can be utilised to the full only when the motorcycle is propped on its side stand.◀

- Open the protective cap.



- Use the ignition key to unlock the fuel filler cap and pop the cap open.



- Refuel with fuel of the grade stated below; do not fill the

tank past the bottom edge of the filler neck.

▶ When refuelling after running on reserve, make sure that you top up the tank to a level above reserve, as otherwise the sensor will not be able to register the new level. If the sensor cannot register the new level neither the fuel-level reading nor the range readout can be updated.◀



Recommended fuel grade

- Regular, unleaded
- 91 ROZ/RON
- 87 AKI



Usable fuel capacity

- approx. 16 l



Reserve fuel

- approx. 4 l

- Press the fuel tank cap down firmly to close.
- Remove the key and close the protective cap.

Securing motorcycle for transportation

- Make sure that all components that might come into contact with straps used to secure the motorcycle are adequately protected against scratching. Use adhesive tape or soft cloths, for example, for this purpose.



! The motorcycle can topple and fall on its side.

Make sure that the motorcycle cannot topple sideways.◀

- Push the motorcycle onto the transportation flat and hold it in position: do not place it on the side stand or centre stand.



! Risk of damaging components.

Take care not to trap components such as brake lines or wires.◀

- At the front, secure the straps to the bottom fork bridge on both sides and tighten the straps.◀



- At the rear, secure the straps to the rear frame on both sides and tighten the straps.
- Tighten all the straps uniformly; the motorcycle's suspension should be compressed as tightly as possible front and rear.

Engineering details

Brake system with BMW Motorrad

ABS 70

Tyre pressure monitoring RDC 72

Brake system with BMW Motorrad ABS

– with BMW Motorrad ABS^{OE}

How does ABS work?

The amount of braking force that can be transferred to the road depends on factors that include the coefficient of friction of the road surface. Loose stones, ice and snow or a wet road all have much lower coefficients of friction than a clean, dry asphalt surface. The lower the coefficient of friction, the longer the braking distance.

If the rider increases braking pressure to the extent that braking force exceeds the maximum transferrable limit, the wheels start to lock and the motorcycle loses its directional stability; a fall is imminent. Before this situation can occur, ABS intervenes and adapts braking pressure to the maximum transferrable braking

force, so the wheels continue to turn and directional stability is maintained irrespective of the condition of the road surface.

What are the effects of surface irregularities?

Humps and surface irregularities can cause the wheels to lose contact temporarily with the road surface; if this happens the braking force that can be transmitted to the road can drop to zero. If the brakes are applied under these circumstances the ABS has to reduce braking force to ensure that directional stability is maintained when the wheels regain contact with the road surface. At this instant the BMW Motorrad ABS must assume an extremely low coefficient of friction, so that the wheels will continue to rotate under all imaginable circumstances, because this is the precondition for ensuring

directional stability. As soon as it registers the actual circumstances, the system reacts instantly and adjusts braking force accordingly to achieve optimum braking.

Rear wheel lift

Under very severe and sudden deceleration, however, under certain circumstances it is possible that the BMW Motorrad ABS will be unable to prevent the rear wheel from lifting clear of the ground. If this happens the outcome can be a highside situation in which the motorcycle can flip over.



Severe braking can cause the rear wheel to lift off the ground.

When you brake, bear in mind that ABS control cannot be relied on in all circumstances to prevent the rear wheel from lifting clear of the ground. ◀

What is the design baseline for BMW Motorrad ABS?

Within the limits imposed by physics, BMW Motorrad ABS ensures directional stability on any surface. The system is not optimised for special requirements that apply under extreme competitive situations off-road or on the track.

Special situations

The speeds of the front and rear wheels are compared as one means of detecting a wheel's incipient tendency to lock. If the system registers implausible values for a lengthy period the ABS function is deactivated for safety reasons and an ABS fault message is issued. Self-diagnosis has to complete before fault messages can be issued. In addition to problems with the BMW Motorrad ABS, exceptional

riding conditions can lead to a fault message being issued.

Exceptional riding conditions:

- Riding for a lengthy period with the front wheel lifted off the ground (wheelie).
- Rear wheel rotating with the motorcycle held stationary by applying the front brake (burn-out).
- Heating up with the motorcycle on the centre stand or an auxiliary stand, engine idling or with a gear engaged.
- Rear wheel locked for a lengthy period, for example while descending off-road.

If a fault message is issued on account of exceptional riding conditions as outlined above, you can reactivate the ABS function by switching the ignition off and on again.

What significance devolves on regular maintenance?



Invariably, a technical system cannot perform beyond the abilities dictated by its level of maintenance.

In order to ensure that the BMW Motorrad ABS is always maintained in optimum condition, it is essential for you to comply strictly with the specified inspection intervals. ◀

Reserves for safety

The potentially shorter braking distances which BMW Motorrad ABS permits must not be used as an excuse for careless riding. ABS is primarily a means of ensuring a safety margin in genuine emergencies.

Take care when cornering. When you apply the brakes on a corner, the motorcycle's weight and

momentum take over and even BMW Motorrad ABS is unable to counteract their effects.

Tyre pressure monitoring RDC

– with tyre pressure monitoring (RDC)^{OE}

Function

A sensor integrated into each tyre measures the air temperature and the air pressure inside the tyre and transmits this information to the control unit.

Each sensor has a centrifugal-force trippswitch that does not enable transmission of the measured values until the motorcycle has accelerated to about 30 km/h. The display shows – – for each tyre until the tyre-pressure signal is received for the first time. The sensors continue to transmit the measured-value sig-

nals for approximately 15 minutes after the motorcycle comes to a stop.<

The control unit can administer four sensors, so two different sets of wheels with RDC sensors can be alternated on the motorcycle. An error message is issued if wheels without sensors are fitted to a motorcycle equipped with an RDC control unit.

Temperature compensation

Tyre pressure is a temperature-sensitive variable: pressure increases as tyre temperature rises and decreases as tyre temperature drops. Tyre temperature depends on ambient temperature, on the style of riding and the duration of the ride.

The tyre-pressure readings shown by the multifunction display are temperature-compensated; the reference tyre temperature for these readings is always 20 °C. The air lines available to the public in petrol stations and motorway service areas have gauges that do not compensate for temperature; the reading shown by a gauge of this nature is the temperature-dependent tyre pressure. In most instances, therefore, these gauge readings will not tally with the pressures shown by the multifunction display.<

Tyre-pressure ranges

The RDC control unit differentiates between three tyre-pressure ranges, all of which are parameterised for the motorcycle:

- Tyre pressure within permitted tolerance.
- Tyre pressure close to limit of permitted tolerance.
- Tyre pressure outside permitted tolerance.

and the RDC reading; when the air-line gauge shows 2.6 bar, the tyre is inflated to the correct pressure.<

Pressure adaptation

Compare the RDC readings on the multifunction display with the value in the table on the inside cover of the Rider's Manual. Then use the air line to compensate for the difference between the RDC reading and the value in the table.

Example: According to the Rider's Manual, tyre pressure should be 2.5 bar, but the reading in the multifunction display is 2.3 bar. The gauge on the air line shows 2.4 bar. You must now increase tyre pressure by the 0.2 bar difference between the value in the table

Accessories

General instructions.....	76
Power sockets	76
Luggage	77
Cases.....	77
Topcase	80

General instructions

BMW Motorrad recommends the use of parts and accessories for your motorcycle that are approved by BMW for this purpose. Genuine BMW parts and accessories and other products which BMW has approved can be obtained from your authorised BMW Motorrad dealer, together with expert advice on their installation and use.

These parts and products have been tested by BMW for safety, function and suitability. BMW accepts product liability for them. Conversely, BMW is unable to accept any liability whatsoever for parts and accessories which it has not approved.

Also bear in mind the information on the effect of wheel size on suspension-control systems (►► 97).



BMW Motorrad cannot examine or test each product of outside origin to ensure that it can be used on or in connection with BMW motorcycles without constituting a safety hazard. Country-specific official authorisation does not suffice as assurance. Tests conducted by these instances cannot make provision for all operating conditions experienced by BMW motorcycles and, consequently, they are not sufficient in some circumstances. Use only parts and accessories approved by BMW for your motorcycle. ◀

Whenever you are planning modifications, comply with all the legal requirements. Make sure that the motorcycle does not infringe the national road-vehicle construction and use regulations applicable in your country.

Power sockets

Notes on use of power sockets:

automatic shutdown

Power sockets are shut down automatically under the following circumstances:

- If battery charge state is too low to maintain the motorcycle's start capability
- If maximum load capability as stated in the technical data is exceeded
- When the engine is being cranked on the starter

Operating electrical accessories

You can start using electrical accessories connected to the motorcycle's sockets only when the ignition is switched on. The accessory remains operational if the ignition is subsequently switched off. The power sockets are switched off approximately

15 minutes after the ignition is switched off, in order to prevent overloading of the on-board electronics.

Cable routing

The cables from the power sockets to the auxiliary devices must be routed in such a way that they:

- Do not impede the rider
- Do not restrict the steering angle or obstruct handling
- Cannot be trapped

Luggage

Lashing luggage

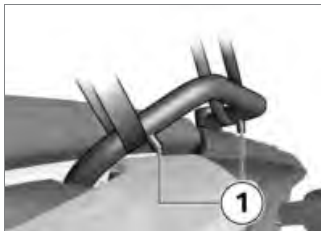

- Loop the luggage straps over the bar between the motorcycle and stops **1**.



- Position luggage strap **2** as shown here with a stuffbag as example.
- Check that the luggage is secure.

Cases

- with cases^{OE}

Opening cases

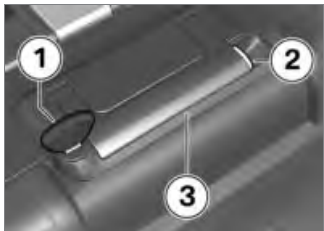

- Turn key **1** in the case lock to right angles with the forward direction of travel.
- Press and hold down yellow latch **2** and pull up carry handle **3**.

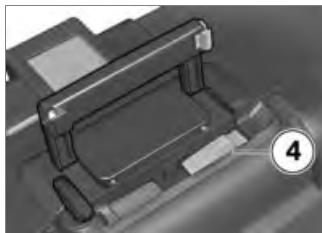

- Push yellow button **4** down and at the same time open the lid of the case.

Closing cases

- Turn the lock with the key until it is at right angles to the forward direction of travel.
- Close the case lid.
- » The lid engages with an audible click.



! Closing the carry handle while the case lock is in line with the forward direction of travel can result in damage to the locking tongue.

Make sure that the case lock is at right angles to the forward direction of travel when you close the carry handle. ◀

- Close carry handle **3**.
- Turn the key in the case lock in line with the forward direction of travel and remove the key from the lock.

Adjusting case volume

- Open the case and remove all its contents.



- Engage pivot lever **1** at the top limit position to set the case to minimum volume.
- Engage pivot lever **1** at the bottom limit position to set the case to maximum volume.
- Close the case.

Removing cases

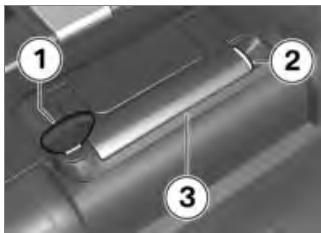

- Turn key **1** in the case lock to right angles with the forward direction of travel.
- Press and hold down yellow latch **2** and pull up carry handle **3**.

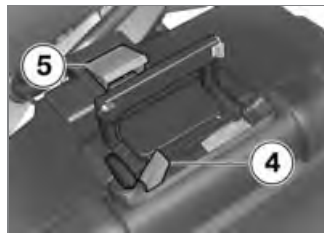

- Pull red release lever **4** up.
» Latching flap **5** pops up.
- Fully open the latching flap.
- Take a firm grip of the handle and lift the case out of the holder.

Install the cases

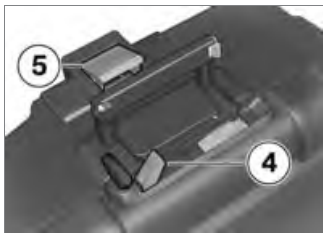

- Fully open latching flap **5**, if necessary pulling up red release lever **4**.◁



- Position the case in case carrier **6**, then pivot it until it is seated at mount **7**.

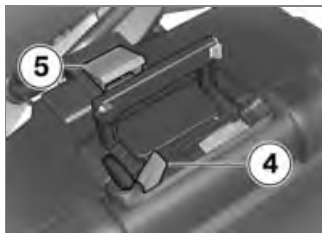

- Push latching flap **5** down as far as it will go and hold it in this position.

- Push red release lever **4** down.
» Latching flap **5** engages.
- Close the carry handle.
- Turn the key parallel with the direction of travel and remove.

Topcase

– with topcase^{OA}

Opening topcase



- Turn key **1** in the topcase lock to the vertical position.
- Press and hold down yellow latch **2** and pull out carry handle **3**.



- Push yellow button **4** forward and at the same time push the topcase lid up.

Close the topcase



- Press down firmly on the topcase lid to close.



Closing the carry handle while the topcase lock is horizontal can result in damage to the locking tongue. Make sure that the topcase lock is vertical when you close the carry handle. ◀

- Close carry handle **3**.
 - » The handle engages with an audible click.
- Turn the key in the topcase lock to the horizontal position and remove the key from the lock.

Adjusting topcase volume

- Open the topcase and remove all its contents.



- Engage pivot lever **1** at the front limit position to set the case to maximum volume.
- Engage pivot lever **1** at the rear limit position to set the case to minimum volume.
- Close the topcase.

Removing topcase

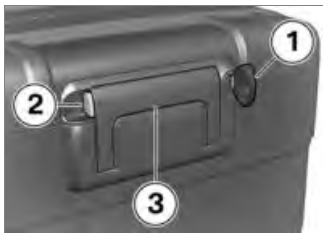

- Turn key **1** in the topcase lock to the vertical position.
- Hold down yellow latch **2** and push carry handle **3** down.



- Pull red lever **4** back as far as it will go.
» Latching flap **5** pops up.
- Fully open latching flap **5**.
- Take a firm grip of the handle and lift the topcase out of the holder.

Installing topcase



- Fully open latching flap **5**, if necessary pulling red release lever **4** to the rear.<



- Engage the topcase in front holders **6** of the topcase carrier plate.
- Press the topcase onto the topcase carrier plate at the rear.



- Push latching flap **5** fully closed and hold it in this position.
- Push red release lever **4** forward.
 - » The latching flap engages.
- Close the carry handle.
- Turn the key to the horizontal position and remove.

Maintenance

General instructions.....	86
Toolkit	86
Engine oil	87
Brake system	88
Coolant	92
Clutch	93
Rims and tyres.....	94
Chain	95
Wheels	97
Front-wheel stand	103
Bulbs	104
Body panels	109
Air filter	111
Jump starting.....	111
Battery.....	113

General instructions

The "Maintenance" chapter describes straightforward procedures for checking and replacing certain wear parts.

Special tightening torques are listed as applicable. The tightening torques for the threaded fasteners on your motorcycle are listed in the section entitled "Technical data".

You will find information on more extensive maintenance and repair work in the Repair Manual on DVD for your motorcycle, which is available from your authorised BMW Motorrad dealer.

Some of the work calls for special tools and a thorough knowledge of motorcycle technology. If you are in doubt consult a specialist workshop, preferably your authorised BMW Motorrad dealer.

Toolkit

Standard toolkit

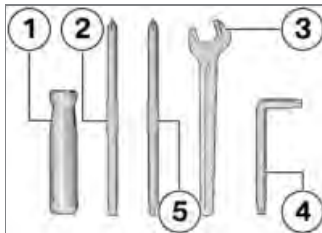

- 1 Screwdriver handle
- 2 Reversible screwdriver blade
With star-head and plain-tip ends
 - Replacing turn indicator bulbs, front and rear (➡ 107).
 - Replacing number-plate light bulbs (➡ 108).
 - Removing battery (➡ 114).

- 3 Open-ended spanner
Width across flats 17
– Adjust the mirror arm (➡ 48).
- 4 Torx wrench, T40
– Adjusting headlight beam throw (➡ 52).
- 5 Reversible screwdriver blade
With star-head and Torx T25
– Remove the centre trim panel (➡ 109).

Tools service set

- with service toolkit^{OA}



BMW Motorrad has assembled a tools service set that is ideal for carrying out extended service work (e.g. removing and installing wheels) on this motorcycle. You can obtain the tools set from your authorised BMW Motorrad dealer.

Engine oil

Checking engine oil level



The oil level varies with the temperature of the oil. The higher the temperature, the higher the level of oil in the sump. Checking the oil level with

the engine cold or after no more than a short ride will lead to misinterpretation; this in turn, means that the engine will be operated with the incorrect quantity of oil. In order to ensure that the engine oil level is read correctly, check the oil level only after a lengthy trip.◀

- Wipe the area around the oil filler neck clean.
- Allow the engine to idle until the fan starts up, then allow it to idle one minute longer.
- Switch off the engine.
- Make sure the engine is at operating temperature and hold the motorcycle upright.
– with centre stand^{OE}
- Check that the engine is at operating temperature, make sure the ground is level and firm and place the motorcycle on its centre stand.◀



- Remove oil dipstick **1**.

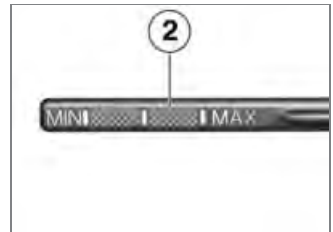

- Use a dry cloth to wipe gauge length **2** clean
- Seat the oil dipstick on the oil filler neck, but do not engage the threads.

- Remove the oil dipstick and check the oil level.

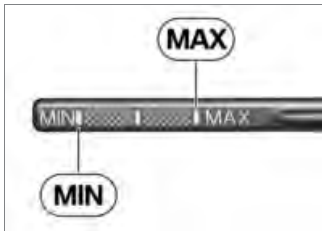

Engine oil, specified level

– Between MIN and MAX marks

If the oil level is below the MIN mark:

- Top up the engine oil (➔ 88).

If the oil level is above the MAX mark:

- Have the oil level corrected by a specialist workshop,

preferably an authorised BMW Motorrad dealer.

- Install the oil dipstick.

Top up the engine oil

- Make sure the ground is level and firm and place the motorcycle on its stand.
- Wipe the area around the filler neck clean.



- Remove oil dipstick 1.



Damage to the engine can result if it is operated without enough oil, but the same

also applies if the oil level is too high.

Always make sure that the oil level is correct. ◀

- Top up the engine oil to the specified level.
- Check the engine oil level (➔ 87).
- Install the oil dipstick.

Brake system

Check operation of the brakes

- Pull the handbrake lever.
 - » The pressure point must be clearly perceptible.
- Press the footbrake lever.
 - » The pressure point must be clearly perceptible.

If pressure points are not clearly perceptible:



Incorrect working practices endanger the reliability of the brakes.

Have all work on the brake system undertaken by trained and qualified specialists.◀

- Have the brakes checked by a specialist workshop, preferably an authorised BMW Motorrad dealer.

Checking brake-pad thickness, front brakes

- Make sure the ground is level and firm and place the motorcycle on its stand.



- Visually inspect the left and right brake pads to ascertain their thickness. Viewing direc-

tion: Between wheel and front suspension toward brake caliper **1**.

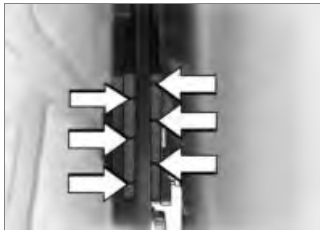

 Brake-pad wear limit, front

– min 1.0 mm (Friction pad only, without backing plate. The wear indicators (grooves) must be clearly visible.)

If the wear indicating marks are no longer clearly visible:

 Brake pads worn past the minimum permissible thickness can cause a reduction in braking efficiency and under certain circumstances they can cause damage to the brake system.

In order to ensure the dependability of the brake system, do not permit the brake pads to wear past the minimum permissible thickness.◀

- Have the brake pads replaced by a specialist workshop, preferably an authorised BMW Motorrad dealer.

Check the brake pad thickness, rear brakes

- Make sure the ground is level and firm and place the motorcycle on its stand.



- Visually inspect the brake pads to ascertain their thickness. Viewing direction: from the rear toward brake caliper **1**.



Brake-pad wear limit,
rear

– min 1.0 mm (Friction pad only, without backing plate. The wear indicators must be clearly visible.)

If the wear indicating mark is no longer visible:



Brake pads worn past the minimum permissible thickness can cause a reduction in braking efficiency and under certain circumstances they can

cause damage to the brake system.

In order to ensure the dependability of the brake system, do not permit the brake pads to wear past the minimum permissible thickness.◀

- Have the brake pads replaced by a specialist workshop, preferably an authorised BMW Motorrad dealer.

Checking brake-fluid level, front brakes



A low fluid level in the brake reservoir can allow air to penetrate the brake system. This significantly reduces braking efficiency.

Check the brake-fluid level at regular intervals.◀

- Make sure the ground is level and firm and hold the motorcycle upright.

- with centre stand^{OE}
- Make sure the ground is level and firm and place the motorcycle on its centre stand.◀
- Move the handlebars to the straight-ahead position.



- Check the brake fluid level in front reservoir **1**.

▷ Wear of the brake pads causes the brake fluid level in the reservoir to sink.◀◀



	Brake fluid level, front (visual inspection)
– Brake fluid (DOT4)	
– It is impermissible for the brake fluid level to drop below the MIN mark.	

If the brake fluid level drops below the permitted level:

- Have the defect rectified as quickly as possible by a specialist workshop, preferably an authorised BMW Motorrad dealer.

Check the brake-fluid level, rear brakes

 A low fluid level in the brake reservoir can allow air to penetrate the brake system. This significantly reduces braking efficiency. Check the brake-fluid level at regular intervals.◀

- Make sure the ground is level and firm and hold the motorcycle upright.
- with centre stand^{OE}
- Make sure the ground is level and firm and place the motorcycle on its centre stand.◀



- Check the brake fluid level in rear reservoir **1**.

▶ Wear of the brake pads causes the brake fluid level in the reservoir to sink.◀



 Brake fluid level, rear
(visual inspection)

– Brake fluid (DOT4)

– It is impermissible for the brake fluid level to drop below the MIN mark.

If the brake fluid level drops below the permitted level:

- Have the defect rectified as quickly as possible by a specialist workshop, preferably an authorised BMW Motorrad dealer.

Coolant

Check the coolant level

- Make sure the ground is level and firm and place the motorcycle on its stand.



- Check the coolant level in expansion tank **1**. Viewing direction: From in front, between windscreen and right side panel.



Coolant, specified level

– Antifreeze

– between MIN and MAX marks on the expansion tank

If the coolant drops below the permitted level:

- Top up the coolant.

Topping up coolant



- Open cap **1** of the expansion tank.
- Using a suitable funnel, top up with coolant until the level is correct.
- Close the cap of the expansion tank.

Clutch

Checking clutch operation

- Pull the clutch lever.
 - » The pressure point must be clearly perceptible.

If the pressure point is not clearly perceptible:

- Have the clutch checked by a specialist workshop, preferably an authorised BMW Motorrad dealer.

Check the clutch play

- Turn the handlebars all the way to left

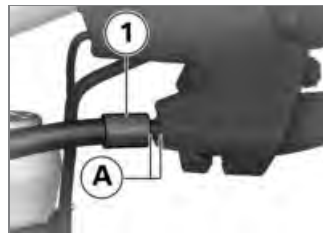

- Pull clutch cable **1** as far as possible away from the clutch lever.

- Measure clutch play **A** between the handlebar fitting and the clutch cable.



– 3 mm (Handlebars turned fully left, between handlebar fitting and clutch cable)

Clutch play is out of tolerance:

- Adjusting clutch play (➡ 94).

Adjusting clutch play



- Slacken nut **3**.
- To increase clutch play: screw nut **2** up.

- To reduce clutch play: screw nut **2** down.
- Check the clutch play (➡ 93).
- Repeat the steps in this procedure until clutch play is set correctly.
- Tighten nut **3**.

Rims and tyres

Checking rims

- Make sure the ground is level and firm and place the motorcycle on its stand.
- Visually inspect the rims for defects.
- Have damaged rims checked and, if necessary, replaced by a specialist workshop, preferably an authorised BMW Motorrad dealer.

Check the tyre tread depth



Your motorcycle's handling and grip can be impaired even before the tyres wear to the minimum tyre tread depth permitted by law.

Have the tyres changed in good time before they wear to the minimum permissible tread depth. ◀

- Make sure the ground is level and firm and place the motorcycle on its stand.
- Measure the tyre tread depth in the main tread grooves with wear marks.



Tyres have wear indicators integrated into the main tread grooves. The tyre is worn out when the tyre tread has worn down to the level of the marks. The locations of the marks are indicated on the edge of the tyre,

e.g. by the letters TI, TWI or by an arrow.◀

If the tyre tread is worn to minimum:

- Replace tyre or tyres, as applicable.

Chain

Lubricating chain



Dirt, dust and inadequate lubrication will result in accelerated wear and significantly shorten the drive chain's useful life.

Clean and lubricate the drive chain at regular intervals.◀

- Lubricate the drive chain every 1000 km at the latest. Lubricate the chain more frequently if the motorcycle is ridden in wet, dusty or dirty conditions.<
- Switch the ignition off and select neutral.

- Clean the drive chain with a suitable cleaning product, dry it and apply chain lubricant.
- Wipe off excess lubricant.

Checking chain sag

- Make sure the ground is level and firm and place the motorcycle on its stand.
- Turn the rear wheel until it reaches the position with the lowest amount of chain sag.

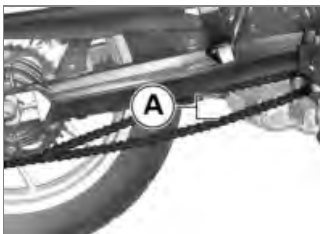

- Use a screwdriver to push the chain up and down and measure difference **A**.



Chain deflection

- 30...40 mm (Motorcycle with no weight applied, supported on its side stand)
- with lowered suspension^{OE}
- 20...30 mm (Motorcycle with no weight applied, supported on its side stand)<

If measured value is outside permitted tolerance:

- Adjust the chain sag (➡ 95).

Adjusting chain sag

- Make sure the ground is level and firm and place the motorcycle on its stand.

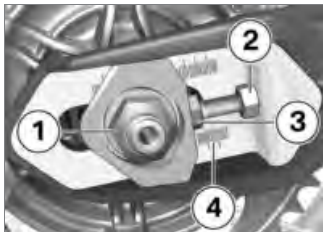

- Slacken quick-release axle nut **1**.
- Slacken locknuts **2** on left and right.
- Use adjusting screws **3** on left and right to adjust chain sag.
- Checking chain sag (→ 95).
- Make sure that scale readings **4** are the same on left and right.
- Tighten locknuts **2** on left and right to the specified tightening torque.

 Locknut of the final-drive chain tensioning screw

– 19 Nm

- Tighten quick-release axle nut **1** to the specified tightening torque.

 Rear quick-release axle in swinging arm

– 100 Nm

Checking chain wear

- Make sure the ground is level and firm and place the motorcycle on its stand.
- Engage 1st gear.
- Turn the rear wheel in the normal direction of travel until the chain is tensioned.
- Measure the length of the chain over 9 rivets below the rear wheel swinging arm.

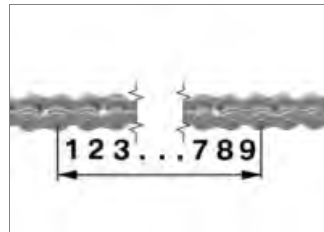

 permissible chain length

– max 144.30 mm (measured over 9 rivets, chain pulled taut)

If the chain has stretched to the maximum permissible length:

- Seek the advice of a specialist workshop, preferably an authorised BMW Motorrad dealer.

Wheels

Tyre recommendation

For each size of tyre BMW Motorrad tests certain makes, and approves those that it certifies as roadworthy. If BMW Motorrad has not approved the wheels and tyres, it cannot assess their suitability or provide any guarantee of road safety. Use only wheels and tyres approved by BMW Motorrad for your type of motorcycle.

You can obtain detailed information from your authorised BMW Motorrad dealer or on the Internet at www.bmw-motorrad.com.

Effect of wheel size on ABS

Wheel size is very important as a parameter for the ABS. In particular, the diameter and the width of a motorcycle's wheels are programmed into the control unit

and are fundamental to all calculations. Any change in these influencing variables, caused for example by a switch to wheels other than those installed ex-works, can have serious effects on the performance of the control systems.

The sensor rings are essential for correct road-speed calculation, and they too must match the motorcycle's control systems and consequently cannot be changed.

If you decide that you would like to fit non-standard wheels to your motorcycle, it is very important to consult a specialist workshop beforehand, preferably an authorised BMW Motorrad dealer. In some cases, the data programmed into the control units can be changed to suit the new wheel sizes.

RDC label

– with tyre pressure monitoring (RDC)^{OE}

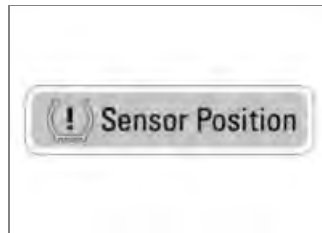

 Incorrect tyre fitting can damage the RDC sensors. Be sure to explain to the authorised BMW Motorrad dealer or the specialist workshop that the wheel is fitted with an RDC sensor.◀

If the motorcycle is equipped with RDC, each wheel rim bears an adhesive label indicating the position of the RDC sensor. When changing the tyre, take

care not to damage the RDC sensor. Be sure to draw the attention of the authorised BMW Motorrad dealer or specialist workshop to the fact that the wheel is fitted with an RDC sensor.

Removing front wheel

- Make sure the ground is level and firm and place the motorcycle on its stand.
 - with BMW Motorrad ABS^{OE}



- Remove screw **1** and remove the speed sensor from its bore.<

- Place the motorcycle on a suitable auxiliary stand.
 - with centre stand^{OE}
- Make sure the ground is level and firm and place the motorcycle on its centre stand.<
- Raise front of motorcycle until the front wheel can turn freely. BMW Motorrad recommends the BMW Motorrad front-wheel stand for lifting the motorcycle.
- Install the front-wheel stand (→ 103).



- Release axle clamping screw **2**.

- Remove axle **3**, while supporting the wheel.
- Do not remove the grease from the axle.



Once the calipers have been removed, there is a risk of the brake pads being pressed together to the extent that they cannot be slipped back over the brake disc on reassembly.

Do not operate the handbrake lever when the brake calipers have been removed.<

- Roll the front wheel forward to remove.



- Remove spacing bushing **4** from the left-hand side of the wheel hub.





- Slip spacing bushing **4** into the left-hand side of the wheel hub.



- Raise the front wheel, insert axle **3** and tighten to specified torque.

Installing front wheel

 Threaded fasteners not tightened to the specified torque can work loose or their threads can suffer damage. Always have the security of the fasteners checked by a specialist workshop, preferably an authorised BMW Motorrad dealer. ◀

 The front wheel must be installed right way round to rotate in the correct direction. Note the direction-of-rotation arrows on the tyre or the wheel rim. ◀

- Roll the front wheel into position between the forks, making sure that the brake disc passes between the brake pads.

 Quick-release axle, front, in axle holder

– 30 Nm

- Remove the front-wheel stand.
- without centre stand^{OE}
- Remove the auxiliary stand. ◀
- Firmly compress the front forks several times.



- Tighten axle clamping screw **2** to the specified torque.



Clamp of quick-release axle

– 19 Nm

– with BMW Motorrad ABS^{OE}



- Insert the ABS sensor into its bore and install screw **1**.



The cable of the wheel-speed sensor could chafe through if it comes into contact with the brake disc.

Make sure that the sensor cable is routed correctly.◀

- Make sure that the ABS sensor cable is routed as shown here.◀

Remove the rear wheel

- Make sure the ground is level and firm and place the motorcycle on its stand.



- Remove screw **1** and remove the speed sensor from its bore.
- Make sure the ground is level and firm and place the motorcycle on a suitable auxiliary stand.

– with centre stand^{OE}

- Make sure the ground is level and firm and place the motorcycle on its centre stand.◀

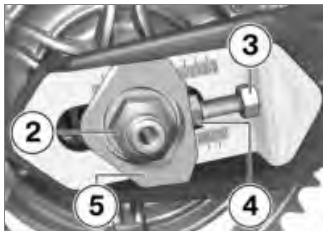

- Remove axle nut **2**.
- Slacken locknuts **3** on left and right by turning them counter-clockwise.
- Back off adjusting screws **4** on left and right by turning them counter-clockwise.
- Remove adjusting plate **5** and push the axle in as far as it will go.



- Remove quick-release axle **6** and remove adjusting plate **7**.

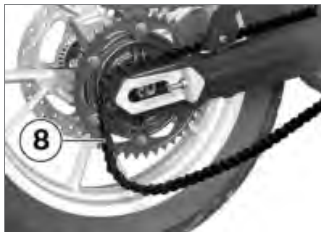

- Roll the rear wheel as far forward as possible and disengage chain **8** from the sprocket.

- Roll the rear wheel back until it is clear of the swinging arm.

 The sprocket and the spacer sleeves on left and right are loose fits in the wheel. Make sure that these parts are not damaged or lost on removal. ◀

Install the rear wheel

 Possible malfunctions when the ABS system intervenes if non-standard wheels are installed.

See the information on the effect of wheel size on the ABS system at the start of this chapter. ◀

 Threaded fasteners not tightened to the specified torque can work loose or their threads can suffer damage. Always have the security of the fasteners checked by a specialist workshop, preferably an authorised BMW Motorrad dealer. ◀

- Roll the rear wheel into the swinging arm, making sure that the brake disc passes between the brake pads.



- Roll the rear wheel as far forward as possible and loop chain **8** over the sprocket.



- Seat left adjusting plate **7** in the swinging arm and install quick-release axle **6** in the brake caliper and the rear wheel.
- Make sure that the axle fits into the recess of the adjusting plate.



- Install right adjusting plate **5**.



- Install nut **2**, but do not tighten it at this point.

- without centre stand^{OE}
- Remove the auxiliary stand.<



- Insert the speed sensor into the bore and install screw **1**.
- Adjust the chain sag (→ 95).

Front-wheel stand

Install the front-wheel stand

 The BMW Motorrad front wheel stand is not designed to support the motorcycle without the assistance of an auxiliary stand. A motorcycle resting only on the front wheel stand and the rear wheel can topple.

Place the motorcycle on an auxiliary stand before lifting the front wheel with the BMW Motorrad front-wheel stand.◀

- Place the motorcycle on a suitable auxiliary stand.
 - with centre stand^{OE}
- Place the motorcycle on its centre stand.◀

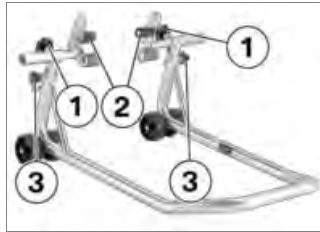

- Use basic stand (83 30 0 402 241) with front-wheel adapter (83 30 0 402 242).
- Slacken adjusting screws **1**.
- Push the two adapters **2** apart until the front forks fit between

them. Adjust the adapter studs to suit the front suspension.

- Use locating pins **3** to set the front-wheel stand to the desired height.
- Centre the front-wheel stand relative to the front wheel and push it against the front axle.

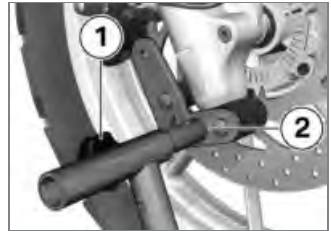

- Align the two adapters **2** so that the front forks are securely seated.
- Tighten adjusting screws **1**.



- Apply uniform pressure to push the front-wheel stand down and raise the motorcycle.

– with centre stand^{OE}



If the motorcycle is raised too far the centre stand will lift clear of the ground and the motorcycle could topple to one side.

When raising the motorcycle, make sure that the centre stand remains on the ground. If necessary, adjust the height of the front-wheel stand.◀

- Make sure the motorcycle is standing firmly.◀

Bulbs

Replacing low-beam and high-beam headlight bulb

- Make sure the ground is level and firm and place the motorcycle on its stand.
- Switch off the ignition.

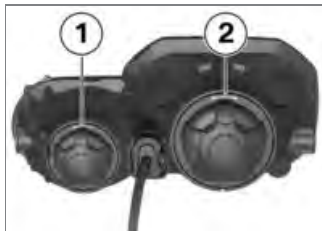

- Remove cover **1** for the high-beam headlight or cover **2** for the low-beam headlight.

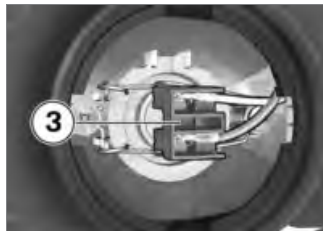

- Disconnect plug **3**.



- Disengage spring clips **4** from the fastenings and swing them aside.
- Remove bulb **5**.

- Replace the defective bulb.



– H7 / 12 V / 55 W

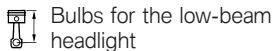

– H7 / 12 V / 55 W

- Hold the new bulb by the base only, in order to keep the glass free of foreign matter.



- Install the bulb, making sure that alignment is correct at position **6**.

- Close and lock spring clips **4**.

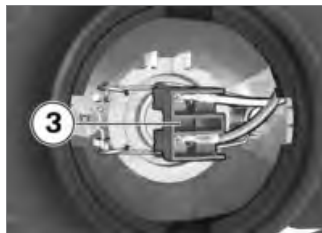

- Connect plug **3**.

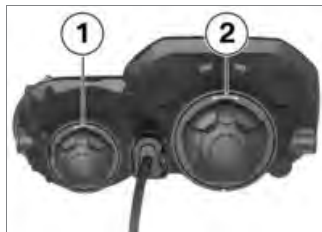

- Install cover **1** or cover **2**, as applicable.

Replacing parking-light bulb

- Make sure the ground is level and firm and place the motorcycle on its stand.
- Switch off the ignition.

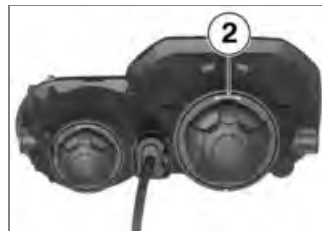

- Remove cover **2**.



- Pull parking-light bulb **3** out of the headlight housing.



- Remove the bulb from the bulb holder.

- Replace the defective bulb.



Bulb for parking light

– W5W / 12 V / 5 W



- Push the bulb into the bulb socket.



- Insert parking-light bulb **3** into the headlight housing.

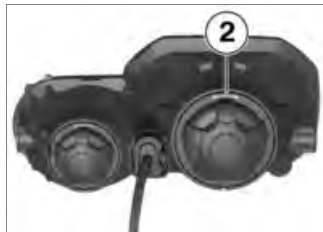

- Install cover **2**.

Replacing brake light and rear light bulb

- The LED rear light can be replaced only as a complete unit. Consult a specialist workshop, preferably an authorised BMW Motorrad dealer.

Replacing turn indicator bulbs, front and rear

- Make sure the ground is level and firm and place the motorcycle on its stand.
- Switch off the ignition.



- Remove screw **1**.



- Pull the glass out of the reflector housing at the threaded-fastener side.



- Turn bulb **2** counter-clockwise and remove it from the bulb housing.

- Replace the defective bulb.

 Bulbs for flashing turn indicators, front

– R10W / 12 V / 10 W

– with white turn indicators^{OE}

– RY10W / 12 V / 10 W\triangleleft

– with LED turn indicators^{OA}

– LED / 12 V\triangleleft

 Bulbs for flashing turn indicators, rear

– R10W / 12 V / 10 W

– with white turn indicators^{OE}

– RY10W / 12 V / 10 W\triangleleft

– with LED turn indicators^{OA}

– LED / 12 V\triangleleft

- Use a clean, dry cloth to hold the new bulb in order to keep the glass free of foreign matter.

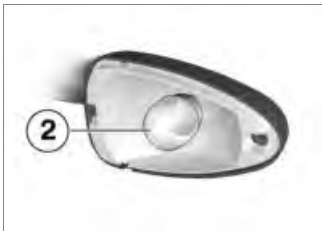

- Turn bulb **2** clockwise to install it in the bulb housing.



- Working from the inboard side, insert the glass into the bulb housing and close the housing.



- Install screw **1**.

Replacing number-plate light bulbs

- Make sure the ground is level and firm and place the motorcycle on its stand.
- Switch off the ignition.



- Remove screw **1** from the mudguard cover and remove the cover.



- Pull bulb holder **2** out of the light carrier.



- Pull the bulb out of the bulb socket.
- Replace the defective bulb.

 Bulb for number-plate light

– W5W / 12 V / 5 W

- Use a clean, dry cloth to hold the new bulb in order to keep the glass free of foreign matter.



- Insert the bulb into the bulb socket.



- Seat bulb holder **2** in the light carrier.



- Hold the mudguard cover in position and install screw **1**.

Body panels

Remove the centre trim panel

- Remove the seat ( 52).



- Remove screws **1** on left and right.

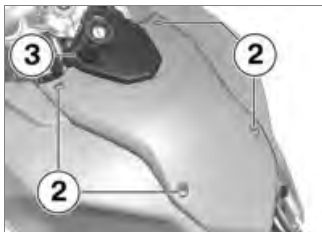

- Remove four screws **2**.
- Disconnect the plug from socket **3**.
- Remove the centre trim panel.

Installing centre trim panel

- Connect the plug to the socket.



- Manoeuvre the centre trim panel into position. Make sure that all three tabs **4** on left and right engage the side panels.

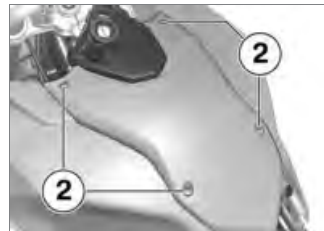

- Install four screws **2**.



- Install screws **1** on left and right.
- Install the seat (→ 53).

Air filter

Removing air filter

- Remove the centre trim panel (➡ 109).

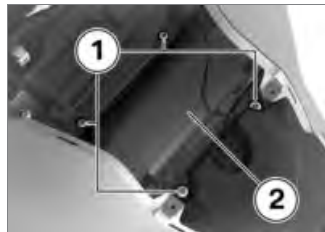

- Remove screws **1**.
- Remove air-filter cover **2**.



- Remove air filter **3**.

Installing air filter



- Install air filter **3**.

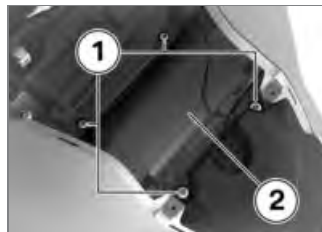

- Hold air-filter cover **2** in position.
- Install screws **1**.
- Installing centre trim panel (➡ 110).

Jump starting

 The wires leading to the power socket do not have a load-capacity rating adequate for jump-starting the engine. Excessively high current can lead to a cable fire or damage to the vehicle electronics.

Do not use the on-board socket

to jump-start the engine of the motorcycle. ◀

! A short-circuit can result if the crocodile clips of the jump leads are accidentally brought into contact with the motorcycle.

Use only jump leads fitted with fully insulated crocodile clips at both ends. ◀

! Jump-starting with a donor-battery voltage higher than 12 V can damage the vehicle electronics.

Make sure that the battery of the donor vehicle has a voltage rating of 12 V. ◀

- Remove the centre trim panel (→ 109).
- When jump-starting the engine, do not disconnect the battery from the on-board electrical system.



- Begin by connecting one end of the red jump lead to the positive terminal of the discharged battery and the other end to the positive terminal of the donor battery (positive on this vehicle: position **2**).
- Then connect one end of the black jump lead to the negative terminal of the donor battery and the other end to the negative terminal of the discharged battery (negative on this vehicle: position **1**).

▷ The spring-strut screw can be used as an alternative to the battery's negative terminal. ◀

- Run the engine of the donor vehicle during jump-starting.
- Start the engine of the vehicle with the discharged battery in the usual way; if the engine does not start, wait a few minutes before repeating the attempt in order to protect the starter motor and the donor battery.
- Allow both engines to idle for a few minutes before disconnecting the jump leads.
- Disconnect the jump lead from the negative terminals first, then disconnect the second lead from the positive terminals.

▷ Do not use proprietary start-assist sprays or other products to start the engine. ◀

- Installing centre trim panel (→ 110).

Battery

Maintenance instructions

Correct upkeep, recharging and storage will prolong the life of the battery and are essential if warranty claims are to be considered.

Compliance with the points below is important in order to maximise battery life:

- Keep the surface of the battery clean and dry
- Do not open the battery
- Do not top up with water
- Be sure to read and comply with the instructions for charging the battery on the following pages
- Do not turn the battery upside down



If the battery is not disconnected, the on-board electronics (e.g. clock, etc.) gradually drain the battery. This can cause the battery to run flat. If this happens, warranty claims will not be accepted.

Connect a float charger to the battery if the motorcycle is to remain out of use for more than four weeks.◀



BMW Motorrad has developed a float charger specially designed for compatibility with the electronics of your motorcycle. Using this charger, you can keep the battery charged during long periods of disuse, without having to disconnect the battery from the motorcycle's on-board systems. You can obtain additional information from your authorised BMW Motorrad dealer.◀

Charging battery when connected

- Disconnect devices plugged into the sockets.



Charging the connected battery directly at the battery terminals can damage the vehicle electronics.

Always disconnect the battery from the on-board circuits before recharging it with a charger connected directly to the battery posts.◀



Only chargers suitable for this mode of charging can be used to recharge the battery via the on-board socket. Unsuitable chargers could cause damage to the motorcycle's on-board electrics.

Use BMW chargers with the part numbers 71 60 7 688 864 (220 V) or, as applicable, 71 60 7 688 865 (110 V). If you are in doubt, disconnect

the battery from the on-board systems and connect the charger directly to the battery.◀



If you switch on the ignition and the multifunction display and telltale lights fail to light up, the battery is completely flat (battery voltage is less than 9 V). Attempting to charge a completely flat battery via the on-board socket can cause damage to the motorcycle's electronics. If a battery has discharged to the extent that it is completely flat, it has to be disconnected from the on-board circuits and charged with the charger connected directly to the battery posts.◀

- Charge via the power socket, with the battery connected to the motorcycle's on-board electrical system.

▶ The motorcycle's on-board electronics know when the battery is fully charged. The

on-board socket is switched off when this happens.◀

- Comply with the operating instructions of the charger.

▶ If you are unable to charge the battery through the on-board socket, you may be using a charger that is not compatible with your motorcycle's electronics. If this happens, disconnect the battery from the on-board systems and connect the charger directly to the battery.◀◀

Charging battery when disconnected

- Charge the battery using a suitable charger.
- Comply with the operating instructions of the charger.
- Once the battery is fully charged, disconnect the charger's terminal clips from the battery terminals.



The battery has to be recharged at regular intervals in the course of a lengthy period of disuse. See the instructions for caring for your battery. Always fully recharge the battery before restoring it to use.◀

Removing battery

- Make sure the ground is level and firm and place the motorcycle on its stand.
 - with anti-theft alarm^{OE}
- If applicable, switch off the anti-theft alarm.◀
- Switch off the ignition.
- Remove the centre trim panel (▶ 109).



! Disconnection in the wrong sequence increases the risk of short-circuits.

Always proceed in the correct sequence. ◀

- Disconnect negative lead **1** first.
- Then disconnect positive lead **2**.
- Remove screws **3** on left and right and remove the battery holder.
- Lift the battery up and out; work it slightly back and forth if it is difficult to remove.

Installing battery

▶ If the battery was disconnected from the motorcycle for a prolonged period of time it will be necessary to enter the current date in the instrument panel, in order to ensure that the service-due indicator functions correctly.

If you want to have the date set consult a specialist workshop, preferably an authorised BMW Motorrad dealer. ◀

- Switch off the ignition.
- Insert the battery into the battery compartment, with the positive terminal on the right in the direction of travel.



- Place the battery holder in position, making sure that the leads are correctly routed at position **4**.
- Install screws **3** on left and right.

! Connection in the wrong sequence increases the risk of short-circuits.

Always proceed in the correct sequence. ◀

- Connect positive lead **2** to the battery's positive terminal.
- Connect negative lead **1** to the battery's negative terminal.

- Installing centre trim panel (➡ 110).
- Setting clock (➡ 39).

Care

Care products	118
Washing motorcycle	118
Cleaning easily damaged components.....	118
Paint care	119
Protective wax coating	120
Laying up motorcycle	120
Restoring motorcycle to use	120

Care products

BMW Motorrad recommends that you use the cleaning and care products you can obtain from your authorised BMW Motorrad dealer. The substances in BMW Care Products have been tested in laboratories and in practice; they provide optimised care and protection for the materials used in your vehicle.

 The use of unsuitable cleaning and care products can damage vehicle components. Do not use solvents such as cellulose thinners, cold cleaners, fuel or the like, and do not use cleaning products that contain alcohol.◀

Washing motorcycle

BMW Motorrad recommends that you use BMW insect remover to soften and wash off insects and stubborn dirt on

painted parts prior to washing the motorcycle.

To prevent stains, do not wash the motorcycle immediately after it has been exposed to strong sunlight and do not wash it in the sun.

Make sure that the motorcycle is washed frequently, especially during the winter months.

To remove road salt, clean the motorcycle with cold water immediately after every trip.

 After the motorcycle has been washed, ridden through water or ridden in the rain, the brake discs and pads might be wet and the brakes might not take effect immediately.

Apply the brakes in good time until the brake discs and brake pads have dried out.◀

 Warm water intensifies the effect of salt.

Use only cold water to wash off road salt.◀

 The high pressure of high-pressure cleaners (steam cleaners) can damage seals, the hydraulic brake system, the electrical system, and the seat. Do not use a steam jet or high-pressure cleaning equipment.◀

Cleaning easily damaged components

Plastics

 If plastic parts are cleaned using unsuitable cleaning agents, the surfaces can be damaged.

Do not use cleaning agents that contain alcohol, solvents or abrasives to clean plastic parts. Even fly-remover pads or cleaning pads with hard surfaces can produce scratches.◀

Body panels

Clean the trim panels with water and BMW plastic care emulsion.

Windscreens and headlight lenses made of plastic

Clean off dirt and insects with a soft sponge and plenty of water.

 Soften stubborn dirt and insects by covering the affected areas with a wet cloth.◀

Chrome

Use plenty of water and BMW shampoo to clean chrome, particularly if it has been exposed to road salt. Use chrome polish for additional treatment.

Radiator

Clean the radiator regularly to prevent overheating of the engine due to inadequate cooling. For example, use a garden hose with low water pressure.



Cooling fins can be bent easily.

Take care not to bend the fins when cleaning the radiator.◀

Rubber

Treat rubber components with water or BMW rubber-care products.



Using silicone sprays for the care of rubber seals can cause damage.

Do not use silicone sprays or other care products that contain silicon.◀

Paint care

Washing the motorcycle regularly will help counteract the long-term effects of substances that damage the paint, especially if your motorcycle is ridden in areas with high air pollution or natural sources of dirt, for example tree resin or pollen.

Remove particularly aggressive substances immediately, however, as otherwise the paint can be affected or become discoloured. Substances of this nature include spilt fuel, oil, grease, brake fluid and bird droppings. We recommend BMW vehicle polish or BMW paint cleaner for this purpose.

Marks on the paintwork are particularly easy to see after the motorcycle has been washed. Remove stains of this kind immediately, using cleaning-grade benzene or petroleum spirit on a clean cloth or ball of cotton wool. BMW Motorrad recommends BMW tar remover for removing specks of tar. Remember to wax the parts treated in this way.

Protective wax coating

BMW Motorrad recommends applying only BMW car wax or products containing carnauba wax or synthetic wax.

It is time to re wax the paint-work when water "puddles" on the surface, instead of forming beads.

Laying up motorcycle

- Clean the motorcycle.
- Removing battery (➡ 114).
- Spray the brake and clutch lever pivots, the side stand pivots and the centre stand pivots (if the motorcycle is fitted with a centre stand) with a suitable lubricant.
- Coat bright metal and chrome-plated parts with an acid-free grease (e.g. Vaseline).
- Stand the motorcycle in a dry room in such a way that there is no load on either wheel.

Restoring motorcycle to use

- Remove the protective wax coating.
- Clean the motorcycle.
- Install a charged battery.
- Before starting: work through the checklist.

Technical data

troubleshooting chart	122
Threaded fasteners	123
Engine	125
Fuel.....	126
Engine oil	126
Clutch	127
Transmission	127
Rear-wheel drive.....	128
Running gear	128
Brakes	129
Wheels and tyres	129
Electrics	131
Frame	132
Dimensions	133
Weights.....	134

Riding specifications	134
-----------------------------	-----

troubleshooting chart

Engine does not start at all or is difficult to start.

Possible cause	Rectification
Kill switch activated	Kill switch in operating position (run).
Side stand extended and gear engaged	Retract the side stand.
Gear engaged and clutch not disengaged.	Select neutral or pull the clutch lever.
No fuel in tank	Refuelling (➡ 65).
Battery flat	Charge the battery when connected (➡ 113).

Threaded fasteners

Front wheel	FR	Valid
Brake caliper to fork leg		
M10 x 40	38 Nm	
Clamp of quick-release axle		
M8 x 25	19 Nm	
Quick-release axle, front, in axle holder		
M16 x 1.5	30 Nm	
Rear wheel	FR	Valid
Locknut of the final-drive chain tensioning screw		
M8	19 Nm	
Rear quick-release axle in swinging arm		
M16 x 1.5	100 Nm	

Mirror arm	FR	Valid
Locknut (mirror) to clamping piece		
M14 x 1	20 Nm	
Clamping piece (mirror) to clamping block		
M10	30 Nm	

Engine

Engine design	Two-cylinder four-stroke, DOHC with chain-and-sprocket drive, 4 valves operated by cam followers, balancing conrod, liquid-cooled cylinders and heads, integral water pump, 6-speed gearbox and dry sump lubrication
Displacement	798 cm ³
Cylinder bore	82 mm
Piston stroke	75.6 mm
Compression ratio	12 : 1
Nominal output	52 kW, at engine speed: 7000 min ⁻¹
– with power reduction ^{OE}	25 kW, at engine speed: 5000 min ⁻¹
Torque	75 Nm, at engine speed: 4500 min ⁻¹
– with power reduction ^{OE}	57 Nm, at engine speed: 3000 min ⁻¹
Maximum engine speed	max 9000 min ⁻¹
Idle speed	1250 ⁺⁵⁰ min ⁻¹

Fuel

Recommended fuel grade	Regular, unleaded 91 ROZ/RON 87 AKI
Usable fuel capacity	approx. 16 l
Reserve fuel	approx. 4 l

BMW recommends BP fuels



Engine oil

Engine oil, capacity	2.9 l, with filter change
viscosity classes recommended by BMW Motorrad	
SAE 10W-40	Engine oil for motorcycles with oil-bath clutch, API SG / SH / JASO MA ≥-20 °C
SAE 15W-40	Engine oil for motorcycles with oil-bath clutch, API SG / SH / JASO MA ≥-10 °C

BMW recommends 

Oil additives	BMW Motorrad recommends not using oil additives, because they can have a detrimental effect on clutch operation. Please do not hesitate to contact your authorised BMW Motorrad dealer if you have any questions relating the choice of a suitable engine oil for your motorcycle.
---------------	--

BMW recommends 

Clutch

clutch type	Multiplate clutch running in oil bath
-------------	---------------------------------------

Transmission

gearbox type	Claw-shift 6-speed gearbox, integrated into engine block
Gearbox transmission ratios	1.943 (35/68 teeth), Primary transmission ratio 1:2.462 (13/32 teeth), 1st gear 1:1.750 (16/28 teeth), 2nd gear 1:1.381 (21/29 teeth), 3rd gear 1:1.174 (23/27 teeth), 4th gear 1:1.042 (24/25 teeth), 5th gear 1:0.960 (25/24 teeth), 6th gear

Rear-wheel drive

Type of final drive	chain drive
Type of rear suspension	Two-arm cast-aluminium swinging arm
Number of teeth, rear-wheel drive (Pinion / sprocket)	17 / 41

Running gear

Front wheel

Type of front suspension	telescopic forks
Spring travel, front	180 mm, At wheel

Rear wheel

Type of rear suspension	Two-arm cast-aluminium swinging arm
Type of rear suspension	Direct-pivot central spring strut with steplessly adjustable rebound-stage damping
Spring travel at rear wheel	170 mm, At wheel
– with lowered suspension ^{OE}	135 mm, At wheel

Brakes

Front wheel

Type of front brake	Hydraulically operated disc brake with 2-piston floating caliper and fixed disc
Brake-pad material, front	Sintered metal

Rear wheel

Type of rear brake	Hydraulically operated disc brake with 1-piston floating caliper and fixed disc
Brake-pad material, rear	Organic material

Wheels and tyres

Recommended tyre sets	You can obtain an up-to-date list of approved tyres from your authorised BMW Motorrad dealer or on the Internet at " www.bmw-motorrad.com ".
-----------------------	--

Front wheel

front wheel type	Cast aluminium, MT H2
front wheel rim size	2.50" x 19"
Tyre designation, front	110 / 80 R 19

Rear wheel

rear-wheel type	Cast aluminium, MT H2
rear wheel rim size	3.50" x 17"
Tyre designation, rear	140 / 80 R 17

Tyre pressure

Tyre pressure, front	2.2 bar, one-up, at tyre temperature: 20 °C 2.4 bar, two-up and/or with luggage, at tyre temperature: 20 °C
Tyre pressure, rear	2.4 bar, one-up, at tyre temperature: 20 °C 2.8 bar, two-up and/or with luggage, at tyre temperature: 20 °C

Electrics

Electrical rating of on-board sockets	5 A
Fuses	Electronic fuses protect all the circuits. If an electronic fuse trips and de-energises a circuit, the circuit is active as soon as the ignition is switched on after the fault has been rectified.

Battery

battery type	AGM (Absorbent Glass Mat) battery
battery rated voltage	12 V
battery rated capacity	12 Ah

Spark plugs

Spark plugs, manufacturer and designation	NGK DCPR 8 E
Electrode gap of spark plug	0.8...0.9 mm, When new

Lighting

Bulb for high-beam headlight	H7 / 12 V / 55 W
Bulbs for the low-beam headlight	H7 / 12 V / 55 W
Bulb for parking light	W5W / 12 V / 5 W
Bulb for tail light/brake light	LED / 12 V
Maximum number of defective LEDs in rear-light unit	6, Brake light/rear light

Bulb for number-plate light	W5W / 12 V / 5 W
Bulbs for flashing turn indicators, front	R10W / 12 V / 10 W
– with white turn indicators ^{OE}	RY10W / 12 V / 10 W
– with LED turn indicators ^{OA}	LED / 12 V
Bulbs for flashing turn indicators, rear	R10W / 12 V / 10 W
– with white turn indicators ^{OE}	RY10W / 12 V / 10 W
– with LED turn indicators ^{OA}	LED / 12 V

Frame

Frame type	tubular spaceframe
type plate location	Steering head, front top
VIN location	Steering head, right

Dimensions

Length of motorcycle	2280 mm, across front wheel to number-plate carrier
Height of motorcycle	1240 mm, Without rider at unladen weight
Width of motorcycle	845 mm, across mirrors without mirrors
Front-seat height	820 mm, Without rider at unladen weight
– with dual seat, low ^{OE}	790 mm, Without rider at unladen weight
– without lowered suspension ^{OE}	
– with lowered suspension ^{OE}	765 mm, Without rider at unladen weight
rider's inside-leg arc, heel to heel	1810 mm
– with dual seat, low ^{OE}	1760 mm, Without rider at unladen weight
– without lowered suspension ^{OE}	
– with lowered suspension ^{OE}	

Weights

Unladen weight	199 kg, DIN unladen weight, ready for road, 90 % load of fuel
Permissible gross weight	436 kg
– with lowered suspension ^{OE}	349 kg
Maximum payload	237 kg
– with lowered suspension ^{OE}	150 kg

Riding specifications

Top speed	max 190 km/h
– with power reduction ^{OE}	max 147 km/h

Service

BMW Motorrad Service	136
BMW Motorrad Mobility services	136
Maintenance work	136
Confirmation of maintenance work	138
Confirmation of service	143

BMW Motorrad Service

BMW Motorrad has an extensive after-sales service network in place to look after you and your motorcycle in more than 100 countries. Authorised BMW Motorrad dealerships have the technical information and the technical know-how to carry out reliably all maintenance and repair work on your BMW.

Visit our website www.bmw-motorrad.com to find out where the nearest authorised BMW Motorrad dealership is located.



If maintenance and repair work is performed inexpertly, it could result in consequential damage and thus constitute a safety risk.

BMW Motorrad recommends you to have all the associated work on your motorcycle carried out by a specialist workshop, prefer-

ably an authorised BMW Motorrad dealer. ◀

In order to help ensure that your BMW is always in optimum condition, BMW Motorrad recommends compliance with the maintenance intervals specified for your motorcycle. Have all maintenance and repair work carried out confirmed in the "Service" chapter in this manual. For generous treatment of claims submitted after the warranty period has expired, evidence of regular maintenance is essential.

Your authorised BMW Motorrad dealer can provide information on BMW services and the work undertaken as part of each service.

BMW Motorrad Mobility services

As owner of a new BMW motorcycle, in circumstances in which assistance is required you can benefit from the protection afforded by the various BMW Motorrad mobility services (e.g. Mobile Service, breakdown service, vehicle recovery service). Your authorised BMW Motorrad dealer will be happy provide information about the mobility services available to you.

Maintenance work

BMW Pre-delivery Check

Your authorised BMW Motorrad dealer conducts the BMW pre-delivery check before handing over the motorcycle to you.

BMW Running-in Check

The BMW running-in check has to be performed when the motorcycle has covered between 500 km and 1200 km◀

BMW Service

The BMW Service is carried out once a year; the extent of servicing can vary, depending on the age of the motorcycle and the distance it has covered. Your authorised BMW Motorrad dealer confirms that the service work has been carried out and enters the date when the next service will be due.

Riders who cover long distances in a year might have to bring in their motorcycles for service before the next scheduled date. It is to allow for these cases that a maximum odometer reading is entered as well in the confirmation of service. Servicing has to be brought forward if this odo-

meter reading is reached before the next scheduled date for the service.

The service-due indicator in the multifunction display reminds you about one month or 1000 km in advance when the time for a service is approaching, on the basis of the programmed values.◀

Confirmation of maintenance work

BMW Pre-delivery Check

Completed

on _____

Stamp, signature

BMW Running-in Check

Completed

on _____

Odometer reading _____

Next service
at the latest

on _____

or, if logged beforehand,

Odometer reading _____

Stamp, signature

BMW Service

Completed

on _____

Odometer reading _____

Next service
at the latest

on _____

or, if logged beforehand,

Odometer reading _____

Stamp, signature

BMW Service

Completed

on _____

Odometer reading _____

Next service
at the latest

on _____

or, if logged beforehand,

Odometer reading _____

Stamp, signature

BMW Service

Completed

on _____

Odometer reading _____

Next service
at the latest

on _____

or, if logged beforehand,

Odometer reading _____

Stamp, signature

BMW Service

Completed

on _____

Odometer reading _____

Next service
at the latest

on _____

or, if logged beforehand,

Odometer reading _____

Stamp, signature**BMW Service**

Completed

on _____

Odometer reading _____

Next service
at the latest

on _____

or, if logged beforehand,

Odometer reading _____

Stamp, signature**BMW Service**

Completed

on _____

Odometer reading _____

Next service
at the latest

on _____

or, if logged beforehand,

Odometer reading _____

Stamp, signature

BMW Service

Completed

on _____

Odometer reading _____

Next service
at the latest

on _____

or, if logged beforehand,

Odometer reading _____

Stamp, signature

BMW Service

Completed

on _____

Odometer reading _____

Next service
at the latest

on _____

or, if logged beforehand,

Odometer reading _____

Stamp, signature

BMW Service

Completed

on _____

Odometer reading _____

Next service
at the latest

on _____

or, if logged beforehand,

Odometer reading _____

Stamp, signature

BMW Service

Completed

on _____

Odometer reading _____

Next service
at the latest

on _____

or, if logged beforehand,

Odometer reading _____

Stamp, signature**BMW Service**

Completed

on _____

Odometer reading _____

Next service
at the latest

on _____

or, if logged beforehand,

Odometer reading _____

Stamp, signature**BMW Service**

Completed

on _____

Odometer reading _____

Next service
at the latest

on _____

or, if logged beforehand,

Odometer reading _____

Stamp, signature

Confirmation of service

The table is intended as a record of maintenance and repair work, the installation of optional accessories and, if appropriate, special campaign (recall) work.

Item	Odometer reading	Date

- A**
Abbreviations and symbols, 6
ABS
 Control, 16
 Engineering details, 70
 Operation, 46
 Self-diagnosis, 60
 Warnings, 33
Accessories
 General instructions, 76
Air filter
 Installation, 111
 Position on the motorcycle, 15
 Removal, 111
Ambient temperature
 Ice warning, 32
 Reading, 26
Anti-theft alarm
 Telltale light, 18
 Warnings, 32
Average values
 Resetting, 41
- B**
Battery
 Charging battery when connected, 113
 Charging battery when disconnected, 114
 Installation, 115
 Maintenance instructions, 113
 Position on the motorcycle, 15
 Removal, 114
 Technical data, 131
Brake fluid
 Checking fluid level, front, 90
 Checking fluid level, rear, 91
 Reservoir, front, 13
 Reservoir, rear, 13
Brake pads
 Checking front, 89
 Checking rear, 89
 Running in, 61
Brakes
 Adjusting handlebar lever, 47
 Checking operation, 88
 Safety instructions, 63
 Technical data, 129

- Bulbs
 Replacing high-beam headlight bulb, 104
 Replacing low-beam headlight bulb, 104
 Replacing number-plate light bulbs, 108
 Replacing side-light bulb, 105
 Replacing the brake light and rear light bulbs, 107
 Replacing turn indicator bulbs, 107
 Technical data, 131
 Warning for bulb failure, 31

- C**
Case
 Operation, 77
Chain
 Adjusting sag, 95
 Checking sag, 95
 Checking wear, 96
 Lubricating, 95
Checklist, 58

- Clock
 - Adjusting, 39
 - Control, 18
- Clutch
 - Adjusting handlebar lever, 47
 - Adjusting play, 94
 - Checking operation, 93
 - Checking play, 93
 - Technical data, 127
- Confirmation of maintenance work, 138
- Coolant
 - Checking fill level, 92
 - Fill-level indicator, 13
 - Topping up, 93
 - Warning for overtemperature, 30
- Currency, 7
- D**
 - Damping
 - Adjuster, 13
 - Adjusting, 50
 - Dimensions
 - Technical data, 133
- E**
 - Electrics
 - Technical data, 131
 - Emergency off switch (kill switch), 17
 - Operation, 45
 - Engine
 - Starting, 59
 - Technical data, 125
 - Warning for engine electronics, 31
 - Engine oil
 - Checking fill level, 87
 - Filler neck, 11
 - Oil dipstick, 11
 - Technical data, 126
 - Topping up, 88
 - Warning for engine oil pressure, 31
 - Equipment, 7
- F**
 - First-aid kit
 - Stowage, 14
 - Frame
 - Technical data, 132
- Front-wheel stand
 - Installing, 103
- Fuel
 - Filler neck, 13
 - Refuelling, 65
 - Technical data, 126
- Fuel reserve
 - Distance covered, 25
 - Warning, 30
- Fuses
 - Technical data, 131
- G**
 - General views
 - Instrument panel, 18
 - Left handlebar fitting, 16
 - Left side of motorcycle, 11
 - Multifunction display, 22
 - Right handlebar fitting, 17
 - Right side of motorcycle, 13
 - Underneath the seat, 14
 - Underneath the trim panel, 15
 - Warning and telltale lights, 24
 - Grip heating
 - Control, 17
 - Operation, 45

H

Hazard warning flashers

Control, 16, 17

Operation, 44

Headlight

Adjusting headlight beam throw, 52

Beam throw, 51

Driving on right/driving on left, 51

Helmet holder

Helmet, securing, 53

Position on the motorcycle, 14

Horn, 16

I

Ignition

Switching off, 38

Switching on, 38

Immobiliser

Reserve key, 39

Warning, 30

Instrument panel

Ambient-light brightness sensor, 18

Overview, 18

J

Jump starting, 111

K

Keys, 38

L

Lights

Control, 16

Headlight flasher, operating, 43

High-beam headlight, operating, 43

Low-beam headlight, 43

Parking lights, operating, 43

Side light, 43

Lowered suspension

Restrictions, 56

Luggage

Instructions for loading, 56

lashing, 77

M

Maintenance

General instructions, 86

Maintenance intervals, 136

Mirrors

Adjusting, 48

Mobility services, 136

Motorcycle

care, 117

Cleaning, 117

Lashing, 66

Laying up, 120

Parking, 64

Restoring to use, 120

Multifunction display, 18

Control, 16

Meaning of symbols, 23

Overview, 22

Selecting readings, 40

multifunction switch

General view, left side, 16

General view, right side, 17

O

Odometer and tripmeters

Control, 18

Resetting, 41

Off-roading, 62

P

- Parking, 64
- Power socket
 - Notes on use, 76
 - Position on the motorcycle, 11
- Pre-ride check, 60

R

- Rear-wheel drive
 - Technical data, 128
- Redline warning
 - Switching on, 61, 62
 - Warning light, 18
- Refuelling, 65
- Rev. counter, 18
- Rider's Manual
 - Position on the motorcycle, 14
- Running gear
 - Technical data, 128
- Running in, 61

S

- Safety instructions
 - for brake, 63
 - for riding, 56

Seat

- Installation, 52
- Lock, 11
- Removal, 52
- Service, 136
- Service-due indicator, 25
- Spark plugs
 - Technical data, 131
- Speedometer, 18
- Spring preload
 - Adjuster, 13
 - Adjusting, 49
 - Tools, 14
- Starting, 59
 - Control, 17
- Steering lock
 - Locking, 38
- Stopwatch
 - Operation, 41
- Symbols
 - Meaning, 23

T

- Technical data
 - Battery, 131
 - Brakes, 129
 - Bulbs, 131
 - Clutch, 127
 - Dimensions, 133
 - Electrics, 131
 - Engine, 125
 - Engine oil, 126
 - Frame, 132
 - Fuel, 126
 - Rear-wheel drive, 128
 - Running gear, 128
 - Spark plugs, 131
 - Standards, 7
 - Transmission, 127
 - Weights, 134
 - Wheels and tyres, 129
- Telltale lights
 - Overview, 24
- Toolkit
 - Contents, 86
 - Position on the motorcycle, 14

- topcase
 - Operation, 80
- Torques, 123
- Transmission
 - Technical data, 127
- Trim panels
 - Installing centre trim panel, 110
 - Removing centre trim panel, 109
- troubleshooting chart, 122
- Turn indicators
 - Control, left, 16
 - Control, right, 17
 - Operation, 44
- Type plate
 - Position on the motorcycle, 13
- Tyre pressure monitoring RDC
 - Adhesive label for rim, 97
 - Engineering details, 72
 - Reading, 26
 - Warnings, 33
- Tyres
 - Checking inflation pressure, 50
 - Checking tread depth, 94
 - Pressures, 130

- Recommendation, 97
- Running in, 61
- Table of tyre pressures, 14
- Technical data, 129

V

- Vehicle identification number
 - Position on the motorcycle, 13

W

- Warning lights
 - Overview, 24
- Warnings
 - ABS, 33
 - Anti-theft alarm, 32
 - Bulb defect, 31
 - Coolant temperature, 30
 - Engine electronics, 31
 - Engine oil pressure, 31
 - Fuel reserve, 30
 - Ice warning, 32
 - Immobiliser, 30
 - Mode of presentation, 26
 - RDC, 33
- Warnings, overview, 28

- Weights
 - Payload table, 14
 - Technical data, 134
- Wheels
 - Change of size, 97
 - Checking rims, 94
 - Install the rear wheel, 101
 - Installing front wheel, 99
 - Remove the rear wheel, 100
 - Removing front wheel, 98
 - Technical data, 129

Details described or illustrated in this booklet may differ from the motorcycle's actual specification as purchased, the accessories fitted or the national-market specification. No claims will be entertained as a result of such discrepancies.

Dimensions, weights, fuel consumption and performance data are quoted to the customary tolerances.

The right to modify designs, equipment and accessories is reserved.

Errors and omissions excepted.

© 2011 BMW Motorrad

Not to be reproduced either wholly or in part without written permission from BMW Motorrad, After Sales.

Printed in Germany.

Important data for refuelling

Fuel

Recommended fuel grade	Regular, unleaded 91 ROZ/RON 87 AKI
------------------------	---

Usable fuel capacity	approx. 16 l
----------------------	--------------

Reserve fuel	approx. 4 l
--------------	-------------

Tyre pressure

Tyre pressure, front	2.2 bar, one-up, at tyre temperature: 20 °C 2.4 bar, two-up and/or with luggage, at tyre temperature: 20 °C
----------------------	--

Tyre pressure, rear	2.4 bar, one-up, at tyre temperature: 20 °C 2.8 bar, two-up and/or with luggage, at tyre temperature: 20 °C
---------------------	--

BMW recommends 

Order No.: 01 41 8 525 241
09.2011, 4th edition

<http://www.motorcycle.in.th>

