

Rider's Manual

K 1600 GT



BMW Motorrad



The Ultimate
Riding Machine

Motorcycle data/dealership details

Motorcycle data

Model

Vehicle identification number

Colour code

Date of first registration

Registration number

Dealership details

Person to contact in Service department

Ms/Mr

Phone number

Dealership address/phone number (company stamp)

Welcome to BMW

We congratulate you on your choice of a motorcycle from BMW and welcome you to the community of BMW riders.

Familiarise yourself with your new motorcycle so that you can ride it safely and confidently in all traffic situations.

Please read this Rider's Manual carefully before starting to use your new BMW motorcycle. It contains important information on how to operate the controls and how to make the best possible use of all your BMW's technical features.

In addition, it contains information on maintenance and care to help you maintain your motorcycle's reliability and safety, as well as its value.

If you have questions concerning your motorcycle, your authorised

BMW Motorrad dealer will gladly provide advice and assistance.

We hope that you will enjoy riding your BMW and that all your journeys will be pleasant and safe.

BMW Motorrad.

Table of Contents

You can also consult the index at the end of this Rider's Manual if you want to find a particular topic or item of information.

1 General instructions 5

Overview 6

Abbreviations and symbols 6

Equipment 7

Technical data 7

Currency 7

2 General views 9

General view, left side 11

General view, right side 13

Handlebar fitting, left 14

Handlebar fitting, right 16

Underneath the seat 17

Instrument panel 18

3 Status indicators 21

Multifunction display 22

Meaning of symbols 23

Range 24

Ambient temperature 24

Tyre pressures 24

Oil level 25

Service-due indicator 25

Warning and telltale

lights 27

Warnings 28

4 Operation 43

Ignition switch/steering

lock 44

Electronic immobiliser

EWS 45

Multifunction display 46

On-board computer 50

Odometer and

tripmeters 51

Lights 52

Turn indicators 54

Hazard warning flashers 55

Emergency off switch (kill

switch) 55

Grip heating 56

Seat heating 56

Dynamic Traction Control

DTC 58

Ride mode 59

Front seat 60

Windscreen 61

slipstream deflector 62

Cruise-control system 63

Stowage compartments 65

Clutch 65

Brakes 66

Mirrors 66

Spring preload 66

Damping 67

Electronic Suspension Ad-

justment ESA 68

Central locking 69

Anti-theft alarm (DWA) 73

Tyres 77

5 Riding 79

Safety instructions 80

Checklist 82

Starting 82

Running in 84

Brakes 85

Parking your motorcycle 86

Refuelling 87

Securing motorcycle for transportation	88	Clutch	120	Transmission	148
6 Engineering details	91	Rims and tyres	121	Rear-wheel drive	149
Ride mode	92	Wheels	122	Running gear	149
Brake system with BMW		Front-wheel stand	128	Brakes	150
Motorrad Integral ABS	93	Jump starting	130	Wheels and tyres	151
Electronic engine manage-		Bulbs	131	Electrics	152
ment with BMW Motorrad		Battery	134	Anti-theft alarm	154
DTC	96	Fuses	137	Frame	155
Tyre pressure monitoring		9 Care	139	Dimensions	155
RDC	98	Care products	140	Weights	156
Electronic Suspension Ad-		Washing motorcycle	140	Riding specifications	156
justment ESA II	99	Cleaning easily damaged		11 Service	157
7 Accessories	101	components	140	BMW Motorrad service	158
General instructions	102	Paint care	141	BMW Motorrad service	
Power sockets	102	Protective wax coating ...	142	quality	158
Navigation device	103	Laying up motorcycle	142	BMW Motorrad mobility	
Cases	106	Restoring motorcycle to		services - roadside assist-	
Topcase	108	use	142	ance	158
8 Maintenance	113	10 Technical data	143	BMW Motorrad service	
General instructions	114	troubleshooting chart	144	network	159
Toolkit	114	Threaded fasteners	145	Maintenance work	159
Engine oil	114	Engine	146	Confirmation of mainten-	
Brake system	116	Fuel	147	ance work	160
Coolant	120	Engine oil	147	Confirmation of service	165
		Clutch	148	12 Index	167

General instructions

Overview	6
Abbreviations and symbols	6
Equipment	7
Technical data	7
Currency	7

Overview

Chapter 2 of this Rider's Manual will provide you with an initial overview of your motorcycle. All maintenance and repair work on the motorcycle is documented in Chapter 11. This record of the maintenance work you have had performed on your motorcycle is a precondition for generous treatment of goodwill claims.

When the time comes to sell your BMW, please remember to hand over this Rider's Manual; it is an important part of the motorcycle.

Abbreviations and symbols



Indicates warnings that you must comply with for reasons of your safety and the safety of others, and to protect your motorcycle against damage.

 Specific instructions on how to operate, control, adjust or look after items of equipment on the motorcycle.

◀ Indicates the end of an item of information.

• Instruction.

» Result of an activity.

 Reference to a page with more detailed information.

◁ Indicates the end of a passage relating to specific accessories or items of equipment.



Tightening torque.



Item of technical data.

OE Optional extra
The motorcycles are assembled complete with all the BMW optional extras originally ordered.

OA Optional accessory
You can obtain optional accessories through your authorised BMW Motorrad dealer; optional accessories have to be retrofitted to the motorcycle.

EWS Electronic immobiliser.

DWA Anti-theft alarm (Diebstahlwarnanlage)

ABS Anti-lock brake system

DTC Dynamic Traction Control.

ESA Electronic Suspension Adjustment
Electronic Suspension Adjustment.

RDC Tyre pressure monitoring (ReifenDruck-Control)

Equipment

When you ordered your BMW motorcycle, you chose various items of custom equipment. This Rider's Manual describes optional extras (OE) offered by BMW and selected optional accessories (OA). This explains why the manual may also contain descriptions of equipment which you have not ordered. Please note, too, that your motorcycle might not be exactly as illustrated in this manual on account of country-specific differences. If your BMW was supplied with equipment not described in this Rider's Manual, you will

find these features described in separate manuals.

Technical data

All dimensions, weights and power ratings stated in the Rider's Manual are quoted to the standards and comply with the tolerance requirements of the Deutsches Institut für Normung e.V. (DIN). Versions for individual countries may differ.

Currency

The high safety and quality standards of BMW motorcycles are maintained by constant development work on designs, equipment and accessories. Because of this, your motorcycle may differ from the information supplied in the Rider's Manual. Nor can BMW Motorrad entirely rule out errors and omissions. We hope you will appreciate that no claims can be entertained on







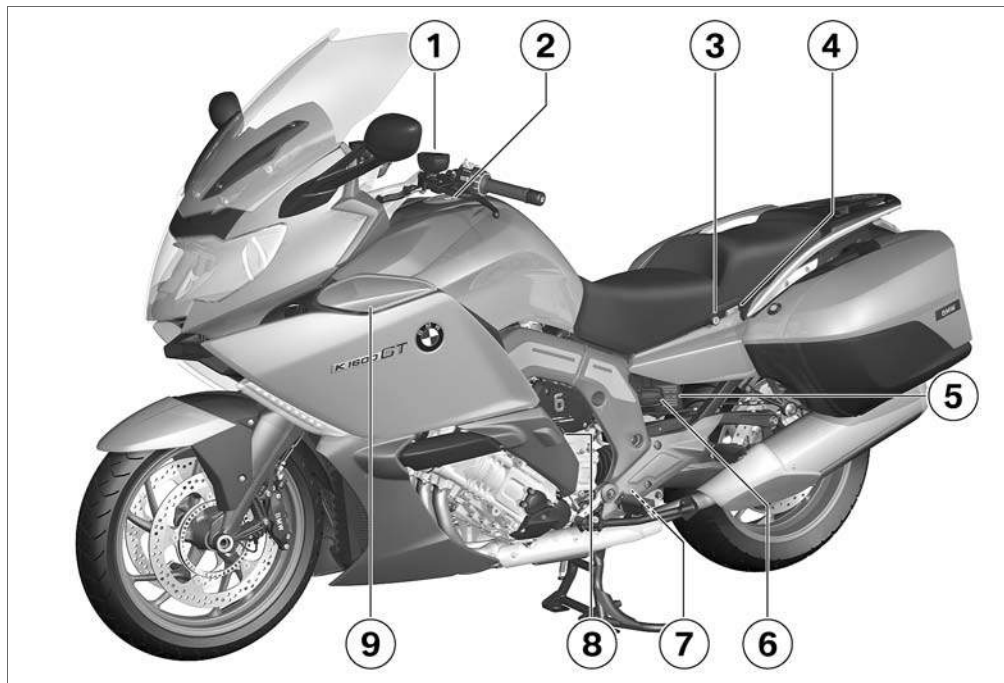

the basis of the data, illustrations or descriptions in this manual.

General views

General view, left side.....	11
General view, right side	13
Handlebar fitting, left.....	14
Handlebar fitting, right	16
Underneath the seat	17
Instrument panel.....	18



General view, left side

- 1 Clutch-fluid reservoir
( 120)
- 2 Fuel filler neck ( 87)
- 3 Seat lock ( 60)
- 4 Rear seat heating control
(on rear seat) ( 57)
- 5 Payload table
Table of tyre pressures
- 6 Adjuster, spring preload
( 67)
- 7 Adjuster for damping characteristic ( 67)
- 8 Storage compartment
( 65)
- 9 slipstream deflector
( 62)

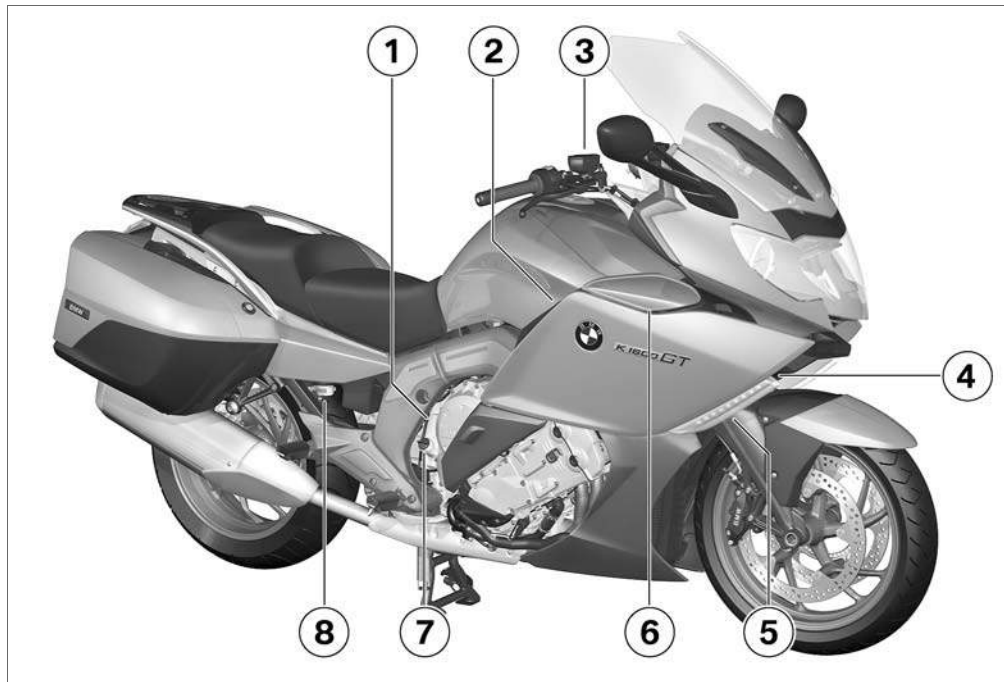

General view, right side

- 1** Vehicle Identification Number (above engine oil filler neck)
- 2** Power socket (➡ 102)
- 3** Brake-fluid reservoir, front (➡ 118)
- 4** Coolant level indicator (behind side panel) (➡ 120)
- 5** Type plate (on front suspension)
- 6** slipstream deflector (➡ 62)
- 7** Engine-oil filler neck and oil dipstick (➡ 114)
- 8** Brake-fluid reservoir, rear (➡ 119)

Handlebar fitting, left

- 1 High-beam headlight and headlight flasher (→ 52)
- 2 – with auxiliary headlight^{OA}
Operation of the auxiliary headlights (→ 53)
- 3 Cruise control system control (→ 63)
- 4 Hazard warning flashers (→ 55)
- 5 Windscreen control (→ 61)
- 6 Operation of the flashing turn indicators (→ 54)
- 7 Horn

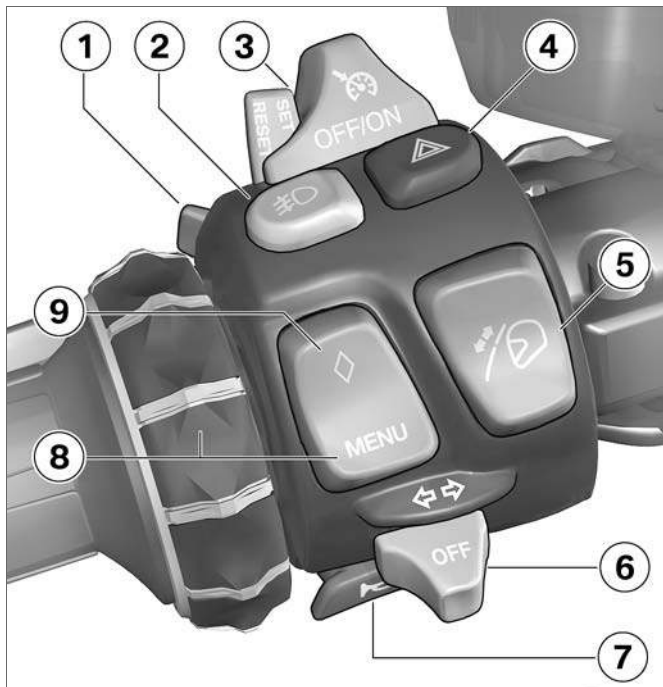

- 8** Multi-controller and MENU button
Operation of the multifunction display (►► 46)
– with Dynamic Traction Control (DTC)^{OE}
Control for DTC (►► 58)
– with Electronic Suspension Adjustment (ESA)^{OE}
Operating ESA (►► 68)
– with audio system with preparation for navigation device^{OE}
Operation of the audio system (see the appropriate instructions for use)
- 9** Select the favourite menu. (►► 49).

Handlebar fitting, right

- 1 – with central locking^{OE}
Operation of the central locking system (➔ 69)
- 2 Selection of the ride mode (➔ 59)
- 3 Emergency off switch (kill switch) (➔ 55)
- 4 Starting engine (➔ 82)



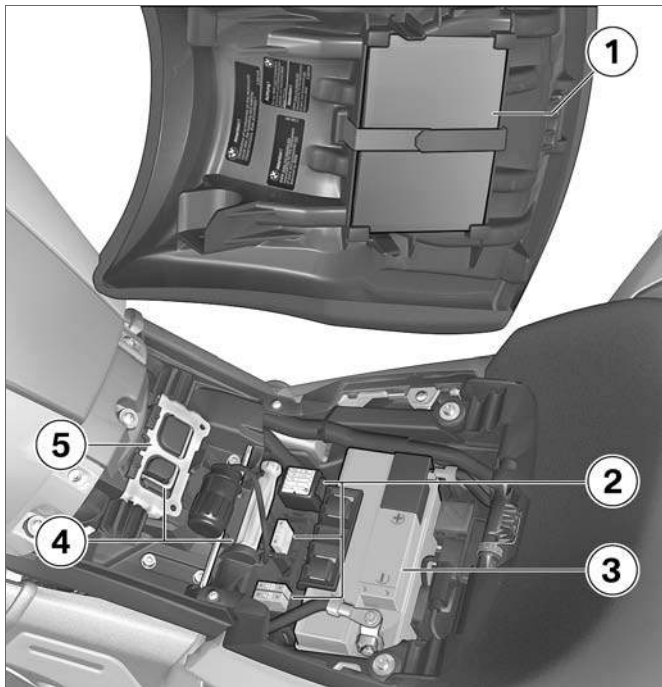

Underneath the seat

- 1 Rider's Manual
- 2 Fuses (➔ 137)
- 3 Battery (➔ 134)
- 4 Toolkit (➔ 114)
- 5 Seat-height adjustment (➔ 61)

Instrument panel

- 1 Speedometer
- 2 Trimmer
 - with preparation for navigation device^{OE}
- 3 Warning and telltale lights (➔ 27)
- 4 – with preparation for navigation device^{OE}
 - with navigation system^{OA}
- 5 Ambient-light brightness sensor (for adapting the brightness of the instrument lighting)
- 6 Rev. counter
- 7 Control for tripmeters (➔ 51)
- 8 Multifunction display (➔ 22)

 The brightness of the warning lights and telltale lights, the display and the instrument needle and gauge lighting is ad-

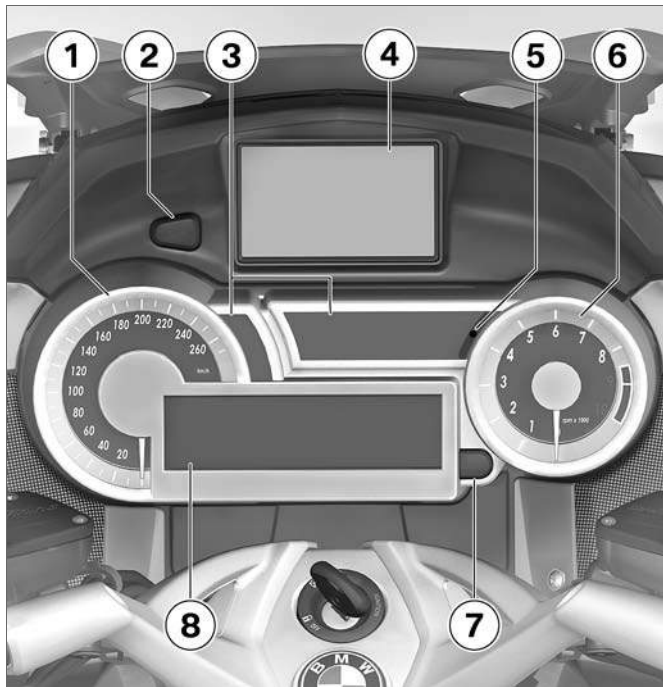

apted automatically to suit ambient brightness. ◀

Status indicators

Multifunction display	22
Meaning of symbols	23
Range	24
Ambient temperature	24
Tyre pressures.....	24
Oil level	25
Service-due indicator	25
Warning and telltale lights.....	27
Warnings	28

Multifunction display

- 1 Ride mode (➡ 59)
- 2 Coolant temperature
- 3 Area for warnings (➡ 28)
- 4 Menu area (➡ 46)
 - with audio system with preparation for navigation device^{OE}
 - Area for messages relating to the audio system
- 5 Status-indicator panel of the on-board computer (➡ 50)
 - with tyre pressure monitoring (RDC)^{OE}
 - RDC readings
- 6 Status indicators for seat heating (➡ 56)
 - Status indicators for handlebar grip heating (➡ 56)
 - with Electronic Suspension Adjustment (ESA)^{OE}
 - ESA settings
- 7 Tripmeter (➡ 51)

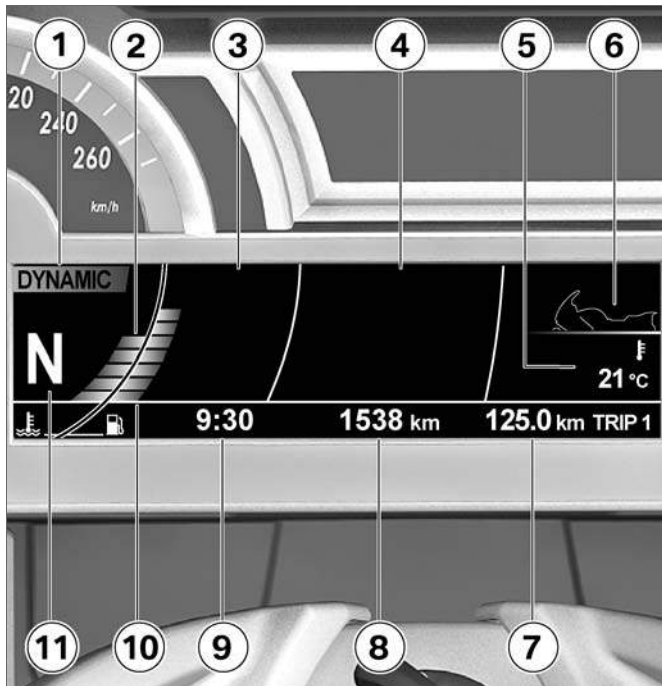





- 8** Total distance covered
- 9** Clock (➡ 49)
- 10** Fuel level
- 11** Gear indicator; "N" indicates neutral

Meaning of symbols



Meanings of the symbols at position **1**:

-  Average consumption 1 and 2 since last reset (➡ 50)
-  Range with fuel now on board (➡ 24)
-  Average speed since last reset (➡ 50)
-  Ambient temperature (➡ 24)

 Tyre pressures (➡ 24)

 Stopwatch (➡ 51)

 Travel times (➡ 51)

 Date (display mode depends on the time format selected) (➡ 49)

 Oil level (➡ 25)

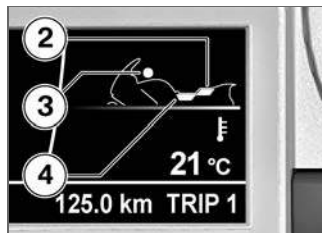

- 2** Rear-seat heating ON
- 3** Handlebar grip heating ON
- 4** Front-seat heating ON

– with Electronic Suspension Adjustment (ESA)^{OE}



5 Damping

6 Vehicle load◀

Range

 The range readout indicates how far you can ride with the fuel remaining in the tank. The figure for average consumption used to calculate range is not shown and might not be the same as the average-consumption reading that appears on the display.

You must put at least five litres of

fuel into the fuel tank for the new level to be registered correctly. If the sensor cannot register the new level the range readout cannot be updated.

When the motorcycle is propped on its side stand the slight angle of inclination means that the sensor cannot register the fuel level correctly. This is the reason why the range is calculated only when the side stand is in the retracted position.

 The calculated range is only an approximate reading.

Consequently, BMW Motorrad recommends that you should not try to use the full range before refuelling.◀

Ambient temperature

 When the motorcycle is at a standstill the heat of the engine can falsify the ambient-temperature reading. If the effect

of the engine's heat becomes excessive, – temporarily appears on the display.

 If ambient temperature drops below 3 °C this warning appears, drawing your attention to the risk of black ice forming. The display automatically switches from any other mode to the temperature reading when the temperature drops below this threshold for the first time.◀

Tyre pressures

– with tyre pressure monitoring (RDC)^{OE}

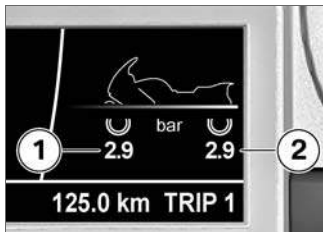

The tyre-pressure readings are based on a reference tyre temperature of 20 °C. The front tyre pressure is on the left **1**; the reading on the right **2** is the rear tyre pressure. "– – –" appears directly after the ignition is switched on, because the sensors do not transmit tyre pressures until the first time the motorcycle accelerates to more than 30 km/h.◀

If the pressure in a tyre drops to a critical level the corresponding status indicator shows red.



The tyre warning symbol also appears on the display.



The "General" warning light flashes red.

The detailed description of BMW Motorrad RDC starts on page (➔ 98).

Oil level



The oil-level indicator gives you an indication of the engine oil level.

The preconditions for the oil level check are as follows:

- Engine at operating temperature.
- Engine idling for at least ten seconds.
- Side stand retracted.
- Make sure the motorcycle is upright.

The readings mean:

OK: Oil level is correct

CHECK !: Check the oil level the next time you stop for fuel.

– – -: Oil level cannot be measured (conditions as stated above not satisfied).

Service-due indicator



If a service is due, for a brief period after the pre-ride check the service symbol appears on the display and the service-due date shows instead of the odometer reading.



If the service is overdue the General warning light briefly shows yellow and the service symbol lights up continuously.



If the countdown to the next service is less than one month, service-due date **1** appears on the display.



If the motorcycle covers long distances in the course of the year, under certain circumstances it

might be necessary to have it serviced at a date in advance of the forecast due date. If the countdown distance to the early service is less than 1000 km, countdown distance **2** appears on the display.

▶ If the service-due indicator appears more than a month before the service date, the date saved in the instrument cluster must be adjusted. This situation can occur if the battery was disconnected.◀

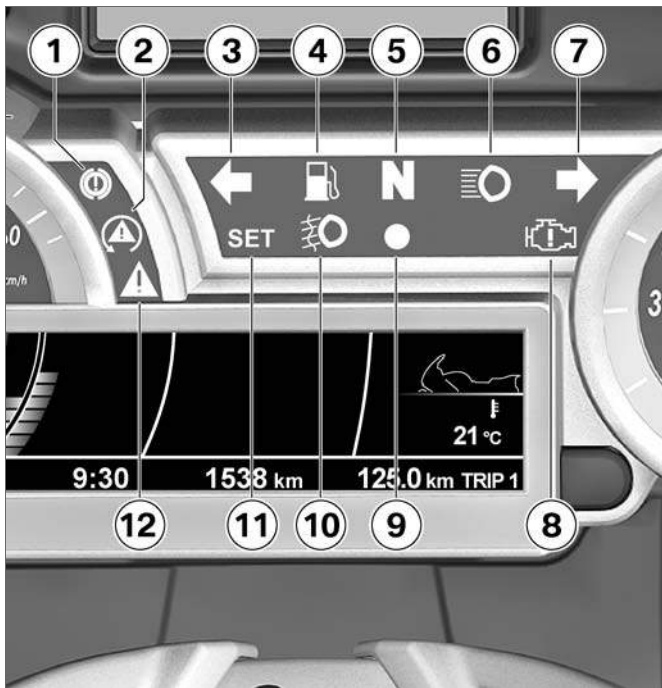

Warning and telltale lights

- 1 ABS warning light (►► 36)
- 2 – with Dynamic Traction Control (DTC) ^{OE}
DTC warning light (►► 37)
- 3 Telltale light of the left turn indicators
- 4 Warning light for fuel down to reserve (►► 33)
- 5 Telltale light for neutral
- 6 High-beam headlight telltale light
- 7 Telltale light of the right turn indicators
- 8 Warning light for engine electronics
- 9 – with anti-theft alarm (DWA) ^{OE}
Anti-theft alarm telltale light (►► 73)
- 10 – with auxiliary headlight ^{OA}
Telltale light for the auxiliary headlights (►► 53)

- 11** Telltale light of cruise control (➡ 63)
- 12** General warning light, in combination with warnings in the display (➡ 28)

Warnings

Mode of presentation

Warnings are indicated by the corresponding warning lights.

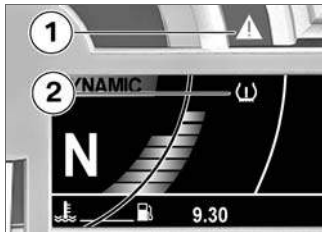

Warnings for which there is no dedicated warning light are indicated by 'General' warning light **1** showing in combination with a warning symbol such as, for example, **2** appearing in the multifunction display. The 'General' warning light shows red or yellow, depending on the urgency of the warning.

Up to four warning symbols can be displayed at any given time. The status of the 'General' warning light matches the most urgent warning. The possible warnings are listed on the next pages.

Warnings, overview

Warning light

Status indicators

Meaning



Lights up yellow



Appears on the display

Electronic immobiliser active (→ 33)



Lights up

Fuel-level reading turns yellow

Fuel down to reserve (→ 33)



Lights up red

Temperature reading turns red

Coolant temperature too high (→ 33)



Lights up

Engine fault (→ 33)



Flashes

Severe engine fault (→ 34)



Appears on the display

Engine-oil level too low (→ 34)



Lights up red















Appears on the display

Insufficient battery charge current (→ 34)



Appears on the display













On-board system voltage low (→ 35)

Warning light	Status indicators	Meaning
 Lights up yellow	 Appears on the display	On-board system voltage critical (→ 35)
 Lights up yellow	 Appears on the display	Rear light failure (→ 35)
 Lights up yellow	 Appears on the display	Front light failure (→ 36)
 Lights up yellow	 Appears on the display	Light failure (→ 36)
	 Appears on the display	Ice warning (→ 36)
 Flashes		ABS self-diagnosis not completed (→ 36)
 Lights up		ABS fault (→ 36)
 Quick-flashes		DTC intervention (→ 37)
 Slow-flashes		DTC self-diagnosis not completed (→ 37)







Warning light

Status indicators

Meaning

 Lights up		DTC switched off (➡ 37)
 Lights up		DTC fault (➡ 37)
 Flashes red	 + tyre pressure in red	Tyre pressure outside permitted tolerance (➡ 38)
	 + "--" or "--" appears on the display.	Signal transmission disrupted (➡ 38)
 Lights up yellow	 + "--" or "--" appears on the display.	Sensor defective or system error (➡ 39)
 Lights up yellow	 Appears on the display	Battery of tyre-pressure sensor weak (➡ 39)
 Lights up red	 Appears on the display	Light direction of the low-beam headlight not known (➡ 40)
 Lights up yellow	 Appears on the display	Beam-throw adjustment of the low-beam headlight restricted (➡ 40)

Warning light**Status indicators****Meaning**

		 Appears on the display	Headlight aiming changed (→ 40)
		 Appears on the display	Anti-theft alarm battery weak (→ 41)
	Lights up yellow	 Appears on the display	Anti-theft alarm battery flat (→ 41)
		 Appears on the display	Central locking locked (→ 41)
	briefly shows yellow	 Appears on the display	Service overdue (→ 41)

Electronic immobiliser active



General warning light shows yellow.



Key appears on the display.

Possible cause:

The key being used is not authorised for starting, or communication between key and engine electronics is disrupted.

- Remove all other vehicle keys from the same ring as the ignition key.
- Use the reserve key.
- Have the defective key replaced, preferably by an authorised BMW Motorrad dealer.

Fuel down to reserve



Reserve-fuel symbol lights up

Fuel-level reading turns yellow.



Lack of fuel can result in the engine misfiring and cutting out unexpectedly. Misfiring can damage the catalytic converter; a hazardous situation can result if the engine cuts out unexpectedly.

Do not run the fuel tank dry.◀

Possible cause:

The fuel tank contains no more than the reserve quantity of fuel.

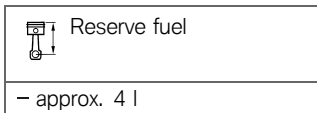

- Refuel (➔ 87).

Coolant temperature too high



General warning light shows red.

The temperature reading turns red.



Continuing to ride when the engine is overheated could result in engine damage. Compliance with the information set out below is essential.◀

Possible cause:

The coolant temperature is too high.

- If possible, ride in the part-load range to cool down the engine.
- In traffic jams, switch off the engine, but leave the ignition switched on so that the radiator fan continues to operate.
- If the coolant temperature is frequently too high, have the fault rectified as soon as possible by a specialist workshop, preferably an authorised BMW Motorrad dealer.

Engine fault



The engine symbol lights up.

Possible cause:

The engine control unit has diagnosed a fault.



The engine is running in emergency operating mode. Unusual engine response is a possibility.

Adapt your style of riding accordingly. Avoid accelerating sharply and overtaking.◀

- If you continue to ride be prepared for unusual engine behaviour (low power, poor throttle response, abrupt stalling, etc.)
- Have the fault rectified as quickly as possible by a specialist workshop, preferably an authorised BMW Motorrad dealer.

Severe engine fault



The engine symbol flashes.

Possible cause:

The engine control unit has diagnosed a severe fault.



An engine fault that can lead to severe consequential damage has been detected. Adapt your style of riding accordingly. Ride slowly, avoid accelerating and overtaking. If possible, have the motorcycle picked up.◀

- If you continue to ride be prepared for unusual engine behaviour (low power, poor throttle response, abrupt stalling, etc.)
- Have the fault rectified as quickly as possible by a specialist workshop, preferably an authorised BMW Motorrad dealer.

Engine-oil level too low



The oil can symbol appears on the display.

Possible cause:

The electronic oil-level sensor has registered an excessively low oil level. Check the engine-oil level with the dipstick the next time you stop to refuel:

- Check the engine oil level (➡ 114).

If the oil level is too low:

- Top up the engine oil (➡ 115).

Insufficient battery charge current



General warning light shows red.



The battery symbol appears on the display.



A discharged battery can render various systems unavailable, for example the lights, the engine or the ABS. This can result in dangerous situations. If possible, do not continue your journey.◀

Battery is not being charged. If you continue to ride the motorcycle the on-board electronics will drain the battery.

Possible cause:

Alternator or alternator drive defective

- Have the fault rectified as quickly as possible by a specialist workshop, preferably an authorised BMW Motorrad dealer.

On-board system voltage low



The split battery symbol appears on the display. Generator power is only just sufficient to supply all consumers and charge the battery.

Possible cause:

Too many consumers switched on. On-board system voltage tends to drop particularly at low

engine rpm and when the engine is idling.

- When riding at low engine rpm switch off consumers that are not necessary for road safety (e.g. heated body warmer or auxiliary headlights).

On-board system voltage critical



General warning light shows yellow.



The split battery symbol appears on the display.

Generator power is no longer sufficient to supply all consumers and charge the battery. In order to ensure that the engine can be started and the motorcycle ridden, the on-board electronics switch off the electricity supply to the on-board sockets and the auxiliary headlights. In extreme cases the seat heating and the

grip heating might also be shut down.

Possible cause:

Too many consumers switched on. On-board system voltage tends to drop particularly at low engine rpm and when the engine is idling.

- When riding at low engine rpm switch off consumers that are not necessary for road safety (e.g. heated body warmer or auxiliary headlights).

Rear light failure



General warning light shows yellow.



Bulb symbol with arrow pointing to the rear appears on the display.

Possible cause:

Rear light, brake light or rear flashing turn indicator defective.

- The LED rear light must be replaced. Consult a specialist

workshop, preferably an authorised BMW Motorrad dealer.

Front light failure



General warning light shows yellow.



Bulb symbol with arrow pointing to the front appears on the display.

Possible cause:

Low-beam headlight, high-beam headlight, parking light or front flashing turn indicator defective.

- Consult a specialist workshop, preferably an authorised BMW Motorrad dealer, if the low-beam headlight or an LED turn indicator requires replacement.
- Replacing high-beam headlight bulb (➔ 131).

Light failure



General warning light shows yellow.



Bulb symbol with two arrows appears on the display.

Possible cause:

A combination of light failures has occurred.

- Consult a specialist workshop, preferably an authorised BMW Motorrad dealer.

Ice warning



The ice-crystal symbol appears on the display.

Possible cause:

The air temperature measured at the motorcycle is lower than 3 °C.



The ice warning does not mean that there is no risk of black ice forming at measured temperatures above 3 °C.

Always take extra care when temperatures are low; remember that the danger of black ice form-

ing is particularly high on bridges and where the road is in shade.◀

- Ride carefully and think well ahead.

ABS self-diagnosis not completed



ABS warning light flashes.

Possible cause:

Self-diagnosis did not complete, so the ABS function is not available. The motorcycle must be ridden at a speed of at least 5 km/h in order for ABS self-diagnosis to complete.

- Pull away slowly. Bear in mind that the ABS function is not available until self-diagnosis has completed.

ABS fault



ABS warning light shows.

Possible cause:

The ABS control unit has detected a fault. The ABS function is not available.

- You can continue to ride the motorcycle, but make due provision for the fact that the ABS function is not available. Bear in mind the more detailed information on situations that can lead to an ABS fault (➡ 95).
- Have the fault rectified as quickly as possible by a specialist workshop, preferably an authorised BMW Motorrad dealer.

DTC intervention

– with Dynamic Traction Control (DTC) ^{OE}



DTC warning light quick-flashes.

The DTC has detected a degree of instability at the rear wheel and has intervened to reduce

torque. The warning light flashes for longer than DTC intervention lasts. This affords the rider visual feedback on control intervention even after the critical situation has been dealt with.

DTC self-diagnosis not completed

– with Dynamic Traction Control (DTC) ^{OE}



DTC warning light slow-flashes.

Possible cause:

Self-diagnosis did not complete, so the DTC function is not available. The engine must be running and the motorcycle must reach a speed of at least 5 km/h in order for DTC self-diagnosis to complete.

- Pull away slowly. Bear in mind that the DTC function is not available until self-diagnosis has completed.

DTC switched off

– with Dynamic Traction Control (DTC) ^{OE}



DTC warning light shows.

Possible cause:

The rider has switched off the DTC system.

- Switch on DTC.

DTC fault

– with Dynamic Traction Control (DTC) ^{OE}



DTC warning light shows.

Possible cause:

The DTC control unit has detected a fault. The DTC function is not available.

- You can continue to ride. Bear in mind that the DTC function is not available. Bear in mind the more detailed information

on situations that can lead to a DTC fault (➔ 97).

- Have the fault rectified as quickly as possible by a specialist workshop, preferably an authorised BMW Motorrad dealer.

Tyre pressure outside permitted tolerance

– with tyre pressure monitoring (RDC)^{OE}



General warning light flashes red.



+ the critical tyre pressure shows red.

Possible cause:

Measured tyre pressure is outside permitted tolerance.

- Check the tyre for damage and to ascertain whether the motorcycle can be ridden with the tyre in its present condition.

If the motorcycle can be ridden with the tyre in its present condition:



Incorrect tyre pressures impair the motorcycle's handling characteristics.

If tyre pressure is incorrect it is essential to adapt your style of riding accordingly.◀

- Correct the tyre pressure at the earliest possible opportunity.



Before you adjust tyre pressure, read the information on temperature compensation and adjusting pressure in the section entitled "Engineering details".◀

- Have the tyre checked for damage by a specialist workshop, preferably an authorised BMW Motorrad dealer.

If you are unsure whether the motorcycle can be ridden with the tyre in its present condition:

- Do not continue your journey.
- Notify the breakdown service.

Signal transmission disrupted

– with tyre pressure monitoring (RDC)^{OE}



+ "---" or "--- ---" appears on the display.

Possible cause:

The motorcycle has not yet accelerated past the threshold of approximately 30 km/h. The RDC sensors do not start transmitting signals until the motorcycle reaches a speed above this threshold for the first time (➔ 98).

- Increase speed above this threshold and observe the RDC readings. Assume that a permanent fault has not occurred unless the 'General' warning light comes on to accompany

the symptoms. Under these circumstances:

- Have the fault rectified by a specialist workshop, preferably an authorised BMW Motorrad dealer.

Possible cause:

Wireless communication with the RDC sensors has been disrupted. Possible causes include radio-communication systems operating in the vicinity and interfering with the link between the RDC control unit and the sensors.

- Move to another location and observe the RDC readings. Assume that a permanent fault has not occurred unless the 'General' warning light comes on to accompany the symptoms. Under these circumstances:
- Have the fault rectified by a specialist workshop, preferably

an authorised BMW Motorrad dealer.

Sensor defective or system error

- with tyre pressure monitoring (RDC)^{OE}



General warning light shows yellow.



+ "--" or "-- --" appears on the display.

Possible cause:

Motorcycle is fitted with wheels not equipped with RDC sensors.

- Fit wheels and tyres equipped with RDC sensors.

Possible cause:

One or two RDC sensors have failed.

- Have the fault rectified by a specialist workshop, preferably

an authorised BMW Motorrad dealer.

Possible cause:

A system error has occurred.

- Have the fault rectified by a specialist workshop, preferably an authorised BMW Motorrad dealer.

Battery of tyre-pressure sensor weak

- with tyre pressure monitoring (RDC)^{OE}



General warning light shows yellow.



The RDC battery symbol appears on the display.

▶ This error message appears only briefly after the pre-ride check completes.◀

Possible cause:

The integral battery in the tyre-pressure sensor has lost a significant proportion of its original capacity. There is no assurance of how long the tyre pressure control system can remain operational.

- Seek the advice of a specialist workshop, preferably an authorised BMW Motorrad dealer.

Light direction of the low-beam headlight not known



General warning light shows red.



Headlight with question mark appears on the display.

Illumination of the road ahead is no longer optimum; there is a possibility of dazzling oncoming traffic.

Possible cause:

Light direction and range of the low-beam headlight are unknown, adjustment is no longer possible.

- If it is dark leave the motorcycle where it is or have it picked up, if possible.
- Have the defect rectified as quickly as possible by a specialist workshop, preferably an authorised BMW Motorrad dealer.

Beam-throw adjustment of the low-beam headlight restricted



General warning light shows yellow.



Headlight with zero appears on the display.

Illumination of the road ahead is no longer optimum.

Possible cause:

Only restricted adjustment of light direction and range of the low-beam headlight possible.

- Have the defect rectified by a specialist workshop, preferably an authorised BMW Motorrad dealer.

Headlight aiming changed

– with Adaptive Headlight ^{OE}



appears on the display.

Corning light control for the low-beam headlight is switched off.

Possible cause:

Headlight alignment has been changed from the as-delivered condition.

- Adjust for traffic driving on right or driving on left (→ 53).

Anti-theft alarm battery weak

– with anti-theft alarm (DWA)^{OE}



The anti-theft alarm battery symbol appears on the display.

 This error message appears only briefly after the pre-ride check completes. ◀

Possible cause:

The integral battery in the anti-theft alarm has lost a significant proportion of its original capacity. There is no assurance of how long the anti-theft alarm can remain operational if the motorcycle's battery is disconnected.

- Seek the advice of a specialist workshop, preferably an authorised BMW Motorrad dealer.

Anti-theft alarm battery flat

– with anti-theft alarm (DWA)^{OE}



General warning light shows yellow.



The anti-theft alarm battery symbol appears on the display.

 This error message appears only briefly after the pre-ride check completes. ◀

Possible cause:

The integral battery in the anti-theft alarm has lost its entire original capacity. There is no assurance that the anti-theft alarm will be operational if the motorcycle's battery is disconnected.

- Seek the advice of a specialist workshop, preferably an authorised BMW Motorrad dealer.

Central locking locked

– with central locking^{OE}



The locked symbol appears on the display.

All locks in the central locking system are locked.

Service overdue



appears on the display.



General warning light briefly shows yellow after the pre-ride check.

Possible cause:

A necessary service has not been carried out.

- Have servicing carried out as quickly as possible by a specialist workshop, preferably an authorised BMW-Motorrad dealer.

Operation

Ignition switch/steering lock	44	Windscreen	61
Electronic immobiliser EWS.....	45	slipstream deflector	62
Multifunction display	46	Cruise-control system	63
On-board computer.....	50	Stowage compartments	65
Odometer and tripmeters	51	Clutch	65
Lights.....	52	Brakes	66
Turn indicators.....	54	Mirrors	66
Hazard warning flashers.....	55	Spring preload	66
Emergency off switch (kill switch).....	55	Damping.....	67
Grip heating.....	56	Electronic Suspension Adjustment ESA	68
Seat heating	56	Central locking.....	69
Dynamic Traction Control DTC	58	Anti-theft alarm (DWA).....	73
Ride mode	59	Tyres	77
Front seat.....	60		

Ignition switch/steering lock

Keys

You receive two master keys and one spare key. Please consult the information on the electronic immobiliser (EWS) if a key is lost or mislaid (► 45).

Ignition switch/steering lock, tank filler cap lock, stowage compartment, seat lock and cases are all operated with the same key.

– with topcase ^{OA}

If you wish you can arrange to have the topcase fitted with a lock that can be opened with the same key. Consult a specialist workshop, preferably an authorised BMW Motorrad dealer.◁

Switching on ignition

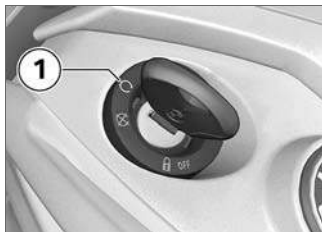

- Turn the key to position **1**.
 - » Parking lights and all function circuits switched on.
 - » Engine can be started.
 - » Pre-ride check is performed. (► 83)
 - » ABS self-diagnosis is performed. (► 83)
- with Dynamic Traction Control (DTC) ^{OE}
 - » DTC self-diagnosis is performed. (► 84)

Switching off ignition



- Turn the key to position **2**.
 - » Lights switched off.
 - » Handlebars not locked.
 - » Key can be removed.
 - » The windscreen automatically moves to the bottom limit position.

Locking handlebars



If the motorcycle is on the side stand, the surface of the ground will determine whether it is better to turn the handlebars to the left or right. However, the motorcycle is more stable on

a level surface with the handlebars turned to the left than with the handlebars turned to the right.

On level ground, always turn the handlebars to the left to set the steering lock.◀

- Turn the handlebars to the full left or right lock position.



- Turn the key to position **3**, while moving the handlebars slightly.
 - » Ignition, lights and all function circuits switched off.
 - » Handlebars locked.

» Key can be removed.

Electronic immobiliser EWS

The on-board electronics access the data saved in the ignition key via a ring aerial in the ignition lock. The ignition is not enabled for starting until the engine control unit has recognised the key as "authorised" for your motorcycle.

▶ A spare key attached to the same ring as the ignition key used to start the engine could "irritate" the electronics, in which case the enabling signal for starting is not issued. The EWS warning appears in the multifunction display.

Always keep the spare key separately from the ignition key.◀

If you mislay a key you can have the key in question barred by your authorised BMW Motorrad dealer. In order to have a key barred you must bring along all the other keys belonging to the motorcycle.

The engine cannot be started by a barred key, but a key that has been barred can subsequently be reactivated.

You can obtain replacement/extra keys only through an authorised BMW Motorrad dealer. The keys are part of an integrated security system, so the dealer is under an obligation to check the legitimacy of all applications for replacement/extra keys.

Multifunction display

Selecting menu

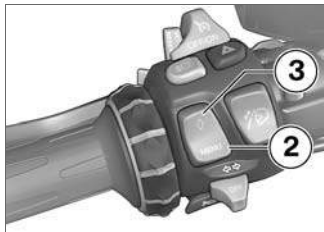

Press button **2** to step through the sequence of menus, starting with the **Info** menu. Each time you press button **2** you call up the next menu in the sequence; the number of menus depends on the options fitted to the motorcycle.

You also have the option of pressing button **3** for direct access to a favourite menu of your choice.

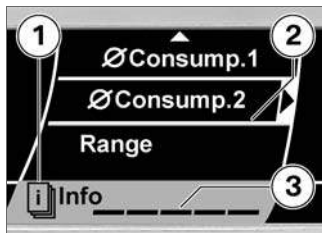

The type of menu shows at position **1**; cursor **2** indicates the current selection. Each line **3** indicates a menu that can be selected. The line representing the menu you are currently viewing is greyed to show you where you are in the sequence of menus.

▶ See the separate Quick Reference Guide for an overview of all menus.◀

Selecting menu item

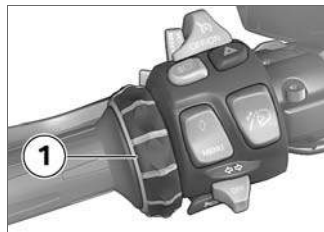

Use multi-controller **1** to move the cursor in a menu.

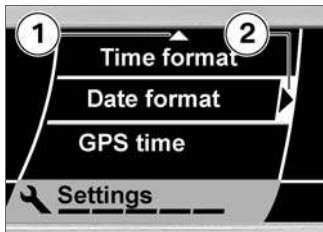

An arrow **1** at the top or bottom of the display indicates that there are other items in this menu that you can view by turning the multi-controller in the corresponding direction. If arrow **2** appears in the cursor, you can call up a submenu by pressing the multi-controller to the right (for information on the different meaning in relation to average values and list selections, see (►► 47)).

Setting parameters

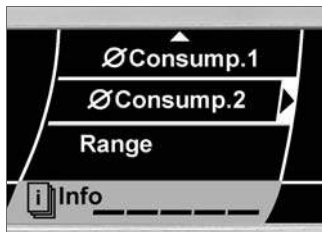

Direct selection:

If you move the cursor to a menu item that requires no other settings, your selection goes active right away.

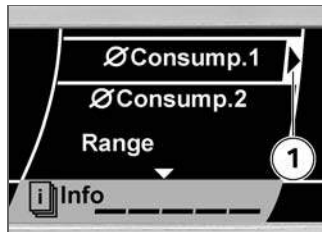

Resetting values:

You can reset average values marked with an arrow **1** by long-pressing the multi-controller to the right.

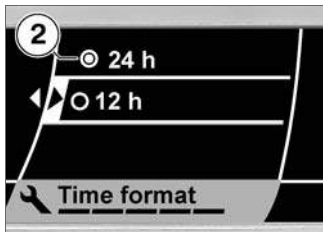

Selecting from a list:

A circle **2** beside each selectable item means that the items are part of a selection list. A circle with a dot indicates the item that is currently selected.

If you want to change the selection move the cursor to some other item in the list and press the multi-controller to the right to either activate or deactivate the parameter you selected.

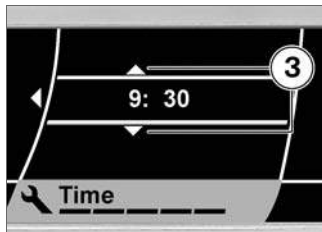

Setting numerical values:

If there are one or more numerical values between the arrows **3**, you can increase the values by turning the multi-controller up or reduce the values by turning the multi-controller down. You can toggle between the values by pressing the multi-controller to the right or left.

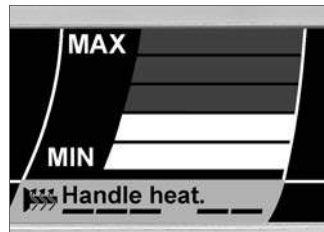

Setting relative values:

A bar indicator enables you to set a value in a range between two limits. Turn the multi-controller up to increase the setting or down to reduce the setting.

Exiting menu

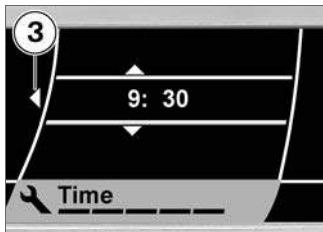

Arrow **3** appears when you are in a submenu.

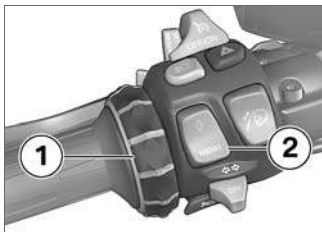



Press multi-controller **1** to the left to return to the next highest menu; press MENU button **2** to return to the main menu.

If you want to hide the menus, press multi-controller **1** to the left in a main menu.

Selecting favourite menu

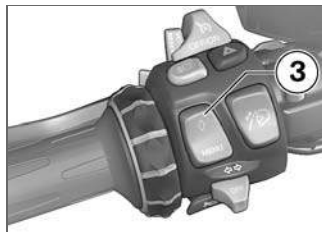
- Select the main menu of your choice.



- Press and hold down button **3**.
 The lozenge appears to the right of the menu designation.

» The menu you have selected will subsequently be called up whenever you press button **3**.

Adapting mode of presentation

- Switch on the ignition.
- Call up the Settings menu and select User.

The settings you can choose are as follows:

- Language: Display language (German, English, Spanish, Italian, French, Dutch, Portuguese)
- Time format -
Time format: Clock in 12-hour format (12 h) or in 24-hour format (24 h)
- Time format -
Date format: Date in day . month . year format (dd . mm . yy) or in month / day / year format (mm / dd / yy)
- Time format -
GPS time: Accept GPS time and GPS date from the built-in navigation system (On), (Off)
- Brightness: Brightness of the display and the instruments
- Start logo: Show start logo after the ignition is switched on (On), (Off)
- Initial state: Restore factory defaults (when

Reset ! appears on the display press the multi-controller to the right and hold in this position)

- Use the multi-controller to select your preferred settings.

On-board computer

Selecting readings

- Call up the Info menu and select the item of information of your choice.



The following items of information can be displayed in panel **3**:

- ØConsump . 1: Average consumption 1
- ØConsump . 2: Average consumption 2
- Range: Range with fuel remaining in fuel tank
- ØSpeed: Average speed
- Temperature: Ambient temperature
- Tire pressure: Tyre pressures
- Stopwatch: Stopwatch
- Travel times: Travel times
- Date: Current date
- Oil level: Engine-oil level
- Off: No reading

Resetting average values

- Call up the Info menu and select the average value you want to reset.
- Push the multi-controller to the right and hold it in this position until the average value is reset.

Operating stopwatch

- Call up the Info menu and select Stopwatch.

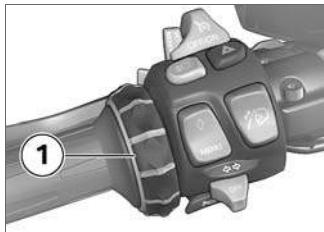

- With the stopwatch stopped, push multi-controller **1** to the right to start the stopwatch.
 - » The stopwatch continues timing even if you select some other reading or switch off the ignition.
- With the stopwatch running, push multi-controller **1** to the right to stop the stopwatch.

- Push multi-controller **1** to the right and hold it in this position to reset the stopwatch.

Measuring travel times

- Call up the Info menu and select Travel times.

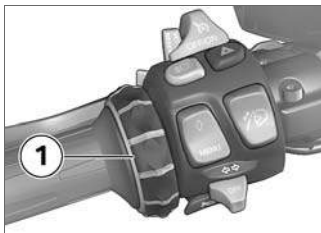

- Push multi-controller **1** to the right and hold it in this position to reset the travel time.
 - » Timing continues even if you select some other reading or switch off the ignition.

- ▶ Time during which the motorcycle was on the move since the last reset.

- ▮ Time during which the motorcycle was at a standstill since the last reset.

Odometer and tripmeters

Selecting odometer

- Switch on the ignition.

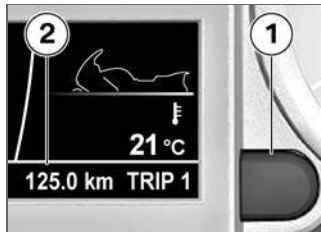

- Press button **1** to select tripmeter **2** of your choice. The following counters can be displayed:

- Tripmeter 1 (Trip 1)
- Tripmeter 2 (Trip 2)

- Automatic trip meter (Trip A, resets automatically eight hours after ignition OFF)

Resetting tripmeter

- Switch on the ignition.
- Select the desired tripmeter.

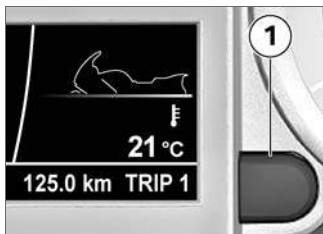

- Press and hold down button **1** until the tripmeter reading is reset.

Lights

Side light

The side lights switch on automatically when the ignition is switched on.

▶ The side lights place a strain on the battery.

Do not switch the ignition on for longer than absolutely necessary. ◀

Low-beam headlight

The low-beam headlight switches on automatically when you start the engine.

High-beam headlight



- Push switch **1** forward to switch on the high-beam headlight.
- Pull switch **1** back to operate the headlight flasher.

▶ The high-beam headlight can also be switched on when the engine is not running. ◀

Parking light

- Switch off the ignition.

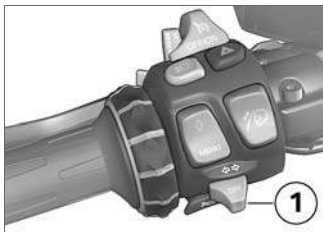

- Immediately after switching off the ignition, push button **1** to the left and hold it in this position until the parking lights come on.
- Switch the ignition on and off again to switch off the parking lights.

Adjusting for traffic driving on right or driving on left

– with Adaptive Headlight ^{OE}

- Switch on the ignition.

- Call up the Settings menu and select Vehicle - Headlamp.



- R-hand traffic: for countries in which the traffic drives on the right-hand side of the road.
- L-hand traffic: for countries in which the traffic drives on the left-hand side of the road.
- Select the appropriate setting.



appears on the display.

- » The cornering light function is not active for as long as the setting is changed.

Beam throw

The xenon headlight has continuous beam throw control that keeps beam throw constant regardless of how the motorcycle is ridden and the load it carries.

Operating auxiliary headlights

- with auxiliary headlight ^{OA}

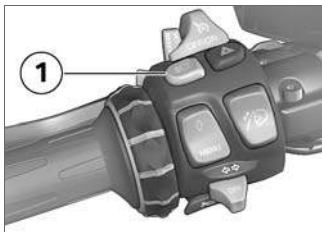

- Press button **1** to switch on the auxiliary headlights.



The telltale light shows.



If this warning symbol appears it tells you that the on-board system voltage is low. If applicable, the auxiliary headlights might have been temporarily switched off.

- Press button **1** again to switch off the auxiliary headlights.

Operating ground lighting

– with ground lighting^{OA}

- Switch on the ignition.
- Call up the **Settings** menu and select **Vehicle - Ground light**.

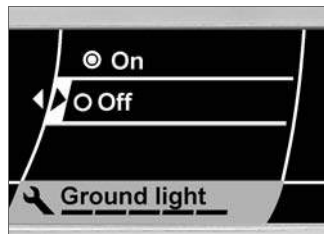

- **On**: Ground lighting comes on for a brief period after the ignition is switched off.
- **Off**: Ground lighting does not come on after the ignition is switched off.

– with central locking^{OE}

» If the function is switched off as described above, the ground lighting switches on nonetheless when you unlock the central locking system.

Turn indicators

Operating flashing turn indicators

- Switch on the ignition.



The turn indicators are cancelled automatically after you have ridden for approximately 10 seconds and covered a distance of about 300 m.◀

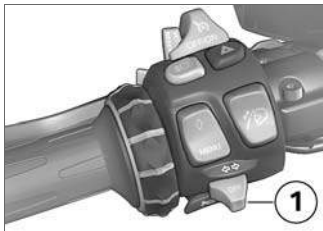

- Push button **1** to the left to switch on the left flashing turn indicators.
- Push button **1** to the right to switch on the right flashing turn indicators.
- Centre button **1** to cancel the flashing turn indicators.

Hazard warning flashers

Operating hazard warning flashers

- Switch on the ignition.

▶ The hazard warning flashers place a strain on the battery. Do not use the hazard warning flashers for longer than absolutely necessary. ◀◀

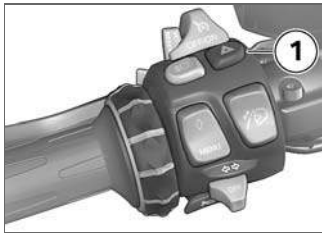

- Press button **1** to switch on the hazard warning flashers.
 - » Ignition can be switched off.
- Press button **1** again to switch off the hazard warning flashers.

Emergency off switch (kill switch)



- 1** Emergency off switch (kill switch)

! Operating the kill switch when riding can cause the rear wheel to lock and thus cause a fall. Do not operate the kill switch when riding. ◀

The emergency off switch is a kill switch for switching off the engine quickly and easily.



- a** Engine switched off
b Normal operating position (run)

Grip heating

Operating grip heating

- Start the engine.

 Grip heating can be activated only when the engine is running. ◀

- Call up the **Handle heat.** menu.

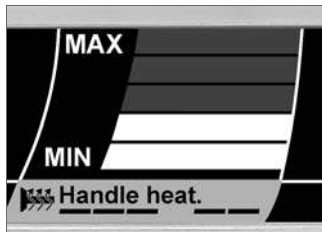

The grips have five-stage heating. Stage five is for heating the grips quickly: it is advisable to switch back to a lower stage as soon as the grips are warm.

- Select the heating stage you want.

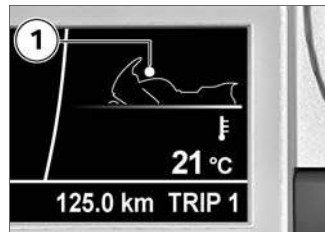

Symbol **1** appears on the display, indicating that the handlebar grip heating is ON.



If this warning symbol appears it tells you that the on-board system voltage is low. If applicable, the handlebar grip heating might have been temporarily switched off.

Seat heating

Front-seat heating

- Start the engine.

▶ Seat heating can be activated only when the engine is running.◀

- Call up the Seat heating menu.

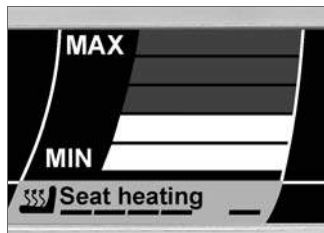

The front seat has five-stage heating. Stage five is for heating the seat quickly: it is advisable to switch back to a lower stage as soon as the seat is warm.

- Select the heating stage you want.

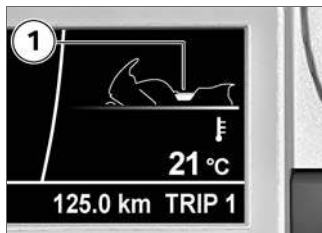

Symbol **1** appears on the display, indicating that the seat heating is ON.



If this warning symbol appears it tells you that the on-board system voltage is low. If applicable, the seat heating might have been temporarily switched off.

Rear-seat heating

- Start the engine.

▶ Seat heating can be activated only when the engine is running.◀

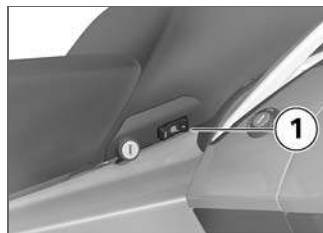

- Set switch **1** to the desired heating stage.

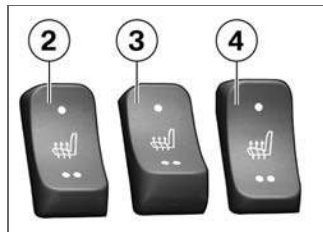

The rear seat has two-stage heating. Stage two is for heating the seat quickly: it is advisable to

switch back to stage one as soon as the seat is warm.

- **2** Switch centred: Heating off.
- **3** One-dot section of switch pressed: 50 % heating power.
- **4** Two-dot section of switch pressed: 100 % heating power.

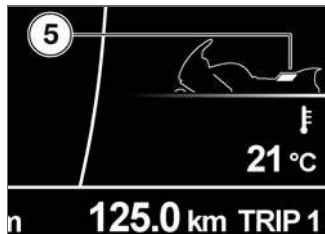

Symbol **5** appears on the display, indicating that the rear seat heating is ON.

 If this warning symbol appears it tells you that the on-board system voltage is low. If applicable, the seat heating

might have been temporarily switched off.

Dynamic Traction Control DTC

- with Dynamic Traction Control (DTC) ^{OE}

Switching DTC off and on

- Switch on the ignition.
- Call up the **Settings** menu and select DTC.

 This menu cannot be called up while the motorcycle is on the move. ◀



- Select **Off (once)** to switch DTC off once, in other words until the ignition is next switched on.

 The DTC warning light shows to indicate that DTC has been switched off.

- Select **On** to switch on DTC. Alternatively: Switch the ignition off and then on.

 DTC warning light goes out; if self-diagnosis has not completed the DTC warning light starts flashing.

Ride mode

Setting riding mode

- Switch on the ignition.



- Press button **1**.

▶ See the section entitled "Engineering details" for more information on the various ride modes that can be selected.◀



The current setting is shown at position **2**; each time the button is pressed one of the possible riding modes is shown at position **3**.

- Repeatedly press the button until the reading shows the riding mode you want.
 - » With the motorcycle at a standstill, the mode you select is activated after a brief delay.
 - » The newly selected riding mode is activated as you ride only when the following preconditions are satisfied:
 - Brake not applied

- Throttle twistgrip in fully closed position
- Clutch pulled
 - » Once the new riding mode has been activated, the selection display disappears.
 - » The mode selected in this way is retained with the engine-characteristic and DTC adaptation settings even after the ignition has been switched off.

Front seat

Removing front seat

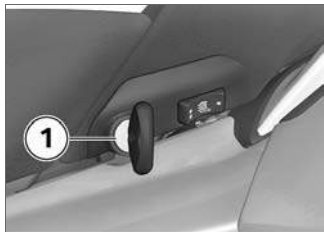

- Use the ignition key to unlock seat lock **1** and lift the rear of the front seat.



- Disconnect plug **2** of the seat heating and remove the front seat.
- Place the seat, upholstered side down, on a clean surface.

Installing front seat



- Connect plug **2** of the seat heating.

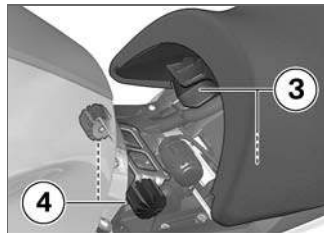

- Position the front seat with mounts **3** in rubber buffers **4** on left and right.

- Lower the rear of the front seat and engage the seat in the latching mechanism.

Adjusting front-seat height

- Remove the front seat. (→ 60).



- Pull latch **1** to the rear and remove adjusting plate **2**.



- Turn the adjusting plate to position **A** for the lower seat height.
- Turn the adjusting plate to position **B** for the higher seat height.

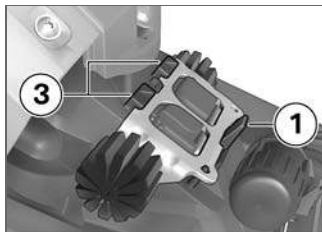

- Insert the adjusting plate in the desired position into mounts **3** and then push it into latch **1**.
- Install the front seat (→ 60).

Windscreen

Adjusting windscreen

- Switch on the ignition.
 - » When you pull away the windscreen automatically returns to the position it was in before the ignition was switched off.

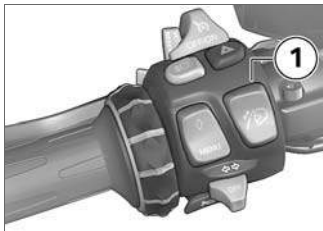

- Press top section of button **1** to raise the windscreen.
- Press bottom section of button **1** to lower the windscreen.
- Switch off the ignition.
 - » The windscreen automatically moves to the bottom limit position.
 - » If the windscreen encounters resistance before it reaches its limit position the pressure-sensitive finger guard system goes active. The windscreen is stopped and raised slightly. After a delay of a few seconds the windscreen again attempts

to move to the bottom limit position.

There is no guarantee that the pressure-sensitive finger guard system will function correctly if a windscreen that does not have BMW approval is installed.

- Under these circumstances: Before switching off the ignition always check that there is nothing to obstruct movement of the windscreen.

slipstream deflector

Adjusting slipstream deflectors

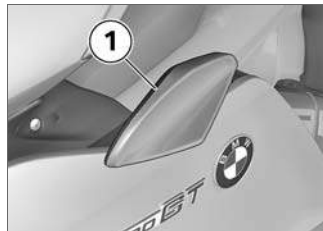

! Attempting to adjust the slipstream deflectors while the motorcycle is being ridden can lead to accidents. Do not attempt to adjust the slipstream deflectors unless the motorcycle is at a standstill. ◀

- Turn slipstream deflector **1** in or out to adjust the airflow for the rider. In this process, note the outer limit stop.

Cruise-control system

Switching on cruise control



- Slide switch **1** to the right.
- » Button **2** is operational.

Saving road speed



- Briefly push button **2** forward.

▶ Cruise control can be set within a speed range from 30 km/h to 220 km/h.◀

SET Telltale light for cruise control shows.

- » The motorcycle maintains your current cruising speed and the setting is saved.

Accelerating



- Briefly push button **2** forward.
 - » Speed is increased by approx. 1 km/h each time you push the button.◀
- Push button **2** forward and hold it in this position.
 - » The motorcycle accelerates steplessly.
 - » The current speed is maintained and saved if button **2** is not pushed again.

Decelerating



- Briefly push button **2** back.
 - » Speed is reduced by approx. 1 km/h each time you push the button.◀
- Push button **2** back and hold it in this position.
 - » The motorcycle decelerates steplessly.
 - » The current speed is maintained and saved if button **2** is not pushed again.

Deactivating cruise control

- Brake, pull the clutch lever or turn the throttle twistgrip (close the throttle by turning the twistgrip back past the idle position) to deactivate the cruise-control system.
 - » Telltale light for cruise-control goes out.

Resuming former cruising speed



- Briefly push button **2** back to return to the speed saved beforehand.

▶ Opening the throttle does not deactivate the cruise-control system. If you release the twistgrip the motorcycle will decelerate only to the cruising speed saved in memory, even though you might have intended slowing to a lower speed.◀

SET Telltale light for cruise control shows.

Switching off cruise control



- Slide switch **1** to the left.
 - » The system is deactivated.
 - » Button **2** is disabled.

Stowage compartments

Operating the stowage compartment



- Use the ignition key to open or close lock **1** of the stowage compartment.
 - To open the lid, push the unlocked lock barrel down.
- with preparation for audio system and navigation device^{OE}
- The description applies by analogy to the stowage compartment on the right side.<

 Temperatures inside the stowage compartments can be high, particularly in summer, and it is important to remember that high temperatures might damage objects stowed in the compartments. This applies in particular to electronic devices such as mobile phones and MP3 players.

Refer to the operating instructions of your electronic devices device for possible usage restrictions.<

- In summer, do not place heat-sensitive objects in the stowage compartments.

Clutch

Adjusting clutch lever

 Changing the position of the clutch-fluid reservoir can allow air to penetrate the clutch system.

Do not turn the handlebar fitting on the handlebar.<

 Attempting to adjust the clutch lever while riding the motorcycle can lead to accidents. Do not attempt to adjust the clutch lever unless the motorcycle is at a standstill.<



- Turn adjusting screw **1** clockwise to increase the span between the clutch lever and the handlebar grip.
- Turn adjusting screw **1** counter-clockwise to reduce the span between the clutch lever and the handlebar grip.

▶ The adjusting screw is easier to turn if you push the clutch lever forward.◀

▶ The anti-hopping function of the clutch can cause the clutch lever to pulsate briefly in some situations (e.g. variation of load).◀

Brakes

Adjusting handbrake lever

! Changing the position of the brake-fluid reservoir can allow air to penetrate the brake system.

Do not turn the handlebar fitting on the handlebar.◀

! Attempting to adjust the handbrake lever while riding the motorcycle can lead to accidents.

Do not attempt to adjust the handbrake lever unless the motorcycle is at a standstill.◀

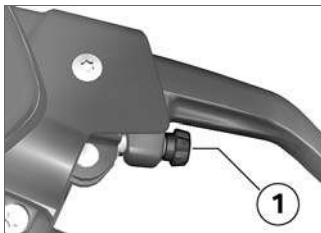

- Turn adjusting screw **1** clockwise to increase the span between the brake lever and the handlebar grip.
- Turn adjusting screw **1** counter-clockwise to reduce the span between the brake lever and the handlebar grip.

▶ The adjusting screw is easier to turn if you push the handbrake lever forward.◀

Mirrors

Adjusting mirrors



- Pivot the mirror to the correct position by pressing gently at the edge.

Spring preload Setting

It is essential to set spring preload of the rear suspension to suit the load carried by the motorcycle. Increase spring preload when the motorcycle is heavily loaded and reduce spring preload

accordingly when the motorcycle is lightly loaded.

Adjusting spring preload for rear wheel

- Make sure the ground is level and firm and place the motorcycle on its stand.



 Adjusting spring preload while the motorcycle is being ridden can lead to accidents. Do not attempt to adjust spring preload unless the motorcycle is at a standstill.◀

- Pull knob **1** out for better accessibility.

 Your motorcycle's handling will suffer if you do not match the spring-preload and damping-characteristic settings. Adjust the damping characteristic to suit spring preload.◀

- If you want to increase spring preload, turn the knob in the direction indicated by the HIGH arrow.
- If you want to reduce spring preload, turn the knob in the direction indicated by the LOW arrow.



Basic setting of spring preload, rear

- without Electronic Suspension Adjustment (ESA)^{OE}
- Knob turned as far as it will go in the direction indicated by the LOW arrow (Full load of fuel, with rider 85 kg)◀

- Push the knob back in to its original position.

Damping Setting

Damping must be adapted to suit the surface on which the motorcycle is ridden and to suit spring preload.

- An uneven surface requires softer damping than a smooth surface.
- An increase in spring preload requires firmer damping, a reduction in spring preload requires softer damping.

Adjusting damping for rear wheel

- Make sure the ground is level and firm and place the motorcycle on its stand.



- If you want a harder damping characteristic, use the tool from the on-board toolkit to turn adjusting screw **1** in the direction indicated by the H arrow.
- If you want a softer damping characteristic, use the tool from the on-board toolkit to turn adjusting screw **1** in the direction indicated by the S arrow.

Basic setting of rear-suspension damping characteristic

– without Electronic Suspension Adjustment (ESA)^{OE}

Basic setting of rear-suspension damping characteristic

- Turn the adjusting screw as far as it will go in the direction indicated by the H arrow and then turn it back one and a half turns in the direction indicated by the S arrow (Full load of fuel, with rider 85 kg)◀

Electronic Suspension Adjustment ESA

- with Electronic Suspension Adjustment (ESA)^{OE}

Settings

Electronic Suspension Adjustment ESA provides a convenient way of adapting the motorcycle to the load it carries and the surface over which you intend riding. This entails selecting the load

variant and the damping characteristic.

You have a choice of three load variants with any of three damping characteristics selectable for each one.

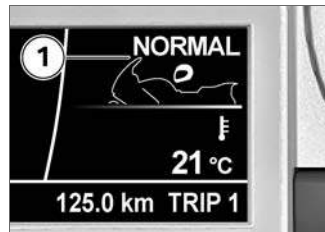

The current setting appears in display field **1**.

The detailed description of the ESA II Electronic Suspension Adjustment system is on page (➔ 99).

Adjusting suspension

- Start the engine.

▶ You can adjust the damping characteristic while the motorcycle is on the move.◀

- Call up the ESA menu.



The possible settings for the damping characteristic appear on the display.



- **Comfort**: comfort mode
- **Normal**: normal mode
- **Sport**: sport mode
- Select the damping characteristic you want or move the

cursor down to set the vehicle load.

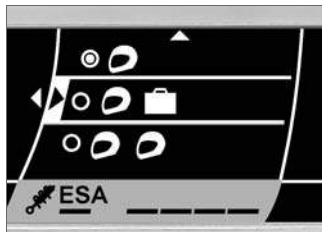
▶ The load cannot be set while the motorcycle is in motion.◀



The possible settings for vehicle load appear on the display.

-  One-up
-  One-up with luggage
-  Two-up (with luggage)

- Select the vehicle load variant you want.
- » The suspension adjusts to suit the new setting and the ESA reading changes accordingly. The symbols for vehicle load and damping characteristic are greyed while adjustment is in progress.

Central locking

– with central locking^{OE}

Locking



- Switch on the ignition and press button **3**.

- Alternatively: Press button **1** on the remote control.
- » The stowage compartment in the left side panel and the cases are locked.
- with preparation for audio system and navigation device^{OE}
- » The stowage compartment in the right side panel is locked.
- with topcase^{OA}
- » The topcase is locked.
- » These locks cannot subsequently be unlocked manually.



The locked symbol appears on the display.

- with anti-theft alarm (DWA)^{OE}
- » The functions of the remote control for the anti-theft alarm are described in the corresponding section.

Unlocking



- Switch on the ignition and press button **3**.
- Alternatively: Press button **2** on the remote control.
- » The stowage compartment in the left side panel and the cases are unlocked.
- with preparation for audio system and navigation device^{OE}
- » The stowage compartment in the right side panel is unlocked.
- with topcase^{OA}
- » The topcase is unlocked.

- » Once a lock has been locked manually it subsequently has to be unlocked manually as well.
- with anti-theft alarm (DWA)^{OE}
- » The functions of the remote control for the anti-theft alarm are described in the corresponding section.
- with ground lighting^{OA}
- » If you use the remote control to unlock with the ignition switched off, the ground lighting is switched on for a brief period.

Emergency unlocking

If the central locking system refuses to unlock, you can open the cases, topcase and stowage compartments manually. The procedure is as follows:

- Remove the cases (➡ 107).
- Open the cases (➡ 106).



- First turn the key in the top-case lock 45° past the LOCK position, then turn it to the dot position and press in the lock barrel.
- » The release lever pops open.



- Turn the key in the stowage-compartment lock 45° out past the vertical position and press in the lock barrel.
- » The stowage-compartment lid pops open.

Logon of remote controls

If a remote control has been mislaid and a replacement acquired or if you are going to use an additional remote control, you must invariably log on all the remote controls in the set.

- Enable logon of the remote controls as follows:

- Switch on the ignition.

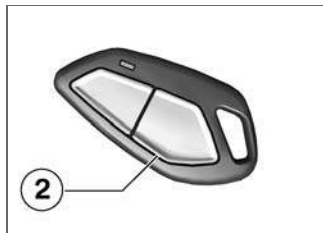

- Press button **2** on the remote control three times.
- » One acoustic signal sounds.
- Within ten seconds, switch off the ignition.
- Press button **2** on the remote control three times.
- » One acoustic signal sounds.
- Within ten seconds, switch on the ignition.

You can now proceed to log on all the remote controls.

- Step through the following procedure with each remote control in turn:

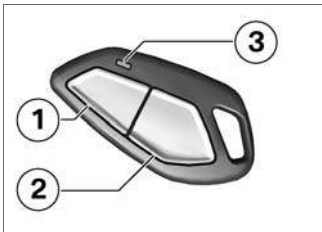

- Press and hold down buttons **1** and **2** until LED **3** stops flashing.
 - » LED **3** flashes for about ten seconds.
- Release buttons **1** and **2**.
 - » LED **3** lights up.
- Press button **1** or button **2**.
 - » One acoustic signal sounds, LED **3** goes out.

To complete logon:

- Switch off the ignition.
 - » Three acoustic signals sound.
 - » Logon is also ended when
 - four remote controls have been logged on.
 - if you have logged on the first remote control and then do not press a button within approximately 30 seconds.

Synchronising remote controls

If the central locking system stops responding to the signals from a remote control, the unit in question has to be synchronised. This can happen, for example, if the buttons on the remote control were pressed too frequently while the remote control was out of range of the anti-theft alarm.

- The procedure for synchronising the remote controls is as follows:

- Switch on the ignition.

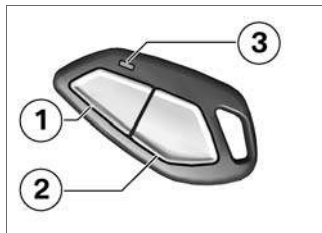

- Press and hold down buttons **1** and **2** until LED **3** stops flashing.
 - » LED **3** flashes for about ten seconds.
- Release buttons **1** and **2**.
 - » LED **3** lights up.
- Press button **1** or button **2**.
 - » LED **3** goes out.

Replacing battery of remote control

If you press a button on the remote control and the LED does not show or lights up only briefly:

- Replace the battery of the remote control.

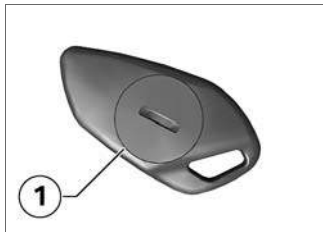

- Open lid of battery compartment **1**.
- Dispose of the old battery in accordance with all applicable laws and regulations; do not attempt to dispose of batteries as domestic waste.

 Using a battery of the wrong type or inserting the battery with the polarity reversed can cause irreparable damage to the device.

Use a battery compliant with the manufacturer's specifications. When inserting the battery, always make sure polarity is correct. ◀

- Insert the new battery with the positive terminal up.



Battery type and rated voltage

- CR 1632 lithium
- 3 V

- » The LED on the remote control lights up; the remote control has to be synchronised.

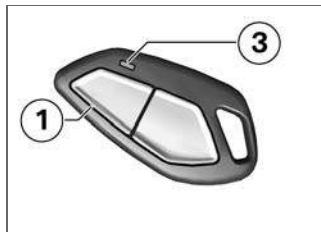

- Press button **1** twice.
 - » LED **3** flashes for a few seconds.
 - » The remote control is again ready for use.

Anti-theft alarm (DWA) Activation without remote control

– with anti-theft alarm (DWA)^{OE}

- If applicable, switch on automatic activation of the anti-theft alarm after ignition OFF.
- Customise the anti-theft alarm settings (➡ 76).

- Switch off the ignition.
 - » Activation takes approximately 30 seconds to complete.
 - » Turn indicators flash twice.
 - » Confirmation tone sounds twice (if programmed).
 - » Anti-theft alarm is active.
- To deactivate the motion sensor (for example if you are about to transport the motorcycle on a train and the swaying movement of the moving train could trip the alarm), call up the Settings menu before switching off the ignition.
- Select **Vehicle - Alarm syst. - Sensor.**

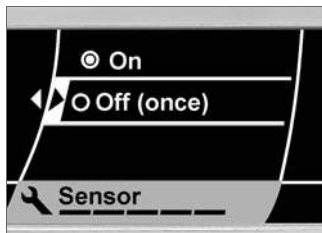

- Select **Off (once)** to switch off the motion sensor this once.
- Switch off the ignition.
 - » Activation takes 30 seconds to complete.
 - » Turn indicators flash three times.
 - » Confirmation tone sounds three times (if programmed).
 - » The anti-theft alarm is active, the motion sensor is deactivated.

Activation with remote control

- with anti-theft alarm (DWA)^{OE}
- with central locking^{OE}
- Switch off the ignition.



- Press button **1** on the remote control twice.
 - ▶ See also the other functions of the remote control for the central locking system.◀
 - » Activation takes approximately 30 seconds to complete.
 - » Turn indicators flash twice.

- » Confirmation tone sounds twice (if programmed).
- » Anti-theft alarm is active.



- To deactivate the motion sensor (for example if you are about to transport the motorcycle on a train and the swaying movement of the moving train could trip the alarm), press button **1** on the remote control again during the activation phase.
- » Turn indicators flash three times.
- » Confirmation tone sounds three times (if programmed).

- » Motion sensor is deactivated.

Alarm

- with anti-theft alarm (DWA)^{OE}

An alarm can be triggered by

- the motion sensor
- an attempt to use an unauthorised key to switch on the ignition
- disconnection of the anti-theft alarm from the motorcycle's battery (internal battery in the anti-theft alarm provides power - alarm tone only, the turn indicators do not flash)

All functions are sustained even if the internal battery of the anti-theft alarm system is flat; the only difference is that an alarm cannot be triggered if the system is disconnected from the motorcycle's battery.

An alarm lasts for approximately 26 seconds. While an alarm is in progress an alarm tone sounds and the turn indicators flash. You can program the type of alarm tone.

- with central locking^{OE}

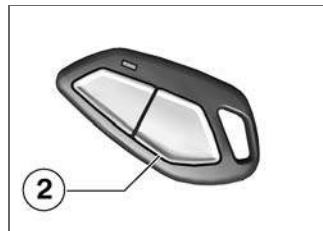

You can cancel an alarm at any time without deactivating the anti-theft alarm by pressing button **2** on the remote control.<

If an alarm was triggered while the motorcycle was unattended, the rider is notified accordingly by an alarm tone sounding once

when the ignition is switched on. The anti-theft alarm telltale light then signals the reason for the alarm for one minute.

The meanings of the flash codes are as follows:

- Flashes 1x: Motion sensor 1
- Flashes 2x: Motion sensor 2
- Flashes 3x: Ignition switched on with unauthorized key
- Flashes 4x: Disconnect of the anti-theft alarm from the motorcycle's battery
- Flashes 5x: Motion sensor 3

Deactivation without remote control

- with anti-theft alarm (DWA)^{OE}
- Kill switch in operating position (run).
- Switch on the ignition.
 - » Turn indicators flash once.
 - » Confirmation tone sounds once (if programmed).
 - » Anti-theft alarm is deactivated.

Deactivation with remote control

- with anti-theft alarm (DWA)^{OE}
- with central locking^{OE}

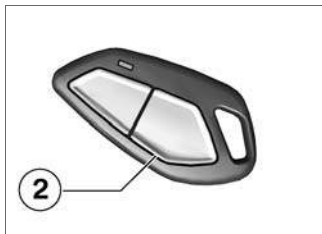

- Press button **2** on the remote control once.

▶ See also the other functions of the remote control for the central locking system. ◀

▶ If you use the remote control to deactivate the alarm function and do not follow up by switching on the ignition, the alarm function is automatically reactivated after 30 seconds if

the "activation after ignition off" parameter is set. ◀

- » Turn indicators flash once.
- » Confirmation tone sounds once (if programmed).
- » Anti-theft alarm is deactivated.

Customising anti-theft alarm settings

- with anti-theft alarm (DWA)^{OE}
- Call up the `Settings` menu and select `Vehicle - Alarm syst..`

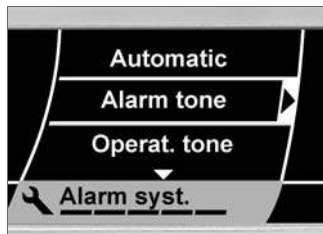

The following settings are available:

- **Automatic - On:** Anti-theft alarm is activated automatically when the ignition is switched off.
- **Automatic - Off:** Anti-theft alarm has to be activated with the remote control when the ignition is switched off.
- **Alarm tone:** Type of alarm tone.
- **Operat. tone - On:** Turn indicators flash and one tone sounds as confirmation when the alarm is switched on or off.
- **Operat. tone - Off:** Turn indicators flash as only confirmation when anti-theft alarm is switched on or off.
- Use the multi-controller to select your preferred settings.

Tyres

Checking tyre pressure



Incorrect tyre pressures impair the motorcycle's handling characteristics and increase the rate of tyre wear.

Always check that the tyre pressures are correct. ◀

- Make sure the ground is level and firm and place the motorcycle on its stand.
- Check tyre pressures against the data below.



Tyre pressure, front

- 2.9 bar (Tyre cold)



Tyre pressure, rear

- 2.9 bar (Tyre cold)

If tyre pressure is too low:

- Correct tyre pressure.

Riding

Safety instructions	80
Checklist.....	82
Starting	82
Running in	84
Brakes	85
Parking your motorcycle	86
Refuelling	87
Securing motorcycle for transportation	88

Safety instructions

Rider's equipment

Do not ride without the correct clothing. Always wear:

- Helmet
- Motorcycling jacket and trousers
- Gloves
- Boots

This applies even to short journeys, and to every season of the year. Your authorised BMW Motorrad dealer will be glad to advise you on the correct clothing for every purpose.

Correct loading



Overloading and imbalanced loads can adversely affect the motorcycle's handling. Do not exceed the permissible gross weight and be sure to comply with the instructions on loading. ◀

- Set spring preload, damping characteristic and tyre pressures to suit total weight.
- Make sure that the weight is uniformly distributed between right and left.
- Pack heavy items at the bottom and toward the inboard side.
- Note the maximum permissible payload and the speed limit for riding with cases fitted, as stated on the label inside the case.
 - with topcase ^{OA}
- Note the maximum permissible payload and the speed limit for riding with topcase fitted, as stated on the label inside the topcase. ◀
- with tankbag ^{OA}
- Note the maximum permissible payload of the tankbag and the speed limit for riding with a tankbag on the motorcycle.



Payload of tankbag

– ≤5 kg



Maximum permissible speed for riding with the tankbag fitted to the motorcycle

– ≤160 km/h ◀

Speed

If you ride at high speed, always bear in mind that various boundary conditions can adversely affect the handling of your motorcycle:

- Settings of the spring-strut and shock-absorber system
- Imbalanced load
- Loose clothing
- Insufficient tyre pressure
- Poor tyre tread
- Etc.

Risk of poisoning

Exhaust fumes contain carbon monoxide, which is colourless and odourless but highly toxic.

 Inhaling the exhaust fumes therefore represents a health hazard and can even cause loss of consciousness with fatal consequences. Do not inhale exhaust fumes. Do not run the engine in an enclosed space.◀

Risk of burn injury

 Engine and exhaust system become very hot when the motorcycle is in use. There is a risk of burn injuries by contact with hot surfaces, particularly at the silencer.

When you park the motorcycle make sure that no-one comes into contact with the engine and exhaust system.◀

Catalytic converter

If misfiring causes unburned fuel to enter the catalytic converter, there is a danger of overheating and damage.

For this reason, observe the following points:

- Do not run the fuel tank dry.
- Do not attempt to start or run the engine with a spark-plug cap disconnected.
- Stop the engine immediately if it misfires.
- Use only unleaded fuel.
- Comply with all specified maintenance intervals.

 Unburned fuel will destroy the catalytic converter. Note the points listed for protection of the catalytic converter.◀

Risk of overheating

 Cooling would be inadequate if the engine were allowed to idle for a lengthy period with the motorcycle at a standstill: overheating would result. In extreme cases, the motorcycle could catch fire. Do not allow the engine to idle unnecessarily. Ride away immediately after starting the engine.◀

Manipulation

 Tampering with motorcycle settings (e.g. electronic engine management unit, throttle valves, clutch) can cause damages to the components in question and lead to failure of safety-relevant functions. Damage caused in this way is not covered by the warranty. Do not tamper with the motorcycle in any way that could result in tuned performance.◀

Checklist

Use the following checklist to check important functions, settings and wear limits before you ride off.

- Brakes
- Brake-fluid levels, front and rear
- Clutch
- Clutch fluid level
- Shock absorber setting and spring preload
- Tyre-tread depth and tyre pressures
- Cases correctly installed and luggage secured

At regular intervals:

- Engine oil level (every refuelling stop)
- Brake-pad wear (every third refuelling stop)

Starting

Side stand

You cannot start the motorcycle with the side stand extended and a gear engaged. The engine will switch itself off if you start it with the gearbox in neutral and then engage a gear before retracting the side stand.

Starting engine

- Switch on the ignition.
 - » Pre-ride check is performed. (➡ 83)
 - » ABS self-diagnosis is performed. (➡ 83)
 - with Dynamic Traction Control (DTC) ^{OE}
 - » DTC self-diagnosis is performed. (➡ 84)
- Select neutral or, if a gear is engaged, pull the clutch lever.
- When starting a cold engine at low ambient temperatures: disengage the clutch and turn

the twistgrip slightly to open the throttle.



- Press starter button **1**.

▶ The start attempt is automatically interrupted if battery voltage is too low. Recharge the battery before you start the engine, or use jump leads and a donor battery to start. ◀

- » The engine starts.
- » Consult the troubleshooting chart below if the engine refuses to start. (➡ 144)

Pre-ride check

The instrument panel runs a test of the 'General' warning light when the ignition is switched on: this is the "Pre-Ride-Check. The test is aborted if you start the engine before it completes.

Phase 1



General warning light shows red.

- CHECK! appears on the display.

Phase 2



General warning light shows yellow.

- CHECK! appears on the display.

SET

The SET light lights up.

If the 'General' warning light does not show:



Some malfunctions cannot be indicated if the 'General' warning light cannot be displayed.

Check that the 'General' warning light comes on, and that it shows red and yellow. ◀

- Have the fault rectified as quickly as possible by a specialist workshop, preferably an authorised BMW Motorrad dealer.

ABS self-diagnosis

BMW Motorrad Integral ABS performs self-diagnosis to ensure its operability. Self-diagnosis is performed automatically when you switch on the ignition.

Phase 1

- » Test of the diagnosis-compatible system components with the motorcycle at a standstill.



ABS warning light flashes.

Phase 2

- » Test of the wheel sensors as the motorcycle pulls away from rest. The motorcycle must reach a speed of at least 5 km/h in order for ABS self-diagnosis to complete.



ABS warning light flashes.

ABS self-diagnosis completed

- » The ABS warning light goes out.

If an indicator showing an ABS fault appears when ABS self-diagnosis completes:

- You can continue to ride. Bear in mind that neither the ABS function nor the integral braking function is available.
- Have the fault rectified as quickly as possible by a specialist workshop, preferably an authorised BMW Motorrad dealer.

DTC self-diagnosis

– with Dynamic Traction Control (DTC) ^{OE}

BMW Motorrad DTC performs self-diagnosis to ensure its operability. Self-diagnosis is performed automatically when you switch on the ignition.

Phase 1

- » Test of the diagnosis-compatible system components with the motorcycle at a standstill.



DTC warning light slow-flashes.

Phase 2

- » Test of the diagnosis-compatible system components while the motorcycle is on the move. The engine must be running and the motorcycle must reach a speed of at least 5 km/h in order for DTC self-diagnosis to complete.



DTC warning light slow-flashes.

DTC self-diagnosis completed

- » The DTC symbol no longer shows.

If an indicator showing a DTC fault appears after DTC self-diagnosis completes:

- You can continue to ride. Bear in mind that the DTC function is not available.

- Have the fault rectified as quickly as possible by a specialist workshop, preferably an authorised BMW Motorrad dealer.

Running in

The first 1000 km

- While running in the motorcycle, vary the throttle opening and engine-speed range frequently; avoid riding at constant engine rpm for prolonged periods.
- Try to do most of your riding during this initial period on twisting, fairly hilly roads, avoiding high-speed main roads and highways if possible.
- Comply with the rpm limits for running in.



Running-in speed

– 5000 min^{-1} (Odometer reading 0...300 km)

– 6000 min^{-1} (Odometer reading 300...1000 km)

– no full throttle (Odometer reading 0...1000 km)

- Do not omit the first inspection after 500 - 1200 km.

Brake pads

New brake pads have to bed down before they can achieve their optimum friction levels. You can compensate for this initial reduction in braking efficiency by exerting greater pressure on the levers.



New brake pads can extend stopping distance by a significant margin.

Apply the brakes in good time.◀

Tyres

New tyres have a smooth surface. This must be roughened by riding in a restrained manner at various heel angles until the tyres are run in. This running in procedure is essential if the tyres are to achieve maximum grip.



Tyres do not have their full grip when new and there is a risk of accidents at extreme angles of heel.

Avoid extreme angles of heel.◀

Brakes

How can stopping distance be minimised?

Each time the brakes are applied, a load distribution shift takes place with the load shifting forward from the rear to the front wheel. The sharper the motorcycle decelerates, the more load is shifted to the front wheel. The higher the wheel load, the more

braking force can be transmitted without the wheel locking.

To optimise stopping distance, apply the front brakes rapidly and keep on increasing the force you apply to the brake lever. This makes the best possible use of the dynamic increase in load at the front wheel. Remember to pull the clutch at the same time. In the "panic braking situations" that are trained so frequently braking force is applied as rapidly as possible and with the rider's full force applied to the brake levers; under these circumstances the dynamic shift in load distribution cannot keep pace with the increase in deceleration and the tyres cannot transmit the full braking force to the surface of the road. ABS has to intervene to keep the front wheel from locking; this increases stopping distance.

Descending mountain passes

 There is a danger of the brakes fading if you use only the rear brakes when descending mountain passes. Under extreme conditions, the brakes could overheat and suffer severe damage.

With the BMW integrated brake system, the rear brake is activated when the handbrake lever is pressed. This protects against overheating. Only use the front brake and utilise engine braking. ◀

Wet and dirty brakes

Wetness and dirt on the brake discs and the brake pads diminish braking efficiency.

Delayed braking action or poor braking efficiency must be reckoned with in the following situations:

- Riding in the rain or through puddles of water.
- After the motorcycle has been washed.
- Riding on salted or gritted roads.
- After work has been carried on the brakes, due to traces of oil or grease.
- Riding on dirt-covered surfaces or off-road.

 Wetness and dirt result in poor braking efficiency.

Apply the brakes lightly while riding to remove wetness and dirt, or dismount and clean the brakes.

Think ahead and brake in good time until full braking efficiency is restored. ◀

Parking your motorcycle

Side stand

- Switch off the engine.

 If the ground is soft or uneven, there is no guarantee that the motorcycle will rest firmly on the stand.

Always check that the ground under the stand is level and firm. ◀

- Extend the side stand and prop the motorcycle on the stand.

 The side stand is designed to support only the weight of the motorcycle.

Do not lean or sit on the motorcycle with the side stand extended. ◀

- If the camber of the roadway permits, turn the handlebars all the way to the left.

- On a gradient, the motorcycle should always face uphill; select 1st gear.

Centre stand

- Switch off the engine.

! If the ground is soft or uneven, there is no guarantee that the motorcycle will rest firmly on the stand.

Always check that the ground under the stand is level and firm.◀

! Excessive movements could cause the centre stand to retract, and the motorcycle would topple in consequence.

Do not lean or sit on the motorcycle with the centre stand extended.◀

- Extend the centre stand and lift the motorcycle onto the stand.

Refuelling

! Fuel is highly flammable. A naked flame close to the fuel tank can cause a fire or explosion.

Do not smoke. Never bring a naked flame near the fuel tank.◀

! Fuel attacks plastics, which become dull or unsightly. Wipe off plastic parts immediately if they come into contact with fuel.◀

- Make sure the ground is level and firm and place the motorcycle on its stand.
- Open the protective cap.



- Use the ignition key to unlock the fuel filler cap and pop the cap open.



! Fuel expands when hot. Fuel escaping from an overfilled tank could make its way

onto the road surface. This could cause a fall.

Do not overfill the fuel tank.◀



Leaded fuel will destroy the catalytic converter.

Use only unleaded fuel.◀

- Refuel with fuel of the grade stated below; do not fill the tank past the bottom edge of the filler neck.



When refuelling after running on reserve, make sure that you top up the tank to a level above reserve, as otherwise the sensor will not be able to register the new level. If the sensor cannot register the new level neither the fuel-level reading nor the range readout can be updated.◀



Recommended fuel grade

- Super unleaded
- 95 ROZ/RON
- 89 AKI



Usable fuel capacity

- approx. 24 l



Reserve fuel

- approx. 4 l

Securing motorcycle for transportation

- Make sure that all components that might come into contact with straps used to secure the

motorcycle are adequately protected against scratching. Use adhesive tape or soft cloths, for example, for this purpose.



The motorcycle can topple and fall on its side.

Make sure that the motorcycle cannot topple sideways.◀

- Push the motorcycle onto the transportation flat and hold it in position: do not place it on the side stand or centre stand.

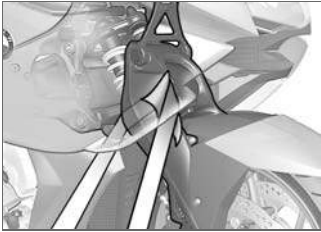

The ball joint and the brake lines can suffer damage. Take care not to damage components. ◀

- Pass the straps on left and right through the suspension and strap the motorcycle down.

- At the rear, secure the straps to the rear frame on both sides and tighten the straps.
- Do not pull the straps over the footrests.
- Uniformly tighten all the straps.

Engineering details

Ride mode	92
Brake system with BMW Motorrad Integral ABS	93
Electronic engine management with BMW Motorrad DTC	96
Tyre pressure monitoring RDC	98
Electronic Suspension Adjustment ESA II	99

Ride mode

Selection

This section has yet to be finalised!

Three riding modes enable the motorcycle's characteristics to adapt to the prevailing weather conditions, the road and traffic, and the rider's style of riding:

- RAIN
- Road
- DYNAMIC

Each of these modes produces perceptible differences in the way the motorcycle behaves. DTC can be switched off in each mode; the explanations below invariably refer to conditions with the system switched ON. The mode last selected is automatically reactivated after the ignition has been switched off and then on again.

The basic rule is: the sportier the mode you select, the more directly can you tap into the engine's reserves of power. At the same time, the level of rider assistance that the DTC system offers decreases accordingly. Consequently, you must always bear the following in mind with regard to your selection of a ride mode: the sportier the setting, the greater the challenge to your riding skill.

RAIN

The engine's full power is not made available. Power increase when you open the throttle is reserved, engine response is correspondingly soft. The DTC system intervenes early enough to prevent the rear wheel from spinning. On road surfaces with high to medium grip (dry and wet asphalt to dry cobblestones) the motorcycle remains

very stable; movements of the tail are clearly perceptible only on slippery road surfaces (wet bitumen or wet cobblestones).

ROAD

The engine's full power is available in this mode. Power increase when you open the throttle is more direct than in RAIN mode, the engine responds more rapidly. DTC system intervention is later than in RAIN mode. On road surfaces with high to medium grip (dry and wet asphalt to dry cobblestones) the motorcycle remains stable. Slight rear-wheel drift is perceptible. Movements of the tail are clearly perceptible on slippery road surfaces (wet bitumen or wet cobblestones).

DYNAMIC

SPORT is the standard mode. Power increase and engine response are the same as in ROAD mode. Response to rider input, however, is considerably more direct.

DTC system intervention is even later, which means that even on dry asphalt drifting is possible under sharp acceleration when cornering.

Mode changes

A mode change involving functions in the engine management system and the DTC system is possible only when drive torque is not applied to the rear wheel.

In order to achieve this state,

- the motorcycle must be at a standstill with the ignition switched on,

or

- the throttle twistgrip must be in the fully closed position,
- the clutch lever must be pulled and the clutch disengaged.

The desired ride mode is initially preselected. The mode change does not take place until the systems in question are all in the appropriate state.

The selection menu does not disappear from the display until the mode change has taken place.

Brake system with BMW Motorrad Integral ABS

Partially integral brakes

Your motorcycle is equipped with partially integral brakes. Both front and rear brakes are applied when you pull the handbrake lever. The footbrake lever acts only on the rear brake.

While the brakes are slowing the motorcycle, the BMW Motorrad Integral ABS adapts braking-force distribution between front and rear brakes to suit the load on the motorcycle.



The integral braking function makes it very difficult to spin the rear wheel by opening the throttle with the front brake applied to keep the motorcycle stationary (burn-out). Attempted burn-outs can result in damage to the rear brake and the clutch. Do not attempt burn-outs. ◀

How does ABS work?

The amount of braking force that can be transferred to the road depends on factors that include the coefficient of friction of the road surface. Loose stones, ice and snow or a wet road all have much lower coefficients of friction than a clean, dry asphalt surface. The lower the coefficient

of friction, the longer the braking distance.

If the rider increases braking pressure to the extent that braking force exceeds the maximum transferrable limit, the wheels start to lock and the motorcycle loses its directional stability; a fall is imminent. Before this situation can occur, ABS intervenes and adapts braking pressure to the maximum transferrable braking force, so the wheels continue to turn and directional stability is maintained irrespective of the condition of the road surface.

What are the effects of surface irregularities?

Humps and surface irregularities can cause the wheels to lose contact temporarily with the road surface; if this happens the braking force that can be transmitted to the road can drop to zero. If the brakes are applied

under these circumstances the ABS has to reduce braking force to ensure that directional stability is maintained when the wheels regain contact with the road surface. At this instant the BMW Motorrad Integral ABS must assume an extremely low coefficient of friction, so that the wheels will continue to rotate under all imaginable circumstances, because this is the precondition for ensuring directional stability. As soon as it registers the actual circumstances, the system reacts instantly and adjusts braking force accordingly to achieve optimum braking.

What feedback does the rider receive from the BMW Motorrad Integral ABS?

If the ABS system has to reduce braking force on account of the circumstances described above, vibration is perceptible through the handbrake lever.

When the handbrake lever is pulled, brake pressure is also built up at the rear wheel by the integral function. If the brake pedal is depressed after the handbrake lever is pulled, the brake pressure built up beforehand is perceptible as counter-pressure sooner than is the case when the brake pedal is depressed either before or at the same time as the brake lever is pulled.

Rear wheel lift

Even under severe braking, a high level of tyre grip can mean that the front wheel does not lock up until very late, if at all. Consequently, ABS does not intervene until very late, if at all. Under these circumstances the rear wheel can lift off the ground, and the outcome can be a high-siding situation in which the motorcycle can flip over.



Severe braking can cause the rear wheel to lift off the ground.

When you brake, bear in mind that ABS control cannot be relied on in all circumstances to prevent the rear wheel from lifting clear of the ground. ◀

What is the design baseline for BMW Motorrad Integral ABS?

Within the limits imposed by physics, the BMW Motorrad Integral ABS ensures directional stability on any surface. The system is not optimised for special requirements that apply under extreme competitive situations off-road or on the track.

Special situations

The speeds of the front and rear wheels are compared as one means of detecting a wheel's incipient tendency to lock. If the system registers implausible values for a lengthy period the ABS function is deactivated for safety reasons and an ABS fault message is issued. Self-diagnosis has to complete before fault messages can be issued.

In addition to problems with the BMW Motorrad Integral ABS,

exceptional riding conditions can lead to a fault message being issued.

Exceptional riding conditions:

- Heating up with the motorcycle on the centre stand or an auxiliary stand, engine idling or with a gear engaged.
- Rear wheel locked by the engine brake for a lengthy period, for example while descending on a loose surface.

If a fault message is issued on account of exceptional riding conditions as outlined above, you can reactivate the ABS function by switching the ignition off and on again.

What significance devolves on regular maintenance?

 Invariably, a technical system cannot perform beyond the abilities dictated by its level of maintenance.

In order to ensure that the BMW Motorrad Integral ABS is always maintained in optimum condition, it is essential for you to comply strictly with the specified inspection intervals. ◀

Reserves for safety

The potentially shorter braking distances which BMW Motorrad Integral ABS permits must not be used as an excuse for careless riding. ABS is primarily a means of ensuring a safety margin in genuine emergencies.

Take care when cornering. When you apply the brakes on a corner, the motorcycle's weight and

momentum take over and even BMW Motorrad Integral ABS is unable to counteract their effects.

Electronic engine management with BMW Motorrad DTC

– with Dynamic Traction Control (DTC) ^{OE}

How does DTC work?

The BMW Motorrad DTC compares the speed of rotation of the front wheel and the rear wheel. The differential is used to compute slip as a measure of the reserves of stability available at the rear wheel. If slip exceeds a certain limit the electronic engine management system intervenes, adapting engine torque accordingly.

 Even DTC is constrained by the laws of physics. Invariably, the rider bears respons-

ibility for assessing road and traffic conditions and adopting his or her style of riding accordingly. Do not take risks that would negate the additional safety offered by this system. ◀

What is the design baseline for BMW Motorrad DTC?

BMW Motorrad DTC is designed as an assistant system for the rider and for use on public roads. The extent to which the rider affects DTC control can be considerable (weight shifts when cornering, items of luggage loose on the motorcycle), especially when style of riding takes rider and machine close to the limits imposed by physics.

The system is not optimised for special requirements that apply under extreme competitive situations off-road or on the track. You have the option of deactiv-

ating the BMW Motorrad DTC system for these circumstances.



Even DTC is constrained by the laws of physics. Invariably, the rider bears responsibility for assessing road and traffic conditions and adopting his or her style of riding accordingly. Do not take risks that would negate the additional safety offered by this system. ◀

Special situations

In accordance with the laws of physics, the ability to accelerate is restricted more and more as the angle of heel increases. Consequently, there can be a perceptible reduction in acceleration out of very tight bends.

The speeds of the front and rear wheels are compared and the angle of heel taken into account as one means of detecting the rear wheel's incipient tendency to

spin or slip sideways. If the electronic processor receives values that it considers implausible over a lengthy period, a dummy value is used for the angle of heel or the DTC function is switched off. Under these circumstances the indicator for a DTC fault shows. Self-diagnosis has to complete before fault messages can be issued.

The BMW Motorrad DTC can issue an error message under the exceptional riding conditions outlined below.

Exceptional riding conditions:

- Riding for a lengthy period with the front wheel lifted off the ground (wheelie) and DTC deactivated.
- Rear wheel rotating with the motorcycle held stationary by applying the front brake (burn-out).

- Heating up with the motorcycle on an auxiliary stand, in neutral or with a gear engaged.

If the front wheel lifts clear of the ground under severe acceleration, the DTC reduces engine torque until the front wheel regains contact with the ground. Under these circumstances, BMW Motorrad recommends rolling the throttle slightly closed so as to restore stability with the least possible delay.

When riding on a slippery surface, never snap the throttle twistgrip fully closed without pulling the clutch at the same time. Engine braking torque can cause the rear wheel to skid, with a corresponding loss of stability. The BMW Motorrad DTC is unable to control a situation of this nature.

Tyre pressure monitoring RDC

– with tyre pressure monitoring (RDC)^{OE}

Function

A sensor integrated into each tyre measures the air temperature and the air pressure inside the tyre and transmits this information to the control unit. Each sensor has a tripswitch that does not enable transmission of the measured values until the motorcycle has accelerated to about 30 km/h. The display shows "--" for each tyre until the tyre-pressure signal is received for the first time. The sensors continue to transmit the measured-value signals for approximately 15 minutes after the motorcycle comes to a stop. An error message is issued if wheels without sensors are fitted

to a motorcycle equipped with an RDC control unit.

Temperature compensation

Tyre pressure is a temperature-sensitive variable: pressure increases as tyre temperature rises and decreases as tyre temperature drops. Tyre temperature depends on ambient temperature, on the style of riding and the duration of the ride.

The tyre-pressure readings shown by the multifunction display are temperature-compensated; the reference tyre temperature for these readings is always 20 °C. The air lines available to the public in petrol stations and motorway service areas have gauges that do not compensate for temperature; the reading shown by a gauge of this nature is the temperature-dependent tyre pressure. In

most instances, therefore, these gauge readings will not tally with the pressures shown by the multifunction display. The warmer the tyre, the higher the gauge reading by comparison with the reading shown on the display.

Pressure adaptation

Compare the RDC readings on the multifunction display with the value in the table on the inside cover of the Rider's Manual. Then use the air line to compensate for the difference between the RDC reading and the value in the table.

Example: According to the Rider's Manual, tyre pressure should be 2.9 bar, but the reading in the multifunction display is 2.7 bar, so pressure is low by 0.2 bar. The gauge on the air line shows 2.5 bar. You must now increase tyre pressure by the 0.2 bar dif-

ference between the value in the table and the RDC reading; when the air-line gauge shows 2.7 bar, the tyre is inflated to the correct pressure.<

Electronic Suspension Adjustment ESA II

– with Electronic Suspension Adjustment (ESA)^{OE}

Suspension adjustments

Depending on the load on the motorcycle, the appropriate load status must first be selected when the motorcycle is stationary. The damping characteristics on both spring struts and the spring mount and the spring rate on the rear spring strut are adjusted on the basis of the riding mode that is then selected. If the selected driving mode is changed, the damping characteristics on both spring struts and the spring rate on the rear spring

strut are also adjusted. This allows the suspension to be very accurately adapted to all riding conditions, even when the motorcycle is in motion.

- The combination of spring mount, suspension and spring rate ensure that the suspension geometry is always perfectly adjusted.
- The static normal position is almost maintained even while riding.
- The different riding conditions and load statuses are compensated, so that the handling of the motorcycle remains constant.

It is possible to change the spring rate electronically by combining a conventional coil spring and a plastic element (Elastogran), the lateral expansion of which can be restricted electro-hydraulically using

a displaceable sleeve. The more the sleeve encloses the plastic element, the more the expansion of the plastic element is restricted, causing the spring rate to increase. The maximum spring rate is achieved when the sleeve completely encloses the plastic element and rests on the steel spring. By the same token, the spring rate decreases when the sleeve allows the plastic element to expand further.

Accessories

General instructions.....	102
Power sockets	102
Navigation device	103
Cases.....	106
Topcase	108

General instructions

BMW Motorrad recommends the use of parts and accessories for your motorcycle that are approved by BMW for this purpose. Genuine BMW parts and accessories and other products which BMW has approved can be obtained from your authorised BMW Motorrad dealer, together with expert advice on their installation and use.

These parts and products have been tested by BMW for safety, function and suitability. BMW accepts product liability for them. Conversely, BMW is unable to accept any liability whatsoever for parts and accessories which it has not approved.

Also bear in mind the information on the effect of wheel size on suspension-control systems (►► 122).



BMW Motorrad cannot examine or test each product of outside origin to ensure that it can be used on or in connection with BMW motorcycles without constituting a safety hazard. Country-specific official authorisation does not suffice as assurance. Tests conducted by these instances cannot make provision for all operating conditions experienced by BMW motorcycles and, consequently, they are not sufficient in some circumstances. Use only parts and accessories approved by BMW for your motorcycle. ◀

Whenever you are planning modifications, comply with all the legal requirements. Make sure that the motorcycle does not infringe the national road-vehicle construction and use regulations applicable in your country.

Power sockets

Notes on use of power sockets:

automatic shutdown



If this warning symbol appears it tells you that the on-board system voltage is low. The on-board sockets might be temporarily switched off.

The on-board sockets are also switched off when the engine is being cranked by the starter and if maximum load capability as stated in the technical data is exceeded.

If more than one socket is used, total current must not exceed the maximum load capability.

Operating electrical accessories

You can start using electrical accessories connected to an on-board socket only when the ignition is switched on. If you sub-

sequently switch off the ignition the sockets are also switched off if the power drain caused by their electrical consumers is high. If the power drain is low the sockets remain operational for a certain period of time before being switched off.

Cable routing

The cables from the power sockets to the auxiliary devices must be routed in such a way that they:

- Do not impede the rider
- Do not restrict the steering angle or obstruct handling
- Cannot be trapped

Navigation device

- with preparation for navigation device^{OE}
- with navigation system^{OA}

Installing navigation device

- Switch on the ignition.

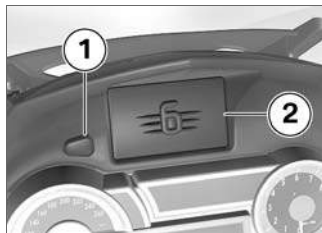

- Press button **1** to open the slot for the navigation device.
 - » Slot cover pops open, wind-screen moves to top limit position.
- Pull slot cover up as far as it will go.
- From behind, push out cap **2**.



- Operate latch **3** and remove cover **4**.

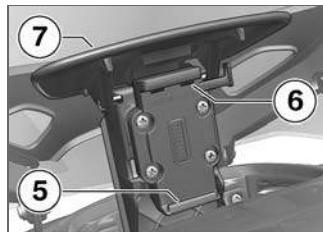

- Initially insert the navigation device into mount **5**, then press it into latching mechanism **6**.

- Check that the navigation device is secure in the cradle.
- Press cover **7** to push cradle with navigation device into the slot until it snaps into position.

Removing navigation device

- Switch on the ignition.

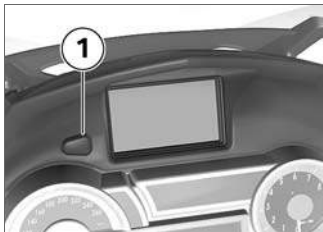

- Press button **1** to open the slot for the navigation device.
- » Slot cover pops open, wind-screen moves to top limit position.

- Pull slot cover up as far as it will go.



- Operate latch **3**, pull the navigation device forward out of holder **6** and lift it up and out.



- Install cover **4**.

- Press cover **7** to push the cradle into the slot until it snaps into position.



- Insert cap **2**.

Operating navigation device

- If applicable, switch on the navigation device.
- Call up the Navigation menu.

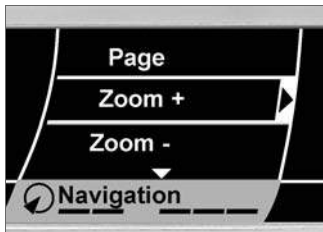

The options for using the navigation device appear on the display.

- **Page:** You can page from view to view; the choices are main menu, map and on-board computer.
- **Zoom +:** Performs functions marked with a plus sign + in the navigation system. In the map view, for instance, the view zooms in on the map detail.
- **Zoom –:** Performs functions marked with a minus sign - in the navigation system. In the map view, for instance, the

view zooms out from the map detail.

- **Speak:** The last navigation announcement is spoken again. The announcement is spoken again even if automatic spoken announcement have been switched off in the settings of the navigation system.
- **Mute:** Automatic spoken announcements are toggled off and on.
- **Display Off:** The display of the navigation device is toggled off and on.
- Select the function you want and implement the function by pushing the multi-controller to the right.

Special functions

Integration of the BMW Motorrad Navigator IV into the K 1600 GT/L series has produced a number of deviations from the descrip-

tions in the user guide for the Navigator.

Traffic channel (TMC)

If the motorcycle is fitted with an audio system, the audio system sends the traffic announcements to the Navigator. The symbol described in the user guide for the Navigator appears on the display. It is not possible to receive traffic announcements from subscription services via the BMW Motorrad audio system.

Reserve fuel level warning

The settings for the fuel gauge enable you to define a distance that is covered per tankful of fuel. The motorcycle sends the figure for residual range possible with the fuel remaining in the fuel tank to the Navigator, so it is no longer necessary to enter this value.

Time and date

The Navigator sends time and date to the motorcycle. Acceptance of these data for the readings on the instrument panel has to be activated in the user settings for the motorcycle.

Security settings

The BMW Motorrad Navigator IV can be secured against unauthorised use with a four-digit PIN (Garmin Lock). If this function is activated, while the Navigator is cradled on the motorcycle and the ignition is switched on you are prompted to add the motorcycle to the list of secured vehicles. If you answer "Yes" at this prompt the Navigator saves the VIN of this vehicle in its internal memory.

A maximum of five VINs can be saved in this way.

Subsequently, the PIN does not have to be entered when the

Navigator is switched on by ignition ON while cradled in any of these vehicles.

If the Navigator is removed from the vehicle while switched on, a security prompt asking for the PIN to be entered is issued.

Screen brightness

Screen brightness is adjusted by the motorcycle while the unit is cradled. There is no provision for manual input.

Cases

Opening cases

- with central locking^{OE}
- If applicable, open the central locking.<

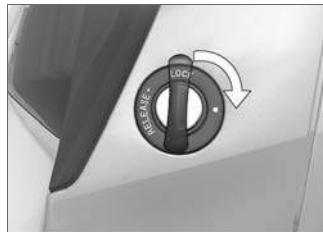

- Turn the key to the in the case lock to the position indicated by the dot.

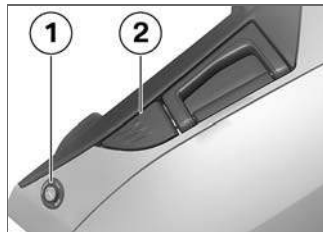

- Push lock barrel **1** down.
» Lever **2** pops up.

- Pull the release lever all the way up and open the lid of the case.

Closing cases



- Pull release lever **2** all the way up.
- Close the lid of the case and press it down. Check that nothing is trapped between the lid and the case.
- Push release lever **2** down until it engages.
- Turn the key in the case lock to the LOCK position and remove the key from the lock.

Removing cases



- Turn the key to the RELEASE position in the case lock.
- » The handle pops out.



- Pull carry handle **3** up as far as it will go.

- » The case is released and can be removed.

Installing cases

- Pull the handle up as far as it will go.

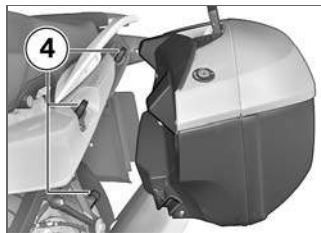

- Seat the case in holders **4**.



- Push handle **3** down until it engages.
- Turn the key in the case lock to the LOCK position and remove the key from the lock.

Topcase

– with topcase ^{OA}

Opening topcase

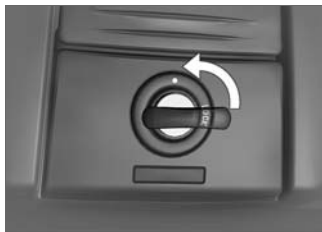

- Turn the key to the in the topcase lock to the position indicated by the dot.

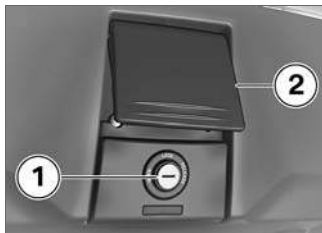

- Push lock barrel **1** forward.
» Lever **2** pops up.

- Pull the release lever all the way up and open the lid of the topcase.

Closing topcase



- Pull release lever **2** all the way up.
- Close the lid of the topcase and hold it down. Check that nothing is trapped between the lid and the case.
- Push release lever **2** down until it engages.
- Turn the key in the topcase lock to the LOCK position and remove the key from the lock.

Removing topcase

- Switch off the ignition.
- Remove the front seat. (→ 60).



- Remove screws **1**.
- Pull the rear seat slightly forward and lift the seat slightly.



- Disconnect plug **2** of the seat heating and remove the rear seat.
- Place the seat, upholstered side down, on a clean surface.



- Disconnect plug **1**.

- Work the topcase-end plug through to the rear.
- Open the topcase.
- If applicable, empty the topcase and lift out the bottom mat.

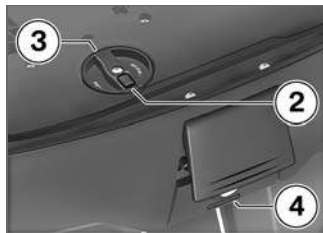

- Push slide latch **2** toward the outside and hold it in this position.
- Turn rotary latch **3** in the direction indicated by the RELEASE arrow.
- » Release warning **4** is visible.
- Close the topcase.



- Lift the topcase at the rear and remove it from the luggage carrier.

Installing topcase

- If applicable, empty the topcase and lift out the bottom mat.



- Set the topcase on the luggage carrier.
- Open the topcase (➡ 108).



- Turn rotary latch **3** as far as it will go in the direction indicated by the LOCK arrow

while pressing down on the back edge of the topcase.

» Release warning **4** is no longer visible.

If the release warning is still visible the topcase is not correctly secured.

- Make sure that the topcase is correctly seated on the luggage carrier.

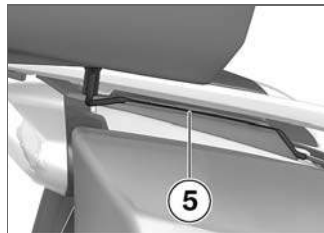

- Route the connecting cable forward in cable guide **5**.

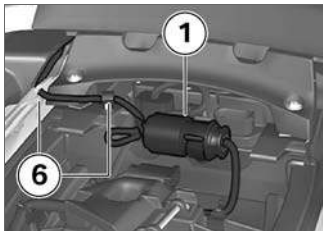

- Work the cable into position at positions **6**.
- Connect plug **1**.

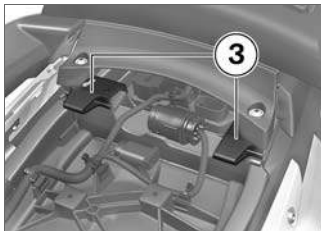

- Slip the rear seat under mounts **3** and lower it into position.



- Connect plug **2** of the seat heating.



- Install screws **1**.

Maintenance

General instructions.....	114
Toolkit	114
Engine oil	114
Brake system	116
Coolant	120
Clutch	120
Rims and tyres.....	121
Wheels	122
Front-wheel stand	128
Jump starting.....	130
Bulbs	131
Battery.....	134
Fuses	137

General instructions

The Maintenance chapter describes straightforward procedures for checking and replacing certain wear parts.

Special tightening torques are listed as applicable. The tightening torques for the threaded fasteners on your motorcycle are listed in the section entitled "Technical data".

You will find information on more extensive maintenance and repair work in the Repair Manual on DVD for your motorcycle, which is available from your authorised BMW Motorrad dealer.

Some of the work calls for special tools and a thorough knowledge of motorcycle technology. If you are in doubt consult a specialist workshop, preferably your authorised BMW Motorrad dealer.

Toolkit

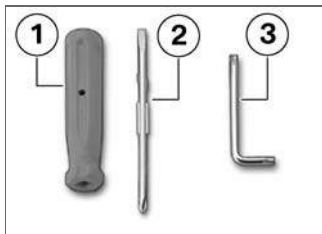

- 1** Screwdriver handle
- 2** Reversible screwdriver blade
With star-head and Torx T25
– Adjust the damping for rear wheel (►► 67).
- 3** Torx wrench, T25/T30
T25 on short end, T30 on long end
– Replacing high-beam headlight bulb (►► 131).
– Removing number-plate carrier.

Engine oil

Checking engine oil level

! The engine can seize if the oil level is low, and this can lead to accidents. Always make sure that the oil level is correct.◀

! The oil level varies with the temperature of the oil. The higher the temperature, the higher the level of oil in the sump. Checking the oil level with the engine cold or after no more than a short ride will lead to misinterpretation; this in turn, means that the engine will be operated with the incorrect quantity of oil. In order to ensure that the engine oil level is read correctly, check the oil level only after a lengthy trip.◀

- Check that the engine is at operating temperature, make sure the ground is level and firm

and place the motorcycle on its centre stand.

- Allow the engine to idle until the fan starts up, then allow it to idle one minute longer.
- Switch off the engine and wait for about one minute to allow the oil to drain into the sump.
- Wipe the area around the oil filler neck clean.



- Remove oil dipstick **1** and wipe it with a clean, dry cloth.
- Seat the oil dipstick on the oil filler neck, but do not engage the threads.

- Remove the oil dipstick and check the oil level.

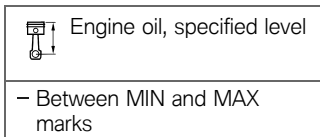
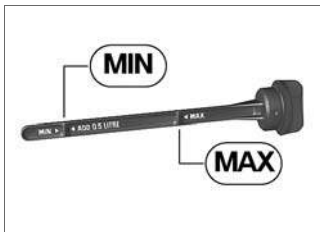

If the oil level is below the MIN mark:

- Top up the engine oil (➔ 115).

If the oil level is above the MAX mark:

- Have the oil level corrected by a specialist workshop,

preferably an authorised BMW Motorrad dealer.

- Install the oil dipstick.

Topping up engine oil

- Make sure the ground is level and firm and place the motorcycle on its stand.
- Wipe the area around the filler neck clean.

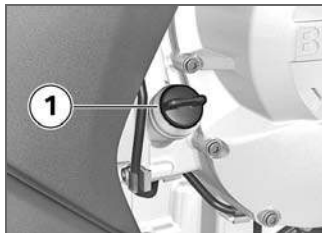

- Remove oil dipstick **1**.

 Damage to the engine can result if it is operated without enough oil, but the same

also applies if the oil level is too high.

Always make sure that the oil level is correct.◀

- Top up the engine oil to the specified level.
- Check the engine oil level (114).
- Install the oil dipstick.

Brake system

Checking operation of brakes

- Pull the handbrake lever.
 - » The pressure point must be clearly perceptible.
- Press the footbrake lever.
 - » The pressure point must be clearly perceptible.

If pressure points are not clearly perceptible:



Incorrect working practices endanger the reliability of the brakes.

Have all work on the brake system undertaken by trained and qualified specialists.◀

- Have the brakes checked by a specialist workshop, preferably an authorised BMW Motorrad dealer.

Checking front brake pad thickness

- Make sure the ground is level and firm and place the motorcycle on its stand.



- Visually inspect the left and right brake pads to ascertain their thickness. Viewing dir-

ection: between wheel and front suspension toward brake pads **1**.

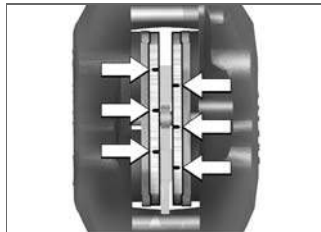

Brake-pad wear limit, front

– min 1.0 mm (Friction pad only, without backing plate. The wear indicators (grooves) must be clearly visible.)

If the wear indicating marks are no longer clearly visible:

 Brake pads worn past the minimum permissible thickness can cause a reduction in braking efficiency and under certain circumstances they can cause damage to the brake system.

In order to ensure the dependability of the brake system, do not permit the brake pads to wear past the minimum permissible thickness. ◀

- Have the brake pads replaced by a specialist workshop, preferably an authorised BMW Motorrad dealer.

Checking rear brake pad thickness

- Make sure the ground is level and firm and place the motorcycle on its stand.

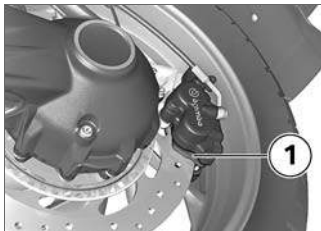

- Visually inspect the brake pads to ascertain their thickness. Viewing direction: from below toward brake pads **1**.

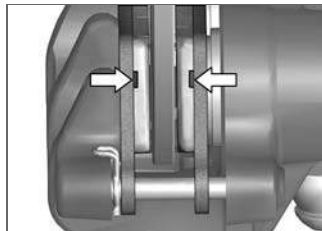

 Brake-pad wear limit, rear

- min 1.0 mm (Friction pad only, without backing plate. Do not permit wear to progress to the point at which the wear indicators (grooves) are reached.)

If the wear indicating mark is no longer visible:

 Brake pads worn past the minimum permissible thickness can cause a reduction in braking efficiency and under

certain circumstances they can cause damage to the brake system.

In order to ensure the dependability of the brake system, do not permit the brake pads to wear past the minimum permissible thickness.◀

- Have the brake pads replaced by a specialist workshop, preferably an authorised BMW Motorrad dealer.

Checking brake-fluid level, front brakes

 A low fluid level in the brake reservoir can allow air to penetrate the brake system. This significantly reduces braking efficiency.

Check the brake-fluid level at regular intervals.◀

- Make sure the ground is level and firm and place the motorcycle on its centre stand.



- Check the brake fluid level in front reservoir **1**.

 Wear of the brake pads causes the brake fluid level in the reservoir to sink. The drop in fluid level is compensated by a clearly visible black rubber diaphragm.◀



Brake fluid level, front

– DOT4 brake fluid

– It is impermissible for the brake fluid level to drop below the MIN mark. (Brake-fluid reservoir horizontal, motorcycle upright and handlebars centred)

If the brake fluid level drops below the permitted level:

- Have the defect rectified as quickly as possible by a specialist workshop, preferably

an authorised BMW Motorrad dealer.

If the bottom edge of the black diaphragm in the brake-fluid reservoir is below the MAX mark:

- Check the front brake pad thickness (➔ 116).

Checking brake-fluid level, rear brakes

 A low fluid level in the brake reservoir can allow air to penetrate the brake system. This significantly reduces braking efficiency.

Check the brake-fluid level at regular intervals.◀

- Make sure the ground is level and firm and place the motorcycle on its centre stand.

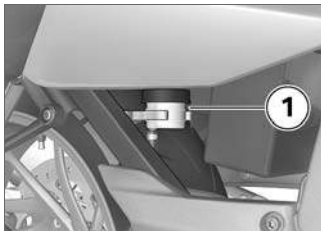

- Check the brake fluid level in rear reservoir **1**.

▶ Wear of the brake pads causes the brake fluid level in the reservoir to sink.◀



 Brake fluid level, rear

– DOT4 brake fluid

– It is impermissible for the brake fluid level to drop below the MIN mark. (Brake-fluid reservoir horizontal, motorcycle upright)

If the brake fluid level drops below the permitted level:

- Have the defect rectified as quickly as possible by a specialist workshop, preferably an

authorised BMW Motorrad dealer.

Coolant

Checking coolant level

- Make sure the ground is level and firm and place the motorcycle on its stand.
- Allow the engine to cool down.

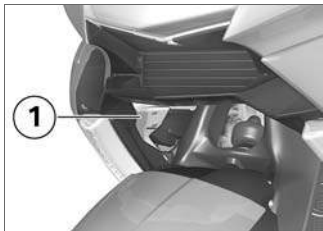

- Check the coolant level in expansion tank **1**.

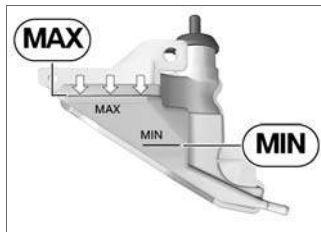

Coolant, specified level

– between MIN and MAX marks on the expansion tank (engine cold)

If the coolant drops below the permitted level:

- Have the defect rectified as quickly as possible by a specialist workshop, preferably an authorised BMW Motorrad dealer.

Clutch

Checking clutch operation

- Pull the clutch lever.
 - » The pressure point must be clearly perceptible.
- If the pressure point is not clearly perceptible:

- Have the clutch checked by a specialist workshop, preferably an authorised BMW Motorrad dealer.

Checking clutch fluid level

- Make sure the ground is level and firm and place the motorcycle on its centre stand.
- Move the handlebars to the straight-ahead position.



- Check the clutch fluid level in reservoir **1**.

▶ Wear of the clutch causes the fluid level in the clutch fluid reservoir to rise.◀

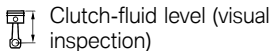

Clutch-fluid level (visual inspection)

– It is impermissible for the clutch fluid level to drop.

If the clutch-fluid level drops:

 Unsuitable hydraulic fluids could cause damage to the clutch system.

Do not attempt to top up the system with fluids of any kind.◀

- Have the defect rectified as quickly as possible by a specialist workshop, preferably an authorised BMW Motorrad dealer.

Rims and tyres

Checking rims

- Make sure the ground is level and firm and place the motorcycle on its stand.
- Visually inspect the rims for defects.
- Have damaged rims checked and, if necessary, replaced by a specialist workshop, preferably an authorised BMW Motorrad dealer.

Checking tyre tread depth

 Your motorcycle's handling and grip can be impaired even before the tyres wear to

the minimum tyre tread depth permitted by law.

Have the tyres changed in good time before they wear to the minimum permissible tread depth.◀

- Make sure the ground is level and firm and place the motorcycle on its stand.
- Measure the tyre tread depth in the main tread grooves with wear marks.

▶ Tyres have wear indicators integrated into the main tread grooves. The tyre is worn out when the tyre tread has worn down to the level of the marks. The locations of the marks are indicated on the edge of the tyre, e.g. by the letters TI, TWI or by an arrow.◀

If the tyre tread is worn to minimum:

- Replace tyre or tyres, as applicable.

Wheels

Tyre recommendation

For each size of tyre BMW Motorrad tests and classifies as roadworthy certain makes. BMW Motorrad cannot assess the suitability or provide any guarantee of road safety for other tyres.

BMW Motorrad recommends using only tyres tested by BMW Motorrad.

You can obtain detailed information from your authorised BMW Motorrad dealer or on the Internet at www.bmw-motorrad.com.

Effect of wheel size on suspension-control systems

Wheel size is very important as a parameter for the running-gear control systems ABS and DTC. In particular, the diameter and the width of a motorcycle's wheels

are programmed into the control unit and are fundamental to all calculations. Any change in these influencing variables, caused for example by a switch to wheels other than those installed ex-works, can have serious effects on the performance of the control systems.

The sensor rings are essential for correct road-speed calculation, and they too must match the motorcycle's control systems and consequently cannot be changed.

If you decide that you would like to fit non-standard wheels to your motorcycle, it is very important to consult a specialist workshop beforehand, preferably an authorised BMW Motorrad dealer. In some cases, the data programmed into the control units can be changed to suit the new wheel sizes.

RDC label

- with tyre pressure monitoring (RDC)^{OE}

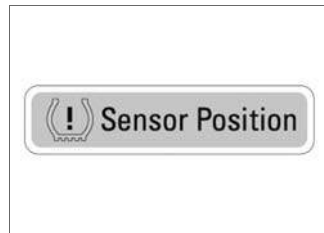

 Incorrect tyre fitting can damage the RDC sensors. Be sure to explain to the authorised BMW Motorrad dealer or the specialist workshop that the wheel is fitted with an RDC sensor. ◀

If the motorcycle is equipped with RDC, each wheel rim bears an adhesive label indicating the position of the RDC sensor. When changing the tyre, take

care not to damage the RDC sensor. Be sure to draw the attention of the authorised BMW Motorrad dealer or specialist workshop to the fact that the wheel is fitted with an RDC sensor.

Remove the front wheel

- Make sure the ground is level and firm and place the motorcycle on its centre stand.



- Remove screws **1** on left and right.
- Pull the front-wheel cover forward to remove.

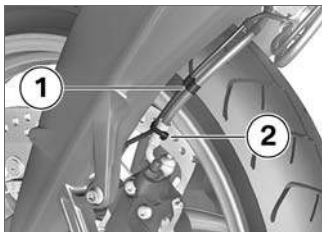

- Unclip retaining clip **1** of the sensor cable from the brake line.
- Remove cable tie **2**.
- Mask off the parts of the wheel rim that could be scratched in the process of removing the brake calipers.

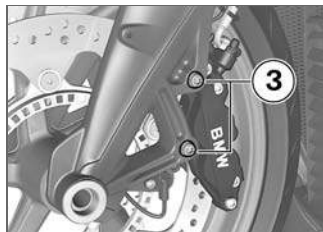

! Once the calipers have been removed, there is a risk of the brake pads being pressed together to the extent that they cannot be slipped back over the brake disc on reassembly.

Do not operate the handbrake lever when the brake calipers have been removed. ◀

- Remove screws **3** of the brake calipers on left and right.

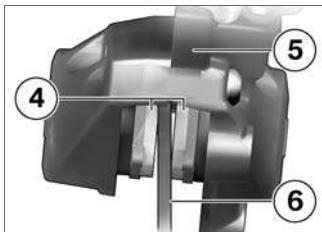

- Force the brake pads **4** slightly apart by rocking brake caliper **5** back and forth against brake disc **6**.
- Carefully pull the brake calipers back and out until clear of the brake discs.

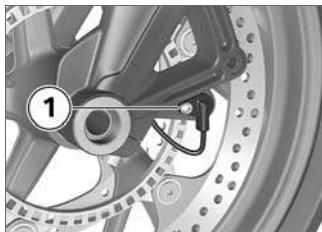

- Remove screw **1** and remove the ABS sensor from its bore.
- Raise front of motorcycle until the front wheel can turn freely. BMW Motorrad recommends the BMW Motorrad front-wheel stand for lifting the motorcycle.
- Install the front-wheel stand (➔ 128).

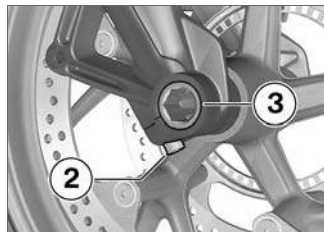

! The left axle clamping screw locates the threaded bush in the front suspension. If the threaded bush is not correctly aligned the gap between the ABS sensor ring and the ABS sensor will not be correct and this can cause the ABS to malfunction or allow the ABS sensor to be damaged. In order to ensure that the threaded bush remains correctly aligned, do not slacken or remove the left axle clamping screw. ◀

- Remove right-hand axle clamping screw **2**.
- Remove quick-release axle **3**, while supporting the wheel.
- Roll the front wheel forward to remove.

Installing front wheel

 Possible malfunctions when ABS and DTC systems intervene if non-standard wheels are installed.

See the information on the effect of wheel size on the ABS and DTC systems at the start of this chapter. ◀

 Threaded fasteners not tightened to the specified torque can work loose or their threads can suffer damage. Always have the security of the fasteners checked by a specialist workshop, preferably an authorised BMW Motorrad dealer. ◀

 The front wheel must be installed right way round to rotate in the correct direction. Note the direction-of-rotation arrows on the tyre or the wheel rim. ◀

- Roll the front wheel into position between the front forks.

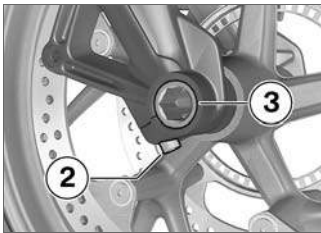

- Raise the front wheel, insert quick-release axle **3** and tighten to specified torque.

 Quick-release axle in threaded bush (wheel carrier)

– 50 Nm

- Tighten right axle clamping screw **2** to the specified tightening torque.

 Clamping screw for quick-release axle to wheel carrier

– 19 Nm

- Remove the front-wheel stand.

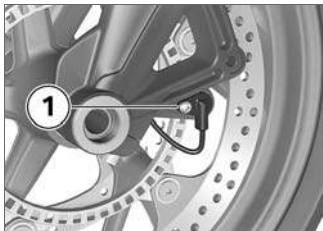

- Insert the ABS sensor into its bore and install screw **1**.
- Ease the brake calipers on to the brake discs.

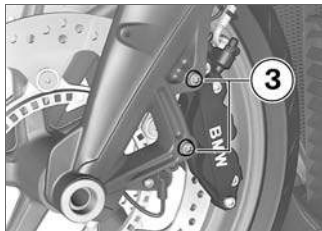

- Install securing screws **3** on left and right and tighten to specified tightening torque.



Front brake caliper to
wheel carrier

– 30 Nm

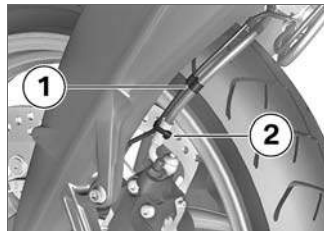

- Clip retaining clip **1** of the sensor cable to the brake line.
- Secure new cable tie **2**.
- Remove the adhesive tape from the wheel rim.
- Firmly pull the handbrake lever until the pressure point is perceptible, and repeat this operation several times.

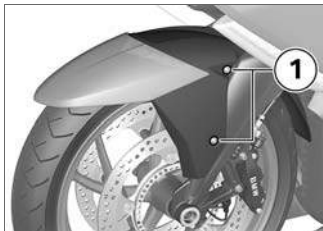

- Hold the front-wheel cover in position and install bolts **1** on left and right.

Remove the rear wheel

- Make sure the ground is level and firm and place the motorcycle on its centre stand.
- If applicable, remove the cases.

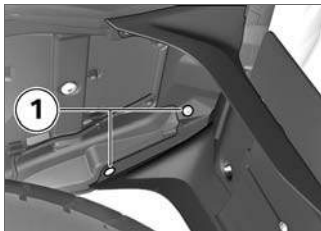

- Remove screws **1** on left and right.
- Remove the number-plate carrier.
- Engage first gear.

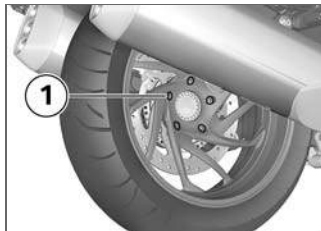

-  Risk of burns caused by the hot exhaust system. Do not touch the exhaust system when it is hot; if necessary, allow the exhaust system ample time to cool before proceeding. ◀
- Remove five bolts **1** from the rear wheel, while supporting the wheel.
- Lower the rear wheel to the ground and roll it out to the rear.

Installing rear wheel



Possible malfunctions when ABS and DTC systems intervene if non-standard wheels are installed.

See the information on the effect of wheel size on the ABS and DTC systems at the start of this chapter. ◀



Threaded fasteners not tightened to the specified torque can work loose or their threads can suffer damage.

Always have the security of the fasteners checked by a specialist workshop, preferably an authorised BMW Motorrad dealer. ◀

- Roll the rear wheel into position at the rear-wheel adapter and attach it.



- Fit five bolts **1** and tighten to the specified torque in diagonally opposite sequence.



Rear wheel to wheel flange

– Tightening sequence: tighten in diagonally opposite sequence

– 60 Nm

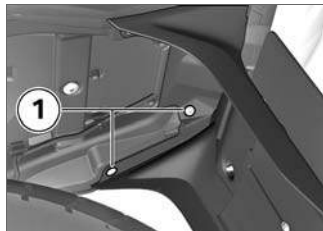

- Hold the number-plate carrier in position.
- Install screws **1** on left and right.

Front-wheel stand

Installing front-wheel stand



The BMW Motorrad front wheel stand is not designed to support motorcycles not fitted with a centre stand or without other auxiliary stands. A motorcycle resting only on the front wheel stand and the rear wheel can topple.

Place the motorcycle on its centre stand or another auxiliary stand before lifting the front wheel with the BMW Motorrad front-wheel stand.◀

- Use basic stand with tool number (83 30 0 402 241) in combination with front-wheel adapter (83 30 0 402 243).
- Make sure the ground is level and firm and place the motorcycle on its centre stand.

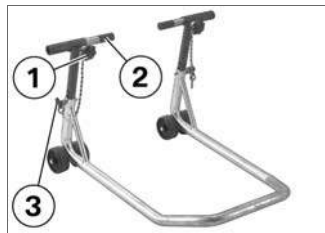

- Slacken adjusting screws **1**.

- Push the two pins **2** apart until the front suspension fits between them.
- Use locating pins **3** to set the front-wheel stand to the desired height.
- Centre the front-wheel stand relative to the front wheel and push it against the front axle.



- ⚠ There is a risk of damaging the sensor ring of the BMW Motorrad Integral ABS. Push the left pin in just far enough to ensure that it clears the sensor ring.◀

- Push both mounting pins **2** through the triangles of the brake caliper anchorages just far enough to allow the front wheel to be rolled between them.
- Tighten adjusting screws **1**.



- ⚠ If the motorcycle is on the centre stand and is raised too far, the centre stand will lift clear of the ground and the motorcycle could topple to one side. When raising the motorcycle, make sure that the centre stand remains on the ground.◀

- Apply uniform pressure to push the front-wheel stand down and raise the motorcycle.

Jump starting

 The wires leading to the power socket do not have a load-capacity rating adequate for jump-starting the engine. Excessively high current can lead to a cable fire or damage to the vehicle electronics.

Do not use the on-board socket to jump-start the engine of the motorcycle. ◀

 Touching live parts of the ignition system with the engine running can cause electric shock.

Do not touch parts of the ignition system when the engine is running. ◀

 A short-circuit can result if the crocodile clips of the jump leads are accident-

ally brought into contact with the motorcycle.

Use only jump leads fitted with fully insulated crocodile clips at both ends. ◀

 Jump-starting with a donor-battery voltage higher than 12 V can damage the vehicle electronics.

Make sure that the battery of the donor vehicle has a voltage rating of 12 V. ◀

- When jump-starting the engine, do not disconnect the battery from the on-board electrical system.
- Remove the front seat. (►► 60).
- Run the engine of the donor vehicle during jump-starting.
- Begin by connecting one end of the red jump lead to the positive terminal of the discharged battery and the other end to the positive terminal of the donor battery.
- Then connect one end of the black jump lead to the negative terminal of the donor battery, and the other end to the negative terminal of the discharged battery.
- Start the engine of the vehicle with the discharged battery in the usual way; if the engine does not start, wait a few minutes before repeating the attempt in order to protect the starter motor and the donor battery.
- Allow both engines to idle for a few minutes before disconnecting the jump leads.
- Disconnect the jump lead from the negative terminals first, then disconnect the second lead from the positive terminals.
- Install the front seat (►► 60).

Bulbs

General instructions

A warning appears in the multi-function display if a bulb is defective.

 A defective bulb places your safety at risk because it is easier for other users to oversee the motorcycle. Replace defective bulbs as soon as possible; always carry a complete set of spare bulbs if possible. ◀

 The types of bulb fitted to your motorcycle are listed in the section entitled "Technical data". ◀

 Do not touch the glass of new bulbs with your fingers. Use a clean, dry cloth to hold the bulbs when handling them. Dirt deposits, in particular oil and grease, interfere with heat radiation from the bulb. This leads

to overheating and shortens the bulb's operating life. ◀

Replacing high-beam headlight bulb

 The description below steps you through the procedure for replacing the left high-beam headlight bulb. Proceed by analogy to replace the right high-beam headlight bulb. ◀

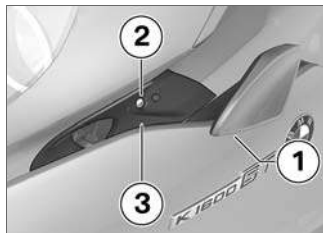

- Turn slipstream deflector **1** out.
- Remove screw **2** and work side cover **3** to the rear and remove.

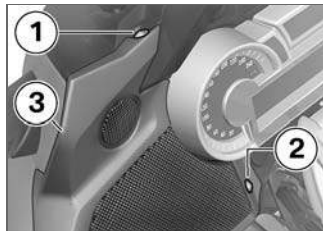

- Remove screw **1**.
- Switch on the ignition and raise the windscreen to its highest position.
- Remove screw **2** and work hand protector **3** to the side to remove.
- Switch off the ignition and wait until the windscreen has moved to its lowest position.

– with audio system with preparation for navigation device^{OE}

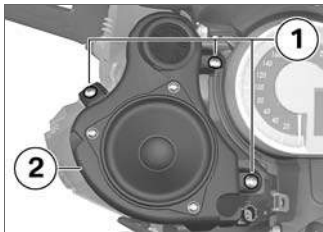

- Remove screws **1**.
- Work speaker unit **2** to the rear to remove.<

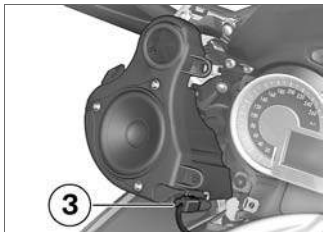

- Disconnect plug **3**.<

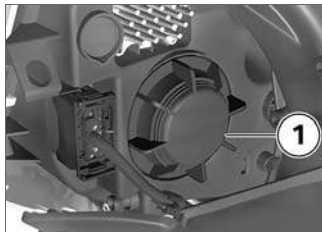

- Turn covers **1** counter-clockwise to remove.

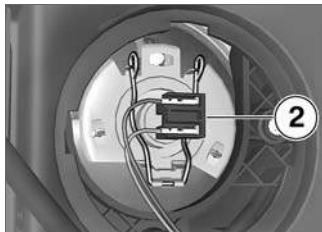

- Disconnect plug **2**.

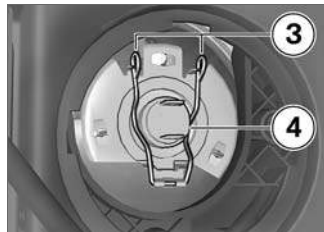

- Release spring clip **3** at left and right and swing it up.

! The bulb is pressurised and can cause injury if damaged. Wear protective goggles and gloves when changing bulbs.<

- Remove bulb **4**.
- Replace the defective bulb.



Bulb for high-beam headlight

– H7 / 12 V / 55 W

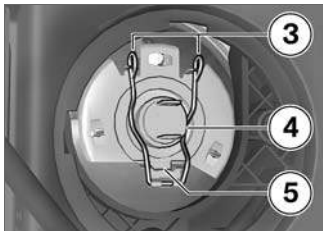

- Install bulb **4**, making sure that tab **5** is correctly positioned.
- Engage spring clip **3**.



- Connect plug **2**.

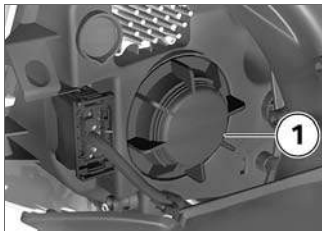

- Turn covers **1** clockwise to install.

– with audio system with preparation for navigation device^{OE}

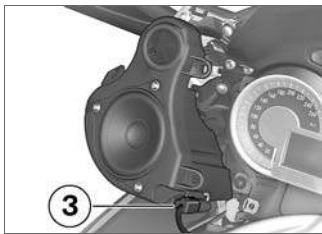

- Connect plug **3**.<

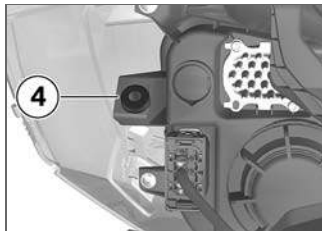

- Seat the speaker unit in mount **4**.<



- Install screws **1**.<
- Switch on the ignition and raise the windscreen to its highest position.

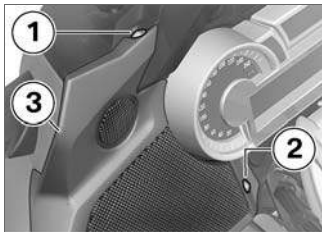

- Hold hand protector **3** in position and install screw **2**.
- Switch off the ignition and wait until the windscreen has moved to its lowest position.
- Install screw **1**.

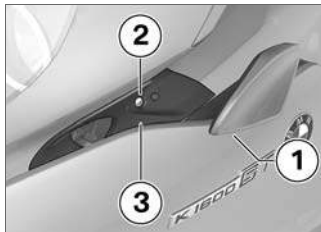

- Hold side cover **3** in position and install screw **2**.
- Align slipstream deflector **1**.

Battery

Maintenance instructions

Correct upkeep, recharging and storage will prolong the life of the battery and are essential if warranty claims are to be considered.

Compliance with the points below is important in order to maximise battery life:

- Keep the surface of the battery clean and dry
- Do not open the battery
- Do not top up with water
- Be sure to read and comply with the instructions for charging the battery on the following pages
- Do not turn the battery upside down



If the battery is not disconnected, the on-board electronics (e.g. clock, etc.) gradually drain the battery. This can cause the battery to run flat. If this happens, warranty claims will not be accepted.

Connect a float charger to the battery if the motorcycle is to remain out of use for more than four weeks. ◀



BMW Motorrad has developed a float charger specially designed for compatibility with the electronics of your mo-

torcycle. Using this charger, you can keep the battery charged during long periods of disuse, without having to disconnect the battery from the motorcycle's on-board systems. You can obtain additional information from your authorised BMW Motorrad dealer.◀

Charging battery when connected

 Charging the connected battery directly at the battery terminals can damage the vehicle electronics.

Always disconnect the battery from the on-board circuits before recharging it with a charger connected directly to the battery posts.◀

 If you switch on the ignition and the multifunction display and telltale lights fail to light up, the battery is completely flat (battery voltage is less than 9

V). Attempting to charge a completely flat battery via the on-board socket can cause damage to the motorcycle's electronics. If a battery has discharged to the extent that it is completely flat, it has to be disconnected from the on-board circuits and charged with the charger connected directly to the battery posts.◀

 Only chargers suitable for this mode of charging can be used to recharge the battery via the on-board socket. Unsuitable chargers could cause damage to the motorcycle's on-board electrics.

Use BMW chargers with the part numbers 71 60 7 688 864 (220 V) or, as applicable, 71 60 7 688 865 (110 V). If you are in doubt, disconnect the battery from the on-board systems and connect the charger directly to the battery.◀

- Charge via the power socket, with the battery connected to the motorcycle's on-board electrical system.

 The motorcycle's on-board electronics know when the battery is fully charged. The on-board socket is switched off when this happens.◀

- Comply with the operating instructions of the charger.

 If you are unable to charge the battery through the on-board socket, you may be using a charger that is not compatible with your motorcycle's electronics. If this happens, disconnect the battery from the on-board systems and connect the charger directly to the battery.◀

Charging battery when disconnected

- Charge the battery using a suitable charger.

- Comply with the operating instructions of the charger.
- Once the battery is fully charged, disconnect the charger's terminal clips from the battery terminals.

 The battery has to be recharged at regular intervals in the course of a lengthy period of disuse. See the instructions for caring for your battery. Always fully recharge the battery before restoring it to use ◀

Removing battery

- Remove the front seat. (➡ 60).
– with anti-theft alarm (DWA)^{OE}
- If applicable, switch off the anti-theft alarm. ◀
- Switch off the ignition.



 Disconnection in the wrong sequence increases the risk of short-circuits. Always proceed in the correct sequence. ◀

- Disconnect negative lead **1** first.
- Then open the cover and disconnect positive lead **2**.
- Remove screws **3** and remove the retainer.
- Lift the battery up and out; work it slightly back and forth if it is difficult to remove.

Installing battery

- Place the battery in the battery compartment, positive terminal on the right in the forward direction of travel.

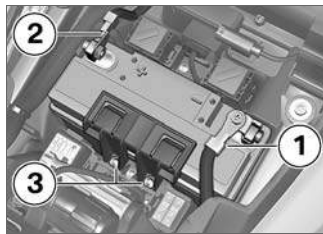

- Install the retainer and install screws **3**.

 Installation in the wrong sequence increases the risk of short-circuits. Always proceed in the correct sequence. ◀

- Connect battery positive lead **2** first and close the cover.

- Then connect battery negative lead **1**.
- Install the front seat (➡ 60).
- Switch on the ignition.
- Set the time in **Settings - Time** and set the date in **Settings - Date**.

Fuses

Replacing fuses

- Switch off the ignition.
- Remove the front seat. (➡ 60).

 Risk of fire if an attempt is made to jumper defective fuse.

Always replace defective fuses with new fuses of the correct amperage rating.◀

- Consult the fuse assignment diagram and replace the defective fuse.

 If fuse defects recur frequently have the electric circuits checked by a specialist workshop, preferably an authorised BMW Motorrad dealer.◀

- Install the front seat (➡ 60).

Fuse assignment

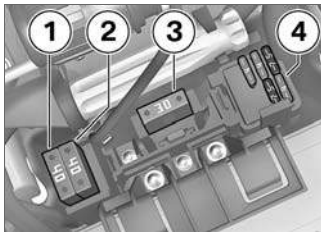

- | | |
|----------|--|
| 1 | 40 A
Motorcycle electronics |
| 2 | 40 A
Motorcycle electronics
– with Electronic Suspension Adjustment (ESA) ^{OE}
ESA |

- | | |
|-----------|--|
| 3 | 30 A
Engine electronics |
| 4 | fuse box open with fuses assignment as follows: |
| -1 | Not used |
| -2 | Not used |
| -3 | Not used |
| -4 | 4 A
Left handlebar fitting
– with tyre pressure monitoring (RDC) ^{OE}
RDC
– with topcase ^{OA}
Topcase light |
| -5 | Not used
– with preparation for audio system and navigation device ^{OE}
7,5
Audio system |
| -6 | 4 A
Beam throw adjustment
– with Adaptive Headlight ^{OE}
Adaptive cornering lights |

- 7** 4 A
Main relay, instrument panel, ignition switch
 - 8** Not used
 - with anti-theft alarm (DWA)^{OE}
 - or
 - with central locking^{OE}
- 7.5 A
Anti-theft alarm
Central locking

Care

Care products	140
Washing motorcycle	140
Cleaning easily damaged components.....	140
Paint care	141
Protective wax coating	142
Laying up motorcycle	142
Restoring motorcycle to use	142

Care products

BMW Motorrad recommends that you use the cleaning and care products you can obtain from your authorised BMW Motorrad dealer. The substances in BMW CareProducts have been tested in laboratories and in practice; they provide optimised care and protection for the materials used in your vehicle.

 The use of unsuitable cleaning and care products can damage vehicle components. Do not use solvents such as cellulose thinners, cold cleaners, fuel or the like, and do not use cleaning products that contain alcohol.◀

Washing motorcycle

BMW Motorrad recommends that you use BMW insect remover to soften and wash off insects and stubborn dirt on

painted parts prior to washing the motorcycle.

To prevent stains, do not wash the motorcycle immediately after it has been exposed to strong sunlight and do not wash it in the sun.

Make sure that the motorcycle is washed frequently, especially during the winter months.

To remove road salt, clean the motorcycle with cold water immediately after every trip.

 After the motorcycle has been washed, ridden through water or ridden in the rain, the brake discs and pads might be wet and the brakes might not take effect immediately.

Apply the brakes in good time until the brake discs and brake pads have dried out.◀

 Warm water intensifies the effect of salt.

Use only cold water to wash off road salt.◀

 The high pressure of high-pressure cleaners (steam cleaners) can damage seals, the hydraulic brake system, the electrical system, and the seat.

Do not use a steam jet or high-pressure cleaning equipment.◀

Cleaning easily damaged components

Plastics

 If plastic parts are cleaned using unsuitable cleaning agents, the surfaces can be damaged.

Do not use cleaning agents that contain alcohol, solvents or abrasives to clean plastic parts.

Even fly-remover pads or cleaning pads with hard surfaces can produce scratches.◀

Body panels

Clean the trim panels with water and BMW plastic care emulsion.

Windscreens and headlight lenses made of plastic

Clean off dirt and insects with a soft sponge and plenty of water.

 Soften stubborn dirt and insects by covering the affected areas with a wet cloth.◀

Chrome

Use plenty of water and BMW shampoo to clean chrome, particularly if it has been exposed to road salt. Use chrome polish for additional treatment.

Radiator

Clean the radiator regularly to prevent overheating of the engine due to inadequate cooling. For example, use a garden hose with low water pressure.



Cooling fins can be bent easily.

Take care not to bend the fins when cleaning the radiator.◀

Rubber

Treat rubber components with water or BMW rubber-care products.



Using silicone sprays for the care of rubber seals can cause damage.

Do not use silicone sprays or other care products that contain silicon.◀

Paint care

Washing the motorcycle regularly will help counteract the long-term effects of substances that damage the paint, especially if your motorcycle is ridden in areas with high air pollution or natural sources of dirt, for example tree resin or pollen.

Remove particularly aggressive substances immediately, however, as otherwise the paint can be affected or become discoloured. Substances of this nature include spilt fuel, oil, grease, brake fluid and bird droppings. We recommend BMW vehicle polish or BMW paint cleaner for this purpose.

Marks on the paintwork are particularly easy to see after the motorcycle has been washed. Remove stains of this kind immediately, using cleaning-grade benzene or petroleum spirit on a clean cloth or ball of cotton wool. BMW Motorrad recommends BMW tar remover for removing specks of tar. Remember to wax the parts treated in this way.

Protective wax coating

BMW Motorrad recommends applying only BMW car wax or products containing carnauba wax or synthetic wax.

It is time to re wax the paintwork when water "puddles" on the surface, instead of forming beads.

Laying up motorcycle

- Clean the motorcycle.
- Remove the battery (▶▶▶ 136).
- Spray the brake and clutch lever pivots and the main and side stand pivots with a suitable lubricant.
- Coat bright metal and chrome-plated parts with an acid-free grease (e.g. Vaseline).
- Stand the motorcycle in a dry room in such a way that there is no load on either wheel.



Before laying the vehicle up out of use, have the engine oil and the oil filter element changed by a specialist workshop, preferably an authorised BMW Motorrad dealer. Combine work for laying up/restoring to use with a BMW service or inspection.◀

Restoring motorcycle to use

- Remove the protective wax coating.
- Clean the motorcycle.
- Install a charged battery.
- Before starting: work through the checklist.

Technical data

troubleshooting chart	144
Threaded fasteners	145
Engine	146
Fuel.....	147
Engine oil	147
Clutch	148
Transmission	148
Rear-wheel drive.....	149
Running gear	149
Brakes	150
Wheels and tyres	151
Electrics	152
Anti-theft alarm	154
Frame	155
Dimensions	155

Weights.....	156
Riding specifications	156

troubleshooting chart

Engine does not start at all or is difficult to start.

Possible cause	Rectification
Side stand	Retract the side stand (➡ 82).
Gear engaged and clutch not disengaged	Select neutral or pull the clutch lever.
Clutch pulled before ignition was switched on	Switch on the ignition, then pull the clutch lever.
No fuel in tank	Refuel (➡ 87).
Battery flat	Charge the battery when connected (➡ 135).

Threaded fasteners

Front wheel	Value	Valid
Front brake caliper to wheel carrier		
M8 x 30 - 10.9	30 Nm	
Clamping screw for quick-release axle to wheel carrier		
M8 x 30	19 Nm	
Quick-release axle in threaded bush (wheel carrier)		
M24 x 1.5	50 Nm	
Rear wheel	Value	Valid
Rear wheel to wheel flange		
M10 x 1.25 x 40	tighten in diagonally opposite sequence	
	60 Nm	

Engine

Engine design	transverse straight-six four-stroke engine with four valves per cylinder and two overhead camshafts; liquid cooling, electronic fuel injection, integral six-speed cassette gearbox, dry-sump lubrication.
Displacement	1649 cm ³
Cylinder bore	72 mm
Piston stroke	67.5 mm
Compression ratio	12,2:1
Nominal output	118 kW, at engine speed: 7750 min ⁻¹
– with power reduction ^{OE}	79 kW, at engine speed: 7750 min ⁻¹
Torque	175 Nm, at engine speed: 5250 min ⁻¹
– with power reduction ^{OE}	150 Nm, at engine speed: 4750 min ⁻¹
Maximum engine speed	max 8500 min ⁻¹
Idle speed	900 ^{±50} min ⁻¹ , Engine at regular operating temperature

Fuel

Recommended fuel grade	Super unleaded 95 ROZ/RON 89 AKI
Usable fuel capacity	approx. 24 l
Reserve fuel	approx. 4 l

Engine oil

Engine oil, capacity	4.5 l, with filter change
products recommended by BMW Motorrad and generally admissible viscosity classes	
Castrol Power 1 Racing SAE 5W-40, API SL / JASO MA2	≥ -20 °C
SAE 5W-40, API SJ / JASO MA2	≥ -20 °C
SAE 10W-50, API SJ / JASO MA2	≥ -20 °C

Clutch

clutch type	Multiplate clutch running in oil bath
-------------	---------------------------------------

Transmission

gearbox type	Claw-shift 6-speed gearbox, integrated into engine block
Gearbox transmission ratios	1,617, Primary transmission ratio 1.941 (33:17 teeth), 1st gear 1.429 (30:21 teeth), 2nd gear 1.148 (31:27 teeth), 3rd gear 0.958 (23:24 teeth), 4th gear 0.806 (25:31 teeth), 5th gear 0.686 (24:35 teeth), 6th gear 0.913 (21:23 teeth), Angular drive 1.258 (39:31 teeth), Countershaft

Rear-wheel drive

Type of final drive	Shaft drive with bevel gears
Type of rear suspension	Cast-aluminium single swinging arm with BMW Motorrad Paralever
Number of teeth on rear-wheel drive (gear ratio)	2,75 (33:12)

Running gear

Front wheel

Type of front suspension	BMW Motorrad Duolever
Spring strut, front, type	Central suspension strut
– with Electronic Suspension Adjustment (ESA) ^{OE}	Central suspension strut with electrically adjustable damping.
Spring travel, front	125 mm, At wheel

Rear wheel

Type of rear suspension	Cast-aluminium single swinging arm with BMW Motorrad Paralever
Type of rear suspension	central suspension strut pivoted to lever system. Spring preload and rebound-stage damping steplessly adjustable.
– with Electronic Suspension Adjustment (ESA) ^{OE}	central suspension strut pivoted to lever system. Electrically adjustable damping and spring preload/spring rate.
Spring travel, rear	135 mm, At wheel

Brakes

Type of front brake	Hydraulically operated twin disc brake with 4-piston fixed calipers and floating brake discs
Brake-pad material, front	Sintered metal
Type of rear brake	Hydraulically operated disc brake with 2-piston floating caliper and fixed disc
Brake-pad material, rear	Organic material

Wheels and tyres

Recommended tyre sets	You can obtain an up-to-date list of approved tyres from your authorised BMW Motorrad dealer or on the Internet at " www.bmw-motorrad.com ".
Front wheel	
front wheel type	Cast aluminium, MT H2
front wheel rim size	3.50" x 17"
Tyre designation, front	120 / 70 ZR 17
Rear wheel	
rear-wheel type	Cast aluminium, MT H2
rear wheel rim size	6.00" x 17"
Tyre designation, rear	190 / 55 ZR 17
Tyre pressure	
Tyre pressure, front	2.9 bar, Tyre cold
Tyre pressure, rear	2.9 bar, Tyre cold

Electrics

Electrical rating of on-board socket	max 10 A, All sockets
Battery	
battery type	Gel battery
battery rated voltage	12 V
battery rated capacity	19 Ah
Technical data	
Spark plugs, manufacturer and designation	NGK LMAR8AI-8
Electrode gap of spark plug	0.8 mm, When new 1.0 mm, Wear limit
Lighting	
Bulb for high-beam headlight	H7 / 12 V / 55 W
Bulbs for the low-beam headlight	D1S / 35 W
Bulb for parking light	Lighting rings, integrated into headlight
Bulb for tail light/brake light	LED
Bulbs for flashing turn indicators, front	LED
Bulbs for flashing turn indicators, rear	LED

Fuses	
Fuse carrier 1	30 A, Engine electronics
Fuse carrier 2	40 A, Slot left: Vehicle electronics 40 A, Slot right: Vehicle electronics, ESA
Fuse box	Not used, Slot 1 Not used, Slot 2 Not used, Slot 3 4 A, Slot 4: Left handlebar fitting, tyre pressure monitoring (RDC), topcase interior light 7.5 A, Slot 5: Audio system 4 A, Slot 6: Beam throw control, Adaptive Headlight 4 A, Slot 7: Main relay, instrument cluster, ignition switch 7.5 A, Slot 8: Anti-theft alarm (DWA), central locking

Anti-theft alarm

– with anti-theft alarm (DWA)^{OE}

Anti-theft alarm

Time to active after activation	30 s
Alarm duration	26 s
Activation time between two alarms	10 s
Battery type	CR 123 A

Remote control

Range of the remote control	10 m
Signal frequency	25 kHz, Broadband
Transmission frequency	433.92 MHz
Battery type and rated voltage	CR 1632 lithium 3 V

Frame

Frame type	Cast light alloy weldment with bolt-on light-alloy rear frame
type plate location	Wheel carrier, front right
VIN location	Frame side section, front right (beside engine-oil filler neck)

Dimensions

Length of motorcycle	2324 mm, Across luggage carrier
– with topcase ^{OA}	2456 mm, over topcase
Height of motorcycle	1440 mm, To windscreen at DIN unladen weight
Width of motorcycle	1000 mm, Across mirrors 980 mm, without mirrors
Front-seat height	810...830 mm, Without rider
– with front seat, low ^{OE}	780...800 mm, Without rider
rider's inside-leg arc, heel to heel	1830...1870 mm, Without rider
– with front seat, low ^{OE}	1775...1810 mm, Without rider

Weights

Unladen weight	319 kg, DIN unladen weight, without cases, ready for road, 90 % load of fuel, without optional extras
Permissible gross weight	540 kg
Maximum payload	221 kg

Riding specifications

Top speed	>200 km/h
-----------	-----------

Service

BMW Motorrad service	158
BMW Motorrad service quality	158
BMW Motorrad mobility services - roadside assistance	158
BMW Motorrad service network	159
Maintenance work	159
Confirmation of maintenance work	160
Confirmation of service	165

BMW Motorrad service

Advanced technology requires specially adapted methods of maintenance and repair.



If maintenance and repair work is performed inexpertly, it could result in consequential damage and thus constitute a safety risk.

BMW Motorrad recommends you to have all the associated work on your motorcycle carried out by a specialist workshop, preferably an authorised BMW Motorrad dealer. ◀

Your authorised BMW Motorrad dealer can provide information on BMW services and the work undertaken as part of each service. Have all maintenance and repair work carried out confirmed in the "Service" chapter in this manual. Authorised BMW Motorrad dealers are supplied with the latest technical information and have

the necessary technical know-how. BMW Motorrad recommends that you contact your authorised BMW Motorrad dealer if you have questions regarding your motorcycle.

BMW Motorrad service quality

Along with its reputation for engineering quality and high reliability, BMW Motorrad is a byword for excellent quality of service.

To ensure that your BMW is always in optimum condition, BMW Motorrad recommends that you have the maintenance work required for your motorcycle carried out regularly, preferably by your authorised BMW Motorrad dealer. For generous treatment of claims submitted after the warranty period has expired, evidence of regular maintenance is essential.

Certain signs of wear, moreover, may otherwise not be noticed until it is too late to put them right at moderate cost. Your authorised BMW Motorrad dealer's mechanics know every detail of your motorcycle and can take remedial action if necessary before minor faults develop into serious problems. By having the necessary repairs done properly and in good time, you save time and money in the long run.

BMW Motorrad mobility services - roadside assistance

In the event of a breakdown, the BMW Motorrad mobility services available for each new BMW motorcycle enable you to access an extensive range of services such as breakdown assistance, motorcycle transportation etc. (details can differ from country to country). In the event of a breakdown,

contact the Mobile Service organisation of BMW Motorrad. The specialists will provide the necessary advice and assistance. You will find important country-specific contact addresses and the after-sales service organisation phone numbers in the "Service Kontakt / Service Contact" brochures, along with information on Mobile Service and the dealership network.

BMW Motorrad service network

BMW Motorrad has an extensive after-sales service network in place to look after you and your motorcycle in more than 100 countries. In Germany alone, you have the best possible access to approximately 200 authorised BMW Motorrad dealers.

All information concerning the international dealership network can be found in the brochure

"Service Contact Europe" or "Service Contact Africa, America, Asia, Australia, Oceania".

Maintenance work

BMW Pre-delivery Check

Your authorised BMW Motorrad dealer conducts the BMW pre-delivery check before handing over the motorcycle to you.

BMW Running-in Check

The BMW running-in check has to be performed when the motorcycle has covered between 500 km and 1200 km

BMW Service

The BMW Service is carried out once a year; the extent of servicing can vary, depending on the age of the motorcycle and the distance it has covered. Your authorised BMW Motorrad dealer confirms that the service work has been carried out and enters

the date when the next service will be due.

Riders who cover long distances in a year might have to bring in their motorcycles for service before the next scheduled date. It is to allow for these cases that a maximum odometer reading is entered as well in the confirmation of service. Servicing has to be brought forward if this odometer reading is reached before the next scheduled date for the service.

The service-due indicator in the multifunction display reminds you about one month or 1000 km in advance when the time for a service is approaching, on the basis of the programmed values.

Confirmation of maintenance work

BMW Pre-delivery Check

Completed

on _____

Stamp, signature

BMW Running-in Check

Completed

on _____

Odometer reading _____

Next service
at the latest

on _____

or, if logged beforehand,

Odometer reading _____

Stamp, signature

BMW Service

Completed

on _____

Odometer reading _____

Next service
at the latest

on _____

or, if logged beforehand,

Odometer reading _____

Stamp, signature**BMW Service**

Completed

on _____

Odometer reading _____

Next service
at the latest

on _____

or, if logged beforehand,

Odometer reading _____

Stamp, signature**BMW Service**

Completed

on _____

Odometer reading _____

Next service
at the latest

on _____

or, if logged beforehand,

Odometer reading _____

Stamp, signature

BMW Service

Completed

on _____

Odometer reading _____

Next service
at the latest

on _____

or, if logged beforehand,

Odometer reading _____

Stamp, signature**BMW Service**

Completed

on _____

Odometer reading _____

Next service
at the latest

on _____

or, if logged beforehand,

Odometer reading _____

Stamp, signature**BMW Service**

Completed

on _____

Odometer reading _____

Next service
at the latest

on _____

or, if logged beforehand,

Odometer reading _____

Stamp, signature

BMW Service

Completed

on _____

Odometer reading _____

Next service
at the latest

on _____

or, if logged beforehand,

Odometer reading _____

Stamp, signature**BMW Service**

Completed

on _____

Odometer reading _____

Next service
at the latest

on _____

or, if logged beforehand,

Odometer reading _____

Stamp, signature**BMW Service**

Completed

on _____

Odometer reading _____

Next service
at the latest

on _____

or, if logged beforehand,

Odometer reading _____

Stamp, signature

BMW Service

Completed

on _____

Odometer reading _____

Next service
at the latest

on _____

or, if logged beforehand,

Odometer reading _____

Stamp, signature**BMW Service**

Completed

on _____

Odometer reading _____

Next service
at the latest

on _____

or, if logged beforehand,

Odometer reading _____

Stamp, signature**BMW Service**

Completed

on _____

Odometer reading _____

Next service
at the latest

on _____

or, if logged beforehand,

Odometer reading _____

Stamp, signature

Confirmation of service

The table is intended as a record of maintenance and repair work, the installation of optional accessories and, if appropriate, special campaign (recall) work.

Item	Odometer reading	Date

- A**
Abbreviations and symbols, 6
ABS
 Engineering details, 93
 Self-diagnosis, 83
 Warnings, 36
Ambient temperature
 Black ice warning, 36
Anti-theft alarm
 Operation, 73
 Telltale light, 18
 Warnings, 41
Auxiliary headlights
 Operation, 53
- B**
Battery
 Charging battery when connected, 135
 Charging battery when disconnected, 135
 Installation, 136
 Removal, 136
 Stowage, 17
 Technical data, 152
 Warning for battery charge current, 34
 Warning for battery voltage low, 35
BMW Motorrad service, 158
Brake fluid
 Checking fluid level, front, 118
 Checking fluid level, rear, 119
 Reservoir, front, 13
 Reservoir, rear, 13
Brake pads
 Checking front, 116
 Checking rear, 117
 Running in, 85
Brakes
 Adjusting brake lever, 66
 Checking operation, 116
 Safety instructions, 85
 Technical data, 150
Bulbs
 General instructions, 131
 Replacing high-beam headlight bulb, 131
 Technical data, 152
 Warning for bulb failure, 35, 36

- C**
Case
 Operation, 106
Central locking
 Operation, 69
Checklist, 82
Clock, 22
Clutch
 Adjusting clutch lever, 65
 Checking fluid level, 120
 Fluid reservoir, 11
 Technical data, 148
 Test, 120
Confirmation of maintenance work, 160
Coolant
 Checking fill level, 120
 Fill-level indicator, 13
 Warning, 33
Cruise-control system
 Control, 14
 Operation, 63
Currency, 7

D

- Damping
 - Adjuster, rear, 11
 - Adjusting, 67
- Dimensions
 - Technical data, 155

DTC

- Control, 14
- Engineering details, 96
- Self-diagnosis, 84
- switching on/off, 58
- Warning, 37

E

- Electrics
 - Technical data, 152
- Electronic immobiliser EWS
 - Warning, 33
- Emergency off switch (kill switch), 16, 55
- Engine
 - Control, 16
 - Ride mode, 16
 - Starting, 82
 - Technical data, 146

- Temperature gauge, 22

- Warning for engine electronics, 33, 34

Engine oil

- Checking fill level, 114
- Filler neck, 13
- Oil dipstick, 13
- Technical data, 147
- Topping up, 115
- Warning for engine oil level, 34

Equipment, 7**ESA**

- Control, 14
- Engineering details, 99
- Operation, 68

F**Frame**

- Technical data, 155

Front seat

- Adjusting seat height, 61
- Height adjuster, 17
- Lock, 11
- Removing and installing, 60

Front-wheel stand

- Installing, 128

Fuel

- Filler neck, 11
- Fill-level indicator, 22
- Refuelling, 87
- Technical data, 147
- Warning for fuel down to reserve, 33

Fuses, 152

- Position on the motorcycle, 17
- Replacing, 137

G**Gear indicator, 22****General views**

- Instrument panel, 18
- Left handlebar fitting, 14
- Left side of motorcycle, 11
- Multifunction display, 22
- Right handlebar fitting, 16
- Right side of motorcycle, 13
- Underneath the seat, 17
- Warning and telltale lights, 27

Grip heating

- Operation, 56

Ground lighting, 54

H
Handlebar fittings
 General view, left side, 14
 General view, right side, 16
Hazard warning flashers
 Control, 14
 Operation, 55
Headlight
 Adjusting for traffic driving on
 right/driving on left, 53
 Headlight beam-throw
 adjustment, 11
 Warnings, 40
Helmet holder, 17
High-beam headlight
 Switching on, 52
Horn, 14

I
Ignition
 Switching off, 44
 Switching on, 44
Immobiliser, 45
 Warning, 33

Instrument panel
 Ambient-light brightness
 sensor, 18
 Overview, 18

J
Jump starting, 130

K
Keys, 44

L
Laying up, 142
Lights
 Control, 14
 Headlight flasher, 14, 52
 High-beam headlight, 14
 Parking light, 52
 Switch on the high-beam
 headlight, 52
 Switching on low-beam
 headlight, 52
 Switching on the side lights, 52

M
Maintenance
 General instructions, 114
Maintenance intervals, 159
Mirrors
 Adjusting, 66
Mobility services, 158
Motorcycle
 Laying up, 142
 Parking, 86
 Restoring to use, 142
Multifunction display, 18
 Meaning of symbols, 23
 Operation, 46
 Overview, 22

N
Navigation devices
 Installation, 103
 Operation, 104
 Removal, 104

O

- Odometer and tripmeters, 22
 - Control, 14
 - Operation, 51
 - Resetting, 52
 - Select the readings, 51
- On-board computer
 - Ambient temperature, 24
 - Control, 14
 - Oil level, 25
 - Operation, 50
 - Range, 24
 - Reset the average values, 50
 - Stopwatch, 51
 - travel times, 51

P

- Parking, 86
- Parking light, 52
- Power socket, 13
 - Notes on use, 102
- Pre-ride check, 83

R

- Rear-wheel drive
 - Technical data, 149
- Refuelling, 87
- Remote control
 - registration, 71
 - Replacing battery, 73
 - synchronising, 72
- Reserve volume
 - Warning, 33
- Rev. counter, 18
- Ride mode
 - Adjusting, 59
 - Engineering details, 92
- Rider's Manual
 - Stowage, 17
- Running gear
 - Technical data, 149
- Running in, 84

S

- Safety instructions
 - Brakes, 85
 - General, 80

- Seat heating
 - Control, 11
 - Operation, 56
- Service, 158
 - Warning, 41
- Service-due indicator, 25
- Side stand
 - For starting, 82
- slipstream deflector, 62
- Spark plugs, 152
- Speedometer, 18
- Spring preload
 - Adjuster, rear, 11
 - Adjusting, 66
- Starting, 82
- Steering lock
 - Locking, 44
- Stopwatch
 - Operation, 51
- Storage compartment, 11
- Stowage compartment, 65
- Symbols
 - Meaning, 23

T

Technical data

- Battery, 152
- Brakes, 150
- Bulbs, 152
- Clutch, 148
- Dimensions, 155
- Electrics, 152
- Engine, 146
- Engine oil, 147
- Frame, 155
- Fuel, 147
- Rear-wheel drive, 149
- Running gear, 149
- Spark plugs, 152
- Standards, 7
- Transmission, 148
- Weights, 156
- Wheels and tyres, 151

Telltale lights, 18

- Overview, 27

Toolkit

- Contents, 114
- Stowage, 17

topcase

- Closing, 108
- Opening, 108
- Operation, 108

Torques, 145

- Transmission
- Technical data, 148

Transportation

- Lashing, 88

Travel times

- measuring, 51

troubleshooting chart, 144

Turn indicators

- Control, 14
- Operation, 54

Type plate, 13

Tyre pressure monitoring RDC

- Adhesive label for rim, 122
- Engineering details, 98
- Reading, 24
- Warnings, 38

Tyres

- Checking inflation pressure, 77
- Checking tread depth, 121
- Recommendation, 122

Running in, 85

- Table of tyre pressures, 17
- Technical data, 151

V

Vehicle identification number, 13

W

Warning lights, 18

- Overview, 27

Warnings

- Mode of presentation, 28

Warnings, overview, 29

Weights

- Payload table, 17
- Technical data, 156

Wheels

- Change of size, 122
- Checking rims, 121
- Installing front wheel, 125
- Installing rear wheel, 128
- Remove the front wheel, 123
- Remove the rear wheel, 127
- Technical data, 151

Windscreen
Adjusting, 61
Control, 14

Certifications

Remote Control for central locking system



Česky

Meta System S.p.A. tímto prohlašuje, že tento PF240009 je ve shodě se základními požadavky a dalšími příslušnými ustanoveními směrnice 1999/5/ES.

Dansk

Undertegnede Meta System S.p.A. erklærer herved, at følgende udstyr PF240009 overholder de væsentlige krav og øvrige relevante krav i direktiv 1999/5/EF.

Deutsch

Hiermit erklärt Meta System S.p.A., dass sich das Gerät PF240009 in Übereinstimmung mit den grundlegenden Anforderungen und den übrigen einschlägigen Bestimmungen der Richtlinie 1999/5/EG befindet.

Eesti

Käesolevaga kinnitab Meta System S.p.A. seadme PF240009 vastavust direktiivi 1999/5/EÜ põhinõuetele ja nimetatud direktiivist tulenevatele teistele asjakohastele sätetele.

English

Hereby, Meta System S.p.A., declares that this PF240009 is in compliance with the essential requirements and other relevant provisions of Directive 1999/5/EC.

Español

Por medio de la presente Meta System S.p.A. declara que el PF240009 cumple con los requisitos esenciales y cualesquiera otras disposiciones aplicables o exigibles de la Directiva 1999/5/CE.

Certifications

Ελληνική

ΜΕ ΤΗΝ ΠΑΡΟΥΣΑ Meta System S.p.A. ΔΗΛΩΝΕΙ
ΌΤΙ PF240009 ΣΥΜΜΟΡΦΩΝΕΤΑΙ ΠΡΟΣ ΤΙΣ
ΑΠΑΙΤΗΣΕΙΣ ΑΠΑΙΤΗΣΕΙΣ ΚΑΙ ΤΙΣ ΛΟΙΠΕΣ
ΣΧΕΤΙΚΕΣ ΔΙΑΤΑΞΕΙΣ ΤΗΣ ΟΔΗΓΙΑΣ 1999/5/ΕΚ.

Français

Par la présente Meta System S.p.A. déclare que
l'appareil PF240009 est conforme aux exigences
essentielles et aux autres dispositions pertinentes
de la directive 1999/5/CE.

Italiano

Con la presente Meta System S.p.A. dichiara che
questo PF240009 è conforme ai requisiti essenziali
ed alle altre disposizioni pertinenti stabilite dalla
direttiva 1999/5/CE.

Latviski

Ar šo Meta System S.p.A. deklarē, ka PF240009
atbilst Direktīvas 1999/5/ΕΚ būtiskajām prasībām
un citiem ar to saistītajiem noteikumiem.

Lietuvių

Šiuo Meta System S.p.A. deklaruoja, kad šis
PF240009 atitinka esminius reikalavimus ir kitas
1999/5/EB Direktyvos nuostatas.

Nederlands

Hierbij verklaart Meta System S.p.A. dat het toestel
PF240009 in overeenstemming is met de
essentiële eisen en de andere relevante bepalingen
van richtlijn 1999/5/EG.

Malti

Hawnhekk, Meta System S.p.A., jiddikjara li dan
PF240009 jikkonforma mal-ħtiġijiet essenzjali u ma
provdimenti oħrajn rilevanti li hemm fid-Dirrettiva
1999/5/EC.

Magyar

Alulírott, Meta System S.p.A. nyilatkozom, hogy a
PF240009 megfelel a vonatkozó alapvető
követelményeknek és az 1999/5/EC irányelv egyéb
előírásainak.

Polski

Niniejszym Meta System S.p.A. oświadcza, że
PF240009 jest zgodny z zasadniczymi wymogami
oraz pozostałymi stosownymi postanowieniami
Dyrektywy 1999/5/EC.

Português

Meta System S.p.A. declara que este PF240009
está conforme com os requisitos essenciais e
outras disposições da Directiva 1999/5/CE.

Certifications

Slovensko

Meta System S.p.A. izjavlja, da je ta PF240009 v skladu z bistvenimi zahtevami in ostalimi relevantnimi določili direktive 1999/5/ES.

Slovensky

Meta System S.p.A. týmto vyhlasuje, že PF240009 spĺňa základné požiadavky a všetky príslušné ustanovenia Smernice 1999/5/ES.

Suomi

Meta System S.p.A. vakuuttaa täten että PF240009 tyypinen laite on direktiivin 1999/5/EY oleellisten vaatimusten ja sitä koskevien direktiivin muiden ehtojen mukainen.

Svenska

Härmed intygar Meta System S.p.A. att denna PF240009 står i överensstämmelse med de väsentliga egenskapskrav och övriga relevanta bestämmelser som framgår av direktiv 1999/5/EG.

Slovenska

Hér með lýsir Meta System S.p.A. yfir því að PF240009 er í samræmi við grunnkröfur og aðrar kröfur, sem gerðar eru í tilskipun 1999/5/EC.

Norsk

Meta System S.p.A. erklærer herved at utstyret PF240009 er i samsvar med de grunnleggende krav og øvrige relevante krav i direktiv 1999/5/EF.

USA, Canada

Product name: TX BMW MR FCC ID: P3O98400 IC:4429A - TXBMWMR

This device complies with Part 15 of the FCC rules. Operation is subject to the following two conditions:

- (1) This device may not cause harmful interference, and
- (2) this device must accept any interference received, including interference that may cause undesired operation.



Any changes or modifications not expressly approved by the party responsible for compliance could void the user's authority to operate the equipment.

Declaration Of Conformity

R&TTE Declaration Of Conformity (DoC)

CE 0470

We:

Meta System S.p.A.

with the address:

Via Majakovskij 10 b/c/d/e
42124 Reggio Emilia -Italy

Declare

Under own responsibility that the product:

TX BMW MR

To which this declaration relates is in conformity with the essential requirements and other relevant requirements of the R&TTE Directive (1999/5/EC).

This product is in conformity with the following standards:

Health & Safety (art.3.1)

EN 60950-1

EMC (art.3.2)

ETSI EN 301 489-1/-3

Spectrum

ETSI EN 300 220 - 2

Human exposure

EN 62311

According to Directive 1999/5/CE

Reggio Emilia , 14/07/2010

Technical Director
Lasagni Cesare



Certifications

Fire Pressure Control TPC

FCC ID: MRXBC54MA4

C: 2546A-BC54MA4

This device complies with Part 15 of the FCC Rules and with RSS-210 of Industry Canada.

Operation is subject to the following two conditions:

- 1) This device may not cause harmful interference, and
- 2) This device must accept any interference received, including interference that may cause undesired operation.

WARNING: Changes or modifications not expressly approved by the party responsible for compliance could void the user's authority to operate the equipment. The term "IC:" before the radio certification number only signifies that Industry Canada technical specifications were met.

Details described or illustrated in this booklet may differ from the motorcycle's actual specification as purchased, the accessories fitted or the national-market specification. No claims will be entertained as a result of such discrepancies.

Dimensions, weights, fuel consumption and performance data are quoted to the customary tolerances.

The right to modify designs, equipment and accessories is reserved.

Errors and omissions excepted.

© 2010 BMW Motorrad

Not to be reproduced either wholly or in part without written permission from BMW Motorrad, After Sales.

Printed in Germany.

The most important data for a filling-station stop can be found in the following chart:

Fuel	
Recommended fuel grade	Super unleaded 95 ROZ/RON 89 AKI
Usable fuel capacity	approx. 24 l
Reserve fuel	approx. 4 l
Tyre pressure	
Tyre pressure, front	2.9 bar, Tyre cold
Tyre pressure, rear	2.9 bar, Tyre cold

BMW recommends 

Order No.: 01 41 8 526 791
12.2010, 1st edition

