

**DAELIM**

# OWNER'S MANUAL

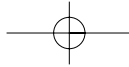
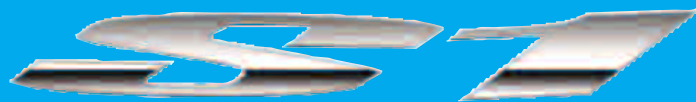
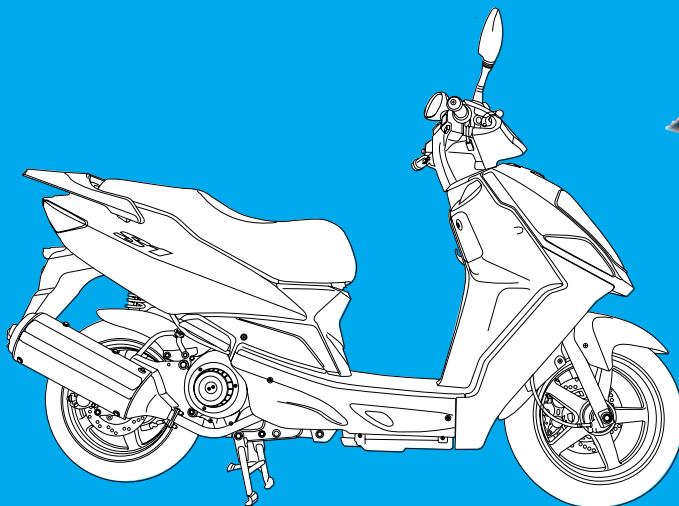

## IMPORTANT NOTICE

### WELCOME

Thank you for purchasing an Daelim vehicle. We hope you enjoy safe riding.

### OPERATOR AND PASSENGER

This motorcycle is designed to carry the operator and one passenger.

#### **▲ WARNING**

Attempting to change the pre-set maximum speed may cause danger and will void the Daelim warranty.

### ON-ROAD USE

This motorcycle is designed to be used only on the road.

### READ THIS OWNER'S MANUAL CAREFULLY

Pay special attention to statements preceded by the following words:

#### **▲ WARNING**

Indicates a strong possibility of severe personal injury or death if instructions are not followed.

#### **▲ CAUTION**

Indicates a possibility of personal injury or equipment damage if instructions are not followed.

#### **▲ NOTE**

Gives helpful information.

This manual is an important and integral part of your vehicle. keep it with your vehicle at all times, even though your vehicle is resold.

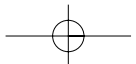



# CONTENTS

<p><b>SPECIFICATION</b> ..... 3</p> <p><b>OPERATION INSTRUCTION</b> ..... 4</p> <p>    <b>SAFETY PRECAUTIONS</b> ..... 4</p> <p>        PRIOR TO STARTING VEHICLE ..... 5</p> <p>        OPERATION ..... 5</p> <p>        CORRECT ATTIRE ..... 6</p> <p>        CARGO ..... 6</p> <p>        MODIFICATION ..... 7</p> <p>        ATTACHMENT ..... 7</p> <p>        MUFFLER ..... 7</p> <p>    <b>PARTS LOCATION</b> ..... 8</p> <p>    <b>METER READING AND USAGE</b> ..... 10</p> <p>        METER ..... 10</p> <p>        INDICATOR LAMPS ..... 10</p> <p>        SIDE STAND LAMP ..... 10</p> <p>        MALFUNCTION INDICATOR LAMP ..... 10</p> <p>    <b>SWITCH OPERATION</b> ..... 11</p> <p>        MAIN SWITCH ..... 11</p> <p>        START BUTTON ..... 12</p> <p>        HEADLIGHT ..... 12</p> <p>        WINKER SWITCH ..... 13</p> <p>        HORN BUTTON ..... 13</p> <p>        PASSING SWITCH ..... 13</p>	<p><b>EQUIPMENT USAGE</b> ..... 14</p> <p>    STEERING STEM LOCK ..... 14</p> <p>    SEAT LOCK ..... 14</p> <p>    TRUNK ..... 15</p> <p>    DOCUMENT STORAGE AREA ..... 15</p> <p>    BAG HOLDER ..... 15</p> <p>    <b>CORRECT DRIVING OPERATION</b> ..... 16</p> <p>        STARTING THE ENGINE ..... 16</p> <p>        IF ENGINE CANNOT BE STARTED ..... 18</p> <p>        AFTER STARTING ENGINE ..... 19</p> <p>        PROPER DRIVING METHODS ..... 20</p> <p>        STOPPING ..... 21</p> <p>    <b>SELF INSPECTIONS BEFORE OPERATION</b> ..... 23</p> <p>        INSPECTION OF CONCENED AREA ..... 24</p> <p>        BRAKE INSPECTION ..... 24</p> <p>        FUEL CHECK ..... 25</p> <p>        TIRE INSPECTION ..... 26</p> <p>        ENGINE OIL LEVEL CHECK ..... 27</p> <p>        LIGHTS AND WINKER INSPECTION ..... 28</p> <p>        BULB REPLACEMENT METHOD ..... 28</p> <p>        REAR VIEW MIRROR ..... 30</p> <p>        FUEL LEAK INSPECTION ..... 30</p>
---	--

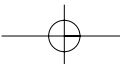



<b>MAINTENANCE</b> .....	31
MAINTENANCE SCHEDULE .....	32
MAINTENANCE PRECAUTIONS .....	34
BRAKES .....	34
BRAKE HOSE, PIPE LEAKAGE, DAMAGE, ASSEMBLY STATE .....	36
BRAKE PAD WEAR .....	36
CHANGING ENGINE OIL .....	37
TRANSMISSION OIL INSPECTION .....	38
WHEEL REMOVAL .....	39
CHANGING COOLING WATER .....	41
SPARK PLUG .....	41
BATTERY INSPECTION .....	42
FUSE REPLACEMENT .....	43
COUPLER CONNECTION .....	44
AIR CLEANER ELEMENT INSPECTION .....	44
SIDE STAND INSPECTION .....	45
CABLE RUBBER PART .....	45
CLEANING .....	46
GENERAL CLEANING / IMPORTANT .....	47
STORAGE GUIDE .....	47
FRAME AND ENGINE NUMBER .....	48

<b>SAFE DRIVING</b> .....	49
<b>PREPARATION BEFORE DRIVING</b> .....	49
<b>DRIVING METHOD</b> .....	50
DRIVING POSITION .....	50
TAKING POSE OF FELLOW PASSENGER .....	51
PRECAUTION WHEN DRIVING .....	52
STARTING .....	53
<b>TURNING METHOD</b> .....	54
PRINCIPLE OF TURN .....	54
EFFECT OF SPEED .....	54
3 POSITIONS OF TURNING .....	55
TURNING METHOD .....	56
PRECAUTION WHEN TURNING .....	57
<b>BRAKING METHOD</b> .....	58
BASIC PRINCIPLE OF BRAKE(FRICTION FORCE) .....	58
RESTRAINT OF BRAKING EFFECT (INERTIA) .....	58
BRAKING METHOD .....	59
COMPARISON OF BRAKING DISTANCE .....	59
IMPACT WHEN COLLISION .....	59
<b>WIRING DIAGRAM</b> .....	60

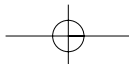

# SPECIFICATION

ITEM	DATA	ITEM	DATA
LENGTH ×WIDTH ×HEIGHT(mm)	1.965 × 702 × 1.120	IGNITION SYSTEM	TRANSISTOR
WHEEL BASE(mm)	1.350	BATTERY CAPACITY	12V10AH(MF TYPE)
GROUND CLEARANCE(mm)	126	FUEL CAPACITY( l )	9.6
SEAT HEIGHT(mm)	770	RESERVE FUEL CAPACITY( l )	2.2
DRY WEIGHT(kgf)	127	TIRE SIZE	FR. 120 / 70 - 13
PASSENGER	2		RR. 130 / 60 - 13
ENGINE TYPE	OIL- COOLED/AIR- COOLED 4 STROKE 4VALVE	SUSPENSION	FR. TELESCOPIC
			RR. UNIT SWING OIL DAMPER
PISTON DISPLACEMENT(cc)	124.9	BRAKE	FR. HYDRAULIC DISK
BORE AND STROKE(mm)	56 × 50.7		RR. HYDRAULIC DISK
STARTING SYSTEM	START MOTOR	SPARK PLUG	CR8EH-9
TRANSMISSION TYPE	V - MATIC	FUSE(A)	30A, 15A

## OPERATION INSTRUCTION

This manual describes matters pertaining to correct operation, safe operation and simple maintenance of the vehicle you purchased.

To ensure more comfortable and safer operation, make sure to read this manual carefully prior to operation.

- The photographs and drawings shown in this manual may differ from those of actual vehicles due to changes in vehicle specifications and modifications made.
- This vehicle is designed for 2 riders including the operator.

### CAUTION

- Do not use polluted gasoline.  
Otherwise, it cause rust inside the fuel tank, and close the supply of fuel to the injector, leading to an improper engine starting or may cause serious damage to an engine.
- Do use genuine oil.  
Then it will protect and extend vehicle life.
- Warranty does not apply to the motorcycles used in competitions or competitive trials. No motorcycle part may be tampered with, altered, or replaced with parts other than original Daelim spare parts during the warranty periody.
- As far as any defect caused by contaminated gasoline or oil, the warranty will be automatically invalidated.

## SAFETY PRECAUTIONS

- Careful driving and the wearing of proper attire and safety equipment are the most important factors in the safe operation of the scooter. Please obey traffic regulations and do not be hurried and careless.
- Many new vehicle owners operate their newly purchased vehicles with great care and attention to safety factors. However, after becoming accustomed to the operations are often discarded, which can lead to accidents. Please don't let this happen to you and always approach the operation of your vehicle with the safety considerations needed.  
When operating the vehicle, always keep in mind and obey the notes of precaution printed on the "Safety Precaution Label" attached to the vehicle.

- Be sure to wear helmet at all time.
- Be sure to put on gloves at all time.
- Always respect speed limits where these are posted.  
However, always adjust your speed to the visibility, road and traffic conditions you are riding in.
- Beware of muffler after driving as it is still hot to be burnt. Especially never children touch on it.
- For safety, do not change, alteration or modification the vehicle.
- Regularly conduct specified maintenance inspections.  
<Maintenance Inspection Points>  
Brakes, Tires, Oil, Lights, Horn, Instruments



## PRIOR TO STARTING VEHICLE

- Read user's manual carefully.
- Conduct maintenance checks prior to operation.
- Always maintain vehicle in clean status and carry out specified maintenance checks.
- Make sure to stop engine and stay away from fire when fueling.
- Exhaust gas contains harmful substance such as carbon monoxide. Start engine in well-ventilated places.

## OPERATION

- Operators should naturally fix bodies to keep smooth driving.
- Please check whether or not you are unnaturally strained and strung up.
- Driving pose has a great influence on safe operation.  
Please always maintain the center of your body in the middle of seat. Especially do not sit at the rear seat because it may lessen the weight of front wheel and cause trembling steering wheel.
- **Always hold** the handlebars firmly with both hands whiling driving. The pillion passenger should **always** hold on to the suitable grab handles at the sides of the seat with both hands. otherwise, it cause severe injury or death.
- When wanting to turn, slightly lean to body toward the direction of the turn. It is unsafe if the body is not moved in union with the vehicle.
- Curvy roads and poor, unpaved roads constantly change in surface quality. Driving on these roads can be unsafe if certain safety precautions are not followed.
- In order to safely drive through these driving conditions, anticipate coming road conditions, slow down to at least half the normal speed, and relax your shoulders and wrists while securely holding the handles.

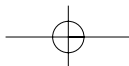



### CORRECT ATTIRE

- Be sure to wear helmet and gloves at all time for safty.
- Wear shirts or jackets with tight in the wheel driving.  
Otherwise it can be caught in the wheel to cause serious damage by overturn of vehicle.
- Many automobile/motorcycle accidents happen because the automobile driver does not "Look" the motorcyclist.
  - Wear bright or reflective clothing.
  - Don't ride in another motorist's "blind spot".
- Be sure to wear dress to catch an eye to avoid any crash from behind.

#### ▲ WARNING

- Be sure you and your passenger always wear a helmet, eye protection and other protective apparel when you ride.
- Not wearing a helmet increases the chance of serious injury or death in a crash.

Wear shirts or jackets with tight.



Be sure to wear helmet at all time and the helmet chin strap securely fastened.

Always put on gloves.

Choose fitting and low-heeled shoes.

### CARGO

- When carrying cargo, you must keep in mind that operating the motorcycle, especially when turning, will be different.
- Make sure not to overload the motorcycle with goods as this can make the motorcycle unstable during operation.

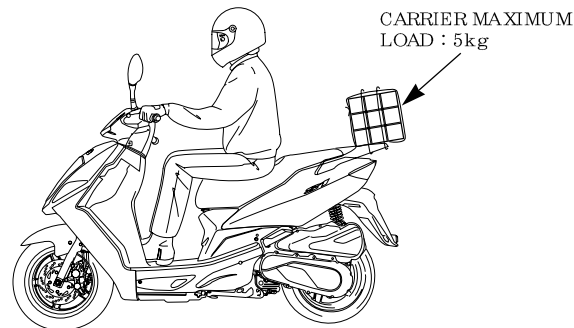

#### ▲ CAUTION

- Pay attention not to overload goods and fasten it tightly whiling driving.
- Do not place articles between the frame body cover and engine as it is hot to be burnt.
- Do not place kind of cloth materials nearby oil tank cap. If the hole in oil tank cap is clogged, oil will not flow freely into the engine which can cause severely engine damage.
- Do not attach large or heavy items (such as a sleeping bag or tent) to the handle bars, fork, or fender. Unstable handling or slow steering response may result.

## MODIFICATION

- Modification of vehicle structure or function deteriorates manipulatability or causes exhaust noise to become louder shortening the vehicle life. These modifications are not only prohibited by law but also are the acts harmful to other people. Modifications are not covered by warranty.

### ⚠ CAUTION

- As far as any defect caused by modifications, the warranty will be automatically invalidated.

## ATTACHMENT

- Except designated attachment by DAELIM MOTOR CO., LTD., don't attach any extra lighting device, because it may cause an early discharging of battery.
- Carefully inspect the accessory to make sure it does not obscure any lights, reduce ground clearance and banking angle, or limit suspension travel, steering travel or control operation.
- Do not add electrical equipment that will exceed the motorcycle's electrical system capacity. A blown fuse could cause a dangerous loss of lights or engine power.

### ⚠ WARNING

- Improper accessories or modifications can cause a crash in which you can be seriously hurt or killed.
- Follow all instructions in this manual regarding accessories and modification.

## MUFFLER

- Pay particular attention to fellow passenger so that he/she can prevent getting burnt by the hot muffler during travel.

### ⚠ CAUTION

- Beware of muffler after driving as it is still hot to be burnt. Especially never children touch on it. And pay attention to park where pedestrian zoon.
- If haystack or vinyl is stuck to the muffler, it might be fired.

## PARTS LOCATION

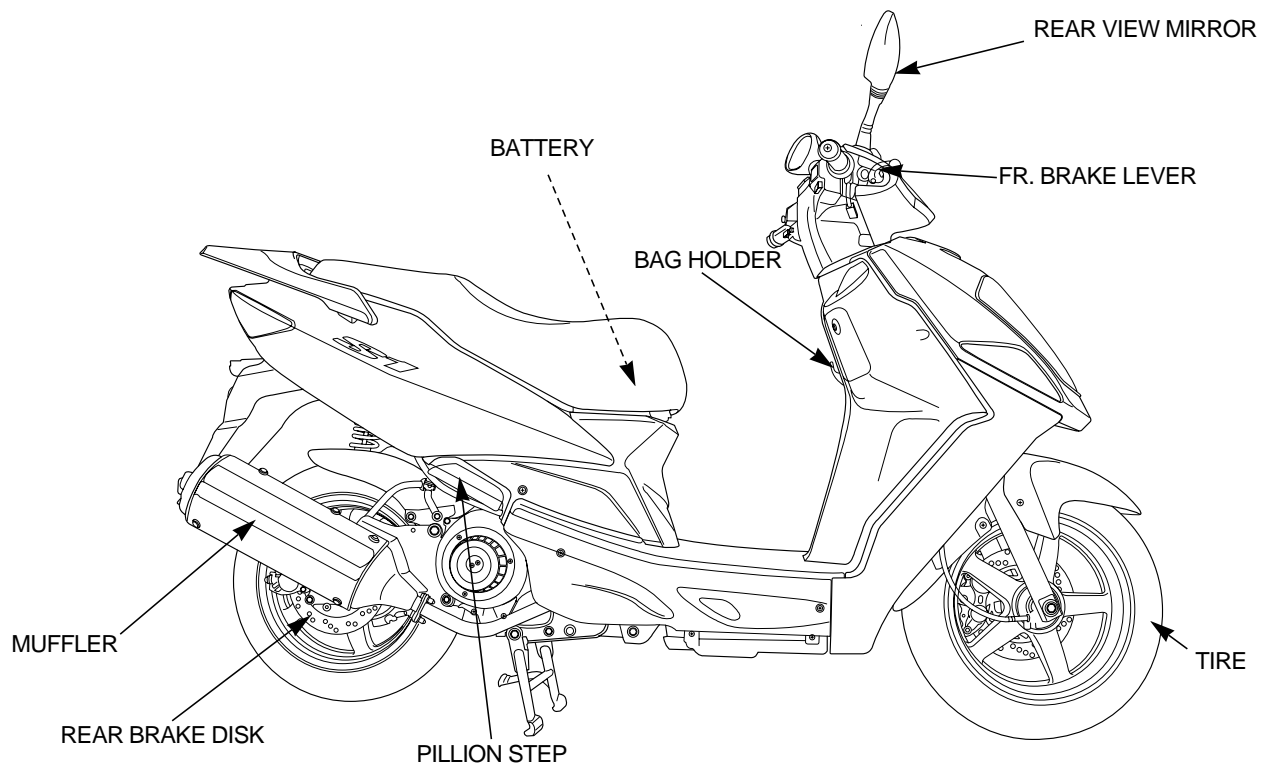

## PARTS LOCATION

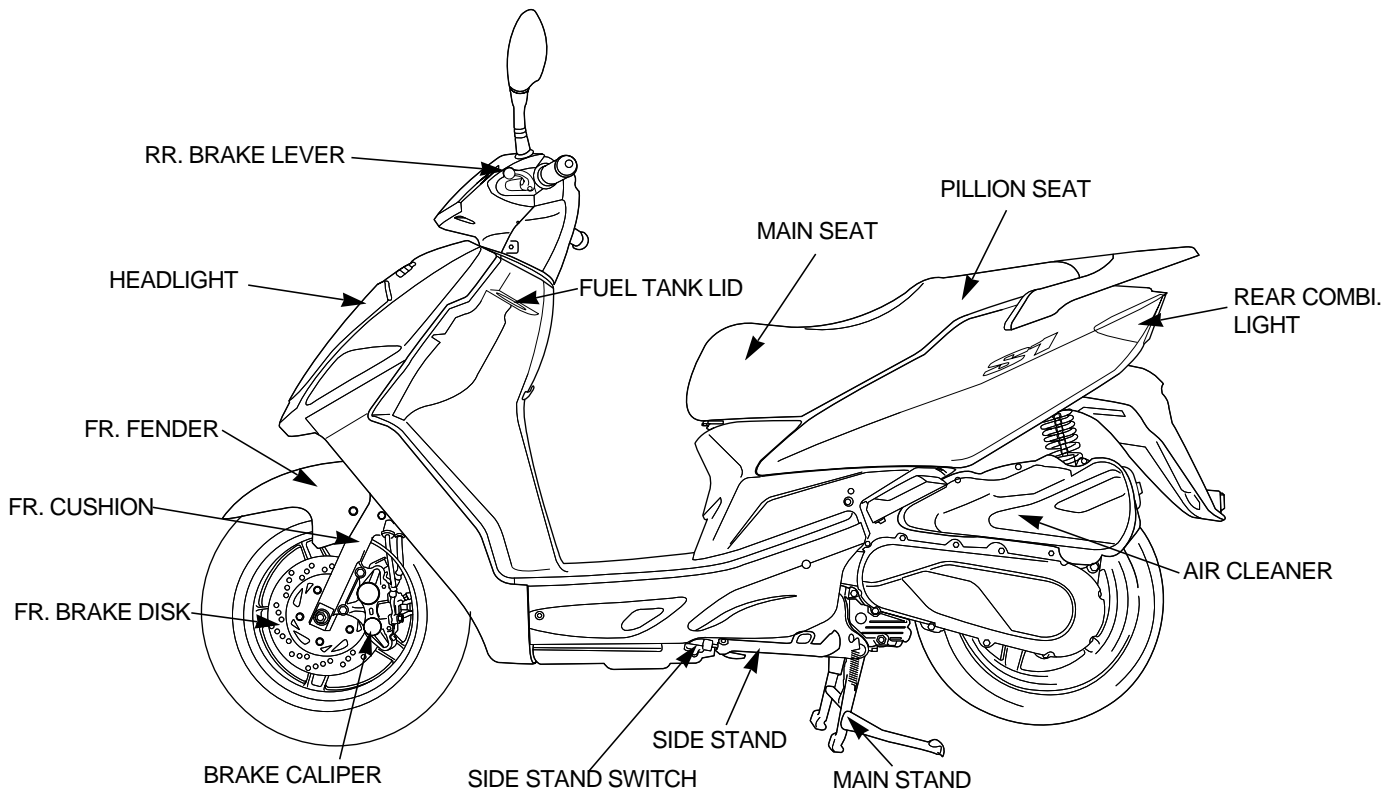

## METER READING AND USAGE

### METER

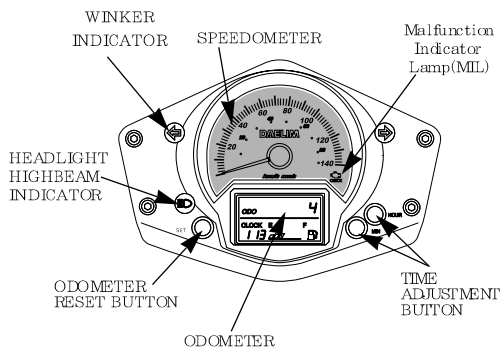

#### <SPEEDOMETER>

Indicates driving speed. Maintain legal speed limits to ensure safe operation.

#### <ODOMETER>

Indicates total distance in kilometers travelled by the vehicle.

#### <FUEL METER>

The fuel meter indicates the gasoline level inside the fuel tank.

Gasoline should be put in the fuel tank as soon as possible if the needle is resting in the red area.

**FUEL TANK CAPACITY : 9.6 ℓ**

**RESERVIOR CAPACITY : 2.2 ℓ**

#### <FUEL WARNING INDICATOR>

When the fuel is low, the fuel warning indicator turns on.

When this happens, fill the fuel tank with the gasoline.

#### ▲ WARNING

- To avoid running out of fuel, it might cause severe injury due to engine abruptly stop.

### INDICATOR LAMPS

#### <WINKER INDICATOR>

When the winker switch is operated, the winker indicator flashes in union with the flashing of the turn signals.

#### <SIDE STAND LAMP>

When the side-stand is down, the engine will stop with side-stand lamp on.

#### MIL<MALFUNCTION INDICATION LAMP>

EMS(Engine Management System)is equipped with a self-diagnosis function in order to ensure that the engine control system is operation normally.

If this function detects a malfunction in the system, the malfunction indicator lamp immediately operates.

It gives the rider that malfunction has occurred in the system.

Normally, the malfunction indicator lamp illuminates for 3 seconds when the main key is turned on.

If the malfunction indicator lamp does not come on under these conditions, the malfunction indicator lamp may be defective.

After 3 seconds, the malfunction indicator lamp off automatically. However, the MIL blinks continuously, check the EMS system. If you are not able to check the EMS system, contact your daelim dealers.

The EMS takes fail-safe function, it enables to drive only temporary by starting even on conditioned.

## SWITCH OPERATION

### MAIN SWITCH

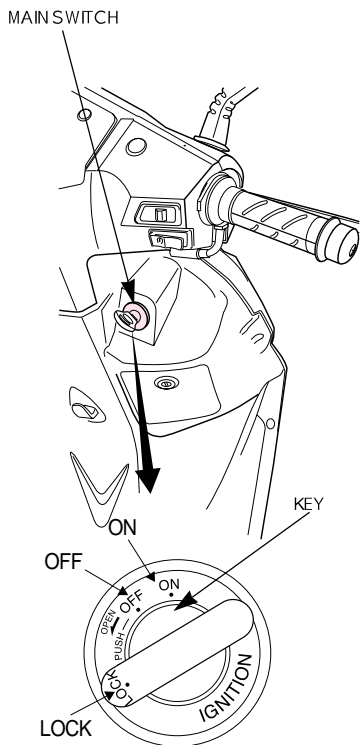

1. ON.... Starts engine. Key can not be pulled out.
2. OFF....Stops engine. Key can be placed in or taken out of the main switch.
3. LOCK....Locks handle bars. Key can be placed in or taken out of the main switch.
4. OPEN....When seat lock is released, key returns to its original position(OFF). Key can be placed in or taken out of the main switch.

#### **CAUTION**

- Do not operate main switch key while driving.
- If the main switch key is placed on "Off" or "Lock" position, all electrical system will not function.
- Never operate the main switch key during travel as it might cause unexpected accidents.
- If it is necessary to remove the main switch key, stop the vehicle first prior to removing.
- When you park the vehicle and leave it, please lock handle bars and take out the key.
- If the key is left in "ON" position without starting engine, battery is discharged.
- Rotate key smoothly without pressing to turn to OPEN.
- Do not use a number of keys together with a metal key holder.
- The keys and the key holder may cause scratches or other damage to the cover while operating the vehicle.  
(Recommend cloth or leather key holders)

## START BUTTON

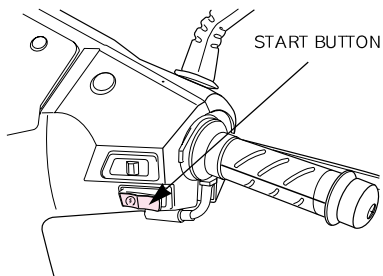

The engine is started pressing this button when pressed in a state where the main switch key is placed to an ON position and the brake lever is pulled.

### CAUTION

- The engine will not start if the brake lever is not grab.
- Do not hold the brake lever and pull the throttle grip when the engine was started. It may damage the engine.

## HEADLIGHT

### <TURNING ON HEADLIGHT>

Put main switch key in “ON” position and turn on headlight switch.

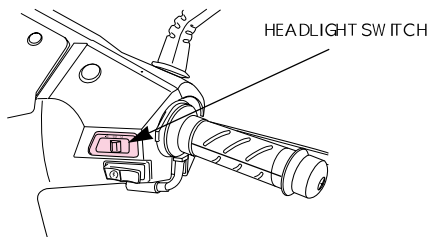

SWITCH POSITION	FUNCTION
☀ (H)	Headlight, taillight, position lamp and meter lights on.
☾☽ (P)	Position lamp, taillight, and meter lights on.
○ (OFF)	Light turned off.

### <DIMMER SWITCH>

High beam or low beam can be operated by the use of dimmer switch.

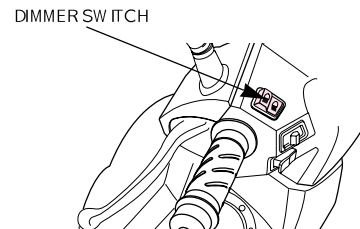

### HIGH BEAM

≡D(HI) ..... used when needing extra light.

### LOW BEAM

≡D(LO) ..... used when other vehicles are present, in the city, etc.

### CAUTION

- Use the high beam only in the suburban road or when the usage of the high beam not hinder the safe driving of the car ahead.



## WINKER SWITCH

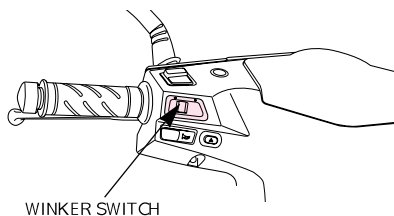

If this switch is turned on when the main switch is in an ON position, the winker will operate.

⇒(R)....used when making a right turn.

⇐(L)....used when making a left turn.

### **CAUTION**

- The winker switch does not automatically turn back to its original position after completing the turn. Please set the switch back to its center position after turning.

## HORN BUTTON

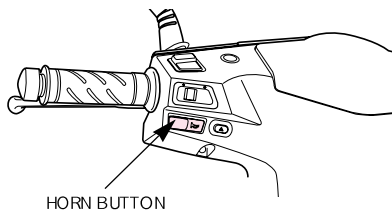

The horn is sounded if the horn button is pressed when the main switch is in an ON position.

## HAZARD SWITCH

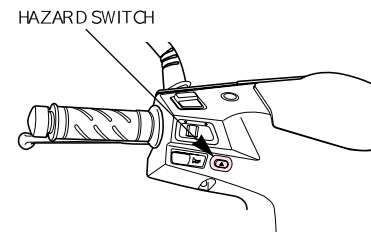

The winker and the winker indicator lamp will operate at the same time if the hazard switch is pressed when the main switch is on.

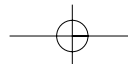



## EQUIPMENT USAGE

### STEERING STEM LOCK

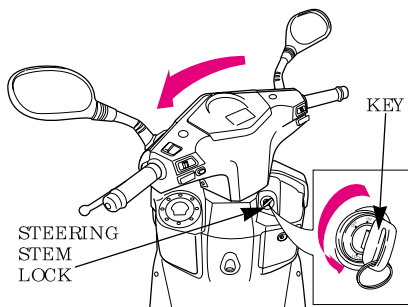

To prevent theft, make sure to lock handle bars of the vehicle when parking.

#### <LOCKING>

To lock the steering, turn the handlebars all the way to the left, turn the key to LOCK while pushing in. Remove the key.

#### <UNLOCKING>

To unlock the steering, turn the key to the OFF position.

#### ▲ WARNING

- Do not turn the key to LOCK while riding the vehicle; loss of vehicle control will result.

### SEAT LOCK

#### <LOCKING>

- The seat automatically locks when the seat is pushed in its downward position.
- Lightly pull upward on the seat to make sure the seat has been properly locked.

#### <UNLOCKING>

- Turn the main switch key from OFF to OPEN to open the seat.

#### ▲ CAUTION

- As the seat automatically locks, take special care not to accidentally leave the key in the trunk.
- Make sure that the seat is securely locked after closing the seat. Driving with unlocked seat lock may cause danger.
- When the seat lock is out of order, do not operate it further and inspect it in the closest authorized repair center.

## TRUNK

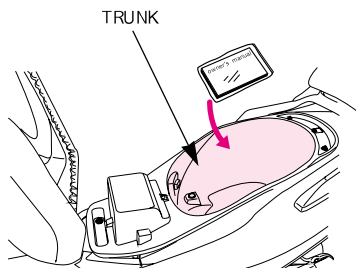

- There is a trunk under the seat.
- The seat is opened to gain access to the trunk by using the main switch key on the seat lock.
- The lamp inside the trunk will be turned on if the seat is opened.

### TRUNK MAXIMUM LOAD:10kg

#### ▲ CAUTION

- The temperature inside the trunk rises due to heat from the engine. Do not place foodstuffs and other articles that can be damaged easily by heat. Also do not place flamm-able materials in the trunk.
- Do not place valuable or fragile goods in trunk.

## DOCUMENT STORAGE AREA

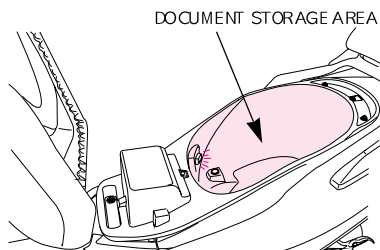

- There is a document storage area on the bottom of the seat.
- Store the owner's manual and the maintenance notebook in this area.

#### ▲ CAUTION

- As water can enter the trunk when washing, make sure to remove articles that can be damaged by water.
- Do not load uncloseable size of helmet and thing in the trunk, otherwise, the battery can be discharged with the trunk lamp on.

## BAG HOLDER

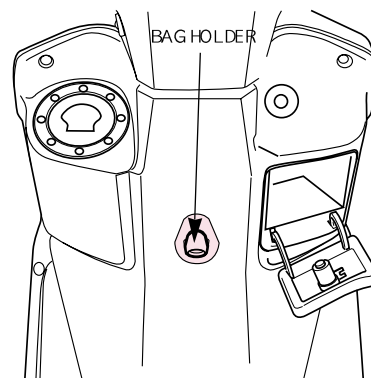

- For ease in carrying bags and similar items, they should be hung from the bag holder which is fitted for this purpose.
- When using the bag holder, place it in the open position and return it to the normal position when not in use.

#### ▲ CAUTION

- Do not attempt to carry very heavy or bulky loads since this would affect the stability and steering characteristics of the scooter.

## CORRECT DRIVING OPERATION

### BAG HOLDER

- Make sure to check the oil, gasoline, etc., before starting the engine.
- Please ensure that the main stand is in a down position when starting the engine.

#### **▲ CAUTION**

- Make sure that the rear wheel is locked when starting the engine to prevent an unexpected quick start of the vehicle.
- Locking is not possible if the rear wheel brake is not adjusted correctly.

- Drive with care for both safety reasons and longer vehicle life.

### <BREAK-IN OPERATION>

- For 1 month (or 1,000km) after purchasing the vehicle, drive moderately avoiding fast starts and fast acceleration.
- Maintain engine revolution at a level less than 6,000rpm for first 1,000km to break-in vehicle.
- If vehicle is broken-in as above, it will extend vehicle life.

### STARTING THE ENGINE

Always follow the proper starting procedure described below.

- This motorcycle is equipped with a side stand ignition cut-off system.
- The engine cannot be started if the side stand is down.
- Always be ensure that you operate the engine starting controls with the scooter on its stand.

#### **▲ WARNING**

- Never run the engine in an enclosed area. The exhaust contains poisonous carbon monoxide gas that can cause loss of consciousness and lead to death.
- While the scooter is on its stand you should never apply full throttle: if the rear wheel touches the ground the scooter would set off at full speed. (Remember that the scooter has a centrifugal automatic speed control)

1 Lock the rear wheel.

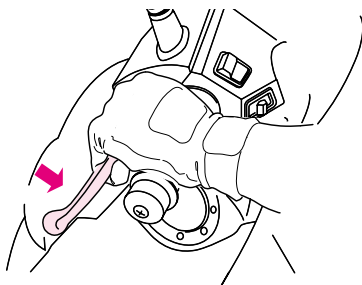

2 Turn the main switch to an ON position.

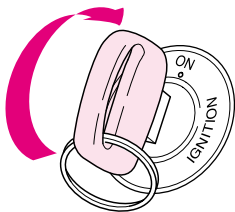

3 Start engine with cell button.

### <USING THE ELECTRIC START(CELL)>

● Press the starter button without rotating the starter grip (opening the throttle).

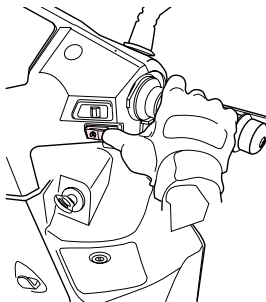

● If engine is not started with throttle grip closed, press starter button and open throttle grip approximately 1/8 to 1/4.

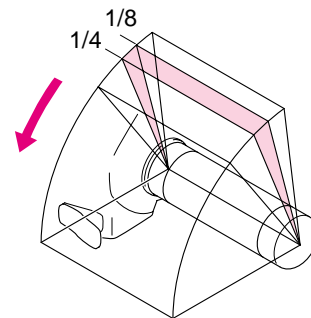

### CAUTION

- Immediately release the starter button as soon as the vehicle has started.
- Do not press the starter button when the engine is running. This can damage the start motor.

- It is possible that starting will be more difficult if the vehicle has not been used for a long period of time or if the fuel hole is plugged up (starting problems even when there is sufficient fuel in the fuel tank may be an indication of a plugged fuel hole).

When this happens, do not rotate the throttle grip and try the starter button a few times.

**CAUTION**

- Do not keep the starter button pressed for more than 5 seconds at a time. Release the starter button for approximately 10 seconds before pressing it again.

- ④ When the engine is cold morning or winter or the vehicle has not been used for a long period of time, let the engine idle for a short period allow the engine to warm up.

**CAUTION**

- Keep holding rear brake until start.
- Exhaust has contains harmful substance such as carbon monoxide. Start engine in well-ventilated places.

**IF ENGINE CANNOT BE STARTED**

If engine cannot be started or vehicle does not move, check the followings.

- Is there fuel in fuel tank?
- Are you operating in accordance with the instructions given in owner's manual?
- Is fuse not cut?
- Is starter motor running?
- If starter motor is not running due to battery consumption, charge the battery.
- If the MIL blinks continuously when the main key is on, contact Daelim dealer.

## AFTER STARTING ENGINE

### 1 Fold the main stand.

- Push the vehicle forward to fold the main stand and make sure that the brake lever does not become released during this operation.

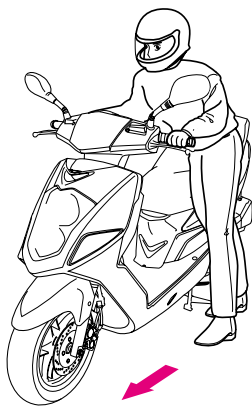

#### CAUTION

- Do not excessively open the throttle until you actually start the driving operation of the vehicle.

### 2 Get on the vehicle.

- Mounting should be done from the left side, and you should sit squarely on the seat. Leave either one foot or both feet planted on the ground.

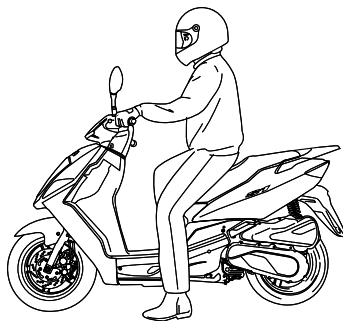

#### CAUTION

- Keep holding rear brake lever before starting.

### 3 Release the squeezing tension on the rear brake lever and slowly begin to rotate the throttle grip to allow for a slow and easy start.

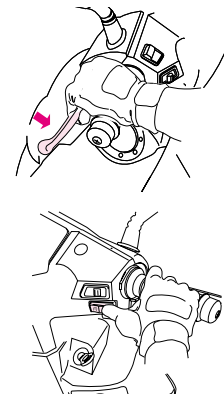

#### CAUTION

- A quick rotating of throttle grip will cause the vehicle to move forward abruptly.
- If the engine RPM will not turn down after throttle grip return to original position, stop operating and inspect it registered repair center nearby.

## PROPER DRIVING METHODS

- Before entering traffic, use the correct turn signal to forward other drivers of your intentions.

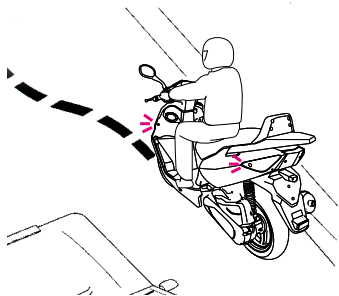

### Speed is controlled by the operation of the throttle grip.

- If the throttle grip is rotated.....  
The speed of the vehicle increases. Please rotate the throttle grip slowly. When climbing a hill, the throttle grip need to be rotated further to give the vehicle more power.
- If the throttle grip is allowed to rotate back.....  
Speed decreases. This can be done slowly or quickly, depending on how quickly you need to decelerate.

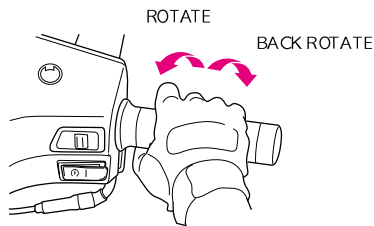

### Work the front and rear brakes together.

- Allow the throttle grip to rotate back to its beginning position and then squeeze the brake levers.
- If is best to operate the brakes by first lightly squeezing the brake levers and then changing to a more firm squeeze.

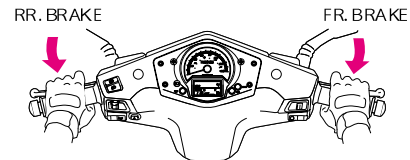

### CAUTION

- If only one of the brakes is used, it is possible for the vehicle to sliding.

**The brakes should never be suddenly applied and the handle bars should never be suddenly turned.**

- Sudden braking or turning can cause the vehicle to slide and tip over.
- It is especially dangerous to perform sudden braking on wet roads or in rainy weather as the tires can lose traction and slip easily.

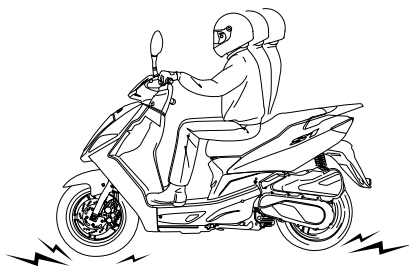

**Special care in driving should be taken during rainy weather.**

- More braking distance is needed when driving on wet roads or in the rain. Reduce speed and be sure to initiate the braking operation sooner than when driving in normal conditions.
- On downgrades, allow the throttle grip to rotate back to its initial position to reduce speed, and apply the brakes and drive slowly down the hill.
- It is possible for the brakes to temporarily lose operative ability after driving through a puddle or when driving in the rain. To ensure that the brakes are operating properly, slow down (after checking for other vehicles) and while driving slowly, lightly apply the brakes to rid the brakes of any excess water and to dry them.
- Be extremely careful when driving in the snow or on icy roads. When driving in these conditions, both the tires lose much of their traction and the rear tire can slip when opening the throttle.

**STOPPING**

- 1 When approaching the desired stopping area.
  - Activate the proper winker, and after checking for other vehicles, slowly turn into the area in which you want to stop.
  - Allow the throttle grip to rotate completely back and apply the front and rear brakes. The brake light will shine to alert vehicles in back of you that you are stopping.

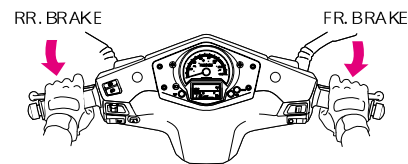



2 After the vehicle has come to a complete stop.

- Return the winker switch to the center position and turn the main switch to OFF. This will turn the engine off.

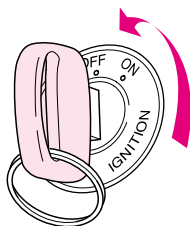

**CAUTION**

- Do not rotate the main switch key while driving. If the main switch is turned to an OFF or LOCK position, the electrical system will not operate. Operating the main switch key while driving can be very hazardous. Only turn the main switch key to OFF or LOCK position after completing stopping the vehicle.

3 Dismount on the left side and lower the main stand on a flat surface.

- Be sure to park in an area that is free of traffic. Also, the vehicle can tip over if the main stand is not placed on a stable and flat surface.
- The main stand is lowered by grasping the handle bars with the left hand, holding the rear carrier with the right hand, and stepping firmly on the stand with the right foot. In this position, lift the rear carrier upward, which will secure the main stand.

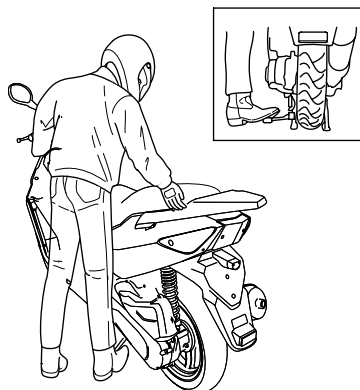

4 To prevent theft, be sure to lock the steering when parking.

**CAUTION**

- Park in a safe area that will not block traffic. When you parked the vehicle after driving, make sure foot the vehicle beyond man's reach because engine and muffler are still hot.
- Park the motorcycle on firm, level ground to prevent it from falling over.
- If you must park on a slight incline, aim the front of the motorcycle uphill to reduce the possibility of rolling off the side stand or overturning.

## SELF INSPECTIONS BEFORE OPERATION

---

Self inspect the vehicle and have regular maintenance inspections for increased safety and the prevention of accidents. Regular maintenance inspections should be performed even if the vehicle has not been used for a long period of time.

Self inspections before operation should be performed on a daily basis prior to operating the vehicle.

- Inspections of concerned Area
- Brake inspection
- Tire inspection
- Fuel check
- Engine oil check
- Lights and winker inspection
- Back mirror inspection
- Fuel leak inspection
- License plate inspection
- Throttle grip inspection.

### ▲ CAUTION

Observe safety rules when conducting inspections.

- Exhaust gas contains harmful substance such as carbon mono-xide. Do not carry out inspections on vehicle in closed places, or in poorly ventilated places, with engine running.
- Conduct inspections on flat, solid ground with the stand erected.
- Be careful of burns when conducting inspections immediately after engine is stopped because the engine and muffler are hot.
- Stop engine and remove the key prior to the vehicle maintenance service.
- Use appropriate types of tools.

### ▲ CAUTION

- If you are unable to correct trouble even after you make adjustment or correction, contact authorized maintenance shops, dealers or designated repair shops for necessary inspection and repairs.

### INSPECTION OF CONCENED AREA

- Check areas which caused for concern when last operating the vehicle.
- If happened, contact authorized maintenance shops for necessary inspection and repairs.

### BRAKE INSPECTION

#### <BRAKE LEVER FREE PLAY>

Lightly squeeze the brake levers until tension is felt to check for an appropriate amount of free play. No free play in the brake levers or overly loose brake levers are indication of a problem in the brake system.

**BRAKE LEVER FREE PLAY: 10~20mm**



#### ⚠ CAUTION

- Specified brake lever free play must be maintained. Excessive free play may cause long stopping distance, brake operational fault and slow reacting time resulting in the dangerous situation and insufficient free play may cause short stopping distance and damage brake system(pad, lining, etc.)

#### <CHECK OF BRAKE FLUID>

This is checked by placing the vehicle on its main stand on a flat surface. Make sure that the handle bars are at a horizontal level. Check to see if the fluid is below the LOWER level.

If brake fluid is significantly low, this may indicate that there is leakage in the brake system. Inspect the brake hose to check for leaks.

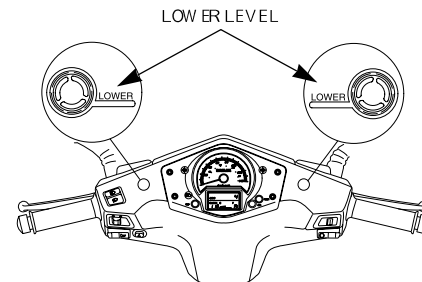

#### ⚠ CAUTION

- If the brake fluid is remarkably lower than the specified level, inspect not only brake fluid but also check the front brake pad for wear.

## FUEL CHECK

### <CHECK>

Check gasoline to see if there is a sufficient amount of gasoline to reach your destination.

- Place the main switch to “ON” position.
- If the fuel meter needle indicates E mark (red portion), fill fuel tank with gasoline as soon as possible.

**RESERVE FUEL CAPACITY : 2.2 l**

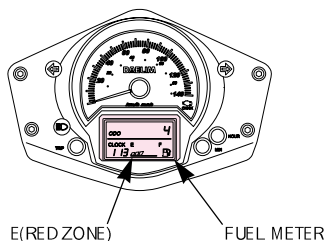

### <REFUELING>

- Open the key cover on fuel tank cap, and turn the key clockwise to remove the cap.
- Fill the tank with gasoline until it reaches the bottom of the level plate.
- Press the cap firmly, and pull out the main key.

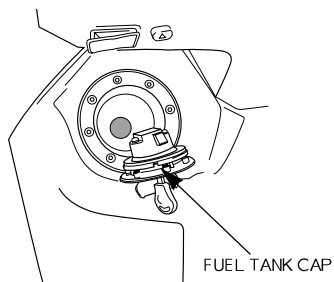

### ⚠ CAUTION

- Gasoline is extremely flammable and is explosive under certain conditions. Refuel in a well-ventilated area.
- Make sure to stop engine and stay away from fire when refueling.
- Do not fill gasoline past the level plate. Gasoline may leak out of the fuel tank when replacing the fuel tank cap if too much gasoline is put in the fuel tank.
- Don't fill low grade gasoline. Using it can cause damage (bending, getting worn, etc.) to combustion chamber and parts of fuel.
- Do not close the fuel cap with excessive strength. It may cause the damage of the cap and the rubber packing resulting in the leak of fuel and may cause fire in case of electrical short or the overturn of the vehicle.
- Avoid repeated or prolonged contact with skin or breathing of vapor.
- Keep out of reach of children.



## TIRE INSPECTION

### <AIR PRESSURE CHECK>

Check for an appropriate level of air pressure by examining how the tire sits on the ground. If you notice any abnormalities in the shape of the tire with regard to the area contacting the ground, use a tire gauge to check tire pressure and adjust the tire pressure to the appropriate level.

SIZE	FRONT	120/70-12	
	REAR	130/70-12	
TIRE PRESSURE (kgf/cm <sup>2</sup> )	WITH ONE PERSON	FRONT	1.75
		REAR	2.00
	WITH TWO PERSON	FRONT	2.25
		REAR	2.25

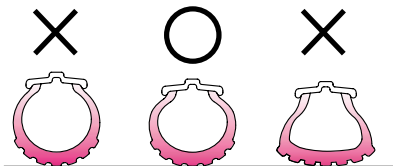

### <CRACKS/DAMAGE>

Check tire tread and sides for cracks and damage.

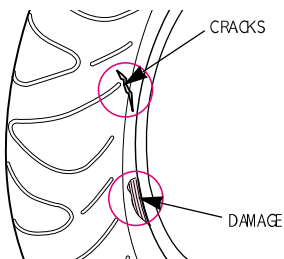

### <ABNORMAL WEAR>

Check tire tread for signs of abnormal wear.

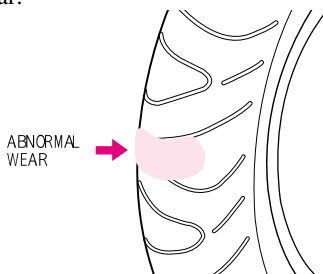

### <FOREIGN MATERIALS>

Check tire tread and sides for nails, rocks, etc. That might have become wedged in the tire.

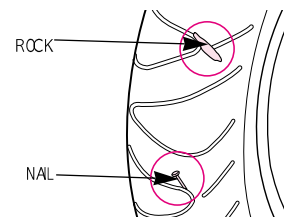

### <TREAD DEPTH>

- Check the wear indicator (wear limit marking) to see if there is an insufficient amount of tread remaining.
- If the indicators are visible, replace tire with a new one.

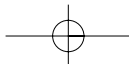
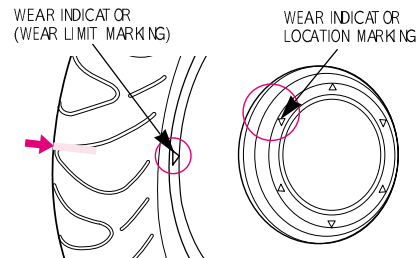

**▲ CAUTION**

- If air pressure is inadequate or if there are cracks, damage or abnormal wear on tires, it may cause trembling steering wheel and flat tire.
- Insufficient air pressure may cause the heavy steering wheel making handling difficult, fuel over consumption and the excessive wear of tire outer area and excessive air pressure may cause easier wheel handling and lower fuel consumption. But it may also cause the excessive wear of tire center area.
- This vehicle is equipped with tubeless tires. If you have flat tires, please contact authorised maintenance shops for inspection.

**ENGINE OIL LEVEL CHECK**

Check the engine oil level each day before riding the motorcycle.

The oil level must be maintained between the upper and lower level marks on the sight-glass

- Stand the motorcycle on the main stand on level ground.
- Start the engine and let it idle for approximately 2~3 minutes.
- Check the engine oil level.
- If required, add the specified oil. Do not overfill.

**▲ CAUTION**

- To avoid running out of engine oil, it may cause serious engine damaged.

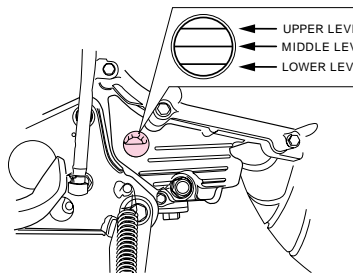

## LIGHTS AND WINKER INSPECTION

### ▲ CAUTION

- The lighting head light emits very hot heat. If you touch with naked hand, it may be burned.
- When replacing head light lamp, stop lame and winker lamp, use only a bulb of rated capacity. Using a lamp exceeding the rated capacity can cause over-discharge of battery and wire burning. It can lead a fire.
- If the head light is turned off due to aging while driving at night, it will cause an accident by obstructing driver's view. Check the condition daily.
- If the tail light is off while driving at night, it will cause an accident by failure of notice by the other drivers. Check the condition daily.

### <INSPECTION OF WINKER>

Turn a main switch "ON". Check the lamp for proper operation (front/rear and right/left) and sound by operating the switch, and also a lens for damage or contamination.

### <INSPECTION OF STOP LAMP>

Turn a main switch "ON". Check a stop lamp for proper operation by operating the front wheel and the rear wheel brakes, and also a lens for damage or contamination.

## BULB REPLACEMENT METHOD

- Be sure to turn a main switch "OFF" prior to replacement of a bulb.
- Use only a bulb of rated capacity.
- After replacement with new bulb, check for proper operation.

### ▲ CAUTION

- Care is to be taken to avoid leaving fingerprints on a headlight bulb. Failing to observe this may cause early damage of the headlight bulb resulted from concentration of heat.
- Be sure to wear clean gloves when replacing a bulb. If touched to it with bare hands, clean it with a cloth soaked with alcohol to prevent from early damage.

### <HEADLIGHT BULB>

- (1) Loosen 7 special screws and disassemble the electric wire of the headlight and remove the front cover.

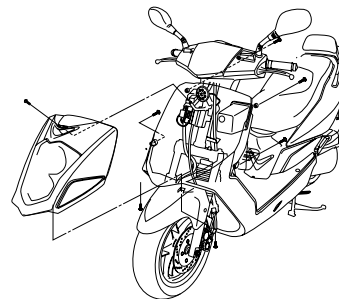

- (2) Disassemble a headlight socket by pulling it out.
- (3) Disassemble the rubber cover.
- (4) Loosen the steel wire, and disassemble the head light bulb.

**HEADLIGHT BULB: 12V 55W**

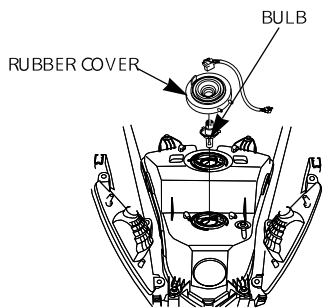

- (5) Replace with new bulb.
- (6) Install in the reverse order of remover.

**<HEADLIGHT ILLUMINATION ANGLE>**

- Adjust headlight illumination angle by turning an adjusting bolt on a headlight. (Use type screwdriver.)
- (1) Adjust the upper/lower by turning the screw on outside.
  - (2) Adjust the right/left by turning the screw on inside.

**CAUTION**

- Illumination angle adjusted incorrectly may dazzle a facing driver's eyes or result in difficulty to show the forward.

**<TAIL/STOP LIGHT BULB>**

- (1) Loosen 2 tapping screws to disassemble tail light lens.
- (2) Press a bulb with a light force and rotate it to counterclockwise to disassemble it.
- (3) Replace it with new bulb. Apply reverse order of disassembly for assembly.

**TAIL/STOP LIGHT BULB : 12V 21/5W**

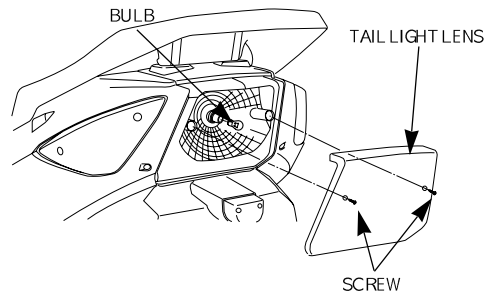

**CAUTION**

- When disassembling, care is to be taken for ensuring that a tail light lens can not be damaged.
- When replacing a tail light lens, be sure to assemble lens seal securely.



## <WINKER BULB>

### Front Winker Bulb

- (1) Loosen tapping screw to disassemble a winker lens.
- (2) Press a bulb with a light force and rotate it to counterclockwise to disassemble it.
- (3) Replace it with new bulb. Apply reverse order of disassembly for assembly.

### FRONT WINKER BULB: 12V 10W

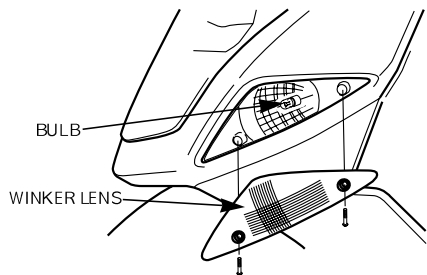

### Rear Winker Bulb

- (1) Loosen two tapping screws to disassemble a tail light lens and a winker lens.
- (2) Press a bulb with a light force and rotate it to counterclockwise to disassemble it.
- (3) Replace it with new bulb. Apply reverse

order of disassembly for assembly.

### REAR WINKER BULB: 12V 10W

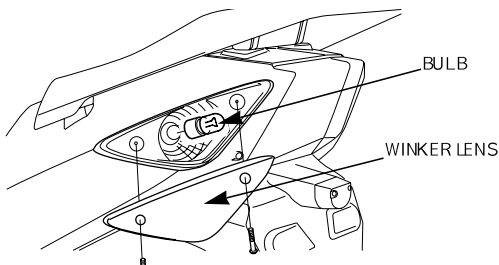

## REAR VIEW MIRROR

Check the objects at the back are well noticed when seating on a driver's seat, and also mirror for damage or contamination.

## FUEL LEAK INSPECTION

Check there is no gasoline leakage from fuel tank, hoses, carburetor, etc.



## MAINTENANCE

---

- The Required Maintenance Schedule specifies how often you should have your motorcycle served, and what things need attention. It is essential that your motorcycle be served as scheduled to retain its high level of safety, dependability, and emission control performance.
- These instructions are based on the assumption that the motorcycle will be used exclusively for its designed purpose. Sustained high speed operation, or operation in unusually wet or dusty conditions, will require more frequent service than specified in the MAINTENANCE SCHEDULE.  
Consult your authorized Daelim dealer for recommendations applicable to your individual needs and use.

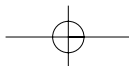



## MAINTENANCE SCHEDULE

Perform the Self Inspections Before Operation at each scheduled maintenance period.  
 I: INSPECT AND, CLEAN, ADJUST, LUBRICATE OR REPLACE IF NECESSARY  
 R: REPLACE L: LUBRICATE C: CLEAN

ITEM		FREQUENCY	ODOMETER READING(NOTE1)					REMARK	
			×1,000Km	1	4	8	12		16
			MONTH	1	6	12	18		24
★	FUEL LINE		I	I	I	I	I		
★	THROTTLE OPERATION		I	I	I	I	I		
	AIR CLEANER ELEMENT			R	R	R	R		
	SPARK PLUG		I	I	I	I	I		
	ENGINE OIL		R	R	R	R	R		
	ENGINE OIL FILTER		R	R	R	R	R		
	OIL FILTER SCREEN		C	C	C	C	C		
★	TRANSMISSION OIL		R		R		R		
	BRAKE FLUID		I	I	I	I	R		
	VALVE CLEARANCE		I	I	I	I	I		

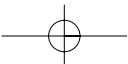



ITEM		FREQUENCY	ODOMETER READING(NOTE 1)					REMARK	
			× 1,000Km	1	4	8	12		16
			MONTH	1	6	12	18		24
★	BRAKE SHOE / PAD WEAR		I	I	I	I	I		
★	BRAKE SYSTEM		I	I	I	I	I		
	BRAKE STOP SWITCH			I	I	I	I		
★	HEADLIGHT ADJUSTMENT		I	I	I	I	I		
★	SUSPENSION			I	I	I	I		
★	BOLTS, NUTS, FASTENERS		I	I	I	I	I		
	WHEELS / TIRES		I	I	I	I	I		
	STEERING		I	I	I	I	I		
★	DRIVE VALTE			I	I	I	I		
★★	WEIGHT ROLLER			I	I	I	I		
★★	SLIDE PIECE			I	I	I	I		
	MOVABLE DRIVE FACE GREASE			L	L	L	L		

★ If you do not have the appropriate tools or information to conduct maintenance, or if you feel you are not capable to perform maintenance on this vehicle, contact authorized dealers or repair shops for maintenance and repairs.

★★ To ensure safety, inspections and maintenance of these parts must be carried out by dealers, or repair centers.

**NOTES :** (1) At higher odometer readings, repeat at the frequency interval established here.

(2) Service more frequently when riding in unusually wet or dusty areas.

(3) Replace every 2 years, or at indicated odometer interval, whichever comes first. Replacement requires mechanical skill.

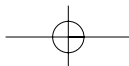

## MAINTENANCE PRECAUTIONS

The following is an explanation of correct inspection methods, cleaning and parts replacing. Please always refer to this section when wanting to inspect or repair your vehicle.

### ⚠ WARNING

- If your motorcycle is overturned or involved in a collision, inspect control levers, cables, brake hoses, calipers, accessories, and other vital parts for damage. Do not ride the motorcycle if damage impairs safe operation. Have your authorized Daelim dealer inspect the major components, including frame, suspension and steering parts, for misalignment and damage that you may not be able to detect.
- Use new, genuine Daelim parts or their equivalent for maintenance and repair. Parts which are not of equivalent quality may impair the safety of your motorcycle and the effective operation of the emission control systems.

### ⚠ CAUTION

- Always observe safety rules when performing maintenance on the vehicle.
- Choose a flat surface and make sure the main stand is in a secure down position.
- Use correct tools.
- Conduct engine maintenance with the engine key out of the ignition.
- Be careful around the engine and muffler when performing maintenance as these areas can become extremely hot.
- After self maintenance, the waste material must be packed in the specified container and entrusted disposal to the authorized disposal company.

## BRAKE

### COMBINED BRAKE SYSTEM

(How to this system works)

If the front brake lever is hold, the front brake is operating.

The rear brake lever is hold, the front

brake and rear brake are simultaneous braking

Both the front and rear brakes are the hydraulic disk type.

As the brake pads wear, the brake fluid level drops.

There are no adjustments to perform, but fluid level and pad wear must be inspected periodically.

The system must be inspected frequently to ensure there are no fluid leaks.

If the lever free play becomes excessive and the brake pads are not worn beyond the recommended limit, there is probably air in the brake system and it must be bled.

See your authorized Daelim dealer for this service.

### ⚠ CAUTION

- Brake fluid may cause irritation. Avoid contact with skin or eyes. In case of contact, flush thoroughly with water and can a doctor if your eyes were exposed.
- Keep out of reach of children.

### <REPLENISHING FRONT BRAKE FLUID>

- Check that the fluid level is above the LOWER level mark with the motorcycle in an upright position.
- Brake fluid must be added to the reservoir whenever the fluid level begins to reach the LOWER level mark.

1. Remove the wind screen.
2. Clean dust and other foreign materials around reserve tank to prevent foreign materials from falling inside tank.
3. Remove the screws and take oil cup cap, diaphragm plate, diaphragm off.
4. Replenish recommended brake oil to the upper level inside reserve tank.

**RECOMMENDED BRAKE OIL IS  
DOT 3 or DOT 4**

5. Reinstall the diaphragm plate, and oil cup cap.
6. Tighten the screws securely.
7. Install the wind screen.

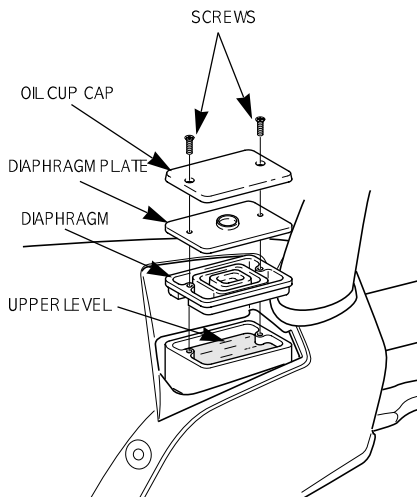

### <REPLENISHING REAR BRAKE FLUID>

- Replenish in the same method as that of front brake fluid replenishment.

### **CAUTION**

- When adding brake fluid, be very careful not to allow foreign materials to enter the reserve tank. Foreign materials can clog the system, causing a reduction or complete loss of braking ability.
- Do not fill past upper level. This can cause brake fluid to leak out of the reserve tank.
- Do not let brake fluid contact vehicle parts as this damages painted areas. If oil contacts parts, quickly clean the fluid off using a dry cloth.
- Use recommended brake fluid as other types can undergo chemical changes.
- If brake fluid is exceedingly low, this can be indication of damage to the brake system.
- A leak in the brake system can lead to reduced braking efficiency and possible loss of braking ability.



## **BRAKE HOSE, PIPE LEAKAGE, DAMAGE, ASSEMBLY STATE**

Visually check for fluid leaks or damage and, using a spanner, check joints and clamps for clearance.

Also, check hose and pipe protective parts to see if they contact other parts when turning the handle bars or due to vibration when driving.

## **BRAKE PAD WEAR**

Brake pad wear depends upon the severity of usage, the type of riding, and road conditions. (Generally, the pads will wear faster on wet and dirty roads.)

Inspect the pads at each regular maintenance interval (page 32).

### **[FRONT / REAR BRAKE]**

- Check the cutout in each pad.
- If either pad is worn to the cutout, replace both pads as a set
- See your authorized Daelim dealer for this service.

### **<FRONT BRAKE>**

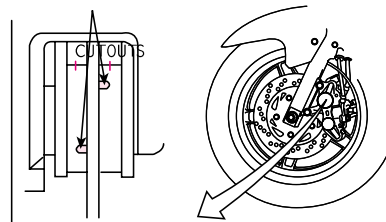

### **<REAR BRAKE>**

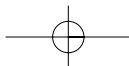
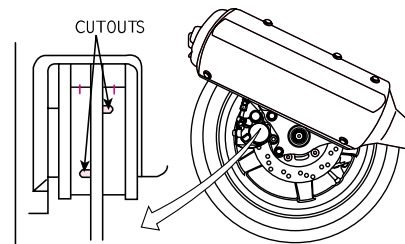

## CHANGING ENGINE OIL

When the engine oil is contaminated, the life of engine will be remarkably shortened. Keep the proper oil level, kind and replacing period.

- Place the vehicle on a flat surface, and idle (warm up) the engine 2~3 minutes.
- Stop the engine, separate the oil level gauge, place a vessel under the engine, and remove the oil drain bolt to drain the oil.
- Remove the adjusting hole cap, and clean the oil filter screen.
- Check the condition of O-ring of oil filter screen.
- Install the oil filter screen, spring, adjusting hole cap.
- Install the oil drain bolt.
- Check the oil level gauge, and add the engine oil until it reaches the specified level (between max and min)
- Install the oil level gauge, and idle the engine for a while.
- Wait for 20~30 seconds after stopping the engine, check again the oil level gauge.

**WHEN CHANGING OIL: 0.9ℓ**

**WHEN CLEANING THE FILTER SCREEN: 0.95ℓ**

**TOTAL AMOUNT: 1.1ℓ**

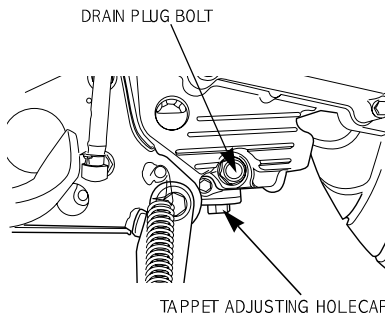

### [SPECIFIED GENUINE OIL]

Don't fill the low grade oil. Using it can cause damage to engine, and can't receive the warranty. Use only the genuine oil.

Genuine oil: Motics 4 oil

SF, SL grade (SAE : 10W40)



### ⚠ WARNING

- If changing the oil by loosening the oil drain bolt, always clean the oil filter screen.

### ⚠ CAUTION

- When changing the engine oil immediately after stopping the engine, be careful not to be burned the hot oil.
- When refueling, make sure not to enter the dirt into oil pouring port.
- If the oil overflows, wipe it clearly.
- Do not fill the oil past the level plate. It can cause damage to engine.
- Don't fill the low grade oil. Using it can cause damage to engine and parts. If the engine is stuck while traveling due to this, it may lead death or serious injury. Use only the genuine oil.
- Do not pour the 2 cycle engine oil. Using it can cause serious damage to engine. If the engine is stuck while traveling due to this, it may lead death or serious injury.
- If the tire is stained with oil while or after refueling, the vehicle may slip while traveling to cause roll over.
- Do not discard the engine oil other than specified place. It will bring environmental contamination, and be brought under the law.





## TRANSMISSION OIL INSPECTION

- Start the engine and let it idle for a few minutes.
- Stop the engine and put the motorcycle on its mainstand on level ground.
- Check to see if transmission oil leaks out of the transmission case.
- Fill the recommended oil when you need.

**RECOMMENDED OIL : SAE80W-90**

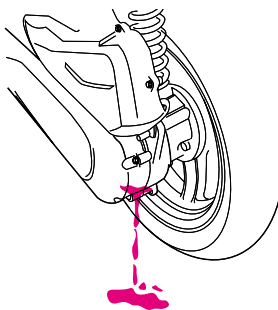
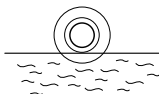
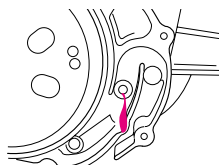

### CAUTION

- Pay special attention not to leak out.
- When draining the oil, make sure that all of the oil is removed.
- The engine can be harmed if there is too much or not enough oil.
- Do not use low-quality oil. These oils can change quality overtime and can cause damage.

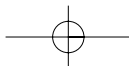

## WHEEL REMOVAL

### <FRONT WHEEL REMOVAL>

- ① Raise the front wheel off the ground by placing a support block under the engine.
- ② Loosen the oval screw and remove the speedometer cable.

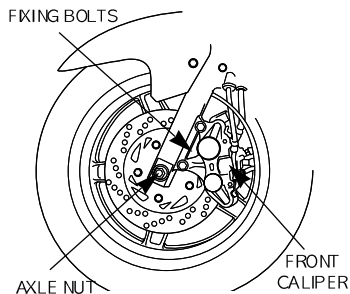

- ③ Remove the front caliper assembly from the front fork by removing the fixing bolts.

#### CAUTION

- Do not operate brake lever after the front wheel is removed. It will make wheel assembling difficult.

- ④ Loosen the axle nut.
- ⑤ Withdraw the front wheel axle and remove the front wheel.

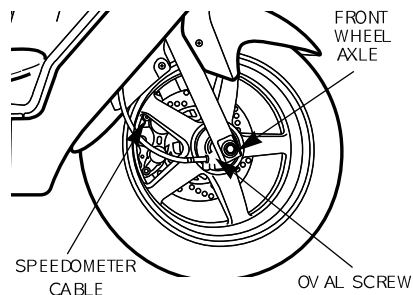

- ⑥ Install in the reverse order of removal.

#### CAUTION

- When installing the wheel, carefully fit the left brake disk between the brake pads to avoid damaging the pads.

- Prior to assembling, match the depressed part (☒) of the speedometer gear box with the projected part of the left front fork.

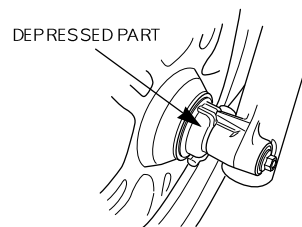

- Fit the caliper over the disk, taking care not to damage the brake pads. Install the caliper fixing bolts, and tighten to a torque of : **2.8~3.4kgf · m**

- Tighten the front axle nut to the specified torque.

**FRONT AXLE NUT TORQUE**  
: **5.0~7.0kgf · m**

- ⑦ After assembling, operate brake for a number of times and see if wheel is turning smoothly without getting interruption.



### <REAR WHEEL REMOVAL>

- ① Set vehicle on main stand in upright position on the ground.
- ② Remove the muffler.
- ③ Remove the rear caliper assembly from the rear swing arm by removing the 2 fixing bolts.
- ④ Remove the special bolt of RR. cushion securing the RR.swing arm and pull it up.
- ⑤ Loosen the axle nut and remove the RR.swing arm.
- ⑥ Remove the collar and the rear wheel.
- ⑦ Install in the reverse order of removal.

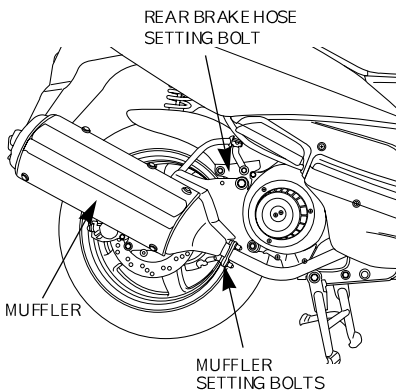

### CAUTION

- If a torque wrench was not used for installation, see your authorized dealer as soon as possible to verify proper assembly. Improper assembly may lead to loss of braking capacity.
- Never perform the maintenance of the muffler right after stopping the vehicle because the muffler is extremely hot.

**REAR AXLE NUT TORQUE**  
**: 12.0~13.0kgf · m**

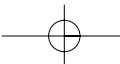
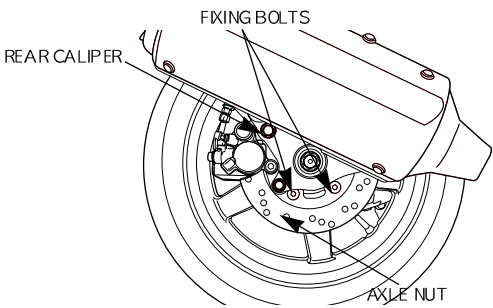

## SPARK PLUG

If electrode is stained or clearance is not right, satisfactory spark is not produced. Clean and make adjustment.

- Remove the spark plug cap.
- Clean around the plug.
- Using a plug wrench, remove the plug.

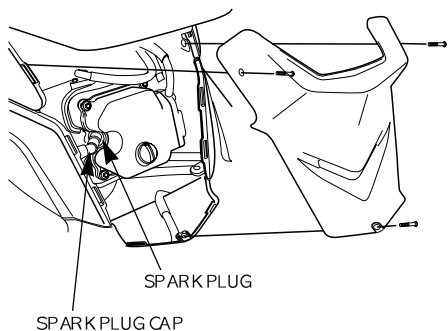

- Clean plug with plug cleaner.
- Check electrode for wear and corrosion.
- If the ends become round, replace it with a new one.
- Check the plug gap using a feeler gauge.

**PLUG GAP: 0.8~0.9mm**

- Tighten with hands until the plug washer touches cylinder head.

**STANDARD PLUG: CR8EH-9**

- If new plug is installed, turn 1/2 and tighten using a plug wrench.
- If plug is reused, turn 1/3~1/4 and tighten.

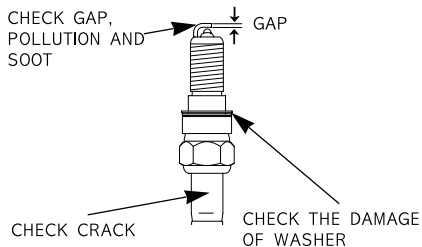

## <HANDLING FOR POOR STARTING>

During cold season or when frequent short-distance traveling, the starting may be poor and even the engine will be OFF. This may be prevented by use of spark plug. The spark plug of this vehicle is equipped as standard when delivery. However, the starting will be poor if the vehicle is continuously driven under low speed.

### CAUTION

If plug of different maker or different heat value is used, it causes unsatisfactory engine starting, inadequate engine revolution and output deterioration.

After driving, the spark plug become very hot. When inspecting, pay attention not to be burned.

## BATTERY INSPECTION

When removing the pillion seat and open the battery box cover, you can find the battery. If the battery terminal is polluted or in-rust, separate battery and clean it.

- Battery terminal in rust with white powder should be cleaned with warm water.
- In case of serious rust of battery terminal, disassemble the battery cord and grind it with wire brush or sandpaper.

LUGGAGE BOX

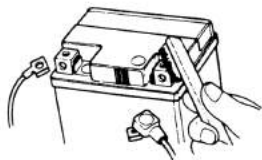
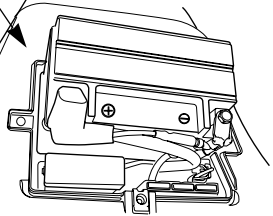

### CAUTION

- Turn the ignition switch OFF before disconnecting the terminal from the battery. Disconnect the negative(-) terminal lead from the battery first. When connecting, connect the positive(+) terminal lead first. If you work in reverse order, short circuit will occur resulting in fire.
- Make sure that terminals do not contact with other adjacent parts when handling (+), (-) terminals. Contact with other parts may cause spark resulting in electrical equipment malfunction, fire and electric shock.
- Do not apply excessive impact. When handling the battery, stay away from flammable materials.
- If the electrolyte contact with terminal, it will be corroded earlier.
- The battery is shield type, so do not disassemble the pouring plug.
- When not using vehicle during a long time, take off the battery from the vehicle to keep from self-discharge and electric discharge. Put the battery in a well ventilated place after charging fully. In case it isn't available to take battery off from the vehicle, disconnect (-) terminal.

### CAUTION

- When using the battery without cover, (+), (-) terminals may be connected to cause short circuit resulting in fire. When handling the battery, stay away from flammable materials.
- Your battery is a maintenance-free type so check or refilling of electrolyte will not be required. If there is any abnormal, contact to Daelim service center.
- If you reform the battery for car, battery will be improperly installed to cause short circuit resulting in fire.
- If the electrolyte gets into your eyes or on skin, it'll cause a serious injury.
- Do not discard the battery other than specified place. It will bring environmental contamination, and be brought under the law

## FUSE REPLACEMENT

Turn off the main switch to see if the fuse is severed. If the fuse is severed, exchange the fuse into a fuse with same capacity.

- Fuse is installed in fuse box around the battery.
- To change a fuse, first take off fuse cover. Then, remove the disconnected fuse, and insert the reserved fuse with same capacity.

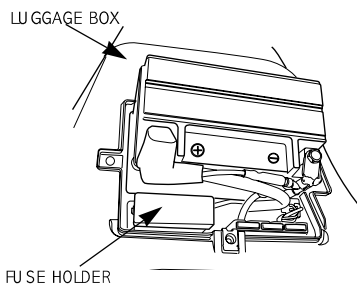

- If the fuse immediately becomes severed after being changed with the new one, check another problem of the electric system. Contact to Daelim service center.

<DISASSEMBLY>

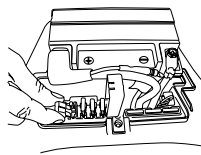

<ASSEMBLY>

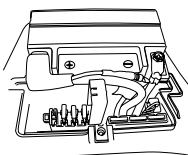

Fuse A	30A	Charging, combi S/W, regulator
Fuse B	15A	Winker relay, meter lighting, horn, headlight (LO/HI), front/rear stop switch, taillight, fuel meter
Fuse C	15A	Ignition coil, Ecu O2 Sensor
Fuse D	15A	Ecu, Fuel pump relay

### CAUTION

- Do not use screw driver or other metal parts to remove the fuse, as short circuit can be occurred to cause damage to electric system.
- Do not use a fuse having a larger voltage, as the wire can become overheated and damaged.
- When replacing any of the electrical parts (lights and gauges), be sure to replace them with the recommended parts. Using different parts can lead to the fuses burning out or damage to the battery.
- When washing the vehicle, take special care not to allow to be splashed in the area of the fuses.

## AIR CLEANER ELEMENT INSPECTION

### <REMOVAL>

- ① Loosen the 6 washer screws and 1 flange bolt, and remove the tube clip and air cleaner case cover.
- ② Inspect the air cleaner element.
- ③ If the air cleaner element is excessively dirt or damaged, replace it with a new one.

AIR CLEANER ELEMENT

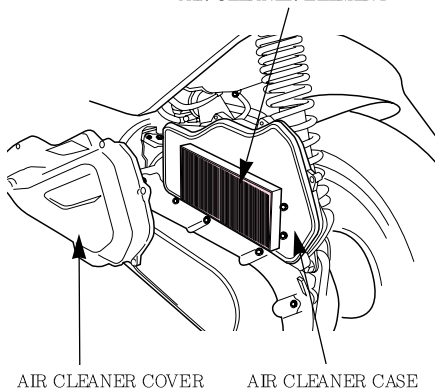

### CAUTION

- If the air cleaner element is inadequately assembled, dust and other waste materials can directly enter the engine. This results in increased cylinder wear and reduced power, and reduced durability of the engine.
- When washing the vehicle, be careful not to allow water to get into the air cleaner. Difficulties in starting the engine may result if this happens.
- If the engine start is failed during rain or after driving across water pool, check to see if the water is infiltrated in the air cleaner and clean it.
- Do not drive in the flooded area. If the water enters the air cleaner or engine, the vehicle may be subjected to the rear-end collision due to the power failure.

## SIDE STAND INSPECTION

- Erect main stand and place vehicle in upright position on level ground.
- Check the spring for damage or loss of tension and the side stand assembly for freedom of movement.
- Check the side stand ignition cut-off system;
  - ① Put the side stand up.
  - ② Start the engine.
  - ③ Lower the side stand. The engine should stop as you put the side stand down.
- If the side stand system does not operate as described, inspect it in the closest authorized repair center.

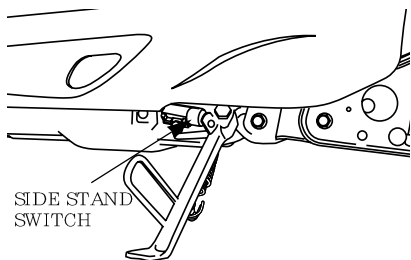

## CABLE RUBBER PART

A rubber boots is assembled on the cable to protect the inner cable. Make sure that this part is placed firmly around the correct part of the cable. When washing the vehicle, do not directly spray water on to the rubber boots or scrub it with brush. Use a dry cloth to clean this area.

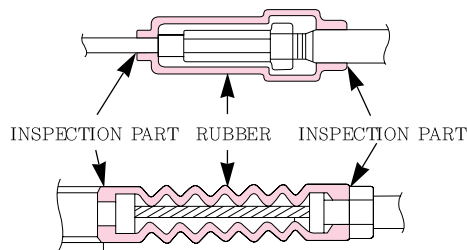

Check the installing condition of rubber boots daily. After adjusting the free play of throttle grip, never forget to place the rubber boots to the original position.

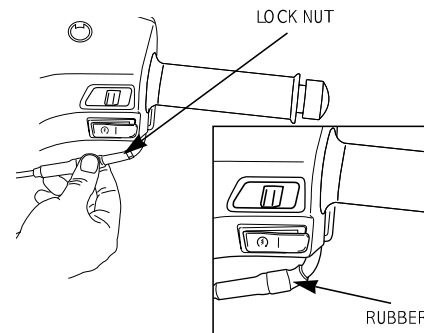

### ⚠ WARNING

- Infiltration of the foreign materials or water caused by damage of rubber boots (disengagement, tearing, etc.) may cause freezing in winter season resulting in faulty operation. It may lead death or serious injury by decreasing of sudden acceleration and braking force due to engine rpm. If any damage is found, replace with the new on immediately.



**▲ CAUTION**

● Petrol is extremely flammable and is explosive under certain conditions. Perform this operation in a well-ventilated area with the engine stopped. Do not smoke or allow flames or sparks in the area where petrol is drained or stored and where the fuel tank is refueled.

- Remove the battery. Store in an area protected from freezing temperatures and direct sunlight. Slow charge the battery once a month.
- Wash and dry the motorcycle. Wax all painted surfaces.
- Inflate the tires to their recommended pressures. Place the motorcycle on blocks to raise both tires off the ground.
- Cover the motorcycle (don't use plastic or other coated materials) and store in an unheated area, free of dampness with a minimum of daily temperature variation. Do not store the motorcycle in direct sunlight.

**<REMOVAL FROM STORAGE>**

- Uncover and clean the motorcycle.
- Charge the battery as required. Install the battery.
- Perform all Self Inspections Before Operation checks (page 26). Test ride the motorcycle at low speeds in a safe riding area away from traffic.

## CLEANING

- Make sure to stop the engine prior to car washing.
- Be careful not to allow water to enter the muffler during the washing. Water inside the muffler may cause an improper engine starting or rust occurrence.
- Do not let water get inside the braking system during the washing, as water inside the brake system may weaken the braking power. Upon completion of washing, select a safe place where there is no traffic obstruction, and start the vehicle.  
Lightly apply the brake while driving at a slow speed and check the braking power. If the braking power has been weak-ened, apply brake lightly while driving at a slow speed to dry up the brake system.
- Take precautions when waxing the vehicle. Excessive polish of the painted section and/or the resin part with compound wax might damage the painted section causing discoloration of the affected area.

## GENERAL CLEANING

- To preserve the finish of metal parts and paintwork, wash and clean your motorcycle at regular intervals, anyway according to the road conditions you ride in.
- Especially during winter period through road salt a continuous cleaning of the vehicle is necessary so that remove the road salt. Use specific products only.
- Avoid aggressive detergents or solents

### <IMPORTANT>

- Do not wash your motorcycle right after use. When the motorcycle is still hot, water drops will evaporate faster and spot hot surfaces.
- Do not use high pressure water jets.  
Never aim the nozzle direct at wheel bearings, front fork seals, electric items, air inlets or exhaust pipe ends.
- Clean off stubborn dirt or exceeding grease from engine parts using a degreasing agent.  
Be sure to avoid contact with drive parts (chain, sprockets, etc)  
Rinse with warm water and dry all surfaces with chamois leather.

## STORAGE GUIDE

Extended storage, such as for winter, requires that you take certain steps to reduce the effects of deterioration from non-use of the motorcycle.

In addition, necessary repairs should be made BEFORE storing the motorcycle; otherwise, these repairs may be forgotten by the time the motorcycle is removed from storage.

### <STORAGE>

- Empty the fuel tank into an approved petrol container using a commercially available hand siphon or an equivalent method.
- If storage will last more than one month, carburetor draining is very important, to assure proper performance after storage.



## FRAME AND ENGINE NUMBER

- The frame number is stamped on the front central part of the frame.
- The engine number is stamped on the lower part of the left crankcase.
- The frame and engine numbers will be used as the basis of recovering the vehicle when is stolen.
- Record the frame and engine numbers along with the vehicle license plate numbers and keep them separately from the vehicle.

### <FRAME NUMBER>

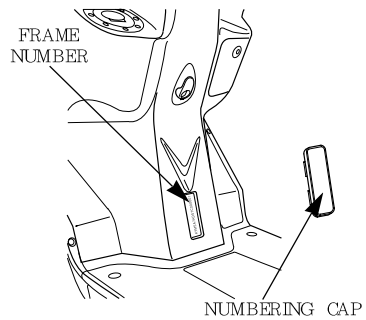

### <ENGINE NUMBER>

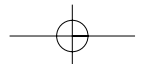
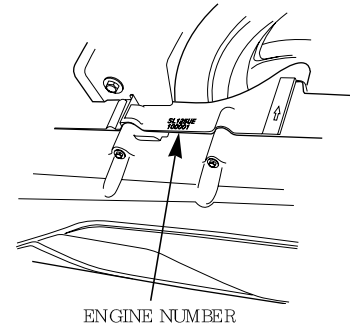

## SAFE DRIVING

### PREPARATION BEFORE DRIVING

---

- Performing daily inspection
- Putting on the protective gears (Helmet, glove, goggles, etc.)
- Bringing the driver's licence
- Determinating the path to the desired destination

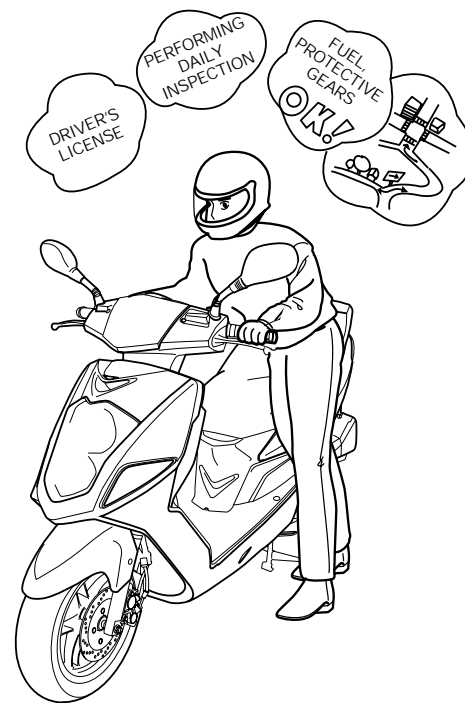

## DRIVING METHOD

### DRIVING POSITION

The appropriate driving position is most important thing to driving safely.

- ① Eyes : Look at the front direction widely.
- ② Shoulders : Relieve the tension.
- ③ Arms : Relieve the tension and bend arms to inside and let them act as the spring.
- ④ Hands : Grip the handle the position away from the inside end of the handle with distance of one finger to facilitate the operation of the switch and lever.
- ⑤ Wrist : Keep the state to act freely without applying excessive force to the shoulder and arms.
- ⑥ Knees : Press the fuel tank slightly.
- ⑦ Feet : Place the feet to face the front parallel and make the step bar be placed in the center of feet.

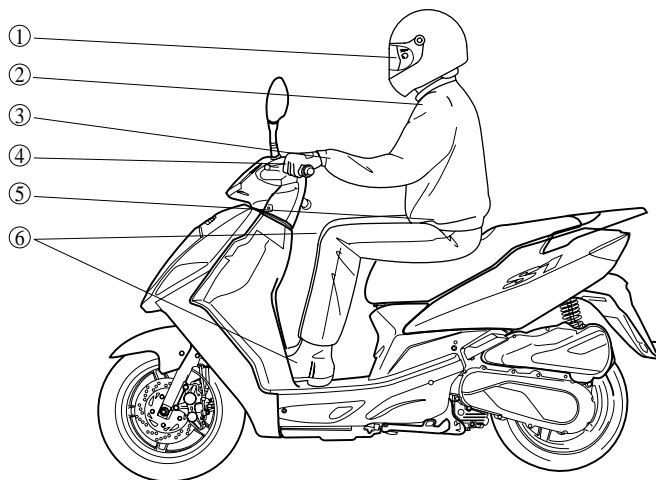

## TAKING POSE OF FELLOW PASSENGER

- ① Hands: Hold the rear grip.
- ② Feet and knees: Put the feet on pillion step, and adhere the knees closely to body.

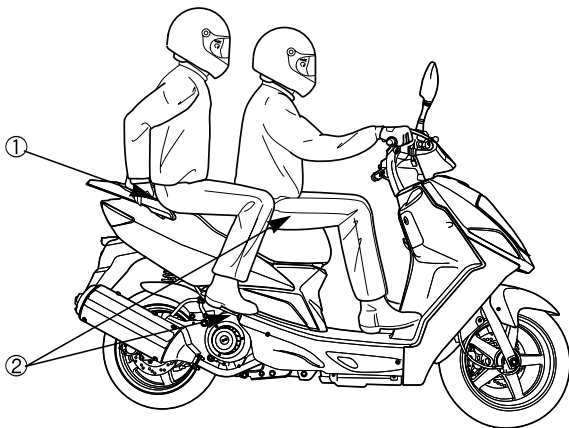

### **▲ WARNING**

- If the fellow passenger doesn't hold the rear grip or put the step on the pillion step, it may lead death or serious injury due to falling from the vehicle as sudden start, stop or turning.
- Do not operate the throttle while setting the main stand. If the fellow passenger sit on and the rear wheel touch the ground, it may lead death or serious injury due to sudden start.



## PRECAUTION WHEN DRIVING

- Secure the safe distance.
- Drive protectively.
- Do not obstruct the traffic.
- Do not drive on the pedestrian way or walkway.
- Drive on the left driveway when passing away.
- Make sure that you can apply the brake anytime.
- Always apply the brake when stopping temporarily.
- Do not drive excessively long distance and take enough break.
- If any abnormality is found, stop driving and contact service center to inspect the vehicle.
- Restart the vehicle after 2~3 min when it is turned over.
- Always turn on the headlight at night.

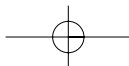

## STARTING

Prior to starting always look around to avoid accident.

- ① Get on the vehicle after pulling back the stand.
- ② Start driving slowly after turning on the winker and releasing the brake while ensuring the safety around the vehicle.

### CAUTION

- Return the side stand to its original position. Keep driving without doing this may cause turnover accident.
- Drive the vehicle only on the driveway. Driving on the walkway can cause accident. Also, if the wheel is transformed when advancing directly to the walkway, the vehicle can be overturned resulting in injury of the driver due to the driving instability.
- Overspeed driving on the unpaved road can cause the vehicle to be overturned resulting in injury of the driver due to the driving instability.
- Do not drive in the gravel road. If any gravel enters the wheel or engine case, the vehicle can be overturned resulting in injury of the driver.
- If possible, do not drive close to the sea or on the road where calcium chloride is treated.

The muffler, external parts and welded parts can be corroded rapidly, and also in case of damage of the frame, the vehicle can be overturned resulting in injury of the driver.

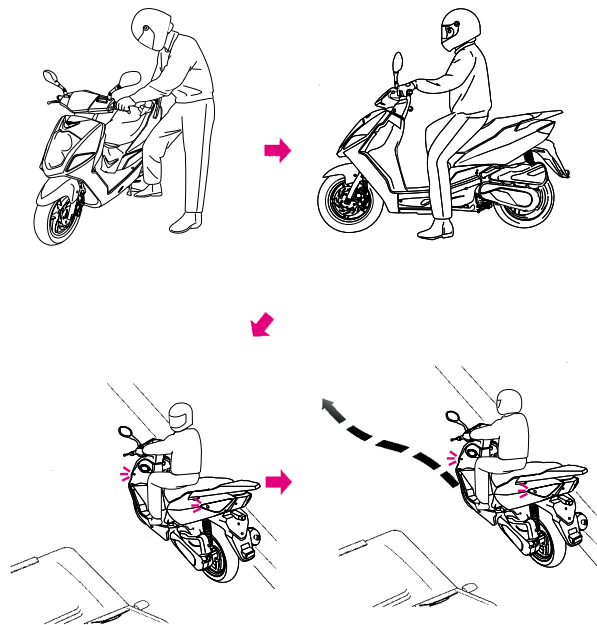



## TURNING METHOD

### PRINCIPLE OF TURN

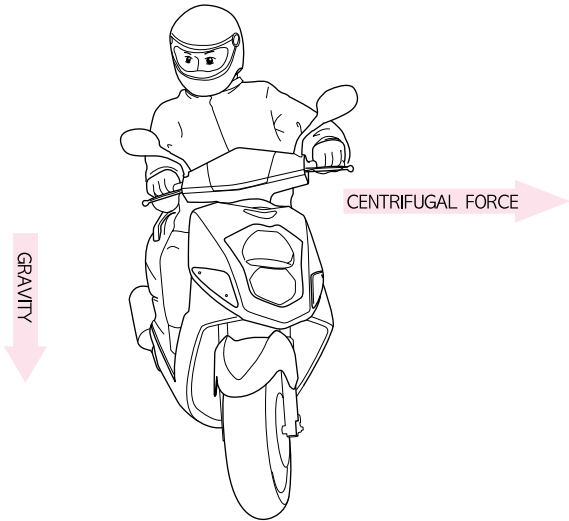

The basic principle of turn is balancing using the centrifugal force which makes vehicle go outside and the gravity which makes vehicle fall inside.

### EFFECT OF SPEED

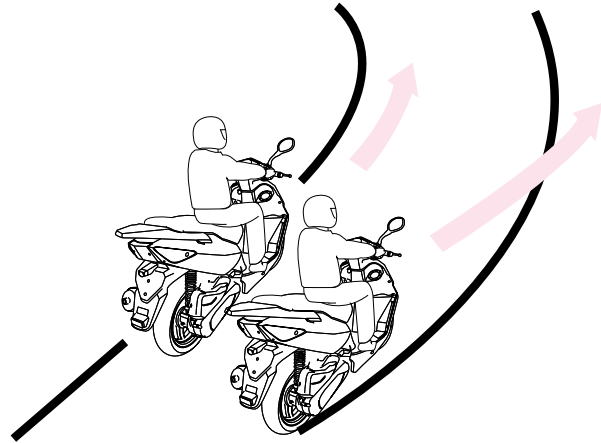

The centrifugal force increases in inverse portion to the radius of a curve and in portion to the square speed. Decelerate prior to entering the curved way to reduce the centrifugal force.



### 3 POSITIONS OF TURNING

The basic principle of turn is balancing using combined force of the centrifugal force and the gravity.

All 3 positions require straightening the head and keeping the eyes horizontally.

#### < LEAN-WITH >

This is a turning position with motorcycle and driver in a line.

This position is the most natural and exact, so driver must learn it thoroughly.

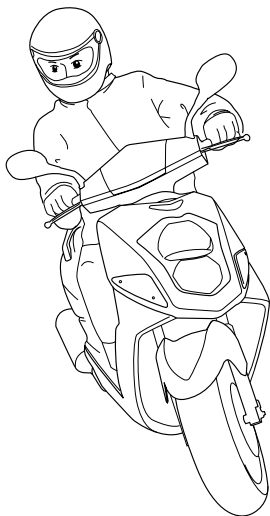

#### < LEAN-IN >

This is a turning position with driver leaned inside more than motorcycle. This position is adequate to drive on the rained or slippery road because it has best road holding.

However, special attention is required because front visual field is poor when driver leans inside more than motorcycle.

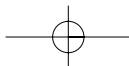
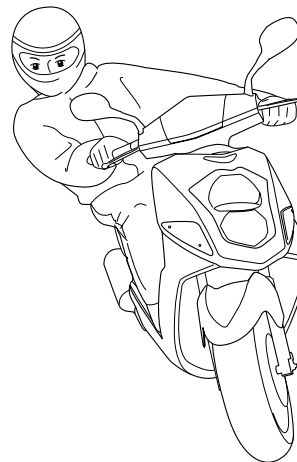



### < LEAN-OUT >

This is a turning position with motorcycle leaned inside more than driver, which is opposite to the lean-in position. With this position, quick turn is well performed and driver can obtain wide front visual field adequate to drive on the rained or slippery road because it has best road holding. However, special attention is required because there is danger of slipping on the bad holding road.

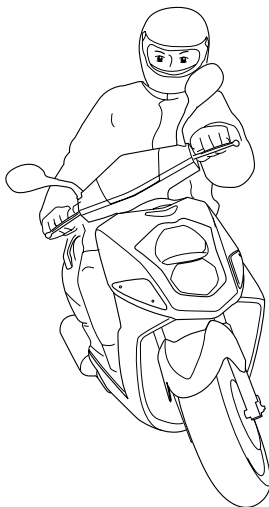

### TURNING METHOD

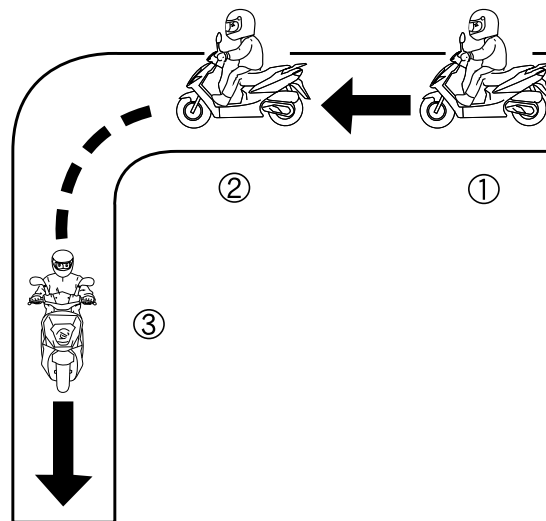

- ① Turn the throttle grip to its original position and decelerate using both front and rear brakes.
- ② Lean the vehicle toward inside of turn circle while driving slowly at constant speed.
- ③ Accelerate gradually.

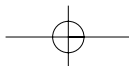



## PRECAUTION WHEN TURNING

Do not drive inside of large truck's turn circle.

### < DEAD ANGLE ZONE >

Dead angle zone is the sight range which cannot be identified by driver and increases in proportion to the width of the vehicle.

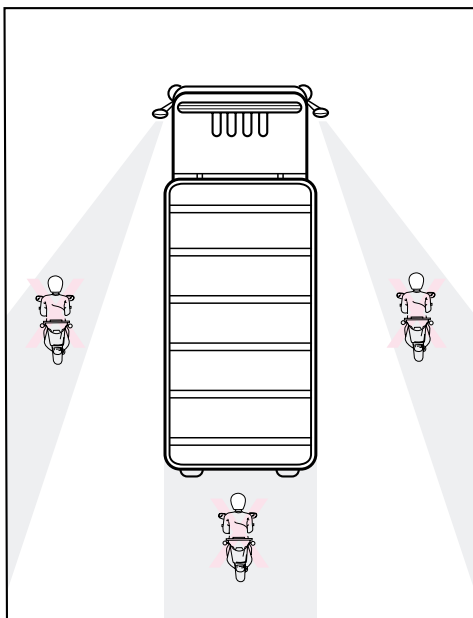

### < DISTANCE BETWEEN THE FRONT AND REAR WHEEL TURN >

It is distance between path of the front and rear wheel and increases in proportion to the length of the vehicle.

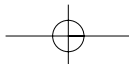
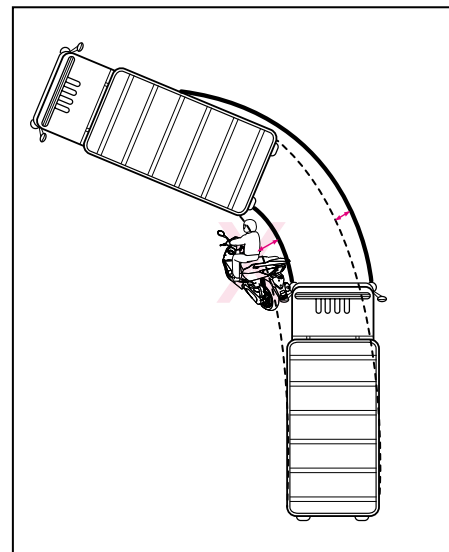

## BRAKING METHOD

### BASIC PRINCIPLE OF BRAKE (FRICTION FORCE)

- Vehicle is braked using friction between road surface and tires.
- Braking distance increases 1.5 times on wet road and 3 times on icy road because friction force of road surface is decreased.

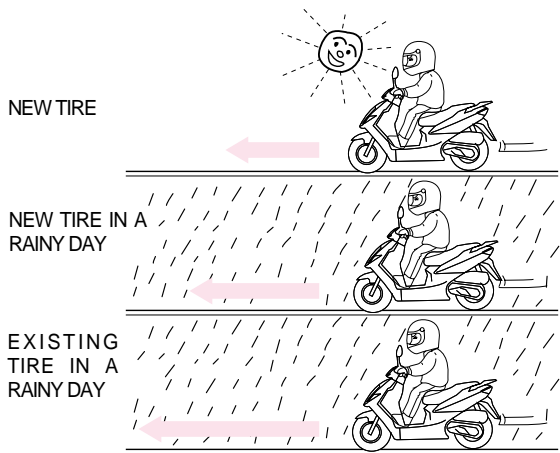

### RESTRAINT OF BRAKE EFFECT (INERTIA)

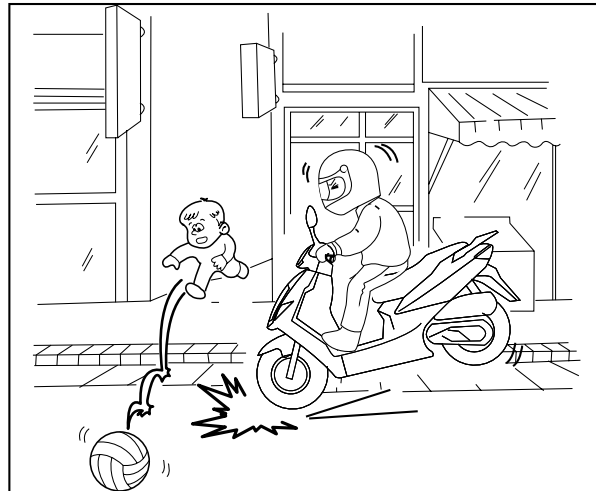

Due to the inertia, vehicle does not stop immediately after applying the brake.

## BRAKING METHOD

- Turn the throttle grip to its original position and decelerate using the engine brake.
- Erect the vehicle straight.
- Brake using both front and rear brakes.

## COMPARISON OF BRAKING DISTANCE

· Vehicle speed : 50 km/h



15m

When using both front and rear brakes



20m

When using only front brake



28m

When using only rear brake

## IMPACT WHEN COLLISION

Learn the proper braking method to prevent accident.

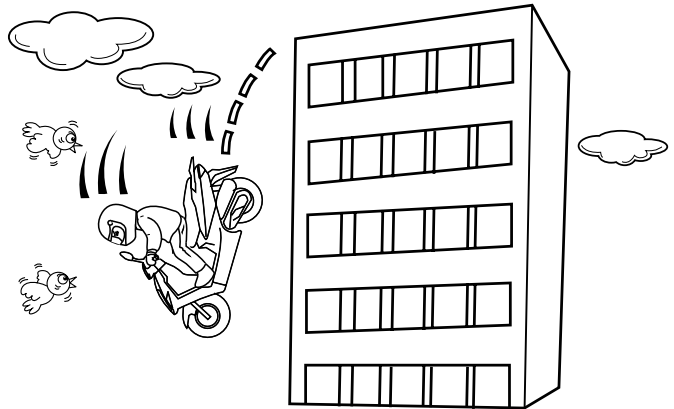

Impact increases in proportion to the speed and weight. The impact when collision to concrete wall at 50 km/h is same as one when falling from the height of 10m.

# WIRING DIAGRAM

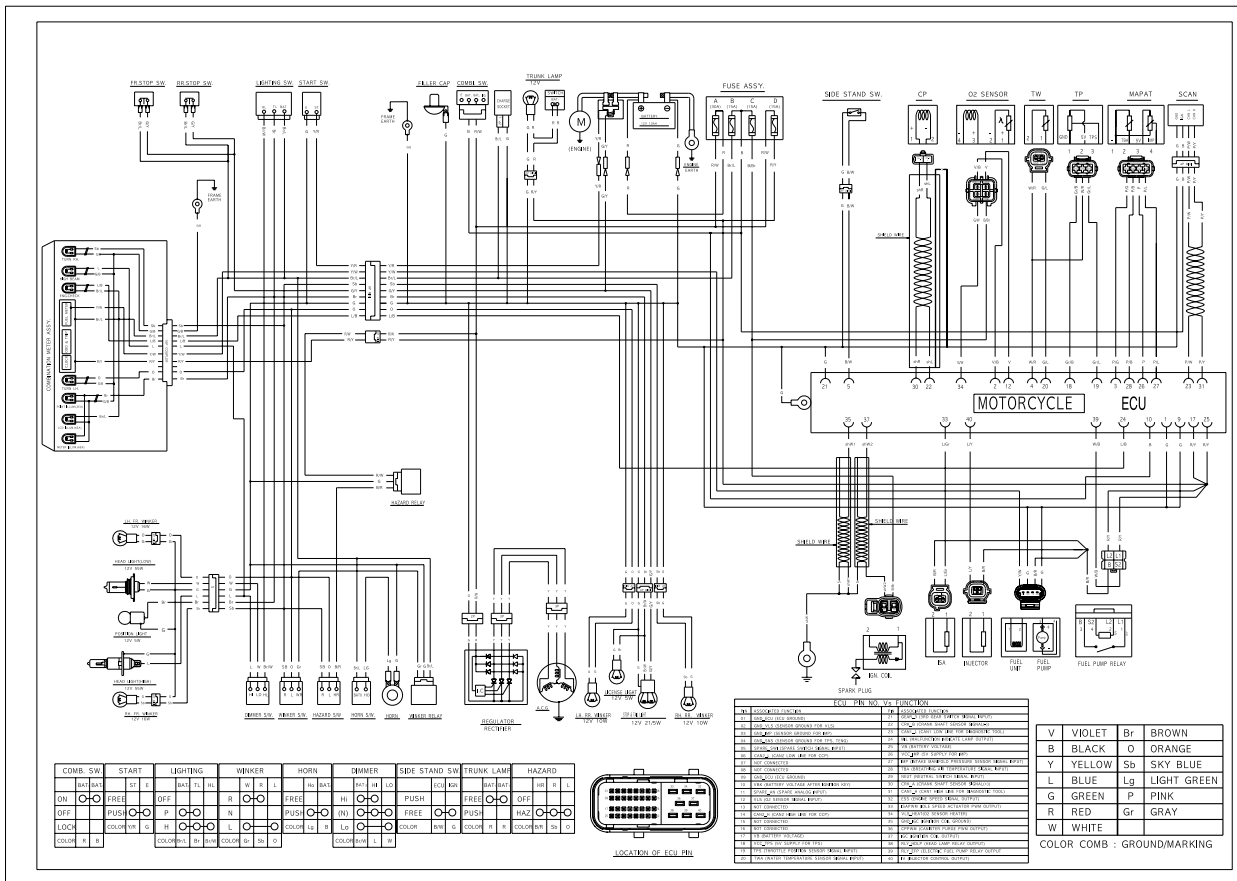



MEMO : .....

.....

.....

.....

.....

.....

.....

.....

.....

.....

.....

.....

.....

.....

.....

.....

.....

.....

.....

.....

.....

.....

.....

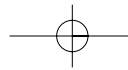





MEMO :

.....  
.....  
.....  
.....  
.....  
.....  
.....  
.....  
.....  
.....  
.....  
.....  
.....  
.....  
.....  
.....  
.....  
.....  
.....  
.....  
.....  
.....  
.....  
.....

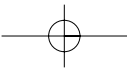



OWNER'S MANUAL

2007. 03 PRINTED  
2007. 03 PUBLICATION

NO COPY

 **DAELIM MOTOR**



■ HEAD OFFICE(FACTORY)

#58, SUNG SAN-DONG, CHANG WON, KYUNGNAM, KOREA

TEL: (82-55) 239-7000 / FAX: (82-2) 467-9997