



1190 SX
1190 RX

2014 EBR OWNER'S MANUAL

EBR 1190RX Model
EBR 1190SX Model

IMPORTANT NOTICE!

Safety Definitions

Statements in this manual preceded by the following words are of special significance:

WARNING

WARNING indicates a potentially hazardous situation which, if not avoided, could result in death or serious injury.

CAUTION

CAUTION indicates a potentially dangerous situation which, if not avoided, may result in minor or moderate injury.

CAUTION

CAUTION used without the safety alert symbol indicates a potentially hazardous situation which, if not avoided, may result in property damage.

NOTE Refers to important information and is placed in Italic type font. Please take special notice of these items.

EBR MOTORCYCLES ARE FOR ON-ROAD USE ONLY This motorcycle is not equipped with a spark arrestor and is configured only to be ridden on the road. Off-road usage in certain areas could be illegal. Please obey local laws and regulations.



YOUR OWNER'S MANUAL

Dear new EBR Owner, Welcome to the American sport motorcycle: EBR! Your motorcycle is the result of years of racing and design knowledge of a dedicated team of sport motorcycling enthusiasts who are also highly trained engineers and technicians. Careful consideration has been given to the form and function of your bike, to bring you an unparalleled riding experience. The unique styling, first rate handling, and exciting community delivered to you by EBR will redefine the way you think about motorcycle riding. Please read through this manual carefully and thoroughly, and consider the NOTES emphasized by the EBR Staff. Take care of yourself and your EBR motorcycle in all the ways detailed in this manual, and the thrill of the road will stretch before you. Our goal is to delight you with your EBR ownership and riding experience, and to offer you the bike that can bring you an adventure unlike any other. Best of roads ahead to you, Erik Buell.

Your Owner's Manual contains instructions for the safe operation and minor maintenance required to keep your EBR motorcycle at peak performance. More serious repairs are covered in detail in a separate EBR Service Video. Such major repairs require the attention of a skilled technician and the use of special tools and equipment. Your EBR dealer has the facilities, experience and genuine EBR parts necessary to properly render this valuable service. It is recommended that any emission system maintenance be performed by an authorized EBR dealer. Your EBR motorcycle conforms to all applicable U.S. Federal Motor Vehicle Safety Standards and U.S. Environmental Protection Agency regulations effective on the date of manufacture. When enjoying your EBR motorcycle, be sure to ride safely, defensively and within the limits of the law. Ride with your headlamp on to increase your visibility, always wear a helmet, and make sure you have on proper eyewear and protective clothing. Never ride while under the influence of alcohol or drugs.

© 2014 Erik Buell Racing LLC

CUSTOMER SERVICE ASSISTANCE

The majority of all sales or service issues will be resolved at the dealership. However if an issue arises that your dealer cannot resolve, please follow the procedure below. Discuss your problem with the appropriate personnel at the dealership in the Sales, Service or Parts area. If that proves unsuccessful, speak to the owner of the dealership or the general manager. If you cannot resolve the issue with the dealership, you can contact the EBR Customer Service Department by calling 262-642-1627, emailing info@ebr.com or writing to:

Attention: EBR Customer Service Department EBR LLC.
2799 Buell Drive
East Troy, WI 53120 USA

For efficient service and support, please have the following information available to give to the Customer Service Representative:

- Your name, address and phone number.
- Motorcycle V.I.N. (Vehicle Identification Number) found on the vehicle registration or stamped on the steering head and on a label located on the motorcycle itself.
- Name and location of the dealership.
- Current mileage.
- Clear description of issue.

Personal Information

| PERSONAL INFORMATION | | DEALER INFORMATION | |
|----------------------|--|--------------------|--|
| Name | | Name | |
| Address | | Address | |
| Telephone | | Telephone | |
| Email | | Sale Contact | |
| Vehicle ID Number | | Parts Contact | |
| Ignition Key Number | | | |
| Purchase Date | | | |

This owner's manual illustrates and describes features that are standard or are available as extra cost options. Therefore, some of the equipment options shown in this publication may not be on your motorcycle. EBR reserves the right to change specifications, equipment or designs at any time without notice and without incurring obligation.

Contents

| | |
|--------------------------|---|
| Safety Definitions | 2 |
|--------------------------|---|

| | |
|--|----------|
| CUSTOMER SERVICE ASSISTANCE | 5 |
|--|----------|

| | |
|------------------------------------|-----------|
| SAFE OPERATING RULES: | 12 |
|------------------------------------|-----------|

| | |
|------------------|----|
| GVWR / GAWR..... | 16 |
|------------------|----|

| | |
|-------------------------|----|
| RULES OF THE ROAD | 18 |
|-------------------------|----|

| | |
|----------------------------|----|
| ACCESSORIES AND CARGO..... | 19 |
|----------------------------|----|

| | |
|-----------------------------|-----------|
| IDENTIFICATION | 25 |
|-----------------------------|-----------|

VEHICLE IDENTIFICATION NUMBER: EBR 1190 RX/SX

| | |
|--------------|----|
| MODELS | 25 |
|--------------|----|

| | |
|---|----|
| Table 1. EBR V.I.N. Breakdown: 2014 Models..... | 25 |
|---|----|

| | |
|-------------------------|----|
| LABELS: EBR MODELS..... | 26 |
|-------------------------|----|

| | |
|-----------------------------|-----------|
| SPECIFICATIONS | 27 |
|-----------------------------|-----------|

| | |
|--------------|----|
| ENGINE | 27 |
|--------------|----|

| | |
|-----------------|----|
| Drivetrain..... | 28 |
|-----------------|----|

| | |
|----------------------|----|
| Cooling System | 28 |
|----------------------|----|

| | |
|-------------------------|----|
| Liquid Capacities | 28 |
|-------------------------|----|

| | |
|----------------------|----|
| Sprocket teeth | 29 |
|----------------------|----|

| | |
|-------------------------------|----|
| Transmission Gear Ratios..... | 29 |
|-------------------------------|----|

| | |
|-------------|----|
| Tires | 30 |
|-------------|----|

| | |
|-----------------|----|
| Bulb Chart..... | 30 |
|-----------------|----|

| | |
|------------------|----|
| Dimensions | 30 |
|------------------|----|

| | |
|---------------|----|
| Weights | 31 |
|---------------|----|

| | |
|-------------------|-----------|
| TIRE | 31 |
|-------------------|-----------|

| | |
|------------------------------|-----------|
| GASOLINE BLENDS | 31 |
|------------------------------|-----------|

| | |
|------------------|-----------|
| FUEL..... | 32 |
|------------------|-----------|

| | |
|----------------------------|-----------|
| Octane Ratings..... | 33 |
|----------------------------|-----------|

| | |
|----------------------------------|-----------|
| CATALYTIC CONVERTERS..... | 33 |
|----------------------------------|-----------|

| | |
|------------------------|-----------|
| OPERATION | 33 |
|------------------------|-----------|

| | |
|----------------------|-----------|
| GENERAL | 33 |
|----------------------|-----------|

| | |
|------------------------------|----|
| CONTROLS AND INDICATORS..... | 33 |
|------------------------------|----|

| | |
|------------------------------------|----|
| IGNITION/HEADLAMP KEY SWITCH | 33 |
|------------------------------------|----|

| | |
|---------------------------------|----|
| Turning Motorcycle On/Off | 34 |
|---------------------------------|----|

| | |
|-----------------------------|----|
| Parking the Motorcycle..... | 35 |
|-----------------------------|----|

| | |
|-----------------------------|----|
| Locking Steering Head | 35 |
|-----------------------------|----|

| | |
|-----------------------------|----|
| Engine OFF/RUN Switch | 36 |
|-----------------------------|----|

| | |
|----------------------------|----|
| Throttle Control Grip..... | 36 |
|----------------------------|----|

| | |
|------------------------|----|
| Clutch Hand Lever..... | 38 |
|------------------------|----|

| | |
|--|-----------|
| Horn Switch | 38 |
| Headlamp High/Low Beam Switch | 38 |
| Passing Lamp Switch | 38 |
| Turn Signal Switch | 38 |
| INSTRUMENT CLUSTER..... | 39 |
| Tachometer..... | 40 |
| Speedometer..... | 40 |
| Odometer..... | 41 |
| Warning Lights and Messages..... | 41 |
| SELECTING FUNCTIONS..... | 43 |
| GEAR SHIFT LEVER..... | 49 |
| ADJUSTING SHIFTER TOE PEG..... | 51 |
| ADJUSTING HANDLE BAR LEVERS | 51 |
| BRAKES..... | 52 |
| ADJUSTING REAR BRAKE TOE PEG..... | 53 |
| ADJUSTING FRONT BRAKE LEVER | 53 |
| FUEL FILLER CAP..... | 53 |
| REMOVAL..... | 54 |
| INSTALLATION..... | 54 |
| FUEL FILL LEVEL..... | 54 |
| STEERING HEAD LOCK..... | 55 |
| SIDESTAND..... | 55 |
| REAR VIEW MIRRORS..... | 55 |
| RIDER SEAT..... | 56 |
| Rider Seat Removal..... | 56 |
| Passenger Seat Removal/Fuse Access | 57 |

OPERATING RECOMMENDATIONS..... 58

| | |
|---|-----------|
| General..... | 59 |
| Operating on a dynamometer..... | 59 |
| BREAK-IN RULES..... | 60 |
| The First 620 Miles (1000 Km)..... | 60 |
| PRE-RIDING CHECK LIST..... | 61 |
| SIDESTAND INTERLOCK..... | 63 |
| STARTING THE ENGINE..... | 63 |
| STOPPING THE ENGINE..... | 65 |
| SHIFTING GEARS..... | 65 |
| Getting Started..... | 65 |
| Upshift (Acceleration)..... | 66 |
| Downshift (Deceleration)..... | 67 |
| Traction Control..... | 68 |
| Suggested Traction Control Levels..... | 71 |
| SUSPENSION ADJUSTMENTS..... | 71 |
| SUSPENSION DEFINITIONS..... | 72 |
| SUGGESTED SUSPENSION SETTINGS..... | 73 |
| FINE TUNING SUSPENSION..... | 78 |
| Changes in Load..... | 78 |
| Ride Quality Enhancement..... | 78 |
| Enhanced Steering Quickness..... | 79 |
| Chassis Control/Handling Enhancement..... | 79 |

MAINTENANCE AND LUBRICATION 80

| | |
|--|-----------|
| SAFE OPERATING MAINTENANCE..... | 80 |
|--|-----------|

| | |
|---|------------|
| BREAK-IN MAINTENANCE | 80 |
| INITIAL SERVICE CHECK | 81 |
| SERVICE INTERVALS AND PERFORMANCE | 82 |
| ENGINE LUBRICATION | 82 |
| CHECKING OIL LEVEL | 83 |
| Oil Level Cold Check | 84 |
| Oil Level Hot Check | 85 |
| ENGINE OIL CHANGE | 86 |
| WINTER LUBRICATION | 90 |
| FUEL FILTER | 90 |
| CHAIN DRIVE | 90 |
| CHASSIS LUBRICATION | 92 |
| FRONT FORK OIL | 93 |
| AIR FILTER | 93 |
| COOLANT LEVEL | 95 |
| Coolant Type | 95 |
| Checking and Adding Coolant in Expansion Tank | 95 |
| STORAGE | 96 |
| Placing Motorcycle in Storage | 97 |
| CLEANING YOUR EBR | 97 |
| WINDSHIELD MAINTENANCE | 98 |
| BODY PANEL CARE | 98 |
| Washing..... | 99 |
| Polishing | 99 |
| Minor Scratch Removal | 99 |
| Major Scratch Removal | 99 |
| WHEEL CARE | 100 |

| | |
|---|------------|
| FRAME AND SWINGARM CARE | 100 |
| HYDRAULIC CLUTCH | 100 |
| General..... | 100 |
| Checking Fluid Level..... | 100 |
| BRAKES | 102 |
| TIRES | 104 |
| TIRE REPLACEMENT | 105 |
| SHOCK ABSORBER | 107 |
| SPARK PLUGS/COILS | 107 |
| IGNITION TIMING | 107 |
| IDLE SPEED | 107 |
| WHEEL BEARINGS | 107 |
| VOLTAGE REGULATOR | 108 |
| BATTERY | 108 |
| GENERAL | 108 |
| HEADLAMP | 112 |
| HEADLAMP ALIGNMENT | 113 |
| HEADLAMP ADJUSTMENT | 116 |
| TROUBLESHOOTING | 118 |
| GENERAL | 118 |
| ENGINE | 118 |
| Starter Does not Operate or Does Not Turn Engine Over. | 118 |
| Engine Turns Over But Does Not Start or Starts Hard. | 119 |
| Starts But Runs Irregularly or Misses..... | 119 |

| | |
|--|------------|
| A Spark Plug Fouls Repeatedly..... | 120 |
| Pre-Ignition or Detonation (Knocks or Pings) | 120 |
| Overheats | 120 |
| Excessive Vibration | 120 |
| Poor Fuel Economy | 120 |
| LUBRICATION SYSTEM | 121 |
| ELECTRICAL SYSTEM..... | 121 |
| Alternator Does Not Charge..... | 121 |
| Alternator Charge Rate is Below Normal..... | 121 |
| TRANSMISSION | 121 |
| Transmission Shifts Hard | 121 |
| Transmission Jumps Out of Gear..... | 121 |
| Clutch Slips | 121 |
| Clutch Drags or Does Not Release | 121 |
| Clutch Chatters..... | 121 |
| BRAKES | 121 |
| Brakes Do Not Hold | 122 |
| COOLING SYSTEM | 122 |
| Overheats | 122 |
| WARRANTY AND MAINTENANCE | 122 |
| KEEPING IT ALL EBR | 123 |
| CALIFORNIA EVAPORATIVE EMISSION CONTROL | 124 |
| EPA NOISE REGULATIONS IN THE UNITED STATES | 124 |
| TAMPERING WITH NOISE CONTROL SYSTEM | |
| PROHIBITED..... | 124 |

| | |
|--|------------|
| AMONG THOSE ACTS PRESUMED TO CONSTITUTE | |
| TAMPERING ARE THE ACTS LISTED BELOW..... | 124 |
| WARRANTY AND SERVICE INFORMATION | 124 |
| REPORTING SAFETY DEFECTS IN THE | |
| UNITED STATES | 125 |
| NHTSA Statement..... | 125 |
| OWNER TRANSFER IDENTIFICATION | |
| FORM..... | 125 |
| LIMITED WARRANTY 2014 EBR 1190 | |
| RX/SX MOTORCYCLE | 127 |
| DURATION | 127 |
| OWNER'S OBLIGATIONS | 128 |
| EXCLUSIONS | 128 |
| OTHER LIMITATIONS | 129 |
| IMPORTANT: READ CAREFULLY..... | 129 |
| 2014 EBR NOISE CONTROL SYSTEM LIMITED WARRANTY | |
| | 130 |
| Other Rights..... | 131 |
| Recommendations for Required Maintenance..... | 131 |
| EMISSION CONTROL SYSTEM | |
| SUPPLEMENTAL WARRANTY..... | 131 |

YOUR WARRANTY RIGHTS AND OBLIGATIONS..... 132
MANUFACTURER'S EMISSION CONTROL SYSTEM
SUPPLEMENTAL WARRANTY COVERAGE..... 132
OWNER'S EMISSION CONTROL SYSTEM SUPPLEMENTAL
WARRANTY RESPONSIBILITIES..... 133

ERIK BUELL RACING, LLC - LIMITED
WARRANTY ON EMISSION CONTROL
SYSTEM 133
REGULAR SERVICE INTERVALS 137
TIRE REGISTRATION FORM 142

SAFE OPERATING RULES: EBR 1190 MODELS

WARNING

Motorcycles operate, steer, handle and brake differently from other vehicles. Motorcycles are less visible to other drivers, and offer less crash protection than cars or trucks. Unskilled or improper use could result in loss of control, death or serious injury.

-Take a rider training course, and become familiar with the function and feel of your own motorcycle.

-Read Owner's Manual before riding, adding accessories or servicing.

-Always wear a helmet, eye protection and protective clothing.

-Never tow a trailer.

Before operating your new EBR, it is your responsibility to read and follow the operating and maintenance instructions in this manual. Follow these basic rules for your personal safety.

Know and respect the Rules of the Road. See RULES OF THE ROAD. You should also read and know the contents of the Motorcycle Handbook for your State.

Before starting the engine, check for proper operation of brake, clutch, shifter and throttle controls. Inspect fuel and oil supply.

WARNING

Do not use aftermarket parts and custom made accessories which can adversely affect performance and handling. Removing or altering factory installed parts can adversely affect performance and could result in death or serious injury.

Use only EBR Approved parts and accessories. Use of certain "race only" or other manufacturers performance parts will void your new motorcycle warranty. See an EBR Dealer for details.

WARNING

Avoid spills. Slowly remove gasoline filler cap. Do not fill above bottom of filler neck insert, leaving air space for fuel expansion. Secure filler cap after refueling. Gasoline is extremely flammable and highly explosive, which could result in death or serious injury.

WARNING

Use care when refueling. Pressurized air in fuel tank can force gasoline to escape through filler tube. Gasoline is extremely flammable and highly explosive, which could result in death or serious injury.

When refueling observe the following rules:

- Refuel in a well ventilated area with the engine off.
- Remove filler cap slowly.
- Do not smoke or allow open flames or sparks when refueling or performing service on the fuel system.
- Do not over fill see figure 29. Gasoline expands as it warms, allow room for this.

WARNING

Do not remove radiator filler cap when engine is hot. The cooling system is under pressure and hot coolant and steam can escape, which could cause severe burns. Allow engine to cool before servicing cooling system.

CAUTION

Cooling fans operate automatically, even when the ignition switch is off. Keep hands away from fan blades. Contact with a rotating fan blade can result in minor or moderate injury.

CAUTION

At operating temperature, the radiator and oil cooler contain hot fluids. Contact with the radiator or oil cooler can result in minor or moderate burns.

WARNING

Engine exhaust from this product contains chemicals known to the State of California to cause cancer, birth defects or other reproductive harm

WARNING

Do not run motorcycle in a closed garage or confined area. Inhaling motorcycle exhaust, which contains poisonous carbon monoxide gas, could result in death or serious injury.

See OPERATION, Break-in Riding Rules: EBR 1190 RX/SX. A new motorcycle must be operated according to the break-in procedure. Operate motorcycle only at moderate speed and out of traffic until you have become familiar with its operation and handling characteristics under all conditions.

NOTE

We recommend that you obtain information and formal training in the correct motorcycle riding technique. In the United States, the Motorcycle Safety Foundation® offers beginning and experienced rider safety courses. Call (800)446-9227 for information.

WARNING

Travel at speeds appropriate for road and conditions and never travel faster than posted speed limit. Excessive speed

can cause loss of vehicle control, which could result in death or serious injury.

Know your limits as a rider. Do not exceed the legal speed limit or drive too fast for existing conditions. Always reduce speed when poor driving conditions exist and/or you feel the driving situation is uncomfortable. High speed increases the influence of any other condition affecting stability and increases the possibility of loss of control. The EBR 1190 RX/SX is equipped with passenger accommodations. **DO NOT EXCEED GVWR.**

Pay strict attention to road surfaces and wind conditions. Your motorcycle may be subject to the following upsetting forces:

- Irregular pavement surfaces, such as holes, patches.
- Wind blasts from passing vehicles.
- Oil spills, gravel, etc. on road surface.
- Inappropriate rider control input.

These forces may influence the handling characteristics of your motorcycle. If this happens, reduce speed and guide the motorcycle with a relaxed grip to a controlled condition. Do not brake abruptly or force the handlebar; this may aggravate an unstable condition.

NOTE

New riders should gain experience under various conditions while riding at moderate speeds.

Operate your motorcycle defensively. Remember, a motorcycle does not afford the same protection as an automobile in an accident. One of the most common accident situations occurs when the driver of the other vehicle fails to see or recognize a motorcycle and turns left into the oncoming motorcyclist.

Riding with headlamp high beam switch on during daylight hours will increase your chances of visibility. Wear a helmet, clothing, and foot gear suited for motorcycle riding. Bright or light colors are best for greater visibility in traffic, especially at night. Avoid loose, flowing garments and scarves.

WARNING

Avoid contact with exhaust system and wear protective clothing that completely covers legs while riding. Exhaust pipes and mufflers get very hot when engine is running and remain too hot to touch, even after engine is turned off.

Failure to wear protective clothing could result in burns or other serious injury.

Do not allow others under any circumstances to operate your motorcycle unless you know they are experienced, licensed riders and are familiar with the operation of your particular motorcycle. Protect your motorcycle against theft. After parking your motorcycle, lock the steering head and remove ignition key from switch.

WARNING

Perform the service and maintenance operations as indicated in the regular service interval table. Lack of regular maintenance at the recommended intervals can affect the safe operation of your motorcycle, which could result in death or serious injury.

WARNING

Do not operate motorcycle with loose, worn or damaged steering or suspension systems. Contact an EBR dealer for repairs. Loose, worn or damaged steering or suspension components can adversely affect stability and handling, which could result in death or serious injury.

Be sure all equipment required by law is installed and in good operating condition.

WARNING

Use EBR replacement fasteners. Aftermarket fasteners can adversely affect performance, which could result in death or serious injury.

See an EBR Parts Manual for proper torque values. Aftermarket fasteners may not have the specific property requirements to perform properly.

WARNING

Do not tow a disabled motorcycle. Towing can adversely affect stability and handling, which could result in death or serious injury.

WARNING

Match tires, air valves and caps to the correct wheel rim. Contact an EBR dealer. Mismatching can result in damage to the tire bead, allow tire slippage on the rim or cause tire failure, which could result in death or serious injury. Be sure

tires are properly inflated, balanced and have adequate tread. Inspect your tires regularly and see an EBR dealer for replacements. Riding with excessively worn, unbalanced or under-inflated tires can adversely affect stability and handling, which could result in death or serious injury.

WARNING

Do not exceed the motorcycle's Gross Vehicle Weight Rating (GVWR) or Gross Axle Weight Rating (GAWR). Exceeding these weight ratings can affect stability and handling, which could result in death or serious injury.

GVWR / GAWR

- GVWR is the sum of the weight of the motorcycle, accessories, and the maximum weight of the rider, and cargo that can be safely carried.
- GAWR is the maximum amount of weight that can be safely carried on each axle.
- The GVWR and GAWR are shown on the United States information label only, located on the frame steering head.

⚠ WARNING

Do not pull a trailer with a motorcycle. Pulling a trailer can cause tire overload, reduced braking efficiency and adversely affect stability and handling, which could result in death or serious injury.

⚠ WARNING

Regularly inspect shock absorbers and front forks. Replace leaking, damaged or worn parts that can adversely affect stability and handling, which could result in death or serious injury.

⚠ WARNING

Observe warnings on labels of brake fluid and cleaning compounds. Failure to follow warnings could result in death or serious injury.

⚠ WARNING

Consult an EBR dealer regarding any questions or problems that occur in the operation of your motorcycle. Failure to do so can aggravate an initial problem, cause costly repairs, cause an accident and could result in death or serious injury.

RULES OF THE ROAD

EBR recommends that inexperienced riders complete the beginners Motorcycle Rider Course® sponsored by the Motorcycle Safety Foundation®.

Important tips about riding are listed below.

- Always sound your horn but do not rely on it to be your only defense against other riders or drivers of automobiles and trucks.
- Never try to pass another vehicle going in the same direction at street intersections, on curves, or when going up or down a hill.
- When you are at street intersections, give the right-of-way to vehicles according to local regulations. Do not assume you have the right-of-way; the other driver may not know that it is your turn.
- Always use your signals when preparing to pass a vehicle, change lanes, turn or stop.
- All traffic signs, including those used for the control of traffic at intersections, should be obeyed promptly.
- SLOW DOWN signs near schools and caution signs at railroad crossings should always be observed and your actions governed accordingly.
- When intending to turn, signal at least 100 ft (30 m) before reaching the turning point. When turning across an intersection, move over to the centerline of the street (unless road is oily, icy, wet or under construction).
- Watch for debris such as leaves or loose gravel. Weather and traffic conditions on the highway dictate adjusting your speed and driving habits accordingly.
- Never run through a yellow or red traffic light. When a change is indicated, slow down and wait for the light to change.
- While turning either right or left, watch for pedestrians and animals; as well as vehicles.
- Do not leave the curb or parking area without signaling and being sure that your way is clear to enter moving traffic.
- Moving lines of traffic have the right-of-way.
- Be sure that your license plate is installed in the position specified by law and that it is clearly visible at all

times. Keeping the plate clean will improve visibility of the motorcycle to other motorists (especially at night).

WARNING

Operating this motorcycle in a reckless manner, including performing wheelies, stoppies or burnouts, can lead to parts failure or loss of control, which could result in death or serious injury.

ACCESSORIES AND CARGO

WARNING

Improper loading of cargo or installation of accessories can affect motorcycle stability and handling, which could result in death or serious injury.

EBR cannot test and make specific recommendations regarding every accessory or combination of accessories sold, the rider must assume responsibility for safe operation of the motorcycle when installing accessories or carrying additional weight. Use the following guidelines when equipping a motorcycle, or carrying cargo.

- Keep cargo weight concentrated close to the motorcycle and as low as possible to minimize the change in the motorcycle's center of gravity. Distribute weight evenly on both sides of the vehicle and do not load bulky items too far behind the rider, or add weight to the handlebars or front forks.
- Be sure cargo is secure and will not shift while riding. Periodically recheck load.
- Accessories that change the operator's riding position can increase reaction time and adversely affect handling. Only use such items if they are designed and approved by EBR, built specifically for your motorcycle and installed properly. Additional electrical equipment can overload the motorcycle's electrical system and cause an unsafe operating condition. Large surfaces, such as fairings, windshields, backrests and luggage racks, can affect handling. These items should be designed and approved by EBR specifically for the motorcycle model and properly installed.

 **WARNING**

EBR motorcycles are not designed for sidecar use. Sidecar use with an EBR can adversely affect handling and reduce braking efficiency, which could result in death or serious injury.

 **WARNING**

Do not use aftermarket parts which can adversely affect performance and handling. Removing or altering factory installed parts can adversely affect performance and could result in death or serious injury.

 **WARNING**

Keep tail lamp visible at all times. Do not place objects on license plate bracket blocking tail lamp visibility. Low visibility of rider can result in death or serious injury.



| 1 | 2 | 3 | 4 | 5 | 6 | 7 | 8 | 9 | 10 |
|-------------|-----------|--------------|-----------------|-------------|----------------------|----------------|--------------------|--------------|-----------|
| Turn Signal | Headlight | Clutch Lever | Ignition switch | Fuel Filler | Battery (under seat) | Tail/stoplight | Passenger Footpegs | Gear Shifter | Sidestand |

Figure 1. 1190 RX Left Side View.



| 1 | 2 | 3 | 4 | 5 | 6 | 7 |
|-------|-------------|---------------|-------------------|---------------------|------------------|--------------------|
| Shock | Turn Signal | License Plate | Front Brake Lever | Front Brake Caliper | Rear Brake Lever | Rear Brake Caliper |

Figure 2. 1190 RX Right Side View.



| 1 | 2 | 3 | 4 | 5 | 6 | 7 | 8 | 9 | 10 |
|-------------|-----------|--------------|-----------------|-------------|----------------------|----------------|--------------------|--------------|-----------|
| Turn Signal | Headlight | Clutch Lever | Ignition switch | Fuel Filler | Battery (under seat) | Tail/stoplight | Passenger Footpegs | Gear Shifter | Sidestand |

Figure 1. 1190 SX Left Side View.



| 1 | 2 | 3 | 4 | 5 | 6 | 7 |
|-------|-------------|---------------|-------------------|---------------------|------------------|--------------------|
| Shock | Turn Signal | License Plate | Front Brake Lever | Front Brake Caliper | Rear Brake Lever | Rear Brake Caliper |

Figure 2. 1190 SX Right Side View.

IDENTIFICATION

VEHICLE IDENTIFICATION NUMBER: EBR 1190 RX/SX MODELS

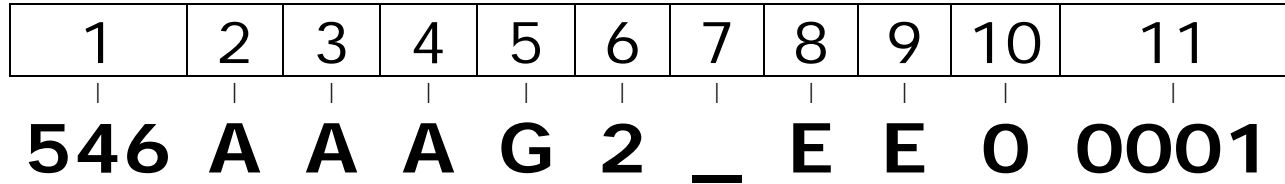

| POSITION | 1 | 2 | 3 | 4 | 5 | 6 | 7 | 8 | 9 | 10 | 11 |
|-----------------|-----------------------|--------------------------------|----------------|------|-----------|-------------|-------------|----------------------|----------------|---|------------------------------|
| DESCRIPTION | WMI Code | Motorcycle Type | Model | Make | BHP | Engine Type | Check Digit | Model Year | Plant Location | Market | Sequential Production Number |
| POSSIBLE VALUES | Erik Buell Racing LTD | A=Superbike B=Streetfighter | A = R B = S | EBR | G=176-200 | 2= Twin | Calculated | E = 2014 F = 2015 | E = East Troy | 0 = USA (All) 1 = EU 3= USA 49 state 5 = Australia | 00001 00002 Etc. |

Table 1. EBR V.I.N. Breakdown: 2014 Models

LABELS: EBR MODELS

See Figure 3 for safety and maintenance labels which were on the vehicle when new. If removed, replacement labels may be purchased for your motorcycle. Refer to Table 2 for label descriptions.

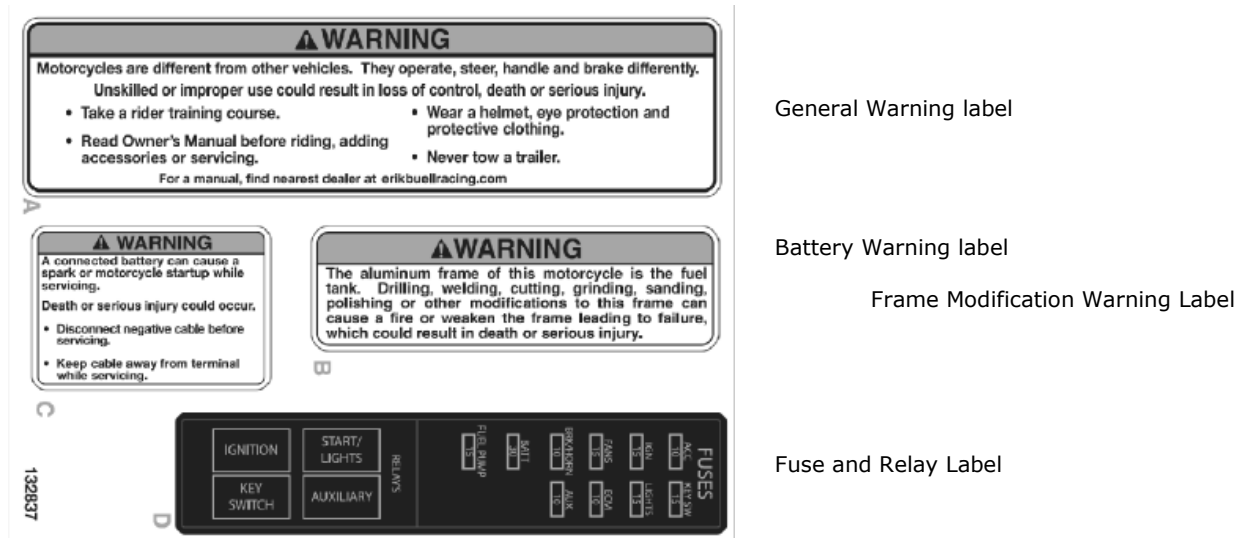

General Warning label

Battery Warning label

Frame Modification Warning Label

Fuse and Relay Label

Figure 3. Safety Labels

SPECIFICATIONS

2014 EBR 1190 RX/SX MODELS

ENGINE

| Item | Specification | |
|-------------------|---|-----------|
| Cylinders | 2 | |
| Type | 72 Degree V-Twin, Liquid Cooled, four-stroke | |
| Bore | 4.173 in. | 106.00 mm |
| Stroke | 2.658 in. | 67.50 mm |
| Displacement | 72.6 cu. in. | 1191 cc |
| Compression Ratio | 13.4:1 | |
| Valve Train | DOHC, four valves per cylinder | |
| Fuel Delivery | Electronic Fuel Injection | |
| Lubrication | Dry sump, reservoir integrated in the engine | |
| Battery | Li-ion, 13.2 volt, 7 amp/hr, 315 cold cranking amps | |
| Spark Plugs | NGK CR9EKB | |
| Size | 10 mm | |
| Gap | .032 in. | 0.81 mm |
| Torque | 7 – 9 ft-lbs | 10- 12 Nm |

Table 2.

NOTE: Specifications in this document may not match those of official certification in some markets due to timing of this documents publication and printing, variance in testing methods, and/or vehicle differences. Customers seeking officially recognized regulatory specifications for their vehicle should refer to certification documents and/or contact their respective dealer or distributor.

Drivetrain

| Item | Specification |
|----------------|---------------------|
| Transmission | 6-speed |
| Clutch | Hydraulic actuation |
| Front Sprocket | Compensated |
| Final Drive | Chain |

Table 3.

Cooling System

| Item | Specification |
|---------------------------------------|---|
| Cooling System | Liquid cooling with integrated water pump, thermostat controlled bypass |
| Coolant | Ethylene glycol, 50/50 mixture |
| Normal Operating Temperature | 140 – 220 F 60 – 104 C |
| Over Temperature threshold (lamp lit) | 230 F 110 C |

Table 4.

Liquid Capacities

| Item | US. | Liters |
|-------------------------------------|----------------|--------|
| Fuel Tank Total (including reserve) | 4.5 Gal. (US.) | 17 |
| Reserve (Low) Fuel Lamp Lit | 0.8 Gal. (US.) | 3 |
| Engine Oil with Oil Filter | 3.3 Qt. (US.) | 3.1 |
| Engine Oil without Oil Filter | 3 Qt. (US.) | 2.8 |
| Coolant | 2.64 Qt. (US.) | 2.5 |

Table 5.

Sprocket teeth

| Drive | Item | Number of Teeth |
|---------|----------------|-----------------|
| Primary | Engine | 36 |
| | Clutch | 65 |
| Final | Front Sprocket | 16 |
| | Rear Sprocket | 41 |
| | Chain (Links) | 116 |

Table 6.

Transmission Gear Ratios

| Gear | Ratio |
|--------|-------|
| First | 2.462 |
| Second | 1.750 |
| Third | 1.381 |
| Fourth | 1.174 |
| Fifth | 1.042 |
| Sixth | .960 |

Table 7.

Tires

| Tire | Type | Solo Riding | | Loaded GVWR | |
|-------|----------------------------|-------------|-----|-------------|-----|
| | | PSI | kPa | PSI | kPa |
| Front | Pirelli Diablo Rosso Corsa | 36 | 248 | 36 | 248 |
| Rear | Pirelli Diablo Rosso Corsa | 34 | 234 | 34 | 234 |

Table 8.

Bulb Chart

| Bulbs | Bulbs Required | WATTS | AMPS | Part Number |
|--------------------|---|-------|------|-------------|
| Headlamps | LED Assembly; replace entire assembly upon failure. | | | |
| Tail Stop Lamp | LED Assembly; replace entire assembly upon failure. | | | |
| License Plate Lamp | LED Assembly; replace entire assembly upon failure. | | | |
| Front Turn Lamps | 2 | 10 | 0.74 | Y0042.1B6 |
| Rear Turn Lamps | 2 | 10 | 0.74 | Y0042.1B6 |
| Instrument Cluster | LED Assembly; replace entire assembly upon failure. | | | |

Table 9.

Dimensions

| Item (Without Rider) | In. | MM |
|----------------------------------|-----------------|--------------|
| Overall Length | 80.3 | 2040 |
| Overall Width (without mirrors) | 29RX/ 31.9 SX | 737/810 |
| Overall Height (without mirrors) | 43.7 RX/42.8 SX | 1110/1087 |
| Wheel Base (unladen) | 55.6 | 1412 |
| Seat Height (unladen) | 32.5 | 826 |
| Trail at Ride Height | 3.8 | 96 |
| Rake at Ride Height | 22.4 degrees | 22.4 degrees |

Table 10.

Weights

| Item (Without Rider) | Lb. | Kg. |
|-----------------------|---------------|---------|
| Weight (Full of Fuel) | 448 RX/443 SX | 203/201 |
| Load Capacity | 377 RX/382 SX | 171/173 |
| GVWR | 825 | 374 |
| GAWR Front | 363 | 165 |
| GAWR Rear | 495 | 225 |

Table 11.

TIRE

WARNING

Match tires, air valves and caps to the correct wheel/rim. Contact an EBR dealer. Mismatching can result in damage to the tire bead, allow tire slippage on the rim or cause tire failure, which could result in death or serious injury.

WARNING

Use only EBR approved tires. See an EBR dealer. Using non-approved tires can adversely affect stability, which could result in death or serious injury.

- Tubeless tires are used on all EBR cast wheels. Tire sizes are molded on the tire sidewall.

- Use only recommended tires (the same as original equipment). Other tires may not fit correctly, could adversely affect handling, and may be hazardous to use.

NOTE: Refer to Table 8. Always check tire pressure before riding. Tire pressures are listed with tires cold.

GASOLINE BLENDS

Your EBR motorcycle was designed to get the optimal performance and efficiency using unleaded gasoline. Most gasoline sold is blended with alcohol and/ or ether, to create "oxygenated" blends. The type and amount of alcohol or ether added to the fuel is important to consider.

CAUTION

Do not use gasoline that contains methanol. Doing so can result in fuel system component failure, engine damage and/or equipment malfunction.

- Gasoline containing METHYL TERTIARY BUTYL ETHER (MTBE): Gasoline/MTBE blends are a mixture of gasoline and as much as 15% MTBE. Gasoline/MTBE blends can be used in your motorcycle.
- ETHANOL is a mixture of 10% ethanol (Grain Alcohol) and 90% unleaded gasoline. Gasoline/ethanol blends can be used in your motorcycle if the ethanol does not exceed 10
- REFORMULATED OR (RFG): "Reformulated gasoline" is a term used to describe gasoline blends that are specifically designed to burn cleaner than other types of gasoline, leaving fewer "tailpipe" emissions. They are also formulated to evaporate less when you are filling your tank. Reformulated gasoline uses additives to "oxygenate" the gas. Your motorcycle will run normally using this type of gas and EBR recommends you use it when possible, as an environmentally friendly alternative to regular unleaded gasoline.
- Do not use race gas or octane boosters. Use of these fuels will damage the fuel system.

You may find that some gasoline blends adversely affect the starting, drivability or fuel efficiency of your bike. If you experience one or more of these problems, we recommend you try a different brand of gasoline or higher octane rating.

FUEL

Refer to Table 12. Always use a good quality unleaded gasoline. Octane ratings are usually found on the pump.

WARNING

Avoid spills. Slowly remove filler cap. Do not fill above bottom of filler neck insert, leaving air space for fuel expansion. Secure filler cap after refueling. Gasoline is extremely flammable and highly explosive, which could result in death or serious injury.

WARNING

Use care when refueling. Pressurized air in fuel tank can force gasoline to escape through filler tube. Gasoline is extremely flammable and highly explosive, and a serious refueling accident could result in death or serious injury.

Modern service station pumps dispense a high flow of gasoline into a motorcycle fuel tank making air entrapment and pressurization a possibility.

Octane Ratings

| Specification (R+M)/2 | Rating |
|-----------------------|------------|
| Pump Octane | 91(95 RON) |

Table 12.

CATALYTIC CONVERTERS

This motorcycle is equipped with dual catalytic converters.

CAUTION

Do not operate catalytic converter-equipped vehicle with engine misfire. If you operate the vehicle under this condition, the exhaust will become abnormally hot, which can cause vehicle damage, including emission control loss.

CAUTION

Use only unleaded fuel in catalytic converter equipped motorcycles. Using leaded fuel will damage the emission control system.

OPERATION

GENERAL

CONTROLS AND INDICATORS

WARNING

Read the **CONTROLS AND INDICATORS** section before riding your motorcycle. Failure to understand the operation of the motorcycle could result in death or serious injury.

Some features explained in this section are standard equipment on this model. Other features may be available as accessories for your EBR motorcycle. See an EBR dealer for a complete list of accessories that will fit your specific motorcycle.

IGNITION/HEADLAMP KEY SWITCH

RX Ignition is located on the upper triple clamp, SX is on the left side behind the headlight, in front of the left fork tube.

WARNING

The automatic-on headlamp feature provides increased visibility of the rider to other motorists. Be sure headlamp is on at all times. Poor visibility of rider to other motorists can result in death or serious injury.

The ignition/headlamp key switch controls the distribution of power to the ignition and lamps.

The key can be removed when the key switch is in the OFF, LOCK or PARKING LAMP position. The key cannot be removed while in the ON position.

The headlamps illuminate when the ignition/headlamp key switch is ON. The tail lamp and running lamps are lit when the ignition/headlamp key switch is in the ON or PARKING LAMP position.

NOTES

- If you leave the key in the ON or PARKING LAMP position for an extended length of time while parked, the lamps will eventually discharge the battery.

Record your key number in the space provided at the front of this Owner's Manual. The key number is pressed on a plastic tab that comes with the keys.

Turning Motorcycle On/Off

1. See Figure 5. Turn the key clockwise to the ON position.

2. The TFT screen will illuminate and display the time, odometer, speedometer, traction control level, low oil warning, current message and the Check Engine light.

The cold engine light will flash for a moment if the engine is cold and then the Low Oil message will display.

NOTES

The check engine lamp may remain lit for up to four seconds longer than other lamps. If the check engine lamp remains on longer, refer to **CONTROLS AND INDICATORS: WARNING Lamps** for more information.

- See Figure 5. Turn the key counterclockwise to the OFF position to shut the motorcycle off.

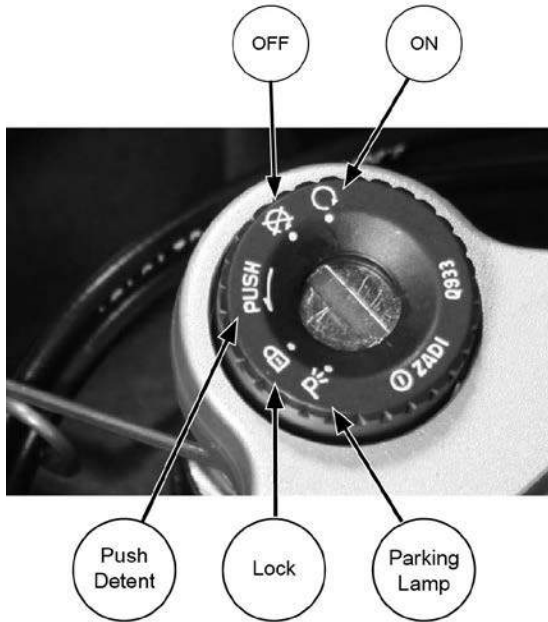

Figure 5. Ignition Switch

Parking the Motorcycle

Lamps can be turned on to increase the motorcycle's visibility to other motorists while parked.

See Figure 5. When the ignition switch is in the PARKING LAMP position, the running lamps, tail lamps, and instrument cluster are illuminated. The front and rear turn signals can also be activated.

1. Turn handlebars full left.
2. Turn the key counterclockwise to the PARKING LAMP position to turn on the parking lamps. Key may be removed.

Locking Steering Head

To lock the steering head.

1. Turn the handlebars full left
2. Turn the key counterclockwise to the LOCK position. Key may be removed.

Electric Starter Switch

See Figure 7. The electric starter switch is located on the right hand controls. Pushing in the electric starter switch engages the electric starter and starts the engine if ignition power is

ON. See OPERATION, Starting the Engine: EBR 1190 RX/SX for operation procedures.

Engine OFF/RUN Switch

See Figure 7. The engine OFF/RUN switch turns the ignition power on or off. The engine OFF/RUN switch is located on the right hand controls. Push the top portion of the engine OFF/RUN switch to turn off ignition power and shut the engine off. Push the bottom portion of the engine OFF/RUN switch to turn on ignition power.

NOTES

-The Engine OFF/RUN switch must be in the RUN position to start or operate the engine.

-The Engine OFF/RUN switch should be used to shut the engine off.

1. To shut the engine off, push the top of the OFF/ RUN switch to the ignition OFF position.

2. See Figure 5. Turn the ignition/headlamp key switch counterclockwise to the OFF position to turn the ignition power completely off.

Throttle Control Grip

1. See Figure 7. The throttle control grip is located on the right handlebar and is operated with the right hand. Turn throttle control grip clockwise (toward the front of the vehicle) to close the throttle and decelerate.

2. Turn the throttle control grip counterclockwise (toward the rear of the vehicle) to open the throttle and accelerate.

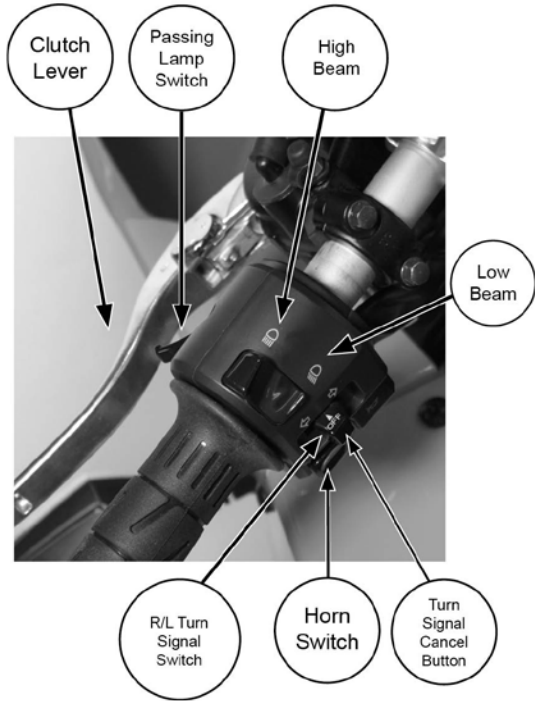

Figure 6. Left Handlebar Switch.

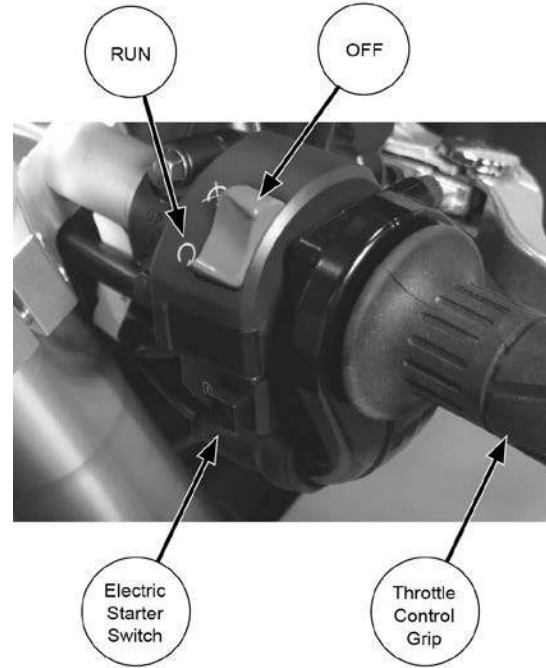

Figure 7. Right Handlebar switch.

Clutch Hand Lever

WARNING

Do not position fingers between the hand control lever and the handlebar grip. Improper hand positioning can impair control lever operation and cause loss of vehicle control, which could result in death or serious injury.

See Figure 6. the clutch hand lever is located on the left handlebar and is operated with the fingers of the left hand.

1. Slowly pull clutch hand lever in against the handlebar grip to fully disengage the clutch.
2. Shift to first gear using the gear shift lever. See OPERATION, Gear Shift Lever. Slowly release the clutch hand lever to engage clutch.

Horn Switch

See Figure 6. The horn is operated by pushing on the horn switch located on the left hand controls.

Headlamp High/Low Beam Switch

The headlamp high/low beam switch is located on the left hand controls. The switch has two positions to activate the headlamps high or low beams.

See Figure 6. Press the top of the headlamp high/low beam switch to activate the high beam.

- Press the bottom of the headlamp high/low beam switch to return to low beam.

See Figure 6. The (blue) high beam indicator lamp will illuminate when the high beam is on.

Passing Lamp Switch

See Figure 6. The passing lamp switch is located on the front of the left hand controls. Pressing the switch when the headlamp dimmer switch is set to low beam will momentarily flash the high beam headlamp.

Turn Signal Switch

See Figure 6. The left/right turn signal switch is located on the left hand controls and activates the front and rear turn signal flashers.

- Push the turn signal switch to the right to activate the right front and rear turn signal flashers.

- Push the turn signal switch to the left to activate the left front and rear turn signal flashers.

-Press the turn signal switch button manually to cancel the turn signal.

NOTE

If signaling to turn in one direction and the switch is depressed towards the opposite direction, the first signal is cancelled and the opposite side begins flashing.

See Figure 9. The green left or right turn signal indicator will flash when the turn signals are in use.

INSTRUMENT CLUSTER

The TFT instrument cluster displays an analog tachometer, a digital speedometer, traction control level, neutral indicator, multi trip odometer, warning lights and messages, diagnostic information, and a clock. See figure 8 and figure 9.

The TFT screen will illuminate when the ignition key switch is in the ON or PARKED position.

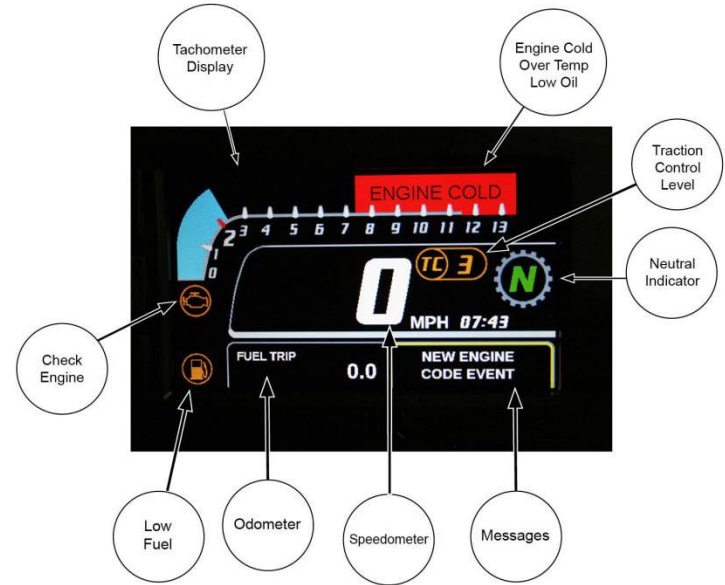

Figure 8. Instrument Cluster Display.

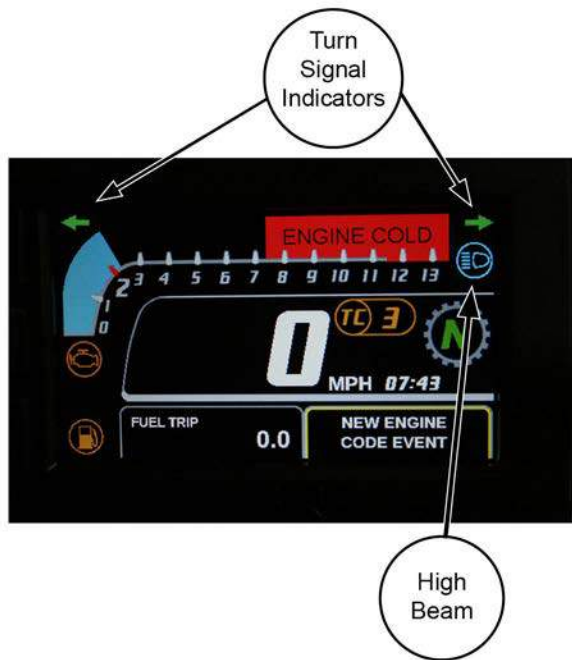

Figure 9. Turn signal and high beam indicators.

Tachometer

CAUTION

See OPERATING RECOMMENDATIONS section. Do not operate the engine above maximum safe RPM as shown under OPERATING RECOMMENDATIONS. Lower the RPM by up shifting to a higher gear or reducing the amount of throttle. Failure to lower RPM may cause equipment damage.

See figure 8. The tachometer displays engine speed in revolutions per minute (RPM x 1000). As the tachometer approaches the redline, the blue tachometer ribbon will change colors; orange at 10,500 RPM and red at 11,500.

NOTE

Your RX/SX 1190 features a soft rev limiter that reduces the chance of over-revving the engine. It will not prevent over-revving on downshifts. Use care to not downshift into a gear that will cause the engine to exceed the redline. See SHIFTING GEARS

Speedometer

See figure 8. The speedometer displays your speed digitally and can be configured to display MPH or KPH (see SELECTING FUNCTIONS).

Odometer

See figure 8. The odometer displays total mileage, mileage for trips A and B as well mileage since the last time ignition key was turned on (Key Trip). Key trip from previous trip is held for reference until the vehicle starts to move at which point it is cleared for tracking the current key on event. There is also a reserve fuel odometer (Fuel Trip) that will appear automatically when the fuel level drops to .7 gal (2.6 liters). This will reset a few minutes after fuel is added to bring the fuel level above the reserve amount. It also displays mileage to the next recommended service.

You toggle between the various trips by pushing the center button on the left edge of the cluster housing. See figure 10.

Warning Lights and Messages

Low Fuel

See figure 8. The Low Fuel light will turn on when the fuel level drops to .7 gal (2.6 liters). This will also trigger the FUEL TRIP odometer to appear and begin counting the mileage from the beginning of the Low Fuel event.

Check Engine

See figure 8. The amber check engine lamp indicates whether the engine management system is operating normally. When an engine malfunction is detected, a check engine message is

displayed on the Instrument Cluster Information Line. The check engine lamp illuminates briefly when the motorcycle's ignition is first turned on. At this time, the engine management system runs a series of self-diagnostics.

If the lamp remains continuously lit after the initial diagnostics, begins flashing, or turns on at a later time, see a EBR dealer. This indicates an event has occurred related to the proper operation of the engine management system.

Engine Cold/Over Temp

See figure 8. The Engine Cold message will appear above the tachometer when the engine is below operating temperature. The ECM will reduce the engines rev limit until the engine reaches proper temperature.

The Over Temp message will appear above the tachometer when engine temperature exceeds the normal operating range. Engine performance will be reduced until the temperature drops to within the normal range. Reduce speed and drive gently until temperature is reduced.

CAUTION

If Over Temp lights remains on stop the engine and check coolant level. If coolant level is correct see Trouble shooting.

WARNING

Do not remove the radiator filler cap when the engine is hot. The cooling system is under pressure and hot coolant and steam can escape, which could cause severe burns. Allow engine to cool before servicing.

Low Oil Pressure

See figure 8 (not shown). A LOW OIL message will appear in the same location as the Engine Temp Message. This indicates that the engine oil pressure is below normal. It is normal for this message to appear when the ignition is turned on and may remain lit for up to 4 seconds after the engine is started.

WARNING

If the LOW OIL message remains on for more than 4 seconds at start up or if it appears while running immediately stop the engine and see an EBR dealer.

TC

See figure 8. This displays the level of traction control selected.

Neutral Indicator

See figure 9. The Neutral Indicator is part of the Gear Indication display and will light with a large green N when the motorcycle is in neutral. When the motorcycle is in motion the display will indicate what gear is engaged.

High Beam

See figure 9. The blue high beam light indicates that your high beam is on.

Turn Signal Indicator

See figure 9. The turn signal indicators will flash to indicate that the right or left turn signal is operating. If the indicator flashes faster than normal you have a burned out bulb and will need to replace it.

Messages

See figure 8. The message area will display diagnostic messages as well as the MPG/KPG numbers for all current trips as well as the overall number.

SELECTING FUNCTIONS



Figure 10.

The various functions available in the instrument cluster are selected using the three buttons on the left hand side of the cluster housing.

- The center button toggles the lower left user preference area and can display the odometer readings for the 4 trips as well as the total mileage.

- The lower button toggles the lower right user preference area and can display fuel consumption figures for the various trips as well as displaying any CONDITION messages such as SERVICE DUE, COOLANT TEMP EVENT, etc..
- The upper button opens the MENU screen.

NOTE

The Menu cannot be accessed at speeds above 3 MPH (5 KPH).

Menu Screen

Clock

See Figure 10. The clock screen allows you to set the current time using the buttons on the left of the case.

- Click the center button (SEL) to display the clock settings.
- Toggle to the setting you wish to change with the top or bottom buttons on the left.

- Use the center (SEL) button to change a setting.

NOTE

The up and down triangles and the SEL images refer to the buttons on the left edge of the case.

The top and bottom buttons (up and down triangles) allow you to move from one area to another. The center button (SEL) allows you to change the values.

Select EXIT to return to the MENU screen.

Units

See Figure 10. The Units screen allows you to select Units of Measure appropriate for your area.

- Click the center button (SEL) to display the unit settings.
 - MPH/Fahrenheit/U.S. Gallons
 - Km/H /Centigrade/Liters
 - MPH/Centigrade/Imperial Gallons

Toggle up or down to the Units of Measure appropriate for your area.

Select desired UOMs.

Select EXIT to return to MENU

Track Data

See Figure 10. Track data allows you to record lap times. There are 10 sessions of 20 laps each that can be stored. Three sessions can be locked. Locked sessions will not be over written by new sessions.

To record lap times use the center button (SEL) to select Track Data:

1. Use the top and bottom buttons to navigate up or down to the LAP TIMER.
2. Use the center button (SEL) to turn the Lap Timer on (white background/dark letters).
3. Select Exit to return to the Menu.
4. Exit back to the Main screen.
5. To start the timer depress the headlight flasher button once
6. To stop one lap and immediately start another lap briefly depress the headlight flasher.

7. To stop recording and end the session press and hold the headlight flasher button for five seconds. This will stop the session and delete the lap that is being timed. All previous laps will be saved.

8. You can start a new session by simply pressing the headlight flasher button to start the lap timer again.

Use the button to move around the screen to view different sessions or laps.

Use EXIT to move up one level in the menu. You may need to select EXIT several times to return to the main screen.

Service

See Figure 10. The service screens shows the distance to next service and allows you to reset the counter after the service is performed. The first service is due at 620 miles (1000 KM). Second service is a 6,200 miles (10,000 KM). Each subsequent service will be 6200 miles (10,000 KM) after the previous service.

Select EXIT to return to MENU

Brightness

See Figure 10. Brightness allows you to increase or decrease screen brightness as needed. Brightness can be configured to

change automatically based on ambient light. Use the center (SEL) button to select brightness.

- To turn on auto brightness adjustment set AUTO ADJUST to ON (white background/dark letters).
- The brightness level for both Day and Night can be adjusted. Select DAY or Night using the up and down buttons. Adjust the brightness using center button.
- You can set the brightness manually by turning the Auto setting off. Only the DAY setting will be available for adjustment.

NOTE

Brightness will change automatically 10 seconds after the ambient light levels change. Light changes lasting less than 10 seconds (like passing through a small tunnel) will not trigger the brightness change.

Select EXIT to return to MENU

Traction

See Figure 10. Traction allows you to set what level of Traction Control you desire.

To set the Traction Control level:

1. Bring motorcycle to a complete stop and put transmission into neutral.
2. Select Traction from the Menu.
3. Read the warning message and select AGREE to move to the adjustment screen. See figure 15.
4. Use the up and down buttons to move the desired Traction Control level up or down. 20 represents the highest level of control and 1 the least. See Table 13. You can also select OFF for no Traction Control at all. See figure 16 See OPERATING RECOMMENDATIONS/Traction Control for a detail explanation of traction control.
5. Select EXIT to return to the previous screen.



Figure 15.



Figure 16.

NOTE

The traction control level selected will display on the main screen.

Diagnostics

See Figure 10. The diagnostic screen provides information to assist in diagnosing faults and to perform service. See your EBR dealer.

Exit

See Figure 10. Selecting EXIT will return you to the previous screen. It may be necessary to select EXIT multiple times to return to the main screen.

GEAR SHIFT LEVER

CAUTION

The clutch must be fully disengaged before attempting a gear shift. Failure to fully disengage the clutch can result in equipment damage.

The gear shift lever is located on the left side of the motorcycle and is operated with the left foot. The transmission is a six speed sequential gear box. See figure 1.

To select a gear;

- Pull the clutch hand lever in against handlebar grip to fully disengage the clutch. See Figure 6.
- Push the gear shift lever all the way down (full stroke) to shift the transmission to the next lower gear.
- Lift the shift lever all the way up (full stroke) to shift the transmission to the next higher gear. See figure 11.
- Push the lever down to shift the transmission to the next lower gear. See figure 12.

NOTES

- Release the gear shift lever after each gear change.
- The lever must return to its central position before another gear change can be made.

First gear is the last gear position that can be found by pushing the gear shift lever full stroke downward.

Neutral is located between first and second gear. The green neutral indicator lamp on the dash will illuminate when the transmission is in neutral.

To shift from first gear to neutral, lift the gear shift lever one half of its full stroke.

When the motorcycle is standing still and the engine is not running, shifting gears requires a different technique. Before shifting in this condition, move the motorcycle backward and forward with the clutch fully disengaged (clutch lever pulled in). While maintaining slight pressure on the shift lever; shift from one gear to another.

Even with the engine running and the motorcycle standing still, difficulty may be experienced in shifting gears. This difficulty occurs because transmission gears are not turning and shifting parts are not lined up to permit engagement.

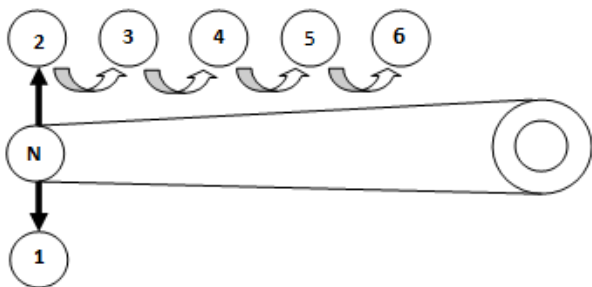

Figure 11. Upshift Pattern

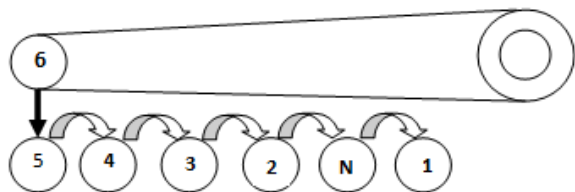

Figure 12. Downshift Pattern

CAUTION

When difficulty of shifting gears is experienced, do not under any circumstances, attempt to force the shift. The results of such abuse will be a damaged or broken shifter mechanism.

See OPERATING RECOMMENDATIONS, Shifting Gears, for more information.



Figure 13. Toe Peg Adjustment.

ADJUSTING SHIFTER TOE PEG

The gear shift toe peg can be adjusted for rider preference.

1. See Figure 13. Loosen the fastener from the toe peg.
2. Slide toe peg to the desired position.
3. Tighten the fastener to 48-72 in-lbs (5.4-8.1 Nm).

ADJUSTING HANDLE BAR LEVERS

The clutch and brake hand lever may be adjusted to the rider's preference.

See Figure 14. Turn knob to desired position.

NOTE

It is easier to adjust the dial if you gently push the lever outward to reduce pressure on the adjuster.

After adjusting hand lever position, rotate steering to full left and full right positions to make certain the levers do not contact the fairing.



Figure 14. Lever Adjustment Knob.

BRAKES

⚠ WARNING

Do not apply brake strongly enough to lock the wheel. A locked wheel will skid and can cause loss of vehicle control, which could result in death or serious injury.

The rear brake pedal controls the rear wheel brake and is located on the motorcycle's right side. Operate the rear brake pedal with the right foot.

The front brake hand lever controls the front wheel brake and is located on the right handlebar. Operate the hand lever with the fingers of the right hand.

⚠ WARNING

Do not position fingers between hand control lever and handlebar grip. Improper hand positioning can impair control lever operation and cause loss of vehicle control, which could result in death or serious injury.

Brakes should be applied uniformly and evenly to prevent wheels from locking up. A balance between rear and front braking is generally best.

ADJUSTING REAR BRAKE TOE PEG

The rear brake toe peg can be adjusted for rider preference.

1. See Figure 13. Loosen the fastener from the toe peg.
2. Slide toe peg to the desired position.
3. Tighten the fastener to 48-72 in-lbs (5.4-8.1 Nm).

NOTE

To adjust the rear brake master cylinder pushrod, see an EBR Dealer

ADJUSTING FRONT BRAKE LEVER

The front brake hand lever may be adjusted to the rider's preference.

See Figure 14. Turn knob to desired position.

NOTE

It is easier to adjust the dial if you gently push the lever outward to reduce pressure on the adjuster.

After adjusting hand lever position, rotate steering to full left and full right positions to make certain the levers do not contact the fairing.

WARNING

Do not position fingers between hand control lever and handlebar grip. Improper hand positioning can impair control lever operation and cause loss of vehicle control, which could result in death or serious injury.

FUEL FILLER CAP

WARNING

Avoid spills. Slowly remove filler cap. Do not fill above bottom of fill plate, leaving air space for fuel expansion. Secure filler cap after refueling. Gasoline is extremely flammable and highly explosive, which could result in death or serious injury.

WARNING

Use care when refueling. Pressurized air in fuel tank can force gasoline to escape through filler tube. Gasoline is extremely

flammable and highly explosive, which could result in death or serious injury.

CAUTION

Do not spill fuel onto the motorcycle while refueling. Immediately wipe up fuel spills on your motorcycle. Fuel can cause damage to cosmetic surfaces.

REMOVAL

1. See Figure 17. To remove fuel filler cap, lift tab up and inset ignition key into lock.
2. Turn ignition key $\frac{1}{4}$ counterclockwise.
3. Lift cap off.

INSTALLATION

1. Replace cap with tab up.
2. Turn ignition key $\frac{1}{4}$ turn clockwise. clockwise
3. Remove key and lower tab.

NOTE

Key cannot be removed while cap is unlocked.

FUEL FILL LEVEL

Do not fill tank above the baffle. See figure 29.

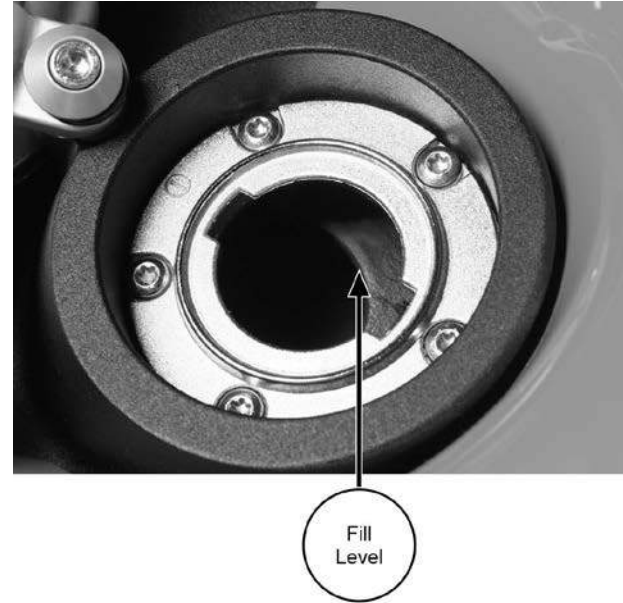

Figure 29. Maximum Fuel Fill Level.

STEERING HEAD LOCK

CAUTION

Protect your vehicle against theft. After parking your motorcycle, lock the steering head and remove ignition key from switch. Failure to lock your motorcycle may result in theft and/or equipment damage.

The steering head lock is located on the ignition/headlamp key switch and is operated by the ignition key.

1. Verify sidestand is down. Turn handlebars full left.
2. See Figure 5. Verify that key is in the OFF position.
3. Push in on the ignition key and turn it counterclockwise to the steering head LOCK position. Move handle-bars slightly until locked.
4. Attempt to turn the handlebars to the right to verify that the steering head is locked. Handlebars should not turn.
5. Remove key from the ignition/headlamp key switch.

SIDESTAND

WARNING

This motorcycle does NOT have a locking sidestand. Park the motorcycle on a level, firm surface. An unbalanced motorcycle can fall, which could result in death or serious injury.

The sidestand is located on the left side of the motorcycle and swings down to support the motorcycle for parking.

WARNING

Be sure sidestand is fully retracted before riding. If sidestand is not fully retracted, it can contact the road surface causing a loss of vehicle control, which could result in death or serious injury.

REAR VIEW MIRRORS

WARNING

Objects in mirrors are closer than they appear. Use caution when judging distance of objects in mirrors. Failure to judge correct distances could result in death or serious injury.

Your vehicle is equipped with two convex rear view mirrors. This type of mirror is designed to give a much wider view to the rear than a flat mirror. However, cars and other objects

seen in this type of mirror will look smaller and farther away than they actually are.

Use caution when judging the size or relative distance of objects seen in rear view mirrors.

Always adjust the rear view mirrors to clearly reflect the area behind the motorcycle before riding. To adjust mirrors, rotate mirror housing up and down, in and out to the desired position. The mirror stalk has only one operating position

NOTE

Adjust mirrors so you can see a small portion of your shoulders in each mirror, this will help you establish the relative distance of vehicles to the rear of your motorcycle.

RIDER SEAT

Rider Seat Removal

See Figure 18.

1. Remove hex head bolt from the bottom of the seat base.

2. Lift rear of seat up and slide seat toward rear of bike.

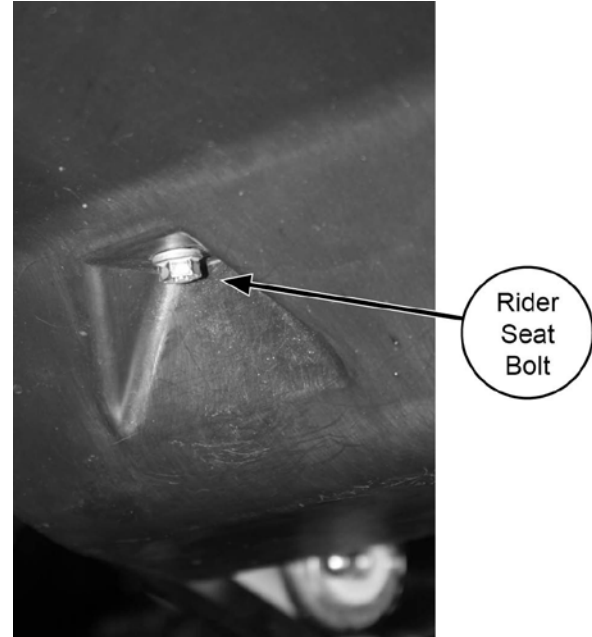

Figure 18. Rider Seat Retention bolt.

To reinstall rider seat insure that the tabs on the seat bottom engage the tabs on the subframe. See figure 19.

Push down on seat and slide forward.

Reinstall bolt through bottom of seat pan.



Tabs

Figure 19: Reinstall seat.

Passenger Seat Removal/Fuse Access

The fuses and relays are under the passenger seat.

- To remove this, insert key into the rider seat back panel and unlock the passenger seat. See figure 20.

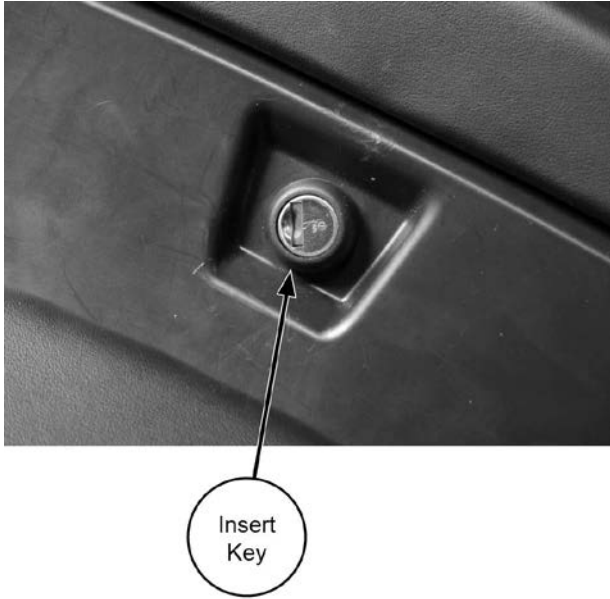

Figure 20.

- Lift the front of the seat upward and pull toward the front of the bike. The seat strap is attached to the motorcycle not the seat and cannot be removed with the seat. Lift the strap up to ease removal and replacement.

- Replace seat by sliding under the strap and when it is fully in place push down on the front to engage the seat lock. See figure 21.



Figure 21. Passenger Seat Removal.

OPERATING RECOMMENDATIONS

General

WARNING

Motorcycles are different from other vehicles. They operate, steer, handle and brake differently. Unskilled or improper use could result in loss of control, death or serious injury.

- Take a rider training course
- Read Owner's Manual before riding, adding accessories or servicing.
- Wear a helmet, eye protection and protective clothing.
- Never tow a trailer.

CAUTION

Do not run the engine at extremely high RPM with clutch disengaged or transmission in neutral. Running an engine at high RPM can result in engine damage.

CAUTION

Do not exceed the maximum safe RPM specified below under any conditions. Exceeding the maximum safe engine RPM can result in equipment damage.

The maximum recommended safe engine speed is 11500 RPM.

Have the engine checked regularly and keep it well tuned.

Operating on a dynamometer

CAUTION

Operating you motorcycle on a dynamometer causes a large amount of heat to be generated without sufficient airflow to remove it.

EBR recommends the removal of the belly pan before running the bike on a dynamometer.

Traction control should be OFF for dynamometer use or excess exhaust heat may be generated due to power limiting strategies.

CAUTION

Do not coast for long distances with the engine off or idling. The transmission is properly lubricated only when the engine is running. Coasting long distances can result in transmission damage.

⚠ WARNING

Do not tow a disabled motorcycle. Towing can adversely affect stability and handling, which could result in death or serious injury.

⚠ CAUTION

Cooling fans operate automatically, even when the ignition switch is off. Keep hands away from fan blades. Contact with a rotating fan blade can result in minor or moderate injury.

⚠ WARNING

When riding on wet roads, brake efficiency and traction are greatly reduced. Failure to use care when braking,

accelerating or turning on wet roads can cause loss of control, which could result in death or serious injury.

⚠ WARNING

Continuous use of brake causes overheating and reduced efficiency, which could result in death or serious injury.

BREAK-IN RULES

The First 620 Miles (1000 Km)

The sound design, quality materials, and workmanship of your new motorcycle will give you optimum performance right from the start.

To allow your engine to wear in its critical parts, we recommend that you observe the riding rules provided below for the first 620 mi (1000 km). Adhering to these suggestions will help future durability and performance.

1. During the first 310 mi (500 km) of riding, keep the engine speed below 6000 rpm in any gear. Do not lug the engine by running or accelerating at very low rpm, or by running at high RPM longer than needed for shifting or passing.

2. Up to 620 mi (1000 km), vary the engine speed and avoid operating at any steady engine speed for long periods. Engine speed up to 7500 rpm in any gear is permissible.
3. Drive slowly and avoid fast starts at wide throttle until the engine has warmed up.
4. Avoid lugging the engine by not running the engine at very low speeds in higher gears.
5. New brakes need to be bedded-in. Avoid stops from very high speeds for the first 200 miles (300 kilometers). Proper seating of the pads can be accomplished by using light brake pressure for the first few stops, letting the system cool, then doing several stops using moderate to firm brake pressure.

PRE-RIDING CHECK LIST

WARNING

Read the CONTROLS AND INDICATORS section before riding your motorcycle. Failure to understand the operation of the motorcycle could result in death or serious injury.

Before riding your motorcycle at any time, make a general inspection to be sure it is in safe riding condition.

WARNING

Stop the engine when refueling or servicing the fuel system. Do not smoke or allow open flame or sparks near gasoline. Gasoline is extremely flammable and highly explosive, which could result in death or serious injury.

WARNING

Avoid spills. Slowly remove filler cap. Do not fill above bottom of fill plate, leaving air space for fuel expansion. Secure filler cap after refueling. Gasoline is extremely flammable and highly explosive, which could result in death or serious injury.

WARNING

Use care when refueling. Pressurized air in fuel tank can force gasoline to escape through filler tube. Gasoline is extremely flammable and highly explosive, which could result in death or serious injury.

CAUTION

Do not spill fuel on the motorcycle while refueling. Immediately wipe up fuel spills on your motorcycle. Fuel can cause damage to cosmetic surfaces.

1. Verify fuel is present in tank and add fuel if required.
2. Adjust mirrors to proper riding conditions
3. Check coolant level. See MAINTENANCE AND LUBRICATION, Coolant Level.
4. Verify oil is present in engine. Check oil level only after warming up motorcycle. See MAINTENANCE AND LUBRICATION, Oil Level
5. Check controls to make sure they operate properly. Operate the front and rear brakes, throttle, clutch and shifter. All controls should operate freely without binding.
6. Check steering for proper operation by turning the handlebars through the full operating range. Handle-bars should turn smoothly without binding.

WARNING

Be sure tires are properly inflated, balanced and have adequate tread. Inspect your tires regularly and see an EBR dealer for replacements. Riding with excessively worn, unbalanced or under-inflated tires can adversely affect stability and handling, which could result in death or serious injury.

7. Check tire condition and pressure. Incorrect pressure will result in poor riding characteristics and affect handling and stability. See table 8 for correct tire pressures. See MAINTENANCE AND LUBRICATION/TIRES/TIRE REPLACEMENT.
8. Check all electrical equipment and switches including the headlamp, stop lamp, turn signals and horn, for proper operation.

NOTE

Check horn operation with engine running.

WARNING

Be sure headlamp, tail lamp, stop lamp and turn signals are operating properly before riding. Poor visibility of rider to other motorists can result in death or serious injury.

9. Check for any fuel, oil, coolant or hydraulic fluid leaks.
10. Check chain for wear and damage. Service as necessary.

SIDESTAND INTERLOCK

Some models are equipped with a sidestand interlock feature. If the sidestand is down, the transmission is in gear, and the clutch is released, the engine will stall. The message SIDESTAND will be displayed in the instrument cluster to indicate the condition.

The vehicle will start and run with the sidestand down while the transmission is in neutral and the clutch is released.

STARTING THE ENGINE

WARNING

Shift transmission to neutral before starting engine to prevent accidental movement, which could result in death or serious injury.

CAUTION

The engine should be allowed to run slowly for 30-60 seconds. This will allow the engine to warm up and let oil reach all surfaces needing lubrication. Failure to comply can result in engine damage.

NOTE

EBR motorcycles feature a starter interlock. Before starting the engine, all the following conditions must be met.

- Engine OFF/RUN switch on handlebar control group must be in the ON position.
- Clutch lever must be pulled in before starting motorcycle in gear. It is not necessary to pull in clutch lever if motorcycle is being started in neutral.

NOTE

The electronic fuel injection system compensates for atmospheric and engine conditions for starting. NO "choke" or enrichener is needed. Do not twist the throttle prior to engaging the starter.

See figure 22.

1. Turn engine OFF/RUN switch to RUN.
2. Be sure the throttle is closed.
3. Raise the sidestand.
4. Turn ignition/headlamp key switch to ON.
5. Verify transmission is in NEUTRAL position by observing lit green neutral indicator lamp on dash panel, and verify neutral position by rolling motorcycle forward and backward.
6. Press electric starter switch to operate starter.
7. Release electric starter switch when engine starts.

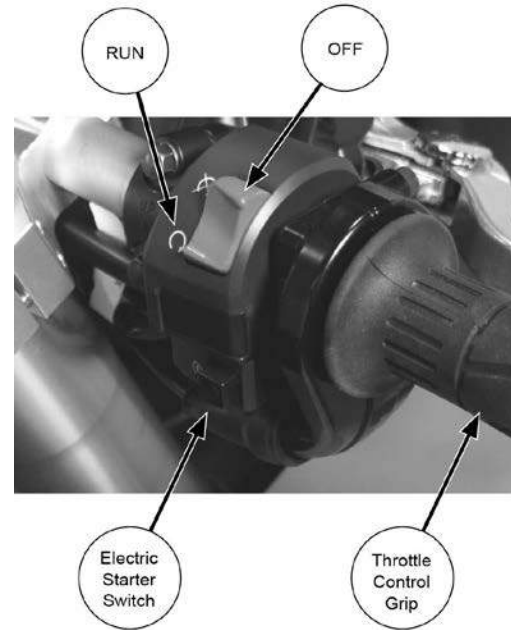

Figure 22.

NOTE

The motorcycle will have a reduced RPM range until the engine is warmed up. If you read this section and still have questions about the correct operation of your motorcycle, talk to an authorized EBR dealer for assistance.

STOPPING THE ENGINE

Turn engine OFF/RUN switch to OFF. See figure 22.

SHIFTING GEARS

Getting Started

CAUTION

The clutch must be fully disengaged before attempting a gear shift. Failure to fully disengage the clutch can result in equipment damage.

NOTE

Always start engine with transmission in neutral. Always start motorcycle's forward motion from first gear.

1. With motorcycle engine running and sidestand retracted, pull the clutch hand lever in against handlebar grip to fully disengage the clutch.
2. Push the foot shift lever down to the end of its travel and release it. The transmission is now in first gear.
3. To start forward motion, release the clutch lever slowly to engage the clutch and at the same time, gradually open the throttle in one smooth motion.

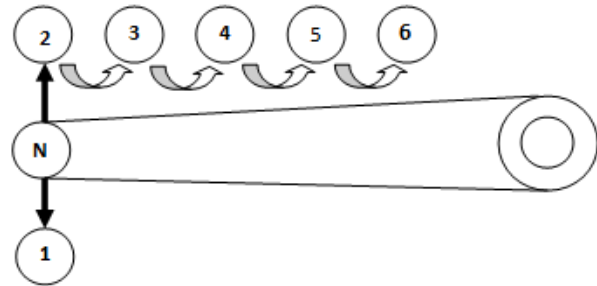

Figure 23

Upshift (Acceleration)

| GEAR CHANGE | MPH | KPH |
|-----------------|-----|-----|
| First to Second | 22 | 35 |
| Second to Third | 32 | 51 |
| Third to Fourth | 42 | 68 |
| Fourth to Fifth | 52 | 84 |
| Fifth to Sixth | 62 | 100 |

Table 14

See figure 23. Gear shift pattern is first gear down, next five gears up. Engage second gear after the motorcycle has reached the appropriate shifting speed. Refer to Table 14 for upshifting speeds.

1. Close the throttle
2. Disengage the clutch (pull clutch lever in)
3. See Figure 24. Lift the gear shift lever up to the end of its travel and release.
4. Engage the clutch (release clutch lever) and gradually open the throttle.
5. Repeat the previous steps to engage third, fourth, fifth, and sixth gears.

NOTES

- Disengage the clutch completely before each gear change.
- Partially close the throttle so the engine will not drag when the clutch is again engaged (clutch lever released).

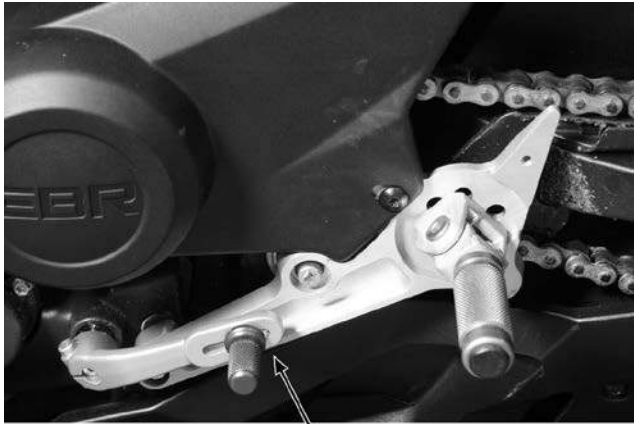

Shift
Lever

Figure 24

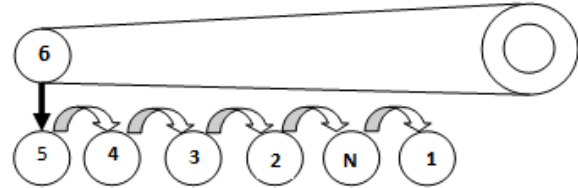

Figure 25

Downshift (Deceleration)

| GEAR CHANGE | MPH | KPH |
|-----------------|-----|-----|
| Sixth to Fifth | 58 | 93 |
| Fifth to Fourth | 48 | 77 |
| Fourth to Third | 38 | 61 |
| Third to Second | 28 | 45 |
| Second to First | 18 | 29 |

Table 15

⚠ WARNING

Do not downshift at speeds higher than those listed in the Downshift (Deceleration) table. Shifting to lower gears when speed is too high can cause the rear wheel to lose traction

and lead to loss of vehicle control, which could result in death or serious injury.

See Figure 25. Gear Shift pattern is first gear down, next five gears up. Refer to table 15 for downshifting speeds.

NOTE

The shifting speeds shown in the tables are a recommendation. Vehicle owners may determine that individual shifting habits differ from those stated and remain appropriate for individual riding styles.

See Table 16. When engine speed decreases, as in climbing a hill or running at reduced speed, shift to the next lower gear by pushing the shift lever down once while partially closing the throttle so the engine accelerates as soon as the clutch lever is released.

NOTES

- Disengage the clutch completely before each gear change.
- Partially close the throttle so the engine will not drag when clutch is again engaged (clutch lever is released.).

CAUTION

Shift to neutral before stopping engine. Shifting mechanism can be damaged by shifting gears while engine is stopped.

The gear shift mechanism permits shifting the transmission to neutral from first gear.

Traction Control

WARNING

Traction Control is a riding tool, but final control of the vehicle is in the rider's hands. Traction Control will not prevent accidents. Always ride within your limits. Failure to do so could result in death or serious injury

The traction control system on the EBR 1190RX/SX is a tool for the rider to enhance safety by helping control wheel slip on the rear wheel when excessive torque is applied for the given dynamic traction available. It also implements a power reduction for high throttle application in low gears in anticipation of conditions which could cause a wheel slip event or a wheelie event.

WARNING

Traction control does not compensate for all possible wheel slip conditions or wheelie events. Always be aware of road and traffic conditions. Always ride within your limits. Failure to do so could result in death or serious injury.

The traction control system on the EBR 1190RX/SX offers 21 levels of adjustability (1 through 20 and OFF). See table 16. Each level changes 4 characteristics of the engine output performance:

- Level of power reduction applied in an estimated wheel slip condition
- The rate of power reduction applied as a function of the estimated wheel slip
- Level of power reduction applied at high throttle in lower gears relative to wheelie conditions
- The throttle position at which power reduction is applied in lower gears relative to wheelie conditions

Level 1 has the lowest intervention and level 20 has the most intervention.

NOTE

Level 20 features a power reduction hold function to quickly drop power in the event of a low traction event and hold the power reduction for a sufficient time to allow the rider to reduce power naturally through the throttle twist grip to a performance output that is more appropriate to the tire traction/grip available. Level 20 is intended for anticipated low traction conditions such as cold, wet, or loose debris like gravel, sand, or leaves. This level is not intended for use on the race track, nor it is intended for off-road use.

The traction control level is always shown to the rider on the instrument cluster screen.

CAUTION

If there is a system fault that affects the traction control functionality traction control will be turned off and will show "OFF" on the instrument cluster regardless of the level previously selected. The system will not allow a level change while the fault exists.

The traction control system uses information from the rear wheel speed sensor, as well as knowledge of the engine's operating conditions and calculated gear position to estimate wheel slip. Depending on the level of traction control selected, the system applies power reduction through manipulating ignition timing, fuel enrichment, and cylinder deactivation. At the highest levels of traction control the maximum power reduction is roughly 40%.

WARNING

If the traction/tire grip available is sufficiently low, power reduction may not be enough to control the wheel slip event; the system is not designed to compensate for excessive throttle for the traction/grip conditions at hand.

NOTE

Depending on the amount of power reduction applied, the rider may hear changes in the engine / exhaust sound.

When traction control is applied, the icon on the instrument cluster screen will flash as an indication to the rider that

traction control is being applied and will continue to flash for 3 seconds after the traction control is no longer being applied.

The levels of traction control selected can be changed through the instrument cluster, and only when the vehicle is completely stopped and in neutral.

To change the traction control level see INSTRUMENT CLUSTER/SELECTING FUNCTIONS/TRACTION section of his manual.

NOTE

Since the traction control system uses the rear wheel speed as the main input, the traction control system will not function below 19 MPH (30 KMH) wheel speed.

NOTE

If the indicated vehicle speed appears erratic, there is a fault with the system and the performance of the traction control system will be negatively affected. Turn Traction Control Off.

Before evaluating and adjusting suspension settings, check the motorcycles tires. Refer to Table 8 and Figure 32. Tires must be in good condition and inflated properly.

WARNING

Do not operate motorcycle with loose, worn or damaged steering or suspension systems. Contact an EBR Dealer for repairs. Loose, worn or damaged steering or suspension components can adversely affect stability and handling, which could result in death or serious injury.

Make all suspension adjustments in small increments. Radical setting changes may cause you to skip the best adjustment, but always remember that any setting chosen is a compromise.

WARNING

Do not pull a trailer with a motorcycle. Pulling a trailer can cause tire overload, reduced braking efficiency and adversely affect stability and handling, which could result in death or serious injury.

SUSPENSION DEFINITIONS

Damping

Resistance to movement. Damping affects how easily the suspension can move and limits oscillations of the system once the movement has begun.

Compression

The suspension is compressed when the wheel moves upwards.

Rebound

The suspension is rebounding when it is moving back from being compressed.

Sag

The amount the suspension moves from maximum length to static loaded condition as weight is added to the vehicle.

Preload

An adjustment made to the suspension springs to limit static sag to achieve a desired percentage of total suspension travel.

SUGGESTED SUSPENSION SETTINGS

| ***Load | | Front Forks | | | Rear Shock | | |
|----------|-----------|--|--|---|---|---|---|
| KG | Lbs | ** Preload: Turns IN from minimum | **Compression: Turns OUT from maximum. | ** Rebound: Turns OUT from maximum. | Preload: Notch (#1 is lightest setting) | ** Compression: Turns OUT from maximum. | ** Rebound: Turns OUT from maximum. |
| under 75 | under 165 | 4 | 6 ½ | 4 1/4 | 1 | 3 | 1 1/4 |
| 75-86 | 165-190 | 5 | 6 | 4 | 2 | 2 1/2 | 3/4 |
| 86-98 | 190-215 | 5 | 6 | 4 | 3 | 2 1/4 | 3/4 |
| 98-111 | 215-245 | 5 | 5 ¾ | 3 3/4 | 4 | 2 1/4 | 3/4 |
| 111-127 | 245-280 | 5 1/4 | 5 ¾ | 3 1/2 | 5 | 2 | 5/8 |
| 127-143 | 280-315 | 5 1/2 | 5 ½ | 3 1/2 | 6 | 2 | 1/2 |
| over 143 | over 315 | 6 | 5 | 3 1/2 | 7 | 1 3/4 | 1/2 |

Table 17.

NOTES

** All Damping adjuster settings are done by tightening (clockwise) until adjuster stops at maximum setting and then counting the turns counterclockwise to get to the desired setting.

*** Load includes: Rider, Passenger, Cargo, Accessories, and riding gear.

Rear Shock Preload Settings

See Figure 26. The factory setting is 2nd position. Use preload tool to turn preload adjuster one notch at a time to desired preload setting. There are a total of 7 ramp positions.

Rear Compression Damping

See Figure 27. Use screwdriver to lightly tighten screw clockwise until it stops. Loosen screw counterclockwise counting the turns as you go to get to desired setting. Factory setting is 2 ½ turns out (counterclockwise) from maximum. There are approximately 4 turns total of range of adjustment.

Rear Rebound Damping

See Figure 45. Use screwdriver to lightly tighten screw clockwise until it stops. Loosen screw counterclockwise

counting the turns as you go to get to desired setting. Factory setting is ¾ turn out (counterclockwise) from maximum. There are approximately 3 turns a total of range of adjustment.

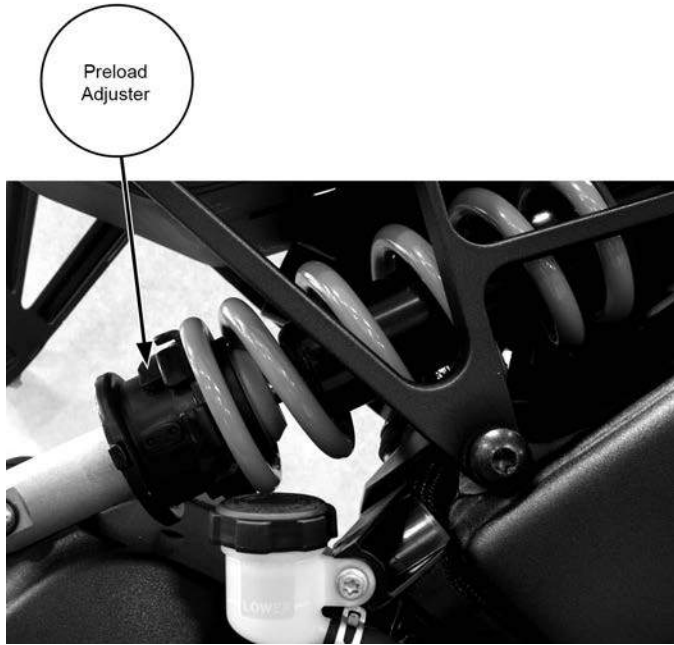

Figure 26. Rear Preload Adjuster.



Figure 27. Rear Compression Adjuster.

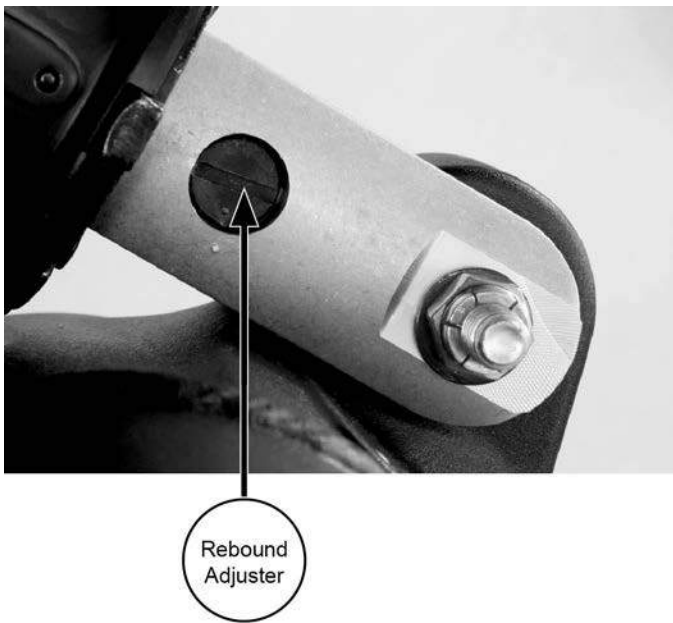

Figure 45. Rear Rebound Adjuster.

Front Fork Preload Settings

See Figure 44. The factory setting is 5 turns in (clockwise) from minimum setting. Use 5mm Allen wrench to turn adjusting screw to desired preload setting. There are approximately 14 turns total range of adjustment each turn is 1mm of spring preload. NOTE: Both forks should be set the same.

Front Compression Damping

See Figure 30. Use screwdriver to lightly tighten screw clockwise until it stops. Loosen screw counterclockwise counting the turns as you go to get to desired setting. Factory setting is 6 turns out (counterclockwise) from maximum. There are approximately 7 turns a total of range of adjustment. NOTE: Both forks should be set the same.

Front Rebound Damping

See Figure 30. Use screwdriver to lightly tighten screw clockwise until it stops. Loosen screw counterclockwise counting the turns as you go to get to desired setting. Factory setting is 4 turn out (counterclockwise) from maximum. There are approximately 5 1/2 turns total of range of adjustment.



Preload

Figure 44. Front Preload Adjuster.

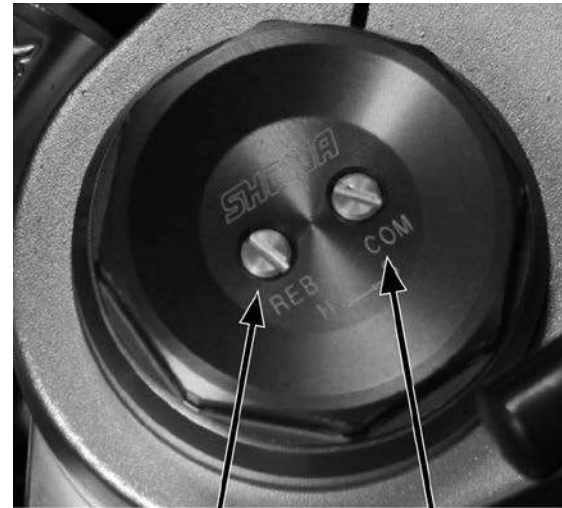

Rebound

Compression

Figure 30. Fork Rebound and Compression Adjusters.

FINE TUNING SUSPENSION

Changes in Load

Changes in the load carried require changes in the preload settings. Carrying less weight requires decreasing the amount of preload. Increasing the load carried requires adding more preload. Refer to Table 17 and adjust preload to match the total weight that will be carried on the motorcycle.

WARNING

Do not exceed the motorcycle's Gross Vehicle Weight Rating (GVWR) or Gross Axle Weight Rating (GAWR). Exceeding these weight ratings can affect stability and handling, which could result in death or serious injury.

- GVWR is the sum of the weight of the motorcycle, accessories, and the maximum weight of the rider, and cargo that can be safely carried.
- GAWR is the maximum amount of weight that can be safely carried on each axle.
- The GVWR and GAWR are shown on the information U. S. plate, located on the frame steering head.

Factory Suspension Settings are a balance of handling, ride, and stability. Suspension can be changed to accommodate rider preferences for ride quality, handling, road conditions and load changes.

NOTES

Do not adjust the following settings beyond those which are listed below.

WARNING

Adjust suspension to the recommendation if possible, but never force adjusters beyond the mechanical stops. Do not operate motorcycle with loose, worn or damaged steering or suspension systems. Contact an EBR dealer for repairs. Loose, worn or damaged steering or suspension components can adversely affect stability and handling, which could result in death or serious injury.

Ride Quality Enhancement

1. The stock settings are designed to offer sufficient chassis control, but some may choose to enhance ride comfort over rougher road conditions or for long rides. Reducing the compression damping will allow the suspension to move more freely reducing road input to the rider. Adjust

suspension for rider weight. See OPERATING RECOMMENDATIONS, Suggested Suspension Settings, Table 17, as the starting point.

2. Increase ride quality by reducing front and rear compression damping by turning adjuster counterclockwise from 1/2 to 1 1/2 turns.

3. If additional ride quality is desired, reduce front preload by turning adjuster counterclockwise one turn.

4. If maximum ride quality is desired, decrease front rebound damping 1 turn and rear rebound by 1/2 turn.

Enhanced Steering Quickness

The response to steering input (quickness) may be enhanced by adjusting the vehicles front/rear ride height by changing sag. This is achieved by adjusting the preload to increase front sag and reduce rear sag.

1. Adjust suspension for the rider's weight See OPERATING RECOMMENDATIONS, Suggested Suspension Settings, Table 17 as the starting point.

2. Reduce steering effort by increasing the rear preload one position.

3. If more enhanced steering and cornering control is desired, reduce front preload by turning adjuster counterclockwise one turn.

4. If additional enhanced steering and cornering control is desired, increase rear compression damping by turning adjuster clockwise by 1/4-1/2 turn.

5. If maximum enhanced steering and cornering control is desired, increase front rebound damping by turning adjuster clockwise 1/2 turn clockwise.

Chassis Control/Handling Enhancement

To provide more road surface feedback for smoother road conditions, increase compression and rebound settings.

1. Adjust suspension for rider weight. See OPERATING RECOMMENDATIONS, Suggested Suspension Settings, Table 17 as the starting point.

2. Increase chassis/handling control by increasing front compression damping by turning 1 to 3 turns clockwise. Adjust rear compression damping by turning adjuster clockwise by 1/2 - 3/4 turns.

3. If maximum chassis control/handling control is desired, increase front rebound damping by turning 1/2 to 3/4

turn clockwise and rear rebound damping by turning 1/8 to 1/2 turn clockwise.

MAINTENANCE AND LUBRICATION

SAFE OPERATING MAINTENANCE



Perform the service and maintenance operations as indicated in the regular service interval table. Lack of regular maintenance at the recommended intervals can affect the safe operation of your motorcycle, which could result in death or serious injury

Good maintenance creates a safe motorcycle. A careful check of certain equipment must be made after periods of storage. Also, frequently inspect the motorcycle between the regular service intervals to determine if additional maintenance is necessary.

Check the following items:

1. Tires for correct pressure, abrasion or cuts.

2. Drive chain for wear or damage.
3. Brakes, steering and throttle for responsiveness and freedom from binding.
4. Brake fluid level and condition. Hydraulic lines and fittings for leaks. Also check brake pads and discs for wear.
5. Cables for fraying or crimping and free operation.
6. Engine oil level.
7. Engine coolant level.
8. Clutch fluid level and condition. Hydraulic lines and fittings for leaks.
9. Headlamp, tail lamp, brake lamp, and directional lamp operation.

BREAK-IN MAINTENANCE

NOTE

New motorcycle initial service is required to keep your new motorcycle warranty in force and make sure the emissions system operates properly.

After a new motorcycle has been ridden its first 620 miles (1000 kilometers) take it to an authorized EBR Dealer to have an initial service performed.

If it is impossible to take it to a dealer at the mileage intervals noted, the owner should:

1. Give the following outlined items attention or arrange to have the motorcycle serviced.
2. Take the motorcycle to a dealer for more complete service as soon as possible.

We recommend a Dealer perform the initial service.

WARNING

When supporting motorcycle, do not place supports under rear brake pedal. Damage to the brake system can occur, which could result in death or serious injury.

INITIAL SERVICE CHECK

First 620 Miles (1000 Kilometers)

The first scheduled maintenance is at 620 miles (1000 Kilometers). See Regular Service Intervals for a complete list of required services.

1. Change engine oil and clean magnetic drain plug.
2. Replace oil filter cartridge.
3. Inspect brake fluid level and condition. Check hydraulic brake lines and fittings for leaks.
4. Check brake pads and rotors for wear.
5. Check clutch fluid level. Check hydraulic lines and fittings for leaks.
6. Check oil lines for leaks.
7. Check tire pressure and inspect tread.
8. Check throttle cable adjustments.
9. Check operation of all electrical equipment and switches.
10. Check coolant level in expansion tank. Check tightness of hose clamps. Clean radiator and oil cooler fins.

11. Check drive chain and sprockets.
12. Check sidestand.
13. Check exhaust system.
14. Road Test.

SERVICE INTERVALS AND PERFORMANCE

Regular lubrication and maintenance will help keep your new EBR operating at peak performance. Your EBR Dealer knows best how to service your motorcycle with factory approved methods and equipment assuring you of thorough and competent workmanship.

See Regular Service Intervals, for more information.

NOTE

Refer to table 21. Regular maintenance interval operations are required to keep your new motorcycle warranty in force. The Use of other than EBR approved parts and service procedures may void the warranty. Any alterations to the emission system components, such as the electronic fuel injection and exhaust system, may be in violation of law.

WARNING

Perform the service and maintenance operations as indicated in the regular service interval time table. Lack of regular maintenance at the recommended time intervals can affect the safe operation of your motorcycle, which could result in death or serious injury.

WARNING

If you operate your motorcycle under adverse conditions (severe cold, extreme heat, very dusty environment, very bad roads, through standing water, etc.) you should perform the regular maintenance intervals more frequently to ensure the safe operation of your motorcycle. Failure to maintain your motorcycle could result in death or serious injury.

ENGINE LUBRICATION

Engine oil is a major factor in the performance and service life of the engine. Always use the proper grade of oil for the lowest temperature expected before the next scheduled oil change. Your authorized dealer has the proper oil to suit your requirements.

Refer to Table 18. EBR recommends using AMSOIL® 20W-50 Advanced Synthetic Motorcycle oil when adding or changing oil. If AMSOIL® is not available and addition of motor oil is required, SAE 20W50 may be used. Although SAE 20W50 is compatible with AMSOIL® we suggest the mixture of fluids be changed as soon as possible.

If AMSOIL® or SAE 20W50 are not available, the final option would be to add a synthetic 15W-50 oil that meets SG and JASO MA specifications. We again suggest the mixture of

fluids be changed as soon as possible. At the first opportunity, see an authorized dealer to change back to 100 percent AMSOIL.

CAUTION

Do not switch lubricant brands indiscriminately because some lubricants interact chemically when mixed. Use of inferior lubricants can damage the engine.

| Advanced Synthetic Motorcycle Oil | Viscosity | Product # | Lowest Ambient Temperature | Cold Weather Starts Below 40° F (10°C) |
|-----------------------------------|-----------|-----------|----------------------------|--|
| AMSOIL® 20W-50 Advanced Synthetic | SAE 20W50 | MCVQT-EA | 40° F (4° C) | Not Recommended |
| AMSOIL® 10W-30 Advanced Synthetic | SAE 10W40 | MCF+QT-EA | Below 40° F (4° C) | Excellent |

Table 18. Recommended Engine Oils

CHECKING OIL LEVEL

An accurate engine oil level reading can only be obtained with the engine at normal operating temperature. The engine will require a longer warm up period in colder temperatures if using the hot check procedure.

NOTES

- As part of the pre-ride inspection, verify that there are no oil leaks from the oil filter cover or oil lines prior to the operating of the motorcycle.

- The motorcycle should be on the sidestand when checking the oil level.
- Refer to Table 18. Use only recommended oil specified.

CAUTION

Do not allow oil level to fall below the **MINIMUM** mark on the sight gage. Doing so can result in equipment damage and/or equipment malfunction.

CAUTION

Do not overfill oil tank. Doing so can result in oil carryover to the air box leading to equipment damage and/or equipment malfunction. Do not switch lubricant brands indiscriminately. Some lubricant brands will interact with each other chemically when they are mixed together. Use of inferior lubricants can damage the engine.

Oil Level Cold Check

Perform engine oil level Cold Check as follows:

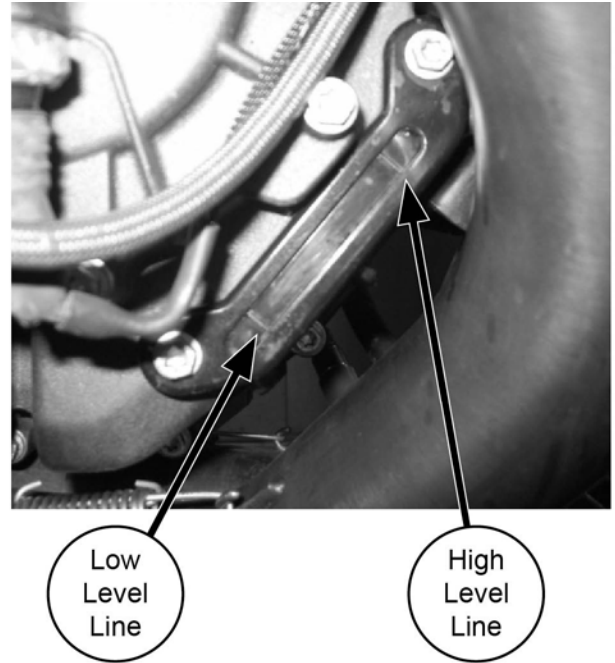

Figure 41. Oil sight gauge (SX) or with fairing removed (RX)

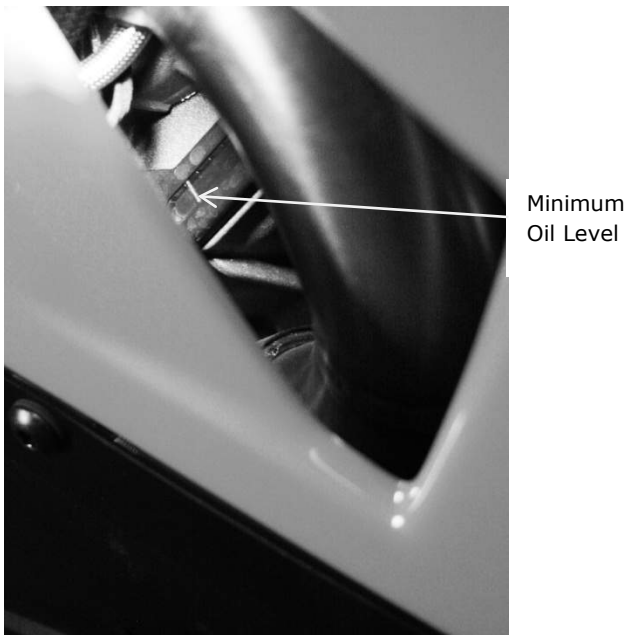

Figure 54. Oil Sight Gauge Visible Through RX Fairing.

NOTE

An accurate engine oil check can only be performed with the engine at normal operating temperature.

1. With motorcycle on the side stand look at the oil level in the sight gauge. An indicated oil level between the lower and upper lines on the oil level sight gauge is acceptable for safe engine operation. See Figures 41 and 54. On the RX the sight gauge is just visible through the right side fairing cooling slot below the front exhaust pipe.
2. If there is no oil present in the sight gauge lift the motorcycle to a straight up and down position to see if any oil appears in the sight gauge.
3. If oil appears proceed to the Hot Check.
4. If no oil appears place motorcycle on sidestand and add oil in 3.4 fl oz (0.1 L) increments just until you see oil in the gauge and then proceed to the Hot Check.

Oil Level Hot Check

Perform engine oil level HOT CHECK as follows:

1. To bring the motorcycle to normal operating temperature, ride the motorcycle for a least 10 minutes and 5 miles (8 kilometers).

2. Park the motorcycle on the sidestand while idling
3. Idle the engine one (1) minute. Shut off the engine.
4. Remove the oil fill plug. See figure 46.
5. Read the oil level in the sight gauge.
 - a. **Below the lower line:** Add oil in 3.4 fl oz (0.1 L) increments until the level is between the upper and lower lines. Refer to Table 17.
 - b. **Between the upper and lower lines:** It is safe to operate the motorcycle.
 - c. **At (or above) the upper line:** Drain oil at 6.8 fl oz (0.2 L) increments until the oil level is between the lines.
6. Install the oil fill plug.



Figure 46. filler plug:

ENGINE OIL CHANGE

CAUTION

Do not switch lubricant brands indiscriminately because some lubricants interact chemically when mixed. Use of inferior lubricants can damage the engine.

⚠ WARNING

Be sure that no lubricants or fluids get on tires, wheels, or brakes when changing fluid. Traction can be adversely affected, which could result in loss of control of the motorcycle and death or serious injury.

NOTE

The engine oil also lubricates the clutch and transmission

1. Place a suitable container under the motorcycle.
2. See figure 46. Unscrew and remove fill plug from oil fill hole. Replace O-ring if torn or damaged.
3. See Figure 40. Remove the left engine oil drain plug located in the crank case. Wipe any accumulated debris from magnetic tip on drain plug and replace the aluminum washer.

4. See Figure 40. Remove the right oil drain plug located under the clutch cover. Wipe any accumulated debris from plug and replace the aluminum washer.
5. After all oil has drained, tilt vehicle to the right side to drain any remaining oil from the right side of the engine.

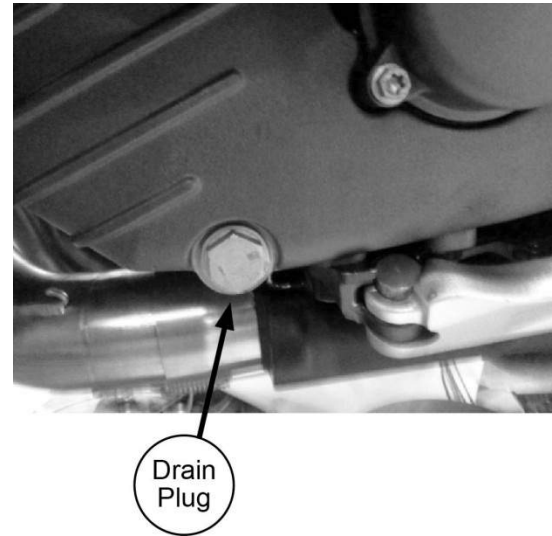

Figure 40. Engine oil drain plug left side

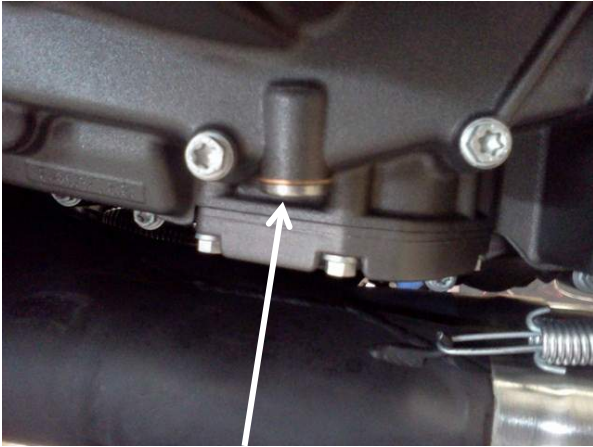

Figure 50. Right side drain plug.

NOTE

Refer to Table 21 to determine if the oil filter cartridge needs to be replaced.

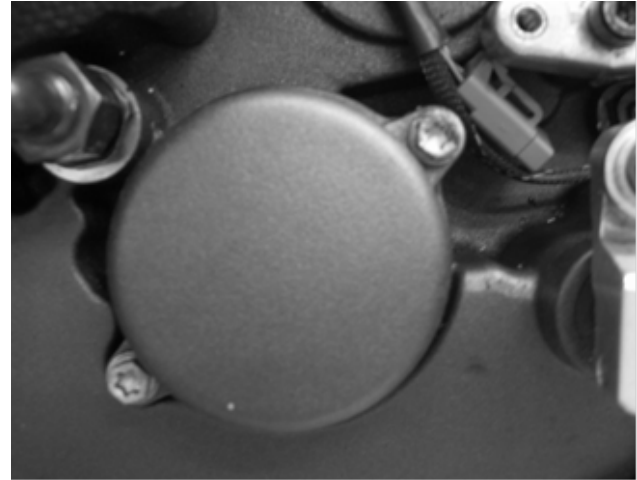

Figure 31. Oil Filter Cover.

6. If replacing the oil filter cartridge, perform the following:
 - A. Remove the two screws to detach the oil filter cover. See figure 31.
 - B. Clean the cover and inside the oil filter recess in the crankcase. Remove any debris.

7. Install both drain plugs after thoroughly draining oil.
 - A. Tighten left engine oil drain plug to 18 ft-lbs (24 Nm).
 - B. Tighten right engine oil drain plug to 11 ft-lbs (15 Nm).
8. Install new oil filter cartridge, if removed.
 - A. Apply a light film of clean engine oil to the rubber contact surface on the new oil filter cartridge.
 - B. Push new oil filter cartridge into cover until properly seated.
 - C. Install oil filter cover (with filter) onto crankcase with two screws. Tighten screws to 97 in-lbs (11 Nm).
9. Fill oil through filler hole using recommended oil from Table 17. Always verify proper hot oil level in sight glass. Do not overfill.

NOTE

Oil capacity with filter change is approximately 3.3 U.S. quarts (3.1 liters).

Oil capacity without filter change is approximately 3.0 U.S. quarts (2.8 liters).

10. Install (screw in) fill plug into oil fill hole. Make sure fill plug is screwed in completely.

NOTE

For ease of installation, apply a light film of clean engine oil to the fill plug O-ring.

WARNING

Compressed air can pierce the skin and flying debris from compressed air could cause serious eye injury. Wear safety glasses when working with compressed air. Never use your hand to check for air leaks or to determine air flow rates.

11. Inspect oil cooler fins for debris or damage. Blow out any debris from fins with compressed air from the inside of the cooler.
12. Wipe up any spilled oil on the vehicle.

13. Start engine. Verify that low oil pressure message on the instrument panel turns off after a few seconds when engine speed is 1000 RPM or above.

14. Check oil filter cover, drain plugs, hoses and oil cooler for leaks.

15. Check (hot) oil level. See MAINTENANCE AND LUBRICATION/ CHECKING OIL LEVEL.

WINTER LUBRICATION

In colder climates, the engine oil should be changed often. If motorcycle is used frequently for short trips, less than 15 miles (24 kilometers), in ambient temperatures below 60° F (16 C) oil change intervals should be reduced to 1500 miles (2400 km). Motorcycles used only for short runs must have a thorough tank flush out before new oil is put in. The tank flush out should be performed by an authorized dealer or qualified technician.

NOTE

The further below freezing the temperature drops, the shorter the oil change interval should be.

Water vapor is a normal by-product of combustion in any engine. During cold weather operation, some of the water

vapor condenses to liquid form on the cool metal surfaces inside the engine. In freezing weather, this water will become slush or ice, and if allowed to accumulate for too long, may block the oil lines and cause damage to the engine.

If the engine is run frequently and allowed to thoroughly warm up, most of this water will become vapor again and will be blown out through the crankcase breather. If the engine is not run frequently, and not allowed to warm up, this water will mix with the engine oil to form a sludge that will harm the engine.

FUEL FILTER

The fuel pump assembly located in the frame fuel cell includes a fuel filter. The fuel filter does not require any maintenance.

CHAIN DRIVE

See figure 42. Adjust chain to 30 mm +/- 2 mm as shown.

To adjust chain:

1. See figure 47. Loosen rear axle three turns.
2. See figure 47. Loosen lock nut.
3. Turn adjusters on each side of the swingarm evenly to adjust chain tension

4. Lift chain until it is tight and check chain tension by measuring the distance from the bottom of a chain link to the bottom of the chain rub block. Adjust distance to 30 mm +/- 2 mm as shown in figure 42.
5. Measure axle adjuster positions on both sides of the swingarm to ensure they are even on each side of the swingarm. This check will ensure rear sprocket is aligned with front sprocket. See figure 47.
6. Tighten lock nut.
7. Tighten axle to 100 ft-lbs (135.6 Nm)



Figure 47: Chain tension adjusters



Lift and Measure

Figure 42: Adjustment Measurement

CHASSIS LUBRICATION

CAUTION

Do not switch lubricant brands indiscriminately because some lubricants interact chemically when mixed. Use of inferior lubricants can damage the engine.

1. The steering head bearings are sealed, angular contact bearings and do not require additional lubrication. Check for smooth range of movement and proper operation.
2. Front and rear wheel bearings are sealed and do not require additional lubrication. Check at every tire change (more often in adverse conditions) or yearly if operated under winter conditions. Replace bearing spacers if they show any wear or distortion.
3. Inspect throttle control grip, throttle control cables, brake controls, clutch controls, fuel filler cap, ignition switch and sidestand every 6200 miles (10,000 km). Check for a smooth range of movement and proper operation. See an EBR Dealer for service as required.
4. Rear swingarm pivot bearings are sealed and do not require additional lubrication. Check for smooth range of movement and proper operation. See an EBR Dealer for service as required.

NOTE

Lubricate all control connections and parts regularly. Pay particular attention to lubrication needs after washing motorcycle or driving in wet weather.

CAUTION

Do not use pressure washers to clean wheel bearings, sprocket bearings, steering head bearings and swingarm pivot bearings. Doing so can result in equipment damage.

FRONT FORK OIL

⚠ WARNING

Incorrect amount of fork oil can adversely affect handling and lead to loss of vehicle control, which could result in death or serious injury.

Drain front fork oil and refill with a AMSOIL® Shock Therapy Suspension Fluid #10 Medium fork oil at the proper mileage intervals. Refer to Table 21. If either fork leaks oil or does not seem to be working properly, see an EBR Dealer. Forks must contain equal amounts of fork oil for proper damping.

Incorrect rebound action will result if there is insufficient oil in either side of fork.

AIR FILTER

⚠ CAUTION

Install air filter before running engine. Failure to do so can draw debris into the engine and could result in engine damage.

See Figure 51 and 52. Remove air box cover and air filter retainer. Remove air filter by pulling toward the rear of bike and then lifting it up. Inspect filter element at proper mileage intervals. Refer to Table 21. Inspect more often under dusty conditions. See an EBR dealer or video service manual for more information.

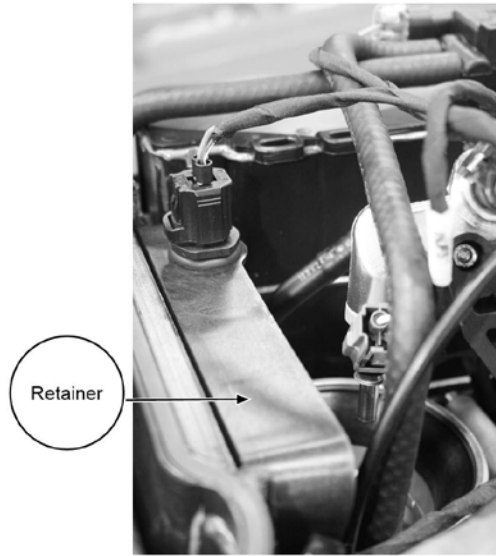

Figure 51: Air Filter Access.

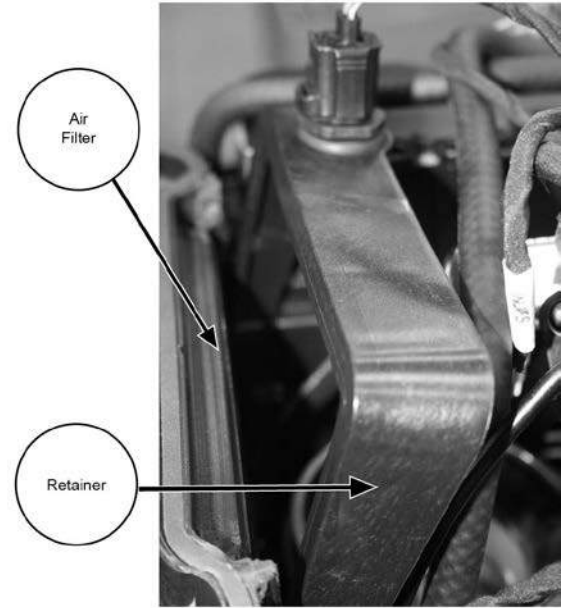

Figure 52: Air filter Access.

COOLANT LEVEL

Coolant Type

CAUTION

Use only high quality extended life antifreeze and coolant. Use of other coolants/mixtures may lead to engine damage.

The antifreeze & coolant needs to be a 50-50 mixture of de-ionized water and Ethylene Glycol-based Anti-freeze.

CAUTION

De-Ionized water must be used with the antifreeze in the cooling system. Hard water can cause scale accumulation in water passages which reduces cooling system efficiency, leading to overheating and engine damage.

Checking and Adding Coolant in Expansion Tank

The expansion tank is located under the right side fairing near the front fork. On the RX the COLD FILL level marking is visible on the inside of the expansion tank by looking under the headlamp, above the front fender and from the opposite

side of the motorcycle. On the SX it is visible on the right side of the motorcycle from the front.

1. View the expansion tank. See Figure 52. The fluid level should be at the marked level when cold.
2. To add coolant, unsnap the cap on the plastic expansion tank and fill to the midpoint of the tank.

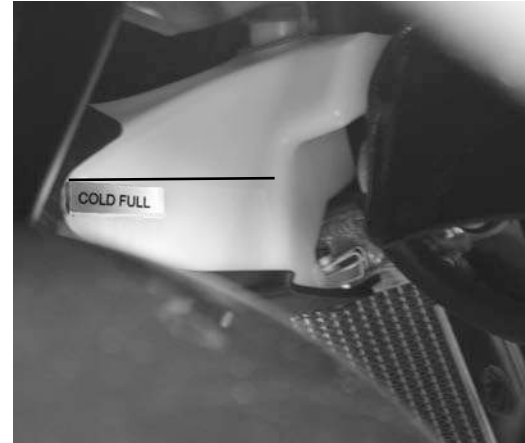

Figure 53. Cold Fill Line.

WARNING

Coolant mixture contains toxic chemicals, which may be fatal if swallowed. If swallowed, do not induce vomiting; call a physician immediately. Use in a well ventilated area. Irritation to skin or eyes can occur from vapors or direct contact. In case of skin or eye contact, flush thoroughly with water and go to the hospital, if necessary. Dispose of used coolant according to federal, state and local regulations.

WARNING

Do not remove the radiator filler cap when the engine is hot. The cooling system is under pressure and hot coolant and steam can escape, which could cause severe burns. Allow engine to cool before servicing

CAUTION

At operating temperature, the radiator and oil cooler contain hot fluids. Contact with the radiator or oil cooler can result in minor or moderate burns.

NOTE

If the coolant expansion tank is empty when the engine is cold, it is possible that air has been drawn into the cooling system. The system must be purged of any trapped air and refilled with coolant. See the video service manual for instructions on the correct procedure.

CAUTION

Clean the inlet surface of the radiator regularly. Leaves and other debris can collect on the radiator surface and degrade radiator performance which could lead to engine overheating and engine damage.

STORAGE

CAUTION

Proper storage is important for the trouble-free operation of your motorcycle. See below for storage recommendations or contact an EBR dealer. Improper storage procedures can lead to equipment damage.

If the motorcycle will not be operated for several months, such as during the winter season, follow the procedure below. Proper storage preparation will protect parts against

corrosion, preserve the battery, and prevent the build-up of gum and varnish in the fuel system. Improper storage may adversely affect the warranty. See WARRANTIES AND MAINTENANCE section for more information.

NOTE

List everything you do and fasten it to a handlebar. When you take the motorcycle out of storage, this list will be your reference/checklist to get your motorcycle in operating condition.

⚠ WARNING

Do not store motorcycle with gasoline in the tank within the home or garage where open flames, pilot lights, sparks, or electric motors are present. Gasoline is extremely flammable and highly explosive, which could result in death or serious injury.

Placing Motorcycle in Storage

If motorcycle is to be covered, use a material such as light canvas that will breathe. Plastic materials that do not breathe

promote the formation of condensation which can damage the finish of a motorcycle.

1. Warm motorcycle to operating temperature. Change oil and turn engine over to circulate the new oil.
2. Fill fuel tank and add a gasoline stabilizer. Use one of the commercially available gasoline stabilizers and follow the manufacturer's instructions.
3. Run engine until gasoline stabilizer has had a chance to reach fuel injectors.

CLEANING YOUR EBR

Aluminum parts must be maintained regularly to retain their original shine and luster. Frequently clean and wax your new EBR motorcycle to inhibit rust and corrosion. To aid in keeping your motorcycle clean, see an EBR dealer for cleaning, touch-up, polishing and waxing products.

CAUTION

Do not use pressure washers to clean wheel bearings, sprocket bearings, steering head bearings and swingarm bearings. Doing so can result in equipment damage.

WARNING

Observe warnings on labels of cleaning compounds. Failure to follow warnings could result in death or serious injury.

WARNING

Do not wash brake discs with cleaners containing chlorine or silicone. Cleaners containing chlorine and silicone can impair brake function, which could result in death or serious injury.

CAUTION

Do not use abrasive cleaners on frame, side stand, swingarm and wheels. The finish on these parts could be damaged if abrasive cleaners are used.

WINDSHIELD MAINTENANCE

CAUTION

Polycarbonate windscreens/windshields require proper attention and care to maintain. Failure to maintain polycarbonate properly can result in damage to the windshield/windscreen.

CAUTION

Do not use benzene, paint thinner, gasoline or any other type of harsh cleaner on the windshield. Doing so will damage the windshield surface.

- Do not clean in hot sun or high temperature.
- Powdered, abrasive or alkaline cleanser will damage the windscreen/windshield.

Windshields require special care. EBR recommends using a soft cloth and a high quality glass cleaner to clean your windshield. To minimize swirl marks, cleaning should be done when the motorcycle is cool and parked in the shade.

NOTE

Faint swirl marks are normal and may be more visible on tinted windshields than on clear windshields.

BODY PANEL CARE

CAUTION

Use of abrasive products or powered buffing equipment will cause permanent cosmetic damage to body panels. Use only

recommended products and techniques outlined in this manual to avoid damaging body panels.

Washing

To wash follow the instructions below:

1. Rinse surface with water.
2. Wash with a high quality car wash
3. Rinse surface thoroughly with water.
4. Dry with a clean chamois or soft dry natural fiber cloth.

Polishing

Polishing body panels results in greater surface gloss and a protective coating.

1. Clean and dry surfaces to be polished. See Washing.
2. Apply a high quality Carnuba Wax per package instructions.

Minor Scratch Removal

CAUTION

Use of abrasive products or powered buffing equipment will cause permanent cosmetic damage to body panels. Use only recommended products and techniques outlined in this manual to avoid damaging body panels.

To remove minor scratches form body panels follow the instructions below:

1. To remove light surface scratches and rubs, use a high quality scratch remover as recommended.
2. Make sure treatment is applied with a moist cloth and by hand (not machine).

NOTE

Black body panels are more prone to suffer permanent cosmetic damage if attempts to remove scratches are overdone.

Major Scratch Removal

There is no repair procedure for severely scratched surfaces. Severely scratched body panels must be replaced.

WHEEL CARE

To maintain the original luster and appearance of the wheels on your EBR motorcycle, clean and polish wheels as often as possible to inhibit rust and corrosion. Damage from harsh chemicals, acid based wheel cleaners, brake dust and lack of maintenance can occur. Regular washing and the use of corrosion protection will help to maintain their original appearance.

NOTES

- *It is imperative that the wheels are cared for weekly to guard against corrosion and pitting.*
- *Corrosion of these components is not considered to be a defect in materials or workmanship.*

See an EBR dealer for cleaning, polishing, and waxing products.

FRAME AND SWINGARM CARE

WARNING

The aluminum frame of this motorcycle is the fuel tank. Drilling, welding, cutting, grinding, sanding, polishing or other

modifications to this frame can weaken it or cause a fire, which could result in death or serious injury.

To aid you in cleaning the frame and swing arm, see an EBR dealer for cleaning supplies and touch up paint.

HYDRAULIC CLUTCH

General

The clutch is hydraulically actuated. Squeezing the left hand lever actuates the clutch master cylinder applying hydraulic pressure through the clutch fluid line to the secondary clutch actuator. The secondary actuator acts on the clutch pressure plate compressing the clutch springs and disengaging the clutch.

Checking Fluid Level

See Figure 31. Refer to table 21. Check the fluid level as follows:

1. Stand the motorcycle upright (not leaning on the sidestand) on a level surface, turn the handlebar so the clutch master cylinder reservoir is level.
2. Verify the fluid level in the fluid reservoir.

3. If the fluid level is at or below the LOWER line, rotate the front forks to access the fluid reservoir and remove the cover, stiffener and diaphragm.
4. Inspect the cover, stiffener and diaphragm for damage. Replace the diaphragm if necessary.
5. Add D.O.T. 4 BRAKE FLUID until the level is above the LOWER line. Use AMSOIL® Series 600 or equivalent.

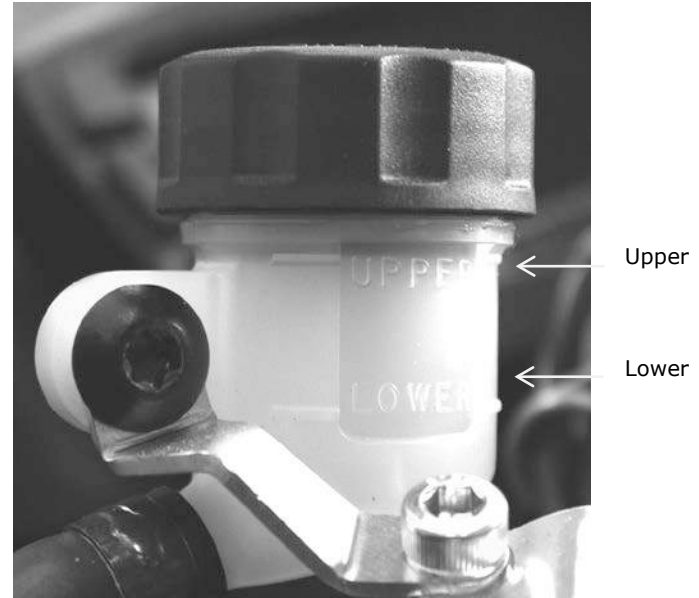

Figure 31. Clutch Fluid Reservoir.

NOTE

Do not overfill the clutch master cylinder reservoir. Leave sufficient volume in the reservoir to accommodate the rise in fluid level as the clutch friction disks wear.

6. Carefully place the diaphragm, stiffener, and cover on the master cylinder reservoir and tighten by hand.

CAUTION

D.O.T. 4 hydraulic brake fluid is used in the hydraulic clutch. Use AMSOIL® Series 600 racing DOT4 racing Brake Fluid or equivalent. Do not use other types of fluids as they are not compatible and could cause equipment damage.

CAUTION

Do not allow dirt or debris to enter the master cylinder reservoir. Dirt or debris in the reservoir can cause improper operation and equipment damage.

WARNING

The clutch failing to disengage can cause loss of control, which could result in death or serious injury. Prior to starting after extended periods of storage, place transmission in gear

and push vehicle back and forth several times to assure proper clutch disengagement.

CAUTION

Direct contact of D.O.T. 4 brake fluid with eyes can cause irritation. Avoid eye contact. In case of eye contact flush with large amounts of water and get medical attention. Swallowing large amounts of D.O.T. 4 brake fluid can cause digestive discomfort. If swallowed, obtain medical attention. Use in a well ventilated area. KEEP OUT OF REACH OF CHILDREN.

CAUTION

D.O.T. 4 brake fluid will damage painted and body panel surfaces it comes in contact with. Always use caution and protect surfaces from spills whenever brake work is performed. Failure to comply can result in cosmetic damage.

BRAKES

WARNING

Inspect brake pads for wear at service intervals. If you ride under adverse conditions (steep hills, heavy traffic, etc.), inspect more frequently. Excessively worn out brake pads can

lead to brake failure, which could result in death or serious injury.

The brake system needs routine inspections and maintenance at certain levels. Refer to table 21 for more information.

⚠ WARNING

Brakes are a critical safety component. Contact an EBR dealer for brake repair or replacement. Improperly serviced brakes can adversely affect brake performance, which could result in death or serious injury.

These brake tasks may include:

1. Inspecting front and rear brake pads and brake disks for wear.
2. Checking the fluid level in the front and rear master cylinder reservoirs.

Stand motorcycle upright and insure that the level is between the LOWER and UPPER marking. See figure 38 for front and figure 39 for the rear.

3. Replacing the front and rear brake pads and pin.

4. Changing the brake fluid and having the brakes serviced. Use only D.O.T. 4 Hydraulic Brake Fluid. Use AMSOIL® Series 600 racing DOT4 racing Brake Fluid or equivalent. Always take your motorcycle to an EBR Dealer for brake system maintenance.

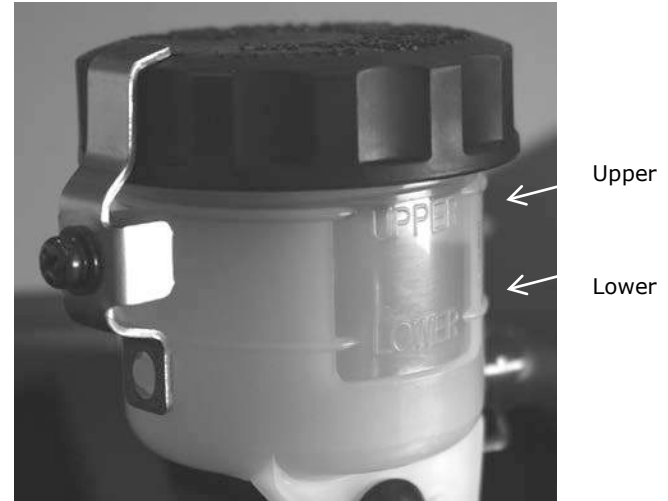

Figure 38. Front Brake Fluid Reservoir.



Figure 39. Rear Brake Fluid Reservoir.

CAUTION

D.O.T. 4 brake fluid will damage painted and body panel surfaces it comes in contact with. Always use caution and protect surfaces from spills whenever brake work is performed. Failure to comply can result in cosmetic damage.

⚠ CAUTION

Direct contact of D.O.T. 4 brake fluid with eyes can cause irritation. Avoid eye contact. In case of eye contact flush with large amounts of water and get medical attention. Swallowing large amounts of D.O.T. Brake fluid can cause digestive discomfort. If swallowed, obtain medical attention. Use in a well ventilated area. **KEEP OUT OF REACH OF CHILDREN.**

TIRES

Keep the tires properly inflated. Check tire pressure before riding when tires are cold.

⚠ WARNING

Be sure tires are properly inflated, balanced and have adequate tread. Inspect your tires regularly and see an EBR dealer for replacements. Riding with excessively worn,

unbalanced or under inflated tires can adversely affect stability and handling, which could result in death or serious injury.

Check inflation pressure and inspect tread for punctures, cuts, breaks, etc. Inspect at least weekly if in daily use or before each trip if used only occasionally. Refer to Table 8 for tire pressures and sizes.

WARNING

Match tires, air valves and caps to the correct wheel rim. Contact an EBR dealer. Mismatching can result in damage to the tire bead, allow tire slippage on the rim, or cause tire failure, which could result in serious injury or death.

Replace worn tires with new tires identical to those that came on the motorcycle as original equipment. Other tires may not fit correctly or may be hazardous to use.

WARNING

Tires are a critical safety component. Contact an EBR dealer for tire repair or replacement. Improper tire service can adversely affect stability and handling, which could result in death or serious injury.

WARNING

Replace punctured or damaged tires. In some cases, small punctures in the tread may be repaired from within the demounted tire by an EBR dealer. Speed should NOT exceed 50mph (80 km/h) for the first 24 hours after the repair, and the repaired tire should NEVER be used over 80 MPH (130 km/h). Failure to follow this warning could result in death or serious injury.

WARNING

Striking an object, such as a curb, can cause internal tire damage. If an object is struck, remove and inspect both the inside and outside of the tire. A damaged tire can adversely affect stability and handling, which could result in death or serious injury.

TIRE REPLACEMENT

Inspection

Tread wear indicator bars will appear on tire tread surfaces when 1/16th in. (1.6 mm) or less of tire tread remains. Always replace tires before the tread wear indicator bars appear on the surface of the tire.

See Figure 32. The location of tread wear indicator bars are identified by "TWI" markings on the tire sidewalls.

When to Replace Tires

New tires are needed if any of the following conditions exist:

1. Tread wear indicator bars become visible on the tread surfaces.
2. Tire cords or fabric become visible through cracked sidewalls, snags, or deep cuts.
3. A bump, bulge, or split in the tire.
4. Puncture, cut, or other damage to the tire that cannot be repaired.

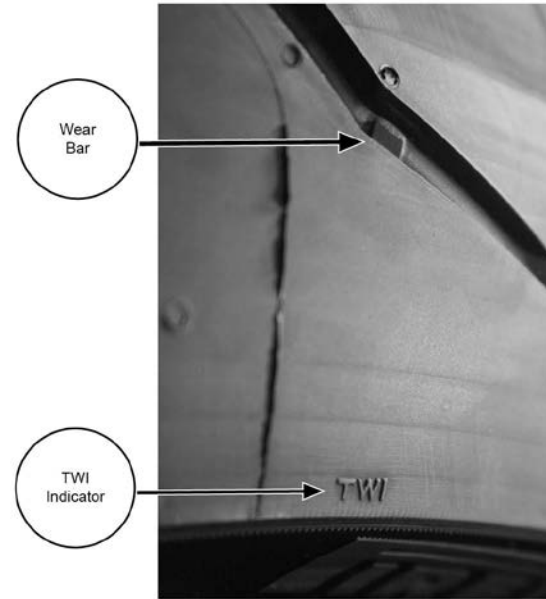

Figure 32

SHOCK ABSORBER

The rear shock absorber requires inspections and maintenance at proper mileage intervals. Refer to Table 21.

- Inspect shock absorber for oil leaks.
- Inspect shock eye bushings for deterioration
- Check for loose mounting hardware.

See an EBR dealer for all shock absorber repairs.

SPARK PLUGS/COILS

Refer to Table 21. Spark plugs require inspection and replacement at specified mileage.

CAUTION

Do NOT pull on any electrical wires. Pulling on electrical wires may damage the internal conductor causing high resistance, which may result in minor or moderate injury.

The engine is equipped with plug-top coils. To inspect the spark plugs, the coils must be removed. See the video service manual for proper service procedure.

See Table 2. Only the specified spark plugs with the proper gap should be installed.

IGNITION TIMING

Spark timing is advanced electronically as engine speed increases to suit starting, low speed and high speed requirements.

IDLE SPEED

| | |
|---|--------------|
| Idle speed is monitored and controlled by the Electronic Control Module (ECM) and Idle Air Control (IAC) and is not adjustable. | REGULAR IDLE |
| 1190 RX/SX | 1350 RPM |

Table 19. Engine Idle speed.

WHEEL BEARINGS

The wheel bearings are sealed units. No greasing or maintenance is required.

Inspect wheel bearings each time the wheel is removed.

Replace when worn.

***NOTE:** Excessive play or roughness indicates worn bearings that require replacement.*

VOLTAGE REGULATOR

The alternator output is controlled and changed to direct current by the voltage regulator.

- The voltage regulator increases charging rate when battery voltage is low.
- The voltage regulator decreases charging rate when battery charge is up.

CAUTION

It is possible to overload your motorcycles charging system by adding too many electrical accessories . If your combined electrical accessories operating at any one time consume more electrical current than your vehicle's charging system can produce, the electrical consumption can discharge the battery and cause vehicle electrical system damage. See an EBR dealer for advice about the amount of current consumed by additional electrical accessories, or for necessary wiring changes.

NOTE

The voltage regulator does not require any scheduled maintenance. If any electrical system trouble is experienced that might be traceable to the alternator or voltage regulator, take the motorcycle to an EBR dealer. Dealers have the necessary parts and testing equipment to perform electrical service.

BATTERY

GENERAL

Type

Your motorcycle uses a permanently sealed, maintenance free, Lithium-Ion battery. All batteries are shipped pre-charged and ready to be put into service. **Do not attempt to open the battery for any reason.**

WARNING

Do not burn or incinerate battery. Battery may explode, and toxic fumes and materials are created causing personal injury or death.

⚠ WARNING

Never remove warning label attached to top of battery. Failure to read and understand all precautions contained in warning, could result in death or serious injury.

Voltmeter Test

The voltmeter test provides a general indicator of battery condition. Check the voltage of the battery to verify that it is in a charged condition. If the open circuit (disconnected) voltage reading is below 13.1 V, charge the battery and then re-check the voltage.

Cleaning and Inspection

Battery is accessed by removing the rider's seat. See RIDER SEAT. Battery top must be clean and dry. Dirt and electrolyte on the battery can cause battery to self-discharge.

1. Clean battery.
2. Clean cable connectors and battery terminals using a wire brush or fine grit sandpaper to remove any oxidation.
3. Inspect and clean the battery screws, clamps and cables. Check for breakage, loose connections and corrosion.

4. Check the battery posts for melting or damage caused by over tightening.
5. Inspect the battery for discoloration, a raised top or a warped or distorted case. This might indicate that the battery has been frozen, overheated or overcharged.
6. Inspect the battery case for cracks or leaks.

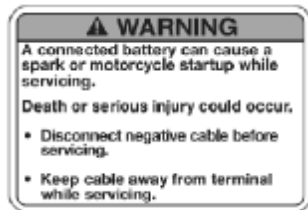

Figure 33. Battery Warning Label

⚠ WARNING

Use this battery only in EBR model 1190 RX/SX motorcycles. Do not use if battery is damaged or cracked.

Charging

Charge the battery if any of the following conditions exist:

- Vehicle lamps appear dim.
- Electric starter sounds weak.

If your motorcycle will not be ridden for longer than a week attach a battery charger.

CAUTION

Never charge a battery without first reviewing the instructions for the charger being used. In addition to the manufacturer's instructions, follow these general safety precautions.

⚠ WARNING

Unplug or turn OFF battery charger before connecting charger cables to battery. Connecting cables with charger ON can cause a spark, which could result in death or serious injury.

⚠ WARNING

Connect positive (+) battery cable first. If positive (+) cable should contact ground with negative (-) cable connected, causing sparks, which could result in death or serious injury.

⚠ WARNING

Do not reverse the charger connections described in the following steps or the charging system of the motorcycle could be damaged.

NOTES

- *A Shorai® BMS Charger with Store Mode is highly recommended.*
- *Use an automatic charger. The charger to determine when charging is complete.*
- *Do not use chargers with excessively high voltage designed for flooded batteries or excessively high current designed for much larger batteries. Charging should be limited to no more than 2 amps at no more than 14.4 volts.*

CAUTION

Older lead chargers without automatic shut-off or that have a desulfation deep cycle conditioning mode should never be used. Improper charging is dangerous and will void your warranty.

CAUTION

“Smart” lead-acid chargers with automatic cutoff may be used for periodic charging, but will NOT work as a tender/maintainer and should be disconnected immediately after charge has finished.

1. Perform a voltmeter test to determine the state of charge. If battery needs to be charged, proceed to the next step.
2. Place the battery on a level surface.
3. Connect the red battery charger lead to positive (+) terminal of the battery.
4. Connect the black battery charger lead to negative (-) terminal of the battery.

NOTE

If the battery is still in the vehicle, connect the negative lead to the chassis ground. Make sure that the ignition and all electrical accessories are turned off.

5. Step away from the battery and turn on the charger.

WARNING

Unplug or turn OFF battery charger before disconnecting charger cables from battery. Disconnecting clamps with charger ON can cause a spark, which could result in death or serious injury.

6. After the battery is fully charged, turn OFF the charger and disconnect the black battery charger lead to the negative (-) terminal of the battery.
7. Disconnect the red battery charger lead to the positive (+) terminal of the battery.

Mark the charging date on the battery.

Storage

- A battery that is stored in the vehicle is affected by quiescent loads. Quiescent loads occur from things like diode leakage and maintaining computer memory with the vehicle off.
- If the battery is going to be left in an unridden bike for more than 2 months (8 weeks), disconnect and remove the battery from the vehicle.

- If you are not riding twice a month, then you should charge the battery every few weeks. A “smart” battery charger will charge the battery but will not work as a maintenance charge. If using a charger of this type disconnect when the battery is fully charged. A Shorai® BMS Charger with Store Mode may be used as a maintenance charger. Read and follow the directions that come with the charger.

- If the battery is removed from a bike after sitting for 2 months or more, attach a trickle charger to the battery to top it off and then store it as you normally would. A Shorai® BMS Charger with Store Mode is highly recommended for this.

The battery terminals can be accessed under the seat. Clean connections and check tightness annually. Battery terminals should be tightened to 22-26 in/lbs (2.5-2.9 Nm). If it is necessary to remove the battery from your motorcycle, see the video service manual for detailed instructions.

NOTE

Use only the battery specified for this model. If installing a new battery, check the polarity marked on the terminals before installation.

JUMP-STARTING EBR MOTORCYCLES

EBR does not recommend jump-starting a motorcycle. Jump starting the battery could cause damage to the cells and lead to an internal short. If a battery voltage is too low to start the vehicle it is important to use the Shorai BMS01 balancing charger to recharge and diagnosis the condition of the battery before use.

HEADLAMP

The low beam and position lamps are lit whenever the ignition key is turned on. All bulbs are lit when the high beam switch is activated or when passing lamp switch is pressed.

The high beam, low beam and position lights are all LEDs and are not replaceable separately.

The automatic-on headlamp feature provides increased visibility of the rider to other motorists.

WARNING

Be sure headlamp is on at all times. Poor visibility to other motorists can result in death or serious injury.

HEADLAMP ALIGNMENT

1. Place the bike on level ground with the center point of the front axle 25 feet (7.6 m) from the wall, or some other suitable target.
2. Verify that front and rear tire inflation pressures are correct and the suspension adjusted to the weight of the principal rider. See SPECIFICATIONS
3. As the weight of the rider will compress the suspension slightly, have a person whose weight is approximately the same as that of the principal rider sit on the motorcycle. With the motorcycle laden and upright, point the front wheel straight forward at the wall and measure the distance from the floor to the center of the LOW BEAM bulb.

NOTE

The low beam is the top lamp and the high beam is the bottom lamp.

4. Draw a vertical line on the wall that aligns with the motorcycle when it is upright.
5. Draw a horizontal line through the vertical line on the wall that is the same height as the center of the low beam.
6. Then draw a second line 2.1 in. (53.3mm) lower than that
7. As the weight of the rider will compress the suspension slightly, have a person whose weight is approximately the same as that of the principal rider sit on the motorcycle.
8. Turn on the low beam. The upper cutoff of the low beam should rest at the lower line and be centered on the vertical line. Adjust as needed.
9. Turn on high beam. The center of the high beam bright spot should rest on the intersection of the top horizontal line and the vertical line. Adjust as needed.

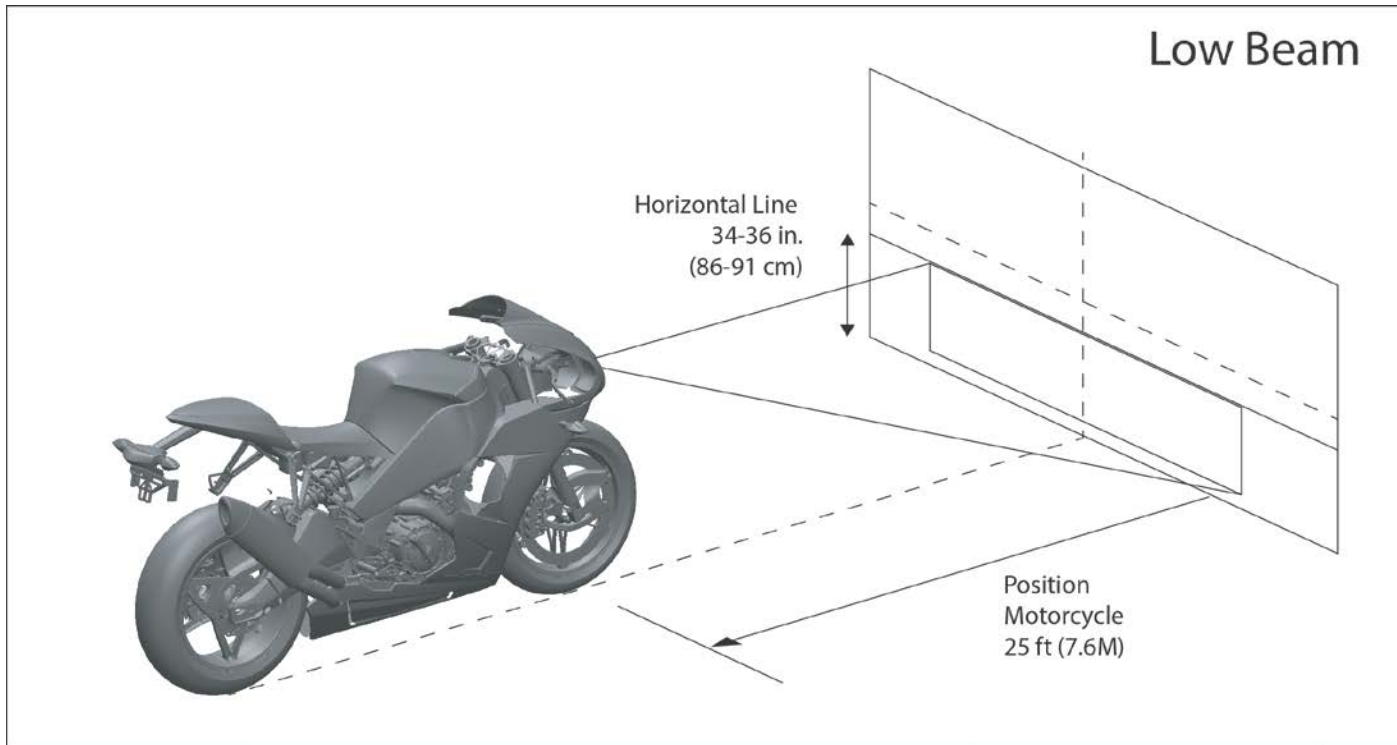

Figure 34. Low Beam Aiming.

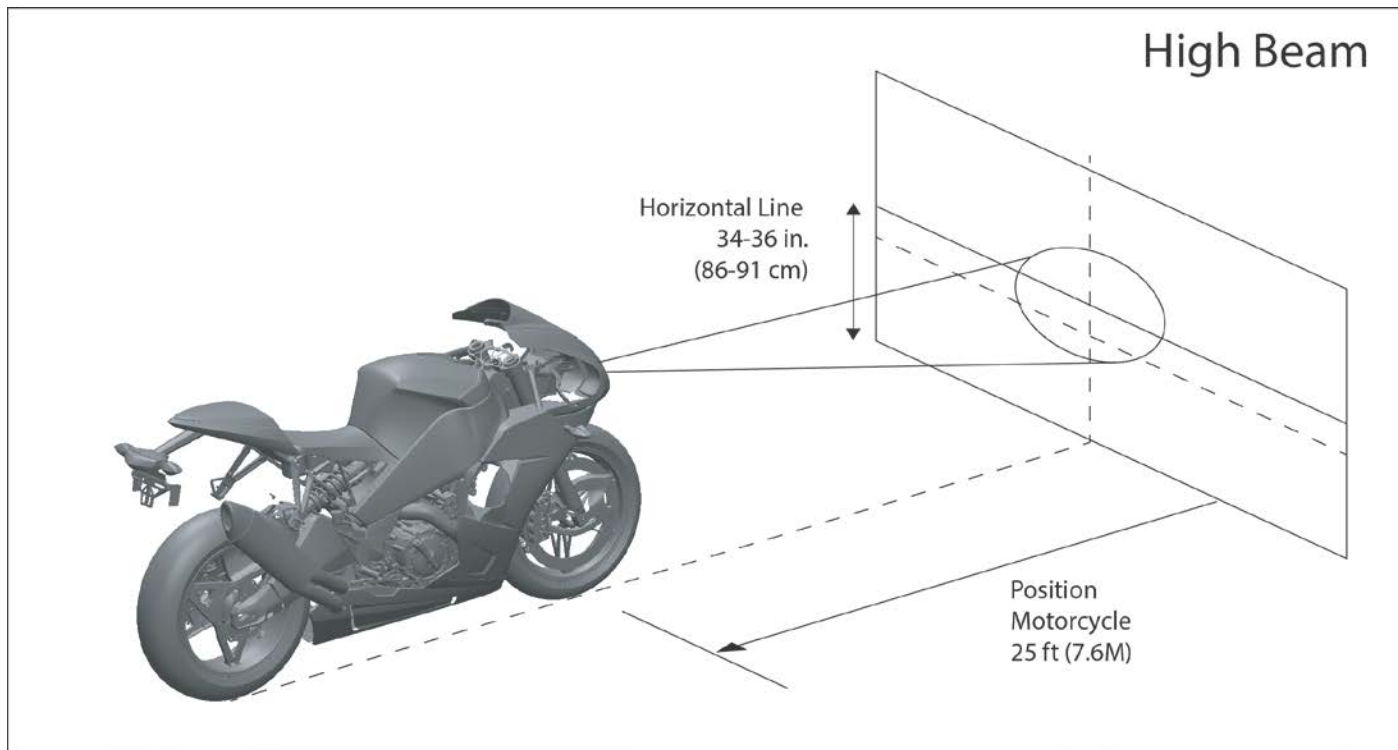

Figure 35. High Beam Aiming

HEADLAMP ADJUSTMENT

To access adjusters on the SX first remove the front trim pieces; see Figure 55.

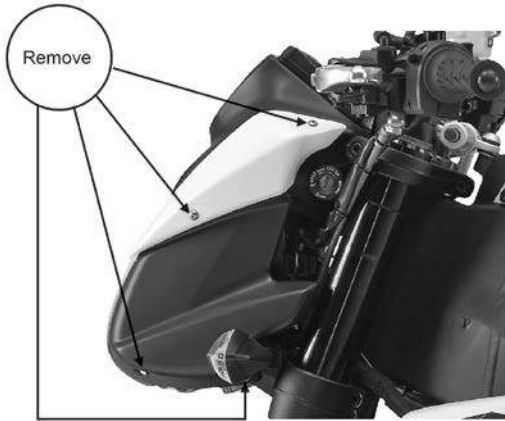

Figure 55.

Horizontal Adjustment

Horizontal adjusters are located on the left side of the bike behind the fairing/headlamp. See figure 36.

NOTE

The top adjuster works on the low beam which is the top lamp. The lower adjuster works on the high beam which is the lower lamp.

- To move low beam to the right, turn upper left adjuster clockwise.
- To move low beam to the left, turn upper left adjuster counterclockwise.
- To move high beam to the right, turn lower left adjuster clockwise.
- To move high beam to the left, turn lower left adjuster counterclockwise.

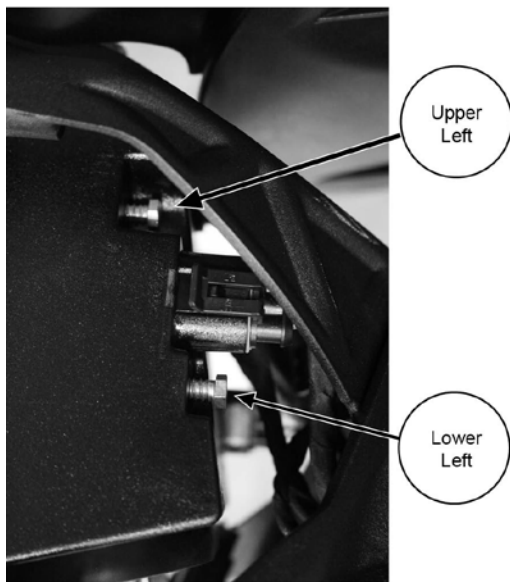

Figure 36. Left Side (Horizontal) Adjusters

VERTICAL ADJUSTMENT

Low beam

See Figure 37. The vertical headlamp adjusters are located on the right side of the bike behind the fairing/headlamp.

NOTE

The top adjuster works on the low beam which is the top lamp. The lower adjuster works on the high beam which is the lower lamp.

- To lower low beam, turn upper right adjuster counter clockwise.
- To raise low beam, turn upper right adjuster clockwise.

Vertical Adjustment: High beam

- To lower upper beam, turn lower right adjuster clockwise.
- To raise upper beam, turn lower right adjuster counter clockwise.

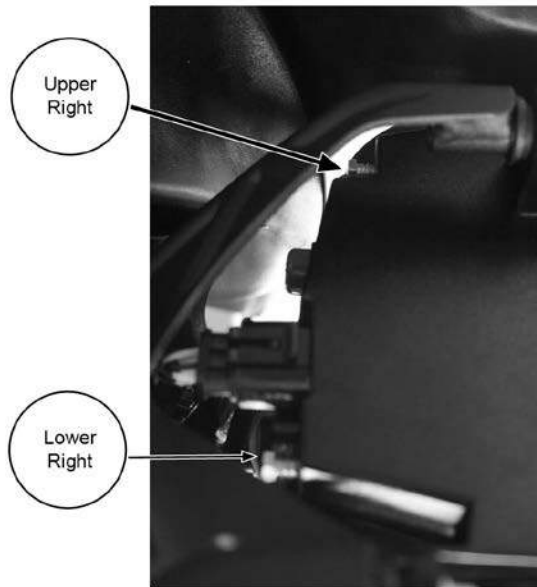

Figure 37. Right side (Vertical) Adjusters.

TROUBLESHOOTING

GENERAL

WARNING

The troubleshooting section of the Owner's Manual is a guide to diagnose problems. Study the video service manual before performing any work. Improper repair and/or maintenance could result in death or serious injury.

The following checklist of possible operating troubles and their probable causes will be helpful in keeping your motorcycle in good operating condition. More than one of these conditions may be causing trouble and should be carefully checked.

ENGINE

Starter Does not Operate or Does Not Turn Engine Over.

1. Engine run switch in OFF position.
2. Ignition switch is not ON.
3. Discharged battery or loose or corroded connections (solenoid chatters)

4. Clutch lever not squeezed against handlebar or transmission not in neutral.

5. Blown fuse.

Engine Turns Over But Does Not Start or Starts Hard.

1. Fuel tank is empty.

2. Discharged Battery or loose or damaged battery terminal connections.

3. Spark Plugs are loose, defective, fouled, have improper gap, or not according to specification.

4. Spark plug coils are defective, have loose connection, or wiring in bad condition and shorting.

5. Engine oil too heavy (winter operation).

6. No output from ECM. See dealer.

7. Clogged fuel filter. See dealer.

8. Inadequate fuel pressure in fuel lines. Possible leak. See dealer.

9. Clogged fuel injectors. See dealer.

10. Inoperative fuel pump. See dealer.

11. Water or dirt in fuel system. See dealer.

12. Engine management system failure. See dealer.

13. Intake Manifold Leak. See dealer.

14. Tripped bank angle sensor. Turn key to OFF, and then back to ON again. Start Engine.

Starts But Runs Irregularly or Misses.

1. Spark plugs in bad condition or partially fouled.

2. Spark plug gap too close or too wide

3. Battery nearly discharged.

4. Damaged wire or loose connection at battery terminals or coils.

5. Intermittent short circuit due to damaged wire

6. Water or dirt in fuel system. See dealer.

7. Engine management system failure. See dealer.

8. Fuel level too low. Add gasoline.

9. Inoperative fuel injector. See dealer.
10. Obstructed fuel tank vent valve or pinched vent
11. Engine management system failure. See dealer.
12. Intake manifold leak. See dealer.

A Spark Plug Fouls Repeatedly.

1. Fuel mixture too rich. See dealer.
2. Incorrect spark plug.

Pre-Ignition or Detonation (Knocks or Pings)

1. Incorrect Fuel.

Overheats

1. Insufficient coolant in system. Add Coolant.
2. Insufficient oil supply or oil not circulating. See dealer.
3. Heavy carbon deposit from lugging engine. See dealer.
4. Oil cooler obstructed.
5. Cooling fans inoperative. See dealer.

6. Thermostat stuck closed. See dealer.
7. Plugged or restricted radiators or coolant lines.
8. Airflow to radiators obstructed.

Excessive Vibration

1. Engine mounts loose. See dealer.
2. Swingarm pivot shaft loose. See dealer.
3. Damaged frame. See dealer.
4. Drive chain badly worn or out of adjustment.
5. Wheels and/or tires damaged. See dealer.

Poor Fuel Economy

1. O2 sensor damaged or malfunctioning (engine running rich). See dealer.
2. Clogged air filter.

LUBRICATION SYSTEM

1. Engine Leaks Oil from Cases or Hoses. Loose parts. See dealer.
2. Imperfect seal at gaskets, washers, etc. See dealer.
3. Restricted oil line or oil screen. See dealer.

ELECTRICAL SYSTEM

Alternator Does Not Charge

1. Regulator not grounded. See dealer.
2. Engine ground wire loose or damaged. See dealer.
3. Loose or damaged wires in charging circuit. See dealer.

Alternator Charge Rate is Below Normal

1. Weak battery.
2. Excessive use of add-on accessories.
3. Loose or corroded connections.
4. Extensive periods of idling or low speed riding.

TRANSMISSION

Transmission Shifts Hard

Transmission shifting mechanism worn. See dealer.

Transmission Jumps Out of Gear

1. Worn shifter dogs in transmission. See dealer.

Clutch Slips

1. Clutch fluid reservoir overfilled.
2. Worn friction discs. See dealer.
1. Insufficient clutch spring tension. See dealer.

Clutch Drags or Does Not Release

1. Improper fluid level.
2. Insufficient clutch spring tension. See dealer.
3. Clutch discs warped. See dealer.

Clutch Chatters

1. Friction discs or steel discs worn or warped. See dealer.

BRAKES

Brakes Do Not Hold

1. Normally Master cylinder low on fluid. See dealer.
2. Brake line contains air bubbles. See dealer.
3. Master cylinder piston worn. See dealer.
4. Brake pads contaminated with grease or oil. See Dealer.
5. Brake pads badly worn. See dealer.
6. Brake discs badly worn or warped. See dealer
7. Brake fades because of heat build up. Excessive braking or pads dragging. See dealer.
8. Brake drags. Insufficient hand lever free play. See dealer.

COOLING SYSTEM

Overheats

1. Air flow through the radiator is obstructed.
2. The radiator is internally plugged.
3. Insufficient coolant.

4. Cooling fans not operating.
5. Thermostat stuck closed.

WARRANTY AND MAINTENANCE

See Regular Service Intervals. This Owner's Manual contains your new motorcycle warranty and a maintenance record.

The maintenance record is a scheduled mileage interval that contains a specific maintenance checklist for upkeep of your motorcycle. It is the owners responsibility to follow the scheduled mileage intervals as specified. All of the specified maintenance services must be performed to keep your warranty valid.

1. Make an appointment with an EBR dealer for inspection and service prior to first 620 miles (1000 km).
2. Bring this Owner's manual with you when you visit the dealer to have your motorcycle inspected and serviced.
3. Have the owner record stubs dated and signed for required proof of service during the warranty period.
4. Keep receipts covering any parts, service or maintenance performed.

These records should be transferred to each subsequent owner.

WARNING

Do not use aftermarket parts which can adversely affect performance and handling. Removing or altering factory installed parts can adversely affect performance and could result in death or serious injury.

Use only EBR approved parts and accessories. Use of certain other manufacturers performance parts may void your warranty. See an EBR dealer.

EBR dealerships are independently owned and operated and may sell parts and accessories that are not manufactured or not approved by EBR. Therefore, you should understand that we are not, and cannot be responsible for the quality, suitability, or safety of any non-EBR part, accessory or design modifications, including labor, which may be sold and/or installed by our dealers.

NOTE

If you move from your present address or sell your motorcycle, visit the EBR website and fill out the owner

information. This is necessary in the event that the EBR Company needs to contact the owner concerning information that could affect the safe operation of this motorcycle.

KEEPING IT ALL EBR

Insist that your dealer uses only Genuine EBR replacement parts to keep your EBR motorcycle and its warranty intact.

NOTE

Installing off-road or competition parts to enhance performance may void your new motorcycle warranty. See an EBR dealer for details.

CAUTION

It is possible to overload your motorcycle's charging system by adding too many electrical accessories. If your combined electrical accessories operating at any one time consume more electrical current than your vehicles charging system can produce, the electrical consumption can discharge the battery and cause vehicle electrical system damage. See an EBR dealer for advice about the amount of current consumed by additional electrical accessories, or for necessary wiring changes.

CALIFORNIA EVAPORATIVE EMISSION CONTROL

All new 2014 EBR motorcycles sold in the state of California are equipped with an evaporative emission control system.

This system is designed to meet the CARB regulations in effect at the time of manufacture. The system requires a small amount of maintenance. Periodic inspection is required to make sure hoses are properly routed, not kinked or blocked, and that all fittings are secure. Mounting hardware should also be checked periodically for tightness.

EPA NOISE REGULATIONS IN THE UNITED STATES

EPA Noise regulations require that the following statements be included in the Owner's Manual.

TAMPERING WITH NOISE CONTROL SYSTEM PROHIBITED

Federal law prohibits the following acts of the causing thereof. (1.) The removal or rendering inoperative by any person other than for the purposes of maintenance, repair, or replacement of any device or element of design incorporated into any new vehicle for the purpose of noise control prior to its sale or delivery to the ultimate purchaser or while it is in use, or (2) the use of the vehicle after such device or element

of design has been removed or rendered inoperative by any person.

AMONG THOSE ACTS PRESUMED TO CONSTITUTE TAMPERING ARE THE ACTS LISTED BELOW.

1. Replacing the muffler(s) and/or entire exhaust system with parts not certified to be noise legal for street use.
2. Removing or modifying the muffler internal baffles in any way.
3. Replacing the air intake/cleaner assembly with one not certified to be noise legal for street use.
4. Modifying the air intake/cleaner assembly in such a way as to make the vehicle no longer noise legal for street use.

EBR recommends that any and all noise related maintenance be done by an authorized EBR dealer using genuine EBR parts.

WARRANTY AND SERVICE INFORMATION

Any authorized EBR dealer is responsible for providing the warranty repair work on your motorcycle. If you have any questions regarding the warranty obligations contact your selling dealer. For normal service work or warranty work

under the above conditions, you may obtain the name and location of your nearest EBR dealer see www.ErikBuellRacing.com

REPORTING SAFETY DEFECTS IN THE UNITED STATES

U.S. Only

Safety defects must be reported to the National Highway Traffic Safety Administration (NHTSA) and EBR.

NHTSA Statement

If you believe that your vehicle has a defect which could cause a crash or could cause injury or death, you should immediately inform the National Highway Traffic Safety Administration (NHTSA) in addition to notifying EBR. If the NHTSA receives similar complaints, it may open an investigation, and if it finds that a safety defect exists in a group of vehicles, it may order a recall and remedy campaign. However, NHTSA cannot become involved in individual problems between you, your dealer, or EBR. Refer to table 20.

NHTSA Contacts

| ITEM | DATA |
|----------|--|
| PHONE | Call the Auto Safety Hot Line toll-free at 1-888-DASH-2DOT |
| MAIL | U.S. Department of Transportation, National Highway Traffic Safety Administration, Office of Defects Investigation, NVS-210, 400 7th Street S.W., Washington, D.C. 20590 |
| WEB SITE | http://www.nhtsa.dot.gov |

Table 20.

You can also obtain other information about motor vehicle safety from the hot line.

NOTE

If you move from your present address, or sell your motorcycle, please fill out and mail the post card at the back of this manual. This is necessary in the event that the Company needs to contact the owner concerning information that could affect the safe operation of this motorcycle.

OWNER TRANSFER IDENTIFICATION FORM

When purchasing a pre-owned EBR, we encourage you to submit an Owner Transfer Notification Form. It is critical that the new owner information is sent to EBR. New owner information is required to be on file with EBR to transfer an Extended Service Plan Contract. EBR is also required by the

National Traffic and Motor Vehicle Safety Act to notify all owners in the event of a recall. The form may be obtained at any EBR dealer or email the below information to info@ebr.com .

| | | | |
|---------------------------------|--|--------------------|--|
| VEHICLE VIN | | CRANKCASE NUMBER | |
| OWNER'S NAME | | | |
| OLD ADDRESS | | APT NO. | |
| CITY | | STATE AND ZIP CODE | |
| DEALER NAME | | | |
| CITY | | STATE AND ZIP CODE | |
| | | | |
| NEW ADDRESS | | APT NUMBER | |
| CITY | | STATE AND ZIP CODE | |
| MY MOTORCYCLE HAS BEEN SOLD TO: | | DATE OF SALE | |
| NEW OWNER'S NAME | | | |
| ADDRESS | | APT NUMBER | |
| CITY | | STATE AND ZIP CODE | |
| | | | |
| | | | |

LIMITED WARRANTY 2014 EBR 1190 RX/SX MOTORCYCLE

24 Months/Unlimited Miles

EBR warrants for any new 2014 EBR motorcycle that an authorized EBR dealer will repair or replace without charge any parts found under normal use to be defective in factory materials or workmanship. Such repair and replacement will be EBR's sole obligation and the customer's sole remedy under this warranty.

THERE IS NO OTHER EXPRESS WARRANTY (OTHER THAN THE SEPARATE EMISSIONS AND NOISE WARRANTIES) ON THE MOTORCYCLE. ANY IMPLIED WARRANTY OF MERCHANTABILITY OR FITNESS FOR PARTICULAR PURPOSE IS LIMITED TO THE DURATION OF THIS WARRANTY.

Some states do not allow limitations on how long an implied warranty lasts, so the above limitation may not apply to you.

TO THE FULLEST EXTENT ALLOWED BY LAW, EBR AND ITS DEALERS SHALL NOT BE LIABLE FOR LOSS OF USE, INCONVIENIENCE, LOST TIME, COMMERCIAL LOSS, OR OTHER INCIDENTAL OR CONSEQUENTIAL DAMAGES.

Some states do not allow the exclusion or limitation of incidental or consequential damages, so the above limitation or exclusion may not apply to you. This warranty gives you specific legal rights, and you may have other rights which vary from state to state.

The following terms and conditions apply to this warranty:

DURATION

1. The duration of this limited warranty is twenty four months, starting from the earlier of (a) the date of the initial retail purchase and delivery from an authorized EBR dealer, or (b) the second anniversary of the last day of the model year of the motorcycle. Your dealer will submit an electronic Sales and Warranty Registration form to initiate your warranty.

2 Any unexpired portion of this limited warranty will be transferred to subsequent owners, upon the resale of the motorcycle during the warranty period.

OWNER'S OBLIGATIONS

To obtain warranty service, return the motorcycle at your expense within the warranty period to an authorized dealer. Our dealer should be able to provide warranty service during normal business hours and as soon as possible, depending on the workload of the dealers service department and the availability of necessary parts.

EBR 2799
Buell Drive East Troy,
WI 53120 USA

EXCLUSIONS

This warranty will not apply to any motorcycle as follows:

1. Which has not been operated or maintained as specified in the Owner's Manual.
2. Which has been abused, misused, improperly stored, used "off the highway" or used for racing or competition of any kind.
3. Which is not manufactured to comply with the laws of the market in which it is registered.
4. Installing off-road or competition parts to enhance performance may void all or part of your new motorcycle warranty. See an EBR dealer for details.
5. Acts of God, war, riot, insurrection, natural disasters, including but not limited to, nuclear contamination, lightning, dust storms, hail storms, ice storms, earthquakes, floods, or for other circumstances out of EBR's control.

OTHER LIMITATIONS

This warranty does not cover:

1. Parts and labor for normal maintenance as recommended in the Owner's Manual, or the replacement of parts due to normal wear and tear including such items as the following: tires, lubrication, oil and filter change, fuel system cleaning, battery maintenance, engine tune up, spark plugs, brake, clutch and chain/ adjustment (including chain replacement).
2. Cosmetic concerns that arise as a result of owner abuse, lack of proper maintenance or environmental conditions (except concerns that result from defects in material or workmanship, which are covered by this warranty for the duration of the warranty period).
3. Any cosmetic condition existing at the time of retail delivery that has not been documented by the selling dealer prior to retail delivery.
4. Defects or damage due to the motorcycle caused by alterations outside of EBR factory specifications.

IMPORTANT: READ CAREFULLY

1. Our dealers are independently owned and operated and may sell other products. Because of this, EBR IS NOT RESPONSIBLE FOR THE SAFETY, QUALITY, OR SUITABILITY OF ANY NON-EBR PART, ACCESSORY OR DESIGN MODIFICATION INCLUDING LABOR WHICH MAY BE SOLD AND/OR INSTALLED BY OUR DEALERS.
2. This warranty is a contract between you and the manufacturer. It is separate and apart from any warranty you may receive or purchase from the dealer. The dealer is not authorized to alter, modify, or in any way change the terms and conditions of this warranty.
3. Any warranty work or parts replacement authorized by the manufacturer will not preclude the manufacturer from later relying on any exclusion where applicable.

2014 EBR NOISE CONTROL SYSTEM LIMITED WARRANTY

The following warranty applies to the noise control system, is in addition to the MOTORCYCLE LIMITED WARRANTY and applies only to motorcycles sold in the U.S.

EBR warrants that this vehicle is designed and built so as to conform at the time of sale with applicable regulations of the U.S. Environmental Protection Agency (as tested following f-76 Drive-By test procedure) and that it is free from defects in materials and workmanship which would cause this motorcycle not to meet such U.S. Environmental Protection Agency Standards within 1 year from initial retail purchase and delivery from an authorized EBR dealer, or one year from the second anniversary of the last day of the model year of the motorcycle, or 3,730 miles (6,000 km) whichever expires first. Any unexpired portion of this limited warranty will be transferred to subsequent owners, upon the resale of the motorcycle during the warranty period. If the motorcycle was used as a demonstrator, then the Warranty period may have started and/or expired prior to the initial retail sale. See an EBR dealer for details.

THERE IS NO OTHER EXPRESS WARRANTY (OTHER THAN THE SEPARATE MOTORCYCLE AND EMISSIONS WARRANTIES) ON THE MOTORCYCLE. ANY IMPLIED WARRANTY OF MERCHANTABILITY OR FITNESS FOR PARTICULAR PURPOSE IS LIMITED TO THE DURATION OF THIS WARRANTY.

Some states do not allow limitations on how long an implied warranty lasts, so the above limitation may not apply to you.

The warranty period shall begin on the date the motorcycle is delivered to the first retail purchaser or, if the motorcycle is placed in service as a demonstrator or company vehicle prior to sale at retail, on the date it is first placed in service.

THE FOLLOWING ITEMS ARE NOT COVERED BY THE NOISE CONTROL SYSTEM WARRANTY

1. Failures which arise as a result of misuse, alterations, or accident as specified in the Owner's Manual.

2. Replacing, removing, or modifying any portion of the NOISE CONTROL SYSTEM (consisting of the exhaust system and air intake/cleaner assembly) with parts not certified to be legal for street use.
3. Any motorcycle on which the odometer mileage has been changed so that the mileage cannot be determined.
4. TO THE FULLEST EXTENT ALLOWED BY LAW, EBR AND ITS DEALERS SHALL NOT BE LIABLE FOR LOSS OF USE, INCONVENIENCE, LOST TIME, COMMERCIAL LOSS OR OTHER INCIDENTAL OR CONSEQUENTIAL DAMAGES.

Some states do not allow the exclusion or limitation or consequential damages, so the above limitation or exclusion may not apply to you.

Other Rights

This warranty gives you specific legal rights, and you may have other rights which vary from state to state.

Recommendations for Required Maintenance

It is recommended that any noise system maintenance be performed by and authorized EBR dealer using genuine EBR replacement parts. The maintenance, replacement, or repair of the noise control system may be performed by any other qualified service outlet or individual. Non-genuine parts may be used only if such parts are certified to comply with U.S. Environmental Protection Agency Standards.

EBR
2799 Buell Drive,
East Troy, WI 53120 USA

EMISSION CONTROL SYSTEM SUPPLEMENTAL WARRANTY

YOUR WARRANTY RIGHTS AND OBLIGATIONS

The U.S. Environmental Protection Agency (EPA) and Erik Buell Racing, LLC (ERIK BUELL RACING) are pleased to explain the emission control system warranty on your 2014 and later motorcycle. In California, new motor vehicles must be designed, built and equipped to meet the State's stringent anti-smog standards. In all other states, new motor vehicles must be designed, built, and equipped to meet U.S. EPA Federal anti-smog standards. ERIK BUELL RACING must warrant the emission control system on your motorcycle for the periods of time listed below provided there has been no abuse, neglect or improper maintenance of your motorcycle.

Your emission control system may include parts such as the fuel-injection system, the ignition system, catalytic converter, oxygen sensors, fuel pump, and engine computer. Also included may be hoses, belts, connectors and other emission-related assemblies.

Where a warrantable condition exists, ERIK BUELL RACING will repair your motorcycle at no cost to you, including diagnosis, parts and labor.

MANUFACTURER'S EMISSION CONTROL SYSTEM SUPPLEMENTAL WARRANTY COVERAGE

Class III motorcycles (280 cc and above): for a period of use of five (5) years or 30,000 kilometers (18,641 miles), whichever first occurs.

If an emission-related part on your motorcycle is defective, the part will be repaired or replaced by ERIK BUELL RACING.

This is your emission control system DEFECTS WARRANTY.

OWNER'S EMISSION CONTROL SYSTEM SUPPLEMENTAL WARRANTY RESPONSIBILITIES

- As the motorcycle owner, you are responsible for the performance of the required maintenance listed in your owner's manual. ERIK BUELL RACING recommends that you retain all receipts covering maintenance on your motorcycle, but ERIK BUELL RACING cannot deny warranty solely for the lack of receipts or for your failure to ensure the performance of all scheduled maintenance.
- You are responsible for presenting your motorcycle to an ERIK BUELL RACING dealer as soon as a problem exists.
- The warranty repairs should be completed in a reasonable amount of time, not to exceed 30 days.
- As the motorcycle owner, you should be aware that ERIK BUELL RACING may deny your warranty coverage if your motorcycle or a part has failed due to abuse, neglect, improper maintenance or unapproved modifications.

If you have any questions regarding your warranty rights and responsibilities, you should contact ERIK BUELL RACING Corporation at 2799

Buell Drive, Unit C, East Troy, Wisconsin, 53120.

ERIK BUELL RACING, LLC - LIMITED WARRANTY ON EMISSION CONTROL SYSTEM

ERIK BUELL RACING warrants that each new 2014 and later EBR brand motorcycle, which includes as standard equipment, a headlight, taillight and stoplight, and is street legal:

- A. is designed, built and equipped so as to conform at the time of initial retail purchase with all applicable regulations of the United States Environmental Protection Agency; and
- B. is free from defects in material and workmanship which cause such motorcycle to fail to conform with applicable regulations of the United States Environmental Protection Agency for a period of use of 30,000 kilometers (18,641 miles), if the motorcycle's engine displacement is equal to or greater than 280 cubic centimeters; or 5 (five) years from the date of initial retail delivery, whichever first occurs.

I. COVERAGE

Warranty defects shall be remedied during customary business hours at any authorized EBR motorcycle dealer located within the United States of America in compliance with the Clean Air Act and applicable regulations of the United States Environmental Protection Agency. Any part or parts replaced under this warranty shall become the property of ERIK BUELL RACING.

II. LIMITATIONS

This Emission Control System warranty shall not cover any of the following:

- A. Repair or replacement required as a result of
 - (1) accident,
 - (2) misuse,
 - (3) repairs improperly performed or replacements improperly installed,
 - (4) use of replacement parts or accessories not conforming to ERIK BUELL RACING's specifications

which adversely affect performance and/or

(5) use in competitive racing or related events.

- B. Inspections, replacement of parts and other services and adjustments required for required maintenance.
- C. Any motorcycle on which the odometer mileage has been changed so that actual mileage cannot be readily determined.

III. LIMITED LIABILITY

- A. The liability of ERIK BUELL RACING under this Emission Control System Warranty is limited solely to the remedying of defects in material or workmanship by an authorized ERIK BUELL RACING motorcycle dealer at its place of business during customary business hours. This warranty does not cover inconvenience or loss of use of the motorcycle or transportation of the motorcycle to or from the ERIK BUELL RACING dealer. ERIK BUELL RACING shall not be liable for any other expenses, loss or damage, whether direct, incidental, consequential or exemplary arising in connection with the sale or use of or inability to use the motorcycle for any purpose. Some states do not allow the exclusion or limitation of any incidental or consequential damages, so the above limitations may not apply to you.
- B. No express emission control system warranty is given by ERIK BUELL RACING, except as specifically set forth herein. Any emission control system warranty implied law, including any warranty of the merchantability or fitness for a particular purpose, is limited to the express emission control system warranty terms stated in this warranty. The foregoing statements of warranty are exclusive and in lieu of all other remedies. Some states do not allow limitations on how long an implied warranty lasts so the above limitations may not apply to you.
- C. No dealer is authorized to modify this Limited Emission Control System Warranty.

IV. LEGAL RIGHTS

This warranty gives you specific legal rights, and you may also have other rights which vary from state to state.

V. This warranty is in addition to ERIK BUELL RACING's limited motorcycle warranty.

VI. ADDITIONAL INFORMATION

Any replacement part that is equivalent in performance and durability may be used in the performance of any maintenance or repairs. However, ERIK BUELL RACING is not liable for these parts. The owner is responsible for the performance of all required maintenance. Such maintenance may be performed at a service establishment or by any individual. The warranty period begins on the date the motorcycle is delivered to an ultimate purchaser.

Erik Buell Racing, LLC
2799 Buell Drive, Unit C
East Troy, WI 53120
Phone: (262) 642-1627
Fax: (262) 684-5353

REGULAR SERVICE INTERVALS

Regular lubrication and maintenance will help keep your new EBR operating at peak performance. Your EBR dealer knows how to best service your motorcycle with factory approved methods and equipment assuring you of thorough and competent workmanship.

NOTES

- Refer to Table 21. Regular maintenance interval operations are required to keep your new motorcycle warranty in force. The use of other than EBR approved parts and service procedures may void the warranty. Any alterations to the emission system components, such as fuel and exhaust system, may be in violation of Federal and State laws.
- Refer to Table 22. When servicing your motorcycle, bring this Owner's manual to the dealership and complete the information needed in the blank columns listed.

Perform the service and maintenance operations as indicated in the regular service interval table. Lack of regular maintenance at the recommended intervals can affect the safe operation of your motorcycle, which could result in death or serious injury. If you operate your motorcycle under adverse conditions (severe cold, extreme heat, very dusty environment, very bad roads, through standing water, etc.), you should perform the regular maintenance intervals more frequently to ensure the safe operation of your motorcycle. Failure to maintain your motorcycle could result in death or serious injury.

Regular Service Intervals

| MAINTENANCE SCHEDULE | | | | | | | | | |
|--|------------------------------------|---------------------|------------------------|--------------------------|--------------------------|--------------------------|--------------------------|--------------------------|-------|
| ITEMS SERVICED | PROCEDURE | 620 MILES (1000 KM) | 6200 MILES (10,000 KM) | 12,400 MILES (20,000 KM) | 18,600 MILES (30,000 KM) | 24,800 MILES (40,000 KM) | 31,000 MILES (50,000 KM) | 37,200 MILES (60,000 KM) | NOTES |
| Engine Oil | Replace | X | X | X | X | X | X | X | 1 |
| Engine Oil Filer Cartridge | Replace | X | | X | | X | | X | |
| Air Cleaner | Inspect, clean & Re-oil | | X | X | X | X | X | X | |
| Crankcase Breather | Clean or Replace | | | X | | X | | X | |
| Tires | Check Condition, Pressure, & Tread | X | X | X | X | X | X | X | 4 |
| Rear Chain and Sprocket | Inspect, Adjust & Lubricate | X | X | X | X | X | X | X | 2 |
| Throttle, Brake, Clutch controls & Sidestand | Inspect, Service as needed | X | X | X | X | X | X | X | 2 |
| Clutch Fluid | Check Levels & Condition | X | X | X | X | X | X | X | 3 |
| Brake Fluid | Check Levels & Condition | X | X | X | X | X | X | X | 3 |
| Brake Pads & Discs | Inspect for Wear | X | X | X | X | X | X | X | |
| Spark Plugs | Replace | | | X | | | X | | 2 |

MAINTENANCE SCHEDULE

| ITEMS SERVICED | PROCEDURE | 620 MILES (1000 KM) | 6200 MILES (10,000 KM) | 12,400 MILES (20,000 KM) | 18,600 MILES (30,000 KM) | 24,800 MILES (40,000 KM) | 31,000 MILES (50,000 KM) | 37,200 MILES (60,000 KM) | NOTES |
|-----------------------------------|--|--|-------------------------------|---------------------------------|---------------------------------|---------------------------------|---------------------------------|---------------------------------|--------------|
| Electrical switches and equipment | Check Operation | | | X | | | X | | 2 |
| Front Fork Oil | Replace | | | X | | X | | X | 2 |
| Exhaust System | Inspect for Leaks, Cracks, Loose or Missing Fasteners or Heat Shield | X | X | X | X | X | X | X | 5 |
| Battery | Check battery and Clean Connections | | | | | | | | 5 |
| Cooling System | Inspect Level, Check Clamps for Tightness | X | X | X | X | X | X | X | 2 |
| Coolant | Replace | Replace Every 15,000 Miles (24,000 KM) | | | | | | | 2, 6 |
| Radiators & Oil Cooler Fins | Clean | X | X | X | X | X | X | X | |

| ITEMS SERVICED | PROCEDURE | 620 MILES (1000 KM) | 6200 MILES (10,000 KM) | 12,400 MILES (20,000 KM) | 18,600 MILES (30,000 KM) | 24,800 MILES (40,000 KM) | 31,000 MILES (50,000 KM) | 37,200 MILES (60,000 KM) | NOTES |
|---|---------------------------------------|---------------------|------------------------|--------------------------|--------------------------|--------------------------|--------------------------|--------------------------|-------|
| Brake system, clutch Actuating system & Oil Lines | Inspect for Leaks | X | X | X | X | X | X | X | 2 |
| Critical Fasteners | Check Tightness | | | X | | X | | X | 2 |
| Valve Clearance | Inspect and Adjust Shims as Necessary | | X | X | X | X | X | X | 4, 2 |
| Road Test | Verify Component & System Functions | X | X | X | X | X | X | X | |

Table 21.

NOTES:

1. Perform annually or at specified interval, whichever comes first.
2. Should be performed by an authorized EBR dealer, unless you have proper tools, data and qualifications.
3. Change D.O.T. 4 fluid and flush brake and clutch systems every 2 years.
4. May vary with frequency of operation and riding style.

5. Perform annually.
6. Perform every two years or at specified interval, whichever comes first.

| Service Mile Interval | Date | Dealer Number | Technician Name | Technician Signature |
|--------------------------|------|---------------|-----------------|----------------------|
| 620 MILES (1000 KM) | | | | |
| 6,200 MILES (10,000 KM) | | | | |
| 12,400 MILES (20,000 KM) | | | | |
| 18,600 MILES (30,000 KM) | | | | |
| 24,800 MILES (40,000 KM) | | | | |
| 31,000 MILES (50,000 KM) | | | | |
| 37,200 MILES (60,000 KM) | | | | |
| 43,400 MILES (70,000 KM) | | | | |

Table 22. Owner's Maintenance Records

SERVICE LITERATURE Visit any EBR dealer or go to ErikBuellRacing.com to purchase a service or parts manual for your motorcycle. Factory authorized manuals are the most complete and detailed source of information outside of your EBR dealer.

TIRE REGISTRATION FORM

TIRE REGISTRATION FORM

It is important that you register your Pirelli brand tire purchases with Pirelli promptly after your purchase is completed. You can either fill out the registration form on the right hand side of the page and mail it to the following address:

Pirelli Tire North America—Motorcycle Division:

100 Pirelli Drive
Rome, GA 30161
1-800-PIRELLI

Or register your tires online at the following website

<www.us.pirellimoto.com/newtireregistration>

Benefits of Using the Web to Register:

- Faster— Just fill out the form and send electronically
- Privacy— all of the data you enter on our website is protected.
- Find information about Pirelli tires and the technology behind our products performance.

The Pirelli tires on your EBR have specifically been approved to enhance the ride and performance of your motorcycle. Replacement Pirelli tires are available for purchase at your local EBR retailer. Refer to your EBR owner's manual for specific size and model information.

CO893 1B6



The Tire Identification Number:

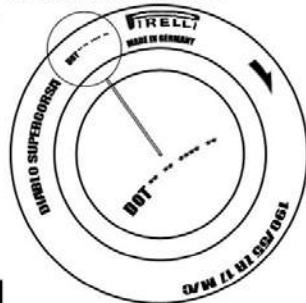

The 12 Digit identification number must be provided in order to register your Pirelli brand motorcycle tires.

Thank You for Registering your Pirelli Brand Tires.

Customer Information:

Customers Name (print) _____ Date _____

Customers Address _____

City _____ State _____ ZIP _____

Motorcycle Brand _____ Model _____ Year _____

Dealer Information:

Name of Dealer which sold Tire _____ Date _____

Dealer's Address _____

City _____ State _____ ZIP _____

The required information above provides Pirelli with the data necessary to contact you in the event it is necessary. Pirelli Tire will not resell or redistribute any personal information without your consent. Please mail your registration to Pirelli.

Pirelli Brand Tires (fill shaded areas)

| Tire Identification Numbers (see tire diagram) | | | | | | | | | | | | |
|--|---|---|---|---|---|---|---|---|---|----|----|----|
| QTY | 1 | 2 | 3 | 4 | 5 | 6 | 7 | 8 | 9 | 10 | 11 | 12 |
| | | | | | | | | | | | | |
| | | | | | | | | | | | | |
| | | | | | | | | | | | | |