



10/02/17 16:49:52 32KWN600\_001



# Honda PCX

**OWNER'S MANUAL**



**USO E MANUTENZIONE**



**MANUAL DEL PROPIETARIO**



© Honda Motor Co., Ltd. 2010

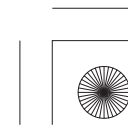
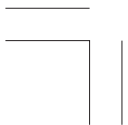



10/02/17 16:49:56 32KWN600\_002



## **IMPORTANT INFORMATION**

- **OPERATOR AND PASSENGER**

This scooter is designed to carry the operator and one passenger. Never exceed the maximum weight capacity.

- **ON-ROAD USE**

This scooter is designed to be used only on the road.

- **READ THIS OWNER'S MANUAL CAREFULLY**

Pay special attention to the safety messages that appear throughout the manual. These messages are fully explained in the "A Few Words About Safety" section which appears before the Contents page.

This manual should be considered a permanent part of the scooter and should remain with the scooter when resold.

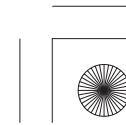



10/02/17 16:49:59 32KWN600\_003



## **Honda PCX OWNER'S MANUAL**

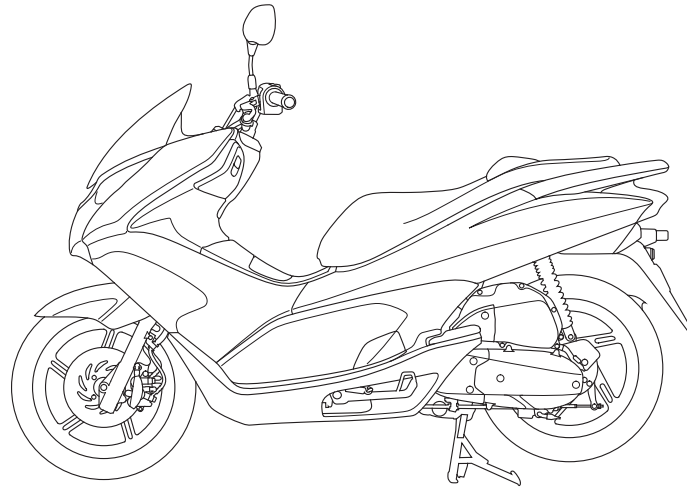

**All information in this publication is based on the latest production information available at the time of approval for printing. Honda Motor Co.,Ltd. reserves the right to make changes at any time without notice and without incurring any obligation.**

**No part of this publication may be reproduced without written permission.**

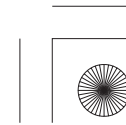



10/02/17 16:50:04 32KWN600\_004



## WELCOME

The scooter presents you a challenge to master the machine, a challenge to adventure. You ride through the wind, linked to the road by a vehicle that responds to your commands as no other does. Unlike an automobile, there is no metal cage around you. Like an airplane, a pre-ride inspection and regular maintenance are essential to your safety. Your reward is freedom.

To meet the challenges safely, and to enjoy the adventure fully, you should become thoroughly familiar with this owner's manual BEFORE YOU RIDE THE SCOOTER.

As you read this manual, you will find information that is preceded by a **NOTICE** symbol. This information is intended to help you avoid damage to your scooter, other property, or the environment.

When service is required, remember that your Honda dealer knows your scooter best. If you have the required mechanical "know-how" and tools, your dealer can supply you with an Official Honda Shop Manual to help you perform many maintenance and repair tasks.

Pleasant riding, and thank you for choosing a Honda !





10/02/17 16:50:11 32KWN600\_005



- The following code in this manual indicates the country.
- The illustrations herein are based on the ED type.

E	UK
F	France
ED	European direct sales
U	Australia                  New Zealand
KO	Korea

- The specifications may vary with each locale.

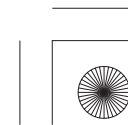
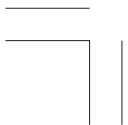

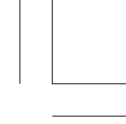

## A FEW WORDS ABOUT SAFETY

Your safety, and the safety of others, is very important. And operating this scooter safely is an important responsibility.

To help you make informed decisions about safety, we have provided operating procedures and other information on labels and in this manual. This information alerts you to potential hazards that could hurt you or others.

Of course, it is not practical or possible to warn you about all hazards associated with operating or maintaining a scooter. You must use your own good judgment.

You will find important safety information in a variety of forms, including:

- **Safety Labels** — on the scooter.
- **Safety Messages** — preceded by a safety alert symbol  and one of three signal words: **DANGER**, **WARNING**, or **CAUTION**.

These signal words mean:

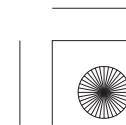



10/02/17 16:50:19 32KWN600\_007



**▲ DANGER**

You **WILL** be **KILLED** or **SERIOUSLY HURT** if you don't follow instructions.

**▲ WARNING**

You **CAN** be **KILLED** or **SERIOUSLY HURT** if you don't follow instructions.

**▲ CAUTION**

You **CAN** be **HURT** if you don't follow instructions.

- **Safety Headings** — such as Important Safety Reminders or Important Safety Precautions.
- **Safety Section** — such as Scooter Safety.
- **Instructions** — how to use this scooter correctly and safely.

This entire manual is filled with important safety information — please read it carefully.

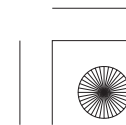

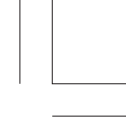

## **OPERATION**

page

### **1 SCOOTER SAFETY**

- 1 IMPORTANT SAFETY INFORMATION
- 2 PROTECTIVE APPAREL
- 5 LOAD LIMITS AND GUIDELINES
- 10 IMAGE LABELS

### **15 PARTS LOCATION**

- 18 INSTRUMENTS AND INDICATORS

### **27 MAJOR COMPONENTS**

**(Information you need to operate this scooter)**

- 27 BRAKES
- 33 COOLANT
- 35 FUEL
- 38 ENGINE OIL
- 39 TUBELESS TYRES

page

### **45 ESSENTIAL INDIVIDUAL COMPONENTS**

- 45 IGNITION SWITCH
- 46 FUEL LID AND SEAT OPENER SWITCH
- 48 RIGHT HANDLEBAR CONTROLS
- 49 LEFT HANDLEBAR CONTROLS

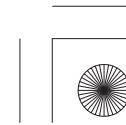



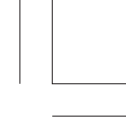

page

**50 FEATURES**

**(Not required for operation)**

- 50 STEERING LOCK
- 51 SHUTTER
- 52 IDLING STOP SYSTEM
- 61 HELMET HOLDER
- 62 CENTER COMPARTMENT
- 63 DOCUMENT COMPARTMENT
- 64 GLOVE BOX
- 65 HEADLIGHT AIM VERTICAL  
ADJUSTMENT
- 66 CLIP



page

**67 OPERATION**

- 67 PRE-RIDE INSPECTION
- 68 STARTING THE ENGINE
- 73 RUNNING-IN
- 74 RIDING
- 83 PARKING
- 84 ANTI-THEFT TIPS

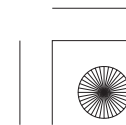

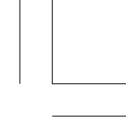

## MAINTENANCE

page

### 85 MAINTENANCE

85	THE IMPORTANCE OF MAINTENANCE
86	MAINTENANCE SAFETY
87	SAFETY PRECAUTIONS
88	MAINTENANCE SCHEDULE
91	TOOL KIT
92	SERIAL NUMBERS
94	COLOUR LABEL
95	AIR CLEANER
96	CRANKCASE BREATHER
97	ENGINE OIL
101	ENGINE OIL STRAINER SCREEN
103	SPARK PLUG
106	COOLANT
107	THROTTLE OPERATION
107	FRONT AND REAR SUSPENSION INSPECTION
108	SIDE STAND
109	BRAKE PAD WEAR

page

110	BRAKE SHOE WEAR
111	BATTERY
114	FUSE REPLACEMENT
116	BULB REPLACEMENT
<b>124</b>	<b>CLEANING</b>
<b>128</b>	<b>STORAGE GUIDE</b>
128	STORAGE
130	REMOVAL FROM STORAGE
<b>131</b>	<b>TAKING CARE OF THE UNEXPECTED</b>
<b>132</b>	<b>SPECIFICATIONS</b>
<b>136</b>	<b>CATALYTIC CONVERTER</b>

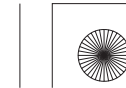



## **SCOOTER SAFETY**

### **IMPORTANT SAFETY INFORMATION**

Your scooter can provide many years of service and pleasure – if you take responsibility for your own safety and understand the challenges that you can meet on the road.

There is much that you can do to protect yourself when you ride. You'll find many helpful recommendations throughout this manual. Following are a few that we consider to be most important.

### **Always Wear a Helmet**

It's a proven fact: helmets significantly reduce the number and severity of head injuries. So always wear an approved motorcycle helmet and make sure your passenger does the same. We also recommend that you wear eye protection, sturdy boots, gloves, and other protective gear (page 2 ).

### **Make Yourself Easy to See**

Some drivers do not see scooters because they are not looking for them. To make yourself more visible, wear bright reflective clothing, position yourself so other drivers can see you, signal before turning or changing lanes, and use your horn when it will help others notice you.

### **Ride Within Your Limits**

Pushing the limits is another major cause of scooter crashes. Never ride beyond your personal abilities or faster than conditions warrant. Remember that alcohol, drugs, fatigue and inattention can significantly reduce your ability to make good judgements and ride safely.

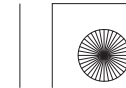



### **Don't Drink and Ride**

Alcohol and riding don't mix. Even one drink can reduce your ability to respond to changing conditions, and your reaction time gets worse with every additional drink. So don't drink and ride, and don't let your friends drink and ride either.

### **Keep Your Bike in Safe Condition**

For safe riding, it's important to inspect your scooter before every ride and perform all recommended maintenance. Never exceed load limits, and only use accessories that have been approved by Honda for this scooter. See page 5 for more details.



### **PROTECTIVE APPAREL**

For your safety, we strongly recommend that you always wear an approved motorcycle helmet, eye protection, boots, gloves, trousers, and a long-sleeved shirt or jacket whenever you ride. Although complete protection is not possible, wearing proper gear can reduce the chance of injury when you ride.

Following are suggestions to help you choose proper gear.



### **⚠ WARNING**

Not wearing a helmet increases the chance of serious injury or death in a crash.

Be sure you and your passenger always wear a helmet, eye protection and other protective apparel when you ride.

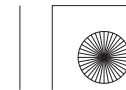



### **Helmets and Eye Protection**

Your helmet is your most important piece of riding gear because it offers the best protection against head injuries. A helmet should fit your head comfortably and securely. A bright-coloured helmet can make you more noticeable in traffic, as can reflective strips.

An open-face helmet offers some protection, but a full-face helmet offers more. Always wear a face shield or goggles to protect your eyes and help your vision.

### **Additional Riding Gear**

In addition to a helmet and eye protection, we also recommend:

- Sturdy boots with non-slip soles to help protect your feet and ankles.
- Leather gloves to keep your hands warm and help prevent blisters, cuts, burns and bruises.
- A motorcycle riding suit or jacket for comfort as well as protection. Bright-coloured and reflective clothing can help make you more noticeable in traffic. Be sure to avoid loose clothes that could get caught on any part of your scooter.

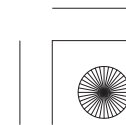
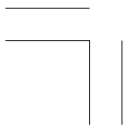



**ALWAYS** wear a helmet.  
You should also wear a face shield or goggles.

Wear bright or reflective clothing.

Clothes should be close-fitting.

Wear gloves.

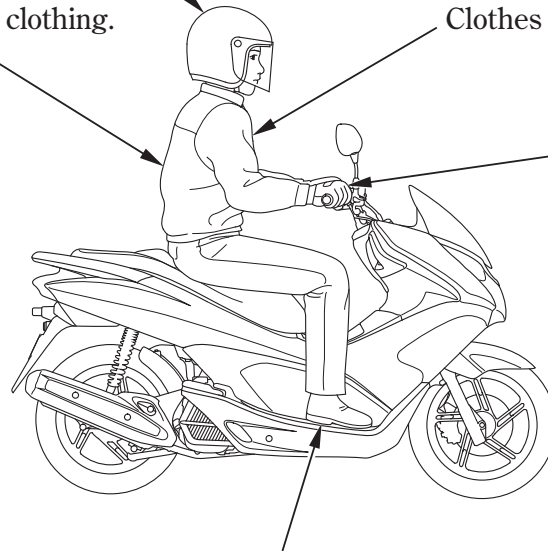

Shoes should be close-fitting, have low heels and offer ankle protection.

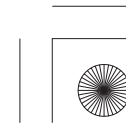



## LOAD LIMITS AND GUIDELINES

Your scooter has been designed to carry you, one passenger and a limited amount of cargo. When you add cargo or carry a passenger, you may feel some difference during acceleration and braking. But so long as you keep your scooter well-maintained, with good tyres and brakes, you can safely carry loads within the given limits and guidelines.



However, exceeding the weight limit or carrying an unbalanced load can seriously affect your scooter's handling, braking and stability. Non-Honda accessories, improper modifications, and poor maintenance can also reduce your safety margin.

The following pages give more specific information on loading, accessories and modifications.

## Loading

How much weight you put on your scooter, and how you load it, are important to your safety. Anytime you ride with a passenger or cargo you should be aware of the following information.

### **WARNING**

Overloading or improper loading can cause a crash and you can be seriously hurt or killed.

Follow all load limits and other loading guidelines in this manual.



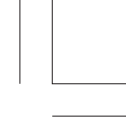

### Load Limits

Following are the load limits for your scooter:

**Maximum weight capacity:**

180 kg (397 lb) ... Except KO type

152 kg (335 lb) ... KO type only

Includes the weight of the rider, passenger, all cargo and all accessories

**Maximum cargo weight:**

13 kg (29 lb) ... Except KO type

11 kg (24 lb) ... KO type only

The weight of added accessories will reduce the maximum cargo weight you can carry.



Putting too much weight in individual storage compartments can also affect stability and handling. So be sure to stay within the limits given below:



**Maximum weight:**

- in center compartment** 10 kg (22 lb)
- in glove box** 1.0 kg (2.2 lb)

Glove box:  
weight limit:  
1.0 kg (2.2 lb)

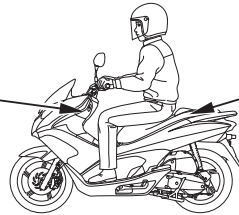

Center compartment:  
weight limit:  
10 kg (22 lb)







### Loading Guidelines

Your scooter is primarily intended for transporting you and a passenger. You may wish to secure a jacket or other small items to the seat when you are not riding with a passenger.

If you wish to carry more cargo, check with your Honda dealer for advice, and be sure to read the information regarding accessories on page 8 .

Improperly loading your scooter can affect its stability and handling. Even if your scooter is properly loaded, you should ride at reduced speeds whenever carrying cargo.

Follow these guidelines whenever you carry a passenger or cargo:

- Check that both tyres are properly inflated (page39).
- To prevent loose items from creating a hazard, make sure the center compartment, glove box is closed and that any other cargo is securely tied down before you ride away.
- Place cargo weight as close to the center of the scooter as possible.
- Balance cargo weight evenly on both sides.

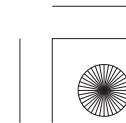
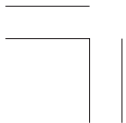



### Accessories and Modifications

Modifying your scooter or using non-Honda accessories can make your scooter unsafe. Before you consider making any modifications or adding an accessory, be sure to read the following information.

#### **WARNING**

Improper accessories or modifications can cause a crash in which you can be seriously hurt or killed.

Follow all instructions in this owner's manual regarding accessories and modifications.

### Accessories

We strongly recommend that you use only Honda Genuine Accessories that have been specifically designed and tested for your scooter. Because Honda cannot test all other accessories, you must be personally responsible for proper selection, installation and use of non-Honda accessories. Check with your dealer for assistance and always follow these guidelines:

- Make sure the accessory does not obscure any lights, reduce ground clearance and banking angle, limit suspension travel or steering travel, alter your riding position or interfere with operating any controls.
- Be sure electrical equipment does not exceed the scooter's electrical system capacity (page 135 ). A blown fuse can cause a loss of lights or engine power.





- Do not pull a trailer or sidecar with your scooter. This scooter was not designed for these attachments, and their use can seriously impair your scooter's handling.

### **Modifications**

We strongly advise you not to remove any original equipment or modify your scooter in any way that would change its design or operation. Such changes could seriously impair your scooter's handling, stability and braking, making it unsafe to ride.

Removing or modifying your lights, mufflers, emission control system or other equipment can also make your scooter illegal.

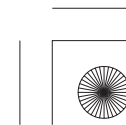
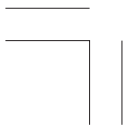

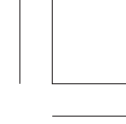

### IMAGE LABELS

〈Except KO type〉



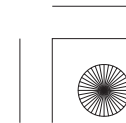
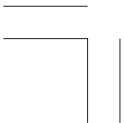

The following pages describe the label meanings. Some labels warn you of potential hazards that could cause serious injury. Others provide important safety information. Read this information carefully and don't remove the labels.

There is a specific symbol on each label. The meanings of each symbol and label are as follows.

If a label comes off or becomes hard to read, contact your Honda dealer for a replacement.





	Read instructions contained in Owner's Manual carefully.
	Read instructions contained in Shop Manual carefully. In the interest of safety, take the motorcycle to be serviced only by a Honda dealer.
	<b>DANGER (with RED background)</b> You <b>WILL</b> be <b>KILLED</b> or <b>SERIOUSLY HURT</b> if you don't follow instructions.
	<b>WARNING (with ORANGE background)</b> You <b>CAN</b> be <b>KILLED</b> or <b>SERIOUSLY HURT</b> if you don't follow instructions.
	<b>CAUTION (with YELLOW background)</b> You <b>CAN</b> be <b>HURT</b> if you don't follow instructions.





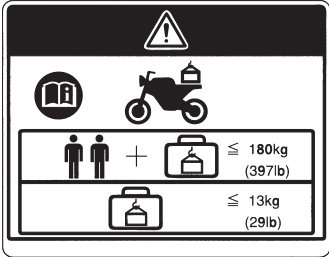







	<p><b>RADIATOR CAP LABEL</b>  <b>DANGER</b>  <b>NEVER OPEN WHEN HOT.</b>          Hot coolant will scald you.          Relief pressure valve begins to open at 1.1 kgf/cm<sup>2</sup>.</p>
	<p><b>ACCESSORIES AND LOADING WARNING LABEL</b>  <b>WARNING</b>  <b>ACCESSORIES AND LOADING</b></p> <ul style="list-style-type: none"> <li>• The safety stability and handling of this motorcycle may be affected by the addition of accessories and luggage.</li> <li>• Read carefully the instructions contained in user's manual and installation guide before installing any accessory.</li> <li>• The total weight of accessories and luggage added to rider's and passenger's weight should not exceed 180 kg (397 lb) , which is the maximum weight capacity.</li> <li>• The luggage weight must not exceed 13 kg (29 lb) under any circumstances.</li> <li>• The fitting of large fork-mounted or large handlebar-mounted fairing is not recommended.</li> </ul>





  	 <b>200</b>  <b>225</b>
	<b>kPa</b>  <b>200</b>  <b>250</b>
	
<b>90/90-14M/C 46P</b> SS-560F	<b>100/90-14M/C 57P</b> SS-560R

**TYRE INFORMATION LABEL**

Cold tyre pressure:

[Driver only]  
 Front 200 kPa (2.00 kgf/cm<sup>2</sup>, 29 psi)  
 Rear 225 kPa (2.25 kgf/cm<sup>2</sup>, 33 psi)

[Driver and passenger]  
 Front 200 kPa (2.00 kgf/cm<sup>2</sup>, 29 psi)  
 Rear 250 kPa (2.50 kgf/cm<sup>2</sup>, 36 psi)

Tyre size:  
 Front 90/90-14M/C 46P  
 Rear 100/90-14M/C 57P

Tyre brand: IRC  
 Front SS-560F  
 Rear SS-560R

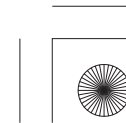
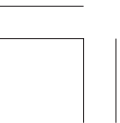



	<b>SAFETY REMINDER LABEL</b> For your protection, always wear helmet and protective gear.
	<b>FUEL LABEL &lt; E, F, ED type only &gt;</b> UNLEADED PETROL ONLY
	<b>CARGO LIMIT LABEL</b> Do not exceed 10 kg (22 lb) .
	<b>CARGO LIMIT LABEL</b> Do not exceed 1.0 kg (2.2 lb) .

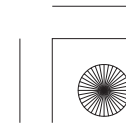





## PARTS LOCATION

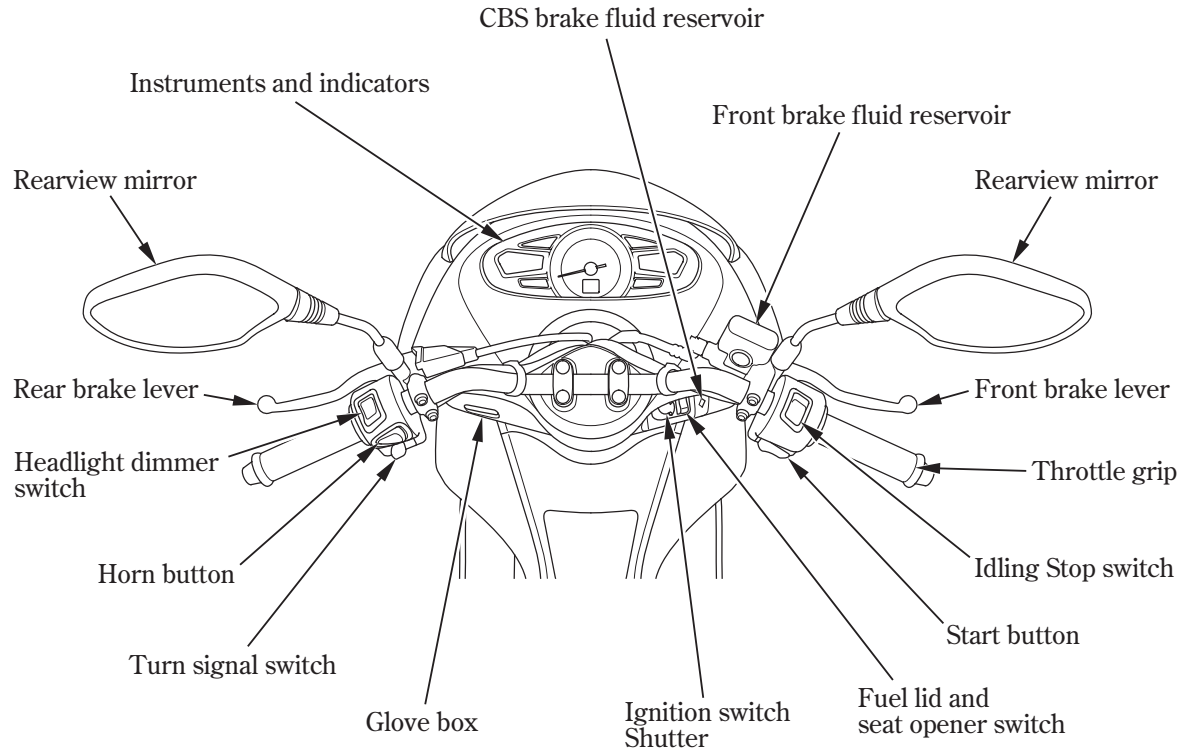

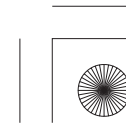
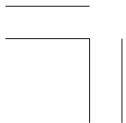
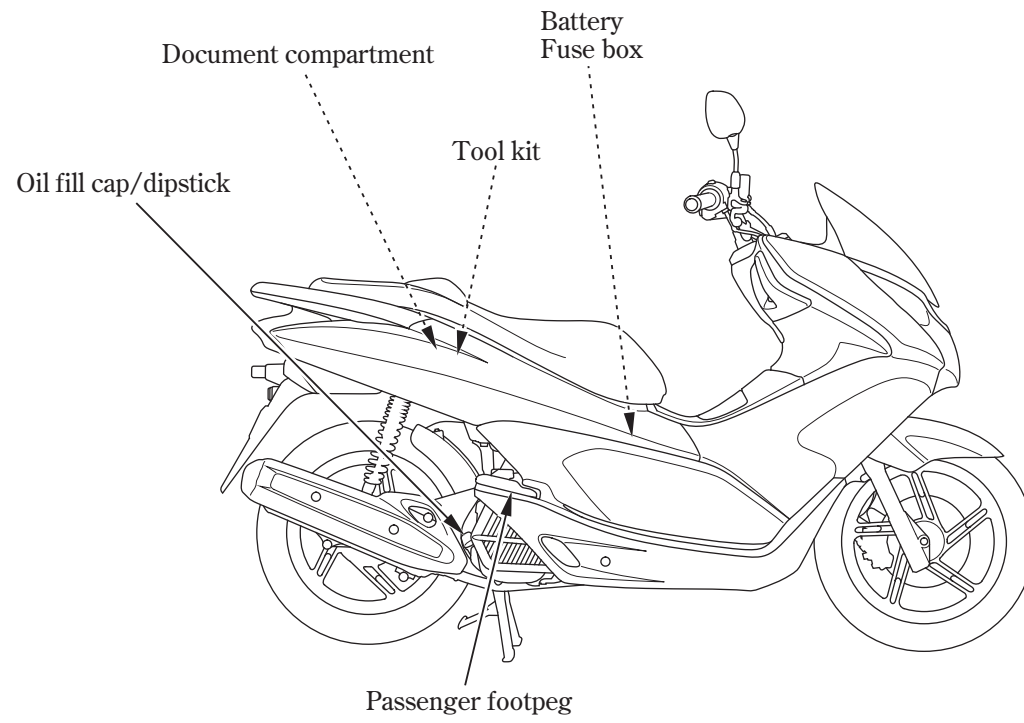

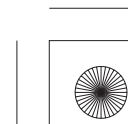
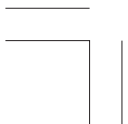
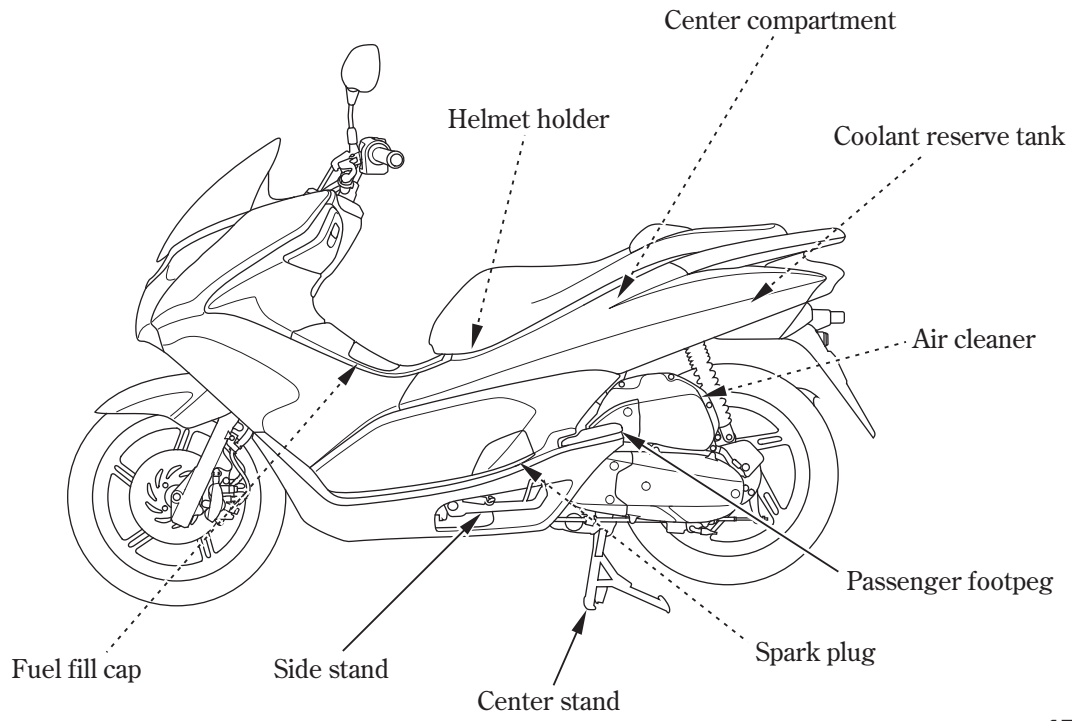

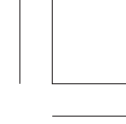

## INSTRUMENTS AND INDICATORS

The indicators are contained in the instrument panel. Their functions are described in the tables on the following pages.

- (1) Mode switch
- (2) High coolant temperature indicator
- (3) Left turn signal indicator
- (4) Speedometer
- (5) Right turn signal indicator
- (6) Odometer/Tripmeter/Fuel gauge display
- (7) PGM-FI malfunction indicator lamp (MIL)
- (8) High beam indicator
- (9) STAND BY indicator

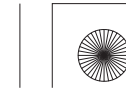
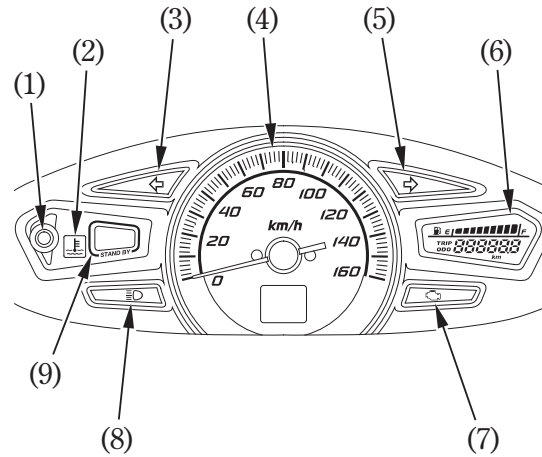



<b>(Ref.No.) Description</b>	<b>Function</b>
(1) Mode switch	Resets the tripmeter or selects the operation mode: tripmeter or odometer (page 24 ).
(2) High coolant temperature indicator (red)	<p>Lights when the coolant is over the specified temperature. If the indicator goes on while riding, stop the engine and check the reserve tank coolant level. Read pages 33 – 34 and do not ride the scooter until the problem has been corrected.</p> <p><b>NOTICE</b> Exceeding maximum running temperature may cause serious engine damage.</p>

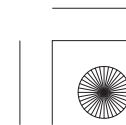
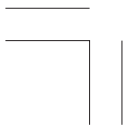



<b>(Ref.No.) Description</b>	<b>Function</b>
(3) Left turn signal indicator (green)	Flashes when the left turn signal operates.
(4) Speedometer	Shows riding speed. This shows your speed in kilometers per hour (km/h) and/or miles per hour (mph) depending on the type. The speedometer needle will swing to the maximum scale on the dial once when the ignition switch is turned ON.

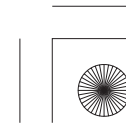
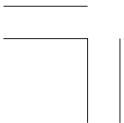



<b>(Ref.No.) Description</b>	<b>Function</b>
(5) Right turn signal indicator (green)	Flashes when the right turn signal operates.
(6) Odometer/Tripmeter/ Fuel gauge display	The display includes the following functions; This display shows the initial display (page 23 ).
Odometer	Shows accumulated mileage (page 24 ).
Tripmeter	Shows mileage per trip (page 24 ).
Fuel gauge	Shows approximate fuel supply available (page 26 ).
(7) PGM-FI malfunction indicator lamp (MIL) (amber)	Lights when there is any abnormality in the PGM-FI (Programmed Fuel Injection) system. Should also light for a few seconds and then go off when the ignition switch is turned ON. If it comes on at any other time, reduce speed and take the scooter to your Honda dealer as soon as possible.

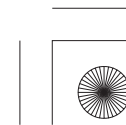
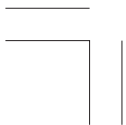



<b>(Ref.No.) Description</b>	<b>Function</b>
(8) High beam indicator (blue)	Lights when the headlight is on high beam.
(9) STAND BY indicator (amber)	Flashes when the Idling Stop system is activated (page 52 ). If you get off the scooter (without sitting) while the engine is stopping by the Idling Stop system, the STAND BY indicator will go out, and for about 3 minutes later, the Idling Stop system will be cancelled.

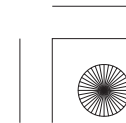





10/02/17 16:53:11 32KWN600\_033



### Initial Display

When the ignition switch is turned ON, the display will temporarily show all the modes and digital segments so you can make sure the liquid crystal display is functioning properly.

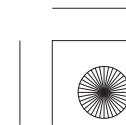
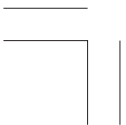
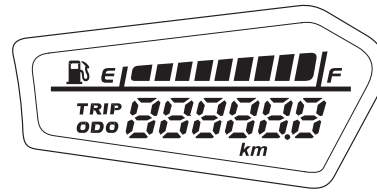



### Odometer/Tripmeter/Fuel Gauge Display

The display (1) has three functions, odometer, tripmeter and fuel gauge.

Except E type: Odometer and tripmeter read in kilometers.

E type: Odometer and tripmeter read in miles.

Push the mode switch (2) to select the "ODO" or "TRIP" mode.

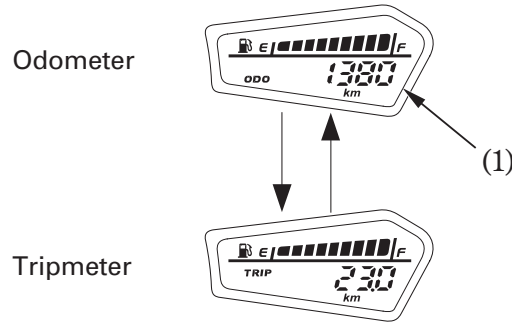

(1) Odometer/Tripmeter/Fuel gauge display

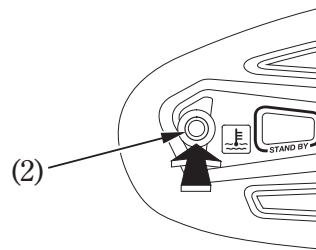

(2) Mode switch

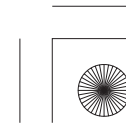



To reset the tripmeter, push and hold the mode switch for more than 2 seconds, with the display in the “TRIP” mode.

Tripmeter reset

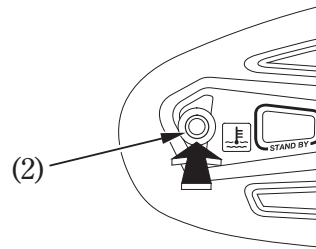
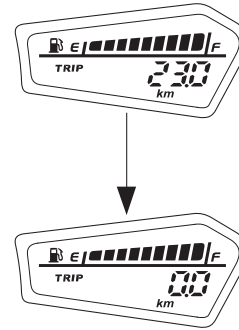

(2) Mode switch

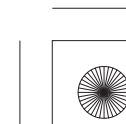
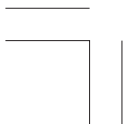



### Fuel Gauge

The fuel gauge liquid crystal display (1) shows the approximate available fuel in a graduated display. When all segments up to F (2) are on, the fuel tank is full.

The fuel tank capacity is:

6.1 l (1.61 US gal , 1.34 Imp gal)

When there is only one segment (3) left, fuel will be low and you should refuel as soon as possible.

The amount of fuel left in the tank with the vehicle set upright is approximately:

1.5 l (0.40 US gal , 0.33 Imp gal)

This segment flashes when the fuel decreases further.

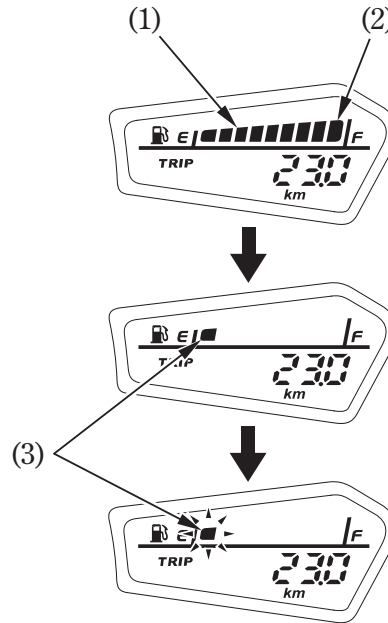

- (1) Fuel gauge
- (2) Segment F
- (3) Segment E

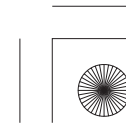
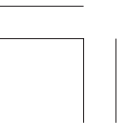

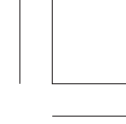

## **MAJOR COMPONENTS** **(Information you need to operate this scooter)**

### **BRAKES**

#### **Combined Brake System (CBS)**

This scooter is equipped with a Combined Brake System. Operating the rear brake lever applies the rear brake and a portion of the front brake. For full braking effectiveness, use both the front and rear brake lever simultaneously, as you would with a conventional scooter braking system.



As with a conventional scooter braking system, excessively hard application of the brake controls may cause wheel lock, reducing control of the scooter.



For normal braking, apply both the front and rear brake lever to match your road speed. For maximum braking, close the throttle and firmly apply the front and rear brake lever.

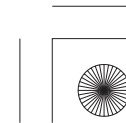
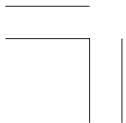



### Front Brake

This scooter has a hydraulic front disc brake.

As the brake pads wear, brake fluid level drops.

There are no adjustments to perform, but fluid level and pad wear must be inspected periodically. The system must be inspected frequently to ensure there are no fluid leaks. If the control lever free travel becomes excessive and the brake pads are not worn beyond the recommended limit (page 109), there is probably air in the brake system and it must be bled. See your Honda dealer for this service.

#### Front Brake Fluid Level:

With the scooter in an upright position, check the fluid level. It should be above the LOWER level mark (1). If the level is at or below the LOWER level mark, check the brake pads for wear (page 109 ).

Worn pads should be replaced. If the pads are not worn, have your brake system inspected for leaks.

The recommended brake fluid is Honda DOT 3 or DOT 4 brake fluid from a sealed container, or an equivalent.

#### Other Checks:

Make sure there are no fluid leaks. Check for deterioration or cracks in the hoses and fittings.

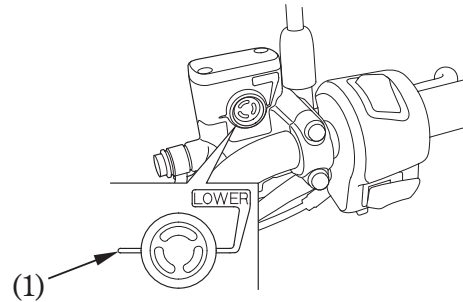

(1) LOWER level mark

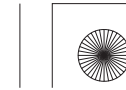



CBS Brake Fluid Level:

With the scooter in an upright position, check the fluid level. It should be between the UPPER (1) and LOWER (2) level marks. If the level is at or below the LOWER level mark, check the brake pads for wear (page109).

Worn pads should be replaced. If the pads are not worn, have your brake system inspected for leaks.

The recommended brake fluid is Honda DOT 3 or DOT 4 brake fluid from a sealed container, or an equivalent.

Other Checks:

Make sure there are no fluid leaks. Check for deterioration or cracks in the hoses and fittings.

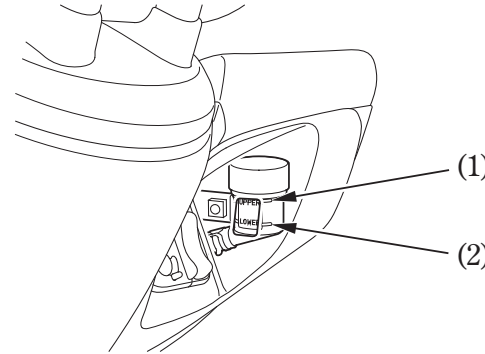

- (1) UPPER level mark
- (2) LOWER level mark

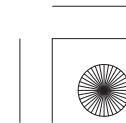



### Rear Brake

Adjust the freeplay of the brake lever with the front wheel pointed straight ahead.

#### Adjustment:

1. Place the scooter on its center stand.
2. Measure the distance the rear brake lever (1) moves before the brake starts to take hold.

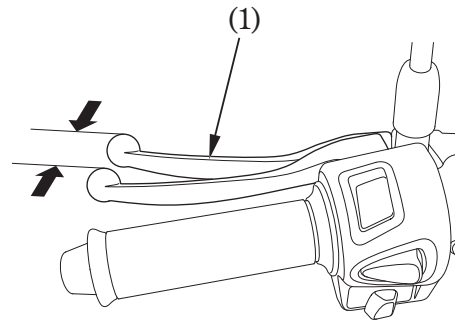

Freeplay at the tip of the brake lever should be:

10–20 mm (0.4–0.8 in)



(1) Rear brake lever

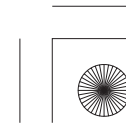
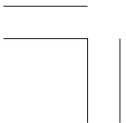





3. If adjustment is necessary, turn the rear brake adjusting nut (2).

Adjust by turning the rear brake adjusting nut a half-turn at a time. Make sure the cut-out on the adjusting nut is seated on the brake arm pin (3) after making final freeplay adjustment.

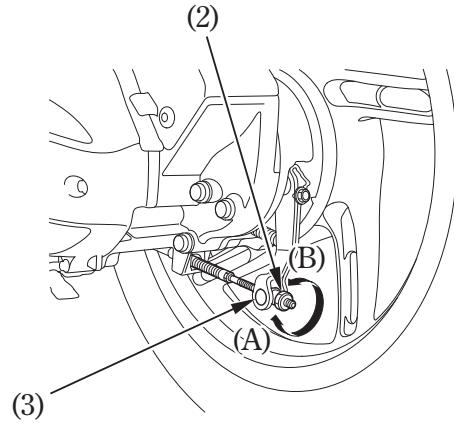

4. Apply the brake several times and check for free wheel rotation after the brake lever is released.

If proper adjustment cannot be obtained by this method, see your Honda dealer.

- (2) Rear brake adjusting nut
- (3) Brake arm pin
- (A) Decrease freeplay
- (B) Increase freeplay





After adjustment, push the brake arm (4) to confirm that there is a gap between the rear brake adjusting nut (2) and the brake arm pin (3).

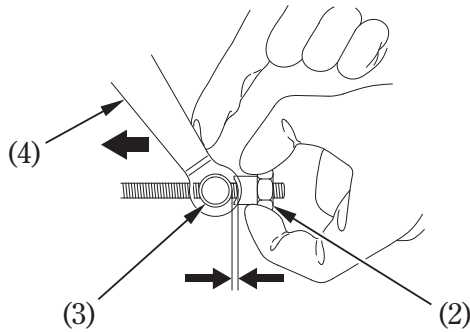

- (2) Rear brake adjusting nut
- (3) Brake arm pin
- (4) Brake arm

After adjustment, confirm the freeplay of the brake lever.

**32**

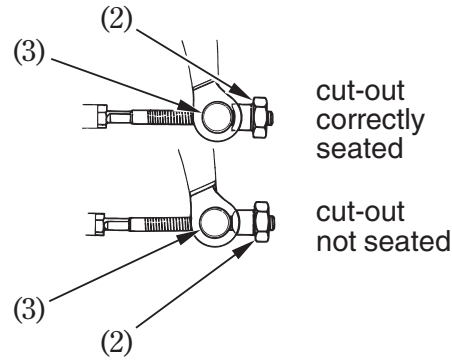

Other Checks:

Check the brake cable for kinks or signs of wear that could cause sticking or failure. Lubricate the brake cable with a commercially available cable lubricant to prevent premature wear and corrosion. Make sure the brake arm, spring and fasteners are in good condition.

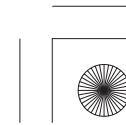



**COOLANT**  
**Coolant Recommendation**

The owner must properly maintain the coolant to prevent freezing, overheating, and corrosion. Use only high quality ethylene glycol antifreeze containing corrosion protection inhibitors specifically recommended for use in aluminum engines. (SEE ANTIFREEZE CONTAINER LABEL).



Use only low-mineral drinking water or distilled water as a part of the antifreeze solution. Water that is high in mineral content or salt may be harmful to the aluminum engine.

Using coolant with silicate inhibitors may cause premature wear of water pump seals or blockage of radiator passages.

Using tap water may cause engine damage.

The factory provides a 50/50 solution of antifreeze and distilled water in this scooter. This coolant solution is recommended for most operating temperatures and provides good corrosion protection. A higher concentration of antifreeze decreases the cooling system performance and is recommended only when additional protection against freezing is needed. A concentration of less than 40/60 (40% antifreeze) will not provide proper corrosion protection. During freezing temperatures, check the cooling system frequently and add higher concentrations of antifreeze (up to a maximum of 60% antifreeze) if required.

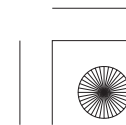
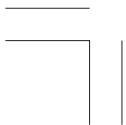



### Inspection

The reserve tank (1) is in the center compartment.

Open the seat (page 47) and check the coolant level in the reserve tank while the engine is at the normal operating temperature with the scooter in an upright position. If the coolant level is below the LOWER level mark (2), remove the clip (3) (page 66) and coolant reserve tank lid (4). Open the reserve tank cap (5) and add coolant mixture until it reaches the UPPER level mark (6).

Always add coolant to the reserve tank. Do not attempt to add coolant by removing the radiator cap.

If the reserve tank is empty, or if coolant loss is excessive, check for leaks and see your Honda dealer for repair.

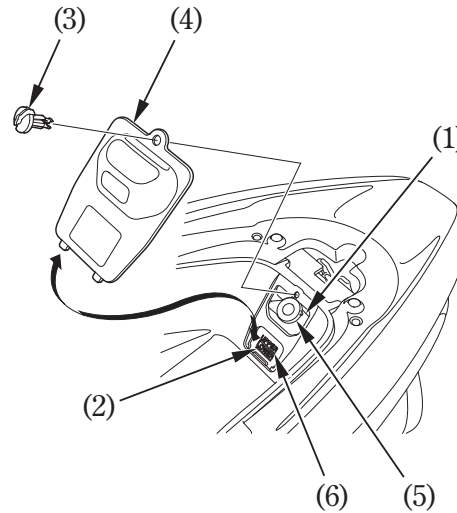

- |                      |                      |
|----------------------|----------------------|
| (1) Reserve tank     | (4) Reserve tank lid |
| (2) LOWER level mark | (5) Reserve tank cap |
| (3) Clip             | (6) UPPER level mark |

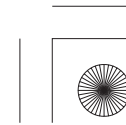



## FUEL Fuel Tank

The fuel tank is located behind the fuel lid.  
Fuel tank capacity is:

6.1 ℓ (1.61 US gal , 1.34 Imp gal)

Open the fuel lid (1) (page 46). Remove the fuel fill cap (2) by turning it counterclockwise.

Do not overfill the tank. There should be no fuel in the level plate (3).

After refueling, be sure to tighten the fuel fill cap firmly by turning it clockwise.

Make sure that the arrow marks (4) on the fuel fill cap and fuel tank is aligned.

Close the fuel lid.

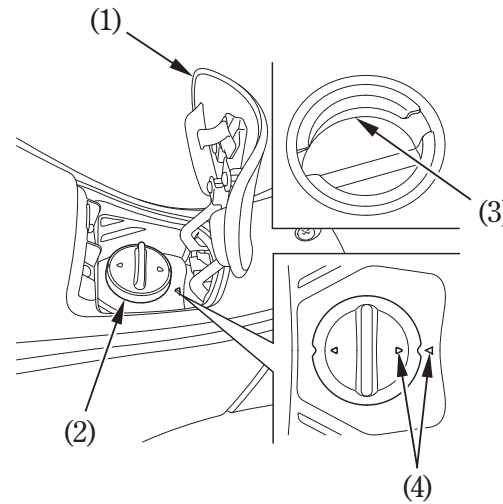

### **⚠ WARNING**

Petrol is highly flammable and explosive. You can be burned or seriously injured when handling fuel.

- Stop the engine and keep heat, sparks, and flame away.
- Refuel only outdoors.
- Wipe up spills immediately.

- (1) Fuel lid
- (2) Fuel fill cap
- (3) Level plate
- (4) Arrow marks

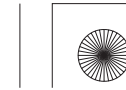



10/02/17 16:54:23 32KWN600\_046

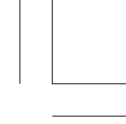

Use unleaded petrol with a research octane number of 91 or higher.

The use of leaded petrol will cause premature damage to the catalytic converter.

**NOTICE**

If “spark knock” or “pinking” occurs at a steady engine speed under normal load, change brands of petrol. If spark knock or pinking persists, consult your Honda dealer. Failure to do so is considered misuse, and damage caused by misuse is not covered by Honda’s Limited Warranty.

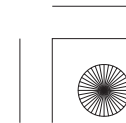
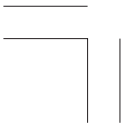



### **Petrol Containing Alcohol**

If you decide to use a petrol containing alcohol (gasohol), be sure it's octane rating is at least as high as that recommended by Honda. There are two types of "gasohol": one containing ethanol, and the other containing methanol. Do not use petrol that contains more than 10 % ethanol. Do not use petrol containing methanol (methyl or wood alcohol) that does not also contain cosolvents and corrosion inhibitors for methanol. Never use petrol containing more than 5 % methanol, even if it has cosolvents and corrosion inhibitors.

The use of petrol containing more than 10 % ethanol (or more than 5 % methanol) may:

- Damage the painting of the fuel tank.
- Damage the rubber tubes of the fuel line.
- Cause corrosion of the fuel tank.
- Cause poor drivability.

Before buying fuel from an unfamiliar station, try to find out if the fuel contains alcohol. If it does, confirm the type and percentage of alcohol used. If you notice any undesirable operating symptoms while using a petrol that contains alcohol, or one that you think contains alcohol, switch to a petrol that you know does not contain alcohol.

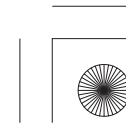
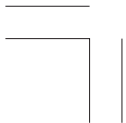



## ENGINE OIL

### Engine Oil Level Check

Check the engine oil level each day before riding the scooter.

The level must be maintained between the upper (1) and lower (2) level marks on the oil fill cap/dipstick (3).

1. Start the engine and let it idle for 3–5 minutes.
2. Stop the engine and put the scooter on its center stand on level ground.
3. After 2–3 minutes, remove the oil fill cap/dipstick, wipe it clean, and reinsert the oil fill cap/dipstick without screwing it in. Remove the oil fill cap/dipstick. The oil level should be between the upper and lower level marks on the oil fill cap/dipstick.
4. If required, add the specified oil (see page 97 ) up to the upper level mark. Do not overfill.

5. Reinstall the oil fill cap/dipstick. Check for oil leaks.

#### NOTICE

Running the engine with insufficient oil pressure may cause serious engine damage.

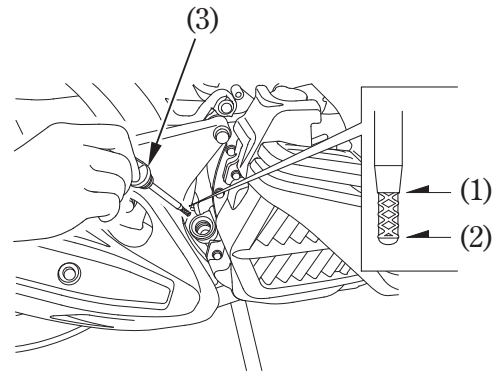

- (1) Upper level mark
- (2) Lower level mark
- (3) Oil fill cap/dipstick







### **TUBELESS TYRES**

To safely operate your scooter, your tyres must be the proper type and size, in good condition with adequate tread, and correctly inflated for the load you are carrying. The following pages give more detailed information on how and when to check your air pressure, how to inspect your tyres for damage, and what to do when your tyres need to be repaired or replaced.



### **⚠ WARNING**

Using tyres that are excessively worn or improperly inflated can cause a crash in which you can be seriously hurt or killed.

Follow all instructions in this owner's manual regarding tyre inflation and maintenance.

### **Air Pressure**

Keeping your tyres properly inflated provides the best combination of handling, tread life and riding comfort. Generally, underinflated tyres wear unevenly, adversely affect handling, and are more likely to fail from being overheated.

Overinflated tyres make your scooter ride harshly, are more prone to damage from road hazards, and wear unevenly.

We recommend that you visually check your tyres before every ride and use a gauge to measure air pressure at least once a month or any time you think the tyres might be low.

Tubeless tyres have some self-sealing ability if they are punctured. However, because leakage is often very slow, you should look closely for punctures whenever a tyre is not fully inflated.

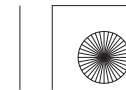

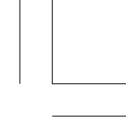

Always check air pressure when your tyres are “cold” – when the scooter has been parked for at least three hours. If you check air pressure when your tyres are “warm” – when the scooter has been ridden for even a few miles – the readings will be higher than if the tyres were “cold”. This is normal, so do not let air out of the tyres to match the recommended cold air pressures given below. If you do, the tyres will be underinflated.

The recommended “cold” tyre pressures are:

kPa (kgf/cm <sup>2</sup> , psi)		
Driver only	Front	200 (2.00 , 29)
	Rear	225 (2.25 , 33)
Driver and one passenger	Front	200 (2.00 , 29)
	Rear	250 (2.50 , 36)

**Inspection**

Whenever you check the tyre pressures, you should also examine the tyre treads and sidewalls for wear, damage, and foreign objects:

Look for:

- Bumps or bulges in the side of the tyre or the tread. Replace the tyre if you find any bumps or bulges.
- Cuts, splits or cracks in the tyre. Replace the tyre if you can see fabric or cord.
- Excessive tread wear.

Also, if you hit a pothole or hard object, pull to the side of the road as soon as you can safely and carefully inspect the tyres for damage.

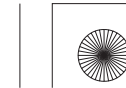



### Tread Wear

Replace tyres immediately when the wear indicator (1) appears at on the tyre.

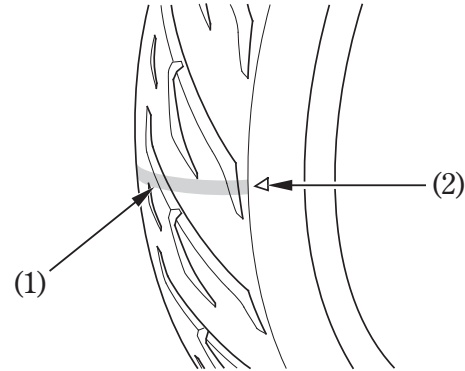

- (1) Wear indicator
- (2) Wear indicator location mark

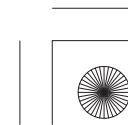
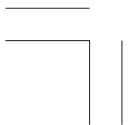



### **Tyre Repair**

If a tyre is punctured or damaged, you should replace it, not repair it. As discussed below, a tyre that is repaired, either temporarily or permanently, will have lower speed and performance limits than a new tyre.

A temporary repair, such as an external tubeless tyre plug, may not be safe for normal speeds and riding conditions. If a temporary or emergency repair is made to a tyre, you should ride slowly and cautiously to a dealer and have the tyre replaced. If possible, you should not carry a passenger or cargo until a new tyre is installed.

Even if a tyre is professionally repaired with a permanent internal patch plug, it will not be as good as a new tyre. You should not exceed 80 km/h (50 mph) for the first 24 hours, or 130 km/h (80 mph) at any time thereafter. In addition, you may not be able to safely carry as much weight as with a new tyre. Therefore, we strongly recommend that you replace a damaged tyre. If you choose to have a tyre repaired, be sure the wheel is balanced before you ride.

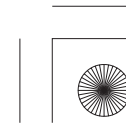
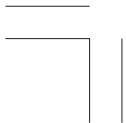



### Tyre Replacement

The tyres that came on your scooter were designed to match the performance capabilities of your scooter and provide the best combination of handling, braking, durability and comfort.

### WARNING

Installing improper tyres on your scooter can affect handling and stability. This can cause a crash in which you can be seriously hurt or killed.

Always use the size and type of tyres recommended in this owner's manual.

The recommended tyres for your scooter are:

Front: 90/90-14M/C 46P  
IRC  
SS-560F

Rear: 100/90-14M/C 57P  
IRC  
SS-560R

Type: bias-ply, tubeless

Whenever you replace a tyre, use one that is equivalent to the original and be sure the wheel is balanced after the new tyre is installed.

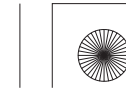

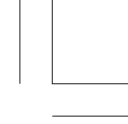

**Important Safety Reminders**

- Do not install a tube inside a tubeless tyre on this scooter. Excessive heat build-up can cause the tube to burst.
- Use only tubeless tyres on this scooter. The rims are designed for tubeless tyres, and during hard acceleration or braking, a tube-type tyre could slip on the rim and cause the tyre to rapidly deflate.

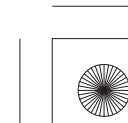
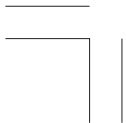



## ESSENTIAL INDIVIDUAL COMPONENTS

### IGNITION SWITCH

The ignition switch (1) is on the right side below the steering stem.

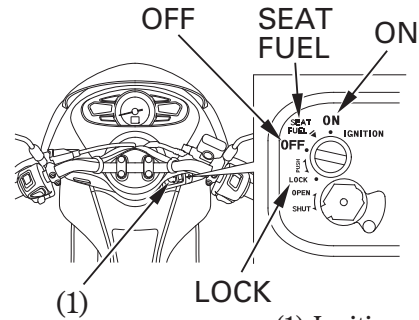

(1) Ignition switch

Key Position	Function	Key Removal
LOCK (Steering lock)	Steering is locked. Engine and lights cannot be operated.	Key can be removed
OFF	Engine and lights cannot be operated.	Key can be removed
SEAT FUEL	Fuel lid and seat opener switch can be operated. Engine and lights cannot be operated.	Key cannot be removed
ON	Engine can be operated. The brakelight, meter light, turn signals and horn can be operated. The headlight operates only when the engine is running.	Key cannot be removed





## FUEL LID AND SEAT OPENER SWITCH

If the ignition switch is ON or OFF position, fuel lid and seat opener switch (1) will not operate.

### Fuel Lid

#### Open the Fuel Lid:

1. Insert the ignition key (2) and turn it to the position of "SEAT FUEL" (3).
2. Push the "FUEL" (4) side of the fuel lid and seat opener switch.
3. Open the fuel lid (5).

#### Close the Fuel Lid:

Close the fuel lid until it locks. Make sure the fuel lid is secure before riding.

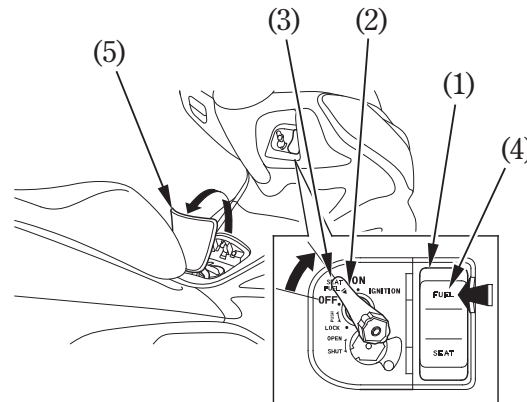

- (1) Fuel lid and seat opener switch  
(2) Ignition key

- (3) "SEAT FUEL"  
(4) "FUEL"  
(5) Fuel lid

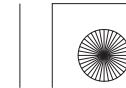





## Seat

### Open the Seat:

1. Turn the handlebar pointed straight ahead.
2. Insert the ignition key (1) and turn it to the position of "SEAT FUEL" (2).
3. Push the "SEAT" (3) side of the fuel lid and seat opener switch (4).
4. Open the seat (5).

### Close the Seat:

Close the seat, lower and push down until it locks. Make sure the seat is secure before riding.

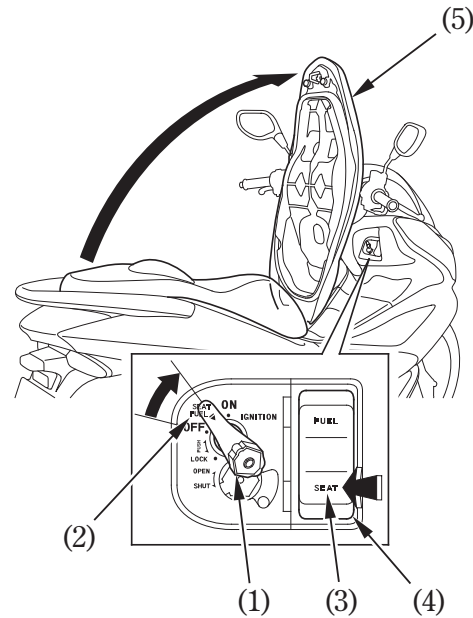

- (1) Ignition key  
(2) "SEAT FUEL"  
(3) "SEAT"

- (4) Fuel lid and  
seat opener switch  
(5) Seat

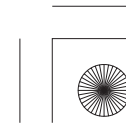

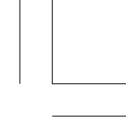

## RIGHT HANDLEBAR CONTROLS

### Start Button (1)

The start button is next to the throttle grip. When the start button is pressed, the starter motor cranks the engine. See page 68 for the starting procedure.

### Idling Stop Switch (2)

Push the Idling Stop switch to activate or deactivate the Idling Stop system. Refer to the “IDLING STOP SYSTEM” on page 52 .

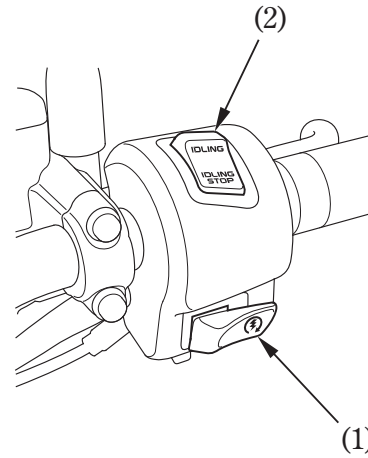

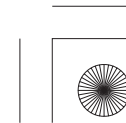
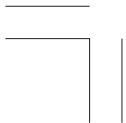

- (1) Start button
- (2) Idling Stop switch





## LEFT HANDLEBAR CONTROLS

### Headlight Dimmer Switch (1)

Push the dimmer switch to  (HI) to select high beam or to  (LO) to select low beam.

### Horn Button (2)

Press the button to sound the horn.

### Turn Signal Switch (3)

Move to  to signal a left turn,  to signal a right turn. Press to turn signal off.

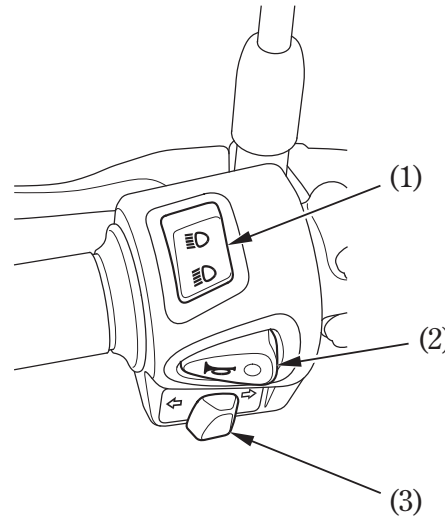

- (1) Headlight dimmer switch
- (2) Horn button
- (3) Turn signal switch

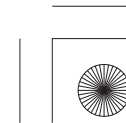



## FEATURES (Not required for operation)

### STEERING LOCK

The steering can be locked when the ignition switch (1) is in the "LOCK" position.

To lock the steering, turn the handlebars all the way to the left or right, turn the ignition key (2) to LOCK while pushing in. Remove the key.

To unlock the steering, turn the key to OFF while pushing in.

Do not turn the key to LOCK while riding the scooter; loss of vehicle control will result.

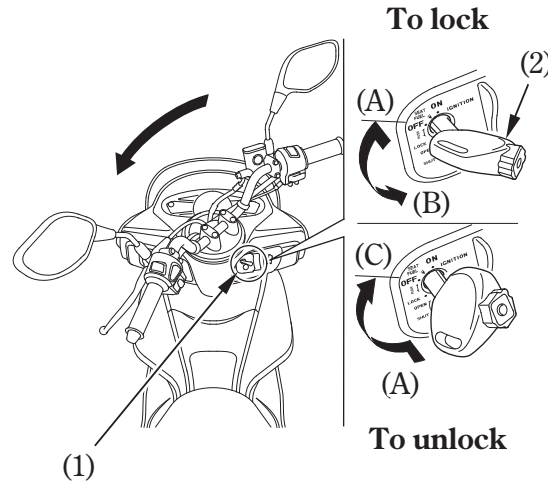

- (1) Ignition switch
- (2) Ignition key

- (A) Push in
- (B) Turn to LOCK
- (C) Turn to OFF





### SHUTTER

The ignition switch of this scooter is equipped with a shutter. After parking the scooter, close the shutter for theft prevention.

To close the shutter, ignition key (1) is removed, align the projection (2) of the shutter key (3) with the slot (4) of the shutter, and turn the shutter key counterclockwise or move the knob (5) upward.

To open the shutter, align the projection of the shutter key with the slot of the shutter, and turn the shutter key clockwise.

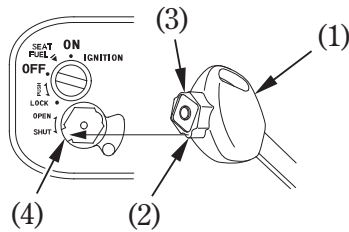

(1) Ignition key  
(2) Projection

(3) Shutter key  
(4) Slot

### < CLOSE >

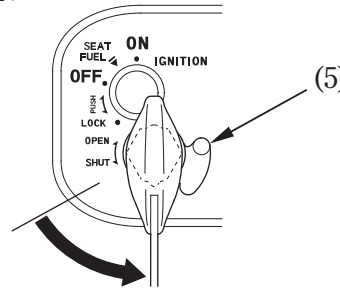

### < OPEN >

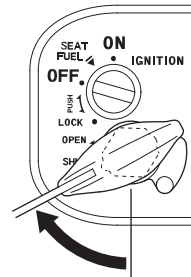

(5) Knob

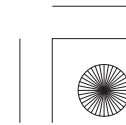

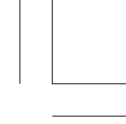

### **IDLING STOP SYSTEM**

This scooter is equipped with Idling Stop system. Idling Stop system is designed to help reduce the fuel consumption and noise, by idling stop while making a stop such as waiting at an intersection.

- Engine will stop by Idling Stop system, a few seconds after the scooter is stopped, with the throttle (1) completely closed.
- While Idling Stop system is working, the STAND BY indicator (2) flashes and the headlights get dark.
- Engine will start, when the throttle is opened.

You can change the Idling Stop system mode by switching the Idling Stop switch (3) (page 53).

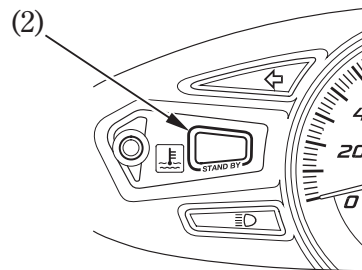
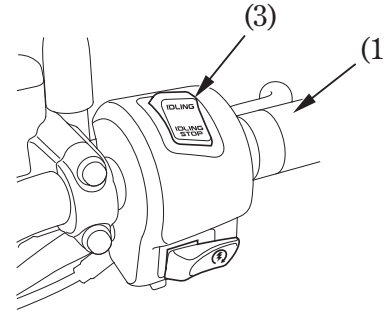

- (1) Throttle
- (2) STAND BY indicator
- (3) Idling Stop switch





### **Idling Stop System Operating Conditions**

Followings are requirements for the Idling Stop system to operate properly.

#### Before riding

- Put the side stand up.
- Warm up the engine. Idling Stop system does not operate, if the engine is not warmed up.
- Push the Idling Stop switch to the “**IDLING STOP**”.
- Ride the scooter at proper riding position. Idling Stop system is designed not to work when no load on the seat.

Ride the scooter at speed above 10 km/h (6 mph), to enable the Idling Stop system under above conditions.

#### After Stopping

- Close the throttle completely. Engine will not stop if the throttle is little opened.
- Stop the scooter completely. Engine will not stop if the speed is not at 0 km/h (0 mph).

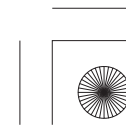
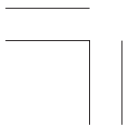



### Restart the Engine

- Check the STAND BY indicator. If it is not flashing, you can't restart the engine with the Idling Stop system, even if you open the throttle.
- If you get off the scooter (without sitting) while the engine is stopping by the Idling Stop system, the STAND BY indicator will go out, and for about 3 minutes later, the Idling Stop system will be cancelled and headlight will go out.
- If you lower the side stand, Idling Stop system will be cancelled.

To start the engine with the STAND BY indicator off, see starting procedure (page 68 ) for standard engine starting.

### NOTICE

Headlights stay on after the engine is stopped by the Idling Stop system. The battery may discharge and you may not be able to restart engine.

When the battery is weak, switch the Idling Stop switch to the “**IDLING**” and do not to use the Idling Stop system. See your Honda dealer to check the battery.

See your Honda dealer for checking the battery as specified in the maintenance schedule (page 90 ).

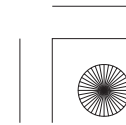





Always follow the precautions of Idling Stop system described below.

- Do not leave the scooter while the engine is stopped by the Idling Stop system. When you leave the scooter, always take the ignition key (1) with you.

- Do not push down on the seat while the engine is stopped by the Idling Stop system.

For example, push the seat down by hand or body, or put the luggage on the seat. The engine will start unexpectedly if the throttle is opened with loading on the seat.

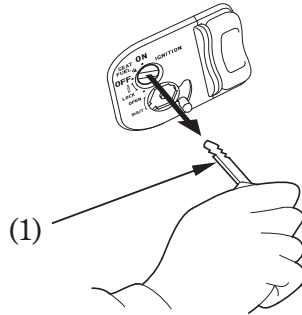

(1) Ignition key

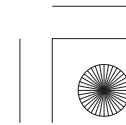
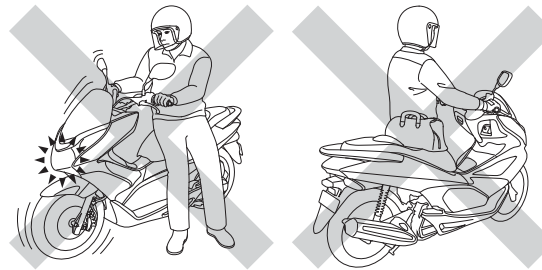



- Do not put excessive luggage in the center compartment. Luggage interfere with the seat to close.  
Idling Stop system does not operate without closing the seat completely.

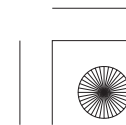
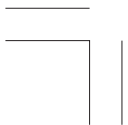
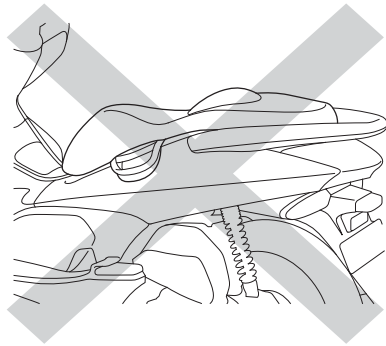



**When the Idling Stop system does not operate properly  
(Idling Stop switch is at “IDLING STOP” position)**

When the Idling Stop system does not operate properly, perform the followings.

Symptom	Possible cause	What to do
Engine does not stop by Idling Stop system	Idling Stop switch is at “IDLING”.	Push the Idling Stop switch to “IDLING STOP”.
	Engine is cold.	Warm up the engine.
	Scooter does not stop completely.	Stop the scooter completely. The Idling Stop system operates if the speed is only at 0 km/h (0 mph).
	Throttle is not closed completely.	Close the throttle completely.
	Did not ride the scooter after engine start.	Ride the scooter at speeds of over 10 km/h (6 mph). The Idling Stop system does not operate until you ride at once.





Symptom	Possible cause	What to do
Engine does not stop by Idling Stop system	Sitting wrong position.	Ride the scooter in proper riding position. Idling Stop system is designed not to work when no load on the seat.
	Excessive luggage in the center compartment.	Luggage interfere with the seat to close completely. Take out some luggage from the center compartment to close the seat completely.
	PGM-FI malfunction indicator lamp (MIL) lights.	When the PGM-FI malfunction indicator lamp (MIL) lights, the Idling Stop system does not operate for protection of the engine. See your Honda dealer.

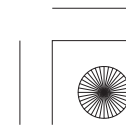
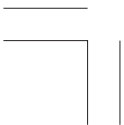



When the STAND BY indicator does not flash, perform the followings.

Symptom	Possible cause	What to do
Engine does not start even open the throttle	Riding in wrong position.	Ride the scooter in proper riding position. Idling Stop system is designed not to work when no load on the seat.
	Left the scooter for more than 3 minutes.	The Idling Stop system will be cancelled, if you get off the scooter for about 3 minutes (without sitting properly), while the engine is stopped by the Idling Stop system.
	Excessive luggage in the center compartment.	Luggage interfere with the seat to close completely. Take out some luggage from the center compartment, to close the seat completely.
	Side stand is down.	When you put down the side stand, Idling Stop system will be cancelled. See starting procedure (page 68 ) for standard engine starting.
	Idling Stop switch is at "IDLING".	When you push the Idling Stop switch to the "IDLING", the Idling Stop system will be cancelled.





10/02/17 16:56:47 32KWN600\_070

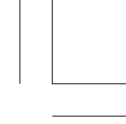

STAND BY indicator flashes, but engine does not start, perform the followings.

Symptom	Possible cause	What to do
Engine does not start even open the throttle	Low (or dead) battery or battery lead is loose.	Check the battery and battery terminals. If battery is weak, charge the battery.

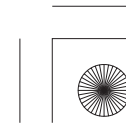
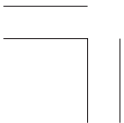



### HELMET HOLDER

The helmet holder (1) is on the left side below the seat. The helmet holder is designed to secure your helmet while parked.

Open the seat (page 47 ).

Route the helmet wire (2) through the helmet D-ring (3) and hook the loops of the helmet wire onto the helmet holder.

Close the seat and lock it securely.

The helmet wire is furnished in the tool kit (page 91 ).

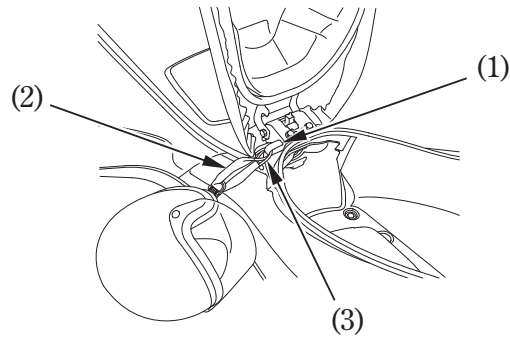

(1) Helmet holder  
(2) Helmet wire

(3) D-ring

## ⚠ WARNING

Riding with a helmet attached to the holder can interfere with the rear wheel or suspension and could cause a crash in which you can be seriously hurt or killed.

Use the helmet holder only while parked. Do not ride with a helmet secured by the holder.





### **CENTER COMPARTMENT**

The center compartment (1) is below the seat. Opening and closing:

See “FUEL LID AND SEAT OPENER SWITCH” (page 47 ).

### **MAXIMUM WEIGHT LIMIT:**

10 kg (22 lb)

Never exceed the maximum weight limit; handling and stability may be severely affected.

The center compartment may become heated by the engine. Do not store food and other articles which are flammable or susceptible to heat damage in this compartment.

Do not direct water under pressure against the center compartment as water will be forced into the compartment.

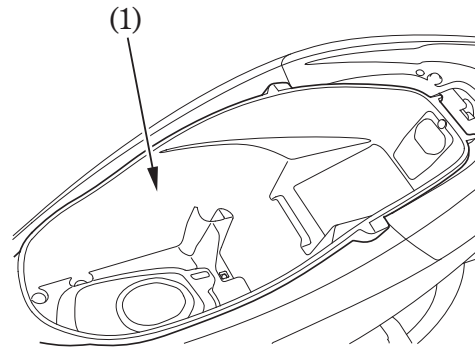

(1) Center compartment

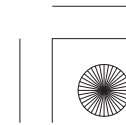



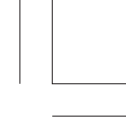

### DOCUMENT COMPARTMENT

The document bag (1) is in the document compartment (2) in the center compartment (3).

Open the seat (page 47 ).

This owner's manual and other documents should be stored in the document bag. When washing your scooter, be careful not to flood this area with water.

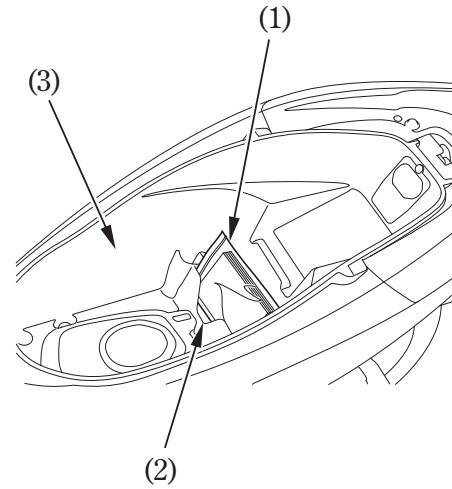

- (1) Document bag
- (2) Document compartment
- (3) Center compartment

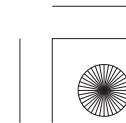
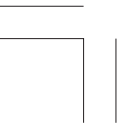



### **GLOVE BOX**

The glove box (1) is provided below the handlebar.

#### **MAXIMUM WEIGHT LIMIT:**

1.0 kg (2.2 lb)

Never exceed the maximum weight limit; handling and stability may be severely affected.

To open the glove box, pull the knob (2) up.

Make sure the box lid (3) is closed before riding.

Do not store valuables or fragile articles in the glove box.

When washing your scooter be careful not to flood this area with water.

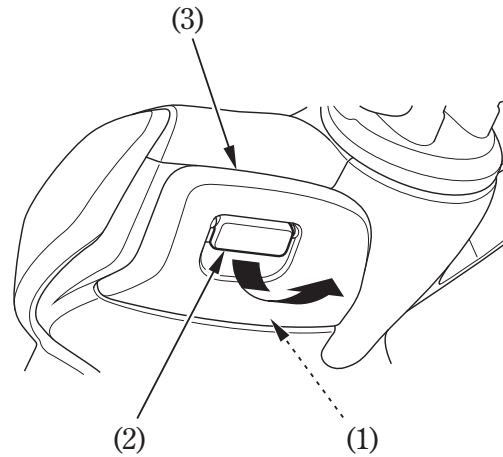

- (1) Glove box
- (2) Knob
- (3) Box lid

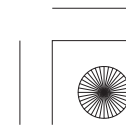



### HEADLIGHT AIM VERTICAL ADJUSTMENT

Vertical adjustment can be made by turning the screw (1) in or out as necessary. Obey local laws and regulations.

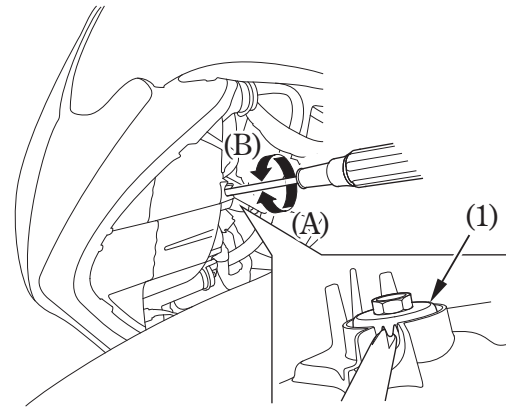

(1) Screw

(A) Up  
(B) Down

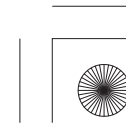
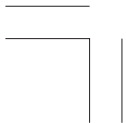



### **CLIP**

#### Removal:

- ① Press down on the center pin to release the lock.
- ② Pull out the clip from the hole.

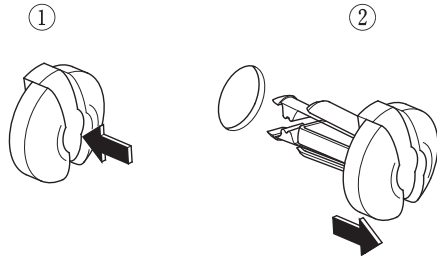

#### Installation:

- ① Slightly open the retaining pawls and then push them out.
- ② Insert the clip into the hole.
- ③ Lightly press down on the center pin to lock the clip.

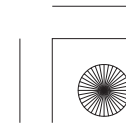
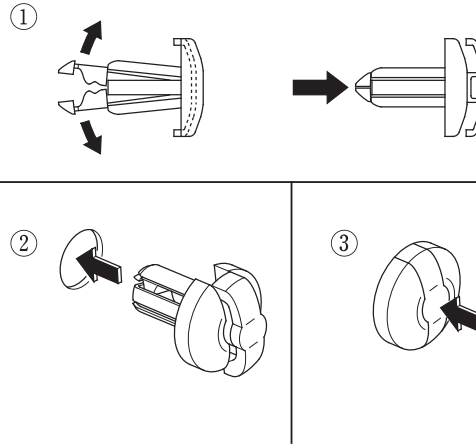



## OPERATION

### PRE-RIDE INSPECTION

For your safety, it is very important to take a few moments before each ride to walk around your scooter and check its condition. If you detect any problem, be sure you take care of it, or have it corrected by your Honda dealer.

### **WARNING**

Improperly maintaining this scooter or failing to correct a problem before riding can cause a crash in which you can be seriously hurt or killed.

Always perform a pre-ride inspection before every ride and correct any problems.

1. Engine oil level—add engine oil if required (page 38 ). Check for leaks.
2. Fuel level—fill fuel tank when necessary (page 35 ). Check for leaks.
3. Coolant level—add coolant if required. Check for leaks (pages 33 – 34 ).
4. Brakes—check operation;  
Front: Make sure there is no brake fluid leakage (pages 28 – 29 ).  
Rear: Adjust freeplay if necessary (pages 30 – 32 ).
5. Tyres—check condition and pressure (pages 39 – 44 ).
6. Throttle—check for smooth opening and full closing in all steering positions.
7. Lights and horn—check that headlight, brake/tail light, position light, license light, turn signals, indicators and horn function properly.
8. Side stand ignition cut-off system—check for proper function (page 108 ).





### **STARTING THE ENGINE**

Always follow the proper starting procedure described below.

This scooter has an automatic fuel valve.

This scooter is equipped with a side stand ignition cut-off system. The engine cannot be started if the side stand is down. A running engine will shut off if the side stand is lowered.

To protect the catalytic converter in your scooter's exhaust system, avoid extending idling and the use of leaded petrol.

Your scooter's exhaust contains poisonous carbon monoxide gas. High levels of carbon monoxide can collect rapidly in enclosed areas such as a garage. Do not run the engine with the garage door closed. Even with the door open, run the engine only long enough to move your scooter out of the garage.

Do not use the electric starter for more than 5 seconds at a time. Release the start button for approximately 10 seconds before pressing it again.

If the scooter is over-turned, you must first turn the ignition switch to the OFF position and then inspect the scooter carefully. Refer to the "TAKING CARE OF THE UNEXPECTED" on page 131 .





This scooter has a fuel-injected engine with an automatic choke. Follow the procedure indicated below.

1. Place the scooter on its center stand.
2. Lock the rear wheel by squeezing the rear brake lever (1).

The electric starter will only work when the rear brake lever is squeezed and the side stand is up.

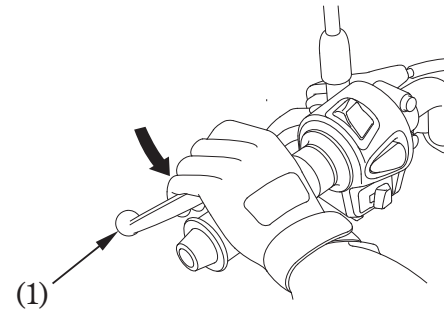

(1) Rear brake lever

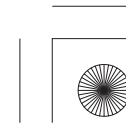
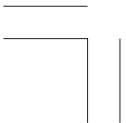



3. Turn the ignition switch (2) to ON.

Confirm the following:

- The PGM-FI malfunction indicator lamp (MIL) is OFF.
- The high coolant temperature indicator is OFF.

4. With the throttle completely closed, press the start button (3). Release the start button as soon as the engine starts.

The engine will not start if the throttle is fully open (because the electronic control module cuts off the fuel supply).

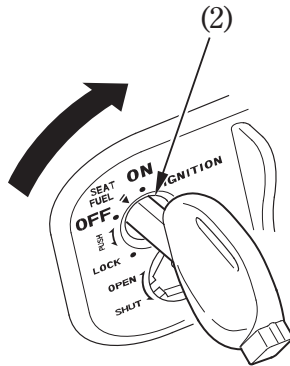

(2) Ignition switch

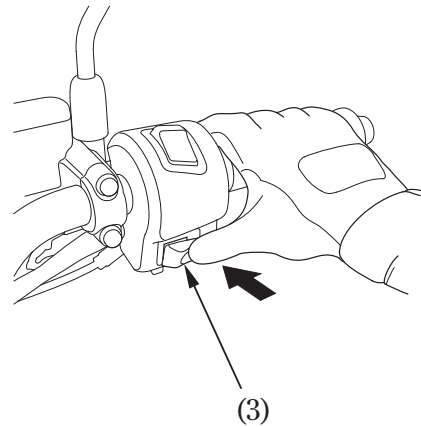

(3) Start button

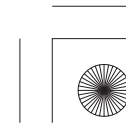





5. Be sure to keep the throttle closed and the rear brake lever locked while starting and warming up the engine.
6. Allow the engine to warm up before riding (See **“RIDING”**, page 74 ).

Do not **“BLIP”** the throttle (open and close rapidly) as the scooter will move forward suddenly, causing possible loss of control. Do not leave the scooter unattended while the engine is warming up.

To use the Idling Stop system, push the Idling Stop switch (4) to **“IDLING STOP”** (see **“IDLING STOP SYSTEM”**, page 52 ).

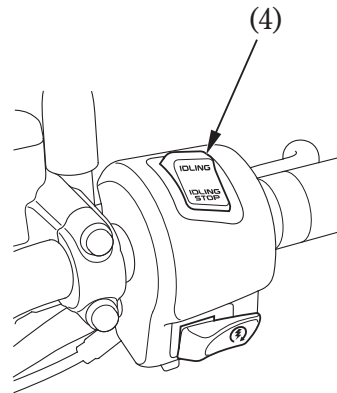

(4) Idling Stop switch

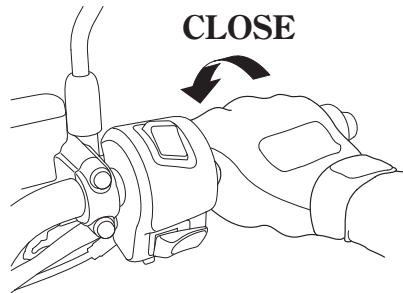



10/02/17 16:57:59 32KWN600\_082

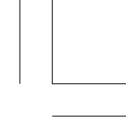

### **Flooded Engine**

If the engine fails to start after repeated attempts, it may be flooded.

1. Open the throttle fully.
  2. Press the start button for 5 seconds.
  3. Follow the normal starting procedure.
  4. If the engine starts with unstable idle, open the throttle slightly.
- If the engine does not start, wait for 10 seconds, then follow steps 1 – 3 again.

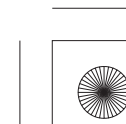
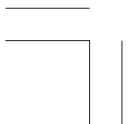



10/02/17 16:58:02 32KWN600\_083



### **RUNNING-IN**

Help assure your scooter's future reliability and performance by paying extra attention to how you ride during the first 500 km (300 miles).

During this period, avoid full-throttle starts and rapid acceleration.

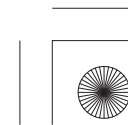
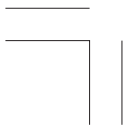



## RIDING

Review Scooter Safety (pages 1 – 14 ) before you ride.

1. **Make sure the throttle is closed and the rear wheel is locked by squeezing the rear brake lever** before moving the scooter off the center stand.

The rear wheel must be locked when moving the scooter off the center stand or loss of control may result.

Make sure flammable materials such as dry grass or leaves do not come in contact with the exhaust system when riding, idling, or parking your scooter.

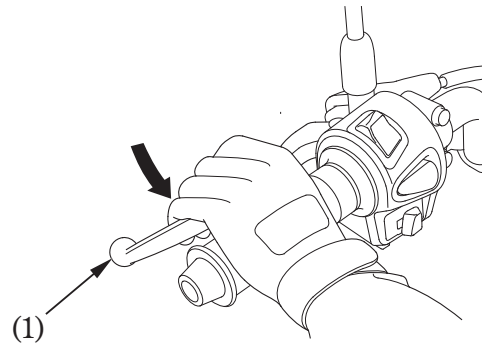

(1) Rear brake lever

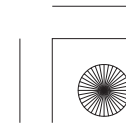



**2. Stand on the left side of the scooter and push it forward and off the center stand.**

**3. Mount the scooter from the left side keeping at least one foot on the ground to steady the scooter.**

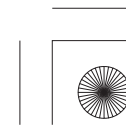
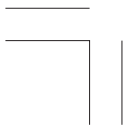
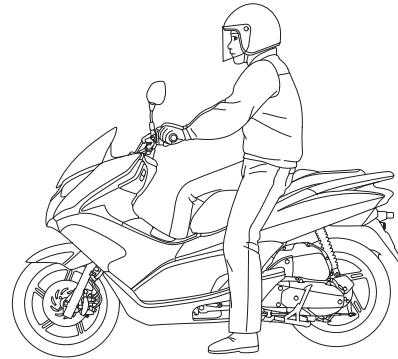
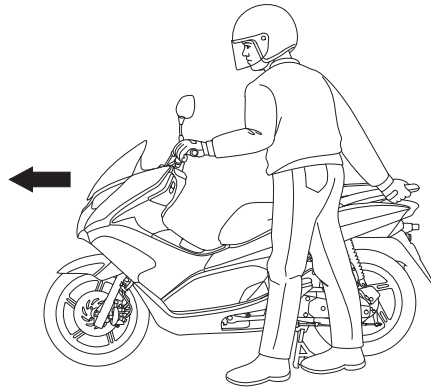



4. Release the rear brake lever (1).

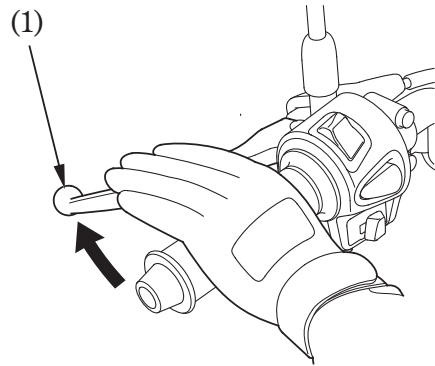

(1) Rear brake lever

5. **Before starting off**, indicate your direction with the turn signals, and check for safe traffic conditions. Grasp the handlebars firmly with both hands.

Never attempt one-handed operation; loss of vehicle control could result.

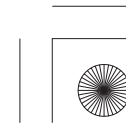
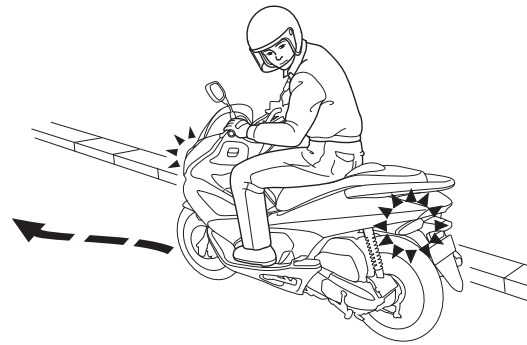



6. **To accelerate**, open the throttle (2) gradually; the scooter will move forward.

Do not “BLIP” the throttle (open and close rapidly) as the scooter will move forward suddenly, causing possible loss of control.

7. **To decelerate**, close the throttle.

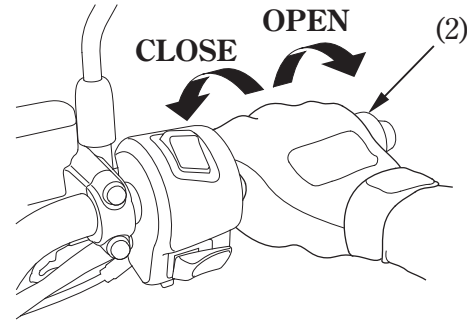

(2) Throttle

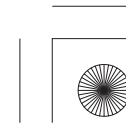
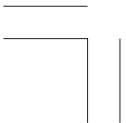



**8. When slowing down the scooter, coordination of the throttle (2) and front and rear brakes (3) is most important.**

Both front and rear brakes should be applied together. Independent use of only the front or rear brake reduces stopping performance.

Excessive brake application may cause either wheel to lock, reducing control of the scooter.

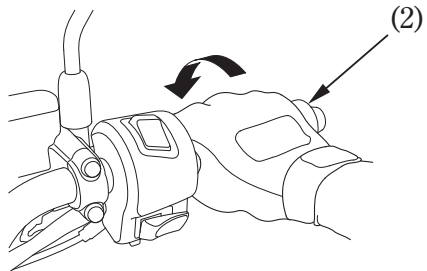

(2) Throttle

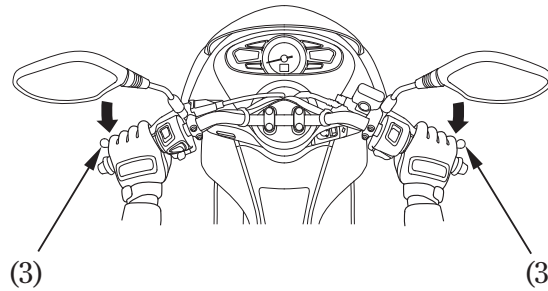

(3) Front and rear brakes

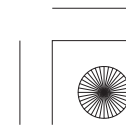





9. **When approaching a corner or turn,** close the throttle (2) fully, and slow the scooter down by applying both front and rear brakes (3) at the same time.
10. **After completing the turn,** open the throttle gradually to accelerate the scooter.

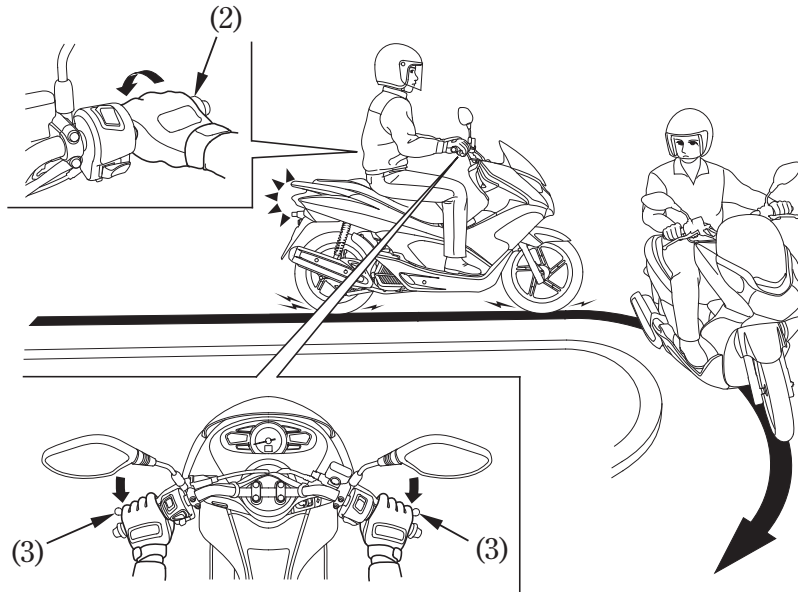

(2) Throttle (3) Front and rear brakes





11. **When descending a steep grade**, close the throttle (2) fully and apply both brakes (3) to slow the scooter.

Avoid continuous use of the brakes, which may result in overheating and reduction of braking efficiency.

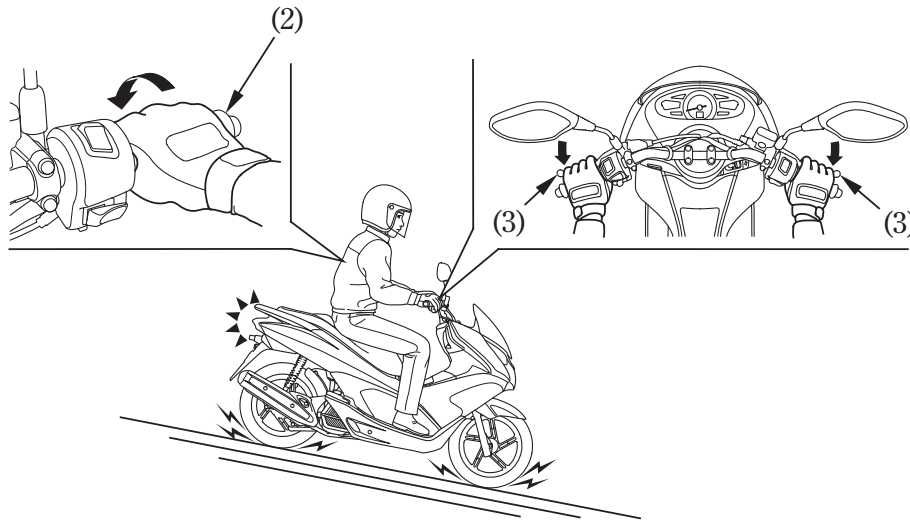

(2) Throttle  
**80**

(3) Front and rear brakes

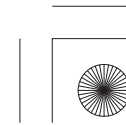



**12. When riding on wet or loose surfaces, be especially cautious.**

When riding in wet or rainy conditions or on loose surfaces, the ability to maneuver and stop will be reduced. For your safety:

- Exercise extreme caution when braking, accelerating or turning.
- Ride at slower speeds and allow for extra stopping distance.
- Keep the scooter as upright as possible.
- Use extreme caution when riding over slippery surfaces such as railroad tracks, iron plates, manhole covers, painted lines, etc.



**When the Idling Stop switch is at “IDLING STOP”**

- Engine will stop by the Idling Stop system, a few seconds after the scooter is stopped, with the throttle completely closed.
- While the Idling Stop system is working, the STAND BY indicator (4) flashes.
- Headlights get dark but stay on after the engine is stopped by the Idling Stop system.

**NOTICE**

Stopping by the Idling Stop system for a long time may cause battery discharge.

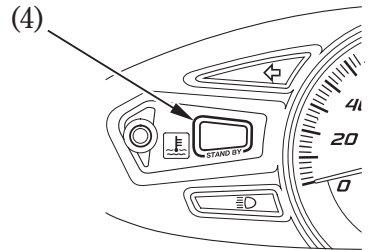

(4) STAND BY indicator

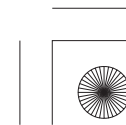
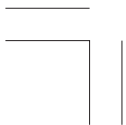

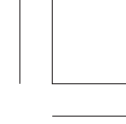

### Restart the engine

- To restart the engine, open the throttle.
- Engine will not start without riding in proper position.
- Make sure the engine is started.
- When starting on a hill, release the brake lever after making sure the feeling of scooter moving.
- While the engine is stopping by the Idling Stop system, push the Idling Stop switch to the “IDLING” to cancel the Idling Stop system.
- If the engine does not start even open the throttle, the battery may discharge. See your Honda dealer for checking the battery.



See your Honda dealer for checking the battery as specified in the maintenance schedule (page 90 ).

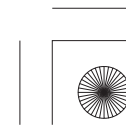
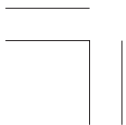



### **PARKING**

1. After stopping the scooter turn the ignition switch to the “OFF” position and remove the key.
2. Use the center stand to support the scooter while parked.

Park the scooter on firm, level ground to prevent it from falling over.  
If you must park on a slight incline, aim the front of the scooter uphill to reduce the possibility of rolling off the center stand or overturning.

3. Lock the steering to help prevent theft (page 50 ).
4. Close the shutter to help prevent theft (page51).

The exhaust pipe and muffler become very hot during operation and remain sufficiently hot to inflict burns if touched even after shutting off the engine.

Make sure flammable materials such as dry grass or leaves do not come in contact with the exhaust system when parking your scooter.

### **HOW TO USE CENTER STAND**

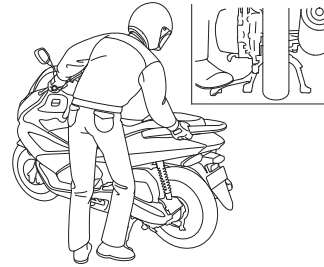



**ANTI-THEFT TIPS**

1. Always lock the steering and never leave the key in the ignition switch. This sounds simple but people do forget.
  2. Be sure the registration information for your scooter is accurate and current.
  3. Park your scooter in a locked garage whenever possible.
  4. Use an additional anti-theft device of good quality.
  5. Put your name, address, and phone number in this Owner's Manual and keep it on your scooters at all times.
- Many times stolen scooters are identified by information in the Owner's Manuals that are still with them.

NAME: \_\_\_\_\_

ADDRESS: \_\_\_\_\_

\_\_\_\_\_

\_\_\_\_\_

PHONE NO: \_\_\_\_\_

**LOCK STEERING**

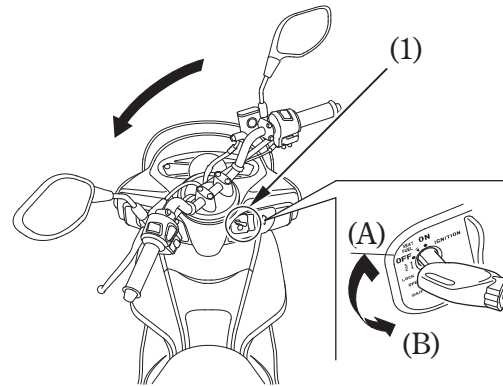

(1) Ignition key

(A) Push in  
(B) Turn to LOCK





## MAINTENANCE

### THE IMPORTANCE OF MAINTENANCE

A well-maintained scooter is essential for safe, economical and trouble-free riding. It will also help reduce air pollution.

To help you properly care for your scooter, the following pages include a Maintenance Schedule and a Maintenance Record for regularly scheduled maintenance.

These instructions are based on the assumption that the scooter will be used exclusively for its designed purpose. Sustained high speed operation or operation in unusually wet or dusty conditions will require more frequent service than specified in the Maintenance Schedule. Consult your Honda dealer for recommendations applicable to your individual needs and use.

If your scooter overturns or becomes involved in a crash, be sure your Honda dealer inspects all major parts, even if you are able to make some repairs.

### WARNING

Improperly maintaining this scooter or failing to correct a problem before you ride can cause a crash in which you can be seriously hurt or killed.

Always follow the inspection and maintenance recommendations and schedules in this owner's manual.



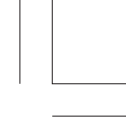

### **MAINTENANCE SAFETY**

This section includes instructions on some important maintenance tasks. You can perform some of these tasks with the tools provided — if you have basic mechanical skills.

Other tasks that are more difficult and require special tools are best performed by professionals. Wheel removal should normally be handled only by a Honda technician or other qualified mechanic; instructions are included in this manual only to assist in emergency service.

Some of the most important safety precautions follow. However, we cannot warn you of every conceivable hazard that can arise in performing maintenance. Only you can decide whether or not you should perform a given task.

### **⚠ WARNING**

Failure to properly follow maintenance instructions and precautions can cause you to be seriously hurt or killed.

Always follow the procedures and precautions in this owner's manual.

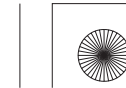





### SAFETY PRECAUTIONS

- Make sure the engine is off before you begin any maintenance or repairs. This will help eliminate several potential hazards:
  - \* **Carbon monoxide poisoning from engine exhaust.**  
Be sure there is adequate ventilation whenever you operate the engine.
  - \* **Burns from hot parts.**  
Let the engine and exhaust system cool before touching.
  - \* **Injury from moving parts.**  
Do not run the engine unless instructed to do so.
- Read the instructions before you begin, and make sure you have the tools and skills required.
- To help prevent the scooter from falling over, park it on a firm, level surface, using the center stand to provide support.

- To reduce the possibility of a fire or explosion, be careful when working around petrol or batteries. Use only nonflammable solvent, not petrol, to clean parts. Keep cigarettes, sparks and flames away from the battery and all fuel-related parts.

Remember that your Honda dealer knows your scooter best and is fully equipped to maintain and repair it.

To ensure the best quality and reliability, use only new Honda Genuine Parts or their equivalents for repair and replacement.



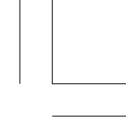

## MAINTENANCE SCHEDULE

Perform the Pre-ride Inspection (page 67 ) at each scheduled maintenance period.

I: INSPECT AND CLEAN, ADJUST, LUBRICATE OR REPLACE IF NECESSARY

C: CLEAN R: REPLACE A: ADJUST L: LUBRICATE

The following items require some mechanical knowledge. Certain items (particularly those marked \* and \*\* ) may require more technical information and tools. Consult your Honda dealer.

- \* Should be serviced by your Honda dealer, unless the owner has proper tools and service data and is mechanically qualified. Refer to the Official Honda Shop Manual.
- \*\* In the interest of safety, we recommend these items be serviced only by your Honda dealer.

Honda recommends that your Honda dealer should road test your scooter after each periodic maintenance is carried out.

- NOTES:
- (1) At higher odometer readings, repeat at the frequency interval established here.
  - (2) Service more frequently when riding in unusually wet or dusty areas.
  - (3) Service more frequently when riding in rain or at full throttle.
  - (4) Replace every 2 years. Replacement requires mechanical skill.

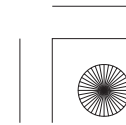



ITEM	FREQUENCY	WHICHEVER → COMES FIRST ↓		ODOMETER READING [NOTE (1)]					Refer to page
		× 1,000 km	× 1,000 mi	1	4	8	12		
		NOTE	MONTH	0.6	2.5	5	7.5		
* FUEL LINE					I	I	I	—	
* THROTTLE OPERATION					I	I	I	107	
AIR CLEANER	NOTE (2)			EVERY 16,000 km (10,000 mi) R				95	
CRANKCASE BREATHER	NOTE (3)				C	C	C	96	
SPARK PLUG						R		103	
* VALVE CLEARANCE				I	I	I	I	—	
ENGINE OIL				R		R		97	
* ENGINE OIL STRAINER SCREEN							C	101	
* ENGINE IDLE SPEED				I	I	I	I	—	
RADIATOR COOLANT	NOTE (4)					I		33	
* COOLING SYSTEM						I		—	





ITEM	FREQUENCY	WHICHEVER → COMES FIRST ↓		ODOMETER READING [NOTE (1)]				Refer to page
		× 1,000 km	× 1,000 mi	1	4	8	12	
		NOTE	MONTH	0.6	2.5	5	7.5	
* DRIVE BELT				EVERY 8,000 km (5,000 mi) I, EVERY 24,000 km (15,000 mi) R				—
* FINAL DRIVE OIL	NOTE (4)							—
* BATTERY				I	I	I	I	111
BRAKE FLUID	NOTE (4)				I	I	I	28
BRAKE SHOES/PADS WEAR					I	I	I	109, 110
BRAKE SYSTEM				I	I	I	I	27, 109, 110
* BRAKE LIGHT SWITCH					I	I	I	—
* BRAKE LOCK OPERATION				I	I	I	I	—
* HEADLIGHT AIM					I	I	I	65
** CLUTCH SHOES WEAR						I		—
SIDE STAND					I	I	I	108
* SUSPENSION					I	I	I	107
* NUTS, BOLTS, FASTENERS				I		I		—
** WHEELS/TYRES					I	I	I	—
** STEERING HEAD BEARINGS				I			I	—



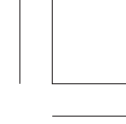

### TOOL KIT

The tool kit (1) is in the tool kit compartment (2) under the seat (page 47). Some roadside repairs, minor adjustments and parts replacement can be performed with the tools contained in the kit.

- Standard/Phillips screwdriver
- Screwdriver handle
- Spark plug wrench
- Helmet wire
- Tool bag

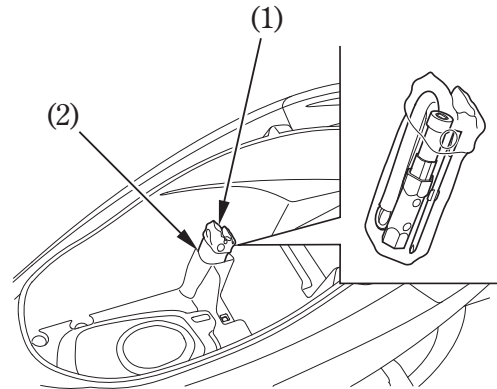

- (1) Tool kit
- (2) Tool kit compartment

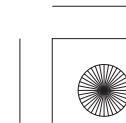
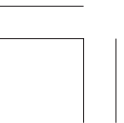

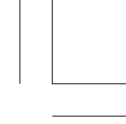

### SERIAL NUMBERS

The frame and engine serial numbers are required when registering your scooter. They may also be required by your dealer when ordering replacement parts. Record the numbers here for your reference.

The frame number (1) is stamped on the rear of the frame below the seat.

The engine number (2) is stamped on the lower left side of the crankcase.

FRAME NO. \_\_\_\_\_

ENGINE NO. \_\_\_\_\_

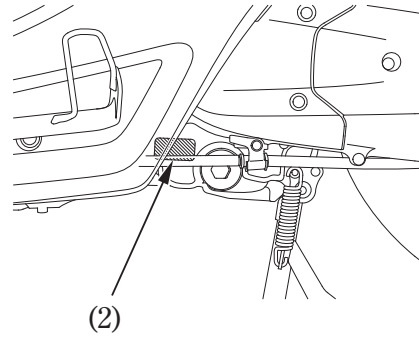
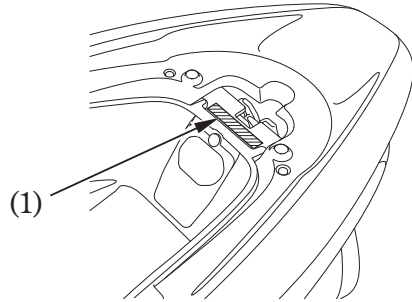

(1) Frame number  
**92**

(2) Engine number

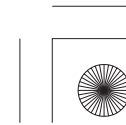



This scooter has two keys (1) and a key number plate (2).

You will need the key number if you ever have to replace a key. Store the plate in a safe place.

To reproduce keys, bring all keys, key number plate and scooter to your Honda dealer.

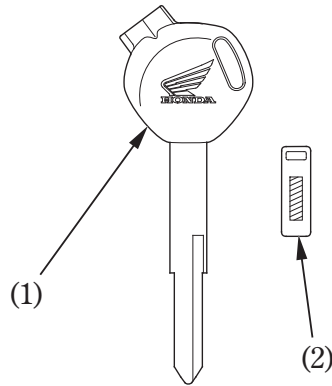

(1) Key

(2) Key number plate

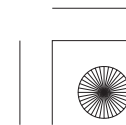
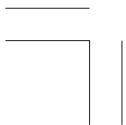

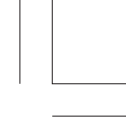

### COLOUR LABEL

The colour label (1) is attached to the center compartment (page 62).

It is helpful when ordering replacement parts. Record the colour and code here for your reference.

COLOUR \_\_\_\_\_

CODE \_\_\_\_\_

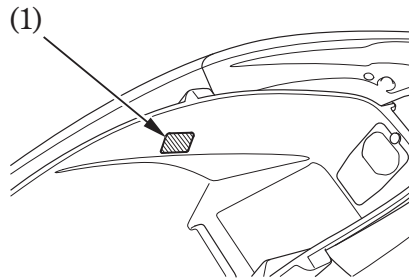

(1) Colour label

**94**

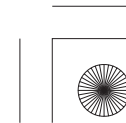
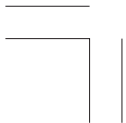





## AIR CLEANER

Refer to the Safety Precautions on page 87 .

The air cleaner should be serviced at regular intervals (page 89 ). Service more frequently when riding in unusually wet or dusty areas.

1. Remove the air cleaner housing cover (1) by removing the screws (2).
2. Remove and discard the air cleaner element (3).
3. Thoroughly clean the inside of the air cleaner housing (4).
4. Install the new air cleaner element.  
Use the Honda Genuine air cleaner element or an equivalent air cleaner element specified for your model. Using the wrong Honda air cleaner element or a non-Honda air cleaner element which is not of equivalent quality may cause premature engine wear or performance problems.
5. Install the removed parts in the reverse order of removal.

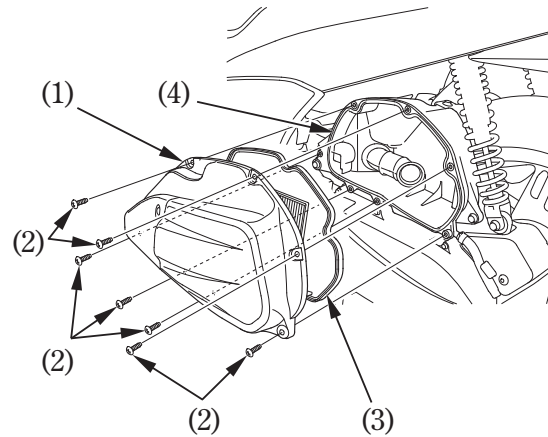

- (1) Air cleaner housing cover
- (2) Screws
- (3) Air cleaner element
- (4) Air cleaner housing





### **CRANKCASE BREATHER**

Refer to the Safety Precautions on page 87 .

1. Remove the crankcase breather tube (1) from the air cleaner housing and drain deposits into a suitable container.
2. Reinstall the crankcase breather tube.

Service more frequently when riding in rain, at full throttle, or after the scooter is washed or overturned. Service if the deposit level can be seen in the transparent section of the drain tube.

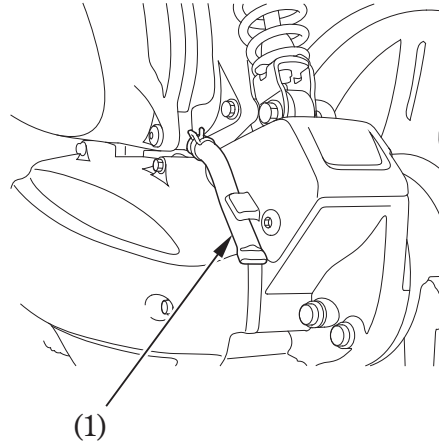

(1) Crankcase breather tube

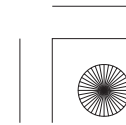



### ENGINE OIL

Refer to the Safety Precautions on page 87 .

#### Oil Recommendation

API classification	SG or higher except oils labeled as energy conserving on the circular API service label
Viscosity	SAE 10W-30
JASO T 903 standard	MB

Suggested Oil
Honda "4-STROKE MOTORCYCLE OIL" or equivalent.

Your scooter does not need oil additives. Use the recommended oil.

Do not use API SH or higher oils displaying a circular API "energy conserving" service label on the container. They may affect lubrication and clutch performance.



NOT RECOMMENDED

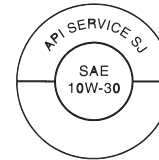

OK

Do not use non-detergent, vegetable, or castor based racing oils.



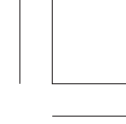

**Viscosity:**

Viscosity grade of engine oil should be based on average atmospheric temperature in your riding area. The following provides a guide to the selection of the proper grade or viscosity of oil to be used at various atmospheric temperatures.

**JASO T 903 standard**

The JASO T 903 standard is an index for engine oils for 4-stroke motorcycle engines. There are two classes: MA and MB. Oil conforming to the standard is labeled on the oil container. For example, the following label shows the MB classification.

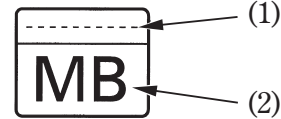
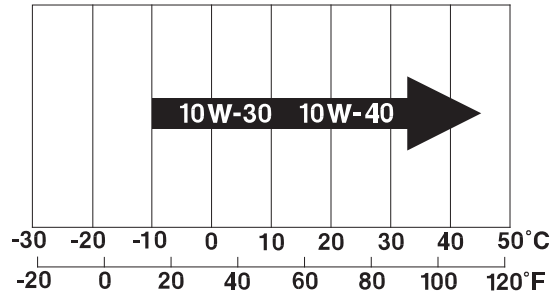

PRODUCT MEETING JASO T 903  
COMPANY GUARANTEEING THIS MB PERFORMANCE:

- (1) Code number of the sales company of the oil
- (2) Oil classification





### Engine Oil

Engine oil quality is the chief factor affecting engine service life. Change the engine oil as specified in the maintenance schedule (page 89 ).

When running in very dusty conditions, oil changes should be performed more frequently than specified in the maintenance schedule.

Please dispose of used engine oil in a manner that is compatible with the environment. We suggest you take it in a sealed container to your local recycling center or service station for reclamation. Do not throw it in the trash or pour it on the ground or down a drain.

Used engine oil may cause skin cancer if repeatedly left in contact with the skin for prolonged periods. Although this is unlikely unless you handle used oil on a daily basis, it is still advisable to thoroughly wash your hands with soap and water as soon as possible after handling used oil.

Changing the oil requires a torque wrench. If you do not have it and the necessary skill, we recommend that you have your Honda dealer perform this service.

If a torque wrench is not used for this installation, see your Honda dealer as soon as possible to verify proper assembly.

Change the engine oil with the engine at normal operating temperature and the scooter on its center stand to assure complete and rapid draining.

Change the engine oil with the Idling Stop switch “**IDLING**”.





1. Place an oil drain pan under the crankcase. Remove the oil fill cap/dipstick, oil drain bolt (1) and sealing washer (2).
2. Check that the sealing washer on the drain bolt is in good condition and install the bolt. Replace the sealing washer every other time the oil is changed, or each time if necessary.  
Oil drain bolt torque:  
24 N·m (2.4 kgf·m , 18 lbf·ft)
3. Fill the crankcase with the recommended grade oil; approximately:  
0.8 l (0.8 US qt , 0.7 Imp qt)
4. Reinstall the oil fill cap/dipstick.
5. Start the engine and let it idle for 3–5 minutes.
6. Stop the engine and wait 2–3 minutes.  
Check that the oil level is at the upper level mark on the oil fill cap/dipstick with the scooter upright on firm, level ground. Make sure there are no oil leaks.

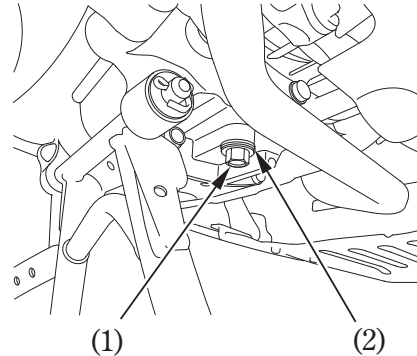

(1) Oil drain bolt

(2) Sealing washer

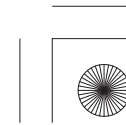



### ENGINE OIL STRAINER SCREEN

Refer to the Safety Precautions on page 87 .

1. Drain the engine oil (page 100).
2. Remove the oil strainer screen cap (1).

3. The spring (2) and oil strainer screen (3) will come out when the oil strainer screen cap is removed.
4. Clean the oil strainer screen.
5. Check that the oil strainer screen, sealing rubber and O-ring (4) are in good condition.

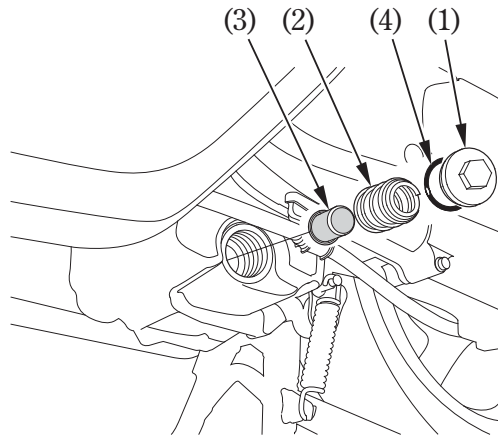

- (1) Oil strainer screen cap
- (2) Spring
- (3) Oil strainer screen
- (4) O-ring

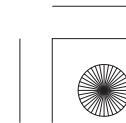
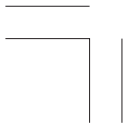



6. Install the oil strainer screen, spring and oil strainer screen cap.

Oil strainer screen cap torque:  
20 N·m (2.0 kgf·m , 15 lbf·ft)

7. Check that the sealing washer on the drain bolt is in good condition and install the bolt. Replace the sealing washer every other time the oil is changed, or each time if necessary.

Oil drain bolt torque:  
24 N·m (2.4 kgf·m , 18 lbf·ft)

8. Fill the crankcase with the recommended grade oil; approximately:

0.9 ℓ (1.0 US qt , 0.8 Imp qt)

9. Install the oil fill cap/dipstick.
10. Start the engine and let it idle for 3–5 minutes.
11. 2–3 minutes after stopping the engine, check that the oil level is at the upper level mark on the oil fill cap/dipstick with the scooter upright on firm, level ground. Make sure there are no oil leaks.

If a torque wrench is not used for this installation, see your Honda dealer as soon as possible to verify proper assembly.

**102**

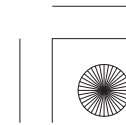





## SPARK PLUG

Refer to the Safety Precautions on page 87 .

Recommended plugs:

Standard:

CPR7EA-9 (NGK)

### NOTICE

Never use a spark plug with an improper heat range. Severe engine damage could result.

1. Remove the plug maintenance lid (1) by removing the screw (2).

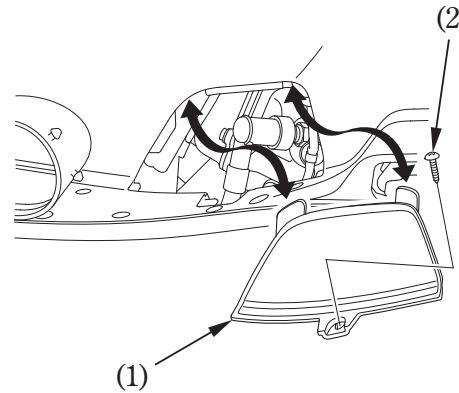

- (1) Plug maintenance lid
- (2) Screw





2. Disconnect the spark plug cap (3) from the spark plug.
3. Clean any dirt from around the spark plug base.  
Remove the spark plug using a spark plug wrench furnished in the tool kit.

4. Inspect the electrodes and center porcelain for deposits, erosion or carbon fouling. If the erosion or deposit is heavy, replace the plug. Clean a carbon or wet-fouled plug with a plug cleaner, otherwise use a wire brush.
5. Check the spark plug gap (4) using a wire-type feeler gauge. If adjustment is necessary, bend the side electrode (5) carefully.

The gap should be:

0.80–0.90 mm (0.031–0.035 in)

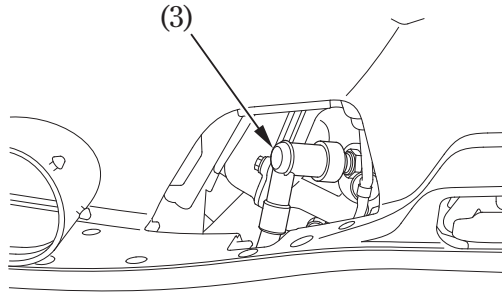

(3) Spark plug cap

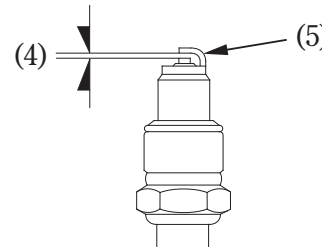

(4) Spark plug gap

(5) Side electrode

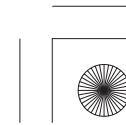



6. Make sure the plug washer is in good condition.
7. With the plug washer attached, thread the spark plug in by hand to prevent cross-threading.
8. Tighten the spark plug:
  - If the old plug is good:
    - 1/8 turn after it seats.
  - If installing a new plug, tighten it twice to prevent loosening:
    - a) First, tighten the plug:  
NGK: 1/2 turn after it seats.
    - b) Then loosen the plug.
    - c) Next, tighten the plug again:  
1/8 turn after it seats.
9. Reinstall the spark plug cap. Take care to avoid pinching any cables or wires.
10. Install the removed parts in the reverse order of removal.



**NOTICE**

An improperly tightened spark plug can damage the engine. If a plug is too loose, a piston may be damaged. If a plug is too tight, the threads may be damaged.

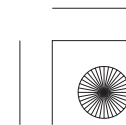
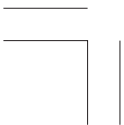

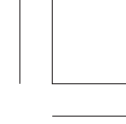

## COOLANT

Refer to the Safety Precautions on page 87 .

### Coolant Replacement

Coolant should be replaced by a Honda dealer, unless the owner has proper tools and service data and is mechanically qualified. Refer to an official Honda Shop Manual.

Always add coolant to the reserve tank. Do not attempt to add coolant by removing the radiator cap.



## WARNING

Removing the radiator cap while the engine is hot can cause the coolant to spray out, seriously scalding you.

Always let the engine and radiator cool down before removing the radiator cap.

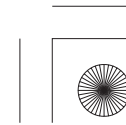

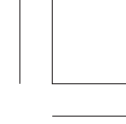

### **THROTTLE OPERATION**

Refer to the Safety Precautions on page 87 .

Check for smooth rotation of the throttle grip from the fully open to the fully closed position at both full steering positions.



### **FRONT AND REAR SUSPENSION INSPECTION**

Refer to the Safety Precautions on page 87 .

1. Check the front fork assembly by locking the front brake and pumping the fork up and down vigorously. Suspension action should be smooth and there must be no oil leakage.
2. Engine hanger bushing—this can be checked by pushing hard against the side of the rear wheel while the scooter is on the center stand and feeling for looseness of the engine hanger bushings.
3. Carefully inspect all front and rear suspension fasteners for tightness.

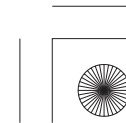
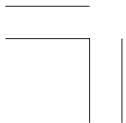



## SIDE STAND

Refer to the Safety Precautions on page 87 .

Perform the following maintenance in accordance with the maintenance schedule.

### Functional Check:

- Check the side stand spring (1) for damage or loss of tension and the side stand assembly for freedom of movement.
- Check the side stand ignition cut-off system:
  1. Place the scooter on its center stand.
  2. Put the side stand up and start the engine.
  3. Lower the side stand. The engine should stop as you put the side stand down.

If the side stand system does not operate as described, see your Honda dealer for service.

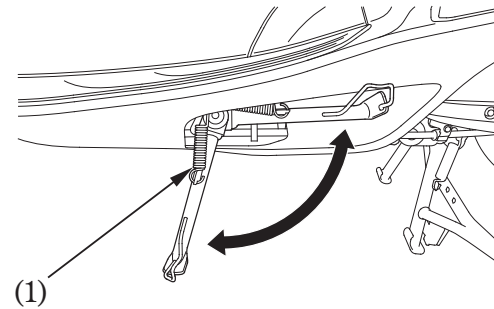

(1) Side stand spring

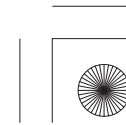



## **BRAKE PAD WEAR**

Refer to the Safety Precautions on page 87 .

Brake pad wear depends upon the severity of usage, the type of riding, and road conditions. (Generally, the pads will wear faster on wet and dirty roads.)

Inspect the pads at each regular maintenance interval (page 90 ).

### **Front Brake**

Check the wear indicator marks (1) on each pad.

If either pad is worn to the wear indicator mark, replace both pads as a set. See your Honda dealer for this service.

### **< FRONT BRAKE >**

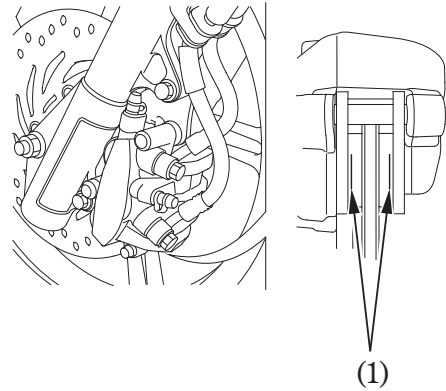

(1) Wear indicator marks

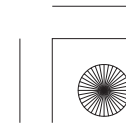
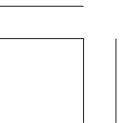



### **BRAKE SHOE WEAR**

Refer to the Safety Precautions on page 87 .

The rear brake is equipped with a brake wear indicator.

When the brake is applied, an arrow (1) attached to the brake arm (2) moves toward a reference mark (3) on the brake panel (4). If the arrow aligns with the reference mark on full application of the brake, the brake shoes must be replaced. See your Honda dealer for this service.

When the brake service is necessary, see your Honda dealer. Use only Honda Genuine Parts or its equivalent.

### **< REAR BRAKE >**

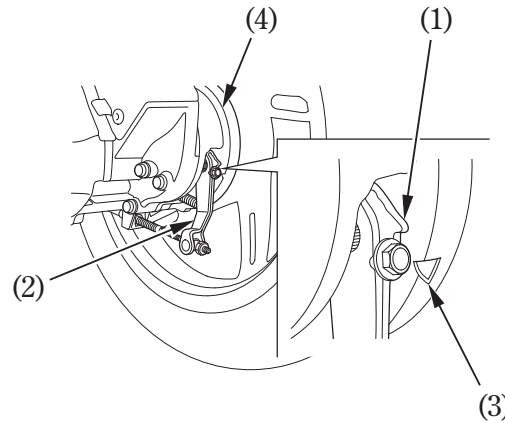

- (1) Arrow
- (2) Brake arm
- (3) Reference mark
- (4) Brake panel

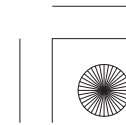



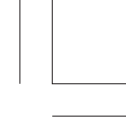

## BATTERY

Refer to the Safety Precautions on page 87 .

It is not necessary to check the battery electrolyte level or add distilled water as the battery is a maintenance-free (sealed) type. If your battery seems weak and/or is leaking electrolyte (causing hard starting or other electrical troubles), contact your Honda dealer.

### NOTICE

Your battery is a maintenance-free type and can be permanently damaged if the cap strip is removed.



This symbol on the battery means that this product must not be treated as household waste.

### NOTICE

An improperly disposed of battery can be harmful to the environment and human health.

Always confirm local regulations for battery disposal.

## WARNING

The battery gives off explosive hydrogen gas during normal operation.

A spark or flame can cause the battery to explode with enough force to kill or seriously hurt you.

Wear protective clothing and a face shield, or have a skilled mechanic do the battery maintenance.

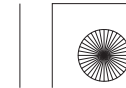



**NOTICE**

Headlights stay on after the engine is stopped by the Idling Stop system. The battery may discharge and you may not be able to restart engine. When the battery is weak, switch the Idling Stop switch to “**IDLING**” and do not to use the Idling Stop system. See your Honda dealer to check the battery.

See your Honda dealer for checking the battery as specified in the maintenance schedule (page 90 ).



**Removal:**

1. Make sure the ignition switch is OFF.
2. Open the seat (page 47 ).
3. Remove the battery cover (1) by removing the clip (2).

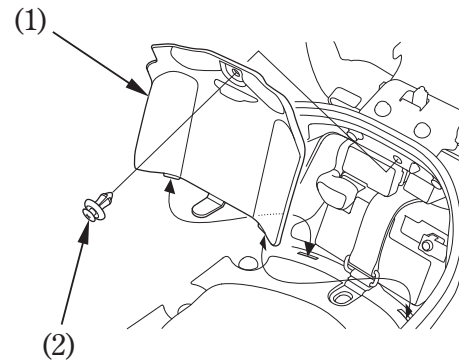

- (1) Battery cover
- (2) Clip

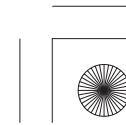



4. Remove the battery holder (3).
5. Disconnect the negative (-) terminal lead (4) from the battery first, then disconnect the positive (+) terminal lead (5).
6. Remove the battery (6).

**Installation:**

1. Reinstall in the reverse order of removal. Be sure to connect the positive (+) terminal first, then the negative (-) terminal.
2. Check all bolts and other fasteners are secure.

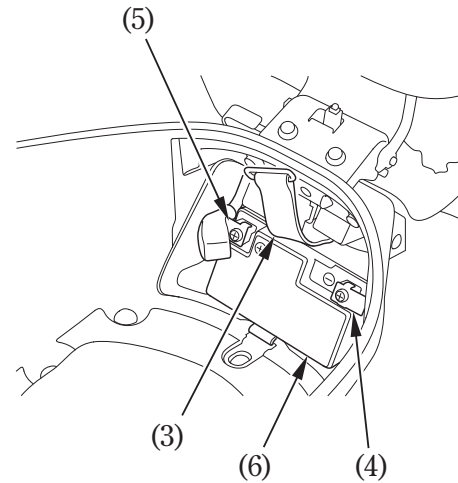

- (3) Battery holder
- (4) Negative (-) terminal lead
- (5) Positive (+) terminal lead
- (6) Battery

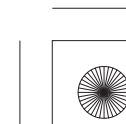
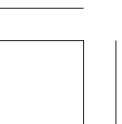



## FUSE REPLACEMENT

Refer to the Safety Precautions on page 87 .

When frequent fuse failure occurs, it usually indicates a short circuit or an overload in the electrical system. See your Honda dealer for repair.

### NOTICE

Never use a fuse with a different rating from that specified. Serious damage to the electrical system or a fire may result, causing a dangerous loss of lights or engine power.



**Blown fuse**

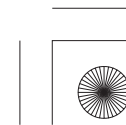
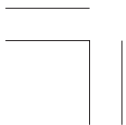
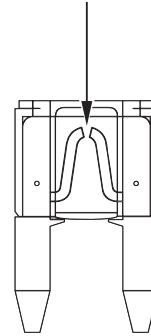



**Fuse Box:**

The fuse box (1) is located near the battery.

The specified fuses are:

Main fuse 1 10A

Main fuse 2 30A

Sub fuse 10A, 15A

1. Remove the battery cover (page 112 ).
2. Open the fuse box cover (2).
3. Pull out the old fuse and install a new fuse.  
The spare fuses (3) are located in the fuse box.
4. Close the fuse box cover and install the battery cover.

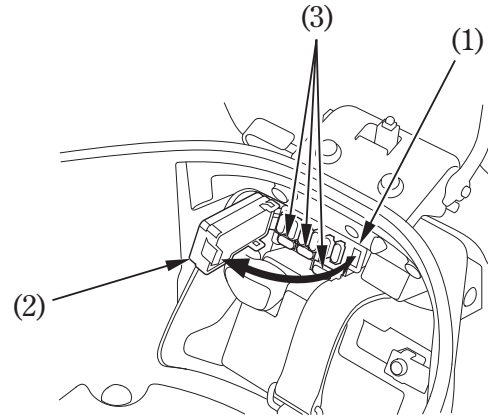

- (1) Fuse box
- (2) Fuse box cover
- (3) Spare fuses

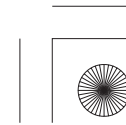



## **BULB REPLACEMENT**

Refer to the Safety Precautions on page 87 .

The light bulb becomes very hot while the light is ON, and remains hot for a while after it is turned OFF. Be sure to let it cool down before servicing.

Do not put finger prints on the headlight bulb, as they may create hot spots on the bulb and cause it to break.

Wear clean gloves while replacing the bulb. If you touch the bulb with your bare hands, clean it with a cloth moistened with alcohol to prevent its early failure.

- Be sure to turn the ignition switch OFF when replacing the bulb.
- Do not use bulbs other than those specified.
- After installing a new bulb, check that the light operates properly.

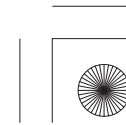



### Headlight Bulb

1. Pull back the rubber dust cover (1).
2. Turn the bulb (2) counterclockwise, and remove it.
3. Remove the bulb from the connector (3).
4. Install a new bulb in the reverse order of removal.
  - Install the rubber dust cover with its "TOP" mark (4) facing up.

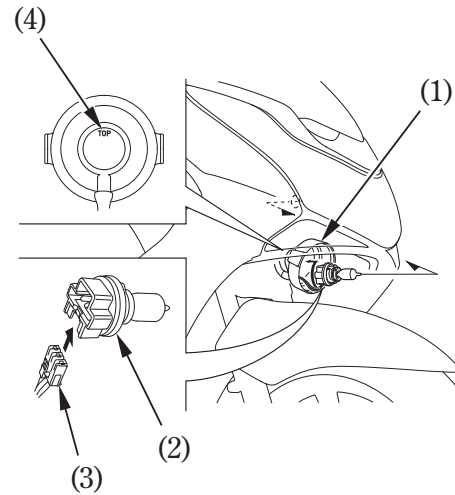

(1) Rubber dust cover  
(2) Bulb

(3) Connector  
(4) "TOP" mark

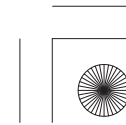



### Position Light Bulb

The right and left position light bulbs replacement can be done in the same way.

1. Turn the socket (1) counterclockwise, and remove it.
2. Pull out the bulb (2) without turning.
3. Install a new bulb in the reverse order of removal.

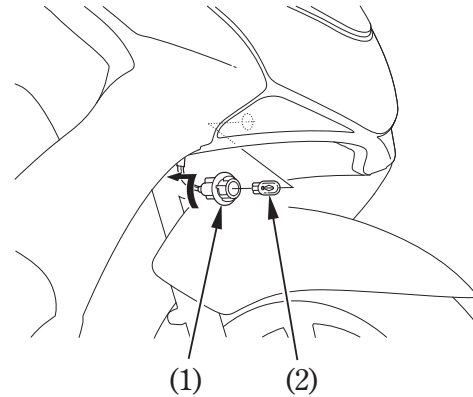

- (1) Socket  
(2) Bulb

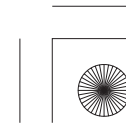
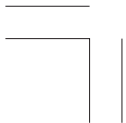





### Brake/Tail Light Bulb

1. Remove the screws (1).
2. While the rear cover (2) pressing as illustration, unhook the prongs (3), from the front side of the rear cover.
3. Remove the rear cover.

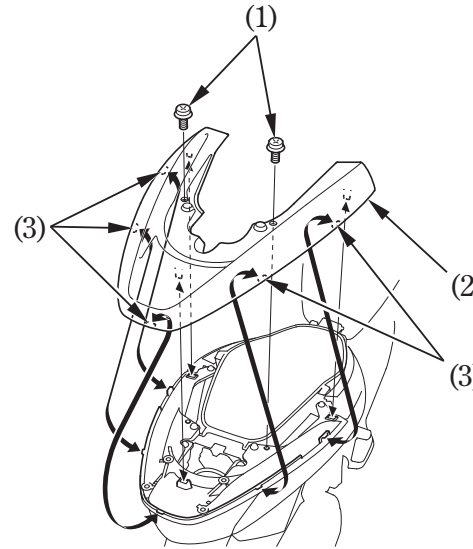
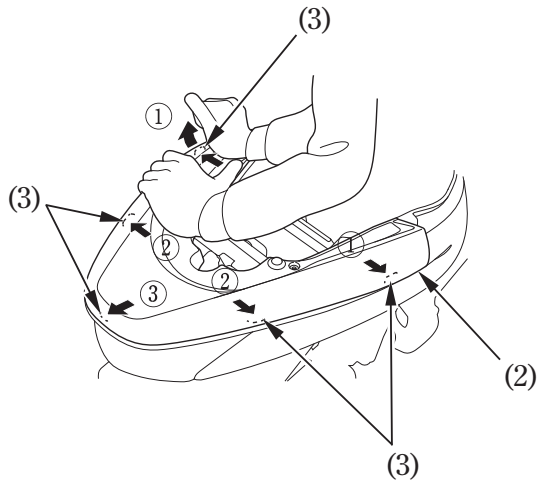

- (1) Screws
- (2) Rear cover
- (3) Prongs

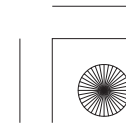



4. Turn the socket (4) counterclockwise, and remove it.
5. Slightly press the bulb (5) and turn it counterclockwise.
6. Install a new bulb in the reverse order of removal.

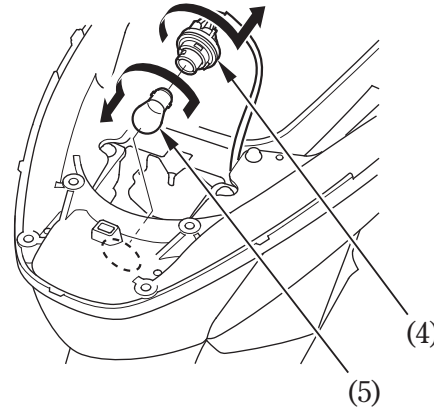

(4) Socket  
(5) Bulb

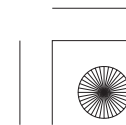
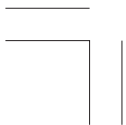



### Front Turn Signal Bulb

The right and left turn signal bulbs replacement can be done in the same way.

1. Turn the socket (1) counterclockwise, and remove it.
2. Slightly press the bulb (2) and turn it counterclockwise.
3. Install a new bulb in the reverse order of removal.
  - Use only the amber bulb.

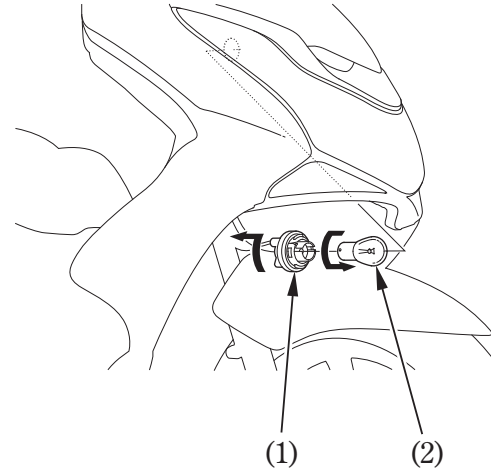

- (1) Socket
- (2) Bulb

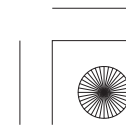
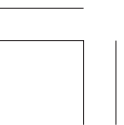

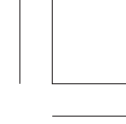

### Rear Turn Signal Bulb

The right and left turn signal bulbs replacement can be done in the same way.

1. Remove the turn signal assembly (1) by removing the screws (2).
2. Unhook the hook (3) and remove the turn signal lens (4) from the turn signal assembly.
3. Slightly press the bulb (5) and turn it counterclockwise.
4. Install a new bulb in the reverse order of removal.
  - Use only the amber bulb.

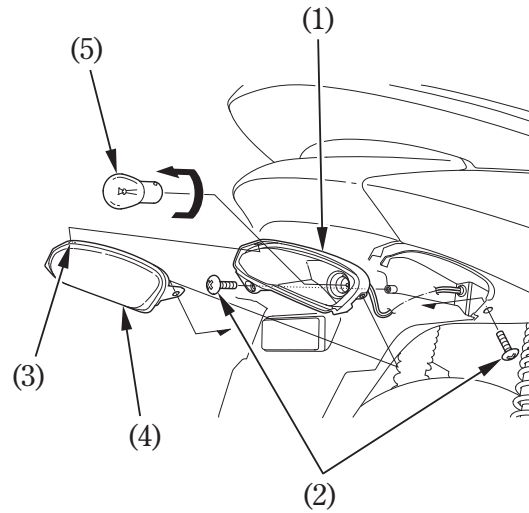

- |                          |                      |
|--------------------------|----------------------|
| (1) Turn signal assembly | (4) Turn signal lens |
| (2) Screws               | (5) Bulb             |
| (3) Hook                 |                      |



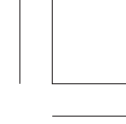

### License Light Bulb

1. Remove the screws (1).
2. Remove the license light cover (2).
3. Pull out the bulb (3) without turning.
4. Install a new bulb in the reverse order of removal.

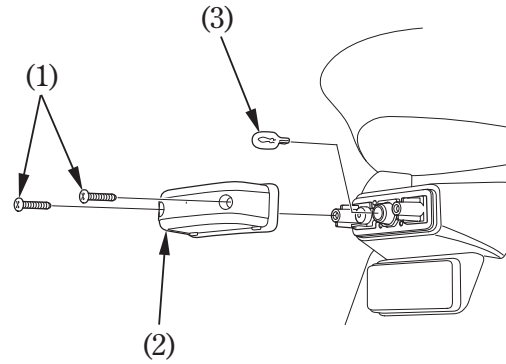

- (1) Screws
- (2) License light cover
- (3) Bulb

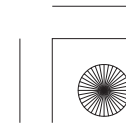



## CLEANING

Clean your scooter regularly to protect the surface finishes and inspect for damage, wear, and oil, coolant or brake fluid leakage.

Avoid cleaning products that are not specifically designed for scooter or automobile surfaces.

They may contain harsh detergents or chemical solvents that could damage the metal, paint, and plastic on your scooter.

If your scooter is still warm from recent operation, give the engine and exhaust system time to cool off.

We recommend avoiding the use of high pressure water spray (typical in coin-operated car washes).

### NOTICE

High pressure water (or air) can damage certain parts of the scooter.

### Washing the scooter

1. Rinse the scooter thoroughly with cool water to remove loose dirt.
2. Clean the scooter with a sponge or soft cloth using cool water.  
Avoid directing water to muffler outlets and electrical parts.
3. Clean the plastic parts using a cloth or sponge dampened with a solution of mild detergent and water. Rub the soiled area gently rinsing it frequently with fresh water.

Take care to keep brake fluid or chemical solvents off the scooter.

They will damage the plastic and painted surfaces.

The inside of the headlight lens may be clouded immediately after washing the scooter. Moisture condensation inside the headlight lens will disappear gradually by lighting the headlight in high beam. Run the engine while keeping the headlight on.

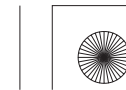



4. After cleaning, rinse the scooter thoroughly with plenty of clean water. Strong detergent residue can corrode alloy parts.
5. Dry the scooter, start the engine and let it run for several minutes.

6. Test the brakes before riding the scooter. Several applications may be necessary to restore normal braking performance.

Braking efficiency may be temporarily impaired immediately after washing the scooter. Anticipate longer stopping distance to avoid a possible accident.



### TEST BRAKES

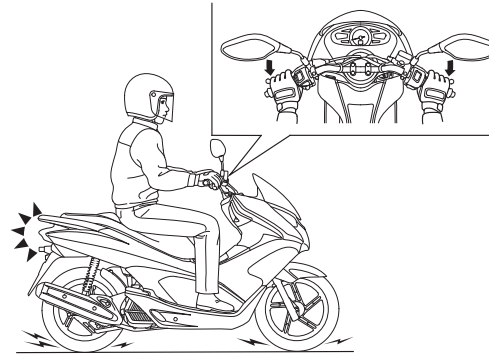



### **Finishing Touches**

After washing your scooter, consider using a commercially-available spray cleaner/polish or quality liquid or paste wax to finish the job. Use only a non-abrasive polish or wax made specifically for motorcycles or automobiles. Apply the polish or wax according to the instructions on the container.



### **Removing Road Salt**

Road Salt used on roads during winter and salt from seawater causes rust.

Wash your scooter as follows after it has run through salty water or on roads treated with Road Salt.

1. Clean the scooter using cool water (page 124 ).

Do not use warm water.  
This worsens the effect of the salt.

2. Dry the scooter and the surface of the metal is protected with the wax.

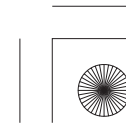
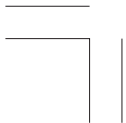



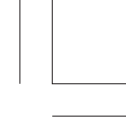

**Painted Aluminum Wheel Maintenance**

Aluminum may corrode from contact with dirt, mud, or road salt. Clean the wheels after riding through any of these substances. Use a wet sponge and mild detergent. Avoid stiff brushes, steel wool, or cleaners containing abrasives or chemical compounds.

After washing, rinse with plenty of water and dry with a clean cloth.

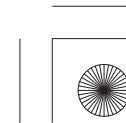
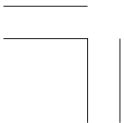

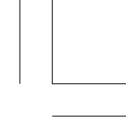

## STORAGE GUIDE

Extended storage, such as for winter, requires that you take certain steps to reduce the effects of deterioration from non-use of the scooter. In addition, necessary repairs should be made BEFORE storing the scooter; otherwise, these repairs may be forgotten by the time the scooter is removed from storage.

### STORAGE

1. Change the engine oil.
2. Make sure the cooling system is filled with a 50/50 % antifreeze solution.
3. Empty the fuel tank into an approved petrol container using a commercially available hand siphon or an equivalent method. Spray the inside of the tank with an aerosol rust-inhibiting oil.  
Reinstall the fuel fill cap on the tank.

## WARNING

Petrol is highly flammable and explosive. You can be burned or seriously injured when handling fuel.

- Stop the engine and keep heat, sparks, and flame away.
- Refuel only outdoors.
- Wipe up spills immediately.

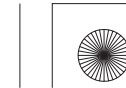



4. To prevent rusting in the cylinder, perform the following:
  - Remove the spark plug cap from the spark plug. Using tape or string, secure the cap to any convenient plastic body part so that it is positioned away from the spark plug.
  - Remove the spark plug from the engine and store it in a safe place. Do not connect the spark plug to the spark plug cap.
  - Pour a tablespoon (15–20 cm<sup>3</sup>) of clean engine oil into the cylinder and cover the spark plug hole with a piece of cloth.
  - Crank the engine several times to distribute the oil.
  - Reinstall the spark plug and spark plug cap.
5. Remove the battery. Store in an area protected from freezing temperatures and direct sunlight. Slow charge the battery once a month.
6. Wash and dry the scooter. Wax all painted surfaces. Coat chrome with rustinhibiting oil.
7. Inflate the tyres to their recommended pressures. Place the scooter on blocks to raise both tyres off the ground.
8. Cover the scooter (don't use plastic or other coated materials) and store in an unheated area, free of dampness with a minimum of daily temperature variation. Do not store the scooter in direct sunlight.

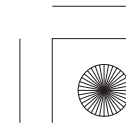

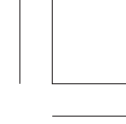

### REMOVAL FROM STORAGE

1. Uncover and clean the scooter.
2. Change the engine oil if more than 4 months have passed since the start of storage.
3. Charge the battery as required. Install the battery.
4. Drain any excess aerosol rust-inhibiting oil from the fuel tank. Fill the fuel tank with fresh petrol.
5. Perform all Pre-ride Inspection checks (page 67 ).  
Test ride the scooter at low speeds in a safe riding area away from traffic.

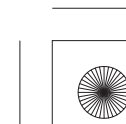
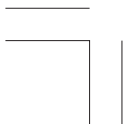



## **TAKING CARE OF THE UNEXPECTED**

### **IF YOU CRASH**

Personal safety is your first priority after a crash. If you or anyone else has been injured, take time to assess the severity of the injuries and whether it is safe to continue riding. Call for emergency assistance if needed. Also follow applicable laws and regulations if another person or vehicle is involved in the crash.

If you decide that you are capable of riding safely, first evaluate the condition of your scooter. If the engine is still running, turn it off and look it over carefully; inspect it for fluid leaks, check the tightness of critical nuts and bolts, and secure such parts as the handlebar, control levers, brakes, and wheels.

If there is minor damage, or you are unsure about possible damage, ride slowly and cautiously. Sometimes, crash damage is hidden or not immediately apparent, so you should have your scooter thoroughly checked at a qualified service facility as soon as possible. Also, be sure to have your Honda dealer check the frame and suspension after any serious crash.

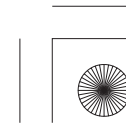

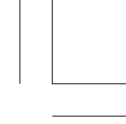

## SPECIFICATIONS

### DIMENSIONS

Overall length	1,915 mm (75.4 in)
Overall width	740 mm (29.1 in)
Overall height	1,090 mm (42.9 in)
Wheelbase	1,305 mm (51.4 in)

### CAPACITIES

Engine oil	After draining	0.8 ℓ (0.8 US qt , 0.7 Imp qt)
	After disassembly	0.9 ℓ (1.0 US qt , 0.8 Imp qt)
Fuel tank		6.1 ℓ (1.61 US gal , 1.34 Imp gal)
Transmission oil	After draining	0.16 ℓ (0.17 US qt , 0.14 Imp qt)
	After disassembly	0.18 ℓ (0.19 US qt , 0.16 Imp qt)
Cooling system capacity		0.70 ℓ (0.74 US qt , 0.62 Imp qt)
Passenger capacity		Operator and one passenger
Maximum weight capacity		180 kg (397 lb) ... Except KO type
		152 kg (335 lb) ... KO type only

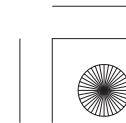
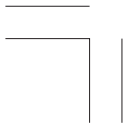



10/02/17 17:03:58 32KWN600\_143



### ENGINE

Bore and stroke  
Compression ratio  
Displacement  
Spark plug  
Standard

52.4 × 57.9 mm (2.06 × 2.28 in)  
11.0 : 1  
125 cm<sup>3</sup> (7.6 cu-in)  
CPR7EA-9 (NGK)

Spark plug gap  
Idle speed

0.80 – 0.90 mm (0.031 – 0.035 in)  
1,700 ± 100 min<sup>-1</sup> (rpm)

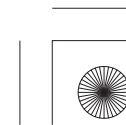
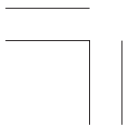



10/02/17 17:04:05 32KWN600\_144



### CHASSIS AND SUSPENSION

Caster	27°00'
Trail	86 mm (3.4 in)
Tyre size, front	90/90-14M/C 46P IRC SS-560F
Tyre size, rear	100/90-14M/C 57P IRC SS-560R
Tyre type	bias-ply, tubeless



### POWER TRANSMISSION

Primary reduction	V-Belt
Final reduction	11.271

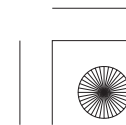
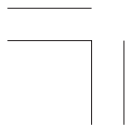





10/02/17 17:04:13 32KWN600\_145



**ELECTRICAL**

Battery  
Generator

12V – 6Ah (10HR) / 6.3Ah (20HR)  
0.308 kW / 5,000 min<sup>-1</sup> (rpm)

**LIGHTS**

Headlight  
Brake/Tail light  
Turn signal light  
Position light  
License light

Front  
Rear

12V – 35/30W × 2  
12V – 21/5W  
12V – 21W × 2  
12V – 21W × 2  
12V – 5W × 2  
12V – 5W



**FUSE**

Main fuse 1  
Main fuse 2  
Sub fuse

10A  
30A  
10A, 15A

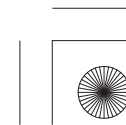
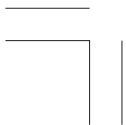

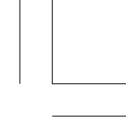

## CATALYTIC CONVERTER

This scooter is equipped with a catalytic converter.

The catalytic converter contains precious metals that serve as catalysts, promoting chemical reactions to convert the exhaust gasses without affecting the metals.

The catalytic converter acts on HC, CO, and NOx. A replacement unit must be an original Honda part or its equivalent.

The catalytic converter must operate at a high temperature for the chemical reactions to take place. It can set on fire any combustible materials that come near it. Park your scooter away from high grasses, dry leaves, or other flammables.

A defective catalytic converter contributes to air pollution, and can impair your engine's performance. Follow these guidelines to protect your scooter's catalytic converter.

- Always use unleaded petrol. Even a small amount of leaded petrol can contaminate the catalyst metals, making the catalytic converter ineffective.
- Keep the engine in good running condition.  
A poorly running engine can cause the catalytic converter to overheat causing damage to the converter or the scooter.
- If your engine is misfiring, backfiring, stalling, or otherwise not running properly, stop riding and turn off the engine. Have your scooter serviced as soon as possible.

