



Manuale dell'Utente
User's manual

MV AGUSTA



Manuale dell'utente
Versione Italiana



Gentile cliente,

La ringraziamo per la fiducia accordataci e ci congratuliamo con Lei per la Sua nuova F4 RR.

La Sua scelta premia l'impegno e lo sforzo fatto con passione dai nostri tecnici, per dare alla F4 RR caratteristiche funzionali ed estetiche che la pongono al di sopra delle moto di più alto livello oggi disponibili sul mercato, rendendola così un oggetto ambito ed esclusivo.

Se dal lato puramente tecnico F4 RR rappresenta, con le sue innumerevoli innovazioni, un punto di riferimento a livello mondiale, la sua linea senza tempo, morbida ed affusolata, è una splendida fusione fra un glorioso passato e un nuovo millennio.

Il connubio di questi elementi, che solo la ricerca del dettaglio, la passione ed il desiderio di realizzare una moto tecnicamente ed esteticamente superiore hanno consentito di raggiungere, eleva la F4 RR al di sopra di qualsiasi moda passeggera, dandole così il privilegio di essere considerata un oggetto unico al mondo.

Se desiderasse ulteriori informazioni, non esiti a contattare il Servizio Assistenza Clienti MV Agusta.

Buon divertimento!

*Giovanni Castiglioni
Presidente
MV Agusta*



INDICE GENERALE

<i>cap.</i>	<i>Descrizione argomenti</i>	<i>pag.</i>
1	INFORMAZIONI GENERALI	5
1.1.	Scopo del manuale	5
1.2.	Simbologia	6
1.3.	Contenuto del supporto digitale	7
1.4.	Dati di identificazione	8
2	INFORMAZIONI SULLA SICUREZZA	11
2.1.	Uso consentito del veicolo	11
2.2.	Manutenzione	11
2.3.	Accessori e modifiche	12
2.4.	Carico veicolo	12
3	COMANDI E STRUMENTI	14
3.1.	Posizione comandi e strumenti	14
3.2.	Cavalletto laterale	15
3.3.	Comandi semimanubrio sinistro	16
3.4.	Comandi semimanubrio destro	18
3.5.	Interruttore accensione e bloccasterzo	21
3.6.	Comando cambio	24
3.7.	Strumentazione e spie	25
3.7.1.	Spie luminose di indicazione	26
3.7.2.	Display multifunzione	27
3.8.	Tabella lubrificanti e liquidi	28

<i>cap.</i>	<i>Descrizione argomenti</i>	<i>pag.</i>
4	USO	29
4.1.	Uso della motocicletta	29
4.2.	Rodaggio	30
4.3.	Avviamento motore	32
4.4.	Selezione e modifica delle funzioni display	35
4.4.1.	Selezione funzioni display	36
4.4.2.	Azzeramento delle funzioni contachilometri parziali	41
4.4.3.	Modalità "TC"	43
4.4.4.	Cronometro	44
4.4.5.	Modalità "NIGHT/DAY"	53
4.4.6.	Regolazione elettronica delle sospensioni	54
4.4.7.	Selezione della funzione ABS	58
4.4.8.	Modalità "QUICK SHIFT"	60
4.4.9.	Funzione "IMMOBILIZER"	61
4.4.10.	Selezione della mappatura centralina	64
4.4.11.	Messaggi di errore/malfunzionamento	76
4.5.	Rifornimento carburante	79
4.6.	Accesso al vano portaoggetti	81
4.7.	Sosta della motocicletta	82



INDICE GENERALE

<i>cap.</i>	<i>Descrizione argomenti</i>	<i>pag.</i>
5	REGOLAZIONI	84
5.1.	Elenco regolazioni	84
5.2.	Tabella delle regolazioni	86
5.3.	Regolazione leva freno anteriore	87
5.4.	Regolazione leva frizione	87
5.5.	Regolazione specchietti retrovisori	87
5.6.	Regolazione sospensione anteriore	88
5.6.1.	Prearico molla (sospensione anteriore)	89
5.7.	Regolazione proiettore anteriore	90



1.1. Scopo del manuale

Il presente Manuale fornisce le informazioni necessarie per un uso corretto e sicuro della moto.

Assieme al Manuale viene fornito un Quick Manual tascabile nel quale sono riportate le informazioni minime essenziali per l'uso del veicolo.

Il Manuale viene fornito anche in formato elettronico (.pdf) sul supporto digitale in dotazione e può essere stampato o visualizzato su un qualsiasi PC, sia dotato di sistema Windows che Mac.

Vi raccomandiamo di leggere attentamente il Manuale prima di utilizzare la moto e di sincerarvi che chiunque utilizzi la moto abbia prima fatto lo stesso.

Vi raccomandiamo, infine, di portare sempre con Voi il Quick Manual completandolo con i dati identificativi vostri e della motocicletta.



Copyright
MV AGUSTA Motor Spa
Tutti i diritti riservati





1.2. Simbologia

Le parti di testo di particolare importanza, relative alla sicurezza della persona e all'integrità della motocicletta, sono evidenziate con i seguenti simboli:



Pericolo - Attenzione: la mancata o incompleta osservanza di queste prescrizioni può comportare pericolo grave per la propria incolumità e per quella di altre persone.



Cautela - Precauzione: la mancata o incompleta osservanza di queste prescrizioni può comportare un rischio di danni alla motocicletta.

Per indicare le persone autorizzate allo svolgimento delle operazioni di regolazione e/o manutenzione, esse sono contraddistinte dai seguenti simboli:



Informazioni sulle operazioni consentite al motociclista.



Informazioni sulle operazioni che devono essere svolte solo dal personale autorizzato.

Per evidenziare ulteriori informazioni vengono utilizzati i seguenti simboli:



Il simbolo  indica la necessità di utilizzare un attrezzo od un'attrezzatura specifica per il corretto svolgimento dell'operazione descritta.



Il simbolo “ § ” indica il rimando al capitolo identificato dal numero che lo segue.





1.3. Contenuto del supporto digitale

Nel presente supporto digitale troverete, oltre a questo Manuale, il Manuale di Manutenzione, il Quick Manual (di cui viene fornita anche la versione stampata), la Guida delle Concessionarie ed il Libretto di Garanzia.

Al momento della consegna della moto, il Vs. Concessionario vi ha consegnato il Certificato di Garanzia e Pre-Consegna.

Vi preghiamo di conservarlo unitamente ai documenti della moto ed ai futuri tagliandi di manutenzione che vi verranno via via consegnati in occasione degli interventi previsti.

IMPORTANTE

Le copie del Certificato di Garanzia e Pre-Consegna devono essere compilate dal Concessionario. Una copia deve essere consegnata al Cliente, una deve essere conservata dal Concessionario ed una deve essere inviata all'Importatore.

Le copie dei tagliandi di manutenzione raccomandata devono essere sempre compilati dal Concessionario. Esse devono essere conservate dal Cliente e dal Concessionario.





1

2) numero di matricola motore

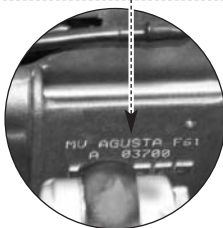

1) numero di matricola telaio

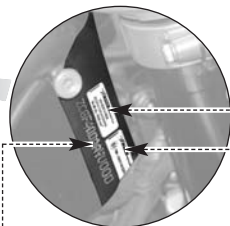

3) dati di omologazione

1.4. Dati di identificazione

- 1) numero di matricola telaio
- 2) numero di matricola motore
- 3) dati di omologazione

► Identificazione motocicletta

La motocicletta è identificata dal numero di matricola del telaio. Per ordinare le parti di ricambio, oltre a questo numero, può essere necessario indicare il numero di matricola motore, il codice colore e il numero di identificazione chiave.

Si consiglia di annotare i dati principali negli spazi sotto riportati.

TELAIO N.: _____

MOTORE N.: _____





► Identificazione chiave della motocicletta

Viene fornita, in duplice copia, una chiave da utilizzare sia per l'avviamento che per l'azionamento di tutte le serrature. Custodire in luogo sicuro la copia di scorta.

La conoscenza del numero di identificazione chiave è essenziale nel caso in cui si renda necessario richiedere un duplicato della chiave a ricambio. Il numero di identificazione chiave è riportato sulla MV Code Card fornita in dotazione insieme alle chiavi di avviamento.



► Identificazione combinazione colori motocicletta

Il codice colore è indispensabile per ordinare le parti di ricambio della carrozzeria. Esso si trova nella parte inferiore destra del serbatoio benzina.

Per accedere alla targhetta codice colore, è necessario rimuovere il fianchetto serbatoio destro. Tirare la parte posteriore del fianchetto serbatoio destro verso l'esterno come mostrato in figura.





1

Procedere alla rimozione del fianchetto serbatoio destro sfilandolo verso la parte posteriore della moto.



Dopo avere rimosso il fianchetto serbatoio, è possibile accedere alla targhetta codice colore posta sul serbatoio. Su questa targhetta è possibile individuare il codice colore della motocicletta, il quale determina la colorazione delle parti della carrozzeria.

Si consiglia di annotare il codice colore della motocicletta nel seguente spazio:

CODICE COLORE :

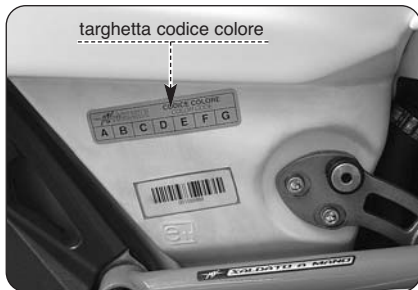



2.1. USO CONSENTITO DEL VEICOLO

La Vostra motocicletta e' stata progettata per un utilizzo esclusivamente stradale ed autostradale.



ATTENZIONE

Saltuariamente e' possibile utilizzare la moto in pista in occasioni non competitive.

In tale caso, tuttavia, a causa delle maggiori sollecitazioni a cui in tale specifico utilizzo la moto e' sottoposta, si raccomanda di far verificare da un Centro Assistenza MV Agusta le condizioni della moto prima e dopo l'uso.

Ogni altro utilizzo e' proibito ed espressamente escluso.

Potete trovare ulteriori informazioni circa l'uso della moto nella sezione 4 del presente Manuale.

2.2. MANUTENZIONE

Per garantire la massima efficienza ed affidabilità del veicolo è essenziale eseguire gli interventi manutentivi previsti nel Manuale di Manutenzione.

MV Agusta raccomanda che tutti gli interventi di manutenzione siano effettuati solo da personale specializzato appartenente ad un Centro Assistenza MV Agusta.

Laddove, viceversa, decidiate di far eseguire gli interventi di manutenzione da officine terze, dovette farVi confermare che le stesse abbiano la capacità e gli strumenti specifici necessari all'esecuzione di tali interventi.



ATTENZIONE

La garanzia MV Agusta potrebbe non operare laddove officine terze abbiano effettuato interventi sulla moto in modo difforme da quanto previsto dalle Circolari Tecniche e nei relativi Manuali di Officina MV Agusta.





2.3. ACCESSORI E MODIFICHE



ATTENZIONE

MV Agusta vieta di apportare qualsiasi modifica alle proprie motociclette.

Questo è necessario al fine di salvaguardare la sicurezza dei suoi Clienti.

È tuttavia possibile personalizzare la Vostra motocicletta attingendo dal ricco catalogo accessori MV Agusta.



ATTENZIONE

L'installazione di alcuni di questi accessori può invalidare l'omologazione della moto e, pertanto, comportare la sua non ulteriore utilizzabilità su strada pubblica.

In caso di dubbio Vi consigliamo di consultarVi con il vostro Concessionario MV Agusta di fiducia per decidere quali accessori siano più adatti alle Vostre esigenze.

2.4. CARICO VEICOLO

Il veicolo è progettato per l'impiego da parte del pilota e di un eventuale passeggero. Per un utilizzo in piena sicurezza e nel rispetto delle norme del codice stradale è obbligatorio non superare mai la massa massima tecnicamente ammissibile dei veicoli, il cui valore è di seguito riportato:

F4 RR:

Massa massima tecnicamente ammissibile:

378 kg

Massa massima trasportabile:

165 kg

La massa massima tecnicamente ammissibile rappresenta la somma delle seguenti masse:

- massa del motociclo in ordine di marcia;
- massa del pilota;
- massa del passeggero;
- massa del bagaglio e degli accessori.



**ATTENZIONE**

Dato che il carico ha un impatto enorme sulla manovrabilità, la frenata, le prestazioni e le caratteristiche di sicurezza del vostro mezzo, tenere sempre presenti le seguenti precauzioni.

- **NON SOVRACCARICARE MAI IL MOTOCICLO!** L'uso di un motociclo sovraccaricato può provocare danneggiamenti dei pneumatici, perdite del controllo o infortuni gravi. Verificare che il peso totale del pilota, del passeggero, del carico e degli accessori non superi il carico massimo specificato per il motociclo.

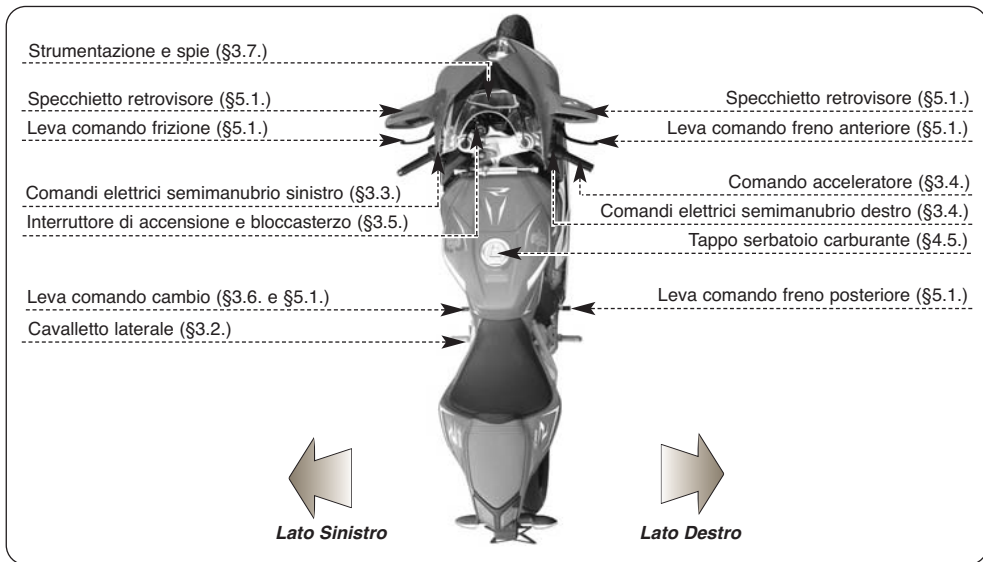

**3.1. Posizione comandi e strumenti****3**



3.2. Cavalletto laterale

Il cavalletto laterale è dotato di un interruttore di sicurezza che impedisce al motociclo di mettersi in marcia con il cavalletto abbassato. Nel caso in cui, a motore avviato e nella condizione di cavalletto abbassato, si azioni il cambio per porsi in movimento, l'interruttore interrompe la corrente al motore provocandone lo spegnimento. Nel caso in cui la moto si trovi invece nella condizione di stazionamento (cavalletto abbassato) e con un rapporto del cambio inserito, l'interruttore impedisce l'avviamento del motore evitando ogni rischio di caduta accidentale del veicolo.

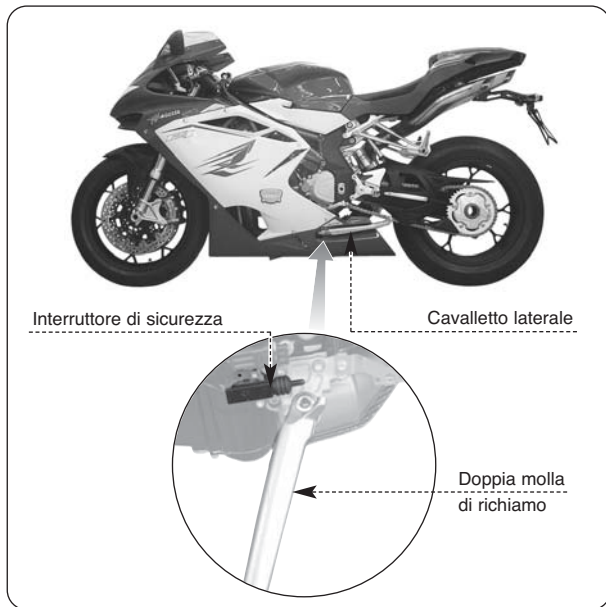



3.3. Comandi semimanubrio sinistro

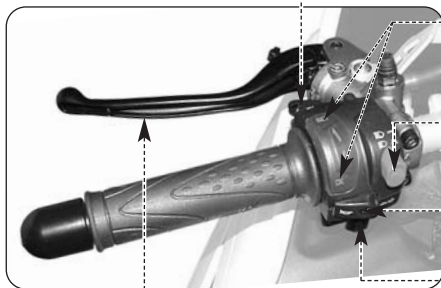





Pulsante lampeggio fari

Premere il pulsante a ripetizione.

Pulsante SET/OK

Premere per modificare le funzioni del cruscotto (§ 4.4.).

Pulsante abbagliante/anabbagliante

Pulsante in fuori  : anabbagliante 
Pulsante in dentro  : abbagliante 

Pulsante avvisatore acustico

Premere per attivare l'avvisatore acustico.

Leva indicatori di direzione

Spostando la leva a destra o a sinistra si attivano gli indicatori di direzione destri o sinistri. La leva torna al centro; premere per disattivare gli indicatori.

Leva frizione

Accostare o allontanare dalla manopola per comandare la frizione.





Pulsante Lampeggio Faro

Questa funzione serve a richiamare l'attenzione degli altri utenti della strada in caso di possibili situazioni di pericolo; con l'abbagliante acceso tale funzione non è attiva.

Pulsante Abbagliante/Anabbagliante

Normalmente viene attivata la funzione anabbagliante; quando le condizioni di traffico e di percorso lo consentono, può essere attivata la funzione abbagliante agendo sul pulsante.

Pulsante Avvisatore Acustico

Questa funzione serve a richiamare l'attenzione degli altri utenti della strada in caso di possibili situazioni di pericolo.

Leva Indicatori di Direzione

Questa funzione permette di segnalare agli altri utenti della strada l'intenzione di cambiare direzione o corsia di marcia.



ATTENZIONE

Il mancato uso o la mancata disattivazione degli indicatori di direzione al momento opportuno può essere causa di incidenti; gli altri utenti della strada potrebbero infatti trarre conclusioni sbagliate riguardo all'effettivo tragitto del veicolo. Azionare sempre gli indicatori di direzione prima di svoltare o cambiare corsia.

Accertarsi poi di disattivare gli indicatori non appena effettuata la suddetta manovra.

Leva Frizione

Questa leva, attraverso un dispositivo a controllo idraulico, consente l'innesto ed il disinnesto della frizione.





3.4. Comandi semimanubrio destro

3

Interruttore stop motore

Se azionato arresta il motore e ne impedisce l'avviamento.

Pulsante avviamento motore

Premuto avvia il motore. Va rilasciato appena avviato. Con motore avviato, ripremendo, è possibile selezionare la mappatura della centralina (§.4.4.10.).

Comando acceleratore

Ruotare per regolare l'alimentazione del motore.

Leva freno anteriore

Avvicinare alla manopola per azionare il freno anteriore.

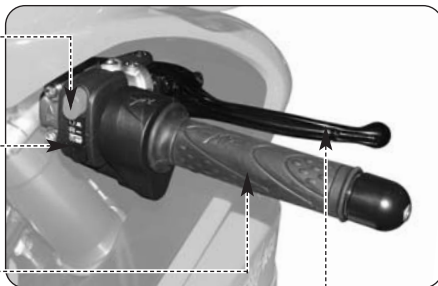



Interruttore Stop Motore

Questa funzione permette di arrestare il motore in caso di emergenza; in questo modo viene disattivato il circuito di accensione impedendo il riavvio del motore. Per poter effettuare l'avviamento riportare il pulsante in posizione di riposo.

NOTA: In condizioni normali non utilizzare questo dispositivo per l'arresto del motore.

Pulsante Avviamento Motore

Questo dispositivo consente l'avviamento del motore; inoltre a motore avviato esso permette di selezionare la mappatura della centralina tramite l'apposita funzione presente nella strumentazione di bordo (§ 4.4.10.).



CAUTELA

Per evitare danni all'impianto elettrico non tenere premuto il pulsante per un tempo superiore ai 5 secondi consecutivi. Se il motore non si avvia dopo alcuni tentativi, consultare il capitolo "GUASTI" nel presente manuale.

Comando Acceleratore

Questo dispositivo consente di regolare l'alimentazione del motore variandone così il regime di rotazione. Per azionare il dispositivo occorre ruotare la manopola dalla posizione di riposo, corrispondente alla condizione di regime minimo del motore.



ATTENZIONE

Nel caso in cui la Vostra motocicletta sia caduta o sia rimasta coinvolta in un incidente, fare controllare la funzionalità del comando acceleratore presso un centro assistenza autorizzato MV Agusta prima di riprendere la marcia.





Leva Freno Anteriore

Questo comando permette di azionare attraverso un circuito idraulico l'impianto frenante della ruota anteriore.

Sistema antibloccaggio ABS *

Alcuni modelli F4 sono equipaggiati con un sistema di frenatura servoassistito ABS ("Antilock Braking System"), che impedisce il bloccaggio delle ruote durante le frenate di emergenza garantendo la stabilità del veicolo e riducendo gli spazi di arresto.



ATTENZIONE

Nel momento in cui il sistema ABS entra in funzione, è possibile avvertire delle vibrazioni sulla leva o sul pedale del freno. In tal caso si raccomanda di mantenere la pressione sui dispositivi di azionamento dei freni per permettere al veicolo di completare l'operazione di arresto.



ATTENZIONE

Un eventuale malfunzionamento o la disattivazione del sistema ABS vengono segnalati dall'accensione dell'apposita spia presente sul cruscotto (vedi § 3.7.1.). Nel momento in cui la spia si accende, la funzione antibloccaggio potrebbe non essere più disponibile. In caso di anomalia, si raccomanda di proseguire la marcia a velocità ridotta e contattare un centro assistenza autorizzato MV Agusta. In caso di disattivazione, procedere con la selezione della funzione ABS (vedi § 4.4.7.).

(*): Funzione presente solo su alcuni modelli





3.5. Interruttore accensione e bloccasterzo



ATTENZIONE

Non applicare portachiavi o altri oggetti alla chiave di accensione per non creare ostacoli alla rotazione dello sterzo.



ATTENZIONE

Non tentare di cambiare alcuna funzione dell'interruttore durante la marcia; si potrebbe incorrere nella perdita di controllo del mezzo.

L'interruttore di accensione attiva e disattiva il circuito elettrico ed il bloccasterzo; le quattro posizioni di comando sono di seguito descritte.

Posizione "OFF"

Tutti i circuiti elettrici sono disattivati. La chiave può essere estratta.

Posizione "ON"

Tutti i circuiti elettrici sono attivati, la strumentazione e le spie eseguono l'autodiagnosi; il motore può essere avviato. La chiave non può essere estratta.



"OFF"



"ON"



CAUTELA

Non lasciare la chiave sulla posizione "ON" a motore spento per lungo tempo, allo scopo di evitare il danneggiamento dei componenti elettrici della motocicletta.





Posizione “LOCK”

Ruotare il manubrio a destra o a sinistra. Premere leggermente la chiave e contemporaneamente ruotarla in posizione “LOCK”.

Tutti i circuiti elettrici sono disattivati e lo sterzo è bloccato. La chiave può essere estratta.

3

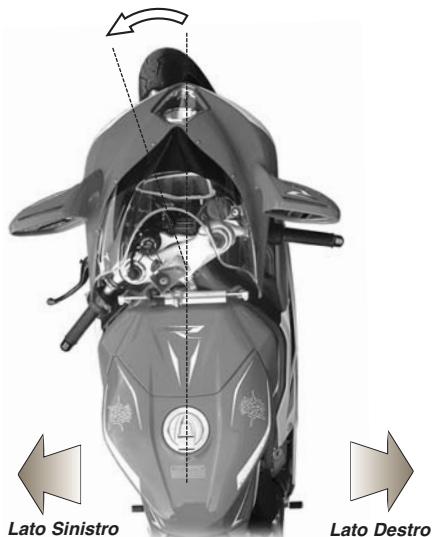



Posizione "P"

Ruotare la chiave dalla posizione "LOCK" alla posizione "P". Tutti i circuiti elettrici sono disattivati tranne le luci di parcheggio (luci di posizione) e lo sterzo è bloccato. La chiave può essere estratta.



CAUTELA

Non lasciare la chiave sulla posizione "P" per lungo tempo, allo scopo di evitare di scaricare la batteria della motocicletta.



3





3.6. Comando cambio

La posizione **N** “Neutral” corrisponde alla posizione di folle segnalata dalla relativa spia cruscotto.

Spostando la leva del cambio verso il basso si innesta la prima marcia.

Analogamente, spostando la leva verso l’alto si innesta la seconda marcia; continuando più volte a spostare la leva verso l’alto si innestano, in modo sequenziale, tutte le altre marce fino alla sesta.

☐ Funzione “Quick Shift”

Il modello F4 RR è equipaggiato con un sistema di cambio rapido (“Quick Shift”), che permette di aumentare il rapporto di marcia senza tirare la leva frizione né agire sul comando acceleratore. In questo modo, è possibile innestare una marcia superiore mantenendo costante l’accelerazione e riducendo al minimo il tempo di variazione del rapporto. Tale sistema non è disponibile quando si cambia rapporto con la leva frizione tirata o ad una velocità inferiore a 30 km/h, né innestando una marcia inferiore a quella attualmente utilizzata.

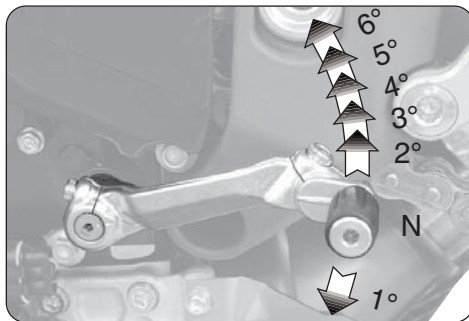

ATTENZIONE: Quando si guida il veicolo utilizzando una marcia bassa ad un elevato numero di giri motore, cambiare rapporto senza utilizzare la leva frizione può causare brusche reazioni del veicolo che possono comprometterne la stabilità. MV Agusta consiglia di utilizzare la leva frizione in tali circostanze, in particolare quando il numero di giri del motore si avvicina al regime di intervento del limitatore.





3.7. Strumentazione e spie

Gli strumenti e le spie si attivano ruotando la chiave di accensione in posizione "ON". Dopo un check-up iniziale (~ 7 secondi) le informazioni corrispondono alle condizioni generali della motocicletta in quel momento.

Spie luminose di indicazione (§3.7.1.)

Display contagiri



Pulsante "SET" (§3.7.2.)

Pulsante "OK" (§3.7.2.)

Pulsante "HAZARD" (§3.7.2.)

Display multifunzione (§3.7.2.)





3.7.1. Spie luminose di indicazione

Spia luce abbagliante (blu)

Si accende quando è attivata la luce abbagliante.

Spia indicatori di direzione/ Spia "Hazard" (verde)

Si accende quando sono attivati gli indicatori di direzione o le luci di emergenza (vedi §3.7.2.).

Spia cambio in folle (verde)

Si accende quando il cambio è nella posizione folle "Neutral".

Spia ABS (arancio) *

Si accende quando il sistema ABS è disattivato, quando si verifica un malfunzionamento oppure a velocità inferiori a 5 km/h.



Pericolo - Attenzione: Se si accende durante l'uso del veicolo, fermarsi immediatamente e verificare che la funzione ABS sia attivata (vedi §4.4.7.). In caso positivo, proseguire la marcia a velocità ridotta e contattare un centro assistenza autorizzato MV Agusta.

(*): Funzione presente solo su alcuni modelli



Spia pressione olio motore (rosso)

Si accende quando l'olio è ad una pressione insufficiente.



Pericolo - Attenzione: Se si accende durante la marcia, fermarsi immediatamente, controllare il livello dell'olio e se necessario farne effettuare il rabbocco presso un centro assistenza autorizzato MV Agusta (vedi §3.8). Se la spia si accende nonostante il livello sia corretto, non proseguire la marcia e contattare un centro assistenza autorizzato MV Agusta.

Spia limitatore giri (rosso)

Si accende quando il motore supera i 10800 rpm; il limitatore interviene a 13500 rpm.

Spia riserva carburante (arancio)

Si accende quando nel serbatoio sono contenuti circa 4 litri di carburante.

Spia cavalletto laterale (rosso)

Si accende quando il cavalletto laterale è abbassato.

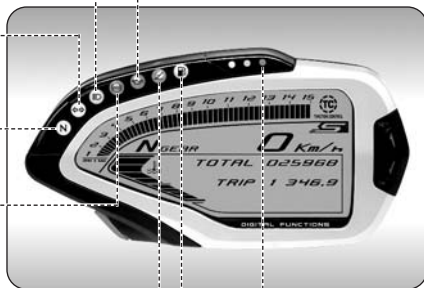



3.7.2. Display multifunzione

Display rapporto cambio

Indica il rapporto del cambio attualmente inserito. La posizione di folle è indicata con la lettera "N" (neutral).

Termometro

Indica la temperatura del liquido di raffreddamento tramite l'accensione di un numero variabile di segmenti su una scala di misura graduata. Quando la temperatura si trova al di fuori del campo di funzionamento normale, possono apparire le seguenti indicazioni:

- sul display compare un unico segmento lampeggiante; è il segnale di temperatura bassa;
- tutti i segmenti sono accesi mentre il segmento superiore lampeggia; è il segnale di temperatura alta.



Pericolo - Attenzione: in caso di temperatura alta, arrestare la motocicletta e controllare il livello del liquido di raffreddamento. Nel caso in cui fosse necessario rabboccarlo, rivolgersi presso un centro assistenza autorizzato MV Agusta (vedi § 3.8). Se l'indicazione compare nonostante il livello sia corretto, non proseguire la marcia e contattare un centro assistenza autorizzato MV Agusta.

Tachimetro

Indica la velocità. Il valore può apparire in chilometri orari (Km/h) oppure in miglia orarie (Mph). Il valore a fondo scala è di 350 Km/h (217 Mph).

Mappatura centralina

Indica la modalità selezionata della centralina iniezione.

Pulsante "SET"

Se premuto, consente di selezionare le cifre del display per effettuare le regolazioni.

Pulsante "OK"

Se premuto, consente di confermare le cifre impostate.

Pulsante "HAZARD"

Se premuto, attiva le luci di emergenza.

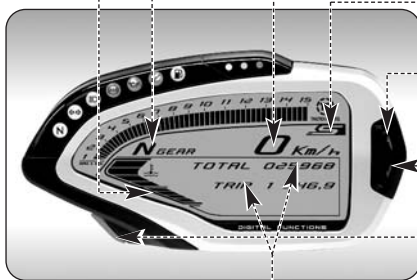

Contachilometri totale "TOTAL"

Indica la percorrenza totale; da 0 a 99999.9 (Km o mi)

Contachilometri parziale 1 "TRIP 1"

Indica la percorrenza parziale; da 0 a 9999.9 (Km o mi)

Contachilometri parziale 2 "TRIP 2"

Indica la percorrenza parziale; da 0 a 9999.9 (Km o mi)

Cronometro

Indica i tempi misurati con la funzione cronometro





3.8. Tabella lubrificanti e liquidi

Descrizione	Prodotto consigliato	Specifiche
Olio lubrificazione motore	eni i-Ride motoGP 10W-60 (*)	SAE 10W-60 - API SG
Liquido di raffreddamento	Agip Eco - Permanent	Glicole - Etilenico diluito con 50% di acqua distillata
Fluido comando frizione e freni	Agip Brake 4	DOT4
Olio lubrificazione catena	D.I.D. CHAIN LUBE	-

* : Per la reperibilità del prodotto consigliato, MV Agusta consiglia di rivolgersi direttamente ai propri concessionari autorizzati. L'olio motore eni i-Ride motoGP 10W-60 è stato realizzato appositamente per il motore del motociclo F4. Qualora il lubrificante descritto non fosse reperibile, MV Agusta consiglia l'utilizzo di olii completamente sintetici con caratteristiche conformi o superiori alle seguenti normative:

- Conforme API SG
- Conforme ACEA A3
- Conforme JASO MA
- Gradazione SAE 10 W-60

NOTA

Le specifiche sopra indicate devono essere riportate, da sole od insieme ad altre, sul contenitore dell'olio lubrificante.





4.1. Uso della motocicletta

In questa sezione vengono esposti gli argomenti principali per il corretto uso della motocicletta.



ATTENZIONE

Il Vostro motociclo presenta elevate caratteristiche di potenza e prestazioni; per il suo uso è pertanto richiesto un'adeguato livello di conoscenza del mezzo. Al momento del primo utilizzo di questo veicolo è necessario adottare un atteggiamento prudente. Uno stile di guida aggressivo o avventato può esporre al rischio di incidenti, compromettendo la Vostra incolumità e quella di altre persone.



ATTENZIONE

LE LIMITAZIONI RELATIVE ALL'USO CONSENTITO DEL VEICOLO SONO RIPORTATE NELLA SEZIONE "INFORMAZIONI PER LA SICUREZZA".



CAUTELA

Le alte temperature derivanti dall'impiego del veicolo in pista potrebbero compromettere l'efficienza del convertitore catalitico e dell'impianto di scarico; pertanto durante l'uso in pista si consiglia di utilizzare un impianto di scarico speciale.





4.2. Rodaggio



Cautela - Precauzione: l'inosservanza delle indicazioni di seguito riportate può pregiudicare la durata e le prestazioni della motocicletta.

È uso comune considerare il rodaggio come una fase applicata al solo motore. In realtà esso va considerato anche per altre parti importanti della moto, in particolare i pneumatici, i freni, la catena di trasmissione, ecc. Nei primissimi chilometri adottare una guida tranquilla.

4

□ Da 0 a 500 Km (da 0 a 300 mi) (A)

Durante questa percorrenza variare frequentemente il regime di rotazione del motore. Se possibile, privilegiare percorsi leggermente collinosi, con molte curve ed evitare lunghi tratti rettilinei.



ATTENZIONE

I pneumatici nuovi devono essere sottoposti ad un adeguato rodaggio per raggiungere la completa efficienza. Evitare le accelerazioni, le curve e le frenate brusche per i primi 100 km. Se non si osserva un periodo di rodaggio iniziale dei pneumatici, si rischia di slittare o di perdere il controllo del veicolo con conseguente pericolo di incidenti.





❑ **Da 500 a 1000 Km (da 300 a 600 mi)**

Durante questa percorrenza evitare di mantenere a lungo il motore sotto sforzo.



❑ **Da 1000 a 2500 Km (da 600 a 1600 mi)**

Durante questa percorrenza è possibile pretendere maggiori prestazioni dal motore, senza tuttavia superare il regime di rotazione indicato.

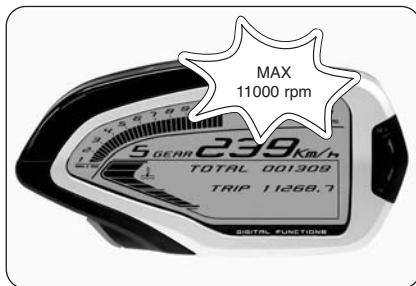



4.3. Avviamento motore



ATTENZIONE

Far funzionare il motore in un ambiente chiuso può essere pericoloso. I gas di scarico contengono monossido di carbonio, un gas incolore ed inodore che può provocare decessi o infortuni gravi. Fare funzionare il motore solo all'esterno, all'aria aperta.



► Ruotando l'interruttore d'accensione in posizione "ON", la strumentazione e le spie eseguono l'autodiagnosi; durante questa fase, accertarsi dell'accensione di tutte le spie presenti sul cruscotto.

► Affinché il sistema di interruzione del circuito di accensione dia il consenso all'avviamento, deve essere stata soddisfatta una delle seguenti condizioni:

- Il cambio è in posizione di folle.
- Il cambio è innestato su una marcia con la leva della frizione tirata ed il cavalletto laterale alzato.





► Nel caso in cui l'autodiagnosi riscontri la presenza di un guasto al veicolo, sul display compare la schermata di errore mostrata nella figura a lato. In particolare viene evidenziato il gruppo o il componente della motocicletta su cui è stato riscontrato il malfunzionamento.

► Premendo il pulsante "OK", il cruscotto passa alla modalità "RUN".

**ATTENZIONE**

In caso di segnalazione di un guasto al veicolo, non avviare il motore e contattare un centro assistenza autorizzato MV Agusta.





❑ Procedura di avviamento

- ▶ Premere il pulsante di avviamento motore senza ruotare la manopola dell'acceleratore.
- ▶ Appena il motore si è avviato rilasciare il pulsante.



Cautela - Precauzione:

- Per evitare danni all'impianto elettrico non azionare l'avviamento per più di 5 secondi consecutivi.
 - Non far funzionare a lungo il motore a motocicletta ferma. Il conseguente surriscaldamento può danneggiare i componenti interni del motore.
- È preferibile portare il motore alla temperatura di esercizio ponendosi in marcia ad andatura ridotta.
- Per allungare al massimo la vita del motore, non accelerare a fondo quando il motore è freddo.

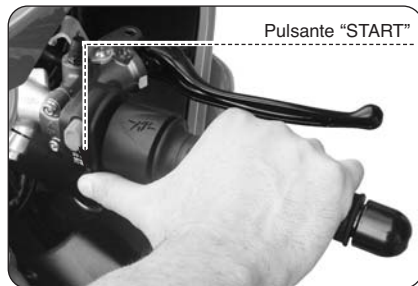



4.4. Selezione e modifica delle funzioni display

La strumentazione prevede la possibilità di intervenire su alcuni dei parametri principali di misurazione. Le operazioni possibili sono :

- Selezione delle modalità di funzionamento:
 - “RUN” (Contachilometri)
 - “TC” (Controllo trazione)
 - “CHRONO” (Cronometro)
 - “NIGHT/DAY” (Modalità Notte/Giorno)
 - “SETTING ÖHLINS” (Regolazione elettronica delle sospensioni)
 - “ABS” (Sistema antibloccaggio)*
 - “QUICK SHIFT” (Cambio rapido)
- Azzeramento delle funzioni contachilometri parziali:

Contachilometri	Parziale 1	“TRIP 1”
Contachilometri	Parziale 2	“TRIP 2”
- Funzione “IMMOBILIZER” (Sistema antifurto)
- Selezione mappatura centralina

(*): Funzione presente solo su alcuni modelli





4.4.1. Selezione funzioni display

La selezione riguarda le seguenti modalità di funzionamento:

- “RUN” (Contachilometri)
- “TC” (Controllo trazione)
- “CHRONO” (Cronometro)
- “NIGHT/DAY” (Modalità Notte/Giorno)
- “SETTING ÖHLINS” (Regolazione elettronica delle sospensioni)
- “ABS” (Sistema antibloccaggio)*
- “QUICK SHIFT” (Cambio rapido)

La visualizzazione delle varie modalità di funzionamento avviene premendo il pulsante “SET” per un tempo inferiore a tre secondi. Agendo su tale pulsante appaiono sul display le funzioni in modo ciclico. Selezionare la funzione desiderata.

(*): Funzione presente solo su alcuni modelli



ATTENZIONE

Le operazioni di modifica o regolazione delle funzioni display devono essere eseguite con motore spento, cambio in folle, motocicletta ferma e piedi a terra. È vietato cambiare le impostazioni del display durante la marcia.



□ Modalità “RUN”

Oltre alla funzione tachimetro, sul display vengono visualizzate le seguenti funzioni (vedi §4.4.2.):

- Contachilometri Totale “TOTAL”
- Contachilometri Parziale 1 “TRIP 1”

In alternativa:

- Contachilometri Totale “TOTAL”
- Contachilometri Parziale 2 “TRIP 2”

□ Modalità “TC”

La presente funzione permette di adattare il livello del controllo di trazione del motore secondo le proprie esigenze di guida (vedi §4.4.3.).





❑ Modalità “CHRONO”

Questa modalità permette l'attivazione della funzione cronometro e l'immagazzinamento dei dati misurati (vedi §4.4.4.). Le funzioni visualizzate diventano:

- Cronometro Giro attuale “CURRENT LAP”
- Cronometro Giro più veloce “BEST LAP”
- Cronometro Giro precedente “LAST LAP”
- Contagiri Totale giri percorsi “N° LAP”



❑ Modalità “NIGHT/DAY”

La presente funzione consente di invertire il colore di fondo del display, per adattarne la visibilità durante l'uso diurno o notturno del veicolo (vedi §4.4.5.).





□ Modalità “SETTING ÖHLINS”

Questa modalità permette di effettuare la regolazione dei seguenti dispositivi (vedi §4.4.6.):

- Sospensione anteriore
- Sospensione posteriore
- Ammortizzatore di sterzo

□ Modalità “ABS” *

La presente funzione permette di attivare o disattivare il sistema antibloccaggio ABS del sistema frenante (vedi §4.4.7.).



(*): Funzione presente solo su alcuni modelli





❑ Modalità “QUICK SHIFT”

Questa modalità permette di attivare o disattivare la funzione di cambio rapido del rapporto di trasmissione (vedi §4.4.8.).





4.4.2. Azzeramento delle funzioni contachilometri parziali

I valori delle funzioni “TRIP 1” e “TRIP 2” possono essere azzerati nel modo seguente.



ATTENZIONE

Le operazioni di modifica o regolazione delle funzioni display devono essere eseguite con motore spento, cambio in folle, motocicletta ferma e piedi a terra. È vietato cambiare le impostazioni del display durante la marcia.

- ▶ Accedere alla modalità “RUN”; nella schermata iniziale vengono visualizzate le funzioni contachilometri totale (“TOTAL”) e contachilometri parziale 1 (“TRIP 1”).
- ▶ Premendo ora il pulsante “OK” per un tempo superiore a tre secondi il valore “TRIP 1” si azzer.





► Premere il pulsante “OK” per un tempo inferiore a tre secondi fino alla visualizzazione della funzione contachilometri parziale 2 (“TRIP 2”).



► Premendo ora il pulsante “OK” per un tempo superiore a tre secondi il valore “TRIP 2” si azzerà.





4.4.3. Modalità "TC"

► Premere il pulsante "SET" per accedere alla modalità "TC", quindi premere il pulsante "OK" per un tempo inferiore ai tre secondi fino alla visualizzazione della scritta "TC LEVEL". L'attuale livello del controllo di trazione corrisponde al valore visualizzato sul display.



ATTENZIONE

Le operazioni di modifica o regolazione delle funzioni display devono essere eseguite con motore spento, cambio in folle, motocicletta ferma e piedi a terra. È vietato cambiare le impostazioni del display durante la marcia.

► Premendo il pulsante "OK" per un tempo inferiore a tre secondi, il livello del controllo di trazione viene incrementato passando al valore successivo. Premendo il pulsante "SET" per un tempo inferiore a tre secondi, il livello del controllo di trazione viene diminuito passando al valore precedente. Tale valore può variare tra **0** e **8**.

► Premere il pulsante "OK" per un tempo superiore a tre secondi; il valore prescelto del livello del controllo di trazione viene confermato.

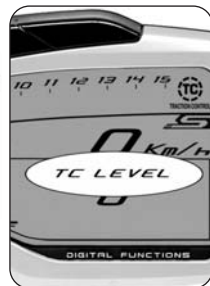

4

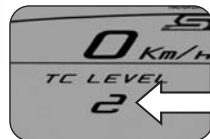
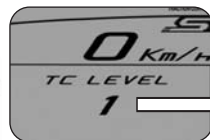



4.4.4. Cronometro

❑ Acquisizione dei tempi sul giro

► Dopo aver attivato la funzione cronometro (modalità “CHRONO”) è possibile iniziare l’acquisizione dei dati relativi ai tempi di percorrenza sul giro.



► L’azionamento del pulsante del lampeggio faro abbagliante determina l’inizio della misurazione dei dati. I puntini che separano i minuti dai secondi e dai decimi di secondo iniziano a lampeggiare. Lo strumento sta acquisendo i tempi.

NOTA: Quando la modalità “CHRONO” è attiva, il primo azionamento del pulsante di lampeggio faro abilita automaticamente la funzione “TC”. Da questo momento è possibile modificare il livello del controllo di trazione con effetto immediato utilizzando opportunamente i tasti “SET” e “OK” (vedi §4.4.3.).





► Premendo nuovamente il pulsante del lampeggio fanale abbagliante viene registrata la misurazione del tempo relativo al 1° giro percorso. Contemporaneamente lo strumento inizia ad acquisire il tempo relativo al secondo giro.

La misurazione del tempo relativo al primo giro viene conservata in memoria e rimane visualizzata sul display per dieci secondi, quindi si procede con la visualizzazione del tempo sul giro successivo.

► Continuando nell'utilizzo del cronometro, ad ogni azionamento del pulsante di lampeggio viene registrato un tempo. Lo strumento ha la possibilità di eseguire un numero massimo di 100 memorizzazioni consecutive.

Durante la visualizzazione del tempo sul giro appena concluso, sul display compare il simbolo “+” oppure “-” nel caso in cui il tempo rilevato sia rispettivamente inferiore o superiore al tempo misurato durante il giro precedente.

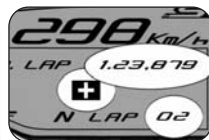
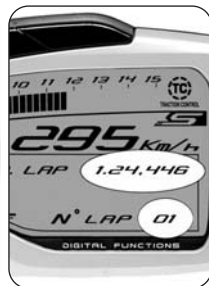



Visualizzazione dei dati

Terminata la fase di acquisizione tempi è possibile eseguirne la visualizzazione.

► Accedere alla modalità “CHRONO”; in questa schermata viene visualizzato il tempo sul giro più veloce (“BEST LAP”) ed il tempo sull’ultimo giro percorso (“LAST LAP”).



ATTENZIONE

Le operazioni di modifica o regolazione delle funzioni display devono essere eseguite con motore spento, cambio in folle, motocicletta ferma e piedi a terra. È vietato cambiare le impostazioni del display durante la marcia.

► Premere il pulsante “OK” per un tempo inferiore a tre secondi fino alla visualizzazione della scritta “LAPS VIEW”.





► La ripetuta pressione del pulsante “OK” consente di visualizzare in sequenza tutti i tempi precedentemente acquisiti a partire dall’ultimo giro memorizzato.

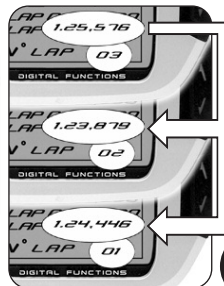

4

► Al termine della visualizzazione dei dati, la pressione del pulsante “SET” consente di tornare alla modalità “LAPS VIEW” per passare alla modalità successiva.

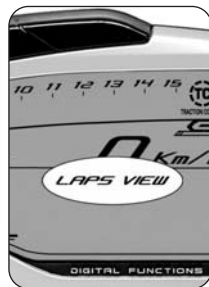



❑ Cancellazione dei dati

L'operazione di cancellazione dei dati memorizzati si esegue applicando le seguenti procedure:



ATTENZIONE

Le operazioni di modifica o regolazione delle funzioni display devono essere eseguite con motore spento, cambio in folle, motocicletta ferma e piedi a terra. È vietato cambiare le impostazioni del display durante la marcia.



► *Cancellazione tempi singoli:* Accedere alla modalità "CHRONO" e premere il pulsante "SET" per un tempo inferiore a tre secondi fino alla visualizzazione della scritta "SINGLE LAP RESET".

► Premere il pulsante "OK" per un tempo inferiore a tre secondi; il valore dell'ultimo tempo sul giro memorizzato inizia a lampeggiare.

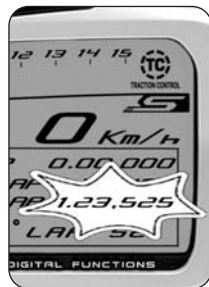



► Premendo ora il pulsante “OK” per un tempo superiore a tre secondi il valore viene cancellato.
Se invece si preme il pulsante “SET” per un tempo inferiore ai tre secondi la procedura di cancellazione viene interrotta.



► Successivamente, la pressione del pulsante “OK” per un tempo superiore a tre secondi consente di cancellare in sequenza tutti i tempi precedentemente acquisiti.

► Al termine della cancellazione dei dati, la pressione del pulsante “SET” consente di tornare alla modalità “LAPS VIEW” per passare alla modalità successiva.





► *Cancellazione miglior tempo*: Accedere alla modalità "LAPS VIEW" e premere il pulsante "SET" per un tempo inferiore a tre secondi fino alla visualizzazione della scritta "BEST LAP RESET".



► Premere il pulsante "OK" per un tempo inferiore a tre secondi; il valore del tempo sul giro più veloce inizia a lampeggiare.

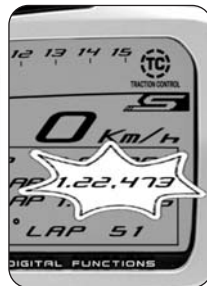



► Premendo ora il pulsante “OK” per un tempo superiore a tre secondi il valore viene cancellato. Se invece si preme il pulsante “SET” per un tempo inferiore a tre secondi la procedura di cancellazione viene interrotta.

► Al termine della cancellazione dei dati, il display mostra la scritta “LAP TIME ERASED” per poi tornare alla modalità “LAPS VIEW”.

► *Cancellazione di tutti i tempi memorizzati:* Accedere alla modalità “LAPS VIEW” e premere il pulsante “SET” per un tempo inferiore ai tre secondi fino alla visualizzazione della scritta “ALL LAPS RESET”.





► Premere il pulsante “OK” per un tempo inferiore a tre secondi; il display richiede la conferma per la cancellazione di tutti i dati presenti in memoria.



► Premendo ora il pulsante “OK” per un tempo superiore a tre secondi tutti i tempi precedentemente acquisiti vengono cancellati.

Se invece si preme il pulsante “SET” per un tempo inferiore a tre secondi la procedura di cancellazione viene interrotta.

► Al termine della cancellazione dei dati, il display mostra la scritta “ALL LAPS ERASED” per poi tornare alla modalità “LAPS VIEW”.





4.4.5. Modalità “NIGHT/DAY”

► Per convertire il colore di fondo del display, accedere alla modalità “NIGHT/DAY MODE” e premere il pulsante “OK” per un tempo inferiore a tre secondi.



ATTENZIONE

Le operazioni di modifica o regolazione delle funzioni display devono essere eseguite con motore spento, cambio in folle, motocicletta ferma e piedi a terra. È vietato cambiare le impostazioni del display durante la marcia.

► La pressione del pulsante “SET” consente di passare in modo ciclico dalla visualizzazione diurna a quella notturna del display.

► Una volta definito il colore di fondo del display, la pressione del pulsante “OK” per un tempo superiore a tre secondi consente di confermare la visualizzazione prescelta e di tornare alla modalità “NIGHT/DAY MODE”. Lo sfondo così definito verrà mantenuto in tutte le successive modalità di utilizzo del cruscotto.

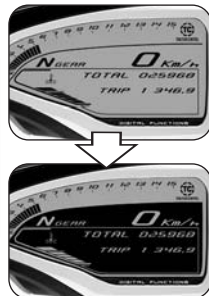
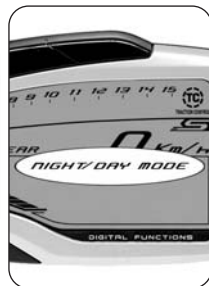



4.4.6. Regolazione elettronica delle sospensioni

► Per eseguire la regolazione personalizzata dell'assetto delle sospensioni, premere il pulsante "SET" fino ad accedere alla modalità "SETTING ÖHLINS".



ATTENZIONE: Le operazioni di modifica o regolazione delle funzioni display devono essere eseguite con motore spento, cambio in folle, motocicletta ferma e piedi a terra. È vietato cambiare le impostazioni del display durante la marcia.

NOTA: La regolazione delle sospensioni è consentita solo nel caso in cui sia selezionata la mappatura "C" della centralina (vedi §4.4.10.)

NOTA: Per i valori di taratura consigliati, riferirsi alla tabella sospensioni allegata al manuale.

□ Frenatura in compressione (Sospensione anteriore)

► Premendo il pulsante "OK" per un tempo inferiore a tre secondi, il display mostra i possibili parametri di regolazione delle sospensioni.

► Dopo alcuni secondi le scritte "FRONT" e "C" iniziano a lampeggiare; è ora possibile modificare i valori di frenatura in compressione della sospensione anteriore.





► Premendo il pulsante “OK” per un tempo inferiore a tre secondi, il livello della frenatura in compressione viene incrementato passando al valore successivo. Tale valore può variare tra **1** e **26**.

► Premere il pulsante “OK” per un tempo superiore a tre secondi; il valore prescelto della frenatura in compressione viene confermato e il display passa alla regolazione successiva. Se invece si preme il pulsante “SET” per un tempo inferiore ai tre secondi la procedura di regolazione viene interrotta, salvando le impostazioni e tornando al menu principale.

□ Frenatura in estensione (Sospensione anteriore)

► Dopo alcuni secondi le scritte “FRONT” e “R” iniziano a lampeggiare; è ora possibile modificare i valori di frenatura in estensione della sospensione anteriore.

► Premendo il pulsante “OK” per un tempo inferiore a tre secondi, il livello della frenatura in estensione viene incrementato passando al valore successivo. Tale valore può variare tra **1** e **26**.

► Premere il pulsante “OK” per un tempo superiore a tre secondi; il valore prescelto della frenatura in estensione viene confermato.



4 E

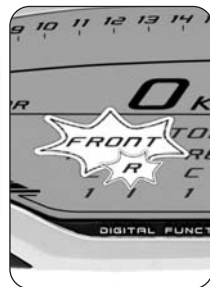



❑ Frenatura in compressione (Sospensione posteriore)

► Dopo alcuni secondi le scritte "REAR" e "C" iniziano a lampeggiare; è ora possibile modificare i valori di frenatura in compressione della sospensione posteriore.

► Premendo il pulsante "OK" per un tempo inferiore a tre secondi, il livello della frenatura in compressione viene incrementato passando al valore successivo. Tale valore può variare tra **1** e **26**.

► Premere il pulsante "OK" per un tempo superiore a tre secondi; il valore prescelto della frenatura in compressione viene confermato.

❑ Frenatura in estensione (Sospensione posteriore)

► Dopo alcuni secondi le scritte "REAR" e "R" iniziano a lampeggiare; è ora possibile modificare i valori di frenatura in estensione della sospensione posteriore.

► Premendo il pulsante "OK" per un tempo inferiore a tre secondi, il livello della frenatura in estensione viene incrementato passando al valore successivo. Tale valore può variare tra **1** e **26**.

► Premere il pulsante "OK" per un tempo superiore a tre secondi; il valore prescelto della frenatura in estensione viene confermato.





□ Ammortizzatore di sterzo

- ▶ Dopo alcuni secondi il display mostra le modalità di regolazione dell'ammortizzatore di sterzo ("AUTO": automatica; "MANUAL": personalizzata).
- ▶ Premendo il pulsante "OK" per un tempo inferiore a tre secondi, la scritta "AUTO" inizia a lampeggiare.
- ▶ Premendo il pulsante "SET" per un tempo inferiore a tre secondi, la scritta "MANUAL" inizia a lampeggiare; premendo il pulsante "OK" per un tempo superiore a tre secondi viene abilitata la modifica dei valori di frenatura dell'ammortizzatore di sterzo.
- ▶ Premendo il pulsante "OK" per un tempo inferiore a tre secondi, il livello di frenatura dell'ammortizzatore di sterzo viene incrementato passando al valore successivo. Tale valore può variare tra **1** e **14**.
- ▶ Premere il pulsante "OK" per un tempo superiore a tre secondi; il valore prescelto della frenatura viene confermato e il display torna alla modalità di regolazione sospensioni. Se invece si preme il pulsante "SET" per un tempo inferiore ai tre secondi la procedura di regolazione viene interrotta e i nuovi valori di taratura vengono confermati.

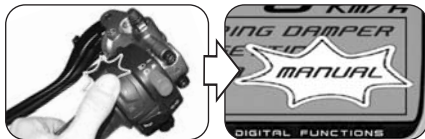
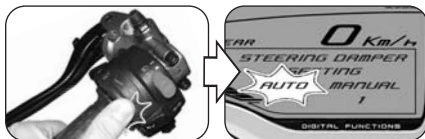

4





4.4.7. Selezione della funzione ABS *

► Premere il pulsante “SET” per accedere alla modalità “ABS”; sul display viene visualizzata la scritta “SETTING ABS”.



ATTENZIONE

Le operazioni di modifica o regolazione delle funzioni display devono essere eseguite con motore spento, cambio in folle, motocicletta ferma e piedi a terra. È vietato cambiare le impostazioni del display durante la marcia.

► Premendo il pulsante “OK” per un tempo inferiore a tre secondi, sul display viene visualizzata l’ultima selezione memorizzata. In condizioni standard, appare la scritta lampeggiante “ABS NORMAL” (*funzione ABS per uso su strada*).

► Se non si preme alcun pulsante, dopo tre secondi la selezione “ABS NORMAL” viene confermata; in questa condizione viene attivata la funzione ABS per uso su strada. Premere il pulsante “SET” per uscire dalla modalità “ABS”.

(*): Funzione presente solo su alcuni modelli





► Se invece si preme il pulsante “OK” mentre l’indicazione lampeggia, la scritta sul display passa a “ABS RACE” (funzione ABS per uso su pista).

 **ATTENZIONE:** La modalità “ABS RACE” è stata studiata esclusivamente per l’uso del veicolo in pista. MV Agusta consiglia di non utilizzare tale funzione quando si percorrono strade pubbliche.

► Se non si preme alcun pulsante, dopo tre secondi la selezione “ABS RACE” viene confermata. Se invece si preme il pulsante “OK” mentre l’indicazione lampeggia, la scritta sul display passa a “ABS OFF”.

► Se non si preme alcun pulsante, dopo tre secondi la selezione “ABS OFF” viene confermata; in questa condizione il sistema ABS è disattivato.

 **ATTENZIONE:** La disattivazione del sistema ABS viene indicata dall’accensione della relativa spia sul cruscotto (vedi §3.7.1.). In questa condizione la funzione antibloccaggio del sistema frenante non è disponibile. Adottare particolare cautela nella guida e ridurre la velocità per mantenere il controllo del veicolo durante le frenate di emergenza.

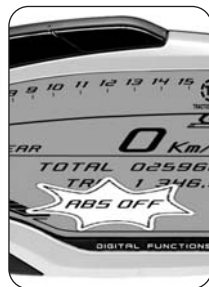
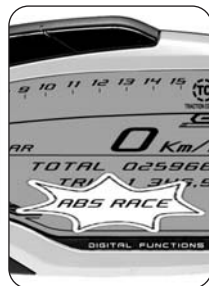



4.4.8. Modalità “QUICK SHIFT”

► Premere il pulsante “SET” per accedere alla modalità “QUICK SHIFT”. Il display mostra lo stato di attivazione della funzione cambio rapido (“ON”: attivata; “OFF”: disattivata).



ATTENZIONE

Le operazioni di modifica o regolazione delle funzioni display devono essere eseguite con motore spento, cambio in folle, motocicletta ferma e piedi a terra. È vietato cambiare le impostazioni del display durante la marcia.

► Premendo il pulsante “OK” per un tempo inferiore a tre secondi, l’indicazione relativa allo stato di attivazione della funzione cambio rapido inizia a lampeggiare.

► Premendo il pulsante “OK” per un tempo inferiore a tre secondi, l’indicazione passa da “OFF” a “ON” o viceversa.

► Dopo alcuni secondi, lo stato di attivazione selezionato del cambio rapido viene automaticamente confermato.





4.4.9. Funzione “IMMOBILIZER”

La funzione “IMMOBILIZER” consente l’avviamento del motore solamente a seguito del riconoscimento della chiave di avviamento originale. Di fatto essa rappresenta un sistema antifurto integrato nel circuito elettronico del veicolo, dal momento che ne impedisce l’utilizzo a qualunque soggetto non autorizzato.

La modalità “IMMOBILIZER” del cruscotto deve essere utilizzata solamente in caso di malfunzionamento. Infatti, se per un motivo qualsiasi il sistema non risulta in grado di riconoscere il codice della chiave di avviamento, per ottenere il consenso all’avviamento del motore è necessario inserire manualmente il codice segreto riportato sulla MV Code Card ricevuta al momento della consegna del veicolo.

- ▶ Rimuovere la copertura dal riquadro presente sul retro della MV Code Card e leggere il codice elettronico segreto relativo alla chiave di avviamento (nella figura è rappresentato un codice casuale a puro titolo indicativo).
- ▶ Partendo dalla modalità “RUN”, premere i pulsanti “SET” e “OK” per un tempo superiore a tre secondi per accedere alla modalità “IMMOBILIZER”.

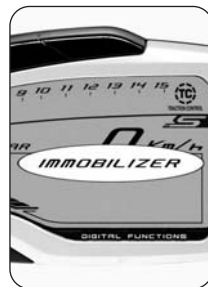

**ATTENZIONE**

Le operazioni di modifica o regolazione delle funzioni display devono essere eseguite con motore spento, cambio in folle, motocicletta ferma e piedi a terra. È vietato cambiare le impostazioni del display durante la marcia.

- ▶ Premere il pulsante “OK” per un tempo inferiore a tre secondi per impostare la prima cifra del codice.
- ▶ La pressione del pulsante “OK” per un tempo inferiore a tre secondi consente di variare tra **0** e **9** il valore relativo alla prima cifra.
- ▶ Una volta selezionata la cifra prescelta, premere il pulsante “OK” per un tempo superiore a tre secondi; la prima cifra del codice viene confermata. È ora possibile impostare la seconda cifra del codice.
- ▶ Operando in maniera analoga, è possibile procedere con l'impostazione delle quattro cifre rimanenti.

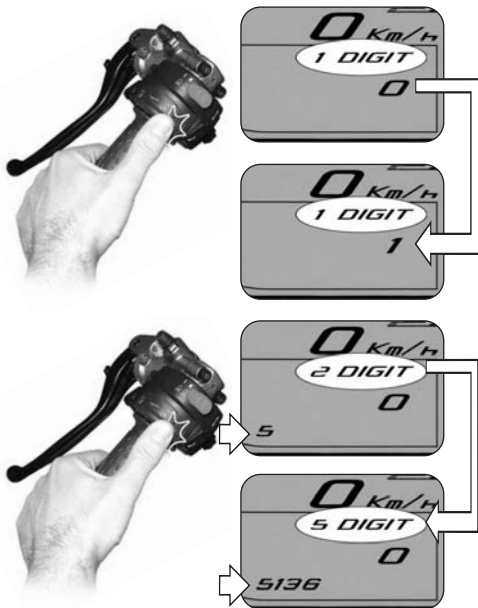



► Una volta completata la procedura di inserimento del codice, sul display compare la scritta “CONFIRM CODE”. Premere il pulsante “OK” per un tempo superiore a tre secondi per confermare il codice inserito.

► Se il codice inserito viene correttamente riconosciuto dal sistema, compare la scritta “VALID CODE”. Il display del cruscotto ritorna alla modalità “RUN”. È possibile avviare il motore.

► Se il codice inserito è errato, compare la scritta “NOT VALID CODE”. Il sistema non dà il consenso all’avviamento del motore; il display ritorna alla modalità “IMMOBILIZER”. Ripetere dall’inizio la procedura di inserimento del codice, facendo attenzione a impostare tutte le cifre corrette riportate sulla MV Code Card in dotazione. Nel caso si riscontrassero ulteriori problemi, contattare un centro assistenza autorizzato MV Agusta.

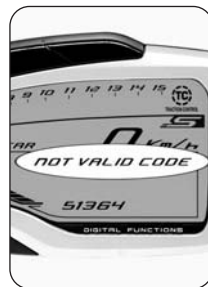
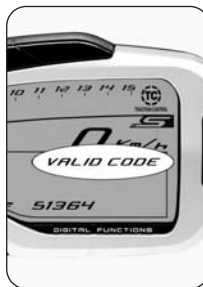
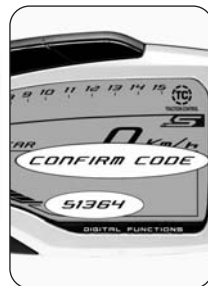



4.4.10. Selezione della mappatura centralina

Sul modello F4 RR, è possibile selezionare differenti mappature della centralina che permettono di ottenere caratteristiche variabili di potenza e prestazioni a seconda del tipo di utilizzo del veicolo.

NOTA

Le operazioni di selezione della mappatura centralina possono essere eseguite con il veicolo in movimento.

La selezione della mappatura centralina può essere effettuata premendo il pulsante di avviamento a motore acceso; in questo modo la mappatura passa al valore successivo. Le relative caratteristiche della mappatura sono elencate nella seguente tabella.

Mappatura	N	R	S	C
Modalità	Normale	Pioggia	Sportiva	Personalizzata

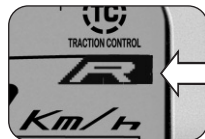
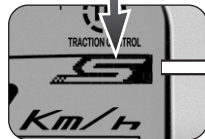



❑ Impostazione della mappatura personalizzata

► Premere il pulsante di avviamento a motore acceso fino a selezionare la mappatura “C” della centralina (mappatura personalizzata).



ATTENZIONE: Le operazioni di impostazione della mappatura personalizzata devono essere eseguite con cambio in folle, motocicletta ferma e piedi a terra. È vietato cambiare le impostazioni del display durante la marcia.

► Premere il pulsante “SET” fino alla visualizzazione della scritta “SETTING C MAP”.

Per modificare l'impostazione dei parametri della mappatura secondo le proprie esigenze, operare come di seguito descritto.

► *Sensibilità del comando acceleratore:* Premere il pulsante “OK” per un tempo inferiore ai tre secondi fino alla visualizzazione della scritta “GAS SENSITIVITY”.

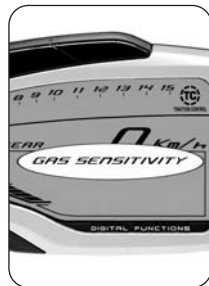



► Premere il pulsante “SET” per un tempo inferiore ai tre secondi. Sul display compare l’attuale impostazione selezionata per la sensibilità del comando acceleratore.

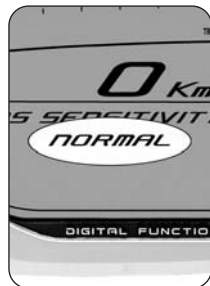

► Premere il pulsante “OK” per un tempo inferiore ai tre secondi; l’indicazione sul display inizia a lampeggiare.

► La ripetuta pressione del pulsante “OK” per un tempo inferiore ai tre secondi permette di visualizzare in sequenza le seguenti impostazioni:

- “NORMAL” (Normale)
- “RAIN” (Pioggia)
- “SPORT” (Sportiva)

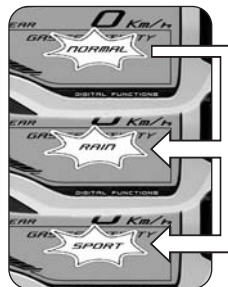



► Premere il pulsante “OK” per un tempo superiore ai tre secondi; la nuova impostazione selezionata viene confermata. L’indicazione sul display smette di lampeggiare e dopo alcuni secondi ritorna al menu “GAS SENSITIVITY”. É ora possibile passare alla regolazione del parametro successivo.

► *Coppia massima del motore:* Premere il pulsante “OK” per un tempo inferiore ai tre secondi fino alla visualizzazione della scritta “MAX ENGINE TORQUE”.

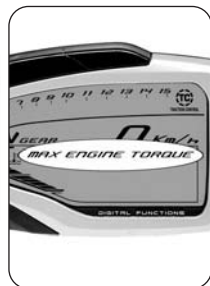



► Premere il pulsante “SET” per un tempo inferiore ai tre secondi. Sul display compare l’attuale impostazione selezionata per la coppia massima del motore.

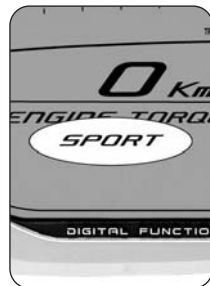

► Premere il pulsante “OK” per un tempo inferiore ai tre secondi; l’indicazione sul display inizia a lampeggiare.

► La ripetuta pressione del pulsante “OK” per un tempo inferiore ai tre secondi permette di visualizzare in sequenza le seguenti impostazioni:

- “SPORT” (Sportiva)
- “RAIN” (Pioggia)





► Premere il pulsante “OK” per un tempo superiore ai tre secondi; la nuova impostazione selezionata viene confermata. L’indicazione sul display smette di lampeggiare e dopo alcuni secondi ritorna al menu “MAX ENGINE TORQUE”.

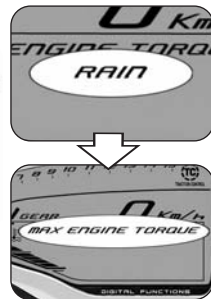

► *Freno motore:* Premere il pulsante “OK” per un tempo inferiore ai tre secondi fino alla visualizzazione della scritta “ENGINE BRAKE”.

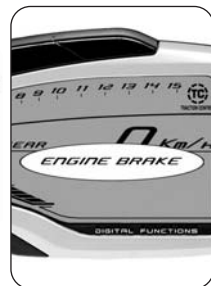



► Premere il pulsante “SET” per un tempo inferiore ai tre secondi. Sul display compare l’attuale impostazione selezionata per il freno motore.



► Premere il pulsante “OK” per un tempo inferiore ai tre secondi; l’indicazione sul display inizia a lampeggiare.

► La ripetuta pressione del pulsante “OK” per un tempo inferiore ai tre secondi permette di visualizzare in sequenza le seguenti impostazioni:

- “NORMAL” (Normale)
- “SPORT” (Sportiva)

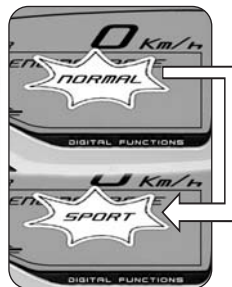



► Premere il pulsante “OK” per un tempo superiore ai tre secondi; la nuova impostazione selezionata viene confermata. L’indicazione sul display smette di lampeggiare e dopo alcuni secondi ritorna al menu “ENGINE BRAKE”.



► *Erogazione del motore:* Premere il pulsante “OK” per un tempo inferiore ai tre secondi fino alla visualizzazione della scritta “ENGINE RESPONSE”.





► Premere il pulsante “SET” per un tempo inferiore ai tre secondi. Sul display compare l’attuale impostazione selezionata per l’erogazione del motore.



► Premere il pulsante “OK” per un tempo inferiore ai tre secondi; l’indicazione sul display inizia a lampeggiare.

► La ripetuta pressione del pulsante “OK” per un tempo inferiore ai tre secondi permette di visualizzare in sequenza le seguenti impostazioni:

- “SLOW RESPONSE” (Erogazione lenta)
- “FAST RESPONSE” (Erogazione rapida)





► Premere il pulsante “OK” per un tempo superiore ai tre secondi; la nuova impostazione selezionata viene confermata. L’indicazione sul display smette di lampeggiare e dopo alcuni secondi ritorna al menu “ENGINE RESPONSE”.



► *Limitatore giri motore:* Premere il pulsante “OK” per un tempo inferiore ai tre secondi fino alla visualizzazione della scritta “RPM LIMITER”.





► Premere il pulsante “SET” per un tempo inferiore ai tre secondi. Sul display compare l’attuale impostazione selezionata per il limitatore giri motore.



► Premere il pulsante “OK” per un tempo inferiore ai tre secondi; l’indicazione sul display inizia a lampeggiare.

► La ripetuta pressione del pulsante “OK” per un tempo inferiore ai tre secondi permette di visualizzare in sequenza le seguenti impostazioni:

- “NORMAL” (Normale)
- “SPORT” (Sportiva)





► Premere il pulsante “OK” per un tempo superiore ai tre secondi; la nuova impostazione selezionata viene confermata. L’indicazione sul display smette di lampeggiare e dopo alcuni secondi ritorna al menu “RPM LIMITER”.

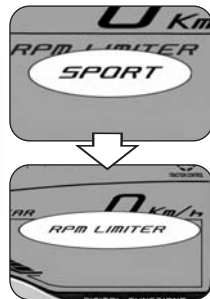

► Premere il pulsante “OK” per un tempo inferiore ai tre secondi fino alla visualizzazione del display in modalità “RUN”. La procedura di impostazione della mappatura personalizzata è così completata.





4.4.11. Messaggi di errore / malfunzionamento

Il cruscotto può segnalare la presenza di un guasto o di un malfunzionamento durante le diverse condizioni di utilizzo della motocicletta.

► *Avviamento motore:* Ruotando l'interruttore d'accensione in posizione "ON", la strumentazione e le spie eseguono l'autodiagnosi. In presenza di un guasto al veicolo, il display visualizza il messaggio di errore mostrato nella figura a lato; in particolare, viene evidenziato il gruppo o il componente della motocicletta su cui è stato riscontrato il malfunzionamento.

► Premendo il pulsante "OK", il cruscotto passa alla modalità "RUN".



ATTENZIONE

Nel caso in cui l'autodiagnosi evidenzi la presenza di un guasto a veicolo fermo, non avviare il motore e contattare un centro assistenza autorizzato MV Agusta.





► *Marcia del veicolo:* Quando viene rilevato un guasto sul veicolo durante la marcia, nella parte inferiore del display viene visualizzato il messaggio di errore mostrato a lato.

**ATTENZIONE**

Nel caso in cui venga segnalata la presenza di un guasto durante l'utilizzo del veicolo, non proseguire la marcia e contattare un centro assistenza autorizzato MV Agusta.

► Al momento dell'arresto del veicolo, sul display viene visualizzato il messaggio di errore che evidenzia il gruppo o il componente della motocicletta su cui è stato riscontrato il malfunzionamento.



4





► *Alta temperatura del liquido di raffreddamento:* Se il sistema rileva un valore eccessivamente elevato della temperatura del liquido di raffreddamento, sul display viene visualizzato il messaggio di errore mostrato a lato. La schermata in questione può comparire durante qualsiasi condizione di utilizzo del veicolo.



ATTENZIONE: In caso di temperatura alta, arrestare la motocicletta e controllare il livello del liquido di raffreddamento. Nel caso in cui fosse necessario rabboccarlo, rivolgersi presso un centro assistenza autorizzato MV Agusta (vedi § 3.8). Se l'indicazione compare nonostante il livello sia corretto, non proseguire la marcia e contattare un centro assistenza autorizzato MV Agusta.





4.5. Rifornimento carburante



Pericolo - Attenzione: la benzina e i suoi vapori sono estremamente infiammabili e nocivi. Evitare il contatto e l'inalazione.

Durante il rifornimento spegnere il motore, non fumare, tenere lontane fiamme, scintille e fonti di calore. Effettuate il rifornimento all'aperto o in locale ben ventilato.



Cautela - Precauzione: utilizzare esclusivamente benzina super senza piombo e senza alcool con un numero di ottano (R.O.N.) di 95 o più. Tale necessità è ricordata da un punto verde sul lato inferiore del tappo serbatoio e dalla targhetta presente sul serbatoio.

- ▶ Sollevare il coperchio parapolvere.
- ▶ Inserire la chiave, ruotarla in senso orario e sollevare il tappo.
- ▶ Dopo il rifornimento premere il tappo verso il basso ruotando contemporaneamente la chiave in senso orario per facilitare la chiusura. Quindi rilasciare la chiave ed estrarla.



**ATTENZIONE**

Un riempimento eccessivo del serbatoio può far traboccare il carburante a causa dell'espansione dovuta al calore del motore o all'esposizione della motocicletta alla luce solare. Eventuali fuoriuscite di carburante possono provocare incendi. Il livello del carburante nel serbatoio non deve mai superare la base del bocchettone di riempimento.



Cautela-Precauzione: asciugare subito con un panno pulito l'eventuale carburante versato, in quanto può deteriorare le superfici verniciate o di plastica.

**ATTENZIONE**

Verificare che il tappo del serbatoio del carburante sia chiuso correttamente prima di utilizzare il motociclo.





4.6. Accesso al vano portaoggetti

- ▶ Inserire la chiave.
- ▶ Premere la sella passeggero nella parte terminale e contemporaneamente ruotare la chiave in senso orario.
- ▶ Sollevare la sella passeggero dall'estremità posteriore, farla scorrere in avanti ed estrarla.

Per il rimontaggio del particolare osservare le seguenti indicazioni:

- Ruotare la chiave nella serratura;
- Premere la sella passeggero;
- Rilasciare la chiave;
- Premere nuovamente la sella assicurandosi di averla saldamente agganciata alla struttura.



ATTENZIONE

Dopo aver rimosso o sollevato la sella passeggero, e comunque prima di ogni utilizzo della moto, assicurarsi che il componente sia stato posizionato correttamente e che risulti ben ancorato alla struttura portante del veicolo.



4.7. Sosta della motocicletta

☐ Sosta con cavalletto laterale



CAUTELA

- Parcheggiare la motocicletta in condizioni di sicurezza e su terreno stabile.
- Per la sosta in pendenza parcheggiare con la ruota anteriore a monte e con la prima marcia inserita; ricordarsi di riportare il cambio in folle prima di riavviare la moto.
- Non lasciare il veicolo incustodito con la chiave di accensione inserita nel quadro.

► Abbassare il cavalletto col piede fino alla battuta ed inclinare lentamente la motocicletta per porre il piedino di appoggio in contatto col suolo.

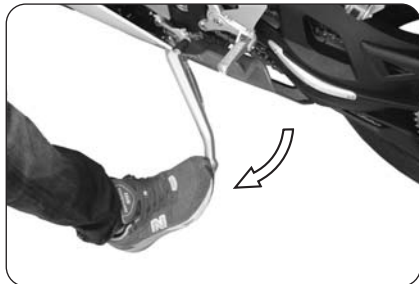

**ATTENZIONE**

Quando il veicolo è in sosta sul cavalletto laterale, è pericoloso sedere a bordo gravando perciò col proprio peso sull'unico appoggio di stazionamento.

**ATTENZIONE**

Prima di mettersi in marcia verificare il funzionamento dell'interruttore di sicurezza accertandosi che la spia di apertura cavalletto laterale sul cruscotto si spenga; in ogni caso verificare che il cavalletto sia rientrato.

Se si nota una disfunzione, fare controllare l'impianto da un concessionario MV Agusta prima di utilizzare il mezzo.

□ Sosta con cavalletto posteriore

Inserire il perno del cavalletto nel foro dell'asse ruota posteriore dal lato sinistro della motocicletta; appoggiare il cavalletto al suolo e facendo forza su di esso sollevare il veicolo fino al raggiungimento della condizione di stabilità.

**CAUTELA**

Questa operazione deve essere eseguita da due persone.





5.1. Elenco regolazioni

La motocicletta possiede un'ampia possibilità di regolazioni che possono migliorare l'ergonomia, l'assetto e la sicurezza.

Tuttavia, poiché una errata regolazione di componenti particolarmente importanti può creare una situazione di pericolo, alcune di queste regolazioni sono riservate soltanto ai Centri Assistenza MV Agusta.



ATTENZIONE

Tutte le regolazioni devono essere effettuate a veicolo fermo.

5





(F) Regolazione specchietto retrovisore (§5.5.)

(A) Regolazione leva frizione (§5.4.)

(F) Regolazione specchietto retrovisore (§5.5.)

(G) Regolazione ammortizzatore di sterzo (§4.4.6)

(D) Regolazione leva cambio (§5.2.)

(L) Regolazione sospensione
posteriore (§4.4.6.)

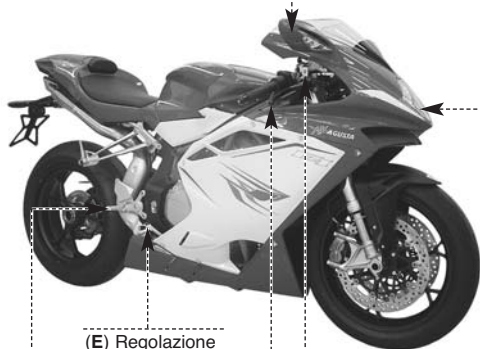

(E) Regolazione
leva freno
posteriore (§5.2.)

(C) Regolazione
pedana destra (§5.2.)

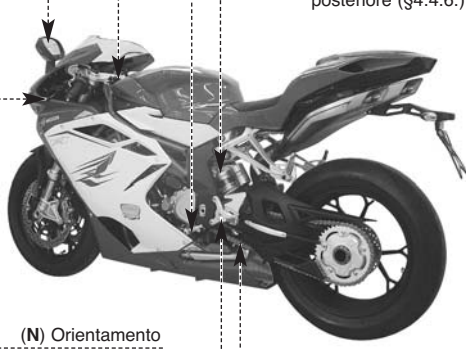

(N) Orientamento
faro (§5.7.)

(H) Regolazione sospensione
anteriore (§5.6. e §4.4.6.)

(B) Regolazione leva freno anteriore (§5.3.)

(M) Regolazione
catena (§5.2.)

(C) Regolazione
pedana sinistra (§5.2.)





5.2. Tabella delle regolazioni



A - Regolazione leva frizione: per ottimizzare la presa in funzione delle esigenze del motociclista (§5.4).



B - Regolazione leva freno anteriore: per ottimizzare la presa in funzione delle esigenze del motociclista (§5.3).



C - Regolazione pedane poggipiedi (destra e sinistra): per ottimizzare la posizione dei piedi in funzione delle esigenze del motociclista.



D - Regolazione leva cambio: per ottimizzare il movimento del comando in funzione delle esigenze del motociclista.



E - Regolazione leva freno posteriore: per ottimizzare il movimento del comando in funzione delle esigenze del motociclista.



F - Regolazione specchietti retrovisori: per ottimizzare l'orientamento (§5.5).



G - Regolazione ammortizzatore di sterzo: per adattare la durezza dello sterzo alle preferenze di guida del motociclista (§4.4.6.).



H - Regolazione sospensione anteriore: per adattare la risposta alle preferenze del motociclista si possono regolare:

- precarico molla (§5.6.1.)
- dispositivo idraulico di frenatura in estensione (§4.4.6.)
- dispositivo idraulico di frenatura in compressione (§4.4.6.)



L - Regolazione sospensione posteriore: per adattare la risposta alle preferenze del motociclista si possono regolare:

- altezza assetto
- precarico molla
- dispositivo idraulico di frenatura in estensione (§4.4.6.)
- dispositivo idraulico di frenatura in compressione (§4.4.6.)



M - Regolazione catena: per l'efficienza e la sicurezza della trasmissione.



N - Orientamento faro: per regolare la profondità del fascio luminoso in funzione dell'assetto (§5.7.).





5.3. Regolazione leva freno anteriore

Ruotare il pomello in senso orario o antiorario per regolare la posizione della leva. In senso orario: la leva si allontana dalla manopola. In senso antiorario: la leva si avvicina alla manopola.

5.4. Regolazione leva frizione

Ruotare il pomello in senso orario o antiorario per regolare la posizione della leva. In senso orario: la leva si allontana dalla manopola. In senso antiorario: la leva si avvicina alla manopola.

5.5. Regolazione specchietti retrovisori

Premere delicatamente nei punti evidenziati per regolare la posizione nelle quattro direzioni.

Eseguire la regolazione su entrambi gli specchietti retrovisori. Per rendere ottimale la messa a punto si consiglia di eseguire la regolazione salendo sul veicolo.

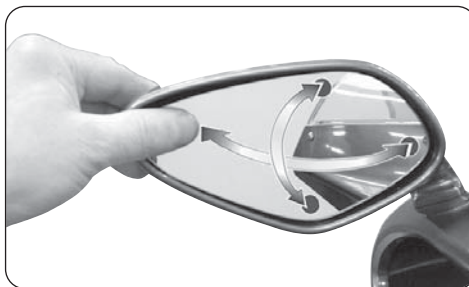
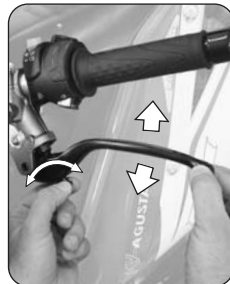



5.6. Regolazione sospensione anteriore

NOTA

La regolazione delle sospensioni deve essere preferibilmente effettuata con il serbatoio carburante pieno.

NOTA

Per la regolazione della frenatura in compressione ed estensione, riferirsi alle procedure descritte nel §4.4.6.

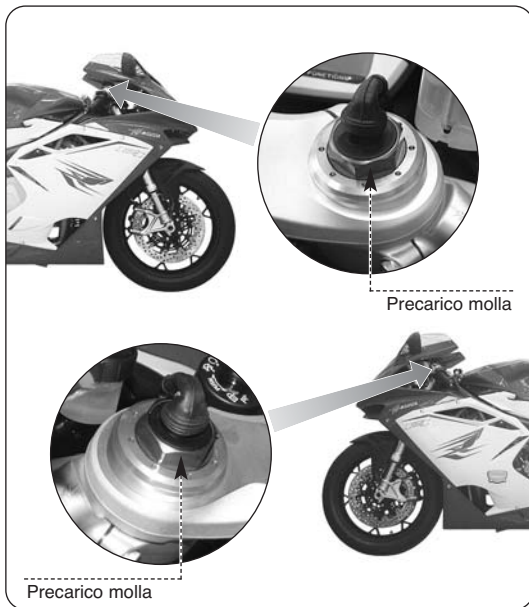



5.6.1. Precarico molla (sospensione anteriore)

► Per accedere al registro del precarico molla, sollevare la guaina di protezione e disimpegnare il connettore aiutandosi con un cacciavite.



► La regolazione deve essere effettuata partendo dalla posizione standard. Per trovare tale posizione, occorre ruotare in senso antiorario fino a fondo corsa, quindi in senso orario fino alla posizione standard (vedi tabella allegata). Ruotare in senso orario per aumentare il precarico molla, oppure ruotare in senso antiorario per diminuirlo.

► Al termine delle operazioni di regolazione, rimontare il connettore e riposizionare la guaina di protezione.



5





5.7. Regolazione proiettore anteriore

Porre il veicolo a 10 metri di distanza da una parete verticale.

Assicurarsi che il terreno sia piano e che l'asse ottico del proiettore sia perpendicolare alla parete.

Il veicolo deve trovarsi in posizione verticale. Misurare l'altezza del centro del proiettore da terra e riportare sulla parete una crocetta alla medesima altezza.

Accendendo la luce anabbagliante, il limite superiore di demarcazione tra la zona oscura e la zona illuminata deve risultare ad un'altezza non superiore a $9/10$ dell'altezza da terra del centro del proiettore.

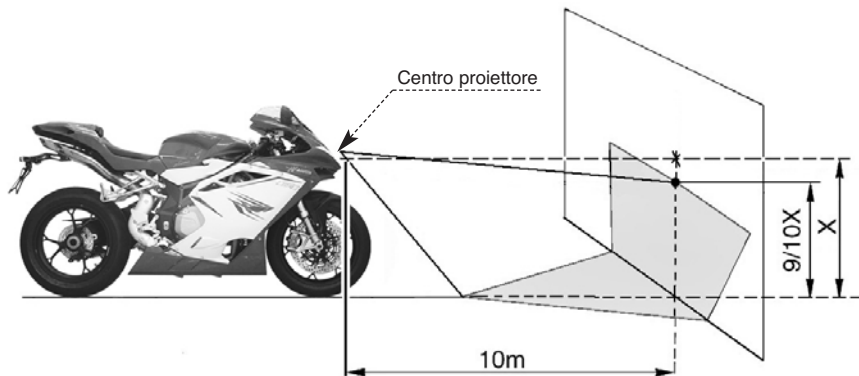



La regolazione verticale del fascio luminoso può essere effettuata agendo sulla vite raffigurata a lato. In senso orario: il gruppo ottico si inclina verso l'alto. In senso antiorario: il gruppo ottico si inclina verso il basso. L'inclinazione può essere variata di $\pm 4^\circ$ rispetto alla posizione standard.

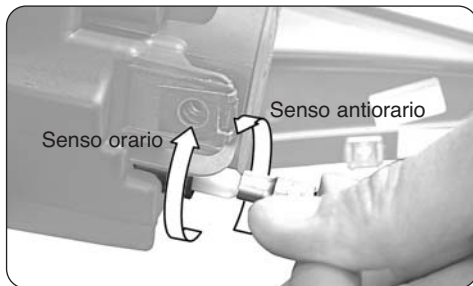



Nota informativa

MV Agusta S.p.A. è impegnata in una politica di continuo miglioramento dei propri prodotti; per questa ragione potrebbe essere possibile riscontrare leggere differenze tra quanto riportato nel presente documento ed il veicolo da Voi acquistato. I modelli MV Agusta vengono esportati in numerosi Paesi, nei quali valgono norme differenti in relazione al Codice della Strada ed alle procedure di omologazione. Contando sulla Vostra comprensione, MV Agusta S.p.A. ritiene quindi necessario riservarsi il diritto di apportare modifiche ai propri prodotti ed alla propria documentazione tecnica in qualsiasi momento e senza fornirne preavviso.

Vi consigliamo di visitare periodicamente il sito Internet **www.mvagusta.it** per ottenere informazioni ed aggiornamenti sui prodotti MV Agusta e sulla relativa documentazione.



Rispettiamo e difendiamo l'ambiente

Tutto ciò che facciamo ha ripercussioni sull'intero pianeta e sulle sue risorse. MV Agusta, a tutela degli interessi della comunità, sensibilizza i Clienti e gli operatori dell'assistenza tecnica ad adottare modalità d'uso del mezzo e di smaltimento di sue parti, nel pieno rispetto delle normative vigenti in termini di inquinamento ambientale, smaltimento e riciclaggio dei rifiuti.

© 2012

È vietata la riproduzione anche parziale di questo documento senza il consenso scritto della MV Agusta S.p.A.

Part. n° 8000B7637

Edizione n° 1 - Novembre 2012



MV AGUSTA



User's manual
English Version



Dear Customer,

We wish to thank you for your preference and congratulate you on purchasing your new F4 RR. Your choice is a reward for the passionate effort our technicians have put into giving the F4 RR functional and aesthetic characteristics that place it above the finest motorcycles currently available on the market, making it an exclusive and sought-after item.

If, from a purely technical standpoint, the F4 RR represents an internationally recognized point of reference on account of the innumerable innovations it introduces, its sleek, timeless design wonderfully combines a glorious past with the new millennium.

The combination of these elements, which was made possible by love of detail, passion, and the desire to realize a technically and aesthetically superior motorcycle, allows the F4 RR to soar above passing fashions, giving it the privilege of being considered a unique item.

For further information, please feel free to contact the MV Agusta Customer Care Service.

Have a good time!

*MV Agusta
Giovanni Castiglioni
Chairman*



CONTENTS

<i>chap.</i>	<i>Subjects covered</i>	<i>page</i>
1	GENERAL INFORMATION	5
1.1.	Purpose of the manual	5
1.2.	Symbols	6
1.3.	Contents of the digital support	7
1.4.	Identification data	8
2	SAFETY INFORMATION	11
2.1.	Allowed use of the vehicle	11
2.2.	Maintenance	11
2.3.	Accessories and modifications	12
2.4.	Vehicle load	12
3	CONTROLS AND INSTRUMENTS	14
3.1.	Location of controls and instruments	14
3.2.	Sidestand	15
3.3.	Handlebar controls, left side	16
3.4.	Handlebar controls, right side	18
3.5.	Ignition switch and steering lock	21
3.6.	Gear lever	24
3.7.	Instruments and warning lights	25
3.7.1.	Warning lights	26
3.7.2.	Multifunction display	27
3.8.	Table of lubricants and fluids	28

<i>chap.</i>	<i>Subjects covered</i>	<i>page</i>
4	OPERATION	29
4.1.	Using the motorcycle	29
4.2.	Running-in	30
4.3.	Starting the engine	32
4.4.	Selecting and setting the display functions	35
4.4.1.	Selecting the display functions	36
4.4.2.	Trip reset	41
4.4.3.	TC Mode	43
4.4.4.	Chronometer	44
4.4.5.	NIGHT/DAY Mode	53
4.4.6.	Electronic suspension adjustment	54
4.4.7.	Selecting the ABS function	58
4.4.8.	QUICK SHIFT Mode	60
4.4.9.	IMMOBILIZER Mode	61
4.4.10.	How to select the mapping of the control unit	64
4.4.11.	Warning/malfunction alerts	76
4.5.	Refuelling	79
4.6.	Glove compartment	81
4.7.	Parking the motorcycle	82



CONTENTS

<i>chap.</i>	<i>Subjects covered</i>	<i>page</i>
5	ADJUSTMENTS	84
5.1.	List of adjustments	84
5.2.	Table of adjustments	86
5.3.	Adjusting the front brake lever	87
5.4.	Adjusting the clutch lever	87
5.5.	Adjusting the rearview mirrors	87
5.6.	Adjusting the front suspension	88
5.6.1.	Spring preload (front suspension)	89
5.7.	Headlight adjustment	90



1.1. Purpose of the manual

This User's Manual contains the necessary information for a correct and safe use of the motorcycle.

Together with this manual, a pocket Quick Manual is also supplied, in which the minimum essential informations for the use of the vehicle are reported.

The User's Manual is also supplied in electronic format (.pdf) on the digital support supplied and it can be printed or viewed on any PC, equipped either with Windows or Mac operative system.

We recommend to carefully read the User's Manual before using your motorcycle, and to make sure that anyone who uses the motorcycle had previously made the same.

Finally, we recommend to always take with you the Quick Manual, after having filled it in with your personal ID data and the specifications of your motorcycle.



Copyright
MV AGUSTA Motor Spa
All rights reserved





1.2. Symbols

Sections of text that are particularly important in terms of personal safety or possible damage to the motorcycle are marked with the following symbols:



Danger - Failure to observe these prescriptions, even in part, may pose a serious hazard to the driver's and other people's safety.



Caution - Failure to observe these prescriptions, even in part, may result in damage to the motorcycle.

The following symbols give an indication of who is supposed to perform the different adjustments and/or maintenance operations:



Information on operations that can be carried out by the user.



Information on operations that must be carried out only by authorized personnel.

The following symbols are used to provide further information:



The “” symbol points out the requirement to use a tool or a special equipment in order to correctly perform the described operation.



The “§” symbol refers the reader to the chapter identified by the number that follows.





1.3. Contents of the digital support

Inside the digital support supplied you will find, besides the User's Manual, the Maintenance Manual, the Quick Manual (which is also supplied in a paper copy), the World Dealer Guide and the Warranty Booklet.

When delivering the bike, your Dealer has also supplied the Warranty and Pre-Delivery Certificate.

We recommend to keep it together with the motorcycle documents and with the service coupons that are given at the moment of servicing the bike.

IMPORTANT

The copies of the Warranty and Pre-Delivery Certificate must be filled in by the Dealer. A copy of the certificate must be given to the Customer, a second copy must be kept by the Dealer and the third one must be sent to the importer.

The dealer must always fill in the recommended maintenance service coupons. They must be kept by both, the Customer and the Dealer.



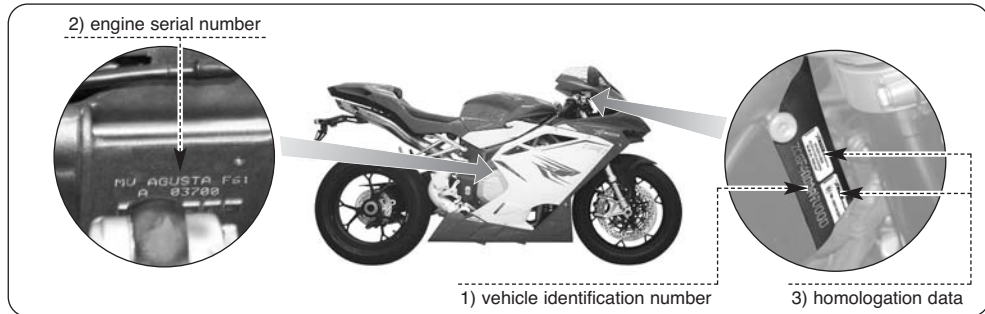

1.4. Identification data

- 1) vehicle identification number
- 2) engine serial number
- 3) homologation data

► Motorcycle identification

The motorcycle is identified by the vehicle identification number. When placing orders for spare parts, in addition to this number, you may be required to provide the engine serial number, the color code and the key identification.

We recommend writing down the main numbers in the spaces provided below.

FRAME No.: _____

ENGINE No.: _____





► **Motorcycle key identification**

A key is supplied in duplicate for both the ignition and all the locks. Keep the duplicate in a safe place.

When placing orders for spare keys, you may be required to provide the key identification number. The key identification number is located on the MV Code Card equipped with the ignition keys.

**1** CB

► **Identification of motorcycle colour combination**

The colour code must be mentioned when ordering body spares. It can be read on the lower right side of the fuel tank.

In order to get to the colour code label, it is necessary to remove the fuel tank right-hand side fairing. Pull out the rear part of the fuel tank right-hand side fairing as shown in the figure.



**GB 1**

Remove the fuel tank right-hand side fairing by pulling it towards the rear part of the motorcycle.



After removing the fuel tank left-hand side fairing, it is possible to get to the colour code label. On this label you can read the motorcycle colour combination, which determines the painting of the bodywork parts.

We recommend writing down the colour code in the space provided below:

COLOUR CODE:

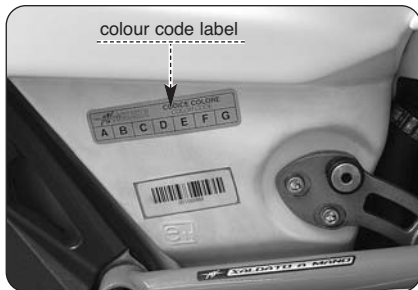



2.1. ALLOWED USE OF THE VEHICLE

Your motorcycle has been strictly designed for use on road or highway route.



WARNING

Occasionally, it is possible to use your motorcycle on race track during non-competitive events.

In this case, however, in consequence of the higher stresses affecting the bike during this specific use, we recommend to have its conditions checked by an authorized MV Agusta Service Center before and after using it.

Any other use of the vehicle is prohibited and explicitly excluded.

You can find further information about the use of the vehicle in the section no. 4 of this Manual.

2.2. MAINTENANCE

In order to guarantee the maximum efficiency and reliability of the vehicle, it is necessary to perform the programmed maintenance operations reported in the Maintenance Manual.

MV Agusta recommends that all maintenance operations are performed only by skilled personnel from an authorized MV Agusta Service Center. Anyway, if you decide to have the maintenance operations performed by non-authorized workshops, you must ensure that they have the skills and the specific tools necessary to perform the above operations.



WARNING

The MV Agusta Warranty could not be valid if non-authorized workshops had performed operations on the bike in a different way from what is described on the Technical Circular Letters and on the related MV Agusta Workshop Manuals.





2.3. ACCESSORIES AND MODIFICATIONS



WARNING

MV Agusta prohibits to make any modification to its motorcycles.

This is necessary to preserve the safety of its Customers.

Anyway, it is possible to customize your motorcycle by consulting the extensive MV Agusta Accessory Catalogue.



WARNING

The installation of some of the above accessories could invalidate the bike homologation, and consequently make the bike not furtherly usable on public roads.

If you have doubts, we suggest to refer to your MV Agusta Dealer in order to choose the accessories which can better suit your needs.

2.4. VEHICLE LOAD

Your motorcycle is designed for use by the rider and it can also seat a passenger. To use the vehicle in complete safety and in accordance with the Highway Code provisions, it is compulsory that the following technically allowed maximum mass conditions are never exceeded:

F4 RR:

Technically allowed maximum mass:

378 kg

Maximum load mass:

165 kg

The technically allowed maximum mass comes out from the sum of the following masses:

- mass of the motorcycle in running order;
- mass of the driver;
- mass of the passenger;
- mass of the luggage and all the accessories.



**WARNING**

Since the load can strongly affect handling, braking, performance and safety characteristics of your motorcycle, you should always keep in mind the following warnings.

- **NEVER OVERLOAD YOUR MOTORCYCLE!** Driving an overloaded motorcycle can cause damage to the tyres, loss of control of the vehicle and serious injury. Verify that the total weight (including the weight of the motorcycle, the driver, the passenger, the load and all the accessories) does not exceed the maximum load value specified for your vehicle.





3.1. Location of controls and instruments

GB 3

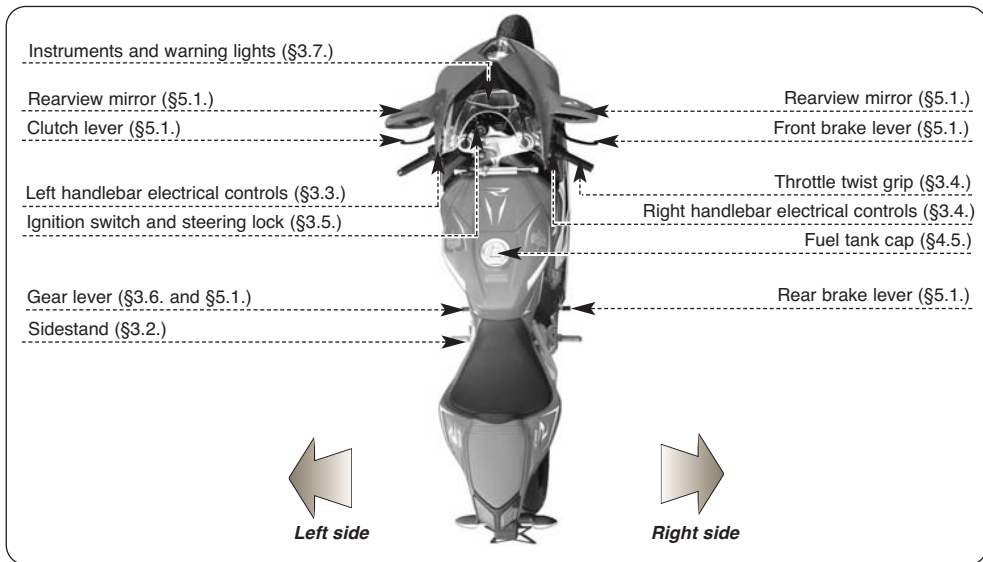



3.2. Sidestand

The sidestand is equipped with a safety switch that prevents the motorcycle from moving off while the stand is down.

If the rider attempts to engage the gears while the engine is running and the stand is down, the switch automatically turns off the engine by cutting the current supply.

If the motorcycle is parked (sidestand down) and the gears are engaged, the switch prevents the engine from being started, thereby avoiding the risk of accidentally toppling the vehicle.

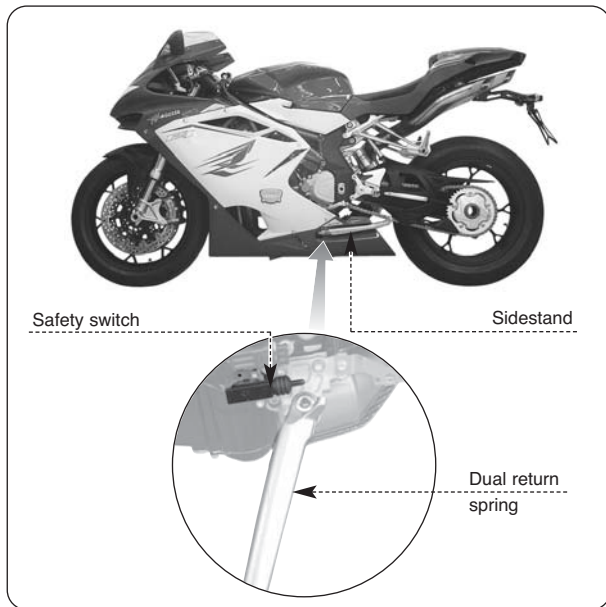



3.3. Handlebar controls, left side

GB 3

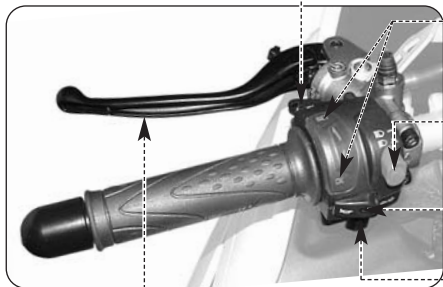

High beam flasher button

Press the button repeatedly.

SET/OK button

Press to select the display functions (§ 4.4.).

Low/high beam button

Button not pressed in  : low beam 

Button pressed in  : high beam 

Horn button

Press to operate the warning horn.

Turn indicator switch

Shifting the lever to the left or right switches on the left or right turn indicators. The switch then returns to the central position. Press to turn off the indicators.

Clutch lever

Move towards/away from the handgrip to release/engage the clutch.





High beam flasher button

It is used to attract the attention of other road users in case of danger. When the high beam is on, the function is inactive.

Low/high beam button

Under normal conditions, the low beam is on. The high beam can be switched on by pressing the button when allowed by the traffic and road conditions.

Horn button

It is used to attract the attention of other road users in case of danger.

Turn indicator switch

It is used to show the rider's intention to change direction or lane.



WARNING

Failure to switch the turn indicators on or off at the right time may cause an accident in that the other road users may draw incorrect conclusions about the direction of motion of the vehicle. Always switch on the indicators before turning or changing lanes. Then be sure to switch off the indicators after completing the operation.

Clutch lever

It engages/disengages the clutch through a hydraulically controlled device.





3.4. Handlebar controls, right side

GB
3

Engine stop switch

Stops the engine and prevents it from being restarted.

Engine start button

Starts the engine. To be released as soon as the engine starts.
When the engine is running, pressing the button selects the mapping of the control unit (§.4.4.10.).

Throttle twist grip

Rotate counterclockwise to increase engine speed.

Front brake lever

Pull to the lever to apply the front brake.

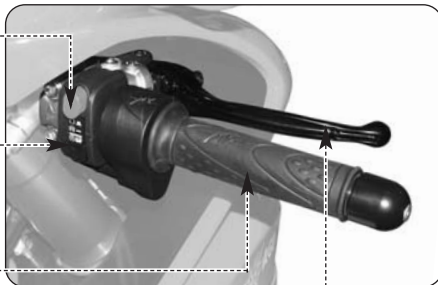

**Engine stop switch**

It is used to switch off the engine in an emergency. The ignition circuit is disabled, preventing the engine from being restarted. To be able to restart the engine, return the switch to its original position.

NOTE

Under normal conditions, do not use this switch to shut off the engine.

Engine start button

It is used to start the engine and, when the engine is running, to select the mapping of the control unit through the related function of the display installed on the instrument panel (see § 4.4.10.).

**CAUTION**

To avoid damaging the electrical equipment, be sure not to hold down the button for longer than 5 consecutive seconds. If, after some attempts, the engine does not start, refer to the chapter “TROUBLESHOOTING” later in this manual.

Throttle twist grip

It controls the fuel-air mixture supplied to the engine, which regulates engine speed. To increase engine speed, rotate the hand grip from its idle position counterclockwise.

**WARNING**

If your motorcycle has toppled over or has been involved in an accident, have the working of the throttle control checked by a MV Agusta authorized center before restarting.





Front brake lever

It controls a hydraulic circuit that operates the front wheel braking system.

□ Antilock Braking System (ABS) *

Some F4 models are equipped with a power-assisted braking system (ABS - Antilock Braking System), which prevents the wheels from locking up during emergency brakings, thus guaranteeing the stability of the vehicle and shortening braking distances.



WARNING

When the ABS system is activated, vibrations could be perceptible through the brake lever or brake pedal. When this event occurs, it is recommended to keep pressed the braking control devices in order to allow the vehicle to complete the braking.



WARNING

If the ABS system has a fault or is deactivated, the related warning light on the dashboard turns on (see § 3.7.1.). From this moment on, the antilock braking system could not be available when braking. If there is a fault in the ABS system, it is recommended to resume riding at reduced speed and contact a MV Agusta authorized service centre. If the ABS system is turned off, follow the activation procedure described at § 4.4.7.

(*): *This function is present only on certain models*





3.5. Ignition switch and steering lock



WARNING

Do not attach a ring or any other object to the ignition key as they may hinder the steering action.



WARNING

Never attempt to change the switch functions while riding, as you may lose control of the vehicle.

The ignition switch enables and disables the electrical circuit and the steering lock. The four positions of the switch are described below.

OFF position

All electrical circuits are deactivated. The key can be removed.

ON position

All electrical circuits are activated. The instruments and warning lights perform the self-diagnostic cycle. The engine can be started. The key cannot be removed.



CAUTION

Do not leave the key on the ON position for a long time when the engine is not running, in order to avoid damage to the electrical parts of the motorcycle.





LOCK position

Turn the handlebar to the left or right. Press the key in gently while rotating it to the LOCK position.

All electrical circuits are deactivated and the steering is locked. The key can be removed.

GB
3

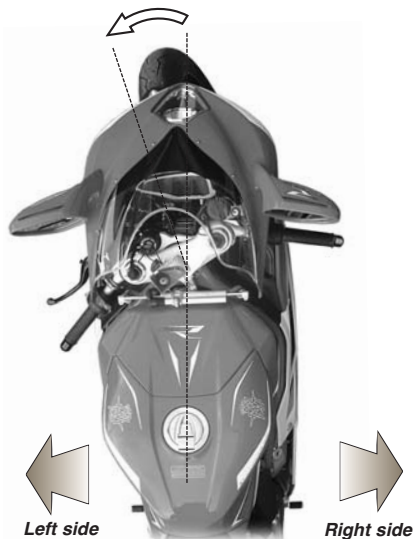



P (PARKING) position

Turn the key from the LOCK position to the P position. All electrical circuits are deactivated except the parking lights. The steering is locked. The key can be removed.



CAUTION

Do not leave the key on the P position for a long time, in order to avoid discharging the battery of your motorcycle.





3.6. Gear lever

The **N** (neutral) position is indicated by the warning light on the instrument panel.

To change into first gear, push the lever down.

To change into second gear, lift the lever up. Lifting the lever up repeatedly engages all the other gears in succession up to the sixth speed.

□ “Quick Shift” function

The F4 RR model is equipped with a “Quick Shift” gear change system; this device enables you to upshift without pulling the clutch or changing the throttle control angle. This way, it is possible to change into upper gears by keeping a constant acceleration and reducing shifting time to a minimum. The “Quick Shift” system is not available when you change gear with the clutch lever pressed or at a speed lower than 30 km/h, nor when shifting into lower gears.

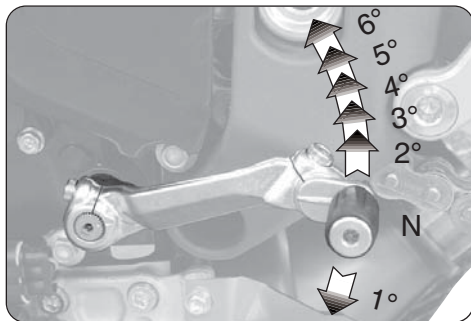

WARNING: When you are riding the vehicle with the engine revving high in a low gear, changing gear without operating the clutch lever can cause abrupt reactions which can compromise the stability of the vehicle. MV Agusta recommends to operate the clutch lever in these circumstances, especially when the engine rpm is close to the rpm-limiter intervention speed.





3.7. Instruments and warning lights

The instruments and warning lights are activated by turning the ignition switch to the ON position. After a preliminary check (approx. 7 seconds) the displayed information reflects the current general condition of the motorcycle.

Warning lights
(§3.7.1.)

Tachometer display



SET button
(§3.7.2.)

OK button
(§3.7.2.)

HAZARD button (§3.7.2.)

Multifunction display (§3.7.2.)





3.7.1. Warning lights

Headlights (blue)

It turns on when the headlights are on.

Turn indicator light / "Hazard" light (green)

Lights up when the turn indicators or the emergency lights (see §3.7.2.) are activated.

Neutral warning light (green)

It turns on when the gear is in "Neutral".

ABS warning light (orange) *

Lights up when the ABS system has a fault or is deactivated, or if the speed is lower than 5 km/h.



WARNING: If the warning light comes on while riding, stop the motorcycle immediately and check that the ABS system is activated (see §4.4.7.). In this case, resume riding at reduced speed and contact a MV Agusta authorized service centre.

(*): This function is present only on certain models

Engine oil pressure warning lights (red)

Lights up when the oil pressure is insufficient.



WARNING: If the warning light comes on while riding, stop the motorcycle immediately. Check the oil level and if necessary have it restored by a MV Agusta authorized service centre (see §3.8.). If the warning light comes on even if the oil level is correct, do not resume riding and contact a MV Agusta authorized service centre.

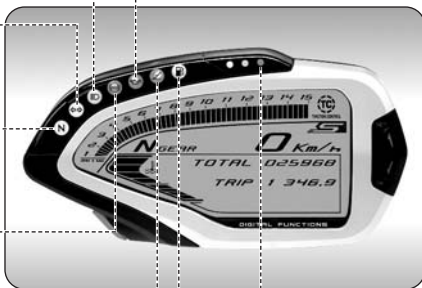

Rev limiter warning light (red)

It turns on when the engine exceeds 10800 rpm; the rev limiter limits the rpm to 13500.

Reserve fuel indicator (orange)

Comes on when approximately 4 litres of fuel are left.

Sidestand down warning light (red)

Lights up when the sidestand is down.





3.7.2. General display

Gear display

It displays the currently engaged gear. "N" stands for "neutral".

Thermometer

It displays the temperature of the coolant by turning on a variable number of segments on a graduated scale. When the temperature falls outside the normal operating range, it may display one of the following information:

- the display shows just one blinking segment; it means that the temperature is low;
- all segments are on, while the upper segment is blinking; it means that the temperature is high.



Danger - Notice: if the temperature is high, stop the motorbike and check the coolant level. If it needs to be filled up, contact a MV Agusta licensed service centre (see § 3.8). If the warning light turns on even if the level is adequate, stop driving and contact a MV Agusta licensed service centre.

Speedometer

It displays the speed of the motorbike. It can be given in kilometres per hour (Km/h) or in miles per hour (Mph). The full scale measures 350 Km/h (217 Mph).

Control unit mapping

It shows the selected mapping of the engine control unit.

"SET" button

Press it to select and set the figures on the display.

"OK" button

Press it to confirm the new settings.

"HAZARD" button

Press it to turn on the emergency lights.

"TOTAL" odometer:

It displays the total distance covered; from 0 to 999999 (Km or miles)

Trip counter 1, "TRIP 1"

It displays the length of a trip; from 0 to 999.9 (Km or miles)

Trip counter 2, "TRIP 2"

It displays the length of a trip; from 0 to 999.9 (Km or miles)

Chronometer

It displays the time measured by the chronometer

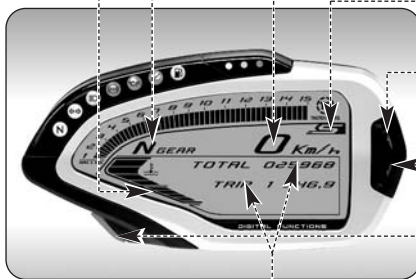



3.8. Table of lubricants and fluids

<i>Description</i>	<i>Recommended product</i>	<i>Specifications</i>
Engine lubrication oil	eni i-Ride motoGP 10W-60 (*)	SAE 10W/60 - API SG
Coolant	Agip Eco - Permanent	Ethylene glycol diluted with 50 percent distilled water
Brake and clutch fluid	Agip Brake 4	DOT4
Drive chain lubrication oil	D.I.D. CHAIN LUBE	–

* : MV Agusta suggests to refer directly to its authorized dealers in order to purchase the recommended product. The eni i-Ride motoGP 10W-60 engine oil has been expressly produced for the F4 motorcycle engine. If the above described lubricant is not available, MV Agusta suggests to use a fully synthetic engine oil having characteristics equal or better than the ones prescribed in the following standards:

- Consistent with: API SG
- Consistent with: ACEA A3
- Consistent with: JASO MA
- SAE Rating: SAE 10 W-60

NOTE

The above standard denominations must be written, alone or together, on the engine oil container label.





4.1. Using the motorcycle

This section provides the basic information needed to correctly operate the motorcycle.



WARNING

Your motorcycle shows high power and performance characteristics; therefore, its use requires an adequate level of knowledge of the vehicle. When you use this motorcycle for the first time, it is essential to adopt a cautious attitude. An aggressive or reckless riding attitude can lead to accidents, compromising the driver's and other people's safety.



WARNING

THE RESTRICTIONS RELATED TO THE ALLOWED USE OF THE VEHICLE ARE DESCRIBED IN THE SECTION "SAFETY INFORMATIONS".



CAUTION

The high temperatures caused by the use of the vehicle on race circuits could compromise the efficiency of the catalytic converter and of the exhaust system; therefore, we suggest assembling a special exhaust system when using the vehicle on race circuits.





4.2. Running-in



CAUTION

Failure to observe the indications provided below can reduce performance and shorten the life of the motorcycle.

Running-in is generally considered to apply only to the engine. In fact, it should be regarded as an essential phase for other important parts such as the tyres, the brakes and the drive chain. During the very first miles, adopt a relaxed riding style.

□ 0 to 500 km (0 to 300 mi) (A)

Frequently change the engine speed. If possible, prefer hilly routes with gentle slopes and many bends. Avoid long straight stretches.



WARNING

New tyres must undergo a proper running-in period to reach their complete efficiency. Avoid abrupt acceleration, turning and braking during the first 100 km. Failure to observe these prescriptions can lead to the sliding of the wheels and the loss of control of the vehicle with subsequent risk of accidents.





❑ **500 to 1000 km (300 to 600 mi)**

Avoid lugging or overspeeding the engine, and vary your speed frequently.



❑ **1000 to 2500 km (600 to 1600 mi)**

Higher engine performance can be demanded, but it is advisable not to exceed the engine speed shown in the figure.

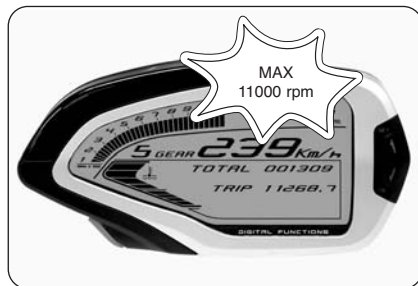



4.3. Starting the engine



WARNING

Starting the engine in a closed place can be dangerous. Exhaust emissions contain carbon monoxide, a colourless and odourless gas that can lead to serious harm or even death when inhaled.

Only start the engine outdoor, in the open air.



► As you turn the ignition switch to the ON position, the instruments and the warning lights will go through the self-diagnostic cycle; during this phase, make sure that all the warning lights on the dashboard come on.

► The start/stop system will let the motorbike turn on if one of the following conditions is met:

- The gear is in neutral.
- The gear is engaged with the clutch lever up and the side stand up.





► If the self-diagnostic cycle detects a fault in the vehicle, the display shows the warning alert shown in the picture. In particular, this message highlights the vehicle part or device on which the fault has been detected.

► Press “OK” button to access to “RUN” mode.

**WARNING**

If a fault is detected on the vehicle, do not start engine and contact an authorized MV Agusta centre.





□ Engine start procedure

- ▶ Press the start button without turning the throttle twist grip.
- ▶ As soon as the engine starts, release the button.



CAUTION

- Do not press the start button for longer than 5 consecutive seconds, in order to avoid damage to the electrical equipment.
- Avoid warming up the engine while the vehicle is stationary. The subsequent engine overheating can cause damage to the internal parts of the engine. It is advisable to bring the engine to the working temperature by riding at reduced speed.
- To ensure the maximum life of the engine, never speed up at full throttle when the engine is cold.

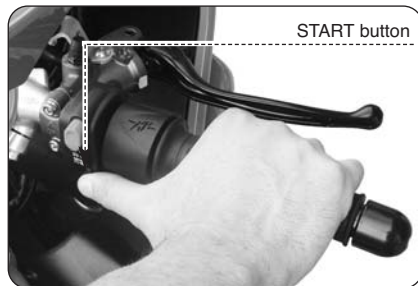



4.4. Selecting and setting the display functions

Some of the main measurements of the instruments may be changed.

The available options include:

- Select an operating mode:
 - “RUN” (Odometer)
 - “TC” (Traction control)
 - “CHRONO” (Chronometer)
 - “NIGHT/DAY” (Night/Day Mode)
 - “SETTING ÖHLINS” (Electronic suspension adjustment)
 - “ABS” (Antilock braking system)*
 - “QUICK SHIFT”
- Reset the trip counter:
 - Trip counter 1 “TRIP 1”
 - Trip counter 2 “TRIP 2”
- “IMMOBILIZER” mode (Antitheft device)
- Control unit mapping selection

(*): This function is present only on certain models





4.4.1. Selecting the display functions

The following settings may be changed on the display:

- “RUN” (Odometer)
- “TC” (Traction control)
- “CHRONO” (Chronometer)
- “NIGHT/DAY” (Night/Day Mode)
- “SETTING ÖHLINS” (Electronic suspension adjustment)
- “ABS” (Antilock braking system)*
- “QUICK SHIFT”

To display the operating modes, press “SET” for less than three seconds. When pressed, the display shows all modes in a sequence. Select the desired mode.

(*): *This function is present only on certain models*



WARNING

The operation must be performed while the engine is not running, the gears are in neutral, the motorcycle is stationary, and with the feet on the ground. Do not set the display functions while riding.





❑ “RUN” mode

In addition to the speedometer, the display shows the following functions (see §4.4.2.):

- Total odometer “TOTAL”
- Trip counter 1 “TRIP 1”

As an alternative:

- Total odometer “TOTAL”
- Trip counter 2 “TRIP 2”

❑ “TC” Mode

This Mode adjusts the engine traction control level to your driving requirements (see §4.4.3.).





❑ “CHRONO” Mode

This mode turns on the Chronometer and saves the recorded information (see §4.4.4.).

The following is displayed:

- Chronometer Current lap “CURRENT LAP”
- Chronometer Fastest lap “BEST LAP”
- Chronometer Last lap “LAST LAP”
- Rev counter Total laps covered “N° LAP”



❑ “NIGHT/DAY” Mode

This function enables the background colour of the display to be reversed in order to adapt its visibility depending on the time of day or night the vehicle is used (see §4.4.5.).





□ “SETTING ÖHLINS” Mode

This mode allows to perform the adjustment of the following elements (see §4.4.6.):

- Front suspension
- Rear suspension
- Steering damper



□ “ABS” Mode *

This mode allows to activate or deactivate the antilock braking system (ABS) (see §4.4.7.).



(*): This function is present only on certain models





□ “QUICK SHIFT” Mode

This mode allows to turn off or on the “quick shift” function of the gear change (see §4.4.8.).





4.4.2. Trip reset

To reset “TRIP 1” and “TRIP 2”, proceed as follows.



WARNING

The display modes may be changed or set when the engine is off, the gear in neutral, the motorbike stationary with your feet on the ground. The display may not be changed while driving.

- ▶ Access the “RUN” mode; the total speedometer (“TOTAL”) and partial speedometer 1 (“TRIP 1”) will appear on the display.
- ▶ By pressing the “OK” key for more than three seconds, the “TRIP 1” value will be reset to zero.





► Press the “OK” key for less than three seconds until the partial speedometer 2 function (“TRIP 2”) appears on the display.



► By pressing the “OK” key for more than three seconds, the “TRIP 2” value will be reset to zero.





4.4.3. "TC" Mode

► Press "SET" in order to access to "TC" mode, then press "OK" for less than three seconds until "TC LEVEL" appears. The current traction control level is the same as the one shown on the display.



WARNING

The display modes may be changed or set when the engine is off, the gear in neutral, the motorbike stationary with your feet on the ground. Do not change the display while driving.

► Press "OK" for less than three seconds: the traction control level rises up to the next value. On the other hand, if you press "SET" for less than three seconds, the traction control level decreases to the previous value. Such value may range between 0 and 8.

► Press "OK" for over three seconds to confirm the selected traction control level.

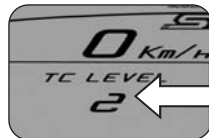
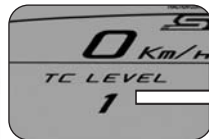
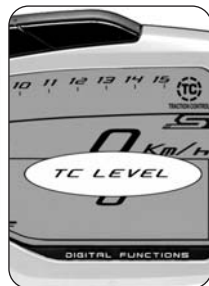



4.4.4. Chronometer

□ Lap time recording

► Turn on the chronometer (“CHRONO” mode) to record the time taken to cover a lap.



► Press the headlight button to start recording the time. The colon that separates the minutes from the seconds and from the tenths of a second will start blinking. Now, the instrument is recording the time.

NOTE: When the “CHRONO” mode is activated, the first pressing of the headlight button automatically enables the “TC” function. From this moment on, it is possible to immediately change the traction control level by properly operate the “SET” and “OK” buttons (see §4.4.3.).





► Press the headlight button again to record the time taken to cover the 1st lap. At the same time, the instrument starts recording the time taken to cover the second lap.

The time measurement for the first lap is stored in the memory and is visualised on the display for ten seconds, after which the time measurement for the following lap appears.

► If using the chronometer again, every time you press the headlight button, it records a time. The instrument can record up to 100 consecutive times.

When the time for the lap which has just concluded is displayed, the symbol “+” or “-” appears if the time recorded is respectively higher or lower than the time measured during the previous lap.

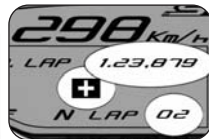
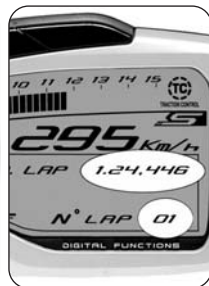



❑ Data display

Once all times have been recorded, they may be displayed.

- ▶ Access the “CHRONO” mode; the time of the fastest lap (“BEST LAP”) and the time of the last lap (“LAST LAP”) appears on the display.



WARNING

The display modes may be changed or set when the engine is off, the gear must be in neutral, the motorbike must be stationary with your feet on the ground. Do not change the display while driving.

- ▶ Press “OK” for less than three seconds until “LAP VIEW” appears.





► By repeatedly pressing the “OK” key, all the times previously acquired starting from the last lap memorised can be displayed in sequence.

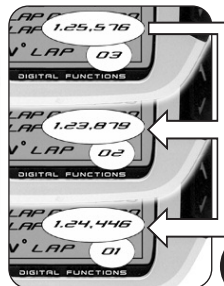

4 GB

► Once all the data have been displayed, press the “SET” key to return to the “LAPS VIEW” mode and then to the following mode.

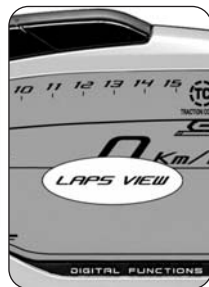



❑ How to delete data

To delete the saved data, proceed as follows:



WARNING

The display modes may be changed or set when the engine is off, the gear in neutral, the motorbike stationary with your feet on the ground. Do not change the display while driving.

▶ *Resetting of individual time recordings:* Access the “CHRONO” mode and press the “SET” key for less than three seconds until the words “SINGLE LAP RESET” appear on the display.

▶ Press the “OK” key for less than three seconds; the value of the last lap time memorised will start flashing.





► Now, press “OK” for over three seconds to delete the value. Otherwise, press “SET” for less than three seconds to stop the deletion procedure.



► Subsequently, by pressing the “OK” key for more than three seconds, all the previously acquired times can be cancelled.

► Once all the data have been cancelled, press the “SET” key to return to the “LAPS VIEW” mode and then to the following mode.





► *Resetting of best lap time:* Access the “LAPS VIEW” mode and press the “SET” key for less than three seconds until the words “BEST LAP RESET” appear on the display.



► Press the “OK” key for less than three seconds; the value of the fastest last lap time memorised will start flashing.





► Now, press “OK” for over three seconds to delete the value. Otherwise, press “SET” for less than three seconds to stop the deletion procedure.

► Once all the data have been cancelled, the display shows “LAP TIME ERASED”, then returns to the “LAPS VIEW” mode.

► *Resetting of all lap times recorded:* Access the “LAPS VIEW” mode and press the “SET” key for less than three seconds until the words “ALL LAPS RESET” appear on the display.





► Press the “OK” key for less than three seconds; the display will ask you to confirm cancellation of all the data present in the memory.



► By pressing the “OK” key for more than three seconds, all the previously acquired times will be cancelled. By pressing the “SET” key for less than three seconds, the cancellation procedure will be interrupted.

► Once all the data have been cancelled, the display shows “ALL LAPS ERASED”, then returns to the “LAPS VIEW” mode.





4.4.5. "NIGHT/DAY" Mode

► To convert the display background colour, access the "NIGHT/DAY MODE" and press the "OK" key for less than three seconds.



WARNING

The display modes may be changed or set when the engine is off, the gear in neutral, the motorbike stationary with your feet on the ground. Do not change the display while driving.

► By pressing the "SET" key, the daytime and night-time display modes can be changed repeatedly.

► Once the display background colour has been defined, press the "OK" key for more than three seconds in order to confirm the chosen display mode and to return to the "NIGHT/DAY MODE". The defined background colour will be maintained in all the subsequent modes of use of the dashboard.

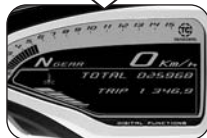
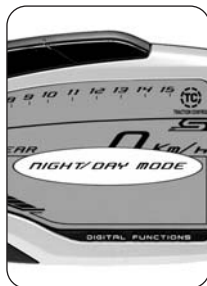



4.4.6. Electronic suspension adjustment

► In order to perform the customised adjustment of the suspensions setup, press “SET” to access to “SETTING ÖHLINS” mode.



WARNING: The display modes may be changed or set when the engine is off, the gear in neutral, the motorbike stationary with your feet on the ground. Do not change the display while driving.

NOTE: The suspension setup adjustment is allowed only if the mapping “C” of the control unit is selected (see §4.4.10.).

NOTE: Refer to the enclosed table to get the recommended suspension setup values.

□ Compression damping (Front suspension)

► By pressing “OK” for less than three seconds, the display shows the available suspension adjustment parameters.

► After some seconds, the “FRONT” and “C” captions start blinking; it is now possible to modify the compression damping value for the front suspension.





▶ Press “OK” for less than three seconds: the compression damping level rises up to the next value. Such value may range between **1** and **26**.

▶ Press “OK” for over three seconds to confirm the selected compression damping level; the display is ready for the next adjustment. Otherwise, press “SET” for less than three seconds to stop the adjustment procedure, save the settings and return to the main menu.



4 GB

□ Rebound damping (Front suspension)

▶ After some seconds, the “FRONT” and “R” captions start blinking; it is now possible to modify the rebound damping value for the front suspension.

▶ Press “OK” for less than three seconds: the rebound damping level rises up to the next value. Such value may range between **1** and **26**.

▶ Press “OK” for over three seconds to confirm the selected rebound damping level.





❑ Compression damping (Rear suspension)

- ▶ After some seconds, the “REAR” and “C” captions start blinking; it is now possible to modify the compression damping value for the rear suspension.
- ▶ Press “OK” for less than three seconds: the compression damping level rises up to the next value. Such value may range between **1** and **26**.
- ▶ Press “OK” for over three seconds to confirm the selected compression damping level.



❑ Rebound damping (Rear suspension)

- ▶ After some seconds, the “REAR” and “R” captions start blinking; it is now possible to modify the rebound damping value for the rear suspension.
- ▶ Press “OK” for less than three seconds: the rebound damping level rises up to the next value. Such value may range between **1** and **26**.
- ▶ Press “OK” for over three seconds to confirm the selected rebound damping level.





❑ Steering damper

- ▶ After some seconds, the display shows the available modes for steering damper adjustment (“AUTO”: automatic; “MANUAL”: customised).
- ▶ Press “OK” for less than three seconds; the “AUTO” caption will start blinking.
- ▶ Press “SET” for less than three seconds; the “MANUAL” caption will start blinking. Pressing “OK” for more than three seconds enables you to modify the steering damping value.
- ▶ Press “OK” for less than three seconds: the steering damping level rises up to the next value. Such value may range between 1 and 14.
- ▶ Press “OK” for over three seconds to confirm the selected steering damping level; the display returns to the suspension adjustment mode. Otherwise, press “SET” for less than three seconds to stop the adjustment procedure and confirm the selected suspension adjustment values.

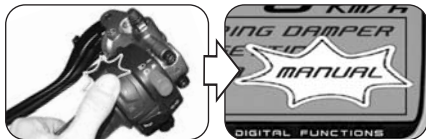

4 GB





4.4.7. Selecting the ABS function *

► Press “SET” in order to access to “ABS” mode; “SETTING ABS” appears on the display.



WARNING

The display modes may be changed or set when the engine is off, the gear in neutral, the motorbike stationary with your feet on the ground. Do not change the display while driving.

► Press “OK” for less than three seconds: the display shows the last memorized selection. Under standard conditions, “ABS NORMAL” (*ABS function for use on road*) will start blinking on the display.

► If you do not press any button, after three seconds the “ABS NORMAL” selection is confirmed; under this condition, the ABS function for use on road is activated. Press “SET” to exit the “ABS” mode.



(*): This function is present only on certain models





► Otherwise, by pressing “OK” while the caption is still blinking, “ABS RACE” (ABS function for use on race track) appears on the display.

 **WARNING:** The “ABS RACE” function has been expressly studied for use of the vehicle on race track. MV Agusta recommends not to use this function when riding on public roads.

► If you do not press any button, after three seconds the “ABS RACE” selection is confirmed. Otherwise, by pressing “OK” while the caption is still blinking, “ABS OFF” appears on the display.

► If you do not press any button, after three seconds the “ABS OFF” selection is confirmed; under this condition, the ABS system is deactivated.

 **WARNING:** When the ABS system is deactivated, the related warning light on the dashboard turns on (see §3.7.1.). From this moment on, the antilock braking system is not available when braking. Adopt a cautious driving style and ride at low speed in order to avoid losing control of the vehicle during emergency brakings.

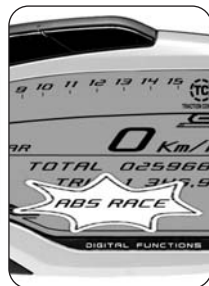



4.4.8. "QUICK SHIFT" mode

▶ Press "SET" in order to access to "QUICK SHIFT" mode. The display shows the current activation state of the "quick shift" function of the gear change.



WARNING

The display modes may be changed or set when the engine is off, the gear in neutral, the motorbike stationary with your feet on the ground. Do not change the display while driving.

▶ Press the "OK" button for less than three seconds; the activation caption of the "quick shift" function begins to flash.

▶ By pressing the "OK" button for less than three seconds, the caption toggles from "OFF" to "ON" and inversely.

▶ After some seconds, the selected "quick shift" activation state is automatically confirmed.





4.4.9. “IMMOBILIZER” Mode

The “IMMOBILIZER” lets the engine start only if it recognises the original starter key. This is actually an anti-theft device built into the electronic circuit of the vehicle, since only authorised people are allowed to drive it.

Use the dashboard “IMMOBILIZER” only in the event of a breakdown. If for any reason the original key is not recognised by the system, to let the engine start you must manually enter the secret code, which is on the MV CodeCard that was handed out to you with the motorbike.

- ▶ Remove the lid from the box on the back of the MV Code Card and read the secret electronic code of the starter key (the figure shows a random code, for information only).
- ▶ Access to “RUN” mode and press “SET” and “OK” for over three seconds until “IMMOBILIZER” appears.

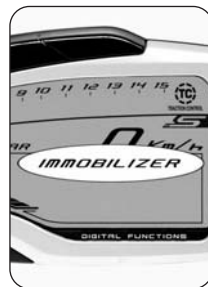

**WARNING**

The display modes may be changed or set when the engine is off, the gear in neutral, the motorbike stationary with your feet on the ground. Do not change the display while driving.

- ▶ Press “OK” for less than three seconds to set the first digit of the code.
- ▶ Press “OK” for less than three seconds to set the first digit between **0** and **9**.
- ▶ Once the digit has been selected, press “OK” for over three seconds to confirm the first digit of the code. Now, you can set the second digit of the code.
- ▶ Do the same to set the other four digits of the code.

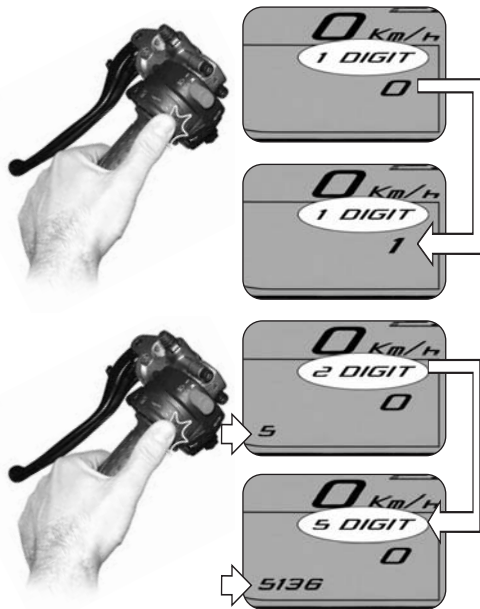



► Once the full code has been entered, “CONFIRM CODE” appears on the display. Press “OK” for over three seconds to confirm the code.

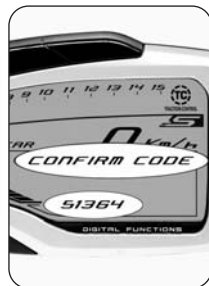

► If the entered code is recognised by the system, “VALID CODE” appears. The dashboard display goes back to “RUN”. The engine may be started.

► If the entered code is wrong, “NOT VALID CODE” appears. The system will not let the engine start; the display goes back to “IMMOBILIZER”. Repeat the code entry procedure from the start, taking care of setting all the right digits shown on your MV Code Card. If the problem persists, contact a MV Agusta licensed service centre.

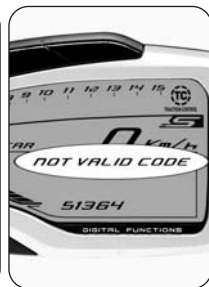
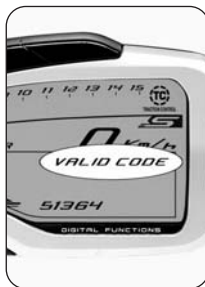



4.4.10. How to select the mapping of the control unit

On the F4 RR model it is possible to select different control unit mappings which allow to obtain variable power and performance characteristics based on the type of vehicle use.

NOTE

The mapping selection may be performed even during the use of the vehicle.

The mapping of the control unit can be selected by pressing the start button when the engine is switched on; this way the mapping switches to the following setting value. The corresponding mapping characteristics are listed in the following table.

Mapping	N	R	S	C
Mode	Normal	Rain	Sports	Customised

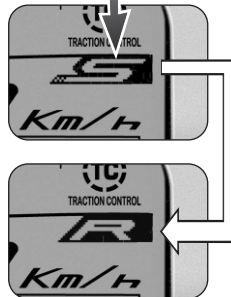



□ Setting of “Custom” mapping

▶ Press the start button when the engine is switched on until selecting the mapping “C” of the control unit (“Custom” mapping).



WARNING

The “Custom” mapping setting operations must be performed when the the gear is in neutral and the motorbike stationary with your feet on the ground. Do not change the display while driving.

▶ Press “SET” until “SETTING C MAP” appears.

In order to adjust the “Custom” mapping parameters to your driving requirements, perform the following operations.

▶ *Throttle control sensitivity*: Press “OK” for less than three seconds until “GAS SENSITIVITY” appears.

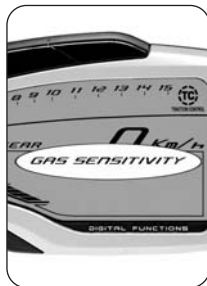



▶ Press “SET” for less than three seconds. The display shows the current setting for throttle control sensitivity.



▶ Press “OK” for less than three seconds; the displayed setting will start flashing.

▶ By repeatedly pressing “OK” for less than three seconds, the following settings can be displayed in sequence:

- “NORMAL”
- “RAIN”
- “SPORT”

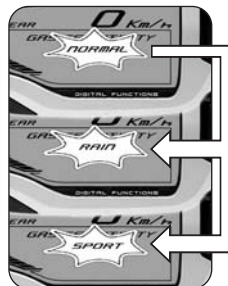



► Press “OK” for more than three seconds; the new setting will be confirmed. The displayed caption stops flashing and after a few seconds the display returns to “GAS SENSITIVITY” mode. It is now possible to proceed with the setting of the following parameter.



► *Maximum engine torque:* Press “OK” for less than three seconds until “MAX ENGINE TORQUE” appears.

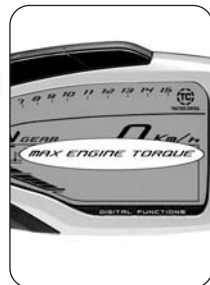



► Press “SET” for less than three seconds. The display shows the current setting for maximum engine torque.

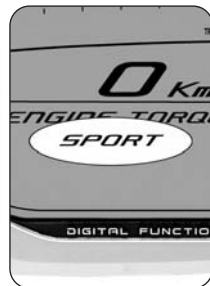

► Press “OK” for less than three seconds; the displayed setting will start flashing.

► By repeatedly pressing “OK” for less than three seconds, the following settings can be displayed in sequence:

- “SPORT”
- “RAIN”





► Press “OK” for more than three seconds; the new setting will be confirmed. The displayed caption stops flashing and after a few seconds the display returns to “MAX ENGINE TORQUE” mode.

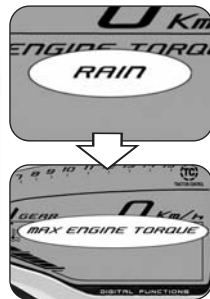

► *Engine brake*: Press “OK” for less than three seconds until “ENGINE BRAKE” appears.





▶ Press “SET” for less than three seconds. The display shows the current setting for engine brake.



▶ Press “OK” for less than three seconds; the displayed setting will start flashing.

▶ By repeatedly pressing “OK” for less than three seconds, the following settings can be displayed in sequence:

- “NORMAL”
- “SPORT”

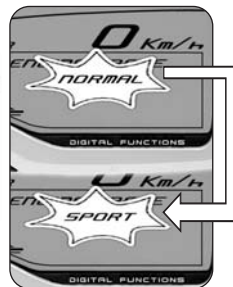



► Press “OK” for more than three seconds; the new setting will be confirmed. The displayed caption stops flashing and after a few seconds the display returns to “ENGINE BRAKE” mode.



► *Engine response*: Press “OK” for less than three seconds until “ENGINE RESPONSE” appears.

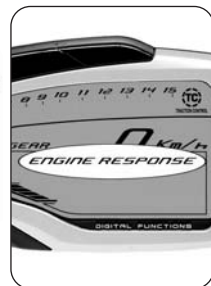



▶ Press “SET” for less than three seconds. The display shows the current setting for engine response.



▶ Press “OK” for less than three seconds; the displayed setting will start flashing.

▶ By repeatedly pressing “OK” for less than three seconds, the following settings can be displayed in sequence:

- “SLOW RESPONSE”
- “FAST RESPONSE”





► Press “OK” for more than three seconds; the new setting will be confirmed. The displayed caption stops flashing and after a few seconds the display returns to “ENGINE RESPONSE” mode.



► *Engine RPM limiter:* Press “OK” for less than three seconds until “RPM LIMITER” appears.





▶ Press “SET” for less than three seconds. The display shows the current setting for engine RPM limiter.



▶ Press “OK” for less than three seconds; the displayed setting will start flashing.

▶ By repeatedly pressing “OK” for less than three seconds, the following settings can be displayed in sequence:

- “NORMAL”
- “SPORT”





► Press “OK” for more than three seconds; the new setting will be confirmed. The displayed caption stops flashing and after a few seconds the display returns to “RPM LIMITER” mode.



► Press “OK” for less than three seconds until the display switches to the “RUN” mode. The setting of the “Custom” mapping is completed.





4.4.11. Warning/malfunction alerts

The dashboard may highlight the presence of a fault or a malfunction during different using conditions of the motorcycle.

► *Engine start:* As you turn the ignition switch to the ON position, the instruments and the warning lights will go through the self-diagnostic cycle. If the self-diagnostic cycle detects a fault in the vehicle, the display shows the warning alert shown in the picture. In particular, this message highlights the vehicle part or device on which the fault has been detected.

► Press “OK” button to access to “RUN” mode.



WARNING

If a fault is detected on the vehicle when the engine is off, do not start engine and contact an authorized MV Agusta centre.





► *Fault during vehicle riding:* If a fault is detected during riding, the lower portion of the display shows the warning alert shown in the picture.

**WARNING**

If a fault is detected during riding, stop the vehicle and contact an authorized MV Agusta centre.

► After the vehicle is stopped, the display shows the warning message highlighting the vehicle part or device on which the fault has been detected.



4 GB





► *High coolant temperature:* If a high value of the coolant temperature is detected, the display shows the warning alert shown in the picture. This message may appear during every using condition of the vehicle.

**WARNING**

If the coolant temperature is high, stop the motorbike and check the coolant level. If it needs to be filled up, contact a MV Agusta licensed service centre (see § 3.8). If the warning alert appears even if the level is adequate, stop driving and contact a MV Agusta licensed service centre.





4.5. Refuelling



WARNING

Petrol and its fumes are highly toxic and flammable. Avoid contact and inhalation. When refuelling, switch off the engine, avoid smoking, and keep away from flames, sparks and heat sources. Perform refuelling in the open air or in a well ventilated area.



CAUTION

Only use unleaded and alcohol-free fuel with a R.O.N. octane rating of 95 or higher. The green dot on the lower side of the tank cap and the label on the fuel tank serve as a reminder of this.

- ▶ Lift the dust cover.
- ▶ Insert the key into the lock, rotate it clockwise and lift the tank cap.
- ▶ After refuelling, press down the tank cap while rotating the key clockwise to facilitate the locking. Then release the key and remove it.



**WARNING**

Overfilling the tank may cause the fuel to overflow as a result of the expansion due to the heat from the engine or to exposure to sunlight. Fuel spills can catch fire. The level of the fuel in the tank must never be higher than the base of the filler.

**CAUTION**

Immediately wipe the overflowed fuel with a clean cloth, to avoid damage to the painted or plastic surfaces.

**WARNING**

Verify that the tank filler cap is correctly closed before using the motorcycle.





4.6. Glove compartment

- ▶ Insert the key.
- ▶ Push the passenger seat downwards at the back and at the same time turn the key in a clockwise direction.
- ▶ Lift up the passenger seat at the back end, let it slide forwards and remove.

In order to reassemble the above mentioned part, you must perform the following operations:

- Rotate the key into the lock
- Press down the passenger seat
- Release the key
- Press down the seat once more, so to make sure of its firm coupling to the frame.



WARNING

Every time you lift or remove the passenger seat and every time the vehicle is used, make sure that the above mentioned part is correctly placed and that it is firmly secured to the motorcycle framework.





4.7. Parking the motorcycle

□ Using the sidestand



CAUTION

- Park the motorcycle safely on solid ground.
- On slopes, engage the first gear and park the vehicle so that the front wheel faces uphill. Remember to put the gear lever in the neutral position before restarting the engine.
- Never leave the vehicle unattended while the engine key is in the dashboard.

► Using your foot, lower the sidestand as far as it will go, and then slowly tip the motorcycle toward you to bring the stand supporting foot into contact with the ground's surface.

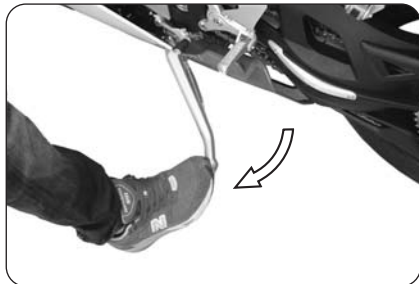

**WARNING**

Do not sit on the vehicle when it is parked on the sidestand, as your full weight would rest on the vehicle's only support.

**WARNING**

Before riding off, ensure that the sidestand warning light on the instrument panel goes out. In any case, make sure that the stand has been retracted.

If you notice a malfunction of the side stand switch, have it controlled by your MV Agusta dealer before using the motorcycle.

□ Using the rear stand

Insert the stand pin into the rear wheel axle hole on the left side of the motorcycle. Rest the stand on the ground and, pressing down on the stand, lift the vehicle until it reaches a stable condition.

**CAUTION**

This operation is best carried out with two people, one to steady the motorcycle and one to manipulate the rear stand.





5.1. List of adjustments

There are many adjustments that can significantly improve the ergonomics, geometry and safety of the motorcycle.

However, since an incorrect adjustment of particularly important components can lead to dangerous situations, some of the above adjustments must be performed only by authorized MV Agusta Service Centers.



WARNING

All adjustments must be performed when the vehicle is stationary.





(F) Rearview mirror adjustment (§5.5.)

(A) Clutch lever adjustment (§5.4.)

(F) Rearview mirror adjustment (§5.5.)

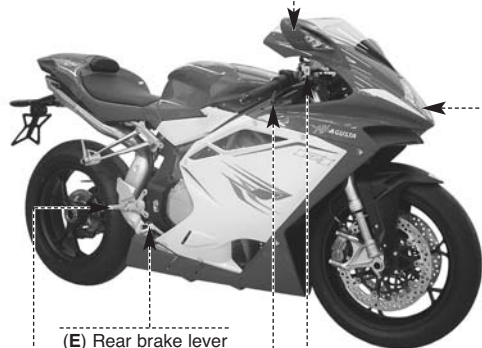

(E) Rear brake lever adjustment (5.2.)

(C) Right-hand footrest adjustment (§5.2.)

(G) Steering damper adjustment (§4.4.6.)

(D) Gear lever adjustment (§5.2.)

(L) Rear suspension adjustment (§4.4.6.)

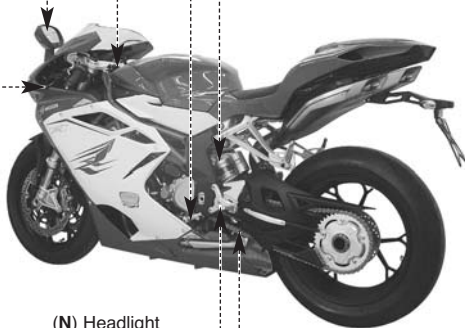

(N) Headlight adjustment (§5.9.)

(H) Front suspension adjustment (§5.6. and §4.4.6.)

(B) Front brake lever adjustment (§5.3.)

(M) Drive chain adjustment (§5.2.)

(C) Left-hand footrest adjustment (§5.2.)





5.2. Table of adjustments

	A - Clutch lever adjustment: Optimizes the grip to suit the rider's needs (§5.4).	
	B - Front brake lever adjustment: Optimizes the grip to suit the rider's needs (§5.3).	
	C - LH and RH footrest adjustment: Optimizes the position of the feet to suit the rider's needs.	
	D - Gear lever adjustment: Optimizes the position of the lever to suit the rider's needs.	
	E - Rear brake lever adjustment: Optimizes the position of the lever to suit the rider's needs.	
	F - Rearview mirror adjustment: Optimizes the orientation of the rearview mirrors (§5.5).	
	G - Steering damper adjustment: Adjusts the steering stiffness to the rider's preference (§4.4.6.).	
		H - Front suspension adjustment: The following can be adjusted to adapt the response of the suspension to the rider's preference: <ul style="list-style-type: none">- spring preload (§5.6.1.)- rebound damper (§4.4.6.)- compression damper (§4.4.6.)
		L - Rear suspension adjustment: The following can be adjusted to adapt the response of the suspension to the rider's preference: <ul style="list-style-type: none">- geometry height- spring preload
		<ul style="list-style-type: none">- rebound damper (§4.4.6.)- compression damper (§4.4.6.)
		M - Drive chain adjustment: To ensure safe and effective transmission of power.
		N - Headlight adjustment: To adjust the range of the light beam to the geometry of the motorcycle (§5.7).





5.3. Adjusting the front brake lever

Turn the ring clockwise or counterclockwise to move the lever away or towards the handgrip respectively.

5.4. Adjusting the clutch lever

Turn the ring clockwise or counterclockwise to move the lever away or towards the handgrip respectively.

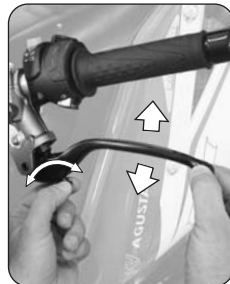

5.5. Adjusting the rearview mirrors

Press the mirror at the points shown in the figure to adjust its position in the four directions.

Perform the adjustment on both rearview mirrors. It is recommended to sit on the vehicle in order to optimize the rearview mirrors adjustment.

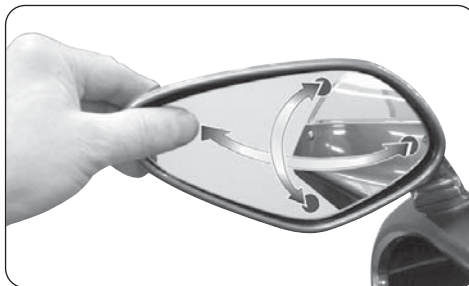



5.6. Adjusting the front suspension

NOTE

The adjustment of the suspensions must be preferably performed with the fuel tank full.

NOTE

For rebound and compression damping adjustment, refer to the procedures described at §4.4.6.

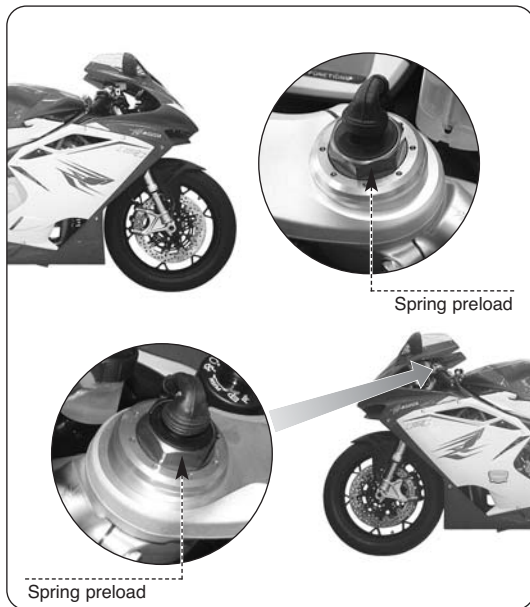

Spring preload

Spring preload





5.6.1. Spring preload (front suspension)

► In order to access to the spring preload adjustment nut, lift the protection sheath and detach the connector by using a flat head screwdriver.



► The adjustment is obtained from the reference position, which is found by fully turning the adjusting nut counterclockwise; from this position, turn the screw clockwise until you reach the standard position (see enclosed table). Rotate clockwise to increase the spring preload or counterclockwise to decrease it.

► When the adjustment operations have been completed, reattach the connector and replace the protection sheath.



5 GB





5.7. Headlight adjustment

Place the vehicle at a distance of 10 m from a vertical wall. Make sure that the motorcycle is placed on an even horizontal surface, and that the headlight's optical axis is perpendicular to the wall.

The vehicle must be held in an upright position. Measure the "X" distance between the headlight center and the ground surface, then trace a small cross on the wall at the same height.

When you turn the headlight on, the upper boundary line between the dark area and the lighted area must be at a height equal or lower than the 9/10 of the headlight center height (X).

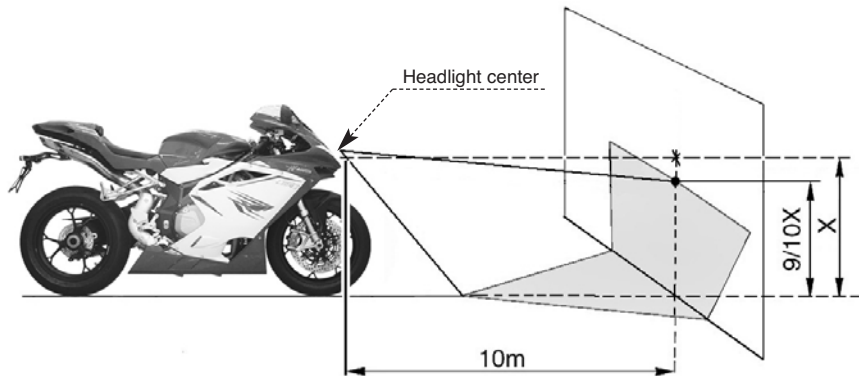



The light beam can be adjusted vertically by turning the screw illustrated. If turned in a clockwise direction: the optical unit tilts upwards. If turned in an anti-clockwise direction: the optical unit tilts downwards. It can be tilted up to an angle of $\pm 4^\circ$ from the standard position.

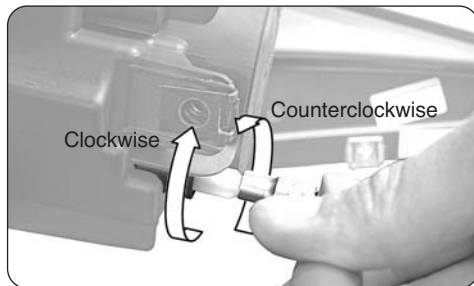



Information

MV Agusta S.p.A. is committed to a policy of constant improvement; therefore, you may find slight differences between the information provided in this document and the vehicle you purchased. MV Agusta motorcycles are exported in several countries, in which different rules and regulations (concerning both the Highway Code and the homologation procedures) are in force. Relying on your understanding, MV Agusta S.p.A. deems it necessary to reserve the right to change its products and the related documentation at any time and without notice.

We suggest to often visit the Internet site www.mvagusta.it in order to obtain informations and updates about the MV Agusta products and the related documentation.



Respect and defend natural environment

Everything we do affects the whole planet as well as its resources.

MV Agusta, in order to protect the interests of the community, awakens the Customers and the Technical Assistance operators to use the vehicle and dispose of its replaced parts respecting the laws in force concerning environmental pollution and waste disposal and recycling.

© 2012

This document may not, in whole or in part, be reproduced without prior consent, in writing, from MV Agusta S.p.A.

Part No. 8000B7637

Edition No. 1 - November 2012



MV AGUSTA



Manuel d'utilisation
Version Française



Cher client,

Nous vous remercions de la confiance que vous nous accordez et vous félicitons pour votre nouvelle F4 RR.

Votre choix récompense l'application et l'effort passionné de nos techniciens pour donner à la F4 RR des caractéristiques fonctionnelles et esthétiques qui la placent au dessus des motos de plus haut niveau actuellement disponibles sur le marché et font d'elle un objet convoité et exclusif.

Si d'un point de vue purement technique, la F4 RR représente avec ses nombreuses innovations, une référence au niveau mondial, sa ligne hors du temps douce et fuselée est une magnifique fusion entre un passé glorieux et un nouveau millénaire.

Le mariage de ces éléments, que seuls la recherche du détail, la passion et le désir de réaliser une moto techniquement et esthétiquement supérieure, ont permis d'atteindre, élève la F4 RR au dessus de toutes les modes passagères et lui confère le privilège d'être considérée comme un objet unique au monde.

Si vous désirez plus d'information, n'hésitez pas à contacter notre Service Après-Vente MV Agusta.

Bon divertissement

*Giovanni Castiglioni
Président
MV Agusta*



TABLE DES MATIÈRES

<i>Chap.</i>	<i>Sujets abordés</i>	<i>page</i>
1	GÉNÉRALITÉS	5
1.1.	Utilité de ce livret	5
1.2.	Symboles	6
1.3.	Contenu du support digital	7
1.4.	Données d'identification	8
2	INFORMATIONS SUR LA SÉCURITÉ	11
2.1.	Utilisation admise du véhicule	11
2.2.	Entretien	11
2.3.	Accessoires et modifications	12
2.4.	Chargement du véhicule	12
3	COMMANDES ET APPAREILS	14
3.1.	Position des commandes et appareils	14
3.2.	Béquille latérale	15
3.3.	Commandes au guidon gauche	16
3.4.	Commandes au guidon droit	18
3.5.	Contacteur principal et verrouillage de direction	21
3.6.	Sélecteur de vitesses	24
3.7.	Appareils et voyants	25
3.7.1.	Voyants lumineux	26
3.7.2.	Affichage multifonctions	27
3.8.	Tableau des lubrifiants et liquides	28

<i>Chap.</i>	<i>Sujets abordés</i>	<i>page</i>
4	UTILISATION	29
4.1.	Utilisation de la moto	29
4.2.	Rodage	30
4.3.	Démarrage	32
4.4.	Sélection et modification des fonctions à l'écran	35
4.4.1.	Sélection des fonctions écran	36
4.4.2.	Mise à zéro des fonctions des compteurs kilométriques partiels	41
4.4.3.	Modalité "TC"	43
4.4.4.	Chronomètre	44
4.4.5.	Modalité "NIGHT/DAY"	53
4.4.6.	Réglage électronique des suspensions	54
4.4.7.	Sélection des fonctions ABS	58
4.4.8.	Modalité "QUICK SHIFT"	60
4.4.9.	Modalité "IMMOBILIZER"	61
4.4.10.	Sélection représentation de la centrale	64
4.4.11.	Messages d'avertissement/pannes	76
4.5.	Approvisionnement en carburant	79
4.6.	Accès à la boîte à gants	81
4.7.	Stationnement de la moto	82



TABLE DES MATIÈRES

<i>Chap.</i>	<i>Sujets abordés</i>	<i>page</i>
5	RÉGLAGES	84
5.1.	Liste des réglages	84
5.2.	Tableau des réglages	86
5.3.	Réglage du levier de frein avant	87
5.4.	Réglage du levier d'embrayage	87
5.5.	Réglage des rétroviseurs	87
5.6.	Réglage de la suspension avant	88
5.6.1.	Précharge du ressort (suspension avant)	89
5.7.	Réglage du projecteur avant	90



1.1. Utilité de ce livret

Le présent Manuel fournit les informations nécessaires pour une utilisation correcte et sûre de la moto.

Est également fourni un Manuel Rapide de poche contenant les informations essentielles pour l'utilisation du véhicule.

Le Manuel est fourni aussi sous format électronique (.pdf) sur support digital fournis et peut être imprimé ou affiché sur tout PC avec système Windows ou Mac.

Nous vous recommandons de lire attentivement le Manuel avant d'utiliser la moto et de vous assurer que toutes les personnes utilisant la moto ont lu attentivement le Manuel.

Nous vous conseillons de toujours avoir sur vous le Manuel Rapide avec vos données d'identification et celles de la moto.



Copyright
MV AGUSTA Motor Spa
Tous droits réservés





1.2. Symboles

Les parties du texte particulièrement importantes qui concernent la sécurité de la personne et l'intégrité de la moto, sont mises en évidence par les pictogrammes suivants:



Danger - Attention: le non respect partiel ou total de ces prescriptions peut être source de danger pour soi-même et pour autrui.



Prudence - Précautions: le non respect partiel ou total de ces prescriptions peut être cause de dommages pour la moto.

Pour indiquer les personnes autorisées à exécuter les opérations de réglage et/ou d'entretien, celles-ci sont mises en évidence par les pictogrammes suivants:



Informations sur les opérations permises au motard.



Informations sur les opérations qui doivent être effectuées uniquement par le personnel autorisé.

Pour mettre en évidence les informations supplémentaires, les symboles suivants sont utilisés:



Le symbole  indique la nécessité d'utiliser un outil ou un appareil spécial pour l'exécution correcte de l'opération décrite.



Le symbole "§" renvoie au chapitre correspondant au numéro qui l'accompagne.





1.3. Contenu du support digital

Dans support digital fourni contient en sus du présent Manuel, le Manuel d'Entretien, le Manuel Rapide (est également fournie une version imprimée), le Guide des Concessionnaires et le Livret de Garantie.

Au moment de vous remettre la moto, votre Concessionnaire vous a remis le Certificat de Garantie et de Préparation à la route.

Nous vous invitons à conserver le Certificat avec les documents de la moto et les coupons qui vous seront remis à toutes les opérations de révision prévues par la garantie.

IMPORTANT

Les copies du Certificat de Garantie et de Préparation à la route doivent être remplie par le Concessionnaire. Une copie doit être remise au Client, une copie doit être conservée par le Concessionnaire et la troisième doit être envoyée à l'Importateur.

Les copies des coupons de révision recommandée doivent toujours être remplies par le concessionnaire. Elles doivent être conservées par le Client et le Concessionnaire.





2) numéro de série du moteur



1) numéro de série du cadre

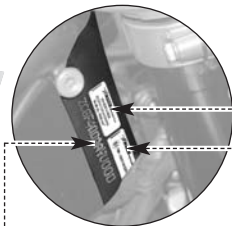

3) données d'homologation

1.4. Données d'identification

- 1) numéro de série du cadre
- 2) numéro de série du moteur
- 3) données d'homologation

► Identification de la moto

La moto est identifiable grâce au numéro de série du cadre. Pour les commandes de pièces détachées, il peut être nécessaire d'indiquer également le numéro de série du moteur, le code couleur et le numéro d'identification des clés.

Il est conseillé de noter les données principales dans les espaces ci-dessous:

CADRE N.: _____

MOTEUR N.: _____





► Identification des clés de la moto

Une clé est fournie en double exemplaire, elle sert pour le contacteur de démarrage et pour toutes les autres serrures. Garder le double en lieu sûr.

Il est indispensable de connaître le numéro d'identification de la clé pour en demander un double. Le numéro d'identification de la clé est imprimé sur la MV Code Card fournie avec les clés de démarrage.



1

FR

► Identification de la combinaison de couleur de la moto

Le code couleur est indispensable pour la commande de pièces détachées de la carrosserie. On peut lire ce code sur la plaque qui se trouve sur la partie droit inférieure du réservoir d'essence.

Pour accéder à la plaque du code couleur, il faut enlever le flanc réservoir droit.

Retirez la partie arrière du flanc réservoir gauche comme représenté sur la figure.



**FR 1**

Enlevez le flanc réservoir droit en le tirant vers la partie arrière de la moto.



Après avoir enlevé le flanc réservoir gauche, on peut lire la plaque du code couleur. Cette plaque porte la mention du code couleur de la moto qui détermine la couleur des parties de la carrosserie.

Il est conseillé de noter le numéro d'identification du code couleur de la moto dans l'espace suivant:

CODE COULEUR:





2.1. UTILISATION ADMISE DU VEHICULE

La moto a été conçue pour une utilisation sur route et autoroute.



ATTENTION

Il est possible d'utiliser occasionnellement la moto sur piste mais pas dans le cadre de compétitions.

En raison des contraintes supplémentaires auxquelles est alors soumise la moto, nous vous recommandons de faire contrôler par un Centre d'Assistance MV Agusta les conditions de la moto avant et après l'emploi.

Toute autre utilisation est interdite et expressément exclue.

Vous trouverez d'autres informations sur l'utilisation de la moto dans la section 4 du présent Manuel.

2.2. ENTRETIEN

Pour garantir l'efficacité et la fiabilité maximum du véhicule, il est indispensable d'effectuer les opérations d'entretien indiquées dans le Manuel d'Entretien.

MV Agusta insiste sur le fait que toutes les opérations d'entretien doivent être effectuées uniquement par un personnel qualifié appartenant à un Centre d'Assistance MV Agusta.

Si toutefois vous décidez de faire exécuter les interventions d'entretien par des ateliers non agréés, nous vous conseillons de vous assurer qu'ils disposent des instruments spécifiques nécessaires à de telles opérations.



ATTENTION

La garantie MV Agusta pourrait ne pas être valable si les ateliers non agréés ont effectué des interventions sur la moto de manière incorrecte et non prévue par les Circulaires Techniques et les Manuels d'Atelier MV Agusta.





2.3. ACCESSOIRES ET MODIFICATIONS



ATTENTION

Pour garantir la sécurité de ses Clients, MV Agusta interdit toute modification aux motos.

Toutefois, vous pouvez personnaliser votre moto en utilisant les Accessoires MV Agusta.



ATTENTION

L'installation de quelques-uns de ces accessoires peut annuler l'homologation de la moto et entraîner la non-utilisation sur route publique.

Dans le doute, nous vous invitons à contacter votre Concessionnaire de confiance pour identifier les accessoires les plus appropriés à vos exigences.

2.4. CHARGEMENT DU VÉHICULE

Le véhicule a été conçu pour être utilisé par un pilote et le cas échéant un passager. Pour l'utiliser en toute sécurité et dans le respect des dispositions du code de la route, il est obligatoire de ne jamais dépasser la masse maximale techniquement admissible dont la valeur est indiquée ci-dessous.

F4 RR:

Masse maximale techniquement admissible:

378 kg

Masse de charge maximum:

165 kg

La masse maximale techniquement admissible est la somme des masses suivantes:

- masse de la moto en ordre de marche;
- masse du pilote;
- masse du passager;
- masse des bagages et des accessoires.



**ATTENTION**

Etant donné que le chargement a un impact énorme sur la mania-bilité le freinage, les performances et les caractéristiques de sécurité de votre moyen de transport, prenez toujours les précautions suivantes.

- **NE SURCHARGEZ JAMAIS LE MOTOCYCLE !** L'utilisation d'une moto surchargée peut provoquer des dégâts aux pneumatiques, des pertes de contrôle ou des accidents graves. Vérifiez que le poids total du pilote, du passager, du chargement et des accessoires ne dépasse pas la cha.





3.1. Position des commandes et appareils

FR 3

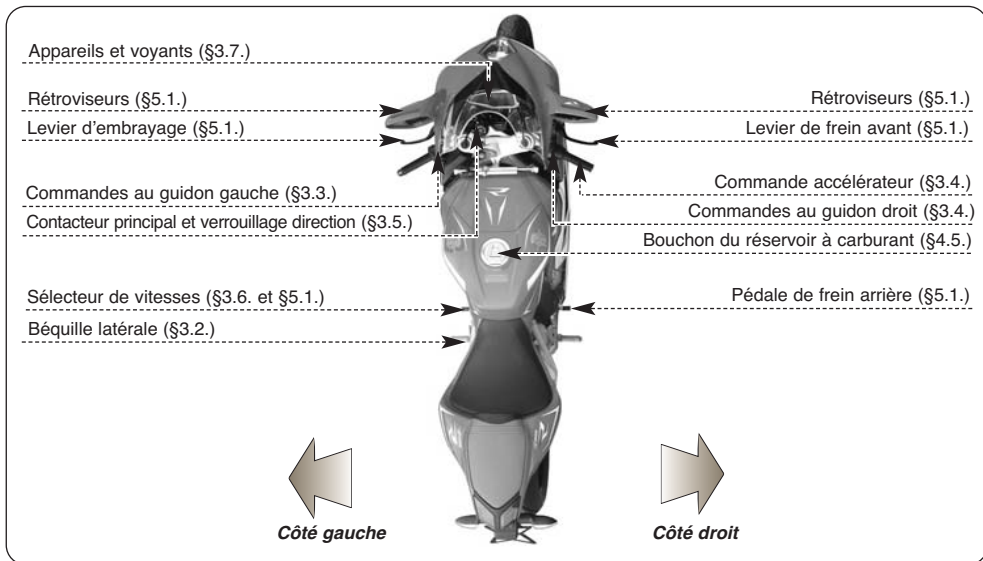



3.2. Béquille latérale

La béquille latérale est équipée d'un contacteur qui empêche à la moto de démarrer avec la béquille baissée.

Si le sélecteur de vitesses est actionné pour mettre la moto en mouvement lorsque le moteur tourne avec la béquille abaissée, le contacteur coupe le courant au moteur et provoque son arrêt.

Dans le cas où la moto se trouve en condition de stationnement (béquille baissée) avec un rapport engagé, le contacteur empêche le démarrage du moteur pour éviter tout risque de chute accidentelle.

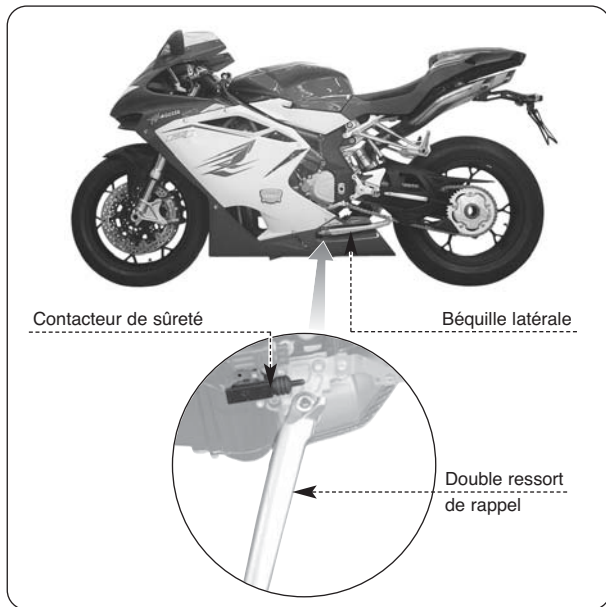



3.3. Commandes au guidon gauche

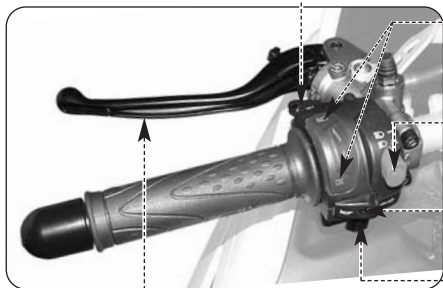

Bouton de clignotement des phares

Appuyer sur le bouton à répétition

Bouton SET/OK

Appuyer pour sélectionner les fonctions de l'écran (§ 4.4.).

Inverseur code/phare

Bouton sorti ■ : feu de croisement 

Bouton enfoncé ▬ : feu de route 

Bouton de l'avertisseur sonore

Appuyer pour utiliser l'avertisseur.

Poussoir de clignotants

En le déplaçant vers la droite ou la gauche on allume les clignotants correspondants. Le poussoir revient au centre, appuyer dessus pour éteindre les clignotants.

Levier d'embrayage

Tirer ou relâcher la poignée pour débrayer ou embrayer.





Bouton d'appel de phare

Cette fonction sert pour rappeler l'attention des autres usagers de la route en présence d'une situation dangereuse. Avec le feu de route éclairé, cette fonction est désactivée.

Bouton inverseur code/phare

C'est normalement la fonction code qui s'allume. Lorsque les de trafic et de route le permettent, il est possible d'allumer le feu de route en agissant sur l'inverseur.

Bouton de klaxon

Cette fonction sert pour attirer l'attention des autres usagers en cas de situations éventuelles de danger.

Levier des clignotants

Cette fonction permet de signaler aux autres usagers de la route, l'intention de changer de direction ou de voie de circulation.



ATTENTION

Si les clignotants ne sont pas utilisés ou coupés au moment opportun, il peut y avoir un risque d'accidents. En effet, les autres conducteurs pourraient tirer des conclusions erronées concernant la trajectoire du véhicule. Actionnez toujours les clignotants avant de tourner ou de changer de voie.

Veillez à les couper dès que la manoeuvre est terminée.

Levier d'embrayage

Ce levier, à travers un dispositif à contrôle hydraulique, permet de débrayer et d'embrayer.





3.4. Commandes au guidon droit

FR 3

Coupe-circuit

Coupe le moteur et empêche le démarrage.

Bouton de démarrage moteur

Actionne le démarreur. Dès que le moteur part, il faut le relâcher.
Une fois le moteur en marche, il sert pour sélectionner la représentation de la centrale (§.4.4.10.).

Commande d'accélérateur

Tourner pour régler l'alimentation du moteur.

Levier de frein avant

Tirer vers la poignée pour actionner le frein avant.

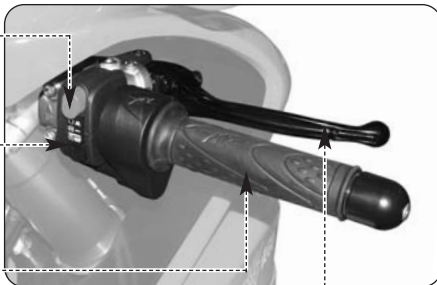



Coupe-circuit moteur

Cette fonction permet d'éteindre le moteur en cas d'urgence. De cette manière, le circuit d'allumage est coupé empêchant le redémarrage du moteur. Pour pouvoir démarrer, ramener le bouton en position de repos.

NOTE

En conditions normales, n'utilisez pas ce dispositif pour couper le moteur.

Bouton de démarrage moteur

Ce dispositif permet le démarrage du moteur. De plus, une fois le moteur démarré, il permet de sélectionner la représentation de la centrale selon la fonction correspondante du tableau de bord (voir § 4.4.10.).



RAPPEL

Pour éviter des dommages à l'installation électrique, ne tenez pas le bouton enfoncé plus de 5 secondes consécutives. Si le moteur ne démarre après plusieurs tentatives, consultez le chapitre "RECHERCHE DES PANNES" du livret.

Commande d'accélérateur

Ce dispositif permet d'agir sur l'alimentation du moteur pour varier son régime de rotation. Pour actionner le dispositif, il faut faire pivoter la poignée à partir de la position de repos qui correspond au régime de ralenti moteur.



ATTENTION

Si votre moto est tombé ou a été impliqué dans un accident, le fonctionnement du commande d'accélérateur doit être vérifiée par un centre MV Agusta agréé avant de redémarrer.





Levier frein avant

Cette commande provoque l'actionnement par l'intermédiaire d'un circuit hydraulique du système de freinage de la roue avant.

Système anti-blocage de frein (ABS) *

Certains modèles F4 sont équipés d'un système d'assistance au freinage ABS ("Antilock Braking System"), ce qui empêche les roues de se bloquer pendant le freinage d'urgence, ce qui garantit la stabilité du véhicule et le raccourcissement de la distance de freinage.



ATTENTION

Lorsque le système ABS est activé, des vibrations pourraient être perceptible sur le levier ou la pédale de frein. Dans ce cas, il est recommandé de maintenir enfoncé les dispositifs de commande des freins afin de permettre au véhicule de compléter le freinage.



ATTENTION

Si le système ABS est en panne ou est désactivé, le voyant correspondante sur le tableau de bord s'allume (voir § 3.7.1.). A partir de ce moment, le système antiblocage des freins ne pourraient pas être disponible lors du freinage. S'il ya un défaut dans le système ABS, il est recommandé de reprendre la course à vitesse réduite et contacter un centre d'assistance autorisé MV Agusta. Si le système ABS est désactivé, suivre la procédure d'activation décrite au § 4.4.7.

(*): Fonction présente uniquement sur certains modèles





3.5. Contacteur principal et verrouillage de direction



ATTENTION

Ne pas appliquer de porte-clés ou autre à la clé de contact pour ne pas risquer de gêner la rotation de la direction.



ATTENTION

Ne jamais chercher à changer certaines fonctions du contacteur en cours de route sous peine de perdre le contrôle du véhicule.

Le contacteur à clé branche et coupe le circuit électrique et le verrouillage de la direction; les quatre positions de commande sont décrites à la suite.

Position "OFF"

Tous les circuits électriques sont coupés. La clé peut être retirée.

Position "ON"

Tous les circuits électriques sont branchés, les appareils et les voyants effectuent l'auto-diagnostic; le moteur peut démarrer. La clé peut être retirée.



"OFF"



"ON"



RAPPEL

Ne pas laisser la clé sur la position "ON" à moteur éteint pendant trop longtemps sous peine d'endommager les composants électriques de la moto.





Position "LOCK"

Braquer le guidon à droite ou à gauche. Pousser légèrement sur la clé et la tourner simultanément en position "LOCK".

Tous les circuits sont coupés et la direction est verrouillée. La clé peut être retirée.

FR 3

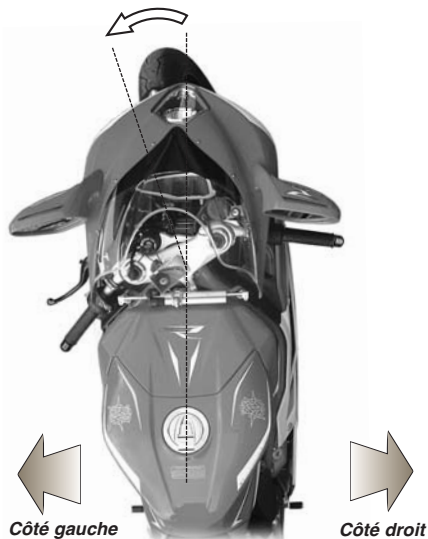

**Position "P"**

Tourner la clé de la position "LOCK" à la position "P".
Tous les circuits électriques sont coupés à l'exception
des feux de stationnement (feux de positions) et la
direction est verrouillée.
La clé peut être retirée.

**RAPPEL**

Ne pas laisser la clé sur la position "P" pendant trop longtemps pour éviter de décharger la batterie de la moto.





3.6. Sélecteur de vitesses

La position **N** "Neutral" correspond au point mort signalé par le voyant correspondant sur le tableau de bord. En déplaçant le sélecteur vers le bas, on engage la première vitesse. De la même manière, en déplaçant le sélecteur vers le haut, on passe la seconde vitesse et ainsi de suite à mesure que l'on déplace le sélecteur vers le haut, on passe dans l'ordre toutes les vitesses suivantes jusqu'à la sixième.

□ Fonction "Quick Shift"

Le modèle F4 RR est équipé d'un système de changement rapide de vitesse ("Quick Shift"); cet appareil permet de enclencher le rapport supérieur sans tirer l'embrayage ou changer l'angle de la commande des gaz. De cette façon, il est possible d'engager les vitesses supérieures en gardant une accélération constante et de réduire les temps de changement au minimum. Le système "Quick Shift" n'est pas disponible lors du changement de vitesse avec le levier d'embrayage enfoncée ou à une vitesse inférieure à 30 km/h, ni lors du passage dans les rapports inférieurs.

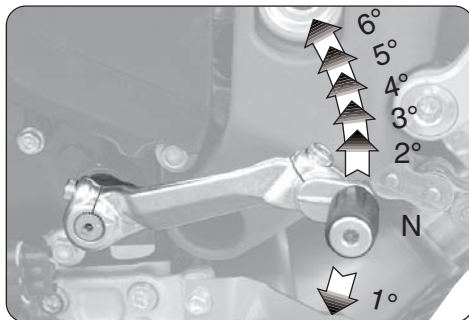

ATTENTION: Lorsque la conduite du véhicule avec le moteur à un régime élevé et une basse vitesse, changer de vitesse sans tirer sur le levier d'embrayage peut provoquer des réactions brusques ce qui peut compromettre la stabilité du véhicule. **MV Agusta recommande de tirer le levier d'embrayage dans ces circonstances, en particulier lorsque le régime moteur est proche de la vitesse de l'intervention du limiteur.**





3.7. Appareils et voyants

Les appareils et les voyants sont activés lorsque la clé de contact est mise sur "ON". Après un check-up initial (~7 secondes), les informations correspondent aux conditions générales de la moto à ce moment là.

Voyants lumineux indicateurs (§3.7.1.)

Ecran compte-tours



Bouton "SET"
(§3.7.2.)

Bouton "OK"
(§3.7.2.)

Bouton "HAZARD" (§3.7.2.)

Ecran multifonctions (§3.7.2.)





3.7.1. Voyants lumineux

Voyant Feux de route (bleu)

S'allume quand les feux de route sont allumés.

Voyant Clignotants/

Voyant "Hazard" (vert)

S'allume quand les clignotants ou les lumières d'urgence sont allumés (voir §3.7.2.).

Voyant Levier de vitesses au point mort (vert)

S'allume quand le levier est en position de point mort "Neutral".

Voyant système ABS (orange) *

S'allume lorsque le système ABS est en panne ou est désactivé ou la vitesse est inférieure à 5 km/h.



Danger - Attention: S'il s'allume pendant la marche du véhicule, s'arrêter immédiatement et vérifier que le système ABS est activé (voir §4.4.7.). Dans ce cas, reprendre la course à vitesse réduite et contacter un centre d'assistance autorisé MV Agusta.

(*): Fonction présente uniquement sur certains modèles



Voyant Pression huile moteur (rouge)

S'allume quand l'huile est à une pression insuffisante.



Danger - Attention: Si il s'allume pendant la marche, s'arrêter immédiatement, contrôler le niveau de l'huile et si nécessaire remplir le réservoir de l'huile auprès d'un centre d'assistance autorisé MV Agusta (voir §3.8). Si le voyant s'allume alors que le niveau est correct, ne pas redémarrer et contacter un centre d'assistance autorisé MV Agusta.

Voyant Limiteur de tours (rouge)

S'allume quand le moteur dépasse les 10800 rpm; le limiteur de tours intervient à 13500 rpm.

Voyant Réserve carburant (orange)

S'allume quand le réservoir ne contient plus que 4 litres de carburant environ.

Voyant d'ouverture de la béquille latérale (rouge)

Il s'allume lorsque la béquille est baissée.

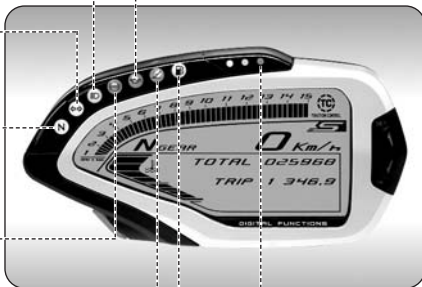



3.7.2. Écran multifonction

Écran Rapport de vitesse

Indique le rapport de vitesse actuellement inséré. La position de point mort est indiquée par la lettre "N" (neutral).

Thermomètre

Indique la température du liquide de refroidissement à travers l'allumage d'un nombre variable de segments sur une échelle de mesure graduée. Quand la température se trouve en dehors du champ de fonctionnement normal, les indications suivantes peuvent apparaître:

- sur l'écran apparaît un unique segment clignotant; c'est le signal de température faible.
- tous les segments sont allumés tandis que le segment supérieur clignote; c'est le signal de température élevée.



Danger - Attention: en cas de température élevée, arrêter le véhicule et contrôler le niveau du liquide de refroidissement. Au cas où il serait nécessaire de remplir le réservoir, s'adresser à un centre d'assistance autorisé MV Agusta (voir § 3.8). Si l'indication apparaît et que le niveau est correct, ne pas redémarrer et contacter un centre d'assistance autorisé MV Agusta.

Compteur de vitesse

Indique la vitesse. La valeur peut apparaître en kilomètre-heure (Km/h) ou bien en milles par heure (Mph). La valeur maximum est de 350 Km/h (217 Mph).

Mappage de la centrale

Indique la modalité sélectionnée de la centrale d'injection.

Bouton "SET"

Appuyer dessus pour sélectionner les chiffres de l'écran pour effectuer les réglages.

Bouton "OK"

Appuyer dessus pour confirmer les chiffres configurés.

Bouton "HAZARD"

Appuyer dessus pour allumer les lumières d'urgence.

Compteur kilométrique total "TOTAL"

Indique le kilométrage total; de 0 à 999999 (Km ou mi)

Compteur kilométrique partiel 1 "TRIP 1"

Indique le kilométrage partiel; de 0 à 999.9 (Km ou mi)

Compteur kilométrique partiel 2 "TRIP 2"

Indique le kilométrage partiel; de 0 à 999.9 (Km ou mi)

Chronomètre

Indique les temps mesurés à l'aide de la fonction chronomètre

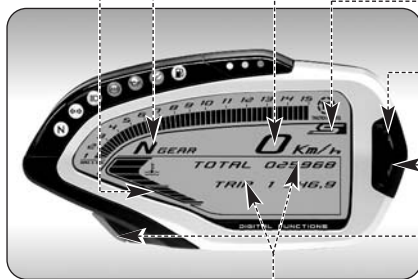



3.8. Tableau des lubrifiants et liquides

Description	Produit préconisé	Caractéristiques
Huile moteur	eni i-Ride motoGP 10W-60 (*)	SAE 10W/60 - API SG
Liquide de refroidissement	Agip Eco - Permanent	Glycol-éthylène dilué à 50% avec eau distillée
Liquide d'embrayage et freins	Agip Brake 4	DOT4
Huile de graissage de la chaîne	D.I.D. CHAIN LUBE	-

* : Pour la disponibilité du produit conseillé, MV Agusta conseille de s'adresser directement aux propres concessionnaires autorisés. L'huile moteur eni i-Ride motoGP 10W-60 a été réalisée spécialement pour le moteur de la motocyclette F4. Au cas où le lubrifiant décrit ne serait pas possible à trouver, MV Agusta conseille d'utiliser des huiles complètement synthétiques avec des caractéristiques conformes ou supérieures aux normes suivantes:

- Conforme API SG
- Conforme ACEA A3
- Conforme JASO MA
- Gradation SAE 10 W-60

NOTE

Les caractéristiques indiquées ci-dessus doivent être indiquées seules ou avec d'autres sur l'emballage de l'huile.





4.1. Utilisation de la moto

Cette partie du livret expose les principaux points qui permettent une utilisation correcte de la moto.



ATTENTION

La Votre moto montre caractéristiques élevées de puissance et de performances; pour l'utilisation, il est donc requise un niveau adéquat de connaissance du véhicule. Lors de la première utilisation de la moto, il est nécessaire de garder une attitude prudente. Une agressive ou impulsive attitude de conduite peut augmenter les risques d'accidents et représenter un danger pour Votre sécurité et celle d'autrui.



ATTENTION

LES LIMITATIONS CONCERNANT L'UTILISATION ADMISE DU VEHICULE SONT REPORTÉES DANS LA SECTION "INFORMATIONS POUR LA SÉCURITÉ".



RAPPEL

Les températures élevées provoquées par l'utilisation du véhicule sur des circuits de course ont pu compromettre l'efficacité de le convertisseur catalytique et de l'échappement; donc, nous suggérons assembler un dispositif d'échappement spécial à l'aide du véhicule sur des circuits de course.





4.2. Rodage



Prudence - Précautions: le non respect des indications suivantes peut porter préjudice à la durée et aux performances de la moto.

Le rodage est communément considéré comme une phase appliquée uniquement au moteur. En réalité, il est nécessaire également pour d'autres parties importantes de la moto, en particulier les pneumatiques, les freins, la chaîne de transmission etc. Durant les premiers kilomètres adopter une conduite tranquille.

De 0 à 500 km (de 0 à 300 mi) (A)

Pendant cette période, varier fréquemment le régime de rotation du moteur. Si possible, préférer les parcours en colline légère avec beaucoup de virages et éviter les longues lignes droites.



ATTENTION

Les pneumatiques neufs doivent être soumis à un rodage adéquat pour atteindre une efficacité complète. Eviter les accélérations, les virages et les freinages brusques pendant les premiers 100 km. Si la période de rodage initial des pneus n'est pas respectée, il y a risque de dérapage ou de perte de contrôle du véhicule entraînant un grave danger d'accident.





De 500 à 1000 km (de 300 à 600 mi)

Pendant cette période, éviter les efforts prolongés du moteur.



De 1000 à 2500 km (de 600 à 1600 mi)

Pendant cette période, il est possible de pousser un peu plus le moteur sans toutefois dépasser le régime indiqué.

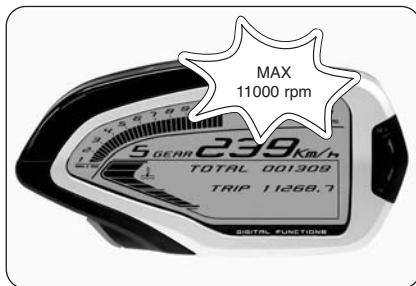



4.3. Démarrage du moteur



ATTENTION

Faire fonctionner le moteur dans un endroit fermé peut être dangereux. Les gaz d'échappement contiennent du monoxyde de carbone, un gaz incolore et inodore qui peut provoquer des décès ou des états graves. Ne faire fonctionner le moteur qu'à l'extérieur, au grand air.

► Tourner l'interrupteur de démarrage en position "ON"; l'instrumentation et les voyants exécutent le test de fonctionnement ; pendant cette phase, s'assurer de l'allumage de tous les voyants présents sur le tableau de bord.

► Afin que le système d'interruption du circuit d'allumage donne son accord pour le démarrage, une des conditions suivantes doit être observée:

- Le levier de vitesses est en position de point mort.
- Le levier de vitesses est enclenché sur une vitesse avec le levier de l'embrayage tiré et la béquille latérale relevée.





► Si le test de fonctionnement détecte un défaut sur le véhicule, l'écran affiche le message d'avertissement figurant dans l'image. En particulier, l'affichage montre le dispositif de la moto sur laquelle le défaut a été détectée.



► Appuyer sur le bouton "OK" afin d'afficher la fonction "RUN".

**ATTENTION**

Si un défaut a été détectée, ne pas démarrer le moteur et contacter un centre d'assistance autorisé MV Agusta.





❑ Procédure de démarrage

- ▶ Appuyer sur le bouton de démarrage du moteur sans tourner la poignée de l'accélérateur.
- ▶ Dès que le moteur a démarré, relâcher le bouton.



Attention - précaution:

- Afin de ne pas endommager l'installation électrique, ne pas actionner le démarrage pendant plus de 5 secondes de suite.
- Ne pas faire fonctionner le moteur avec le véhicule à l'arrêt pendant trop longtemps. La surchauffe pourrait dans ce cas endommager les composants internes du moteur. Il est préférable d'amener le moteur à la bonne température en sélectionnant une vitesse réduite.
- Afin de prolonger au maximum la vie du moteur, ne pas accélérer à fond quand le moteur est froid.

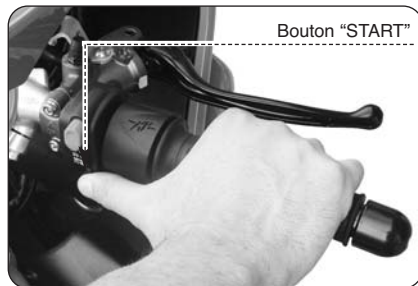



4.4. Sélection et modification des fonctions à l'écran

L'instrumentation prévoit la possibilité d'intervenir sur certains des paramètres de mesure principaux. Les opérations possibles sont:

- Sélection des modalités de fonctionnement:
 - “RUN” (Compteur kilométrique)
 - “TC” (Contrôle de la traction)
 - “CHRONO” (Chronomètre)
 - “NIGHT/DAY” (Modalité Nuit/Jour)
 - “SETTING ÖHLINS” (Réglage électronique des suspensions)
 - “ABS” (Système anti-blocage de frein)*
 - “QUICK SHIFT” (Changement de vitesse rapide)
- Mise à zéro des fonctions des compteurs kilométriques partiels:

Compteur kilométrique	Partiel 1	“TRIP 1”
Compteur kilométrique	Partiel 2	“TRIP 2”
- Modalité “IMMOBILIZER” (Système antivol)
- Sélection représentation de la centrale

(*): Fonction présente uniquement sur certains modèles





4.4.1. Sélection des fonctions écran

La sélection concerne les modes de fonctionnement suivants:

- “RUN” (Compteur kilométrique)
- “TC” (Contrôle de la traction)
- “CHRONO” (Chronomètre)
- “NIGHT/DAY” (Modalité Nuit/Jour)
- “SETTING ÖHLINS” (Réglage électronique des suspensions)
- “ABS” (Système anti-blocage de frein)*
- “QUICK SHIFT” (Changement de vitesse rapide)

L’affichage des différents modes de fonctionnement se fait en appuyant sur le bouton “SET” pendant une durée inférieure à trois secondes. En appuyant sur ce bouton, les fonctions s’affichent à l’écran de façon cyclique. Sélectionner la fonction voulue.

(*): Fonction présente uniquement sur certains modèles



ATTENTION

Les opérations de modification ou de réglage des fonctions de l’écran doivent être effectuées avec le moteur coupé, le levier de vitesse au point mort, le véhicule arrêté et les pieds à terre. Il est interdit de changer les configurations de l’écran pendant la marche.





❑ Modalité “RUN”

Outre la fonction de compteur de vitesse, sur l'écran s'affichent les fonctions suivantes (voir §4.4.2.):

- Compteur kilométrique Total “TOTAL”
- Compteur kilométrique Partiel 1 “TRIP 1”

En alternative:

- Compteur kilométrique Total “TOTAL”
- Compteur kilométrique Partiel 2 “TRIP 2”

❑ Modalité “TC”

Cette fonction permet d'adapter le niveau de contrôle de la traction du moteur selon vos propres exigences de conduite (voir §4.4.3.).





❑ Modalité “CHRONO”

Cette modalité permet l'actionnement de la fonction chronomètre et le stockage des données mesurées (voir §4.4.4.). Les fonctions affichées deviennent:

- Chronomètre Parcours actuel “CURRENT LAP”
- Chronomètre Parcours le plus rapide “BEST LAP”
- Chronomètre Parcours précédent “LAST LAP”
- Compteur de tours Nombre de tours parcourus “N° LAP”



❑ Modalité “NIGHT/DAY”

La présente fonction permet de inverser la couleur de fond de l'afficheur, pour en adapter la visibilité durant l'utilisation de jour ou de nuit du véhicule (voir §4.4.5.).





□ Modalité “SETTING ÖHLINS”

Cette fonction permet d'effectuer le réglage des éléments suivants (voir §4.4.6.):

- Suspension avant
- Suspension arrière
- Amortisseur de direction

□ Modalité “ABS” *

Ce mode de fonctionnement permet d'activer ou de désactiver le système anti-blocage de frein (ABS) (voir §4.4.7.).

(*): Fonction présente uniquement sur certains modèles





☐ Modalité “QUICK SHIFT”

Cette fonction permet de activer ou désactiver le fonction de changement rapide de vitesse (voir §4.4.8.).





4.4.2. Mise à zéro des fonctions des compteurs kilométriques partiels

Les valeurs des fonctions “TRIP 1” et “TRIP 2” peuvent être mise à zéro de la façon suivante.



ATTENTION

Les opérations de modification ou de réglage des fonctions de l'écran doivent être effectuées avec le moteur coupé, le levier de vitesse au point mort, le véhicule arrêté et les pieds à terre. Il est interdit de changer les configurations de l'écran pendant la marche.

- ▶ Accéder à la modalité “RUN”; la page-écran initiale indique les fonctions de compteur kilométrique total (“TOTAL”) et partiel 1 (“TRIP 1”).
- ▶ En appuyant sur le bouton “OK” pendant plus de trois secondes, on met la valeur “TRIP 1” à zéro.





► Appuyer sur le bouton "OK" pendant moins de trois secondes jusqu'à l'affichage de la fonction de compteur kilométrique partiel 2 ("TRIP 2").



► En appuyant sur le bouton "OK" pendant plus de trois secondes, on met la valeur "TRIP 2" à zéro.





4.4.3. Modalité “TC”

► Appuyer sur le bouton “SET” afin d’accéder à la modalité “TC”, puis appuyer sur le bouton “OK” pendant moins de trois secondes afin d’afficher “TC LEVEL”. Le niveau actuel du contrôle de traction correspond à la valeur affichée à l’écran.



ATTENTION: Les opérations de modification ou de réglage des fonctions de l’écran doivent être effectuées avec le moteur coupé, le levier de vitesse au point mort, le véhicule arrêté et les pieds à terre. Il est interdit de changer les configurations de l’écran pendant la marche.

► En appuyant sur le bouton “OK” pendant moins de trois secondes, le niveau du contrôle de traction augmente et passe à la valeur suivante. En appuyant sur le bouton “SET” pendant moins de trois secondes, le niveau du contrôle de traction diminue et passe à la valeur précédente. Cette valeur peut varier entre **0** et **8**.
► Appuyer sur le bouton “OK” pendant plus de trois secondes; la valeur choisie du niveau de contrôle de traction est confirmée.

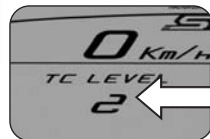
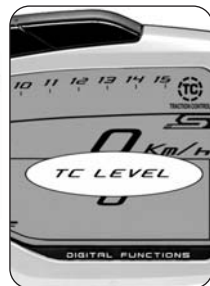



4.4.4. Chronomètre

□ Acquisition des temps de parcours

► Après avoir actionné la fonction chronomètre (modalité “CHRONO”) il est possible de lancer l’acquisition des données relatives aux temps de parcours.



► L’actionnement du bouton de clignotement du feu de route détermine le début de la mesure des données. Les points qui séparent les minutes des secondes et des dixièmes de seconde commencent à clignoter. L’instrument est en train d’acquérir les données.

NOTE: Lorsque le mode “CHRONO” est activée, la première pression du bouton de clignotement du feu de route active automatiquement le fonction “TC”. A partir de ce moment-là, il est possible de changer immédiatement le niveau de contrôle de traction en appuyant sur les boutons “SET” et “OK” (voir §4.4.3.).





► En appuyant à nouveau sur le bouton de clignotement du feu de route, la mesure du temps relatif au 1^{er} tour parcouru est enregistrée. En même temps, l'instrument commence à acquérir le temps relatif au second tour.

La mesure du temps relatif au premier tour est conservée en mémoire et reste affichée pendant dix secondes, puis on affiche le temps concernant le tour successif.

► En continuant à utiliser le chronomètre, un temps est enregistré à chaque actionnement du bouton de clignotement. L'instrument a la possibilité d'effectuer un nombre maximum de 100 enregistrements consécutifs.

Durant l'affichage du temps concernant le tour qui vient de se terminer, l'afficheur indique le symbole "-" ou "+" si le temps relevé est respectivement inférieur ou supérieur au temps mesuré durant le tour précédent.

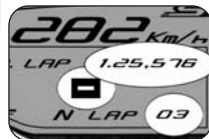
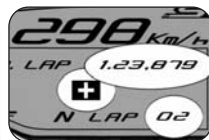
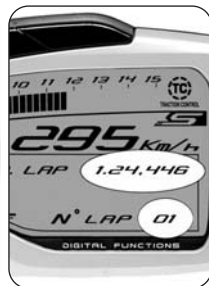



❑ Affichage des données

Une fois terminée la phase d'acquisition des temps, il est possible de les afficher.

► Accéder à la modalité "CHRONO"; cette page-écran affiche le temps concernant le tour le plus rapide ("BEST LAP") et le temps concernant le dernier tour parcouru ("LAST LAP").



ATTENTION

Les opérations de modification ou de réglage des fonctions de l'écran doivent être effectuées avec le moteur coupé, le levier de vitesse au point mort, le véhicule arrêté et les pieds à terre. Il est interdit de changer les configurations de l'écran pendant la marche.

► Appuyer sur le bouton "OK" pendant moins de trois secondes afin d'afficher "LAPS VIEW".

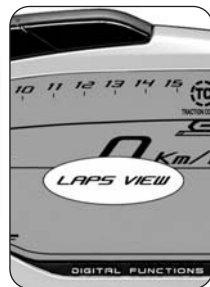



► Une pression répétée sur la touche “OK” permet d’afficher l’un après l’autre tous les temps saisis précédemment à partir du dernier tour mémorisé.

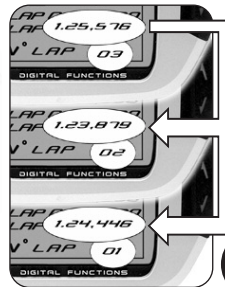

4

► Au terme de l’affichage des données, une pression sur la touche “SET” permet de revenir à la modalité “LAPS VIEW” pour passer à la modalité successive.

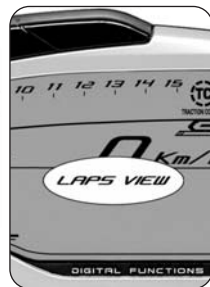



❑ Effacement des données

L'opération d'effacement des données enregistrées se fait en appliquant les procédures suivantes:



ATTENTION

Les opérations de modification ou de réglage des fonctions de l'écran doivent être effectuées avec le moteur coupé, le levier de vitesse au point mort, le véhicule arrêté et les pieds à terre. Il est interdit de changer les configurations de l'écran pendant la marche.

► *Effacement d'un temps à la fois:* Accéder à la modalité "CHRONO" et appuyer sur le bouton "SET" pendant moins de trois secondes jusqu'à l'affichage du message "SINGLE LAP RESET".

► Appuyer sur le bouton "OK" pendant moins de trois secondes; la valeur du dernier temps sur le tour mémorisé commence à clignoter.





► Appuyer alors sur le bouton "OK" pendant plus de trois secondes pour effacer la valeur. Par contre, en appuyant sur le bouton "SET" pendant moins de trois secondes, la procédure d'effacement s'interrompt.

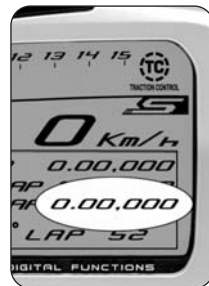

► Ensuite, une pression sur le bouton "OK" pendant plus de trois secondes permet d'effacer un à un tous les temps saisis précédemment.

► Au terme de l'effacement des données, une pression sur le bouton "SET" permet de revenir à la modalité successive "LAPS VIEW" pour passer à la modalité successive.





► *Effacement du meilleur temps:* Accéder à la modalité "LAPS VIEW" et appuyer sur le bouton "SET" pendant moins de trois secondes jusqu'à l'affichage du message "BEST LAP RESET".



► Appuyer sur le bouton "OK" pendant moins de trois secondes; la valeur du temps sur le tour le plus rapide commence à clignoter.





► Appuyer alors sur le bouton “OK” pendant plus de trois secondes pour effacer la valeur. Par contre, en appuyant sur le bouton “SET” pendant moins de trois secondes, la procédure d’effacement s’interrompt.

► Au terme de l’effacement des données, l’écran affiche “LAP TIME ERASED”, puis retourne à la modalité “LAPS VIEW”.

► *Effacement de tous les temps mémorisés:* Accéder à la modalité “LAPS VIEW” et appuyer sur le bouton “SET” pendant moins de trois secondes jusqu’à l’affichage du message “ALL LAPS RESET”.





► Appuyer sur le bouton "OK" pendant moins de trois secondes; le display demande de confirmer l'effacement de toutes les données présentes en mémoire.

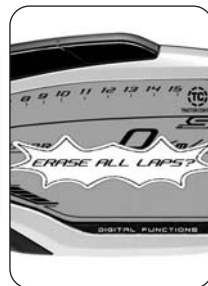

► En appuyant sur le bouton "OK" pendant plus de trois secondes, tous les temps saisis précédemment sont effacés. Si, en revanche, on appuie sur le bouton "SET" pendant moins de trois secondes la procédure d'effacement est interrompue.

► Au terme de l'effacement des données, l'écran affiche "ALL LAPS ERASED", puis retourne à la modalité "LAPS VIEW".





4.4.5. Modalité "NIGHT/DAY"

► Pour convertir la couleur de fond de l'afficheur, accéder à la modalité "NIGHT/DAY MODE" et appuyer sur le bouton "OK" pendant moins de trois secondes.



ATTENTION

Les opérations de modification ou de réglage des fonctions de l'écran doivent être effectuées avec le moteur coupé, le levier de vitesse au point mort, le véhicule arrêté et les pieds à terre. Il est interdit de changer les configurations de l'écran pendant la marche.

► Une pression sur le bouton "SET" permet de passer de façon cyclique de l'affichage de jour à l'affichage nocturne de l'afficheur.

► Une fois qu'on a défini la couleur de fond de l'afficheur, une pression sur le bouton "OK" pendant plus de trois secondes permet de confirmer l'affichage choisi et de revenir à la modalité "NIGHT/DAY MODE". Le fond ainsi défini sera maintenu dans toutes les modalités d'utilisation successives du tableau de bord.

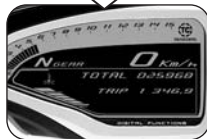
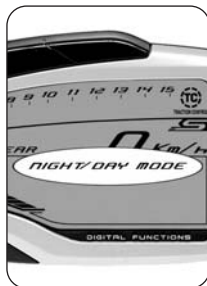



4.4.6. Réglage électronique des suspensions

► Afin d'effectuer le réglage personnalisé de la configuration des suspensions, appuyer sur le bouton "SET" pour accéder à la modalité "SETTING ÖHLINS".



ATTENTION: Les opérations de modification ou de réglage des fonctions de l'écran doivent être effectuées avec le moteur coupé, le levier de vitesse au point mort, le véhicule arrêté et les pieds à terre. Il est interdit de changer les configurations de l'écran pendant la marche.

NOTE: Le réglage des suspensions n'est autorisée que si le mappage "C" de l'unité de commande est sélectionné (voir §4.4.10.).

NOTE: Voir le tableau annexe pour obtenir les valeurs conseillées du réglage des suspensions.

□ Freinage en compression (suspension avant)

► En appuyant sur "OK" pour moins de trois secondes, l'écran affiche les paramètres disponibles pour le réglage des suspensions.

► Après quelques secondes, "FRONT" et "C" commencent à clignoter; il est maintenant possible de modifier la valeur du freinage en compression de la suspension avant.





► En appuyant sur le bouton “OK” pendant moins de trois secondes, le niveau du freinage en compression augmente et passe à la valeur suivante. Cette valeur peut varier entre **1** et **26**.

► Appuyer sur le bouton “OK” pendant plus de trois secondes; la valeur choisie du freinage en compression est confirmée. Par contre, en appuyant sur le bouton “SET” pendant moins de trois secondes, la procédure de réglage s’interrompt, les paramètres sont enregistrés et l’affichage revient au menu principal.

□ Freinage en détente (suspension avant)

► Après quelques secondes, “FRONT” et “R” commencent à clignoter; il est maintenant possible de modifier la valeur du freinage en détente de la suspension avant.

► En appuyant sur le bouton “OK” pendant moins de trois secondes, le niveau du freinage en détente augmente et passe à la valeur suivante. Cette valeur peut varier entre **1** et **26**.

► Appuyer sur le bouton “OK” pendant plus de trois secondes; la valeur choisie du freinage en détente est confirmée.



4 FR

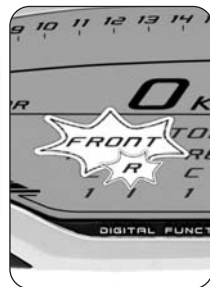



❑ Freinage en compression (suspension arrière)

- ▶ Après quelques secondes, “REAR” et “C” commencent à clignoter; il est maintenant possible de modifier la valeur du freinage en compression de la suspension arrière.
- ▶ En appuyant sur le bouton “OK” pendant moins de trois secondes, le niveau du freinage en compression augmente et passe à la valeur suivante. Cette valeur peut varier entre **1** et **26**.
- ▶ Appuyer sur le bouton “OK” pendant plus de trois secondes; la valeur choisie du freinage en compression est confirmée.



❑ Freinage en détente (suspension arrière)

- ▶ Après quelques secondes, “REAR” et “R” commencent à clignoter; il est maintenant possible de modifier la valeur du freinage en détente de la suspension arrière.
- ▶ En appuyant sur le bouton “OK” pendant moins de trois secondes, le niveau du freinage en détente augmente et passe à la valeur suivante. Cette valeur peut varier entre **1** et **26**.
- ▶ Appuyer sur le bouton “OK” pendant plus de trois secondes; la valeur choisie du freinage en détente est confirmée.





□ Amortisseur de direction

► Après quelques secondes, l'écran affiche les modalités disponibles pour le réglage de l'amortisseur de direction ("AUTO": automatique; "MANUAL": personnalisé).

► En appuyant sur le bouton "OK" pendant moins de trois secondes, la légende "AUTO" commence à clignoter.

► En appuyant sur le bouton "SET" pendant moins de trois secondes, la légende "MANUAL" commence à clignoter. En appuyant sur le bouton "OK" pendant plus de trois secondes, il est possible de modifier le niveau du freinage de l'amortisseur de direction.

► En appuyant sur le bouton "OK" pendant moins de trois secondes, le niveau du freinage de l'amortisseur de direction augmente et passe à la valeur suivante. Cette valeur peut varier entre 1 et 14.

► Appuyer sur le bouton "OK" pendant plus de trois secondes; la valeur choisie du freinage de l'amortisseur de direction est confirmée et l'écran revient à la modalité du réglage des suspensions. Par contre, en appuyant sur le bouton "SET" pendant moins de trois secondes, la procédure de réglage s'interrompt et tous les valeurs sélectionnées du réglage des suspensions sont confirmées.

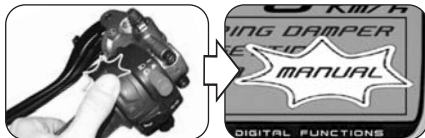
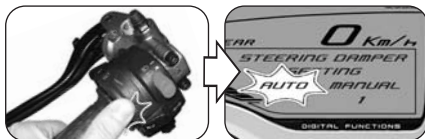



4.4.7. Sélection des fonctions ABS *

► Appuyer sur le bouton “SET” afin d’accéder à la modalité “ABS”; “SETTING ABS” apparaît sur l’écran.



ATTENTION

Les opérations de modification ou de réglage des fonctions de l’écran doivent être effectuées avec le moteur coupé, le levier de vitesse au point mort, le véhicule arrêté et les pieds à terre. Il est interdit de changer les configurations de l’écran pendant la marche.

► En appuyant sur le bouton “OK” pendant moins de trois secondes, l’écran affiche la dernière sélection mémorisée. Dans la condition standard, “ABS NORMAL” (*fonction ABS pour utilisation sur route*) commence à clignoter sur l’écran.

► Si vous n’appuyez sur aucune bouton, après trois secondes la sélection “ABS NORMAL” est confirmée; dans cette condition, la fonction ABS pour utilisation sur route est activé. Appuyer sur le bouton “SET” pour quitter le mode “ABS”.

(*): Fonction présente uniquement sur certains modèles





► Par contre, en appuyant sur le bouton "OK" alors que la légende continue de clignoter, "ABS RACE" (fonction ABS pour utilisation sur piste) apparaît sur l'écran.

ATTENTION: La fonction "ABS RACE" a été expressément étudié pour une utilisation sur piste de course. MV Agusta recommande de ne pas utiliser cette fonction lorsque vous roulez sur les routes publiques.

► Si vous n'appuyez sur aucune bouton, après trois secondes la sélection "ABS RACE" est confirmée. Par contre, en appuyant sur le bouton "OK" alors que la légende continue de clignoter, "ABS OFF" apparaît sur l'écran.

► Si vous n'appuyez sur aucune bouton, après trois secondes la sélection "ABS OFF" est confirmée; dans cette condition, le système ABS est désactivé.

ATTENTION: Si le système ABS est désactivé, le voyant correspondante sur le tableau de bord s'allume (voir § 3.7.1.). A partir de ce moment, le système antiblocage des freins n'est pas disponible lors du freinage. Adopter un style de conduite prudente et rouler à vitesse réduite, afin d'éviter de perdre le contrôle du véhicule pendant le freinage d'urgence.

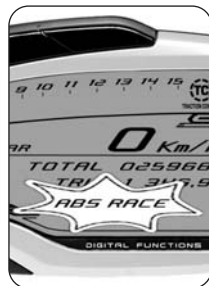



4.4.8. Modalité “QUICK SHIFT”

► Appuyer sur le bouton “SET” afin d’accéder à la modalité “QUICK SHIFT”. L’écran affiche l’état d’activation actuelle de la fonction de changement rapide de vitesse.



ATTENTION

Les opérations de modification ou de réglage des fonctions de l’écran doivent être effectuées avec le moteur coupé, le levier de vitesse au point mort, le véhicule arrêté et les pieds à terre. Il est interdit de changer les configurations de l’écran pendant la marche.

► Appuyer sur le bouton “OK” pendant moins de trois secondes; la légende d’activation de la fonction de changement rapide commence à clignoter.

► En appuyant sur le bouton “OK” pour moins de trois secondes, la légende permet de basculer de “OFF” sur “ON” et inversement.

► Après quelques secondes, l’état d’activation sélectionné de la fonction “quick shift” est automatiquement confirmée.





4.4.9. Modalité “IMMOBILIZER”

La fonction “IMMOBILIZER” ne permet le démarrage du moteur qu’après avoir reconnu la clé de démarrage originale. De fait, celle-ci représente un système antivol intégré dans le circuit électronique du véhicule, car elle empêche l’utilisation de ce dernier par toute autre personne.

La modalité “IMMOBILIZER” du tableau de bord ne doit être utilisée qu’en cas de mal fonctionnement. En effet, si pour une raison quelconque la clé originale n’est pas reconnue par le système, afin d’obtenir l’accord au démarrage du moteur il est nécessaire d’insérer le code secret reporté sur la MV Code Card reçue au moment de la livraison du véhicule.

- ▶ Enlever le cache à l’arrière de la MV Code Card et lire le code secret électronique correspondant à la clé de démarrage (sur la figure est représenté un code au hasard, à titre indicatif).
- ▶ Accéder à la modalité “RUN” et appuyer sur les boutons “SET” et “OK” pendant plus de trois secondes afin d’afficher “IMMOBILIZER”.

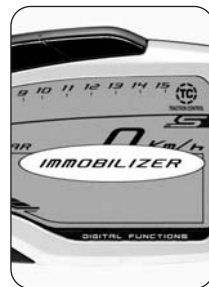

**ATTENTION**

Les opérations de modification ou de réglage des fonctions de l'écran doivent être effectuées avec le moteur coupé, le levier de vitesse au point mort, le véhicule arrêté et les pieds à terre. Il est interdit de changer les configurations de l'écran pendant la marche.

- ▶ Appuyer sur le bouton "OK" pendant moins de trois secondes pour insérer le premier chiffre du code.
- ▶ La pression du bouton "OK" pendant moins de trois secondes permet de varier entre **0** et **9** la valeur relative au premier chiffre.
- ▶ Une fois sélectionné le chiffre voulu, appuyer sur le bouton "OK" pendant plus de trois secondes; le premier chiffre du code est confirmé. Il est alors possible d'insérer le deuxième chiffre du code.
- ▶ En procédant de manière analogue, il est possible de procéder à l'insertion des quatre chiffres restants.

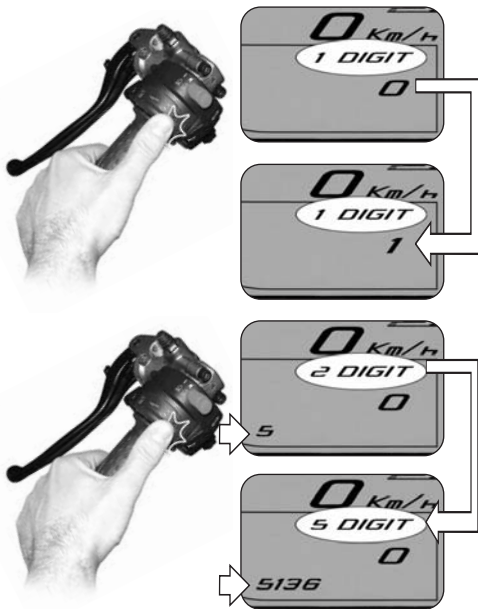



► Une fois complétée la procédure d'insertion du code, sur l'écran apparaît l'inscription "CONFIRM CODE". Appuyer sur le bouton "OK" pendant plus de trois secondes pour confirmer le code inséré.

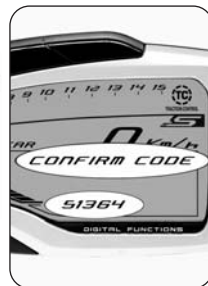

► Si le code inséré est correctement reconnu par le système, l'inscription "VALID CODE" s'affiche. L'écran du tableau de bord retourne en modalité "RUN". Il est possible de démarrer le moteur.

► Si le code inséré est incorrect, l'inscription "NOT VALID CODE" s'affiche. Le système ne donne pas l'accord au démarrage du moteur; l'écran retourne en modalité "IMMOBILIZER". Répéter la procédure d'insertion du code depuis le début, en faisant attention à bien insérer correctement les chiffres reportés sur la MV Code Card fournie. En cas de problèmes, contacter un centre d'assistance autorisé MV Agusta.

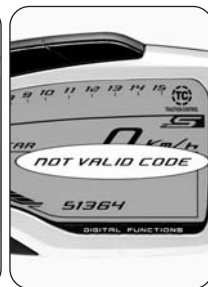
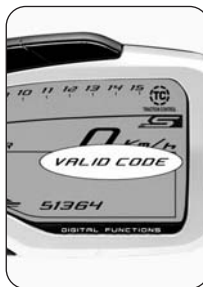



4.4.10. Sélection représentation de la centrale

Sur le modèle F4 RR, il est possible de sélectionner différents mappages de la centrale ce qui permet d'obtenir des caractéristiques variables de puissance et de performances selon le type d'utilisation du véhicule.

NOTE

Les opérations de sélection de la représentation de la centrale peuvent être effectuées même pendant l'utilisation du véhicule.

La sélection du mappage de la centrale peut être effectuée en appuyant sur le bouton de démarrage lorsque le moteur est allumé. De cette manière le mappage passe à la valeur de réglage suivant. Les caractéristiques correspondantes au mappage sont indiquées dans le tableau suivant.

Mappage	N	R	S	C
Mode	Normal	Pluie	Sportif	Personnalisé

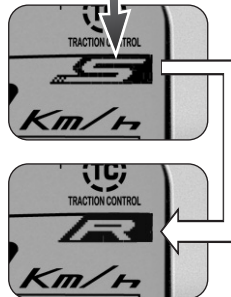



❑ Réglage du mappage personnalisé

▶ Appuyer sur le bouton de démarrage lorsque le moteur est allumé, jusqu'à sélectionner le mappage "C" de l'unité de commande (mappage personnalisé).



ATTENTION: Les opérations de réglage du mappage personnalisé doivent être effectuées avec le levier de vitesse au point mort, le véhicule arrêté et les pieds à terre. Il est interdit de changer les configurations de l'écran pendant la marche.

▶ Appuyez sur "SET" jusqu'à ce que "SETTING C MAP" est affiché.

Afin d'ajuster les paramètres du mappage personnalisé pour vos besoins de conduite, effectuer les opérations suivantes.

▶ *Sensibilité du commande d'accélérateur:* Appuyer sur le bouton "OK" pendant moins de trois secondes afin d'afficher "GAS SENSITIVITY".

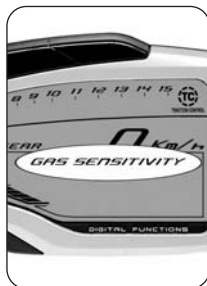



► Appuyer sur le bouton “SET” pendant moins de trois secondes. L'écran affiche le réglage actuel de la sensibilité du commande d'accélérateur.



► Appuyer sur le bouton “OK” pendant moins de trois secondes; le paramètre affiché commence à clignoter.

► Une pression répétée sur le bouton “OK” pendant moins de trois secondes permet d'afficher l'un après l'autre les paramètres suivants:

- “NORMAL” (Normal)
- “RAIN” (Pluie)
- “SPORT” (Sportif)

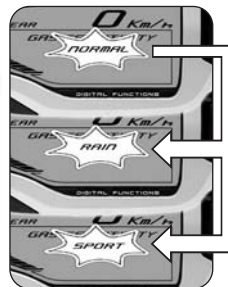



► Appuyer sur le bouton “OK” pendant plus de trois secondes; le nouveau réglage sera confirmée. La paramètre affiché cesse de clignoter et après quelques secondes l'affichage revient à le mode “GAS SENSITIVITY”. Il est possible de procéder à le réglage du paramètre suivant.



► *Couple maximal du moteur:* Appuyer sur le bouton “OK” pendant moins de trois secondes afin d’afficher “MAX ENGINE TORQUE”.

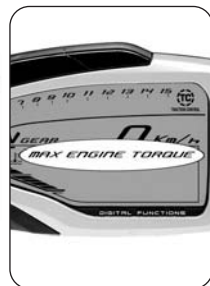



► Appuyer sur le bouton “SET” pendant moins de trois secondes. L'écran affiche le réglage actuel de la couple maximal du moteur.

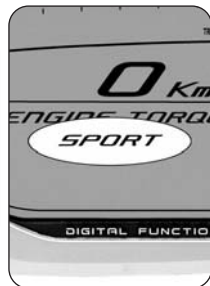

► Appuyer sur le bouton “OK” pendant moins de trois secondes; le paramètre affiché commence à clignoter.

► Une pression répétée sur le bouton “OK” pendant moins de trois secondes permet d'afficher l'un après l'autre les paramètres suivants:

- “SPORT” (Sportif)
- “RAIN” (Pluie)





► Appuyer sur le bouton “OK” pendant plus de trois secondes; le nouveau réglage sera confirmée. La paramètre affiché cesse de clignoter et après quelques secondes l'affichage revient à le mode “MAX ENGINE TORQUE”.

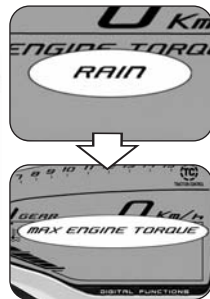

► *Frein moteur:* Appuyer sur le bouton “OK” pendant moins de trois secondes afin d’afficher “ENGINE BRAKE”.





► Appuyer sur le bouton "SET" pendant moins de trois secondes. L'écran affiche le réglage actuel du frein moteur.



► Appuyer sur le bouton "OK" pendant moins de trois secondes; le paramètre affiché commence à clignoter.

► Une pression répétée sur le bouton "OK" pendant moins de trois secondes permet d'afficher l'un après l'autre les paramètres suivants:

- "NORMAL" (Normal)
- "SPORT" (Sportif)

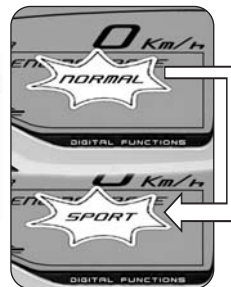



► Appuyer sur le bouton “OK” pendant plus de trois secondes; le nouveau réglage sera confirmée. La paramètre affiché cesse de clignoter et après quelques secondes l'affichage revient à le mode “ENGINE BRAKE”.



► *Réponse du moteur:* Appuyer sur le bouton “OK” pendant moins de trois secondes afin d’afficher “ENGINE RESPONSE”.

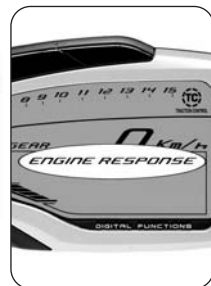



► Appuyer sur le bouton “SET” pendant moins de trois secondes. L'écran affiche le réglage actuel de la réponse du moteur.



► Appuyer sur le bouton “OK” pendant moins de trois secondes; le paramètre affiché commence à clignoter.

► Une pression répétée sur le bouton “OK” pendant moins de trois secondes permet d'afficher l'un après l'autre les paramètres suivants:

- “SLOW RESPONSE” (Réponse lente)
- “FAST RESPONSE” (Réponse rapide)





► Appuyer sur le bouton “OK” pendant plus de trois secondes; le nouveau réglage sera confirmée. La paramètre affiché cesse de clignoter et après quelques secondes l'affichage revient à le mode “ENGINE RESPONSE”.



► *Limiteur de la vitesse de rotation du moteur:* Appuyer sur le bouton “OK” pendant moins de trois secondes afin d'afficher “RPM LIMITER”.





► Appuyer sur le bouton “SET” pendant moins de trois secondes. L'écran affiche le réglage actuel du limiteur de la vitesse de rotation du moteur.



► Appuyer sur le bouton “OK” pendant moins de trois secondes; le paramètre affiché commence à clignoter.

► Une pression répétée sur le bouton “OK” pendant moins de trois secondes permet d'afficher l'un après l'autre les paramètres suivants:

- “NORMAL” (Normal)
- “SPORT” (Sportif)





► Appuyer sur le bouton "OK" pendant plus de trois secondes; le nouveau réglage sera confirmée. La paramètre affiché cesse de clignoter et après quelques secondes l'affichage revient à le mode "RPM LIMITER".

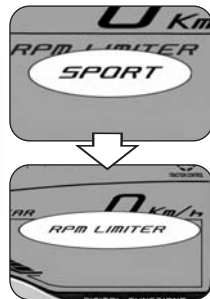

► Appuyer sur le bouton "OK" pendant moins de trois secondes jusqu'à ce que l'affichage passe au mode "RUN". Le réglage du mappage personnalisé est terminée.





4.4.11. Messages d'avertissement/pannes

Le tableau de bord peut signaler la présence d'une faute ou un dysfonctionnement au cours des différentes conditions d'utilisation de la moto.

► *Démarrage du moteur:* En tournant l'interrupteur de démarrage en position "ON"; l'instrumentation et les voyants exécutent le test de fonctionnement. Si le test de fonctionnement détecte un défaut sur le véhicule, l'écran affiche le message d'avertissement figurant dans l'image. En particulier, l'affichage montre le dispositif de la moto sur laquelle le défaut a été détectée.

► Appuyer sur le bouton "OK" afin d'afficher la fonction "RUN".



ATTENTION

Si un défaut a été détectée a moteur coupé, ne pas démarrer le moteur et contacter un centre d'assistance autorisé MV Agusta.





► *Marche du véhicule*: Si une anomalie est détectée pendant l'utilisation du véhicule, la partie inférieure de l'écran affiche le message d'avertissement figurant dans l'image.

**ATTENTION**

Si un défaut a été détectée pendant la marche, arrêter le véhicule et contacter un centre d'assistance autorisé MV Agusta.

► Après l'arrêt du véhicule, l'affichage montre le dispositif de la moto sur laquelle le défaut a été détectée.





► *Température élevée du liquide de refroidissement:*
Si une température élevée du fluide de refroidissement est détectée, l'écran affiche le message d'avertissement figurant dans l'image. Ce message peut apparaître lors de toutes les conditions d'utilisation du véhicule.

**ATTENTION**

En cas de température élevée, arrêter le véhicule et contrôler le niveau du liquide de refroidissement. Au cas où il serait nécessaire de remplir le réservoir, s'adresser à un centre d'assistance autorisé MV Agusta (voir § 3.8). Si l'indication apparaît et que le niveau est correct, ne pas redémarrer et contacter un centre d'assistance autorisé MV Agusta.





4.5. Approvisionnement en carburant



Danger - Attention: l'essence et ses vapeurs sont extrêmement inflammables et nocifs. Eviter le contact et l'inhalation. Pendant l'approvisionnement, couper le moteur, ne pas fumer, tenir à distance les flammes, étincelles et sources de chaleur. Effectuer l'approvisionnement à l'air libre ou dans un local suffisamment aéré.



Rappel - Précaution: utiliser exclusivement de l'essence super sans plomb et sans alcool avec un indice d'octane (R.O.N.) de 95 ou plus. Cette nécessité est rappelé par une pastille verte sur le côté inférieur du bouchon du réservoir et par l'étiquette sur le réservoir de carburant.

- ▶ Soulever le cache poussière.
- ▶ Introduire la clé, tourner dans le sens des aiguilles d'une montre et soulever le couvercle.
- ▶ Une fois l'approvisionnement effectué, pousser le bouchon vers le bas en tournant simultanément la clé dans le sens des aiguilles d'une montre pour faciliter la fermeture, puis relâcher la clé et l'extraire.



**ATTENTION**

Un remplissage excessif du réservoir peut faire déborder le carburant à cause de l'expansion due à la chaleur du moteur ou à l'exposition de la moto à la lumière du soleil. Les écoulements éventuels de carburant peuvent provoquer des incendies. Le niveau de carburant dans le réservoir ne doit jamais dépasser la base de l'embout de remplissage.



Rappel - Précaution: sécher immédiatement avec un chiffon propre le carburant éventuellement renversé, car il peut détériorer les peintures ou les plastiques.

**ATTENTION**

Vérifier que le bouchon du réservoir à carburant est fermé correctement avant d'utiliser le véhicule.





4.6. Accès à la boîte à gants

- ▶ Introduire la clé.
- ▶ Appuyer sur la partie terminale de la selle du passager et tourner simultanément la clé en sens horaire.
- ▶ Soulever la selle du passager par l'extrémité arrière, la faire coulisser vers l'avant et l'extraire.

Pour remonter l'élément, procéder de la façon suivante:

- Tourner la clé dans la serrure;
- Presser la selle passager;
- Relâcher la clé;
- Presser à nouveau la selle en s'assurant qu'elle est fermement accrochée à la structure.



ATTENTION

Après avoir enlevé ou soulevé la selle passager et en tout cas avant d'utiliser la moto, s'assurer que l'élément a été placé correctement et qu'il est fermement assujéti à la structure portante du véhicule.



4.7. Stationnement de la moto

❑ Stationnement avec béquille latérale



RAPPEL

- **Garer la moto en conditions de sécurité et sur un terrain stable.**
- **Pour le stationnement en côte, garer la moto avec la roue avant en amont et la première vitesse engagée. Ne pas oublier de remettre le sélecteur de vitesses au point mort avant de redémarrer la moto.**
- **Ne pas laisser le véhicule sans surveillance avec la clé sur le contact.**

► Abaisser la béquille avec le pied jusqu'à la butée et incliner lentement la moto pour mettre le pied d'appui au contact du sol.

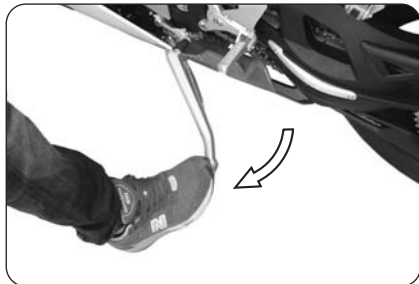

**ATTENTION**

Lorsque le véhicule stationne sur la béquille latérale, il est dangereux de s'asseoir dessus et de peser avec tout le poids du corps sur l'unique appui de stationnement.

**ATTENTION**

Avant de se mettre en route, vérifier le fonctionnement de l'interrupteur de sûreté en s'assurant que le voyant d'ouverture de la béquille latérale sur le tableau de bord s'éteint. Dans tous les cas, vérifier que la béquille est bien rentrée. En cas de fonctionnement défectueux, faire contrôler le dispositif par un concessionnaire MV Agusta avant d'utiliser la moto.

□ Stationnement avec la béquille arrière

Introduire l'axe de béquille dans l'orifice de l'axe de roue arrière du côté gauche de la moto. Appuyer la béquille au sol et en forçant dessus, soulever le véhicule jusqu'à ce qu'il se stabilise.

**RAPPEL**

Cette opération doit être effectuée par deux personnes.





5.1. Liste des réglages

La moto dispose d'une grande diversité de réglages qui peuvent améliorer l'ergonomie, l'assiette et la sécurité.

Toutefois, étant donné qu'un réglage incorrect de pièces particulièrement importantes peut engendrer une situation de danger, quelques-uns des réglages sont réservés aux Centres d'Assistance MV Agusta.



ATTENTION

Tous les réglages s'effectuent à l'arrêt.





(F) Réglage du rétroviseur (§5.5.)

(A) Réglage du levier d'embrayage (§5.4.)

(F) Réglage du rétroviseur (§5.5.)

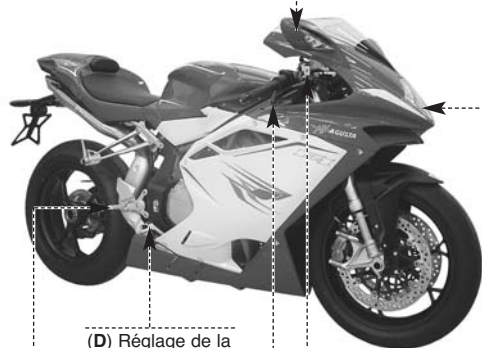

(D) Réglage de la
pédale de frein
arrière (§5.2.)

(C) Réglage du cale-pied
droit (§5.2.)

(B) Réglage du levier de frein avant (§5.3.)

(H) Réglage de la suspension
avant (§5.3. et §4.4.6.)

(G) Réglage de l'amortisseur de direction (§4.4.6.)

(D) Réglage du sélecteur de vitesses (§5.2.)

(L) Réglage de la suspension
arrière (§4.4.6.)

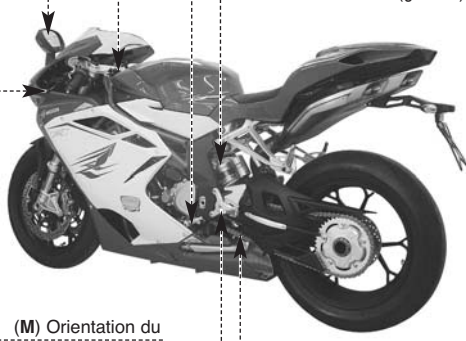

(M) Orientation du
phare (§5.7.)

(L) Réglage de la
chaîne (§5.2.)

(C) Réglage du cale-pied
gauche (§5.2.)





5.2. Tableau des réglages



A - Réglage du levier d'embrayage: pour améliorer la prise en fonction des nécessités du pilote (§5.4).



B - Réglage du levier de frein avant: pour améliorer la prise en fonction des nécessités du pilote (§5.3).



C - Réglage du cale-pied (droit et gauche): pour améliorer la position des pieds en fonction des nécessités du pilote.



D - Réglage du sélecteur de vitesses: pour améliorer le mouvement de commande en fonction des nécessités du pilote.



E - Réglage de la pédale de frein arrière: pour améliorer le mouvement de commande en fonction des nécessités du pilote.



F - Réglage des rétroviseurs: pour améliorer l'orientation (§5.5).



G - Réglage de l'amortisseur de direction: pour adapter la dureté de la direction aux préférences du pilote (§4.4.6.).



H - Réglage de la suspension avant: pour adapter la réponse aux préférences du motard, on peut régler:

- la précharge du ressort (§5.6.1.)
- le dispositif hydraulique de freinage en détente (§4.4.6.)
- le dispositif hydraulique de freinage en compression (§4.4.6.)



L - Réglage de la suspension arrière: pour adapter la réponse aux préférences du motard, on peut régler:

- la hauteur d'assiette
- la précharge du ressort
- le dispositif hydraulique de freinage en détente (§4.4.6.)
- le dispositif hydraulique de freinage en compression (§4.4.6.)



M - Tension de la chaîne: pour l'efficacité et la fiabilité de la transmission.



N - Orientation du phare: pour optimiser la profondeur du faisceau lumineux en fonction de l'assiette (§5.7.).





5.3. Réglage du levier de frein avant

Visser ou dévisser l'écrou pour régler la position du levier. En vissant: le levier s'éloigne de la poignée. En dévissant: le levier se rapproche de la poignée.

5.4. Réglage du levier d'embrayage

Visser ou dévisser l'écrou pour régler la position du levier. En vissant: le levier s'éloigne de la poignée. En dévissant: le levier se rapproche de la poignée.

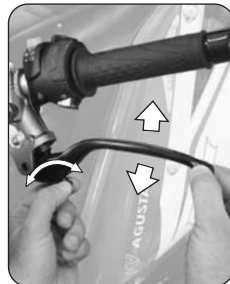

5.5. Réglage des rétroviseurs

Pousser sur les points indiqués pour orienter le rétroviseur dans les quatre directions.

Régler les deux rétroviseurs. Pour une mise au point optimale, monter sur le véhicule pour réaliser le réglage.

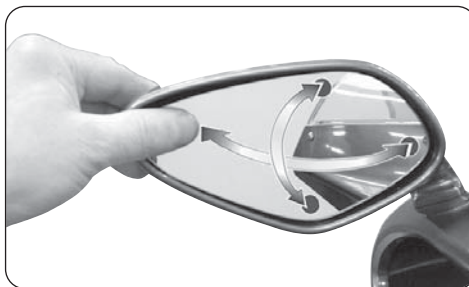



5.6. Réglage de la suspension avant

NOTE

L'ajustement des suspensions doit être de préférence effectué avec le réservoir de carburant plein.

NOTE

Pour le réglage du freinage en compression et en détente, voir les procédures décrites au § 4.4.6.

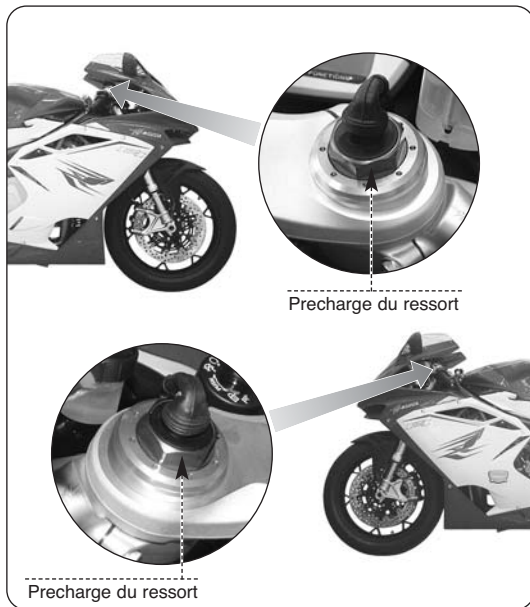



5.6.1. Précharge du ressort (suspension avant)

► Pour accéder à l'écrou de réglage de la précharge de ressort, soulever la gaine de protection et retirer le connecteur à l'aide d'un tournevis à tête plate.



► Le réglage s'effectue en partant de la position standard. Pour trouver cette position, il faut dévisser à fond, puis visser jusqu'à la position standard (voir tableau annexe).
Visser pour augmenter la précharge du ressort ou dévisser pour la diminuer.

► Lorsque les opérations d'ajustement ont été réalisées, rebrancher le connecteur et repositionner la gaine de protection.





5.7. Réglage du projecteur avant

Placer le véhicule à 10 mètres d'une paroi verticale.

Veiller à ce que le terrain soit plat et l'axe du véhicule perpendiculaire à la paroi.

Le véhicule doit se trouver en position verticale. Mesurer la hauteur du centre du projecteur au sol et faire une croix sur la paroi à la même hauteur.

Allumer le code, la limite supérieure de démarcation entre la zone sombre et la zone éclairée ne doit pas dépasser $9/10$ de la hauteur au sol du centre du projecteur.

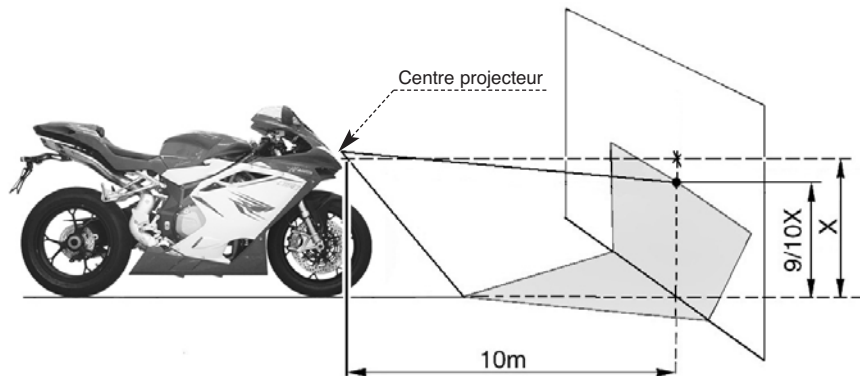



Le réglage vertical du faisceau lumineux peut être effectué en agissant sur la vis représentée sur le côté. En sens horaire : le groupe optique s'incline vers le haut. En sens inverse horaire : le groupe optique s'incline vers le bas. L'inclinaison peut être modifiée de $\pm 4^\circ$ par rapport à la position standard.

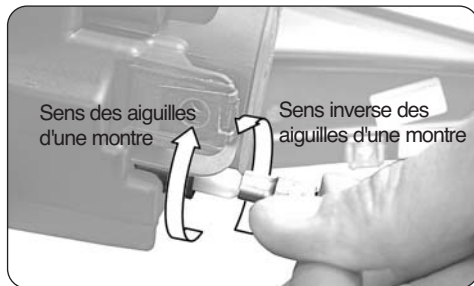



Note d'information

MV Agusta S.p.A. poursuit une politique de continuelle amélioration de ses produits. Pour cette raison, de légères différences pourraient éventuellement se présenter entre les informations de ce livret et le véhicule que vous avez acheté. Les modèles MV Agusta s'exportent dans de nombreux pays où des normes différentes sont en vigueur en ce qui concerne le Code de la Route et les procédures d'homologation. En espérant pouvoir compter sur votre compréhension, il est indispensable à MV Agusta S.p.A. de se réserver le droit d'apporter des modifications à ses produits et à la documentation technique à tout moment sans fournir de préavis.

Nous suggérons de visiter souvent le site Internet www.mvagusta.it afin d'obtenir des informations et des mises à jour sur les produits MV Agusta et la documentation relative.



Respectons et défendons l'environnement

Toutes nos actions ont des répercussions sur la planète entière et sur ses ressources. MV Agusta, au profit des intérêts de tous, sensibilise les Clients et les opérateurs du service après-vente pour leur faire adopter des modalités d'utilisation du véhicule et de traitement de ses parties dans le respect des normes en vigueur en terme de pollution, traitement et recyclage des déchets.

© 2012

Toute reproduction même partielle de ce document est formellement interdite sans autorisation écrite de MV Agusta S.p.A.

Dét. n° 8000B7637

Edition n° 1 - Novembre 2012



MV AGUSTA



Bedienungsanleitung
Deutsche Version



Sehr geehrter Kunde,

wir danken Ihnen für das Vertrauen, dass Sie uns ausgesprochen haben und gratulieren Ihnen zur Wahl Ihres neuen F4 RR.

Ihre Wahl prämiert den Einsatz unserer Techniker, die dem F4 RR funktionelle und ästhetische Merkmale gegeben haben, die dieses Fahrzeug über die besten heute verfügbaren Motorräder stellt. Damit wird es zu einem begehrten und exklusiven Fahrzeug.

Auf rein technischer Ebene repräsentiert der F4 RR mit seinen zahlreichen Innovationen einen weltweiten Bezugs- und Vergleichspunkt. Seine zeitlose, weiche und runde Linie ist ein gelungenes Zusammenspiel aus einer glanzvollen Vergangenheit und einem neuen Jahrtausend.

Die Verbindung dieser Elemente, die nur durch die Suche nach Detaillösungen, Arbeit mit Leidenschaft und dem Wunsch ein technisch und ästhetisch überlegenes Fahrzeug herzustellen, zustande kommen konnte, hebt dieses Fahrzeug aus vorübergehenden Modeerscheinungen heraus und verleiht ihm das Privileg als ein weltweit einzigartiges Objekt angesehen zu werden.

Falls Sie weitere Informationen wünschen, wenden Sie sich bitte an den Kundendienst der MV Agusta.

Viel Spaß!

*Giovanni Castiglioni
Präsident
MV Agusta*



ALLGEMEINES INHALTSVERZEICHNIS

<i>Kap.</i>	<i>Inhalt</i>	<i>Seite</i>
1	ALLGEMEINE INFORMATIONEN	5
1.1.	Zweck der Bedienungsanleitung	5
1.2.	Zeichenerklärung	6
1.3.	Inhalt der Speichermedium	7
1.4.	Rahmen- und Motornummer	8
2	SICHERHEITSINFORMATIONEN	11
2.1.	Sachgemäßer Gebrauch des Fahrzeuges	11
2.2.	Wartung	11
2.3.	Zubehör und Änderungen	12
2.4.	Fahrzeugbeladung	12
3	BEDIENUNGSELEMENTE UND INSTRUMENTE	14
3.1.	Anbringung der Bedienelemente und Instrumente	14
3.2.	Seitlicher Ständer	15
3.3.	Bedienelemente links am Lenker	16
3.4.	Bedienelemente rechts am Lenker	18
3.5.	Zündschloß und Lenkerschloß	21
3.6.	Schaltung	24
3.7.	Instrumente und Kontrolllampen	25
3.7.1.	Kontrolllampen	26
3.7.2.	Multifunktions-Display	27
3.8.	Schmiermitteltabelle	28

<i>Kap.</i>	<i>Inhalt</i>	<i>Seite</i>
4	EINSATZ	29
4.1.	Einsatz des Motorrads	29
4.2.	Einfahren	30
4.3.	Starten des Motors	32
4.4.	Auswahl und Modifizieren der Display-Funktionen	35
4.4.1.	Auswahl der Display-Funktionen	36
4.4.2.	Nullstellen der Funktionen des Teilstrecken-Kilometerzählers	41
4.4.3.	Betriebsmodus "TC"	43
4.4.4.	Chronometer	44
4.4.5.	Betriebsmodus "NIGHT/DAY"	53
4.4.6.	Elektronische Fahrwerkseinstellung	54
4.4.7.	Auswahl der ABS-Funktion	58
4.4.8.	Betriebsmodus "QUICK SHIFT"	60
4.4.9.	Betriebsmodus "IMMOBILIZER"	61
4.4.10.	Auswahl Mapping Motorsteuerung	64
4.4.11.	Warnung / Störmeldung	76
4.5.	Tanken	79
4.6.	Zugang zum Staufach	81
4.7.	Parken des Motorrads	82



ALLGEMEINES INHALTSVERZEICHNIS

<i>Kap.</i>	<i>Inhalt</i>	<i>Seite</i>
5	EINSTELLUNGSARBEITEN	84
5.1.	Liste der Einstellungsarbeiten	84
5.2.	Tabelle der Einstellungsarbeiten	86
5.3.	Einstellung Bremshebel Vorderradbremse	87
5.4.	Einstellung Kupplungshebel	87
5.5.	Einstellung Rückspiegel	87
5.6.	Einstellung vordere Federung	88
5.6.1.	Federvorspannung (Vorderradfederung)	89
5.7.	Scheinwerfereinstellung	90



1.1. Zweck der Bedienungsanleitung

Dieses Handbuch enthält alle für einen korrekten und sicheren Gebrauch Ihres Motorrads erforderlichen Informationen.

Zusammen mit dem Handbuch erhalten Sie auch ein Quick Manual im Taschenformat mit den wichtigsten gebrauchrelevanten Informationen.

Das Handbuch wird in elektronischem Format (.pdf) auf dieser Speichermedium geliefert und kann auf jedem PC mit Windows oder Mac eingesehen oder ausgedruckt werden.

Wir bitten Sie, dieses Handbuch vor der ersten Benutzung des Motorrads aufmerksam durchzulesen und sich immer zu vergewissern, dass auch andere Personen, die das Motorrad benutzen, dies tun.

Vergessen Sie bitte nicht, in das Quick Manual Ihre Daten und die Daten Ihres Motorrads einzutragen und es immer mitzuführen.



Copyright
MV AGUSTA Motor Spa
Alle Rechte vorbehalten





1.2. Zeichenerklärung

Besonders wichtige Textstellen die sich auf die Sicherheit der Personen oder des Fahrzeugs beziehen, sind mit folgenden Symbolen gekennzeichnet:



Gefahr - Achtung: Die mangelnde oder unvollständige Beachtung dieser Vorschriften stellt eine schwere Unfallgefahr für den Arbeiter oder Dritte dar.



Vorsicht - Vorsichtsmaßnahme: Die Nichteinhaltung der Anweisungen kann schwere und dauerhafte Schäden am Fahrzeug verursachen.

Folgende Symbole werden benutzt, um anzuzeigen, wer die angegebenen Wartungs- und Einstellarbeiten ausführen darf:



Informationen zu Arbeiten, die vom Motorradfahrer ausgeführt werden dürfen.



Informationen zu arbeiten, die ausschließlich von ausgebildetem Fachpersonal ausgeführt werden dürfen.

Um weitere Informationen hervorzuheben, werden folgende Symbole verwendet:



Das Symbol  zeigt an, dass für die richtige Durchführung der angegebenen Arbeit ein Spezialwerkzeug oder Sonderausrüstung benötigt werden.



Das Zeichen “§” gefolgt von einer Ziffer verweist auf das entsprechende Kapitel.





1.3. Inhalt der Speichermedium

Auf dieser Speichermedium finden Sie außer diesem Handbuch auch das Wartungshandbuch, das Quick Manual (das Sie auch als Büchlein erhalten haben), die Händlerliste und die Garantie-Heft.

Bei der Übergabe des Motorrades hat Ihnen Ihr Händler auch das Garantiebescheinigung ausgehändigt.

Bewahren Sie es bitte sorgfältig zusammen mit den Fahrzeugpapieren und den zukünftigen Bescheinigungen auf, die Sie bei jeder Inspektion ausgehändigt bekommen werden.

WICHTIG

Die Kopien der Garantiebescheinigung sowie der Bescheinigung der vor Auslieferung vorgenommenen Kontrollen müssen vom Vertragshändler ausgefüllt werden. Eine Kopie muss dem Kunden übergeben werden, eine muss vom Vertragshändler aufbewahrt und eine an den Importeur geschickt werden.

Die Kopien der Wartungcoupons müssen immer vom Vertragshändler ausgefüllt werden. Sie müssen vom Kunden und vom Vertragshändler aufbewahrt werden.





2) Motornummer



1) Rahmennummer

3) Zulassungsnummer

1.4. Rahmen- und Motornummer

- 1) Rahmennummer
- 2) Motornummer
- 3) Zulassungsnummer

► Kennzeichnung des Motorrads

Das Motorrad wird durch die Rahmennummer eindeutig gekennzeichnet. Bei Ersatzteilbestellungen müssen die Rahmennummer und gegebenenfalls auch die Motornummer, die Farbkennziffer und die Schlüsselnummer angegeben werden.

Wir empfehlen Ihnen die wichtigsten Angaben nachstehend einzutragen.

RAHMENNUMMER: _____

MOTORNUMMER: _____





► Schlüsselnummer

Sie erhalten einen Schlüssel und einen Ersatzschlüssel. Die Schlüssel dienen als Zündschlüssel und zum Öffnen aller Schlösser. Den Ersatzschlüssel an einem sicheren Ort aufbewahren.

Bei Nachfrage eines Duplikates ist die Kenntnis der Identifikationsnummer des Schlüssels grundlegend. Die Schlüssel-Identifizierungsnummer ist auf der MV Code Card angegeben, die zusammen mit den Zündschlüsseln geliefert wird.

► Farbkennziffer

Die Farbkennziffer wird bei Bestellung von Karosserieteilen benötigt. Sie befindet sich auf dem rechten unteren Seite des Benzintanks.

Um das Farbkennzifferschild zu lesen, ist es notwendig das rechte seitliche Tankteil zu lösen. Ziehen Sie die Rückseite der rechten seitlichen Tankteil aus, wie in der Abbildung gezeigt.



1 DE





DE 1

Entfernen Sie die rechte seitliche Tankteile, indem Sie sie zur Rückseite des Motorrads ziehen.



Nach Tankteilbeseitigung, ist es möglich, das Farbkennzifferschild zu sehen. Auf dem Schild ist die jeweilige Farbekennziffer des Motorrads zur Lackierung der Karosserieteile angegeben.

Es wird geraten, die Farbkennziffer des Motorrads im nachfolgenden Leerraum einzutragen:

FARBKENNZIFFER:





2.1. SACHGEMÄSSER GEBRAUCH DES FAHRZEUGES

Ihr Motorrad wurde ausschließlich für die Benutzung auf Straßen und Autobahnen geplant.



ACHTUNG

Ausnahmeweise können Sie Ihr Motorrad auch auf einer Rennstrecke benutzen – allerdings nicht, um Rennen zu fahren.

Dabei ist das Motorrad jedoch sehr hohen Beanspruchungen ausgesetzt und daher sollte es vorher und nachher in einer MV Agusta-Vertragswerkstatt überprüft werden.

Jeder andere Einsatz ist ausdrücklich ausgeschlossen und strengstens untersagt.

Weitere Informationen zur Benutzung des Motorrades finden Sie im Abschnitt 4 dieses Handbuches.

2.2. WARTUNG

Damit Ihr Motorrad stets einwandfrei und zuverlässig funktioniert, müssen Sie die im Wartungshandbuch vorgesehenen Inspektionstermine unbedingt einhalten.

Sie sollten diese ausschließlich von Fachleuten in einer MV Agusta-Vertragswerkstatt durchführen lassen.

Sollten Sie sich hingegen für eine freie Werkstatt entscheiden, müssen Sie sich von dieser bestätigen lassen, dass sie über alle für die Durchführung der erforderlichen Kontrollen und Einstellungen notwendigen Ausrüstungen, Möglichkeiten und Kenntnisse verfügt.



ACHTUNG

Die Garantie von MV Agusta könnte im Fall von in freien Werkstätten ausgeführten Eingriffen an Ihrem Motorrad, die nicht den technischen Rundschreiben und den MV Agusta-Werkstatthandbüchern entsprechen, verfallen.





2.3. ZUBEHÖR UND ÄNDERUNGEN



ACHTUNG

Der Hersteller untersagt jegliche eigenmächtige Änderung an seinen Fahrzeugen. Nur so kann die Sicherheit der Benutzer gewährleistet werden.

Allerdings besteht die Möglichkeit, Ihr Motorrad anhand des umfangreichen MV Agusta-Zubehörkatalogs zu personalisieren.



ACHTUNG

Durch die Installation einiger dieser Zubehörteile kann die Zulassung des Motorrades jedoch ungültig werden, was bedeutet, dass Sie damit nicht mehr auf öffentlichen Straßen fahren dürfen.

Wenden Sie sich daher im Zweifelsfall an Ihren Vertragshändler MV Agusta, bevor Sie entscheiden, welches Zubehör für Ihre Erfordernisse geeignet ist.

2.4. FAHRZEUGBELADUNG

Das Motorrad wurde zum Einsatz des Fahrers und höchstens eines Beifahrers entworfen. Für einen sicheren Einsatz und unter Berücksichtigung der Straßenverkehrsvorschriften müssen die technisch zulässige Gesamtmasse, die hier unten angegeben ist, nie überschritten werden:

F4 RR:

Technisch zulässige Gesamtmasse:

378 kg

Maximallastmasse:

165 kg

Die technisch zulässige Gesamtmasse ist die Summe der folgenden Massen:

- Motorradmasse;
- Fahrermasse;
- Beifahrermasse;
- Masse des Gepäcks und des Zubehörteiles.



**ACHTUNG**

Da das Gewicht einen enormen Einfluss auf die Lenkbarkeit, die Bremsleistung, die Fahrzeugeigenschaften und die Fahrzeugsicherheit hat, müssen die folgenden Vorschriften stets eingehalten werden.

- **DAS MOTORRAD NIE ÜBERLADEN!**
Ein überladenes Motorrad kann die Reifen beschädigen, zu einem Kontrollverlust und schweren Unfällen führen. Überprüfen, dass das Gesamtgewicht mit Fahrer, Beifahrer, Gepäck und Zubehör das zulässige Fahrzeug-Gesamtgewicht nicht überschreitet.





3.1. Anbringung der Bedienelemente und Instrumente

DE 3

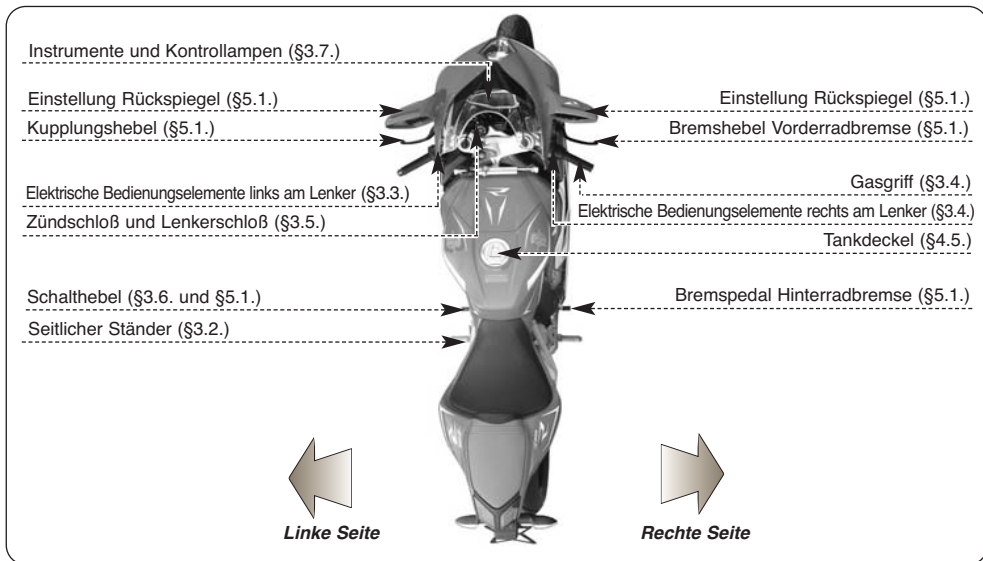



3.2. Seitlicher Ständer

Der Seitenständer ist mit einem Sicherheitsschalter (Startfreigabe) ausgerüstet, der ein Losfahren bei runtergeklapptem Seitenständer verhindert.

Ist der Motor bei runtergeklapptem Seitenständer angelassen worden und wird der Kupplungshebel gezogen, um zu Losfahren einen Gang einzulegen, wird die Stromversorgung zum Motor unterbrochen und der Motor stellt sich ab.

Ist der Seitenständer runtergeklappt und gleichzeitig ein Gang eingelegt, verhindert der Schutzschalter, dass der Motor gestartet werden kann. Auf diese Weise wird ein Umfallen des Motorrads vermieden.

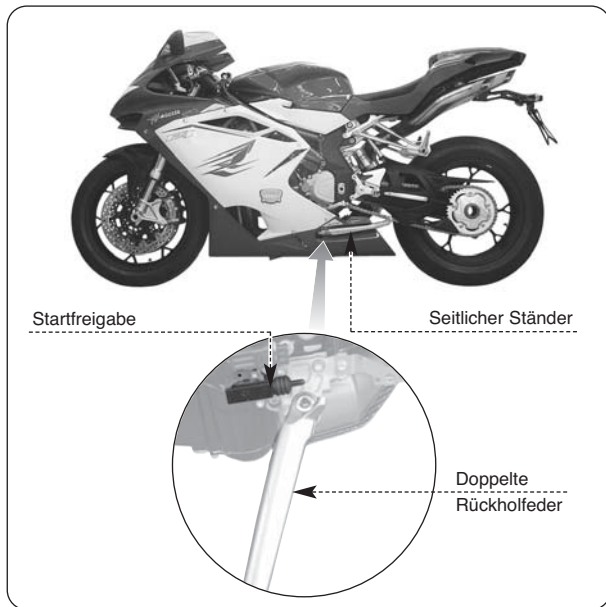



3.3. Bedienungselemente links am Lenker

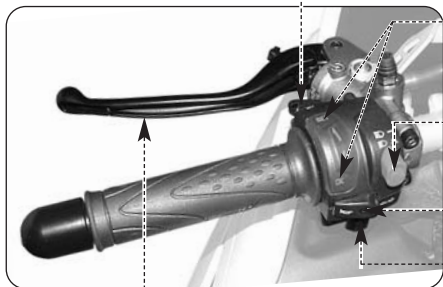



Druckschalter Lichthupe

Den Schalter mehrmals drücken.

Taste SET/OK

Drücken Sie, um die Display-Funktionen wählen (§ 4.4.).

Druckschalter Fernlicht/Fahrlicht

Druckschalter hoch ■ : Fahrlicht 
Druckschalter tief ▬ : Fernlicht 

Hupenschalter

Zur Betätigung der Hupe den Schalter drücken.

Blinkerschalter

Bei Verstellen des Hebels nach rechts oder links werden jeweils die rechten oder linken Blinker eingeschaltet. Der Hebel stellt sich auf Mittelstellung zurück. Zum Ausschalten der Blinker auf den Hebel drücken.

Kupplungshebel

Zur Betätigung der Kupplung den Kupplungshebel ziehen und wieder loslassen.





Lichthupenschalter

Die Betätigung der Lichthupe durch den Lichthupenschalter dient dazu andere Verkehrsteilnehmer auf sich aufmerksam zu machen oder Gefahren zu signalisieren. Bei eingeschaltetem Fernlicht funktioniert die Lichthupe nicht.

Druckschalter Fernlicht/ Abblendlicht

Schaltet sich normalerweise das Abblendlicht ein. Wenn es der Verkehr und die Straßenführung zulassen, kann mit diesem Druckschalter auf Fernlicht umgeschaltet werden.

Hupenschalter

Die Betätigung der Hupe durch den Hupenschalter dient dazu andere Verkehrsteilnehmer auf sich aufmerksam zu machen oder Gefahren zu signalisieren.

Blinkerschalter

Mit diesem Schalter kann anderen Verkehrsteilnehmern ein Fahrtrichtungs- oder Spurwechsel angezeigt werden.



ACHTUNG

Das Nichtbetätigen oder die falsche Betätigung/ das Nichtausschalten des Blinkerschalters kann Unfälle verursachen. Die anderen Verkehrsteilnehmer können dadurch falsche Rückschlüsse auf die tatsächliche Fahrtrichtung ziehen. Vorm Abbiegen oder Spurwechsel stets die Blinker betätigen.

Kupplungshebel

Mit diesem Hebel wird die Kupplung über eine hydraulische Vorrichtung ein- und ausgekuppelt.





3.4. Bedienungselemente rechts am Lenker

Schalter zum Abstellen des Motors

Bei Betätigung wird der Motor abgestellt und kann nicht gestartet werden.

Druckschalter zum Anlassen des Motors

Bei Betätigung wird der Motor gestartet. Sobald der Motor läuft muß der Schalter losgelassen werden. Wird der Schalter bei laufendem Motor erneut betätigt, können die Mapping Zündelektronik ausgewählt werden (§.4.4.10.).

Gasgriff

Zum Gasgeben den Griff drehen.

Bremshebel Vorderradbremse

Zum Bremsen mit der Vorderradbremse den Bremshebel ziehen.

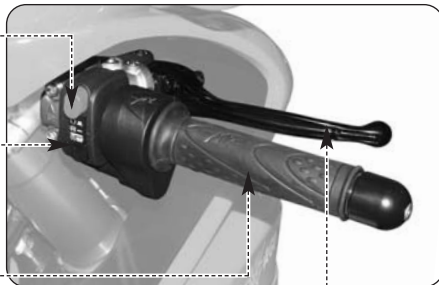



Schalter zum Abstellen des Motors

Mit diesem Schalter kann der Motor in Notfällen abgestellt werden. Wird dieser Schalter betätigt, wird der Zündkreislauf unterbrochen, der Motor kann nicht gestartet werden. Soll der Motor neu gestartet werden, muss vorher dieser Schalter in Ausgangsstellung zurückgestellt werden.

ANMERKUNG

Unter normalen Bedingungen wird dieser Schalter nie zum Abstellen des Motors verwendet.

Druckschalter zum Anlassen des Motors

Mit diesem Schalter wird der Motor gestartet. Bei laufendem Motor können über diesen Schalter die Mapping Zündelektronik ausgewählt werden (siehe § 4.4.10.).



VORSICHT

Um Schäden an der elektrischen Anlage zu vermeiden, sollte dieser Schalter bei Startversuchen nie länger als 5 Sekunden gedrückt werden. Sprint der Motor nach einigen Startversuchen nicht an, siehe Kapitel "STÖRUNGEN" in der vorliegenden Bedienungsanleitung.

Gasgriff

Mit dem Gasgriff wird die Benzinversorgung des Motors geregelt. Zum Gasgeben den Gasgriff aus Ruhestellung (Leerlaufstellung) drehen.



ACHTUNG! Wenn Ihr Motorrad auf die Seite gefallen ist oder in einen Unfall verwickelt wurde, muss der Gasgriff vor einem erneuten Starten des Motorrades durch einen autorisierten MV Agusta Händler überprüft werden.





Bremshebel der Vorderradbremse

Diese Steuerung ermöglicht die Einschaltung des Vorderrad-Bremssystems durch einen hydraulischen Kreislauf.

☐ Antiblockiersystem (ABS) *

Einige Modelle F4 sind mit einem Hilfskraft-Bremssystem ABS (Antiblockiersystem) ausgestattet, das verhindert das Blockieren der Räder während einer Notbremsung, daher garantiert die Stabilität des Fahrzeugs und verkürzt Bremswege.



ACHTUNG

Wenn das ABS-System aktiviert wird, könnte Vibrationen wahrnehmbar am Bremshebel oder Bremspedal. Wenn es auftritt, ist es empfehlenswert, halten die Bremshebel betätigt, um damit das Fahrzeug anzuhalten.



ACHTUNG

Wenn das ABS-System einen Fehler hat oder ausgeschaltet ist, so wird die entsprechende Kontrolllampe auf die Instrumentenausrüstung leuchtet (siehe § 3.7.1.). Von diesem Moment an, konnte das Antiblockiersystem nicht verfügbar sein wenn Sie bremsen. Wenn es einen Fehler in dem ABS-System, empfiehlt es sich, die Fahrt mit verminderter Geschwindigkeit fortgesetzt und einen autorisierten MV Agusta Kundendienst benachrichtigen. Wenn das ABS-System ausgeschaltet ist, folgen Sie den Aktivierungsverfahren in § 4.4.7. beschrieben.

(*): Diese Funktion gibt es nur an einigen Modellen





3.5. Zündschloß und Lenkerschloß



ACHTUNG

Keine Schlüsselanhänger oder anderes am Zündschlüssel anbringen, damit die Lenkerdrehung nicht eingeschränkt wird.



ACHTUNG

Den Zündschlüssel niemals während der Fahrt drehen, Sie könnten sonst die Kontrolle über das Fahrzeug verlieren.

Über das Zündschloß werden der elektrische Kreislauf und das Lenkerschloß ein- bzw. ausgeschaltet. Es gibt folgende vier Stellungen für den Zündschlüssel:

Stellung "OFF"

Alle elektrischen Stromkreise sind ausgeschaltet, der Zündschlüssel kann abgezogen werden.

Stellung "ON"

Alle elektrischen Stromkreise sind eingeschaltet, die Instrumente und Kontrollampen führen eine Autodiagnose durch, der Motor kann gestartet werden. Der Zündschlüssel kann nicht abgezogen werden.



3 DE



VORSICHT

Um Schäden an den elektrischen Bauteilen des Motorrads zu vermeiden, bei ausgeschaltetem Motor den Zündschlüssel nicht über längere Zeit auf Stellung "ON" lassen.





Stellung "LOCK"

Den Lenker nach rechts oder links drehen. Den Schlüssel leicht drücken und auf Stellung "LOCK" drehen.

Alle elektrischen Stromkreise sind ausgeschaltet, das Lenkerschloß ist eingerastet, der Zündschlüssel kann abgezogen werden.

DE 3

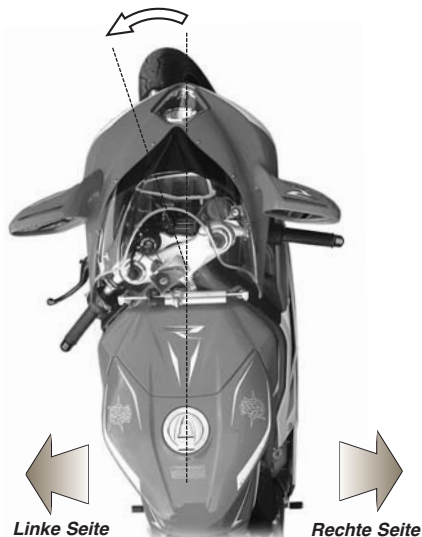



Stellung "P"

Den Schlüssel von Stellung "LOCK" auf Stellung "P" drehen. Alle elektrischen Stromkreise sind mit Ausnahme des Parklichts (Standlichts) ausgeschaltet, das Lenkerschloß ist eingerastet. Der Zündschlüssel kann abgezogen werden.



VORSICHT

Um ein Entladen der Motorradbatterie zu vermeiden, den Schlüssel nicht längere Zeit in Stellung "P" lassen.





3.6. Schaltung

Die Stellung **N** "Neutral" ist die Leerlaufstellung, die auch durch Aufleuchten der entsprechenden Kontrolllampe am Armaturenbrett angezeigt wird. Durch Drücken nach unten wird der erste Gang eingelegt. Durch Drücken nach oben wird der zweite Gang, durch weiteres Drücken der dritte Gang usw. bis zum sechsten Gang eingelegt.

□ Funktion "Quick Shift"

Das Modell F4 RR ist mit einem Gangwechsel-System/Schaltautomat ("Quick Shift") ausgestattet. Dieses System ermöglicht Ihnen in den nächst höheren Gang zu schalten, ohne die Kupplung zu ziehen oder die Gasgriffstellung zu verändern. Auf diese Weise ist es möglich, den nächst höheren Gang blitzschnell einzulegen und so den Beschleunigungsvorgang beizubehalten. Das "Quick Shift"-System arbeitet nicht:

- wenn der Kupplungshebel gezogen wird
- bei einer Geschwindigkeit von weniger als 30 km/h
- beim Zurückschalten in einen niedrigeren Gang
- wenn die "Quick Shift" Funktion abgeschaltet ist (siehe §4.4.8.)

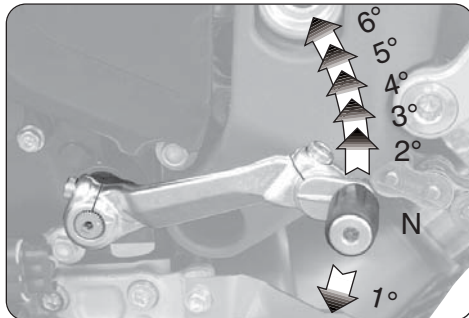

ACHTUNG! Wenn Sie das Motorrad in einem niedrigen Gang mit hohen Drehzahlen fahren und das Quick Shift System zum Hochschalten benutzen, kann das zu abrupten Reaktionen führen, die die Stabilität des Fahrzeugs beeinträchtigen können. MV Agusta empfiehlt in diesen Fahrsituationen den Kupplungshebel zum Schalten zu benutzen, insbesondere dann, wenn die Motor-drehzahl kurz vor dem Einsetzen des Drehzahlbegrenzers liegt.





3.7. Instrumente und Kontrolllampen

Die Instrumente und Kontrolllampen werden durch Drehen des Zündschlüssels auf "ON" eingeschaltet. Nach einer ersten Überprüfung (ungefähr 7 Sekunden) zeigen die Instrumente den allgemeinen Zustand des Motorrads in diesem Moment an.

Kontrolllampen
(§3.7.1.)

Drehzahlmesser-Display

Taste "HAZARD" (§3.7.2.)



Taste "SET"
(§3.7.2.)

Taste "OK"
(§3.7.2.)

Multifunktions-Display (§3.7.2.)





3.7.1. Kontrolllampen

Fernlichtkontrolle (blau)

Leuchtet auf, wenn das Fernlicht eingeschaltet ist.

Blinker/Hazard-Kontrolle (grün)

Leuchtet auf, wenn die Blinker oder die Warnblinkanlage (siehe §3.7.2.) eingeschaltet sind.

Kontrolllampe Schaltung in Leerlauf (grün)

Leuchtet auf, wenn die Schaltung auf Leerlaufposition "Neutral" gestellt ist.

Kontrolllampe ABS (orange) *

Leuchtet auf, wenn das ABS-System einen Fehler hat oder ausgeschaltet ist, oder wenn die Geschwindigkeit niedriger als 5 km/h beträgt.



Gefahr – Achtung: Wenn die Kontrolllampe leuchtet während der Fahrt, sofort anhalten und überprüfen Sie, dass das ABS-System eingeschaltet ist (siehe §4.4.7). In diesem Fall, die Fahrt mit verminderter Geschwindigkeit fortgesetzt und einen autorisierten MV Agusta Kundendienst benachrichtigen.

(*): Diese Funktion gibt es nur an einigen Modellen



Motoröldruckkontrolle (rot)

Leuchtet auf, wenn der Öldruck unzureichend ist.



Gefahr - Achtung: Schaltet sie sich während der Fahrt ein, sofort anhalten und den Ölstand kontrollieren. Gegebenenfalls bei einem autorisierten MV Agusta Kundendienst nachfüllen lassen (siehe §3.8). Schaltet sie sich auch bei richtigem Ölstand ein, nicht weiterfahren und einen autorisierten MV Agusta Kundendienst benachrichtigen.

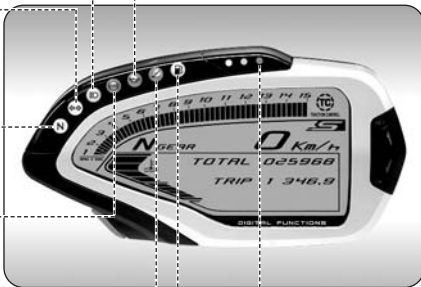

Kontrolllampe Drehzahlbegrenzung (rot)

Leuchtet auf, wenn die Motordrehzahl über 10800 U/min liegt. Die Drehzahlbegrenzung schaltet sich ab 13500 U/min ein.

Benzinreservekontrolle (orange)

Leuchtet auf, wenn im Tank noch ungefähr 4 Liter Kraftstoff enthalten sind.

Kontrolle ausgeklappter Seitenständer (rot)

Leuchtet auf, wenn der Seitenständer ausgeklappt ist.



3.7.2. Multifunktions-Display

Display eingelegter Gang

Zeigt an, welcher Gang aktuell eingelegt ist. Die Leerlaufposition wird durch den Buchstaben "N" (Neutral) angezeigt.

Thermometer

Zeigt die Kühlflüssigkeitstemperatur durch Einschalten unterschiedlich vieler Balken an einer Messskala an. Liegt die Temperatur außerhalb des normalen Betriebsbereiches, kann folgendes angezeigt werden: - Am Display wird nur ein einziger, blinkender Balken angezeigt. Das ist die Anzeige für niedrige Temperatur. - Alle Balken sind eingeschaltet, der oberste Balken blinkt. Das ist die Anzeige für hohe Temperatur.



Gefahr – Achtung: Bei hoher Temperatur das Fahrzeug anhalten und den Kühlflüssigkeitsstand kontrollieren. Muss nachgefüllt werden, wenden Sie sich bitte an einen autorisierten MV Agusta Kundendienst (siehe § 3.8). Erscheint die Anzeige auch bei richtigem Kühlflüssigkeitsstand, nicht weiterfahren und einen autorisierten MV Agusta Kundendienst benachrichtigen.

Tachometer

Zeigt die Geschwindigkeit an. Der Wert kann im Kilometer pro Stunde (km/h) oder Meilen pro Stunden (Mph) angezeigt werden. Der Wert bei Vollausschlag ist 350 km/h (217 Mph).

Mapping Motorsteuerung

Zeigt den ausgewählten Mapping der Motorsteuereinheit.

Taste "SET"

Wenn sie gedrückt wird, können die Ziffern am Display für die Einstellungen ausgewählt werden.

Taste "OK"

Mit dem Drücken der Taste wird die Eingabe der Ziffern bestätigt.

Taste "HAZARD"

Durch Drücken dieser Taste wird die Warnblinkanlage eingeschaltet.

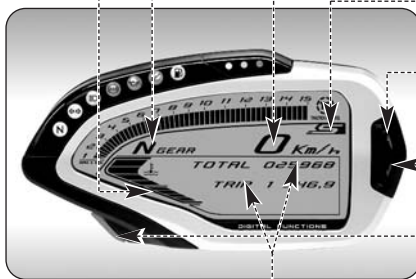

Gesamt-Kilometerzähler "TOTAL"

Zeigt den Gesamt-Kilometerstand an; von 0 bis 999999 (km oder mi)

Teilstrecken-Kilometerzähler 1 "TRIP 1"

Zeigt den Teilstrecken-Kilometerstand an; von 0 bis 999.9 (km oder mi)

Teilstrecken-Kilometerzähler 2 "TRIP 2"

Zeigt den Teilstrecken-Kilometerstand an; von 0 bis 999.9 (km oder mi)

Chronometer / Zeitmesser

Zeigt die mit dem Chronometer gemessenen Zeiten an.





3.8. Schmiermitteltabelle

Beschreibung	Empfohlenes Produkt	Technische Angaben
Motoröl	eni i-Ride motoGP 10W-60 (*)	SAE 10W/60 - API SG
Kühlflüssigkeit	Agip Eco - Permanent	Glykolethylen mit 50% destilliertem Wasser verdünnt
Brems- und Kupplungsflüssigkeit	Agip Brake 4	DOT4
Kettenöl	D.I.D. CHAIN LUBE	-

* : Damit Sie die empfohlenen Produkte finden und kaufen können, empfiehlt Ihnen MV Agusta sich direkt an die autorisierten Vertragshändler zu wenden. Das Motoröl eni i-Ride motoGP 10W-60 wurde speziell für den Motor des Motorrads F4 entwickelt. Steht das empfohlene Schmiermittel nicht zu Verfügung, rät MV Agusta zum Gebrauch vollständig synthetischer Öle, die die gleichen oder bessere Eigenschaften als folgende Normen haben:

- Konform API SG
- Konform ACEA A3
- Konform JASO MA
- Grad SAE 10 W-60

ANMERKUNG

Die o. a. Spezifizierungen müssen entweder allein oder zusammen mit anderen auf dem Behälter des Motoröl aufgedruckt sein.





4.1. Einsatz des Motorrads

In diesem Abschnitt werden die wichtigsten Themen für einen richtigen Einsatz des Motorrads behandelt.



ACHTUNG

Das Motorrad zeigt hohe Leistungsmerkmale. Für sein Gebrauch wird ein ausreichendes Niveau des Wissens des Fahrzeugs angefordert. Wenn Sie dieses Motorrad zum ersten Mal benutzen, ist es notwendig, eine vorsichtige Haltung anzunehmen. Eine konkurrenzfähige Ridinghaltung kann die Gefahr der Unfälle erhöhen, welche die Sicherheit des Treibers und der Leute gefährden.



ACHTUNG

DIE BESCHRÄNKUNGEN FÜR DIE ERLAUBTE NUTZUNG DES FAHRZEUGES FINDEN SIE IM ABSCHNITT "SICHERHEITSINFORMATIONEN".



VORSICHT

Die hohen Temperaturen, die durch den Gebrauch auf Rennstrecken verursacht wurden, konnten die Leistungsfähigkeit des katalytischen Konverters und der Abgasanlage verringern; folglich schlagen wir das Zusammenbauen einer speziellen Abgasanlage vor, wenn Sie den Fahrzeug auf Rennstrecken benutzen.





4.2. Einfahren



Vorsicht - Vorsichtsmaßnahme: Die Nichteinhaltung der Anweisungen kann schwere und dauerhafte Schäden am Fahrzeug verursachen.

Normalerweise denkt man beim Einfahren nur an den Motor. Tatsächlich muß die Einfahrzeit auch für andere wichtige Motorradteile berücksichtigt werden. Dies gilt besonders für die Reifen, die Bremsen, die Antriebskette usw. Die ersten Kilometer müssen besonders langsam und ruhig gefahren werden.

Von 0 bis 500 km (von 0 bis 300 mile) (A)

In dieser ersten Einfahrphase sollte die Motordrehzahl häufig geändert werden. Möglichst auf leicht hügeligen und kurvenreichen Strecken fahren und lange grade Strecken vermeiden.



ACHTUNG

Neue Reifen müssen auf geeignete Weise eingefahren werden, so dass sie ihre komplette Effizienz erhalten. Während der ersten 100 km sollte ein Anfahren bei Vollgas, schnelle Kurvenfahrten und Vollbremsungen vermieden werden. Wird der Einfahrzeitraum nicht beachtet, besteht Schleuder- oder Unfallgefahr, weil die Kontrolle über das Fahrzeug verloren gehen kann.





❑ **Von 500 bis 1000 km (von 300 bis 600 mile)**

In dieser Phase Vollgas vermeiden und nie über lange Strecken mit konstanter Geschwindigkeit fahren.



❑ **Von 1000 bis 2500 km (von 600 bis 1600 mile)**

Das Motorrad kann jetzt stärker beansprucht werden. Trotzdem sollte die angegebene Motordrehzahl nicht überschritten werden.

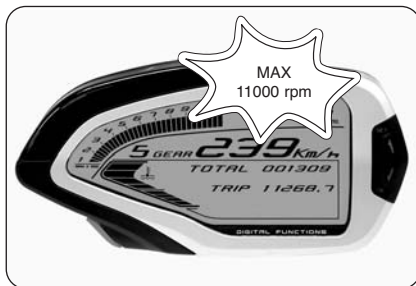



4.3. Starten des Motors



ACHTUNG

Das Fahrzeug in geschlossenen Räumen laufen zu lassen ist gefährlich. Die Abgase enthalten Kohlenmonoxid, ein farbloses und geruchloses Gas, das tödlich sein oder zu schweren Unfällen führen kann. Den Motor nur Außen, in der freien Luft laufen lassen.



► Wird der Zündschalter auf "ON" gedreht, wird von den Instrumenten und den Kontrolllampen eine Autodiagnose ausgeführt. Während dieser Phase sollte geprüft werden, dass sich alle Kontrolllampen am Armaturenbrett einschalten.

► Damit das System für die Zündkreis-Unterbrechung die Startfreigabe gibt, muss eine der folgenden Bedingungen erfüllt sein:

- Die Schaltung ist auf Leerlaufposition.
- Bei der Schaltung ist ein Gang eingelegt, der Kupplungshebel ist gezogen und der Seitenständer hochgeklappt.





► Wenn die Autodiagnose erkennt eine Störung am Fahrzeug, das Display zeigt die Warnung in der gezeigten Bild. Insbesondere das Display zeigt die Teil des Motorrads, auf denen das Störung festgestellt wurde.



► Die Taste "OK" drücken, bis die Funktion "RUN" angezeigt wird.

**ACHTUNG**

Wird ein Störung am Fahrzeug erkannt wird, nicht den Motor starten und einen autorisierten MV Agusta Kundendienst benachrichtigen.





□ Starten des motors

- ▶ Den Anlasserschalter drücken, ohne den Gasgriff zu drehen.
- ▶ Sobald der Motor gestartet ist, den Anlasserschalter loslassen.



Vorsicht – Vorsichtsmaßnahme:

- Um Schäden an der elektrischen Anlage zu vermeiden, den Anlasserschalter nicht länger als 5 Sekunden gedrückt halten.
 - Den Motor nicht über längere Zeit bei stehendem Motorrad laufen lassen. Die daraus folgende Überhitzung kann interne Motorbauteile beschädigen.
- Der Motor sollte bei langsamer Fahrt auf Betriebstemperatur gebracht werden.
- Um die Haltbarkeit des Motors zu verlängern, bei kaltem Motor kein Vollgas geben.

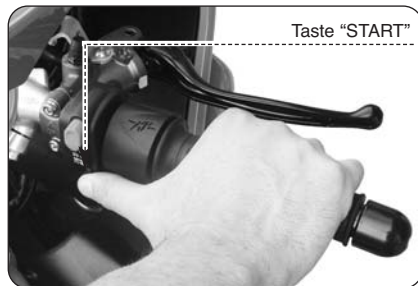



4.4. Auswahl und Ändern der Display-Funktionen

Die Instrumentenausrüstung sieht vor, dass einige der wichtigsten Mess-Parameter geändert werden können. Es ist folgendes möglich:

- Auswahl des Betriebsmodus:
 - “RUN” (Kilometerzähler)
 - “TC” (Traktionskontrolle)
 - “CHRONO” (Chronometer)
 - “NIGHT/DAY” (Betriebsmodus Nacht/Tag)
 - “SETTING ÖHLINS” (Elektronische Fahrwerkseinstellung)
 - “ABS” (Antiblockiersystem)*
 - “QUICK SHIFT”
- Nullstellen der Funktionen des Teilstrecken-Kilometerzählers:
 - Teilstrecken-Kilometerzähler 1 “TRIP 1”
 - Teilstrecken-Kilometerzähler 2 “TRIP 2”
- “IMMOBILIZER” (Anlage Diebstahlsicherung)
- Auswahl Mapping Motorsteuerung

(*): Diese Funktion gibt es nur an einigen Modellen





4.4.1. Auswahl Display-Funktionen

Die Auswahl bezieht sich auf folgende Betriebsmodalitäten:

- "RUN" (Kilometerzähler)
- "TC" (Traktionskontrolle)
- "CHRONO" (Zeitmesser)
- "NIGHT/DAY" (Betriebsmodus Nacht/Tag)
- "SETTING ÖHLINS" (Elektronische Fahrwerkseinstellung)
- "ABS" (Antiblockiersystem)*
- "QUICK SHIFT"

Die Anzeige der einzelnen Betriebsmodalitäten erfolgt durch Druck auf die Taste "SET" für weniger als 3 Sekunden. Bei Betätigung der Taste werden die Funktionen zyklisch am Display angezeigt. Die gewünschte Funktion auswählen.

(*): Diese Funktion gibt es nur an einigen Modellen



ACHTUNG

Änderungen oder Einstellungen an den Displayfunktionen müssen bei ausgeschaltetem Motor, Schaltung in Leerlauf, angehaltenem Motorrad und Füßen auf dem Boden ausgeführt werden. Eine Änderung der Displayeinstellungen während der Fahrt ist verboten.





❑ Betriebsmodus "RUN"

Außer der Tachometerfunktion werden am Display folgende Funktionen angezeigt (siehe §4.4.2.):

- Gesamt-Kilometerzähler "TOTAL"
- Teilstrecken-Kilometerzähler 1 "TRIP 1"

Als eine Alternative:

- Gesamt-Kilometerzähler "TOTAL"
- Teilstrecken-Kilometerzähler 2 "TRIP 2"

❑ Betriebsmodus "TC"

Mit dieser Funktion kann die Motor-Traktionskontrolle den eigenen Fahransprüchen angepasst werden (siehe §4.4.3.).





❑ Betriebsmodus “CHRONO”

Mit diesem Betriebsmodus kann die Chronometerfunktion sowie das Speichern der Messdaten eingeschaltet werden (siehe §4.4.4.). Folgende Funktionen werden angezeigt:

- Chronometer Aktuelle Runde “CURRENT LAP”
- Chronometer Schnellste Runde “BEST LAP”
- Chronometer Letzte Runde “LAST LAP”
- Rundenzähler Runden-Gesamtanzahl “N° LAP”



❑ Betriebsmodus “NIGHT/DAY”

Mit dieser Funktion kann die Hintergrundfarbe des Display invertiert werden, um die Lesbarkeit an die jeweiligen Tag- oder Nachtverhältnisse anzupassen (siehe §4.4.5.).





Betriebsmodus "SETTING ÖHLINS"

Dieses Menü erlaubt die Einstellung der folgenden Komponenten (siehe §4.4.6.):

- Vorderradfederung
- Hinterradfederung
- Lenkungsdämpfer

Betriebsmodus "ABS" *

In diesem Menü ist es möglich das Antiblockiersystem (ABS) zu aktivieren oder zu deaktivieren (siehe §4.4.7.).

(*): Diese Funktion gibt es nur an einigen Modellen





□ Betriebsmodus “QUICK SHIFT”

Diese Menüfunktion erlaubt Ihnen die Aktivierung bzw. Deaktivierung der Quick Shifter Funktion (siehe § 4.4.8.).





4.4.2. Nullstellen der Funktionen des Teilstrecken-Kilometerzählers

Die Werte der Funktionen "TRIP 1" und "TRIP 2" können wie folgt auf Null zurückgestellt werden:



ACHTUNG

Änderungen oder Einstellungen an den Displayfunktionen müssen bei ausgeschaltetem Motor, Schaltung in Leerlauf, angehaltenem Motorrad und Füßen auf dem Boden ausgeführt werden. Eine Änderung der Displayeinstellungen während der Fahrt ist verboten.

- ▶ Den Modus "RUN" öffnen. Auf der Startseite werden die Funktionen Gesamt-Kilometerzähler ("TOTAL") und Teilstrecken-Kilometerzähler 1 ("TRIP 1") angezeigt.
- ▶ Wird jetzt die Taste "OK" länger als drei Sekunden gedrückt gehalten, wird der Wert für "TRIP 1" auf Null gestellt.





► Die Taste "OK" kürzer als 3 Sekunden drücken, bis die Funktion Teilstrecken-Kilometerzähler 2 ("TRIP 2") angezeigt wird.



► Wird jetzt die Taste "OK" länger als drei Sekunden gedrückt gehalten, wird der Wert für "TRIP 2" auf Null gestellt.





4.4.3. Betriebsmodus "TC"

► Die Taste "SET" drücken, bis den Betriebsmodus "TC" öffnen; dann die Taste "OK" weniger als 3 Sekunden drücken, bis "TC LEVEL" angezeigt wird. Die aktuelle Stufe für die Traktionskontrolle entspricht dem am Display angezeigten Wert.



ACHTUNG

Änderungen oder Einstellungen an den Displayfunktionen müssen bei ausgeschaltetem Motor, Schaltung in Leerlauf, angehaltenem Motorrad und Füßen auf dem Boden ausgeführt werden. Eine Änderung der Displayeinstellungen während der Fahrt ist verboten.

► Wenn Sie "OK" für weniger als 3 Sekunden drücken, verringern Sie die Traktionskontrolle um eine Stufe. Dieser Wert kann zwischen "0" und "8" eingestellt werden.

"0" = sehr später Eingriff der Traktionskontrolle

"8" = früher Eingriff der Traktionskontrolle

Alle Stufen zwischen "0" und "8" sind Abstufungen der beiden Werte.

► Drücken Sie "OK" für länger als 3 Sekunden um die ausgewählte Stufe der Traktionskontrolle zu bestätigen.

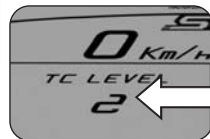
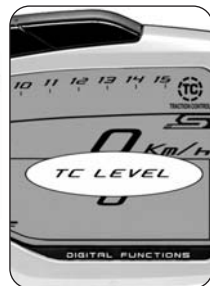



4.4.4. Chronometer

□ Rundenzeitenerfassung

► Nachdem die Chronometer-Funktion eingeschaltet worden ist (Betriebsmodus "CHRONO"), kann mit der Datenerfassung bezüglich der Rundenzeiten begonnen werden.



► Bei Betätigung der Lichthupentaste wird mit der Datenmessung begonnen. Die kleinen Punkte, mit denen die Minutenanzeige von der Sekundenanzeige und von den Zehntel Sekunden getrennt ist, fangen an zu blinken. Das Instrument fängt an die Zeiten zu erfassen.

ANMERKUNG

Wenn die Funktion "CHRONO" aktiviert ist wird durch die erste Betätigung der Lichtupe die Funktion Traktionskontrolle eingeschaltet. Ab jetzt ist es möglich die Stufe der Traktionskontrolle durch die Tasten "SET" und "OK" zu verändern (siehe §4.4.3.).





► Bei erneutem Druck auf die Lichthupentaste wird die Messzeit zur ersten gefahrenen Runde registriert. Gleichzeitig beginnt das Instrument mit der Erfassung der zweiten Rundenzeit.

Die Messzeit zur ersten gefahrenen Runde wird im Speicher gespeichert und bleibt für 10 Sekunden am Display angezeigt, anschließend wird die Zeit für die nächste Runde angezeigt.

► Wird das Chronometer weiter benutzt, wird bei jeder Betätigung der Lichthupentaste eine Zeit registriert. Mit dem Instrument können maximal bis zu 100 aufeinander folgende Daten gespeichert werden.

Während der Zeitanzeige zur eben beendeten Runde erscheint am Display das Symbol “+” oder “-”, je nachdem, ob die gemessene Zeit länger oder kürzer als die vorherige Rundenzeit war.

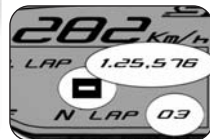
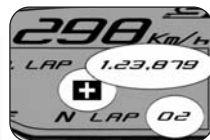
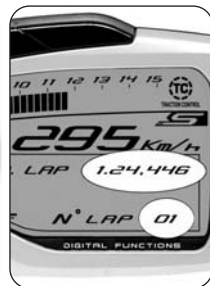



□ Anzeige der Daten

Nach der Erfassung der Zeiten können die Daten angezeigt werden.

- ▶ Den Modus "CHRONO" öffnen. Auf dieser Seite werden die schnellste Rundenzeit ("BEST LAP") sowie die letzte Rundenzeit ("LAST LAP") angezeigt.



ACHTUNG

Änderungen oder Einstellungen an den Displayfunktionen müssen bei ausgeschaltetem Motor, Schaltung in Leerlauf, angehaltenem Motorrad und Füßen auf dem Boden ausgeführt werden. Eine Änderung der Displayeinstellungen während der Fahrt ist verboten.

- ▶ Die Taste "OK" kürzer als 3 Sekunden drücken, bis "LAPS VIEW" angezeigt wird.

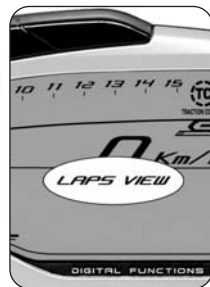



► Durch wiederholten Druck auf die Taste "OK" können nacheinander alle vorher erfassten Zeiten ab der letzten gespeicherten Runde angezeigt werden.

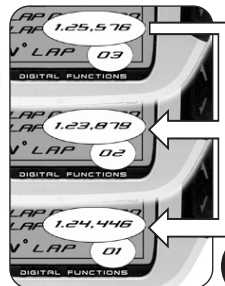

4 DE

► Am Ende der Datenanzeige kann durch Druck auf die Taste "SET" wieder auf den Betriebsmodus "LAPS VIEW" zurückgestellt und auf den nächsten Modus umgestellt werden.

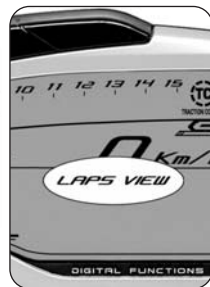



❑ Löschen der Daten

Die gespeicherten Daten können wie folgt gelöscht werden:



ACHTUNG

Änderungen oder Einstellungen an den Displayfunktionen müssen bei ausgeschaltetem Motor, Schaltung in Leerlauf, angehaltenem Motorrad und Füßen auf dem Boden ausgeführt werden. Eine Änderung der Displayeinstellungen während der Fahrt ist verboten.

► *Löschen einzelner Zeiten:* Den Betriebsmodus "CHRONO" öffnen und die Taste "SET" kürzer als drei Sekunden drücken, bis "SINGLE LAP RESET" angezeigt wird.

► Die Taste "OK" kürzer als drei Sekunden drücken. Der Wert für die letzte Zeit der gespeicherten Runde fängt an zu blinken.

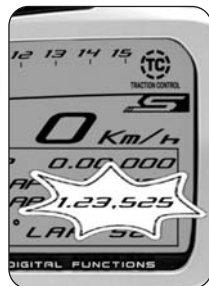



► Wird jetzt die Taste "OK" länger als drei Sekunden gedrückt gehalten, wird der Wert gelöscht.
Wird hingegen die Taste "SET" kürzer als drei Sekunden gedrückt gehalten, wird das Löschverfahren abgebrochen.



► Anschließend können, durch Druck auf die Lichthupentaste mit folgendem Druck auf die Taste "OK" für länger als drei Sekunden, nacheinander alle vorher gemessenen Zeiten gelöscht werden.



► Nach dem Löschen der Daten kann durch Druck auf die Taste "SET" wieder auf den Betriebsmodus "LAPS VIEW" zurückgestellt und auf den nächsten Modus umgestellt werden.





► *Löschen der besten Zeit:* Den Betriebsmodus "LAPS VIEW" öffnen und die Taste "SET" kürzer als drei Sekunden drücken, bis "BEST LAP RESET" angezeigt wird.



► Die Taste "OK" kürzer als drei Sekunden drücken. Der Wert für die beste Rundenzeit fängt an zu blinken.





► Wird jetzt die Taste "OK" länger als drei Sekunden gedrückt gehalten, wird der Wert gelöscht.
Wird hingegen die Taste "SET" kürzer als drei Sekunden gedrückt gehalten, wird das Löschverfahren abgebrochen.

► Nach dem Löschen der Daten das Display zeigt "LAP TIME ERASED", kehrt dann zum der Betriebsmodus "LAPS VIEW".

► *Löschen aller gespeicherten Zeiten:* Den Betriebsmodus "LAPS VIEW" öffnen und die Taste "SET" kürzer als drei Sekunden drücken, bis "ALL LAPS RESET" angezeigt wird.





► Die Taste "OK" kürzer als drei Sekunden drücken. Am Display wird zur Eingabe einer Bestätigung aufgefordert, dass alle im Speicher befindlichen Daten gelöscht werden sollen.

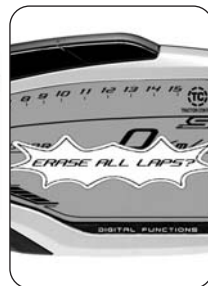

► Wird jetzt die Taste "OK" länger als drei Sekunden gedrückt gehalten, werden alle vorher gespeicherten Zeiten gelöscht. Wird hingegen die Taste "SET" kürzer als drei Sekunden gedrückt gehalten, wird das Lösungsverfahren abgebrochen.

► Nach dem Löschen der Daten das Display zeigt "ALL LAPS ERASED", kehrt dann zum der Betriebsmodus "LAPS VIEW".





4.4.5. Betriebsmodus "NIGHT/DAY"

► Um die Hintergrundfarbe des Display umzuschalten, den Modus "NIGHT/DAY MODE" öffnen und die Taste "OK" kürzer als drei Sekunden drücken.



ACHTUNG

Änderungen oder Einstellungen an den Displayfunktionen müssen bei ausgeschaltetem Motor, Schaltung in Leerlauf, angehaltenem Motorrad und Füßen auf dem Boden ausgeführt werden. Eine Änderung der Displayeinstellungen während der Fahrt ist verboten.

► Mit der Taste "SET" kann zyklisch von Tag- auf Nachtanzeige des Displays umgeschaltet werden.

► Ist die gewünschte Hintergrundfarbe des Display eingestellt, kann durch Druck auf die Taste "OK" für länger als drei Sekunden die gewählte Darstellung bestätigt und auf den Modus "NIGHT/DAY MODE" zurückgestellt werden. Die auf diese Weise gewählte Hintergrundfarbe wird bei den nachfolgenden Bedienmodi der Armaturenbrett beibehalten.

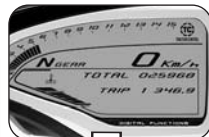
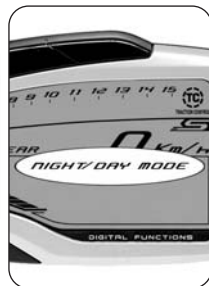



4.4.6. Elektronische Fahrwerkseinstellung

► Um die individuellen Einstellungen des Fahrwerks vorzunehmen, die Taste "SET" drücken um in das Menü "SETTING ÖHLINS" zu wechseln.



ACHTUNG: Änderungen oder Einstellungen an den Displayfunktionen müssen bei ausgeschaltetem Motor, Schaltung in Leerlauf, angehaltenem Motorrad und Füßen auf dem Boden ausgeführt werden. Eine Änderung der Displayeinstellungen während der Fahrt ist verboten.

ANMERKUNG: Die Fahrwerkseinstellung ist nur möglich wenn das Mapping "C" des Zündelektronik ausgewählt ist (siehe § 4.4.10.).

ANMERKUNG: Beachten Sie die anliegende Fahrwerkstabelle für die empfohlenen Einstellwerte.

□ Druckstufendämpfung (Vorderradfederung)

► Drücken Sie "OK" für weniger als drei Sekunden und in der Anzeige erscheinen die verfügbaren Einstellparameter.

► Nach einigen Sekunden fangen die Bildtexte "FRONT" und "C" an zu blinken und die Druckstufendämpfung der Vorderradfederung kann eingestellt werden.





▶ Drücken Sie "OK" für weniger als drei Sekunden und die Druckstufendämpfung erhöht sich auf den nächsten Wert. Sie können den Wert zwischen **1** und **26** einstellen.

▶ Drücken Sie "OK" für mehr als drei Sekunden um den ausgewählten Wert der Druckstufendämpfung zu bestätigen. Das System ist jetzt bereit für weitere Einstellungen. Um den Einstellvorgang abzubrechen, drücken Sie "SET" für weniger als drei Sekunden; die Einstellungen gespeichert werden und das Display zum Hauptmenü zurück wird.

□ Zugstufendämpfung (Vorderradfederung)

▶ Nach einigen Sekunden fangen die Bildtexte "FRONT" und "R" an zu blinken und die Zugstufendämpfung der Vorderradfederung kann eingestellt werden.

▶ Drücken Sie "OK" für weniger als drei Sekunden und die Zugstufendämpfung erhöht sich auf den nächsten Wert. Sie können den Wert zwischen **1** und **26** einstellen.

▶ Drücken Sie "OK" für mehr als drei Sekunden um den ausgewählten Wert der Zugstufendämpfung zu bestätigen.



4 DE

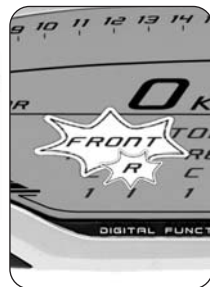



□ Druckstufendämpfung (Hinterradfederung)

- ▶ Nach einigen Sekunden fangen die Bildtexte "REAR" und "C" an zu blinken und die Druckstufendämpfung der Hinterradfederung kann eingestellt werden.
- ▶ Drücken Sie "OK" für weniger als drei Sekunden und die Druckstufendämpfung erhöht sich auf den nächsten Wert. Sie können den Wert zwischen **1** und **26** einstellen.
- ▶ Drücken Sie "OK" für mehr als drei Sekunden um den ausgewählten Wert der Druckstufendämpfung zu bestätigen.



□ Zugstufendämpfung (Hinterradfederung)

- ▶ Nach einigen Sekunden fangen die Bildtexte "REAR" und "R" an zu blinken und die Zugstufendämpfung der Hinterradfederung kann eingestellt werden.
- ▶ Drücken Sie "OK" für weniger als drei Sekunden und die Zugstufendämpfung erhöht sich auf den nächsten Wert. Sie können den Wert zwischen **1** und **26** einstellen.
- ▶ Drücken Sie "OK" für mehr als drei Sekunden um den ausgewählten Wert der Zugstufendämpfung zu bestätigen.





□ Lenkungsdämpfer

- ▶ Nach einigen Sekunden erscheinen die verfügbaren Menüs um den Lenkungsdämpfer einzustellen (“AUTO”: automatisch; “MANUAL”: individuell).
- ▶ Drücken Sie “OK” für weniger als drei Sekunden und der Bildtext “AUTO” fängt an zu blinken.
- ▶ Drücken Sie “SET” für weniger als drei Sekunden und der Bildtext “MANUAL” fängt an zu blinken. Drücken Sie “OK” für mehr als drei Sekunden und der Lenkungsdämpfer kann eingestellt werden.
- ▶ Drücken Sie “OK” für weniger als drei Sekunden und die Dämpfung des Lenkungsdämpfers erhöht sich auf den nächsten Wert. Sie können den Wert zwischen **1** und **14** einstellen.
- ▶ Drücken Sie “OK” für mehr als drei Sekunden um den eingestellten Wert des Lenkungsdämpfers zu bestätigen. Das System schaltet in den Betriebsmodus “SETTING ÖHLINS” zurück. Um den Einstellvorgang abzubrechen und die ausgewählten Fahrwerkeinstellungen zu bestätigen drücken Sie “SET” für weniger als drei Sekunden.

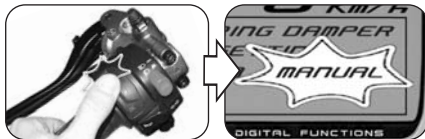



4.4.7. Auswahl der ABS-Funktion *

► Drücken Sie “SET” um in das Menü “ABS” zu wechseln; “SETTING ABS” erscheint in der Anzeige.



ACHTUNG: Änderungen oder Einstellungen an den Displayfunktionen müssen bei ausgeschaltetem Motor, Schaltung in Leerlauf, angehaltenem Motorrad und Füßen auf dem Boden ausgeführt werden. Eine Änderung der Displayeinstellungen während der Fahrt ist verboten.

- Drücken Sie “OK” für weniger als drei Sekunden und das Display zeigt die zuletzt gespeicherte Auswahl. In Standard-Bedingungen, “ABS NORMAL” (ABS-Funktion für Straßennutzung) fängt an in der Anzeige zu blinken.
- Falls Sie keinen Knopf drücken wird die Einstellung “ABS NORMAL” nach drei Sekunden bestätigt und die ABS-Funktion für Straßennutzung ist aktiviert. Drücken Sie “SET” um das ABS-Menü zu verlassen.

(*): Diese Funktion gibt es nur an einigen Modellen





► Falls Sie "OK" drücken solange der Bildtext blinkt, erscheint "ABS RACE" (ABS-Funktion für Rennstreckennutzung) in der Anzeige.

 **ACHTUNG:** Die "ABS RACE" Funktion wurde ausdrücklich für die Fahrzeugnutzung auf der Rennstrecke entwickelt. MV Agusta empfiehlt diese Funktion nicht auf öffentlichen Straßen zu nutzen.

► Falls Sie keinen Knopf drücken wird die Einstellung "ABS RACE" nach drei Sekunden bestätigt. Falls Sie "OK" drücken solange der Bildtext blinkt, erscheint "ABS OFF" in der Anzeige.

► Falls Sie keinen Knopf drücken wird die Einstellung "ABS OFF" nach drei Sekunden bestätigt. Das ABS-System ist deaktiviert.

 **ACHTUNG:** Falls das ABS-System abgeschaltet, wird geht das entsprechende Warnlicht im Instrumentenbrett an (siehe §3.7.1.). Ab diesem Moment steht das Antiblockiersystem beim Bremsen nicht zur Verfügung. Fahren Sie vorsichtig und mit geringer Geschwindigkeit, um nicht die Kontrolle zu verlieren beim Bremsen.

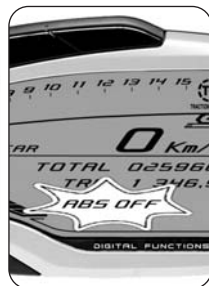
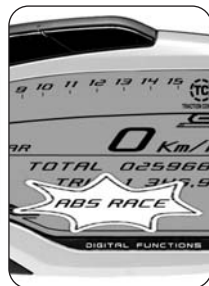



4.4.8. Betriebsmodus "QUICK SHIFT"

▶ Drücken Sie mehrfach die Taste "SET" am linken Lenkerschalter bis der Betriebsmodus "QUICK SHIFT" erscheint. Die aktuelle Einstellung wird im Display angezeigt.



ACHTUNG

Änderungen oder Einstellungen an den Displayfunktionen müssen bei ausgeschaltetem Motor, Schaltung in Leerlauf, angehaltenem Motorrad und Füßen auf dem Boden ausgeführt werden. Eine Änderung der Displayeinstellungen während der Fahrt ist verboten.

- ▶ Drücken Sie "OK" für weniger als drei Sekunden und die aktuelle Einstellung beginnt zu blinken.
- ▶ Drücken Sie "OK" für weniger als drei Sekunden und die Einstellung schaltet von "OFF" zu "ON" und umgekehrt.
- ▶ Nach einigen Sekunden, die ausgewählte Einstellung der "Quick Shift" Funktion automatisch bestätigt wird.





4.4.9. Betriebsmodus "IMMOBILIZER"

Die Funktion "IMMOBILIZER" (Wegfahrsperrung) ermöglicht ein Starten des Motors nur, nachdem der Original-Zündschlüssel erkannt worden ist. Es handelt sich um eine, in den elektronischen Schaltkreis des Fahrzeugs integrierte, Diebstahlsicherung, die allen nicht autorisierten Personen die Nutzung des Fahrzeugs verwehrt. Der Betriebsmodus "IMMOBILIZER" am Armaturenbrett darf nur bei Störungen benutzt werden. Sollte der Originalschlüssel aus irgend einem Grund nicht von der Anlage erkannt werden, um die Motor-Startfreigabe zu erhalten, muss der Geheimcode eingegeben werden, der auf der MV Code Card angegeben ist, die zusammen mit dem Fahrzeug übergeben wurde.

- ▶ Die Abdeckung vom Textkasten auf der Rückseite der MV Code Card entfernen und den elektronischen Geheimcode für den Zündschlüssel ablesen (in der Abbildung ist ein reiner Beispielwert für den Code angegeben).
- ▶ Den Betriebsmodus "RUN" öffnen und die Tasten "SET" und "OK" länger als 3 Sekunden drücken, bis "IMMOBILIZER" angezeigt wird.

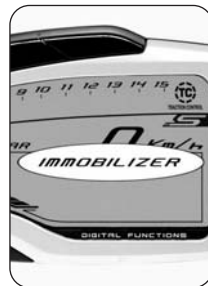

**ACHTUNG**

Änderungen oder Einstellungen an den Displayfunktionen müssen bei ausgeschaltetem Motor, Schaltung in Leerlauf, angehaltenem Motorrad und Füßen auf dem Boden ausgeführt werden. Eine Änderung der Displayeinstellungen während der Fahrt ist verboten.

- ▶ Die Taste "OK" kürzer als 3 Sekunden drücken, um die erste Ziffer des Code einzugeben.
- ▶ Wird die Taste "OK" kürzer als 3 Sekunden gedrückt, kann der Wert für die erste Ziffer zwischen **0** und **9** eingestellt werden.
- ▶ Ist die gewählte Ziffer richtig eingestellt worden, die Taste "OK" länger als 3 Sekunden gedrückt halten. Auf diese Weise wird die erste Ziffer des Code bestätigt. Jetzt kann die zweite Ziffer des Code eingegeben werden.
- ▶ Auf die gleiche Weise wie bei der ersten Ziffer können auch die restlichen vier Ziffern eingegeben werden.

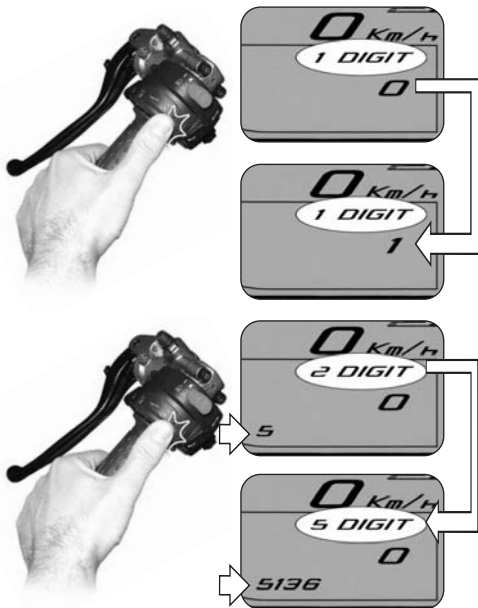



► Nach Abschluss des Verfahrens für die Code-Eingabe erscheint am Display die Meldung "CONFIRM CODE". Die Taste "OK" länger als 3 Sekunden gedrückt halten, um den eingegebenen Code zu bestätigen.

► Wird der eingegebene Code richtig vom System erkannt, erscheint die Meldung "VALID CODE". Das Armaturenbrett-Display stellt sich auf die Betriebsmodalität "RUN" zurück. Der Motor kann gestartet werden.

► Ist ein falscher Code eingegeben worden, erscheint die Meldung "NOT VALID CODE". Das System gibt keine Starfreigabe für den Motor. Das Armaturenbrett-Display stellt sich auf die Betriebsmodalität "IMMOBILIZER" zurück. Das Verfahren für die Code-Eingabe von Anfang an wiederholen. Darauf achten, dass alle auf der MV Code Card angegebenen Ziffern richtig eingegeben werden. Sollten weitere Probleme auftreten, bitte einen autorisierten MV Agusta Kundendienst benachrichtigen.

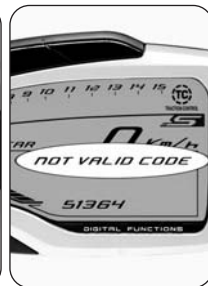
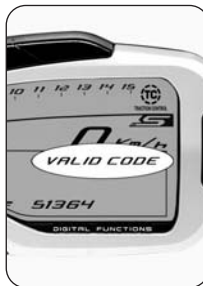
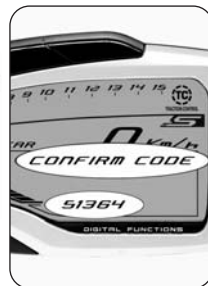



4.4.10. Auswahl Mapping Motorsteuerung

Bei dem Modell F4 RR ist es möglich unterschiedliche Mappings der Motorsteuerung auszuwählen, um die Fahreigenschaften des Motorrads den jeweiligen Fahrsituationen anzupassen.

ANMERKUNG

Auswahl der Mapping kann während der Fahrt eingestellt oder geändert werden.

Das Mapping kann durch Drücken des Anlasserknopfs bei laufendem Motor umgeschaltet werden. Die unterschiedlichen Mappings werden in der unten aufgeführten Reihenfolge nacheinander aufgerufen.

Mapping	N	R	S	C
Modus	Normal	Regen	Sport	Individuell

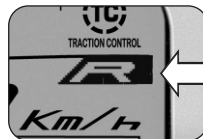
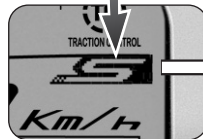



□ Einstellen des individuellen Mappings

▶ Drücken Sie den Anlasserknopf bei laufendem Motor bis Mapping "C" im Display angezeigt wird.



ACHTUNG!

Änderungen oder Einstellungen an dem individuellen Mapping müssen im Leerlauf bei stehendem Motorrad und Füßen auf dem Boden ausgeführt werden. Ändern Sie das Mapping nicht während der Fahrt.

▶ Drücken Sie "SET" bis "SETTING C MAP" erscheint.

Um die individuellen Parameter an Ihre Bedürfnisse anzupassen führen Sie bitte folgende Schritte durch.

▶ *Sensibilität Gasgriff*: Drücken Sie "OK" für weniger als drei Sekunden bis "GAS SENSITIVITY" angezeigt wird.





► Drücken Sie "SET" für weniger als drei Sekunden.
Die aktuelle Einstellung der Sensibilität des Gasgriffs
wird im Display angezeigt.



► Drücken Sie "OK" für weniger als drei Sekunden und
die Anzeige beginnt zu blinken.

► Durch wiederholtes Drücken der Taste "OK" werden
die folgenden Einstellmöglichkeiten nacheinander
angezeigt:

- "NORMAL" (Normal)
- "RAIN" (Regen)
- "SPORT" (Sport)

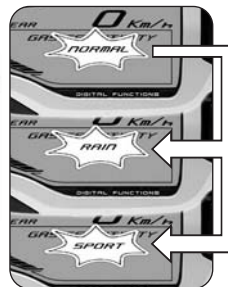



► Drücken Sie "OK" für mehr als drei Sekunden um die gewählte Einstellung zu bestätigen. Die Anzeige hört auf zu blinken und schaltet nach ein paar Sekunden zurück zu "GAS SENSITIVITY". Jetzt kann mit der Einstellung der nächsten Parameter fortgefahren werden.



► *Maximales Drehmoment:* Drücken Sie "OK" für weniger als drei Sekunden bis "MAX ENGINE TORQUE" angezeigt wird.

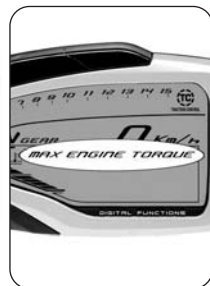



► Drücken Sie "SET" für weniger als drei Sekunden.
Die aktuelle Einstellung des maximalen Drehmoments
wird im Display angezeigt.

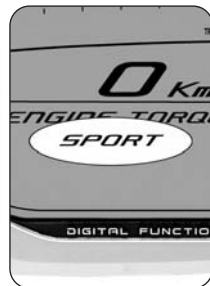

► Drücken Sie "OK" für weniger als drei Sekunden und
die Anzeige beginnt zu blinken.

► Durch wiederholtes Drücken der Taste "OK" werden
die folgenden Einstellmöglichkeiten nacheinander
angezeigt:

- "SPORT" (Sport)
- "RAIN" (Regen)





► Drücken Sie "OK" für mehr als drei Sekunden um die gewählte Einstellung zu bestätigen. Die Anzeige hört auf zu blinken und schaltet nach ein paar Sekunden zurück zu "MAX ENGINE TORQUE".

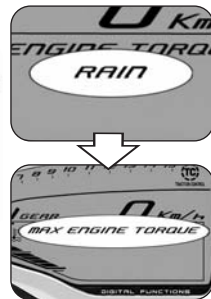

► *Motorbremse:* Drücken Sie "OK" für weniger als drei Sekunden bis "ENGINE BRAKE" angezeigt wird.

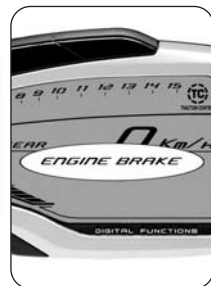



► Drücken Sie "SET" für weniger als drei Sekunden. Die aktuelle Einstellung der Motorbremse wird im Display angezeigt.



► Drücken Sie "OK" für weniger als drei Sekunden und die Anzeige beginnt zu blinken.

► Durch wiederholtes Drücken der Taste "OK" werden die folgenden Einstellmöglichkeiten nacheinander angezeigt:

- "NORMAL" (Normal)
- "SPORT" (Sport)

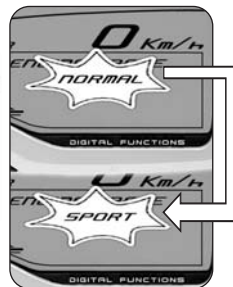



► Drücken Sie "OK" für mehr als drei Sekunden um die gewählte Einstellung zu bestätigen. Die Anzeige hört auf zu blinken und schaltet nach ein paar Sekunden zurück zu "ENGINE BRAKE".

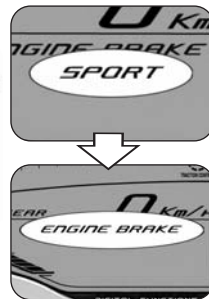

► *Ansprechverhalten des Motors:* Drücken Sie "OK" für weniger als drei Sekunden bis "ENGINE RESPONSE" angezeigt wird.





► Drücken Sie "SET" für weniger als drei Sekunden. Die aktuelle Einstellung des Ansprechverhaltens des Motors wird im Display angezeigt.



► Drücken Sie "OK" für weniger als drei Sekunden und die Anzeige beginnt zu blinken.

► Durch wiederholtes Drücken der Taste "OK" werden die folgenden Einstellmöglichkeiten nacheinander angezeigt:

- "SLOW RESPONSE" (Langsame Ansprechverhalten des Motors)
- "FAST RESPONSE" (Schnelle Ansprechverhalten des Motors)





► Drücken Sie "OK" für mehr als drei Sekunden um die gewählte Einstellung zu bestätigen. Die Anzeige hört auf zu blinken und schaltet nach ein paar Sekunden zurück zu "ENGINE RESPONSE".



► *Drehzahlbegrenzer:* Drücken Sie "OK" für weniger als drei Sekunden bis "RPM LIMITER" angezeigt wird.





► Drücken Sie "SET" für weniger als drei Sekunden.
Die aktuelle Einstellung des Drehzahlbegrenzers wird im Display angezeigt.



► Drücken Sie "OK" für weniger als drei Sekunden und die Anzeige beginnt zu blinken.

► Durch wiederholtes Drücken der Taste "OK" werden die folgenden Einstellmöglichkeiten nacheinander angezeigt:

- "NORMAL" (Normal)
- "SPORT" (Sport)





► Drücken Sie "OK" für mehr als drei Sekunden um die gewählte Einstellung zu bestätigen. Die Anzeige hört auf zu blinken und schaltet nach ein paar Sekunden zurück zu "RPM LIMITER".

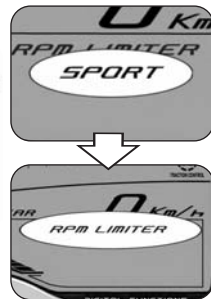

► Drücken Sie "OK" für weniger als drei Sekunden und das Display schaltet in den "RUN" Betriebsmodus zurück. Die Einstellung des individuellen Mappings ist abgeschlossen.





4.4.11. Warnung / Störmeldung

Das Instrumentenausrüstung kann das Vorhandensein eines Störungs während der verschiedenen Bedingungen von die Verwendung des Motorrades zeigen.

► *Starten des Motors:* Wird der Zündschalter auf "ON" gedreht, wird von den Instrumenten und den Kontrolllampen eine Autodiagnose ausgeführt. Wenn die Autodiagnose erkennt eine Störung am Fahrzeug, das Display zeigt die Warnung in der gezeigten Bild. Insbesondere das Display zeigt die Teil des Motorrads, auf denen das Störung festgestellt wurde.

► Die Taste "OK" drücken, bis die Funktion "RUN" angezeigt wird.



ACHTUNG

Wird ein Störung am Fahrzeug erkannt wird, nicht den Motor starten und einen autorisierten MV Agusta Kundendienst benachrichtigen.





► *Fahren des Fahrzeugs:* Wenn ein Störung während der Fahrt entdeckt wird, den unteren Teil des Displays dargestellt die Warnung in der Abbildung.

**ACHTUNG**

Wenn ein Störung während der Fahrt festgestellt, das Fahrzeug zu stoppen und einen autorisierten MV Agusta Kundendienst benachrichtigen.

► Wenn das Fahrzeug gestoppt wird, das Display zeigt die Teil des Motorrads, auf denen das Störung festgestellt wurde.



4 DE





► *Hohe Kühflüssigkeitstemperatur:* Wenn eine hohe Kühflüssigkeitstemperatur erkannt wird, das Display zeigt die Warnung in der gezeigten Bild. Diese Warnung kann bei jeder Bedingung von die Verwendung des Fahrzeugs angezeigt.

**ACHTUNG**

Bei hoher Temperatur das Fahrzeug anhalten und den Kühflüssigkeitsstand kontrollieren. Muss nachgefüllt werden, wenden Sie sich bitte an einen autorisierten MV Agusta Kundendienst (siehe § 3.8). Erscheint die Anzeige auch bei richtigem Kühflüssigkeitsstand, nicht weiterfahren und einen autorisierten MV Agusta Kundendienst benachrichtigen.





4.5. Tanken



Gefahr - Achtung: Benzin und Benzindämpfe sind leicht entzündbar und giftig. Kontakt mit Benzin und Einatmen vermeiden. Beim Tanken den Motor abschalten und nicht rauchen, offene Flammen und Hitzequellen fernhalten. Im Freien oder in gut belüfteten Räumen tanken.



Vorsicht - Vorsichtsmassnahme: Ausschließlich bleifreies und alkoholfreies Superbenzin mit einer Oktanzahl (R.O.N.) von 95 oder mehr tanken. Der grüne Punkt auf der unteren Seite der Behälterkappe und das Abziehbild auf dem Tank dienen als Anzeige für den Gebrauch des bleifreien Benzins.

- ▶ Den Staubschutzdeckel anheben.
- ▶ Den Schlüssel in das Schloß stecken, in Uhrzeigersinn drehen und den Tankdeckel anheben.
- ▶ Nach dem Tanken den Tankdeckel nach unten drücken und gleichzeitig den Schlüssel in Uhrzeigersinn drehen. Den Schlüssel loslassen und abziehen.



**ACHTUNG**

Wird der Tank bis zum Rand gefüllt, kann Benzin austreten, das sich das Benzin durch Sonneneinwirkung oder die Motorwärme ausdehnen kann. Bei austretendem Benzin besteht Brandgefahr. Der Benzinstand darf nie über dem Ende des Einfüllstutzens stehen.



Vorsicht - Vorsichtsmassnahme: Eventuelle ausgetropftes Benzin sofort mit einem sauberen Lappen abwischen, andernfalls können Lack oder Plastikteile beschädigt werden.

**ACHTUNG**

Vorm Losfahren prüfen, ob der Tankdeckel richtig verschlossen ist.





4.6. Zugang zum Staufach

- ▶ Den Schlüssel ins Schloss einstecken.
- ▶ Auf das Ende der Beifahrer-Sitzbank drücken und gleichzeitig den Schlüssel in Uhrzeigersinn drehen.
- ▶ Das Ende der Beifahrer-Sitzbank anheben, die Sitzbank nach vorne schieben und herausziehen.

Zum Wiederaussetzen des Beifahrersitzes sind folgende Punkte zu berücksichtigen:

- Den Schlüssel im Schloss drehen
- Den Fahrersitz nach unten drücken
- Den Schlüssel loslassen
- Den Sitz wiederum nach unten drücken und nachprüfen ob er an der Struktur fest befestigt ist.



ACHTUNG

Nach Demontage oder Abhebung des Beifahrer-Sitzbank und vor jedem Motorrad Einsatz muss man sich vergewissern, dass dieser Bauteil korrekt angebracht und an der Tragstruktur des Fahrzeuges gut befestigt ist.



4.7. Parken des Motorrads

☐ Parken auf dem Seitenständer



VORSICHT

- Das Motorrad stets sicher auf festem Untergrund abstellen.
- Beim Parken auf abschüssigem Gelände das Vorderrad bergauf stellen und den ersten Gang einlegen. Vorm Starten muss wieder der Leerlauf eingelegt werden.
- Niemals den Zündschlüssel stecken lassen, wenn das Fahrzeug unbeaufsichtigt ist.

- ▶ Den Seitenständer mit dem Fuß bis zum Anschlag ausklappen und das Motorrad langsam neigen, bis der Ständerfuß auf dem Untergrund fest aufliegt.

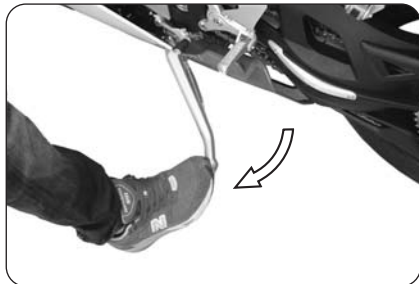

**ACHTUNG**

Wird das Motorrad zum Parken auf den Seitenständer gestellt, ist es gefährlich sich auf das Fahrzeug zu setzen, da das gesamte Gewicht nur auf dem Seitenständer aufliegt.

**ACHTUNG**

Vorm Losfahren die Funktion des Sicherheitsschalters prüfen. Die Kontrolllampe am Armaturenbrett für den abgeklappten Seitenständer muss sich ausschalten. Auf jeden Fall prüfen, dass der Seitenständer richtig hochgeklappt ist.

Wird eine Störung bemerkt, muss die Anlage vor Fahrtantritt bei einem MV Agusta Vertragshändler überprüft werden.

□ Parken auf dem hinteren Ständer

Den Zapfen des Ständer von der linken Fahrzeugseite aus in die Öffnung an der Radachse stecken. Den Ständer auf den Boden stellen, festhalten und das Fahrzeug soweit anheben, bis es sicher steht.

**VORSICHT**

Dieser Vorgang muss von zwei Personen zusammen ausgeführt werden.





5.1. Liste der Einstellungsarbeiten

Das Motorrad bietet eine breite Auswahl von Einstellungsmöglichkeiten, die Ergonomie, die Sitzposition und die Sicherheit verbessern können.

Da eine falsche Einstellung von wichtigen Komponenten eine Gefahrenquelle darstellen kann, dürfen einige dieser Einstellungen nur von einer MV Agusta-Vertragswerkstatt vorgenommen werden.



ACHTUNG

Alle Einstellungsarbeiten müssen bei stehendem Fahrzeug vorgenommen werden.





(F) Einstellung Rückspiegel (§5.5.)

(A) Einstellung Kupplungshebel (§5.4.)

(F) Einstellung Rückspiegel (§5.5.)

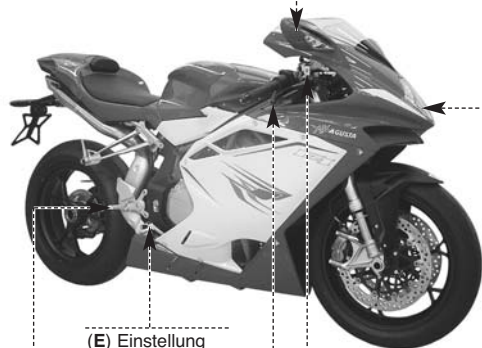

(E) Einstellung
Bremspedal
Hinterradbremse
(§5.2.)

(C) Einstellung rechte
Fußraste (§5.2.)

(B) Einstellung Bremshebel Vorderradbremse (§5.3.)

(G) Einstellung Lenkungsdämpfer (§4.4.6.)

(D) Einstellung Schaltpedal (§5.2.)

(L) Einstellung hintere
Federung (§4.4.6.)



(N) Einstellung
Scheinwerfer (§5.9.)

(H) Einstellung vordere
Federung (§5.6. und §4.4.6.)













(M) Einstellung
Kette (§5.2.)

(C) Einstellung linke
Fußraste (§5.2.)





5.2. Tabelle der Einstellungsarbeiten

	A - Einstellung Kupplungshebel: Bessere Einstellung des Kupplungshebels auf die persönlichen Anforderungen des Fahrers (§5.4).		H - Einstellung vordere Federung: Um die Federung an den persönlichen Fahrstil anzupassen, gibt es folgende Einstellmöglichkeiten: <ul style="list-style-type: none">- Federvorspannung (§5.6.1.)- Zugstufendämpfung (§4.4.6.)- Druckstufendämpfung (§4.4.6.)
	B - Einstellung Bremshebel Vorderradbremse: Bessere Einstellung des Bremshebels auf die persönlichen Anforderungen des Fahrers (§5.3).		
	C - Einstellung der Fußrasten (rechts und links): Bessere Einstellung des Fußrasten auf die persönlichen Anforderungen des Fahrers.		
	D - Einstellung Schaltpedal: Bessere Einstellung des Schaltpedals auf die persönlichen Anforderungen des Fahrers.		L - Einstellung hintere Federung: Um die Federung an den persönlichen Fahrstil anzupassen, gibt es folgende Einstellmöglichkeiten: <ul style="list-style-type: none">- Höhe Sitzposition- Federvorspannung
	E - Einstellung Bremspedal Hinterradbremse: Bessere Einstellung des Bremspedals auf die persönlichen Anforderungen des Fahrers.		<ul style="list-style-type: none">- Zugstufendämpfung (§4.4.6.)- Druckstufendämpfung (§4.4.6.)
	F - Einstellung Rückspiegel: Zur besseren Einstellung (§5.5).		M - Einstellung Kette: Für Funktion und Sicherheit des Antriebs.
	G - Einstellung Lenkungsämpfer: Einstellung der Dämpfung auf die persönlichen Anforderungen des Fahrers (§4.4.6.).		N - Einstellung Scheinwerfer: Um den Lichtstrahl des Scheinwerfers entsprechend der Sitzposition einzustellen (§5.7).





5.3. Einstellung Bremshebel Vorderradbremse

Die Hebelposition durch Drehen der Nutmutter einstellen. Drehen in Uhrzeigersinn: der Hebel entfernt sich vom Handgriff. Drehen gegen den Uhrzeigersinn: der Hebel nähert sich an den Handgriff an.

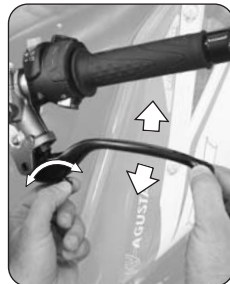

5.4. Einstellung Kupplungshebel

Die Hebelposition durch Drehen der Nutmutter einstellen. Drehen in Uhrzeigersinn: der Hebel entfernt sich vom Handgriff. Drehen gegen den Uhrzeigersinn: der Hebel nähert sich an den Handgriff an.

5.5. Einstellung Rückspiegel

Zur Einstellung des Rückspiegels an den vier in der Abbildung gezeigten Stellen drücken.

Die Einstellung beider Rückspiegel durchführen. Zur Durchführung einer korrekten Rückspiegeleinrichtung ist es ratsam auf das Motorrad zu steigen.

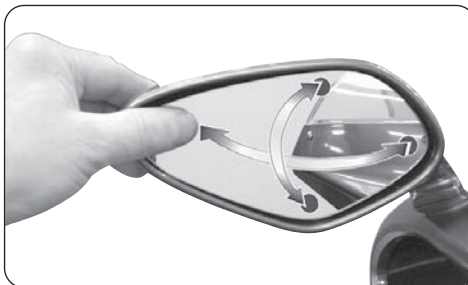



5.6. Einstellung vordere Federung

ANMERKUNG

Die Einstellung der Federungen muß vorzugsweise mit dem Benzintank volle durchgeführt werden.

ANMERKUNG

Für die Einstellung der Zugstufen- und Druckstufendämpfung, beziehen an die Verfahren in §4.4.6. beschrieben.

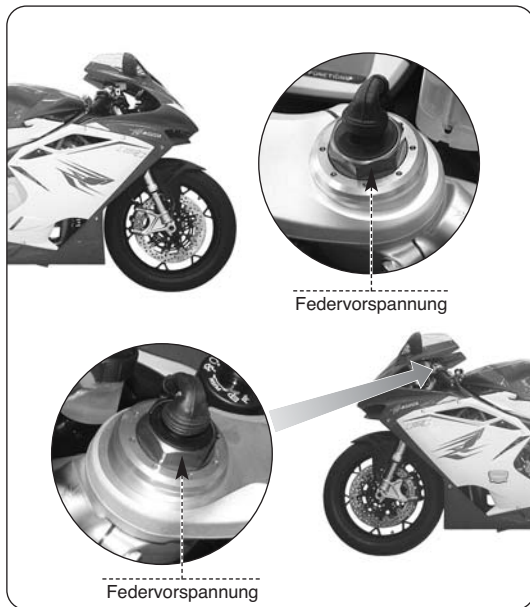



5.6.1. Federvorspannung (Vorderradfederung)

► Um die Einstellmutter der Federvorspannung zuzugreifen, den Schutzhülle aufheben und den Stecker mit einem flachen Schraubenzieher lösen.

► Für die Einstellarbeiten muß von der Standardeinstellung ausgegangen werden. Um die Standardeinstellung zu erreichen, gegen den Uhrzeigersinn bis zum Anschlag drehen, anschließend in Uhrzeigersinn bis Standardposition (siehe Tabelle) drehen. In Uhrzeigersinn drehen um die Federvorspannung zu erhöhen, gegen den Uhrzeigersinn drehen, um die Federvorspannung abzuschwächen.

► Wenn die Einstellarbeiten abgeschlossen sind, den Stecker schließen und den Schutzhülle ersetzen.





5.7. Scheinwerfereinstellung

Das Fahrzeug auf ebenem Untergrund in einem Abstand von 10 m vor eine Wand stellen. Das Fahrzeug muss aufrecht senkrecht zur Wand stehen. Den Abstand zwischen Scheinwerfermitte und Boden messen. Den Wert an der Wand mit einem Kreuz anzeichnen. Den Scheinwerfer einschalten und Fahrlicht einstellen. Den Lichtstrahl so einstellen, dass sich die Hell-Dunkel- Linie 9/10 unterhalb der an der Wand angebrachten Linie befindet.

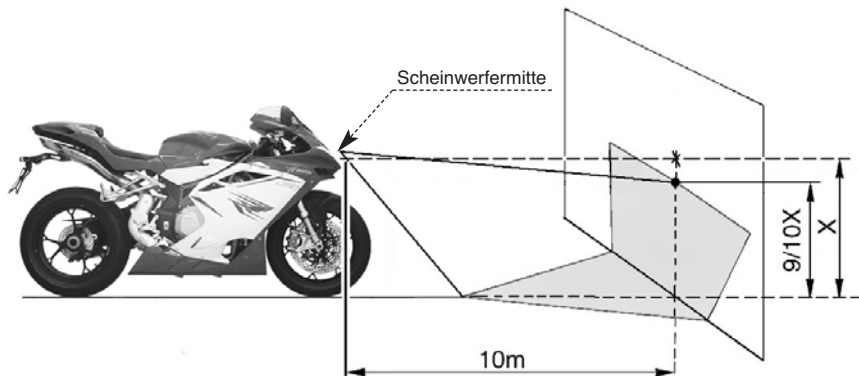



Die Höheneinstellung des Scheinwerfers kann über die nebenstehend abgebildete Schraube vorgenommen werden. In Uhrzeigersinn: Der Scheinwerfer wird nach oben geneigt. Gegen den Uhrzeigersinn: Der Scheinwerfer wird nach unten geneigt. Die Neigung kann um $\pm 4^\circ$ in Bezug auf die Standard-Position geändert werden.

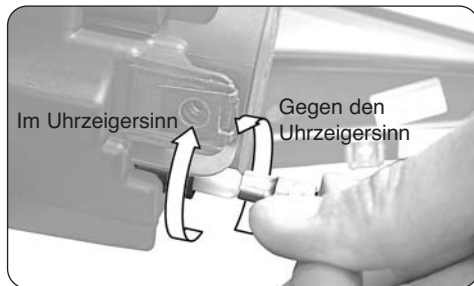



AUFMERKUNG



Informationshinweis

MV Agusta S.p.A. verfolgt eine Politik ständiger Verbesserung ihrer Produkte. Aus diesem Grund kann es vorkommen, dass kleine Abweichungen zwischen dem vorliegenden Dokument und dem von Ihnen erworbenen Fahrzeug bestehen. Die Modelle MV Agusta werden in zahlreiche Länder exportiert, in denen unterschiedliche Straßenverkehrsordnungen und Zulassungsverfahren bestehen. In der Hoffnung auf Ihr Verständnis behält sich MV Agusta S.p.A. deshalb das Recht vor, jederzeit und ohne Vorankündigung, Änderungen an ihren Produkten und den technischen Dokumentationen vorzunehmen.

Wir schlagen vor, um den Internetplatz www.mvagusta.it häufig zu besichtigen, um Informationen und Updates über die MV Agusta-Produkte und die in Verbindung stehenden Unterlagen zu erhalten.



Die Umwelt schützen und respektieren

Alles was wir tun hat Auswirkungen auf den gesamten Planeten und seine Ressourcen. Zum Schutz der Gemeinschaft weist MV Agusta die Kunden und die Angestellten im Kundendienst darauf hin, wie das Motorrad umweltschonend genutzt und Motorradbauteile und Flüssigkeiten entsprechend der geltenden Umweltschutzgesetze entsorgt bzw. dem Recycling zugeführt werden können.

© 2012

Die vollständige oder teilweise Vervielfältigung dieses Dokuments ist ohne vorherige schriftliche Genehmigung der MV Agusta S.p.A. verboten.

Teilnr. 8000B7637

Ausgabe Nr. 1 - November 2012



MV AGUSTA



Manual de uso
Versión en Español



Estimado cliente,

Le agradecemos la confianza que nos ha otorgado y le felicitamos por su nueva F4 RR.

Su elección premia el compromiso y el esfuerzo hecho con pasión por nuestros técnicos que han dado a la F4 RR características funcionales y estéticas que la sitúan por encima de las motos de más alto nivel hoy en el mercado, convirtiéndola en un objeto codiciado y exclusivo.

Si desde el punto de vista puramente técnico la F4 RR representa, con sus innumerables innovaciones, un punto de referencia a nivel mundial, su línea sin tiempo, suave y aerodinámica, es una espléndida fusión entre un glorioso pasado y un nuevo milenio.

La unión de estos elementos, que sólo la búsqueda del detalle, la pasión y el deseo de realizar una moto técnicamente y estéticamente superior han permitido lograr, pone a la F4 RR por encima de cualquier moda pasajera, dándole así el privilegio de ser considerada un objeto único en el mundo.

Si desea más información, no dude en ponerse en contacto con el Servicio de Asistencia Clientes de MV Agusta.

¡Buena diversión!

*Giovanni Castiglioni
Presidente
MV Agusta*



ÍNDICE GENERAL

<i>Cap.</i>	<i>Descripción temas</i>	<i>pág.</i>	<i>Cap.</i>	<i>Descripción temas</i>	<i>pág.</i>
1	INFORMACIÓN GENERAL	5	4	USO	29
1.1.	Finalidad del manual	5	4.1.	Uso de la motocicleta	29
1.2.	Símbolos	6	4.2.	Rodaje	30
1.3.	Contenido del soporte digital	7	4.3.	Arranque del motor	32
1.4.	Datos de identificación	8	4.4.	Selección y modificación funciones display	35
2	INFORMACIÓN SOBRE LA SEGURIDAD	11	4.4.1.	Selección de las funciones de la pantalla	36
2.1.	Uso consentido del vehículo	11	4.4.2.	Reset de las funciones cuenta kilómetros parciales	41
2.2.	Mantenimiento	11	4.4.3.	Función "TC"	43
2.3.	Accesorios y modificaciones	12	4.4.4.	Cronómetro	44
2.4.	Carga vehículo	12	4.4.5.	Función "NIGHT/DAY"	53
3	MANDOS Y INSTRUMENTOS	14	4.4.6.	Regulación electrónica de las suspensiones	54
3.1.	Posición mandos y instrumentos	14	4.4.7.	Selección de la función ABS	58
3.2.	Caballote lateral	15	4.4.8.	Modalità "QUICK SHIFT"	60
3.3.	Mandos semimanillar izquierdo	16	4.4.9.	Función "IMMOBILIZER"	61
3.4.	Mandos semimanillar derecho	18	4.4.10.	Selección del mapeado de la central	64
3.5.	Interruptor encendido y bloqueo del manillar	21	4.4.11.	Mensajes de advertencia/error	76
3.6.	Mando cambio	24	4.5.	Abastecimiento combustible	79
3.7.	Instrumentos y testigos	25	4.6.	Acceso al hueco portaobjetos	81
3.7.1.	Testigos	26	4.7.	Inactividad de la motocicleta	82
3.7.2.	Pantalla multifunción	27			
3.8.	Tabla de lubricantes y líquidos	28			



ÍNDICE GENERAL

<i>Cap.</i>	<i>Descripción temas</i>	<i>pág.</i>
5	REGULACIONES	84
5.1.	Lista regulaciones	84
5.2.	Tabla de las regulaciones	86
5.3.	Regulación de la palanca del freno delantero	87
5.4.	Regulación de la palanca de embrague	87
5.5.	Regulación de los espejos retrovisores	87
5.6.	Regulación de la suspensión delantera	88
5.6.1.	Precarga muelle (suspensión delantera)	89
5.7.	Ajuste proyector delantero	90



1.1. Finalidad del manual

El presente manual proporciona toda la información necesaria para un uso correcto y seguro de la moto.

Junto al manual se entrega también un “Quick Manual” de bolsillo, con una síntesis esencial de la información necesaria para el uso del vehículo.

El manual se entrega también en formato electrónico (.pdf) sobre el soporte digital en el equipamiento base y puede ser impreso o visualizado en cualquier ordenador, ya sea en sistema Windows que Macintosh.

Le recomendamos leer atentamente el manual antes de utilizar la moto y cerciorarse de cualquier otra persona que la use haya hecho lo mismo.

Por último, le aconsejamos llevar siempre con Usted el “Quick Manual” y de rellenarlo con los datos identificativos suyos y de la motocicleta.



Copyright
MV AGUSTA Motor Spa
Todos los derechos reservados





1.2. Símbolos

Las partes del texto de particular importancia, correspondientes a la seguridad de la persona y a la integridad de la motocicleta, están evidenciadas con los siguientes símbolos:



Peligro - Atención: la falta o el incompleto cumplimiento de estas prescripciones puede comportar un grave peligro para su incolumidad o para la de otras personas.



Prudencia - Precaución: la falta o el incompleto cumplimiento de estas prescripciones puede comportar un riesgo de daños a la motocicleta.

Para indicar las personas autorizadas al desarrollo de las operaciones de ajustes y/o mantenimiento, las mismas se encuentran marcadas con los símbolos siguientes:



Información de las operaciones permitidas al motociclista.



Información de las operaciones que deben ser llevadas a cabo sólo por personal autorizado.

Para poner en evidencia ulteriores informaciones se utilizan los siguientes símbolos:



El símbolo  indica que es necesario utilizar una herramienta o utillaje específico para realizar correctamente la operación descrita.



El símbolo “§” indica que nos remitimos al capítulo indicado por el número que lo sigue.





1.3. Contenido del soporte digital

En el soporte digital proporcionado Usted podrá encontrar, además de este manual, el Manual de Mantenimiento, el “Quick Manual” (del que también se entrega una versión impresa), la Guía de las Concesionarias y el Folleto de la Garantía.

Al momento de la entrega de la motocicleta, su Concesionario le habrá entregado también el Certificado de Garantía y Pre-Entrega.

Le rogamos conservarlo junto con los documentos de la moto y los futuros cupones de mantenimiento que recibirá cada vez que realice las intervenciones programadas.

IMPORTANTE

Las copias del Certificado de Garantía y Pre-entrega deben ser rellenas por el Concesionario. Una copia debe ser entregada al Cliente, una se debe mantener por el Concesionario y una debe ser enviada al Importador.

Las copias de los cupones de manutención recomendada deben ser rellenas siempre por los Concesionarios. Deben ser guardadas por el Cliente y el Concesionario.





2) número de matrícula motor



1) número de matrícula del chasis

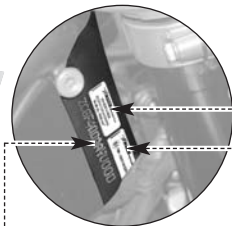

3) datos de homologación

1.4. Datos de identificación

- 1) número de matrícula chasis
- 2) número de matrícula motor
- 3) datos de homologación

► Identificación motocicleta

La motocicleta está identificada por el número de matrícula del chasis. Para pedir piezas de recambio, además de este número, puede ser necesario indicar el número de matrícula del motor, el código del color y el número de identificación de la llave.

Se recomienda anotar los datos principales en los siguientes espacios:

CHASIS N.: _____

MOTOR N.: _____





► **Identificación de la llave de la motocicleta**

Se suministran dos llaves, una llave se utiliza sea para el arranque para accionar las cerraduras. Guarde en un lugar seguro la llave de reserva.

Tener conocimiento del número de identificación de la llave es indispensable en el caso sea necesario pedir un duplicado de la llave como recambio. El número de identificación de la llave esta impreso sobre la MV Code Card que viene junto con las llaves de arranque.



1 ES

► **Identificación combinación colores motocicleta**

El código del color es indispensable para pedir las piezas de recambio de la carrocería. El mismo puede ser leído en la placa colocada en el lado inferior derecha del deposito gasolina.

Para acceder a la placa del código color, es necesario quitar el lateral deposito derecho. Saque la parte posterior del lateral deposito derecho según lo demostrado en la figura.





ES 1

Quite el lateral deposito derecho tirando de él hacia la parte posterior de la motocicleta.



Después de haber quitado el lateral deposito izquierdo, se pueda ver la placa con el código color. En ésta placa es posible conocer el código del color de la motocicleta, el cual determina el color de las partes de la carrocería.

Se aconseja anotar el código color de la motocicleta en el espacio siguiente:

CÓDIGO COLOR:





2.1. USO CONSENTIDO DEL VEHÍCULO

Su motocicleta ha sido proyectada para transitar exclusivamente por carreteras y autopistas.



ATENCIÓN

Saltuariamente es posible utilizar la motocicleta en pistas, pero en ocasiones que no prevean la competición. Sin embargo, a causa del mayor esfuerzo al que se somete la moto en tales ocasiones, en ese caso se recomienda hacer controlar las condiciones del vehículo por un Centro de Asistencia MV Agusta antes y después del uso. Cualquier otro uso está prohibido y expresamente excluido.

Para más información acerca del uso de la moto, consulte la sección 4 del presente manual.

2.2. MANTENIMIENTO

A fin de garantizar la máxima eficiencia y fiabilidad del vehículo, es esencial efectuar las intervenciones de mantenimiento previstas en el Manual de Mantenimiento.

MV Agusta recomienda que todas las operaciones de mantenimiento sean efectuadas exclusivamente por personal especializado perteneciente a un Centro de Asistencia MV Agusta.

En caso de que Usted decida efectuar las intervenciones de mantenimiento en otros talleres, deberá constatar que los mismos cuenten con la capacidad y los instrumentos específicos necesarios para la ejecución de tales operaciones.



ATENCIÓN

La garantía MV Agusta puede perder validez en caso de que otros talleres hayan efectuado intervenciones no conformes con las previstas en las Circulares Técnicas y los Manuales de Taller MV Agusta.





2.3. ACCESORIOS Y MODIFICACIONES



ATENCIÓN

MV Agusta prohíbe aportar cualquier tipo de modificación a sus motocicletas. Ello es necesario para tutelar la seguridad de sus Clientes.

De todos modos, Usted puede personalizar su motocicleta utilizando los artículos del vasto Catálogo de Accesorios MV Agusta.



ATENCIÓN

La instalación de algunos de estos accesorios puede invalidar la homologación de la moto y, por ende, comprometer su posibilidad de tránsito por las vías públicas.

En caso de dudas, le aconsejamos recurrir a su Concesionario MV Agusta de confianza para decidir cuáles son los accesorios más adecuados a sus propias exigencias.



2.4. CARGA DEL VEHICULO

El vehículo ha sido proyectado para ser usado por parte del piloto y de un eventual pasajero. Para utilizarlo en plena seguridad y respetando las normas del código de la circulación es obligatorio no superar nunca la masa máxima técnicamente admisible del vehículo, el cual valor es indicado a continuación:

F4 RR:

Masa máxima técnicamente admisible:
378 kg

Masa de la carga máxima:
165 kg

La masa máxima técnicamente admisible representa la adición de las siguientes masas:

- masa de la motocicleta;
- masa del piloto;
- masa del pasajero;
- masa del equipaje y de los accesorios.

**ATENCIÓN**

Considerado que la carga tiene una enorme importancia en la manejabilidad, la frenada, el rendimiento y las características de seguridad de vuestro vehículo, tener presente siempre las siguientes precauciones.

- **NO SOBRECARGAR NUNCA EL VEHICULO!** La utilización de una moto sobre cargada puede provocar daños a los neumáticos, pérdida del control o graves accidentes. Comprobar que el peso total del piloto, del pasajero, de la carga y de los accesorios no supere el peso máximo especificado para la moto.





3.1. Posición mandos e instrumentos

ES 3

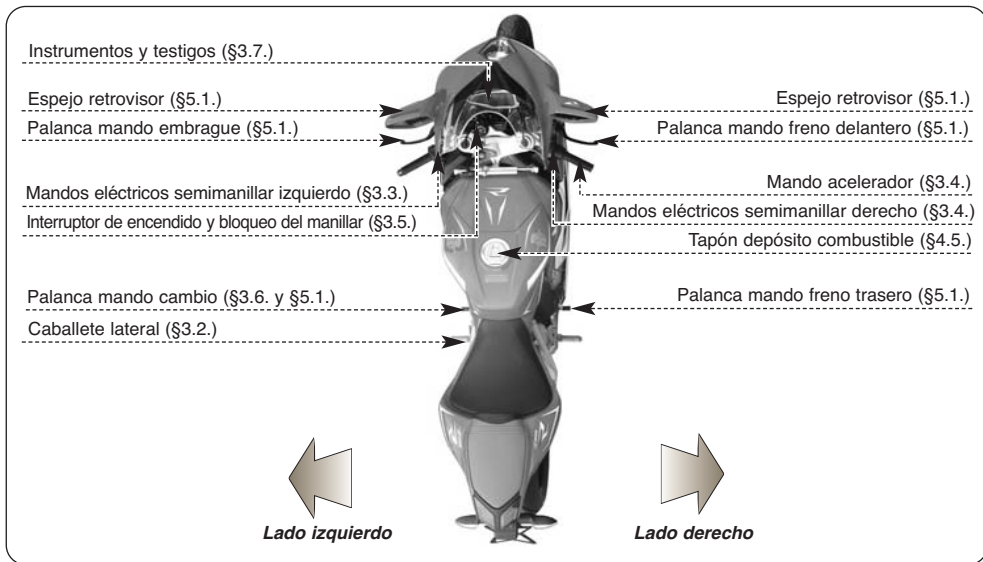



3.2. Caballete lateral

El caballete lateral está equipado con un interruptor de seguridad que impide a la moto de ponerse en marcha con el caballete bajado. En el caso que con el motor en marcha y con el caballete bajado, se acciona el cambio para salir, el interruptor corta la corriente al motor provocando la parada.

En el caso que la moto se encuentre estacionada (con el caballete abajo) y con una velocidad engranada, el interruptor impide el arranque del motor evitando el peligro de caída accidental del vehículo.

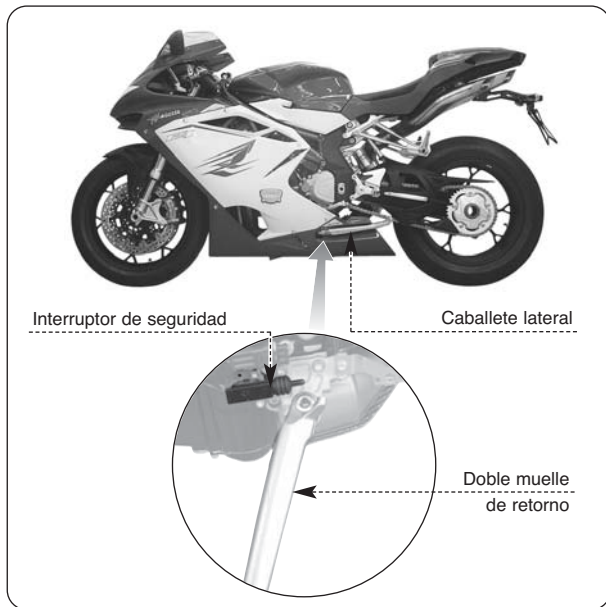



3.3. Mandos semimanillar izquierdo

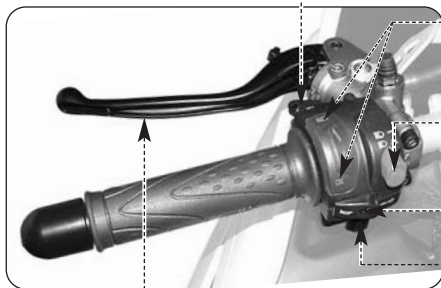

Pulsador centelleo faros

Apriete el pulsador repetidas veces.

Pulsador SET/OK

Apriete para modificar las funciones en el display (§ 4.4.).

Pulsador carretera/cruce

Pulsador hacia fuera ■ : cruce 

Pulsador hacia dentro ▬ : carretera 

Pulsador claxon

Apriete para activar el claxon.

Palanca indicadores de dirección

Desplazando la palanca hacia la derecha o hacia la izquierda se activan los indicadores de dirección derechos o izquierdos. La palanca regresa al centro; apriete para desactivar los indicadores.

Palanca embrague

Acercar o alejar de la manecilla para accionar el embrague.





Pulsador Destello Faro

Esta función sirve para llamar la atención de los demás en el caso de posible situaciones de peligro; con la luz de carretera encendida dicha función no se activa.

Pulsador De carretera/De cruce

Normalmente es activada la función luz de cruce; cuando las condiciones del tráfico y de recorrido lo permiten, puede ser activada la función luz de carretera actuando en el pulsador.

Pulsador del Claxon

Esta función sirve para llamar la atención de los demás conductores en el caso de posible condición de peligro.

Leva Indicadores de Dirección

Esta función permite señalar a los demás la intención de cambiar dirección o carril de marcha.



PELIGRO

No usar o no desactivar los indicadores de dirección en el momento oportuno puede provocar accidentes; los demás conductores podrían interpretar erróneamente el trayecto del vehículo. Accionar siempre los indicadores de dirección antes de girar o cambiar carril. Asegurarse después de desactivar los indicadores apenas efectuada dicha maniobra.

Palanca Embrague

Esta palanca, a través de un dispositivo controlado hidráulicamente, permite accionar el embrague.





3.4. Mandos semimanillar derecho

Interruptor stop motor

Si se acciona detiene el motor e impide su arranque.

Pulsador arranque motor

Apretado arranca el motor. Se debe soltar apenas arranca el motor. Con motor arrancado, apretándolo de nuevo, se selecciona el mapeado de la centralita (§4.4.10.).

Mando acelerador

Girar para regular la alimentación del motor.

Palanca freno delantero

Acercarse a la manecilla para accionar el freno delantero.

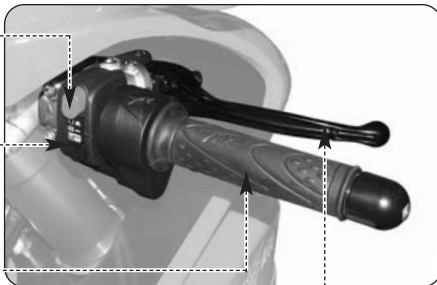



Interruptor Parada Motor

Esta función permite parar el motor en caso de emergencia; de ésta manera se desactiva el circuito de encendido impidiendo el arranque del motor. Para poder efectuar el arranque colocar nuevamente el pulsador en posición de descanso.

NOTA: En condiciones normales no utilizar éste dispositivo para parar el motor.

Pulsador Puesta en marcha del Motor

Este dispositivo permite la puesta en marcha del motor; además con el motor en marcha permite seleccionar el mapeado de la centralita según la función del display presente en la instrumentación de a bordo (ver § 4.4.10.).



PRUDENCIA - PRECAUCION

Para evitar daños a la instalación eléctrica no tener presionado el pulsador por mas de 5 segundos consecutivos. Si el motor no arranca después de varios tentativos, consultar el capítulo "AVERÍAS" en éste manual.

Mando Acelerador

Este dispositivo permite regular la alimentación del motor variando el régimen de rotación. Para accionar el dispositivo es necesario girar la manecilla en la posición de descanso, que corresponde al régimen de ralentí del motor.



ADVERTENCIA

Si su moto se ha caído o ha tenido un accidente, el funcionamiento del mando del acelerador debe ser revisado por un centro autorizado MV Agusta antes de volver a la conducción.





Palanca Freno Delantero

Este mando permite accionar a través de un circuito hidráulico la instalación de frenos de la rueda delantera.

❑ Sistema de antibloqueo de frenos (ABS) *

Algunos modelos F4 están equipados con un sistema asistido de frenado ABS ("Antilock Braking System"), que evita que las ruedas se bloqueen durante las frenadas de emergencia, lo que garantiza la estabilidad del vehículo y acorta la distancia de frenado.



ATENCIÓN

Cuando el sistema ABS está activado, algunas vibraciones podría ser perceptibles en la palanca de freno o en el pedal de freno. En este caso, se recomienda mantener presionados los dispositivos de accionamiento de los frenos, de modo que el vehículo puede completar el frenado.



ATENCIÓN

Si el sistema ABS tiene una avería o está desactivado, la luz de advertencia correspondiente en el tablero de instrumentos se enciende (ver § 3.7.1.). Desde este momento, el sistema de antibloqueo de frenos no podría estar disponible durante el frenado. Si hay una avería en el sistema ABS, se recomienda volver a la marcha a baja velocidad y contactar con un centro de servicio autorizado MV Agusta. Si el sistema ABS está desactivado, seguir el procedimiento de activación descrito en § 4.4.7.

(*): Función disponible sólo en algunos modelos





3.5. Interruptor de encendido y bloqueo del manillar



PELIGRO

No colocar llaveros u otros objetos en la llave de encendido para no crear obstáculos en la rotación de la dirección.



PELIGRO

No intentar cambiar la posición del interruptor durante la marcha; se podría perder el control del vehículo.

El interruptor de encendido activa y desactiva el circuito eléctrico y el bloqueo del manillar; las cuatro posiciones de mando se describen a continuación.

Posición "OFF"

Todos los circuitos eléctricos están desactivados. Se puede extraer la llave.

Posición "ON"

Todos los circuitos eléctricos están activados, los instrumentos y los testigos efectúan el autodiagnóstico; se puede arrancar el motor. La llave no se puede extraer.



"OFF"



"ON"



PRUDENCIA - PRECAUCION

No dejar la llave en la posición de "ON" por mucho tiempo con el motor apagado, para no dañar los componentes eléctricos de la motocicleta.





Posición "LOCK"

Gire el manillar a la derecha o a la izquierda. Empujar levemente la llave y al mismo tiempo girarla en posición "LOCK".

Todos los circuitos eléctricos están desactivados y el manillar está bloqueado. Se puede extraer la llave.

ES
3

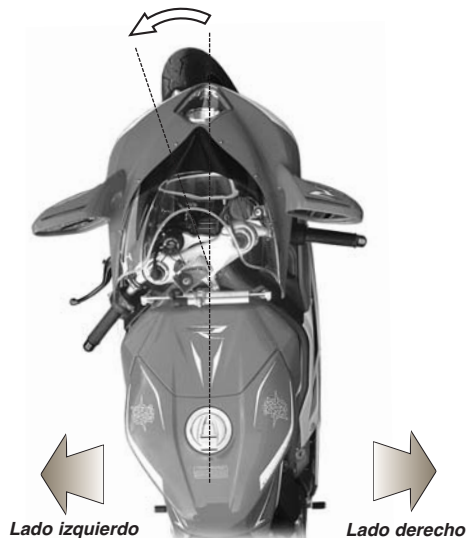



Posición “P”

Gire la llave de la posición “LOCK” a la posición “P”. Todos los circuitos eléctricos están desactivados excepto las luces de estacionamiento (luces de posición) y el manillar está bloqueado. Se puede extraer la llave.



PRUDENCIA - PRECAUCION

No dejar la llave en posición “P” por mucho tiempo, para evitar descargar la batería de la motocicleta.





3.6. Mando cambio

La posición **N** “Neutral” corresponde a la posición de punto muerto señalada por el correspondiente testigo en el cuadro mandos.

Desplazando la palanca del cambio hacia abajo se engrana la primera velocidad. De igual manera, desplazando la palanca hacia arriba se engrana la segunda; continuando varias veces a desplazar la palanca hacia arriba se engranan, en secuencia, todas las demás velocidades hasta la sexta.

❑ Función “Quick Shift”

El modelo F4 RR está equipado con un sistema de cambio rápido de velocidad (“Quick Shift”); este dispositivo permite de engranar las velocidades superiores sin tener que tirar el embrague o cambiar el ángulo del mando del acelerador. De esta manera, es posible engranar velocidades superiores manteniendo una aceleración constante y reduciendo el tiempo de cambio a un mínimo. El sistema “Quick Shift” no está disponible cuando se cambia velocidad con la palanca del embrague presionado, o a una velocidad inferior a 30 km/h, ni cuando se cambia a velocidades inferiores.

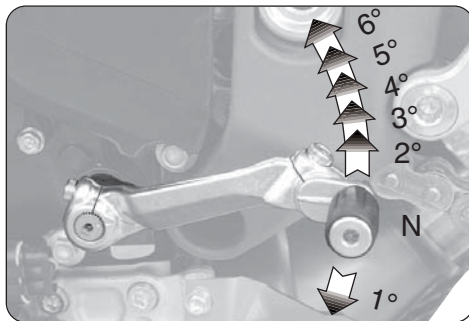

ADVERTENCIA: Durante la conducción del vehículo con el motor de altas revoluciones y en una marcha baja, cambiar la velocidad sin accionar la palanca del embrague puede causar reacciones bruscas, que pueden poner en peligro la estabilidad del vehículo. MV Agusta recomienda tirar la palanca de embrague en estas circunstancias, especialmente cuando la velocidad del motor está cerca de la velocidad de intervención del limitador.





3.7. Instrumentación y testigos

Los instrumentos y los testigos se activan girando la llave de encendido en posición "ON". Después de un check-up inicial (~7 segundos) la información que aparece corresponde a las condiciones generales de la motocicleta en ese momento.

Testigos (§3.7.1.)

Display taquímetro

Pulsador "HAZARD" (§3.7.2.)



Pulsador "SET"
(§3.7.2.)

Pulsador "OK"
(§3.7.2.)

Display multifunción (§3.7.2.)





3.7.1. Testigos

Testigo luz carretera (azul)

Se enciende cuando está activada la luz de carretera.

Testigo indicadores de dirección / Testigo "Hazard" (verde)

Se enciende cuando están activados los indicadores de dirección o las luces de emergencia (§3.7.2.).

Testigo cambio en punto muerto (verde)

Se enciende cuando el cambio está en la posición punto muerto "Neutral".

Testigo ABS (naranja) *

Se ilumina cuando el sistema ABS tiene una avería o está desactivado, o si la velocidad es inferior a 5 km/h.



Peligro - Cuidado: Si se ilumina durante la marcha, deténgase inmediatamente y compruebe que el sistema ABS está activado (ver §4.4.7.). En este caso, volver a la marcha a baja velocidad y contactar con un centro de servicio autorizado MV Agusta.

(*): Función disponible sólo en algunos modelos



Testigo presión aceite motor (rojo)

Se enciende cuando el aceite está a una presión insuficiente.



Peligro-Atención: Si se enciende durante la circulación, deténgase inmediatamente, controle el nivel del aceite y si es necesario hace efectuar el relleno por un centro de asistencia autorizado MV Agusta (ver §3.8.). Si el testigo se enciende a pesar de que el nivel es correcto, no siga circulando y póngase en contacto con un centro de asistencia autorizado MV Agusta.

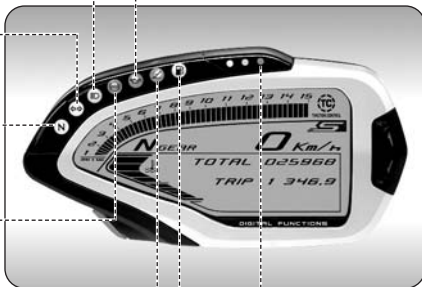

Testigo limitador de revoluciones (rojo)

Se enciende cuando el motor supera las 10800 rpm; el limitador interviene a 13500 rpm.

Testigo reserva combustible (naranja)

Se enciende cuando en el depósito hay aproximadamente cuatro litros de combustible.

Testigo apertura caballete lateral (rojo)

Se enciende cuando el caballete está bajado.



3.7.2. Display multifunción

Display relación de marcha

Indica la relación correspondiente a la marcha embragada. La letra "N" ("Neutral") indica que el cambio se encuentra en punto muerto.

Termómetro

El número de segmentos iluminados sobre una escala graduada le permitirá conocer la temperatura del líquido refrigerante. Cuando la temperatura se encuentre fuera del intervalo de valores normales admisibles podrá visualizar una de las siguientes indicaciones:

- un solo segmento intermitente: temperatura baja;
- todos los segmentos iluminados y el segmento superior intermitente: temperatura alta.



Peligro - Cuidado: En caso de alta temperatura, detenga la motocicleta y controle el nivel del líquido refrigerante. Si debe rellenarse a nivel, diríjase a un Centro de Asistencia MV Agusta autorizado (ver § 3.8). Si la indicación persiste a pesar de que el nivel es correcto, detenga la motocicleta y contacte con un Centro de Asistencia MV Agusta autorizado.

Velocímetro

Indica la velocidad en kilómetros por hora (Km/h) o en millas por hora (Mph). El máximo valor (fondo de escala) es de 350 Km/h (217 Mph).

Mapeado de la central

Indica el modo operativo seleccionado de la central de inyección.

Pulsador "SET"

Presionando esta tecla podrá seleccionar las cifras a programar desde el display.

Pulsador "OK"

Presionando esta tecla podrá confirmar los valores seleccionados.

Pulsador "HAZARD"

Presionando esta tecla podrá activar las luces de emergencia.

Cuenta kilómetros total "TOTAL"

Indica la distancia total recorrida; entre 0 y 999999 (Km o millas).

Cuenta kilómetros parcial 1 "TRIP 1"

Indica la distancia parcial recorrida; entre 0 y 999.9 (Km o millas).

Cuenta kilómetros parcial 2 "TRIP 2"

Indica la distancia parcial recorrida; entre 0 y 999.9 (Km o millas).

Cronómetro

Indica los tiempos medidos con la función "Cronómetro".

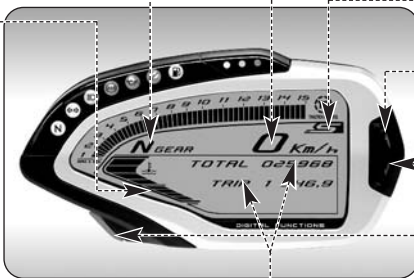



3.8. Tabla lubricantes y líquidos

Descripción	Producto aconsejado	Características
Aceite lubricación motor	eni i-Ride motoGP 10W-60 (*)	SAE 10W/60 - API SG
Líquido de refrigeración	Agip Eco - Permanent	Glicol - Etilénico diluido con 50% de agua destilada
Fluido mando embrague y frenos	Agip Brake 4	DOT4
Aceite lubricación cadena	D.I.D. CHAIN LUBE	-

* : Para encontrar fácilmente los productos recomendados, MV Agusta aconseja dirigirse directamente a los propios concesionarios autorizados. El aceite para motor eni i-Ride motoGP 10W-60 ha sido realizado especialmente para el motor de la motocicleta F4. En el caso que el lubricante descrito no se consiga, MV Agusta aconseja utilizar aceites completamente sintéticos con características conformes o superiores a las siguientes normas:

- Conforme API SG
- Conforme ACEA A3
- Conforme JASO MA
- Gradación SAE 10 W-60

NOTA

Las especificaciones indicadas deben estar presentes, por sí solas o junto a otras, en el envase del aceite lubricante.





4.1. Uso de la motocicleta

En esta sección se exponen los principales temas para el correcto uso de la motocicleta.



ATENCIÓN

Su motocicleta tiene altas características de potencia y prestaciones; por lo tanto, para su utilización es necesario un adecuado nivel de conocimiento del vehículo. Cuando usted utiliza la motocicleta para la primera vez, es necesario adoptar una actitud prudente. Una agresiva o temeraria actitud de conducción podría aumentar el peligro de accidentes y comportar un grave peligro para su incolumidad o para la de otras personas.



ATENCIÓN

LAS RESTRICCIONES DE USO DEL VEHÍCULO ESTÁN INDICADAS EN LA SECCIÓN “INFORMACIÓN PARA LA SEGURIDAD”.



PRUDENCIA

Las altas temperaturas causadas por el uso del vehículo en los circuitos podrían comprometer la eficacia del convertidor catalítico y del dispositivo de escape; por lo tanto, sugerimos montar un dispositivo especial de escape al usar el vehículo en los circuitos.





4.2. Rodaje



Prudencia - Precaución: el incumplimiento de las indicaciones a continuación indicadas puede perjudicar la duración y las prestaciones de la motocicleta.

Es muy común considerar el rodaje como una fase aplicada sólo al motor. En realidad el rodaje es importante también para otras partes primordiales de la moto como son los neumáticos, los frenos, la cadena de transmisión, etc. Durante los primeros kilómetros adopte una conducción tranquila.

De 0 a 500 km (de 0 a 300 mi) (A)

Durante este recorrido varíe frecuentemente el régimen de rotación del motor. Si es posible, efectúe trayectos con colinas, con muchas curvas y evite largos trechos rectilíneos.



PELIGRO

Los neumáticos nuevos deben ser sometidos a un adecuado rodaje para alcanzar la completa eficiencia. Evitar acelerar, curvas y frenadas bruscas en los primeros 100 km. Si no se realiza un primer periodo de rodaje de los neumáticos, hay riesgo de resbalar o perder el control del vehículo con consiguiente peligro de accidentes.





De 500 a 1000 km (de 300 a 600 mi)

Durante este recorrido evite mantener mucho tiempo el motor bajo esfuerzo.



De 1000 a 2500 km (de 600 a 1600 mi)

Durante este recorrido es posible pretender mayores prestaciones al motor pero sin superar el régimen de rotación indicado.

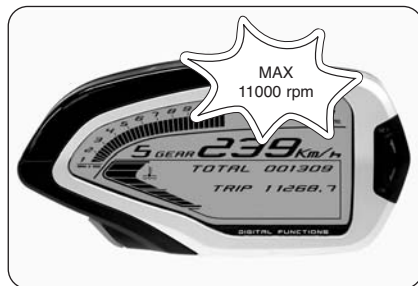



4.3. Arranque



CUIDADO

Dejar el motor en marcha en un ambiente cerrado puede ser peligroso. Los gases de escape contienen monóxido de carbono, un gas incoloro e inodoro que puede provocar la muerte o lesiones serias. Encienda y mantenga el motor en marcha sólo en lugares abiertos y/o al aire libre.

► Al girar el interruptor de encendido hasta la posición "ON", la instrumentación y los pilotos ejecutarán una secuencia de auto-diagnóstico preliminar: compruebe que se iluminen todos los pilotos del tablero durante esta inicialización.

► Para que el sistema del circuito de encendido genere la señal de arranque del motor deberá satisfacerse una de las siguientes condiciones:

- cambio en punto muerto y palanca de cambio en posición de embragado a fondo;
- una marcha embragada, palanca de cambio en posición de embragado a fondo y caballete lateral levantado.





► Si el auto-diagnóstico detecta la presencia de una avería en el vehículo, la pantalla muestra el mensaje de error mostrado en la figura. En particular, la pantalla muestra la parte del vehículo en el que se ha detectada la avería.

► Presionando ahora el pulsador “OK”, se accede a la función “RUN”.



CUIDADO

Si se detecta una avería en el vehículo, no arranque el motor y póngase en contacto con un centro de asistencia autorizado MV Agusta.





❑ Procedimiento de arranque

- ▶ Presione el botón para arrancar el motor sin girar el mando del acelerador.
- ▶ Suelte el botón apenas el motor se ponga en marcha.



Cautela - Precaución:

- Nunca accione el arranque por más de 5 segundos consecutivos para evitar dañar la instalación eléctrica.
- Nunca deje el motor en marcha durante mucho tiempo con la motocicleta parada: pueden dañarse los componentes internos del motor debido al recalentamiento. Es preferible alcanzar la temperatura de régimen circulando a baja velocidad.
- Para prolongar el máximo posible la vida útil del motor, nunca acelere a fondo con el motor en frío.





4.4. Selección y modificación de las funciones en el display

La instrumentación de su motocicleta le permite seleccionar y modificar algunos parámetros principales de medición tal como se describe a continuación:

- Selección de funciones:
 - “RUN” (Cuenta kilómetros)
 - “TC” (Control de tracción)
 - “CHRONO” (Cronómetro)
 - “SETTING ÖHLINS” (Regulación electrónica de las suspensiones)
 - “ABS” (Sistema de antibloqueo de frenos)*
 - “NIGHT/DAY” (Función Noche/Día)
 - “QUICK SHIFT” (Cambio rápido de marcha)
- Reset de las funciones cuenta kilómetros parciales:
 - Cuenta kilómetros Parcial 1 “TRIP 1”
 - Cuenta kilómetros Parcial 2 “TRIP 2”
- Función “IMMOBILIZER” (Sistema anti-robó)
- Selección del mapeado de la central

(*): Función disponible sólo en algunos modelos





4.4.1. Selección de las funciones en el display

Puede seleccionar las siguientes funciones:

- “RUN” (Cuenta kilómetros)
- “TC” (Control de tracción)
- “CHRONO” (Cronómetro)
- “SETTING ÖHLINS” (Regulación electrónica de las suspensiones)
- “ABS” (Sistema de antibloqueo de frenos)*
- “NIGHT/DAY” (Función Noche/Día)
- “QUICK SHIFT” (Cambio rápido de marcha)

Presione la tecla “SET” menos de 3 segundos para poder visualizar las diversas funciones una a la vez. Si presiona la tecla por más de 3 segundos, visualizará todas las funciones, una luego de la otra. Seleccione la función deseada.

(*): Función disponible sólo en algunos modelos



CUIDADO

Las funciones del display deben seleccionarse y modificarse con el motor apagado, en punto muerto, con la motocicleta detenida y los pies apoyados en el suelo. Queda terminantemente prohibido programar las funciones durante la marcha.





❑ Función “RUN”

Además de la función de taquímetro, podrá visualizar en el display las funciones que siguen (ver §4.4.2.):

- Cuenta kilómetros Total “TOTAL”
- Cuenta kilómetros Parcial 1 “TRIP 1”

En alternativa:

- Cuenta kilómetros Total “TOTAL”
- Cuenta kilómetros Parcial 2 “TRIP 2”

❑ Función “TC”

Le permite adaptar el nivel de control de la tracción del motor en función de sus exigencias de conducción (ver §4.4.3.).





❑ Función “CHRONO”

Le permite activar el cronómetro y salvar los datos medidos (ver §4.4.4.). Las opciones visualizadas serán:

- Cronómetro Vuelta en curso “CURRENT LAP”
- Cronómetro Mejor vuelta recorrida “BEST LAP”
- Cronómetro Vuelta anterior “LAST LAP”
- Taquímetro Total de vueltas recorridas “N° LAP”



❑ Función “NIGHT/DAY”

La presente función permite invertir el color de fondo del display, para adaptar su visibilidad durante el uso diurno o nocturno del vehículo (ver §4.4.5.).





❑ Función “SETTING ÖHLINS”

Le permite realizar el ajuste de los siguientes dispositivos (ver §4.4.6.):

- Suspensión delantera
- Suspensión trasera
- Amortiguador de dirección

❑ Función “ABS” *

Le permite activar o desactivar el sistema antibloqueo de frenos (ABS) (ver §4.4.7.).



(*): Función disponible sólo en algunos modelos





❑ Función “QUICK SHIFT”

Le permite apagar o encender la función del cambio rápido de marcha (ver §4.4.8.).





4.4.2. Reset de las funciones cuenta kilómetros parciales

Para resetear las funciones “TRIP 1” y “TRIP 2” siga los pasos descritos a continuación.



CUIDADO

Las funciones del display deben seleccionarse y modificarse con el motor apagado, en punto muerto, con la motocicleta detenida y los pies apoyados en el suelo. Queda terminantemente prohibido programar las funciones durante la marcha.

► Acceder a la función “RUN”; en la pantalla inicial se visualizan las funciones cuentakilómetros total (“TOTAL”) y cuentakilómetros parcial 1 (“TRIP 1”).

► Presionando ahora el pulsador “OK” durante un tiempo superior a tres segundos el valor “TRIP 1” se ajusta a cero.





► Presionar el pulsador “OK” durante un tiempo inferior a tres segundos hasta la visualización de la función cuentakilómetros parcial 2 (“TRIP 2”).



► Presionando ahora el pulsador “OK” durante un tiempo superior a tres segundos el valor “TRIP 2” se ajusta a cero.





4.4.3. Función "TC"

► Presione "SET" para acceder a la función "TC", luego presione "OK" por menos de 3 segundos hasta visualizar "TC LEVEL": el nivel de tracción efectivo corresponde al valor visualizado en el display.



CUIDADO

Las funciones del display deben seleccionarse y modificarse con el motor apagado, en punto muerto, con la motocicleta detenida y los pies apoyados en el suelo. Queda terminantemente prohibido programar las funciones durante la marcha.

► Presione "OK" menos de 3 segundos: el nivel de control de la tracción aumenta hasta alcanzar el valor sucesivo. De lo contrario, presionando "SET" por menos de tres segundos, el nivel de control de la tracción disminuye al valor anterior. Intervalo de variación admisible: entre 0 y 8.

► Presione "OK" por más de 3 segundos para confirmar el nivel de control de tracción seleccionado.

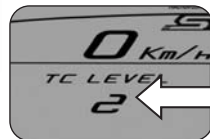
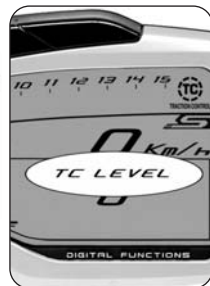



4.4.4. Cronómetro

❑ Adquisición de los tiempos de recorrido de la vuelta

► Active la función cronómetro (“CHRONO”) para que el sistema inicie a adquirir los datos correspondientes a los tiempos de recorrido de la vuelta.



► Basta presionar el mando de la luz larga para que el sistema inicie la ejecución de la función: los dos puntos que separan los minutos, los segundos y las décimas de segundo pasan al estado intermitente, indicando que el sistema está adquiriendo los datos relativos a los tiempos.

NOTA: Cuando la función “CHRONO” está activada, la primera presión del mando de la luz larga activa automáticamente la función “TC”. Desde este momento, es posible modificar el nivel de control de tracción presionando los botones “SET” and “OK” (ver § 4.4.3.).





► Presione nuevamente el mando de la luz larga para adquirir el tiempo correspondiente a la primera vuelta recorrida: el instrumento empezará a adquirir contemporáneamente el tiempo correspondiente a la segunda vuelta.

La medición del tiempo relativo a la primera vuelta se conserva en memoria y permanece visualizada en el display durante diez segundos, luego se visualiza el tiempo de la vuelta sucesiva.

► Cada vez que presione el mando de la luz larga el sistema salvará un tiempo en su memoria. Este instrumento puede memorizar un máximo de 100 datos consecutivos.

Durante la visualización del tiempo de la vuelta apenas acabada, en el display aparece el símbolo “+” o bien “-” en el caso en que el tiempo medido sea respectivamente inferior o superior al tiempo medido durante la vuelta anterior.

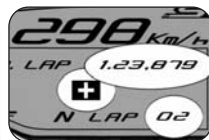
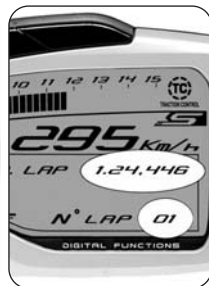



❑ Visualización de datos

Una vez que el sistema haya completado la fase de adquisición de datos podrá visualizar los tiempos en el display.

► Acceder a la función “CHRONO”; en esta pantalla se visualiza el tiempo de la vuelta más rápida (“BEST LAP”) y el tiempo de la última vuelta efectuada (“LAST LAP”).



CUIDADO:

Las funciones del display deben seleccionarse y modificarse con el motor apagado, en punto muerto, con la motocicleta detenida y los pies apoyados en el suelo. Queda terminantemente prohibido programar las funciones durante la marcha.

► Presione “OK” menos de 3 segundos hasta visualizar “LAPS VIEW”.

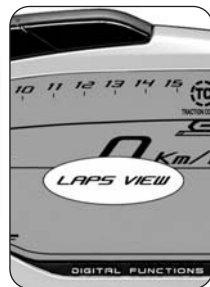



► La presión repetida del pulsador “OK” permite visualizar en secuencia todos los tiempos anteriormente adquiridos a partir de la última vuelta memorizada.

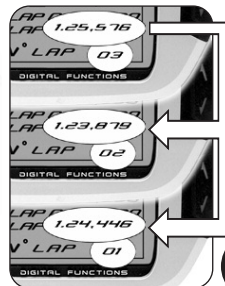

4 ES

► Al final de la visualización de los datos, la presión del pulsador “SET” permite regresar a la función “LAPS VIEW” para pasar a la función sucesiva.

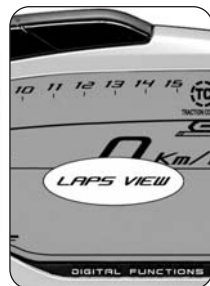



❑ Cómo borrar los datos

Para borrar los datos adquiridos siga los pasos descritos a continuación:



⚠ CUIDADO:

Las funciones del display deben seleccionarse y modificarse con el motor apagado, en punto muerto, con la motocicleta detenida y los pies apoyados en el suelo. Queda terminantemente prohibido programar las funciones durante la marcha.

▶ *Cancelación tiempos individuales:* Acceder a la función "CHRONO" y presionar el pulsador "SET" durante un tiempo inferior a tres segundos hasta la visualización del texto "SINGLE LAP RESET".

▶ Presionar el pulsador "OK" durante un tiempo inferior a tres segundos; el valor del último tiempo de la vuelta memorizada empieza a centellear.

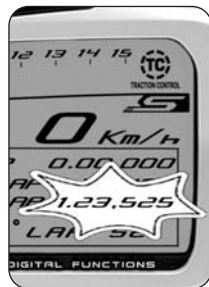



► Presione “OK” por más de 3 segundos para borrar el dato. Si presiona “SET” por menos de 3 segundos, se interrumpirá la ejecución de borrado.

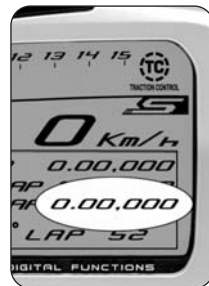

► Sucesivamente, la presión del pulsador “OK” durante un tiempo superior a tres segundos permite cancelar en secuencia todos los tiempos anteriormente adquiridos.

► Al final de la cancelación de los datos, la presión del pulsador “SET” permite regresar a la función “LAPS VIEW” para pasar a la función sucesiva.





► *Cancelación mejor tiempo:* Acceder a la función “LAPS VIEW” y presionar el pulsador “SET” durante un tiempo inferior a tres segundos hasta la visualización del texto “BEST LAP RESET”.



► Presionar el pulsador “OK” durante un tiempo inferior a tres segundos; el valor del tiempo de la vuelta más rápida inicia a centellear.





► Presione “OK” por más de 3 segundos para borrar el dato. Si presiona “SET” por menos de 3 segundos, se interrumpirá la ejecución de borrado.

► Al final de la cancelación de los datos, la pantalla muestra “LAP TIME ERASED” y luego regresa a la función “LAPS VIEW”.



► *Cancelación de todos los tiempos memorizados:* Acceder a la función “LAPS VIEW” y presionar el pulsador “SET” durante un tiempo inferior a tres segundos hasta la visualización del texto “ALL LAPS RESET”.





► Presionar el pulsador “OK” durante un tiempo inferior a tres segundos; el display solicita la confirmación para la cancelación de todos los datos presentes en memoria.

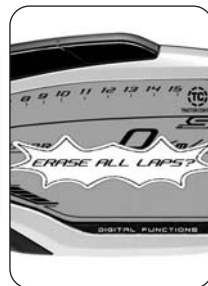

► Presionando ahora el pulsador “OK” durante un tiempo superior a tres segundos todos los tiempos anteriormente adquiridos son cancelados. Si por el contrario se presiona el pulsador “SET” durante un tiempo inferior a tres segundos el procedimiento de cancelación se interrumpe.

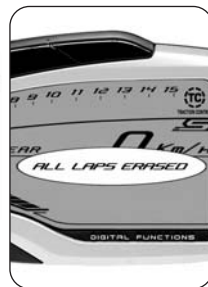

► Al final de la cancelación de los datos, la pantalla muestra “ALL LAPS ERASED” y luego regresa a la función “LAPS VIEW”.





4.4.5. Función “NIGHT/DAY”

► Para convertir el color de fondo del display, acceder a la función “NIGHT/DAY MODE” y presionar el pulsador “OK” durante un tiempo inferior a tres segundos.



CUIDADO:

Las funciones del display deben seleccionarse y modificarse con el motor apagado, en punto muerto, con la motocicleta detenida y los pies apoyados en el suelo. Queda terminantemente prohibido programar las funciones durante la marcha.

► La presión del pulsador “SET” permite pasar en modo cíclico de la visualización diurna del display a la nocturna.

► Una vez definido el color de fondo del display, la presión del pulsador “OK” durante un tiempo superior a tres segundos permite confirmar la visualización elegida y regresar a la función “NIGHT/DAY MODE”. El fondo así definido se mantendrá en todas las sucesivas modalidades de utilización del tablero de instrumentos.

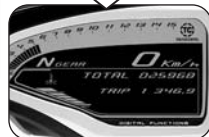
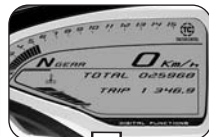
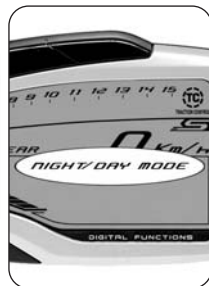



4.4.6. Regulación electrónica de las suspensiones

► Para realizar el ajuste personalizado de la configuración de suspensiones, presione “SET” para acceder a la función “SETTING ÖHLINS”.



CUIDADADO: Las funciones del display deben seleccionarse y modificarse con el motor apagado, en punto muerto, con la motocicleta detenida y los pies apoyados en el suelo. Queda terminantemente prohibido programar las funciones durante la marcha.

NOTA: El ajuste de las suspensiones se permite sólo si el mapeo “C” de la central está seleccionado (ver § 4.4.10.).

NOTA: Ver la tabla adjunta para obtener los valores consejados de ajuste de las suspensiones.

□ Frenado en compresión (suspensión delantera)

► Presionando el pulsador “OK” por menos de tres segundos, la pantalla muestra los parámetros disponibles de ajuste de las suspensiones.

► Después de algunos segundos, “FRONT” y “C” comenzarán a parpadear; ahora es posible modificar el valor del frenado en compresión de la suspensión delantera.





- ▶ Presione “OK” menos de 3 segundos: el nivel del frenado en compresión aumenta hasta alcanzar el valor sucesivo. Intervalo de variación admisible: entre **1** y **26**.
- ▶ Presione “OK” por más de 3 segundos para confirmar el nivel del frenado en compresión seleccionado; la pantalla está lista para el próximo ajuste. Si presiona “SET” por menos de 3 segundos, se interrumpirá la operación de regulación, los valores de configuración serán confirmados y la pantalla volverá al menú principal.



4 ES

❑ Frenado en extensión (suspensión delantera)

- ▶ Después de algunos segundos, “FRONT” y “R” comenzarán a parpadear; ahora es posible modificar el valor del frenado en extensión de la suspensión delantera.
- ▶ Presione “OK” menos de 3 segundos: el nivel del frenado en extensión aumenta hasta alcanzar el valor sucesivo. Intervalo de variación admisible: entre **1** y **26**.
- ▶ Presione “OK” por más de 3 segundos para confirmar el nivel del frenado en extensión seleccionado.

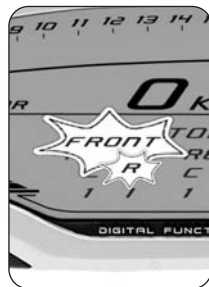



❑ Frenado en compresión (suspensión trasera)

- ▶ Después de algunos segundos, “REAR” y “C” comenzarán a parpadear; ahora es posible modificar el valor del frenado en compresión de la suspensión trasera.
- ▶ Presione “OK” menos de 3 segundos: el nivel del frenado en compresión aumenta hasta alcanzar el valor sucesivo. Intervalo de variación admisible: entre **1** y **26**.
- ▶ Presione “OK” por más de 3 segundos para confirmar el nivel del frenado en compresión seleccionado.



❑ Frenado en extensión (suspensión trasera)

- ▶ Después de algunos segundos, “REAR” y “R” comenzarán a parpadear; ahora es posible modificar el valor del frenado en extensión de la suspensión trasera.
- ▶ Presione “OK” menos de 3 segundos: el nivel del frenado en extensión aumenta hasta alcanzar el valor sucesivo. Intervalo de variación admisible: entre **1** y **26**.
- ▶ Presione “OK” por más de 3 segundos para confirmar el nivel del frenado en extensión seleccionado.





❑ Amortiguador de dirección

► Después de algunos segundos, la pantalla muestra las funciones disponibles para el ajuste del amortiguador de dirección (“AUTO”: automático, “MANUAL”: personalizado).

► Presione el pulsador “OK” por menos de tres segundos; “AUTO” comenzará a parpadear.

► Presione el pulsador “SET” por menos de tres segundos; “MANUAL” comenzará a parpadear. Presionando “OK” por más de 3 segundos, es posible modificar el nivel de frenado del amortiguador de dirección.

► Presione “OK” menos de 3 segundos: el nivel de frenado del amortiguador de dirección aumenta hasta alcanzar el valor sucesivo. Intervalo de variación admisible: entre **1** y **14**.

► Presione “OK” por más de 3 segundos para confirmar el nivel seleccionado del frenado del amortiguador de dirección; la pantalla vuelve al modo de ajuste de las suspensiones. Si presiona “SET” por menos de 3 segundos, se interrumpirá la operación de regulación y los valores seleccionados del ajuste de las suspensiones serán confirmados.

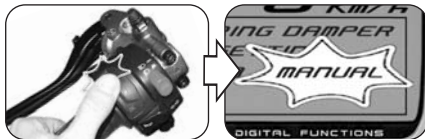
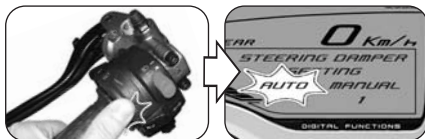



4.4.7. Selección de la función ABS *

► Presione “SET” para acceder a la función “ABS”; “SETTING ABS” aparece en el display.



CUIDADO

Las funciones del display deben seleccionarse y modificarse con el motor apagado, en punto muerto, con la motocicleta detenida y los pies apoyados en el suelo. Queda terminantemente prohibido programar las funciones durante la marcha.

► Presione “OK” menos de 3 segundos: la pantalla muestra la última selección memorizada. En la condición estándar, “ABS NORMAL” (*función ABS para uso en carretera*) empieza a parpadear en el display.

► Si no se presiona ningún botón, después de tres segundos la selección “ABS NORMAL” está confirmada; en esta condición, la función ABS para uso en carretera está activada. Presione “SET” para salir de la función “ABS”.

(*): Función disponible sólo en algunos modelos

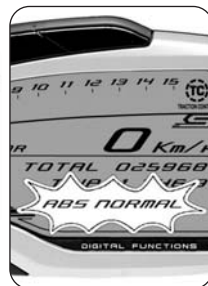



► De lo contrario, si se presiona “OK” mientras que el título sigue parpadeando, “ABS RACE” (función ABS para uso en pista) aparece en el display.

 **CUIDADO:** La función “ABS RACE” está expresamente estudiada para el uso del vehículo en pista. MV Agusta recomienda no utilizar esta función cuando se conduce el vehículo en la carretera.

► Si no se presiona ningún botón, después de tres segundos la selección “ABS RACE” está confirmada. De lo contrario, si se presiona “OK” mientras que el título sigue parpadeando, “ABS OFF” aparece en el display.

► Si no se presiona ningún botón, después de tres segundos la selección “ABS OFF” está confirmada; en esta condición, el sistema ABS está desactivado.

 **CUIDADO:** Si el sistema ABS está desactivado, la luz de advertencia correspondiente en el tablero de instrumentos se enciende (ver § 3.7.1.). Desde este momento, el sistema de antibloqueo de frenos no es disponible durante el frenado. Adoptar un estilo de conducción prudente y viajar a baja velocidad, para no perder el control del vehículo durante una frenada de emergencia.

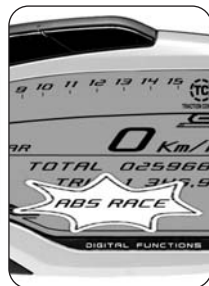



4.4.8. Función “QUICK SHIFT”

► Presione “SET” para acceder a la función “QUICK SHIFT”. La pantalla muestra el estado de activación actual de la función del cambio rápido de marcha.



CUIDADO

Las funciones del display deben seleccionarse y modificarse con el motor apagado, en punto muerto, con la motocicleta detenida y los pies apoyados en el suelo. Queda terminantemente prohibido programar las funciones durante la marcha.

► Presione “OK” por menos de tres segundos; la leyenda de la activación del cambio rápido comienza a parpadear.

► Presionando “OK” por menos de tres segundos, cambia el título de “OFF” en “ON” y viceversa.

► Después de algunos segundos, el estado seleccionado de activación del cambio rápido será automáticamente confirmado.





4.4.9. Función “IMMOBILIZER”

Le permite poner el motor en marcha sólo si el sistema reconoce la llave de arranque original. Se trata de un sistema anti-robado integrado al circuito electrónico del vehículo que impide que una persona no autorizada la ponga en marcha.

La función “IMMOBILIZER” debe utilizarse sólo en caso de anomalía: si por cualquier motivo el sistema no logra reconocer la llave original, para poder poner en marcha su motocicleta deberá introducir entonces el código secreto indicado en la “MV Code Card” entregada junto con el vehículo.

- ▶ Quite la cubierta del recuadro posterior de la “MV Code Card” y lea el código electrónico secreto de su llave de puesta en marcha (la figura indica un código indicativo que puede no corresponder al de su llave).
- ▶ Acceder a la función “RUN” y presione “SET” y “OK” por más de 3 segundos hasta visualizar “IMMOBILIZER”.

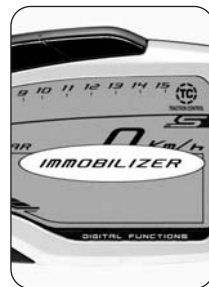

**CUIDADO**

Las funciones del display deben seleccionarse y modificarse con el motor apagado, en punto muerto, con la motocicleta detenida y los pies apoyados en el suelo. Queda terminantemente prohibido programar las funciones durante la marcha.

- ▶ Presione "OK" menos de 3 segundos para programar la primera cifra del código.
- ▶ Presionando "OK" menos de 3 segundos podrá modificar la primera cifra entre **0** y **9**.
- ▶ Una vez que haya seleccionado la primera cifra presione "OK" por más de 3 segundos para confirmarla antes de pasar a la segunda.
- ▶ Repita estos pasos para introducir las 4 cifras restantes del código.

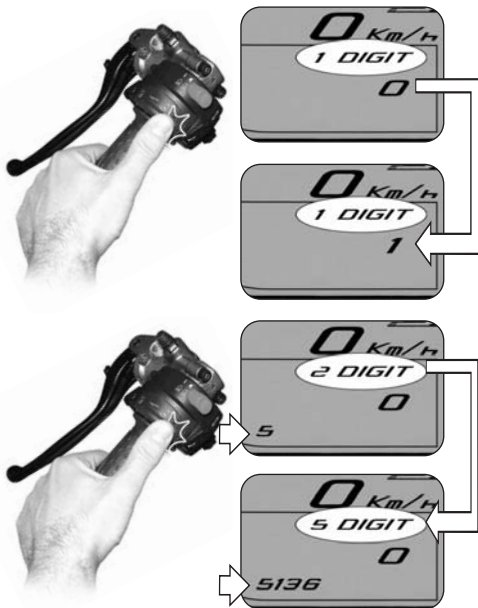



► Una vez que haya introducido todas las cifras del código visualizará en el display el mensaje “CONFIRM CODE”. Presione “OK” por más de 3 segundos para confirmar el código que ha introducido.

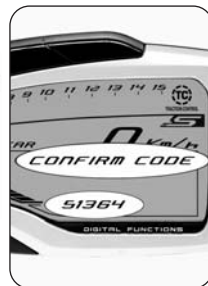

► Si el sistema reconoce el código, visualizará en el display el mensaje “VALID CODE”. El instrumento volverá entonces a la función “RUN”, permitiéndole arrancar el motor.

► Si el código introducido es incorrecto, visualizará en el display el mensaje “NOT VALID CODE”: el sistema no le permitirá arrancar el motor y volverá a la función “IMMOBILIZER”. Repita todos los pasos anteriores para introducir el código secreto correcto indicado en su MV Code Card. En caso de inconvenientes, contacte con un Centro de Asistencia MV Agusta autorizado.

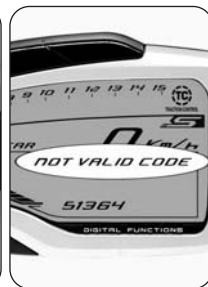
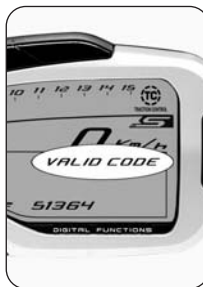



4.4.10. Selección del mapeado de la central

En el modelo F4 RR, se puede seleccionar diferentes mapas de la centralita que permiten obtener características variables de potencia y prestaciones dependiendo del tipo de utilización del vehículo.

NOTA

El mapeado de la central se puede seleccionar también durante el uso del vehículo.

La selección del mapeado de la centralita se puede efectuar presionando el pulsador de arranque con motor encendido; de esta manera el mapeado pasa al valor siguiente. Las relativas características del mapeado se indican en la siguiente tabla.

Mapeado	N	R	S	C
Modalidad	Normal	Lluvia	Deportiva	Personalizada

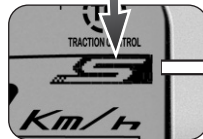



❑ Ajuste del mapeado personalizado

► Presionar el pulsador de arranque con motor encendido hasta la selección del mapeado “C” de la centralita (mapeado personalizado).



CUIDADO

El ajuste del mapeado personalizado se debe seleccionar en punto muerto, con la motocicleta detenida y los pies apoyados en el suelo. Queda terminantemente prohibido programar las funciones durante la marcha.

► Presionar el pulsador “SET” hasta que “SETTING C MAP” aparece.

A fin de ajustar los parámetros del mapeado personalizado a sus necesidades de conducción, realizar las siguientes operaciones.

► *Sensibilidad del control del acelerador:* Apretar el pulsador “OK” durante un tiempo inferior a tres segundos hasta que “GAS SENSITIVITY” aparece.

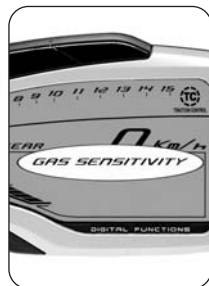



► Apretar el pulsador “SET” durante un tiempo inferior a tres segundos. La pantalla muestra la configuración actual de la sensibilidad del control del acelerador.

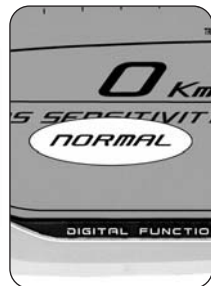

► Apretar el pulsador “OK” durante un tiempo inferior a tres segundos; el ajuste mostrado comienza a parpadear.

► La presión repetida del pulsador “OK” durante un tiempo inferior a tres segundos, permite visualizar en secuencia las siguientes configuraciones:

- “NORMAL” (Normal)
- “RAIN” (Lluvia)
- “SPORT” (Deportiva)

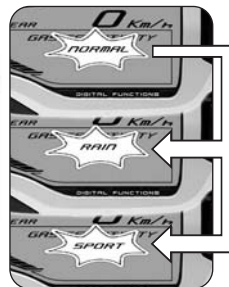



► Apretar el pulsador “OK” durante un tiempo superior a tres segundos; el nuevo ajuste será confirmado. El ajuste mostrado deje de parpadear, y después de algunos segundos la pantalla vuelve a la modalidad “GAS SENSITIVITY”. Ahora es posible proceder con el ajuste del parámetro siguiente.

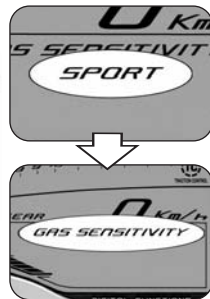

► *Par máximo del motor:* Apretar el pulsador “OK” durante un tiempo inferior a tres segundos hasta que “MAX ENGINE TORQUE” aparece.

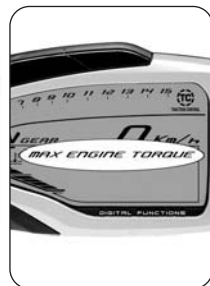



► Apretar el pulsador “SET” durante un tiempo inferior a tres segundos. La pantalla muestra la configuración actual del par máximo del motor.

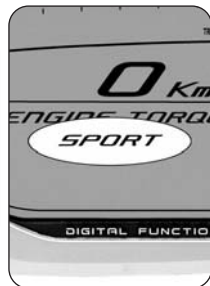

► Apretar el pulsador “OK” durante un tiempo inferior a tres segundos; el ajuste mostrado comienza a parpadear.

► La presión repetida del pulsador “OK” durante un tiempo inferior a tres segundos, permite visualizar en secuencia las siguientes configuraciones:

- “SPORT” (Deportiva)
- “RAIN” (Lluvia)





► Apretar el pulsador “OK” durante un tiempo superior a tres segundos; el nuevo ajuste será confirmado. El ajuste mostrado deje de parpadear, y después de algunos segundos la pantalla vuelve a la modalidad “MAX ENGINE TORQUE”.

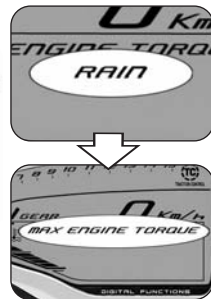

► *Freno motor:* Apretar el pulsador “OK” durante un tiempo inferior a tres segundos hasta que “ENGINE BRAKE” aparece.

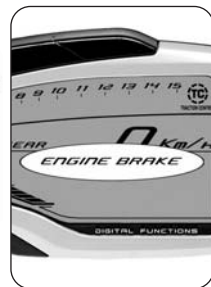



► Apretar el pulsador “SET” durante un tiempo inferior a tres segundos. La pantalla muestra la configuración actual del freno motor.



► Apretar el pulsador “OK” durante un tiempo inferior a tres segundos; el ajuste mostrado comienza a parpadear.

► La presión repetida del pulsador “OK” durante un tiempo inferior a tres segundos, permite visualizar en secuencia las siguientes configuraciones:

- “NORMAL” (Normal)
- “SPORT” (Deportiva)

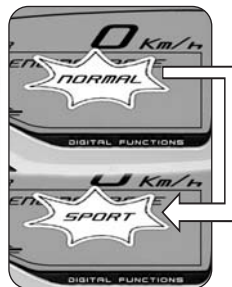



► Apretar el pulsador “OK” durante un tiempo superior a tres segundos; el nuevo ajuste será confirmado. El ajuste mostrado deje de parpadear, y después de algunos segundos la pantalla vuelve a la modalidad “ENGINE BRAKE”.



► *Respuesta del motor:* Apretar el pulsador “OK” durante un tiempo inferior a tres segundos hasta que “ENGINE RESPONSE” aparece.

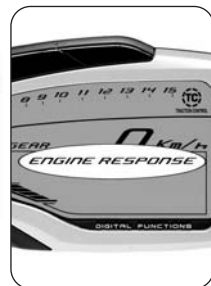



► Apretar el pulsador “SET” durante un tiempo inferior a tres segundos. La pantalla muestra la configuración actual de la respuesta del motor.



► Apretar el pulsador “OK” durante un tiempo inferior a tres segundos; el ajuste mostrado comienza a parpadear.

► La presión repetida del pulsador “OK” durante un tiempo inferior a tres segundos, permite visualizar en secuencia las siguientes configuraciones:

- “SLOW RESPONSE” (Respuesta lenta)
- “FAST RESPONSE” (Respuesta rápida)





► Apretar el pulsador “OK” durante un tiempo superior a tres segundos; el nuevo ajuste será confirmado. El ajuste mostrado deje de parpadear, y después de algunos segundos la pantalla vuelve a la modalidad “ENGINE RESPONSE”.



► *Limitador revoluciones del motor:* Apretar el pulsador “OK” durante un tiempo inferior a tres segundos hasta que “RPM LIMITER” aparece.





► Apretar el pulsador “SET” durante un tiempo inferior a tres segundos. La pantalla muestra la configuración actual del limitador de revoluciones del motor.



► Apretar el pulsador “OK” durante un tiempo inferior a tres segundos; el ajuste mostrado comienza a parpadear.

► La presión repetida del pulsador “OK” durante un tiempo inferior a tres segundos, permite visualizar en secuencia las siguientes configuraciones:

- “NORMAL” (Normal)
- “SPORT” (Deportiva)





► Apretar el pulsador “OK” durante un tiempo superior a tres segundos; el nuevo ajuste será confirmado. El ajuste mostrado deje de parpadear, y después de algunos segundos la pantalla vuelve a la modalidad “RPM LIMITER”.

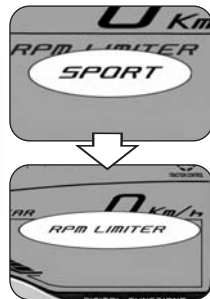

► Apretar el pulsador “OK” durante un tiempo inferior a tres segundos hasta que la pantalla vuelve a la modalidad “RUN”. El ajuste del mapeado personalizado se ha completado.





4.4.11. Mensajes de advertencia/error

La pantalla puede mostrar un error o un mal funcionamiento en las diferentes condiciones de utilización del vehículo.

► *Arranque del motor:* Al girar el interruptor de encendido hasta la posición "ON", la instrumentación y los pilotos ejecutarán una secuencia de auto-diagnóstico preliminar. Si el auto-diagnóstico detecta la presencia de una avería en el vehículo, la pantalla muestra el mensaje de error mostrado en la figura. En particular, la pantalla muestra la parte del vehículo en el que se ha detectada la avería.

► Presionando ahora el pulsador "OK", se accede a la función "RUN".



CUIDADO

Si se detecta una avería con el vehículo parado, no arranque el motor y póngase en contacto con un centro de asistencia autorizado MV Agusta.





► *Marcha del vehículo:* Si se detecta una avería en la conducción del vehículo, la parte inferior de la pantalla muestra el mensaje de error mostrado en la figura.

**CUIDADO**

Si se detecta una avería en la marcha, detener el vehículo y póngase en contacto con un centro de asistencia autorizado MV Agusta.

► Cuando el vehículo está detenido, la pantalla muestra la parte del vehículo en el que se ha detectada la avería.





► *Alta temperatura del líquido refrigerante:* Si se detecta una alta temperatura del líquido refrigerante, la pantalla muestra el mensaje de error mostrado en la figura. Este mensaje puede aparecer durante todas las condiciones de uso del vehículo.



CUIDADO

En caso de alta temperatura, detenga la motocicleta y controle el nivel del líquido refrigerante. Si debe rellenarse a nivel, diríjase a un Centro de Asistencia MV Agusta autorizado (ver § 3.8). Si la indicación persiste a pesar de que el nivel es correcto, detenga la motocicleta y contacte con un Centro de Asistencia MV Agusta autorizado.





4.5. Reabastecimiento combustible



Peligro – Atención: la gasolina y sus vapores son extremadamente inflamables y dañosos. Evitar el contacto y la inhalación. Durante el abastecimiento apagar el motor, no fumar, tener lejos llamas, chispas y fuentes de calor. Efectuar el llenado en un lugar abierto o en un sitio bien ventilado.



Prudencia – Precaución: utilizar exclusivamente gasolina super sin plomo y sin alcohol con 95 octanos (R.O.N.) o mas. Esta necesidad es recordada por un punto verde en la parte inferior de la tapa del deposito y por la etiqueta en el depósito del combustible.

- ▶ Levante la tapa parapolvero.
- ▶ Introduzca la llave, girela en sentido horario y levante el tapón.
- ▶ Después del abastecimiento presione el tapón hacia abajo girando contemporáneamente la llave en sentido horario para facilitar el cierre. Suelte la llave y extráigala.



**PELIGRO**

Llenando excesivamente el depósito puede provocar derrame del carburante debido a la expansión del calor provocada por el calor del motor o a la exposición de la motocicleta a la luz del sol. Eventual derrame de carburante puede provocar incendios. El nivel del carburante en el depósito no debe superar nunca la base de la boca de llenado.



Prudencia - Precaución: secar enseguida con un trapo limpio eventual carburante derramado, puesto que podría dañar la superficie pintada o de plástico.

**PELIGRO**

Verificar que la tapa del depósito del carburante esté cerrada correctamente antes de utilizar el vehículo.





4.6. Acceso al hueco portaobjetos

- ▶ Introducir la llave.
- ▶ Apretar el sillín pasajero en la parte terminal y simultáneamente girar la llave en sentido horario.
- ▶ Levantar el sillín pasajero por el extremo trasero, hacerlo deslizar hacia delante y extraerlo.

Para montar nuevamente la pieza, seguir las siguientes indicaciones:

- Girar la llave en la cerradura
- Presionar el sillín pasajero
- Soltar la llave
- Presionar nuevamente sobre el sillín cerciorándose que el mismo se encuentre muy bien enganchado a la estructura.



ATENCIÓN

Después de haber quitado y levantado el sillín pasajero, y de todas maneras antes de utilizar la motocicleta, cerciorarse que el mismo haya sido colocado correctamente y que se encuentre bien sujeto a la estructura principal del vehículo.





4.7. Estacionamiento de la motocicleta

❑ Estacionamiento con caballete lateral



PRUDENCIA – PRECAUCION

- Aparcar la motocicleta en condiciones de seguridad y en un terreno estable.
- En las pendientes estacionar la moto con la rueda delantera hacia la subida y con la primera velocidad engranada; recordarse de retornar el cambio en neutro antes de poner en marcha el vehículo.
- No dejar el vehículo sin custodia con la llave de encendido introducida en el cuadro.

- ▶ Bajar el caballete con el pie hasta el tope e inclinar lentamente la motocicleta para colocar el pie de apoyo a contacto con el suelo.

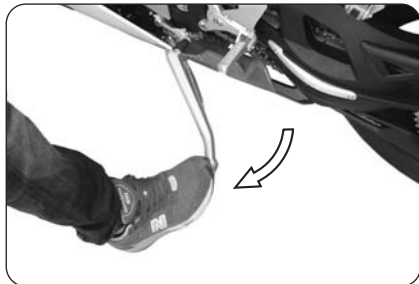

**PELIGRO**

Cuando el vehículo esté parado sobre el caballete lateral, es peligroso sentarse sobre él cargando todo el peso sobre el único apoyo de estacionamiento.

**PELIGRO**

Antes de ponerse en marcha verificar el buen funcionamiento del interruptor de seguridad cerciorandose que la luz testigo del caballete lateral ubicada en el tablero se apague; de todas maneras verificar que el caballete lateral haya retornado.

Si se nota una imperfección, hacer controlar la instalación por un concesionario MV Agusta antes de utilizar el vehículo.

□ Estacionamiento con caballete trasero

Introducir el perno del caballete en el orificio del eje de la rueda trasera en el lado izquierdo de la moto; apoyar el caballete en el suelo y empujándolo, levantar el vehículo hasta que el vehículo esté estable.

**PRUDENCIA - PRECAUCION**

Esta operación se debe realizar por dos personas.





5.1. Lista regulaciones

La motocicleta posee una amplia posibilidad de regulaciones que pueden mejorar la ergonomía, la estabilidad y la seguridad.

Sin embargo algunas de estas regulaciones pueden ser realizadas exclusivamente por los Centros de Asistencia MV Agusta, dado que una regulación errónea de ciertos componentes sumamente importantes puede provocar una situación de peligro.

ES 5

**PELIGRO**

Las regulaciones se deben realizar con el vehículo parado.





(F) Regulación espejo retrovisor (§5.5.)

(A) Regulación palanca embrague (§5.4.)

(F) Regulación espejo retrovisor (§5.5.)

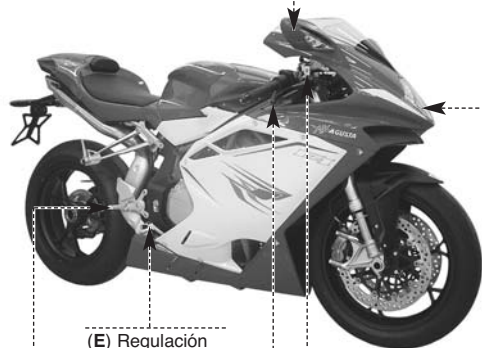

(E) Regulación palanca freno trasero (§5.2.)

(C) Regulación estribo derecho (§5.2.)

(G) Regulación amortiguador de dirección (§4.4.6.)

(D) Regulación palanca cambio (§5.2.)

(L) Regulación suspensión trasera (§4.4.6.)



(N) Orientación faro (§5.7.)

(H) Regulación suspensión delantera (§5.3. y §4.4.6.)

(B) Regulación palanca freno delantero (§5.3.)

(M) Regulación cadena (§5.2.)

(C) Regulación estribo izquierdo (§5.2.)





5.2. Tabla de las regulaciones

	A - Regulación palanca embrague: para optimizar el funcionamiento según las exigencias del motociclista (§5.4).	
	B - Regulación palanca freno delantero: para optimizar el funcionamiento según las exigencias del motociclista (§5.3).	
	C - Regulación estribos reposapiés (derecho y izquierdo): para optimizar la posición de los pies en función de las exigencias del motociclista.	
	D - Regulación palanca cambio: para optimizar el movimiento del mando en función de las exigencias del motociclista.	
	E - Regulación palanca freno trasero: para optimizar el movimiento de los mandos en función de las exigencias del motociclista.	
	F - Regulación espejos retrovisores: para optimizar la orientación (§5.5).	
	G - Regulación amortiguador de dirección: para adaptar la dureza del manillar a las preferencias del motociclista (§4.4.6.).	
	H - Regulación suspensión delantera: para adaptar su respuesta a las preferencias del motociclista se pueden regular: <ul style="list-style-type: none">- precarga muelle (§5.6.1.)- dispositivo hidráulico de frenado en extensión (§4.4.6.)- dispositivo hidráulico de frenado en compresión (§4.4.6.)	
	L - Regulación suspensión trasera: para adaptar su respuesta a las preferencias del motociclista se pueden regular: <ul style="list-style-type: none">- altura rectificado- precarga muelle- dispositivo hidráulico de frenado en extensión (§4.4.6.)- dispositivo hidráulico de frenado en compresión (§4.4.6.)	
	M - Regulación cadena: para la eficacia y la seguridad de la transmisión.	
	N - Orientación faro: para optimizar la profundidad del haz luminoso en función del equilibrado (§5.7.).	





5.3. Regulación de la palanca del freno delantero

Ajuste la posición de la palanca girando la virola en sentido horario o contrario a las agujas del reloj. En sentido horario: la palanca se aleja de la maneta. En sentido contrario a las agujas del reloj: la palanca se acerca a la maneta.

5.4. Regulación de la palanca del embrague

Ajuste la posición de la palanca girando la virola en sentido horario o contrario a las agujas del reloj. En sentido horario: la palanca se aleja de la maneta. En sentido contrario a las agujas del reloj: la palanca se acerca a la maneta.

5.5. Regulación de los espejos retrovisores

Apriete los puntos puestos en evidencia para regular la posición en las cuatro direcciones.

Efectuar el ajuste en ambos espejos retrovisores. Para realizar un óptimo ajuste, aconsejamos realizarlo subidos en el vehículo.

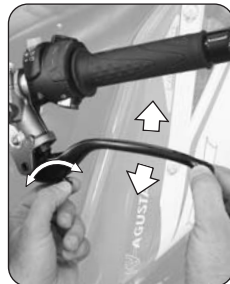



5.6. Regulación de la suspensión delantera

NOTA

La regulación de las suspensiones se debe realizar preferiblemente con el depósito del combustible lleno.

NOTA

Para efectuar la regulación del freno en extensión y compresión, consulte las operaciones descritas en el § 4.4.6.

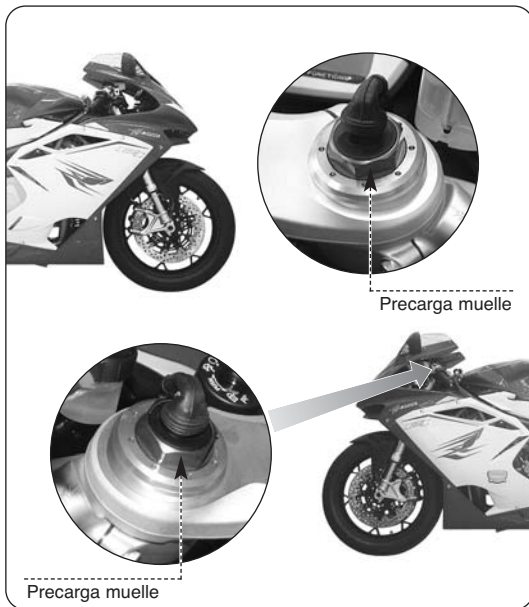



5.6.1. Precarga muelle (suspensión delantera)

► Para acceder a la tuerca de ajuste de la precarga del muelle, levante la funda de protección y extraer el conector con un destornillador de cabeza plana.

► La regulación se debe efectuar partiendo de la posición standard. Para encontrar tal posición es necesario girar en sentido contrario a las agujas del reloj hasta el tope, después en sentido horario hasta la posición standard (véase tabla adjunta). Gire en sentido horario para aumentar la precarga muelle, o bien gire en sentido contrario a las agujas del reloj para disminuirla.

► Cuando las operaciones de ajuste se han completado, vuelva a conectar el conector y colocar la funda de protección.





5.7. Ajuste proyector delantero

Colocar el vehículo a 10 metros de distancia de una pared vertical.

Asegurarse que el piso esté plano y que el eje óptico del proyector se encuentre perpendicular a la pared. El vehículo debe estar en posición vertical. Medir la altura del centro del proyector desde el suelo y marcar a esa altura la pared con una cruz.

Prendiendo la luz de cruce, el límite de demarcación entre la zona oscura y la zona iluminada debe resultar a una altura no superior a $9/10$ de la altura desde el suelo del centro del proyector.

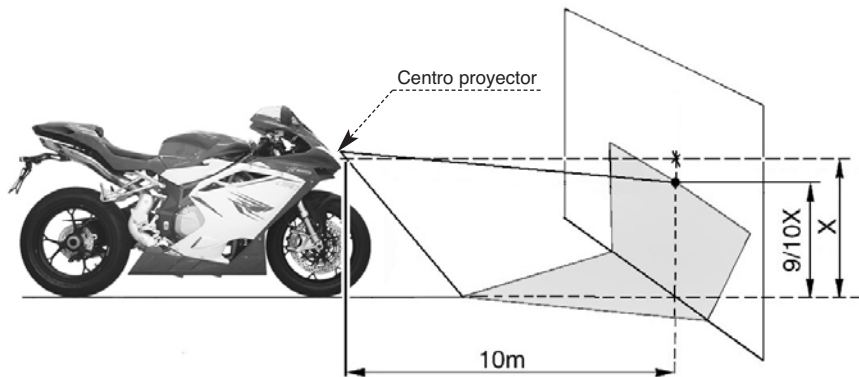



La regulación vertical del haz luminoso se puede efectuar actuando sobre el tornillo mostrado al lado. En sentido horario: el grupo óptico se inclina hacia arriba. En sentido antihorario: el grupo óptico se inclina hacia abajo. La inclinación se puede variar $\pm 4^\circ$ respecto a la posición estándar.

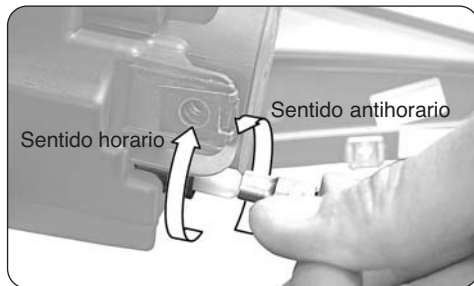



Nota informativa

MV Agusta S.p.A. está comprometida en una política de continuo mejoramiento de sus productos; por este motivo es posible encontrar ligeras diferencias entre el contenido de éste documento y el vehículo adquirido por Ustedes. Los modelos MV Agusta son exportados en muchos Países, en los cuales el Código del Transito y a los procedimientos de homologación son distintos a los nuestros.

Confiamos en Vuestra comprensión. MV Agusta S.p.A. considera por lo tanto necesario reservarse el derecho de aportar modificaciones a sus productos y a la documentación técnica en cualquier momento y sin ningún aviso previo.

Sugerimos para visitar a menudo el sitio Internet **www.mvagusta.it** para obtener informaciones y actualizaciones sobre los productos MV Agusta y la documentación relacionada.



Respetemos y defendamos el medioambiente

Todo lo que hacemos tiene repercusiones para todo el planeta y en sus recursos.

MV Agusta, a tutela de los intereses de la comunidad, sensibiliza los Clientes y los operadores de la asistencia técnica a adoptar una utilización del vehículo y de eliminación de sus partes, respetando plenamente las normativas vigentes en términos de contaminación del medio ambiente, eliminación y reciclaje de los deshechos.

© 2012

Está prohibida la reproducción aunque sea parcial de éste documento sin el consentimiento escrito por MV Agusta S.p.A.

Part. n° 8000B7637

Edición n° 1 - Noviembre 2012



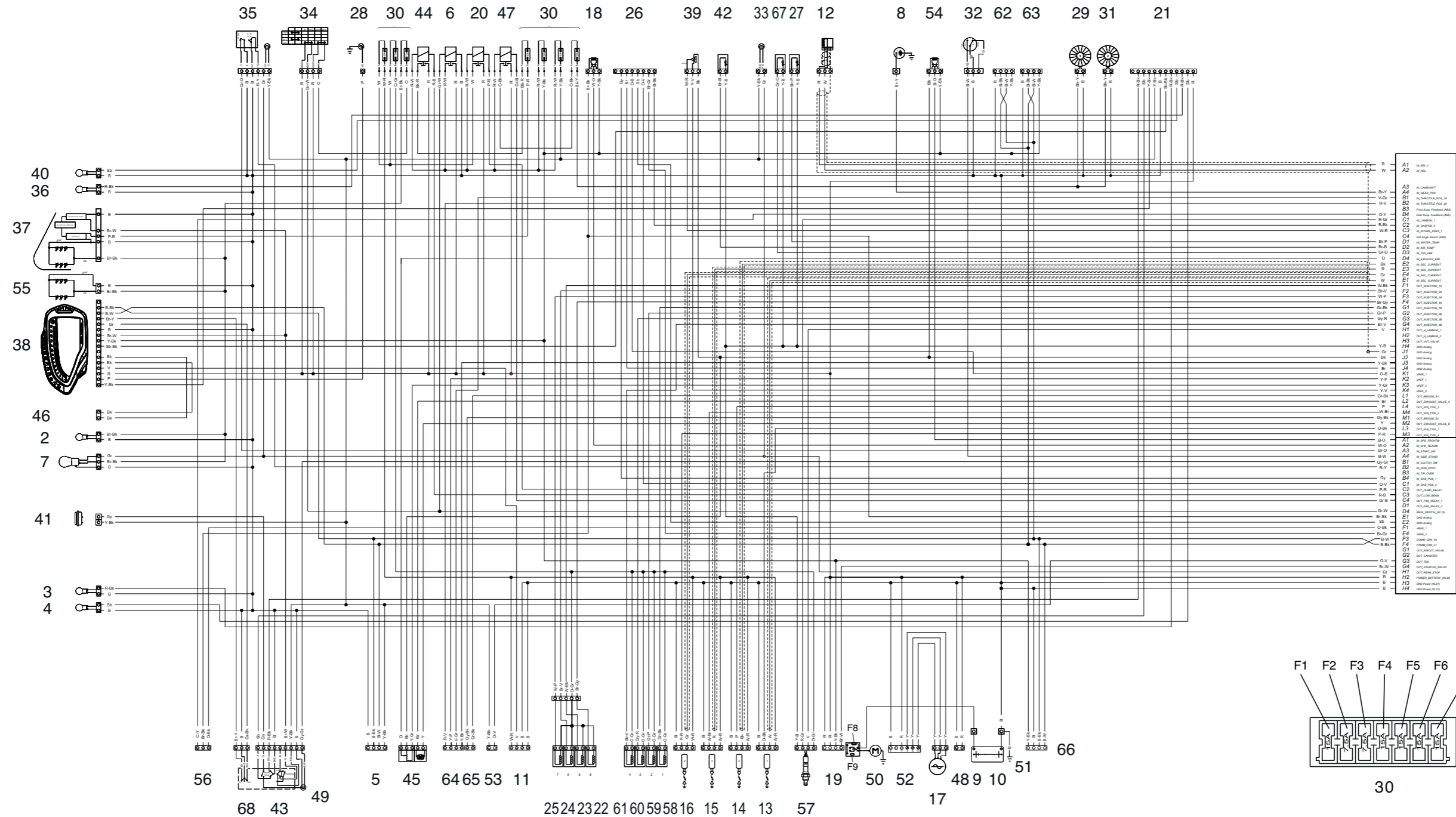

Rif.	Descrizione
1	Centralina
2	Luce targa
3	Indicatore posteriore destro
4	Indicatore anteriore sinistro
5	Connettore diagnosi
6	Relé principale
7	Fanale posteriore - Stop
8	Sensore cambio
9-10	Batteria
11	Pompa - Sonda benzina
12	Sensore giri motore
13-14	Bobine
15-16	Bobine
17	Alternatore
18	Sensore velocità posteriore
19	Teleruttore
20	Relé alimentazione generale
21	Intermittenza

Rif.	Descrizione
22-23	Iniettori superiori
24-25	Iniettori superiori
26	Potenziometro farfalla
27	Sensore temperatura acqua
28	Interruttore olio
29	Elettroventola
30	Fusibili
31	Elettroventola
32	Interruttore stampella laterale
33	Interruttore stop posteriore
34	Interruttore chiave
35	Interruttore di sicurezza e stop anteriore
36	Indicatore anteriore destro
37	Fanale anteriore
38	Cruscotto
39	Sensore pressione aria

Rif.	Descrizione
40	Indicatore posteriore sinistro
41	Avvisatore acustico
42	Sensore temperatura aria
43	Interruttore luci
44	Relé luci
45	Attuatore valvola di scarico
46	Antenna Immobilizer
47	Relé ventole
48	Ricarica batteria
49	Interruttore frizione
50	Motorino avviamento
51	Massa motore
52	Regolatore di tensione
53	Valvola TSS
54	Sensore velocità anteriore
55	Luci di posizione
56	Cambio rapido (Quick Shift)
57	Sonda lambda

Rif.	Descrizione
58-59	Iniettori inferiori
60-61	Iniettori inferiori
62	Connessione TPMS
63	Sensore assetto
64	Posizione DBW (Drive by Wire)
65	Attuatore DBW (Drive by Wire)
66	Centralina gestione sospensioni (solo per F4 RR)
67	Sensore temperatura acqua per ventola
68	Pulsante SET/OK

Legenda colori cavi	
Lettera/e	Colore
R	Rosso
Y	Giallo
B	Blu
G	Verde
W	Bianco
Bk	Nero
P	Rosa
V	Viola
Sb	Azzurro
Gr	Grigio
O	Arancio
Br	Marrone

Nei colori combinati è indicato il colore di fondo e la marcatura. Es.: Br/Bk.

Legenda fusibili		
Rif.	Amperaggio (A)	Utilizzo
F1	15	Pompa benzina - Bobine
F2	7.5	Sonda Lambda - Iniettori
F3	7.5	Luci di posizione - Luce targa
F4	15	Ballast faro anteriore
F5	15	Relé principale - Sensori velocità - Cruscotto - Sensore assetto - TPMS - Centralina sospensioni
F6	15	Intermittenza - Avvisatore acustico - Luce stop - Diagnostica - TSS - Luce abbagliante
F7	15	Ventole di raffreddamento
F8	40	Ricarica batteria
F9	40	Scorta per ricarica batteria

Parts list		Parts list		Parts list		Parts list		Parts list	
Ref.	Description	Ref.	Description	Ref.	Description	Ref.	Description	Ref.	Description
1	Power unit	16	Coil	31	Heater fan	44	Light relay	58-59	Lower injectors
2	Plate light	17	Alternator	32	Side stand switch	45	Exhaust valve actuator	60-61	
3	Rear turn indicator, right hand	18	Rear speed sensor	33	Rear brake switch	46	Immobilizer Antenna	62	TPMS connection
4	Front turn indicator, left hand	19	Solenoid starter	34	Key switch	47	Heater fan relay	63	Lean angle sensor
5	Diagnosis connector	20	Main relay	35	Safety and front brake switch	48	Battery recharge	64	DBW (Drive by Wire) position
6	Main relay	21	Intermittence	36	Front turn indicator, right hand	49	Clutch switch	65	DBW (Drive by Wire) actuator
7	Brake light	22-23	Upper injectors	37	Front light	50	Starter	66	Suspension management unit (only for F4 RR)
8	Gear sensor	24-25		38	Display	51	Engine ground	67	
9-10	Battery	26	Throttle potentiometer	39	Air pressure sensor	52	Voltage regulator	68	SET/OK button
11	Pump - Low fuel probe	27	Water temperature sensor for power unit	40	Rear turn indicator, left hand	53	TSS valve		
12	Engine rpm sensor	28	Oil switch	41	Horn	54	Front speed sensor		
13	Coil	29	Heater fan	42	Air temperature sensor	55	Position lights		
14	Coil	30	Fuses	43	Light switch	56	Quick Shift		
15	Coil					57	Lambda sensor		

Wire colors list	
Letter(s)	Color
R	Red
Y	Yellow
B	Blue
G	Green
W	White
Bk	Black
P	Pink
V	Violet
Sb	Sky blue
Gr	Grey
O	Orange
Br	Brown

In combined colors, background and marking colors have been pointed out. E.g.: Br/Bk.

Fuses list		
Ref.	Amperage (A)	Application
F1	15	Fuel pump - Coils
F2	7.5	Lambda sensor - Injectors
F3	7.5	Position lights - Plate light
F4	15	Front light ballast
F5	15	Main relay - Speed sensors - Dashboard - Lean angle sensor - TPMS - Suspension unit
F6	15	Intermittence - Horn - Stop light - Diagnostic - TSS - High beam
F7	15	Electric fans
F8	40	Battery recharge
F9	40	Battery recharge supply

Légende des composants		Légende des composants		Légende des composants		Légende des composants		Légende des composants	
Ref.	Description	Ref.	Description	Ref.	Description	Ref.	Description	Ref.	Description
1	Boîtier d'allumage	16	Bobine	31	Electroventilateur	44	Relais feux	57	Sonde Lambda
2	Eclaireur de plaque	17	Alternateur	32	Contacteur de béquille latérale	45	Actuateur soupape d'échappement	58-59	Injecteurs inférieurs
3	Clignotant arrière D	18	Capteur de vitesse arrière	33	Contacteur de stop arrière	46	Antenne système Immobilizer	60-61	
4	Clignotant avant G.	19	Télérupteur	34	Contacteur principal à clé	47	Relais ventilateurs	62	Connecteur TPMS
5	Connecteur diagnostic	20	Relais alimentation générale	35	Contacteur de sûreté et stop avant	48	Charge batterie	63	Capteur d'inclinaison
6	Relais principal	21	Centrale clignotante	36	Clignotant avant D.	49	Contacteur embrayage	64	Position DBW (Drive by Wire)
7	Feu arrière "Stop"	22-23	Injecteurs supérieurs	37	Feu avant	50	Démarrateur électrique	65	Actuateur DBW (Drive by Wire)
8	Capteur boîte de vitesse	24-25		38	Tableau de bord	51	Masse moteur	66	Unité de gestion des suspensions (seulement pour F4 RR)
9-10	Batterie	26	Potentiomètre papillon	39	Capteur pour pression air	52	Régulateur de tension	67	Capteur de température d'eau pour ventilateur
11	Pompe - Sonde essence	27	Capteur de température d'eau pour boîtier	40	Clignotant arrière G.	53	Valve TSS	68	Bouton SET/OK
12	Capteur compte tours	28	Manocontact d'huile	41	Avertisseur sonore	54	Capteur de vitesse avant		
13	Bobine	29	Electroventilateur	42	Capteur pour température air	55	Feux de position		
14	Bobine	30	Fusibles	43	Contacteur d'éclairage	56	Changement de vitesse rapide		

Légende couleur des câbles	
Lettre(s)	Couleur
R	Rouge
Y	Jaune
B	Bleu
G	Vert
W	Blanc
Bk	Noir
P	Rose
V	Violet
Sb	Bleu ciel
Gr	Gris
O	Orange
Br	Marron

Pour les couleurs combinés, la couleur de fond et le marquage sont indiqués. Par ex. Br/Bk.

Légende des fusibles		
Ref.	Ampérage (A)	Emploi
F1	15	Pompe à carburante - Bobines
F2	7.5	Sonde Lambda - Injecteurs
F3	7.5	Feux de position - Feu éclaireur de plaque
F4	15	Ballast feu avant
F5	15	Relais principal - Capteurs de vitesse - Tableau de bord - Capteur d'inclinaison - TPMS - Unité suspensions
F6	15	Centrale clignotante - Claxon - Feu stop - Diagnostic - TSS - Feu de route
F7	15	Electroventilateurs
F8	40	Charge batterie
F9	40	Réserve recharge batterie

Zeichenerklärung Bauteile		Zeichenerklärung Bauteile		Zeichenerklärung Bauteile		Zeichenerklärung Bauteile		Zeichenerklärung Bauteile	
Nr.	Beschreibung	Nr.	Beschreibung	Nr.	Beschreibung	Nr.	Beschreibung	Nr.	Beschreibung
1	Zündbox	16	Spule	31	Gebälse	44	Relais Beleuchtung	58-59	Untere Einspritzdüsen
2	Nummernschildbeleuchtung	17	Lichtmaschine	32	Schalter Seitenständer	45	Trieb Auslassventil	60-61	
3	Hinterer rechter Blinker	18	Hinterer Geschwindigkeitssensor	33	Hinterer Bremslichtschalter	46	Immobilizer -Antenna	62	Anschluss TPMS
4	Vorderer linker Blinker	19	Fernrelais	34	Zündschloß	47	Gebälserelais	63	Neigung-Sensor
5	Diagnoseanschluß	20	Relais Hauptversorgung	35	Sicherheits- und vorderer Bremslichtschalter	48	Batterieladung	64	Position DBW (Drive by Wire)
6	Hauptrelais	21	Blinkgeber	36	Vorderer rechter Blinker	49	Kupplungsschalter	65	Trieb DBW (Drive by Wire)
7	Rücklicht - Bremslicht	22-23	Obere Einspritzdüsen	37	Vorderer Scheinwerfer	50	Anlassermotor	66	Steuerung-Einheit für Federung (nur für F4 RR)
8	Gangsensor	24-25		38	Armaturenbrett	51	Masse Motor	67	Temperaturfühler Wassertemperatur für Gebläse
9-10	Batterie	26	Potentiometer Drosselventil	39	Drucksensor von Luft	52	Spannungs-Regler	68	Taste SET/OK
11	Pumpe - Benzinstandgeber	27	Temperaturfühler Wassertemperatur für Zündbox	40	Hinterer linker Blinker	53	Ventil TSS		
12	Sensor Motordrehzahl	28	Öldruckschalter	41	Hupe	54	Vorderer Geschwindigkeitssensor		
13	Spule	29	Gebälse	42	Sensor für Lufttemperatur	55	Standlicht		
14	Spule	30	Sicherungen	43	Lichtschalter	56	Schnelle Gangwechsel		
15	Spule					57	Lambdasonde		

Zeichenerklärung Kabelfarben	
Buchstabe(n)	Farbe
R	Rot
Y	Gelb
B	Blau
G	Grün
W	Weiß
Bk	Schwarz
P	Rose
V	Violett
Sb	Hellblau
Gr	Grau
O	Orange
Br	Braun

Bei Farbkombinationen wird die Grundfarbe und die Markierung angegeben. Z. B. Br/Bk.

Zeichenerklärung Sicherungen		
Nr.	Ampereleistung (A)	Einsatz
F1	15	Benzinpumpe - Spulen
F2	7.5	Lambda-Sonde - Einspritzventile
F3	7.5	Standlicht - Nummernschildbeleuchtung
F4	15	Ballast vorderer Scheinwerfer
F5	15	Hauptrelais - Geschwindigkeitssensoren - Armaturenbrett - Neigung-Sensor - TPMS - Federung-Einheit
F6	15	Blinkgeber - Hupe - Bremslicht - Diagnose - TSS - Fernlicht
F7	15	Gebälse
F8	40	Batterieladung
F9	40	Ersatz für Batterieladung

Leyenda Componentes		Leyenda Componentes		Leyenda Componentes		Leyenda Componentes		Leyenda Componentes	
Ref.	Descripción	Ref.	Descripción	Ref.	Descripción	Ref.	Descripción	Ref.	Descripción
1	Central	16	Bobina	31	Electroventilador	44	Relé de las luces	58-59	Inyectores inferiores
2	Luz matrícula	17	Alternador	32	Interruptor pata lateral	45	Accionador válvula de escape	60-61	
3	Indicador trasero derecho	18	Sensor trasero velocidad	33	Interruptor stop trasero	46	Antena Immobilizer	62	Conexión TPMS
4	Indicador delantero izquierdo	19	Teleruptor	34	Interruptor llave	47	Relé ventiladores	63	Sensor de inclinación
5	Conector diagnóstico	20	Relé alimentación general	35	Interruptor de seguridad y stop delantero	48	Recarga batería	64	Posición DBW (Drive by Wire)
6	Relé principal	21	Intermitencia	36	Indicador delantero derecho	49	Interruptor embrague	65	Accionador DBW (Drive by Wire)
7	Faro trasero - Stop	22-23	Inyectores superiores	37	Faro delantero	50	Motor de arranque	66	Central gestión suspensiones (sólo para F4 RR)
8	Sensor cambio	24-25		38	Cuadro mandos	51	Masa motor	67	Sensor temperatura agua para ventilador
9-10	Batería	26	Potenciómetro mariposa	39	Sensor presión aire	52	Regolador de tensión	68	Pulsador SET/OK
11	Bomba - Sonda gasolina	27	Sensor temperatura agua para central	40	Indicador trasero izquierdo	53	Válvula TSS		
12	Sensor revoluciones motor	28	Interruptor aceite	41	Claxon	54	Sensor delantero velocidad		
13	Bobina	29	Electroventilador	42	Sensor temperatura aire	55	Luces de posición		
14	Bobina	30	Fusibles	43	Interruptor luces	56	Cambio rápido		
15	Bobina					57	Sonda Lambda		

Leyenda colores cables	
Letra/s	Color
R	Rojo
Y	Amarillo
B	Azul marino
G	Verde
W	Blanco
Bk	Negro
P	Rosa
V	Violeta
Sb	Azul
Gr	Gris
O	Naranja
Br	Marrón

En los colores combinados se indica el color de fondo y la marcación Ej. Br/Bk.

Leyenda fusibles		
Ref.	Amperaje (A)	Utilización
F1	15	Bomba carburante - Bobinas
F2	7.5	Sonda Lambda - Inyectores
F3	7.5	Luz posición - Luz matrícula
F4	15	Ballast faro delantero
F5	15	Relé principal - Sensor velocidad - Cuadro mandos - Sensor inclinación - TPMS - Central suspensiones
F6	15	Intermitencia - Claxon - Luz stop - TSS - Luz de carretera
F7	15	Electroventiladores
F8	40	Recarga batería
F9	40	Repuesto recarga batería

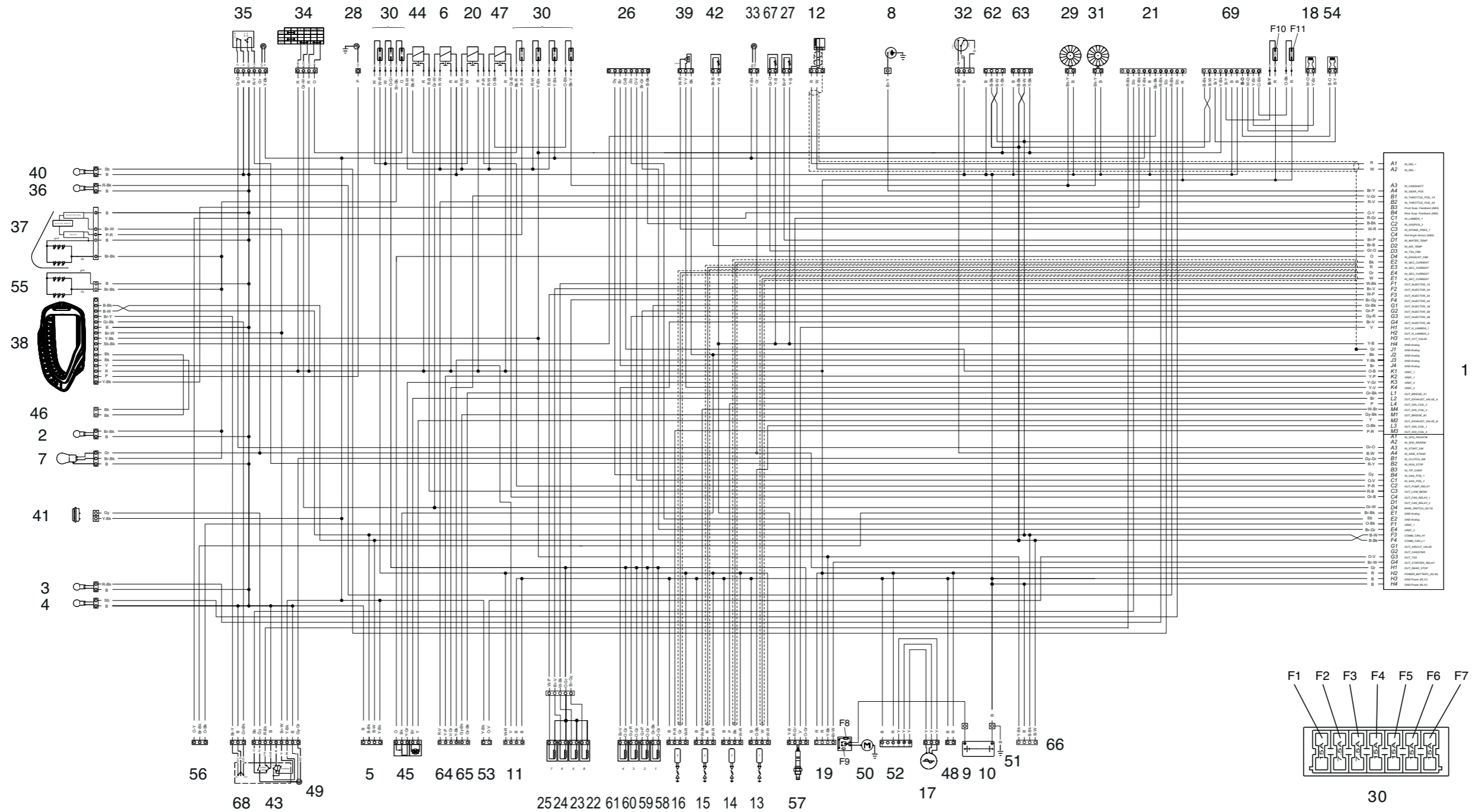

Rif.	Descrizione
1	Centralina
2	Luce targa
3	Indicatore posteriore destro
4	Indicatore anteriore sinistro
5	Connettore diagnosi
6	Relé principale
7	Fanale posteriore - Stop
8	Sensore cambio
9-10	Batteria
11	Pompa - Sonda benzina
12	Sensore giri motore
13-14	Bobine
15-16	Bobine
17	Alternatore
18	Sensore velocità posteriore
19	Teleruttore
20	Relé alimentazione generale
21	Intermittenza

Rif.	Descrizione
22-23	Iniettori superiori
24-25	Iniettori superiori
26	Potenzimetro farfalla
27	Sensore temperatura acqua per centralina
28	Interruttore olio
29	Elettroventola
30	Fusibili
31	Elettroventola
32	Interruttore stampella laterale
33	Interruttore stop posteriore
34	Interruttore chiave
35	Interruttore di sicurezza e stop anteriore
36	Indicatore anteriore destro
37	Fanale anteriore
38	Cruscotto
39	Sensore pressione aria

Rif.	Descrizione
40	Indicatore posteriore sinistro
41	Avvisatore acustico
42	Sensore temperatura aria
43	Interruttore luci
44	Relé luci
45	Attuatore valvola di scarico
46	Antenna Immobilizer
47	Relé ventole
48	Ricarica batteria
49	Interruttore frizione
50	Motorino avviamento
51	Massa motore
52	Regolatore di tensione
53	Valvola TSS
54	Sensore velocità anteriore
55	Luci di posizione
56	Cambio rapido (Quick Shift)
57	Sonda lambda

Rif.	Descrizione
58-59	Iniettori inferiori
60-61	Iniettori inferiori
62	Connessione TPMS
63	Sensore assetto
64	Posizione DBW (Drive by Wire)
65	Attuatore DBW (Drive by Wire)
66	Centralina gestione sospensioni (solo per F4 RR)
67	Sensore temperatura acqua per ventola
68	Pulsante SET/OK
69	Modulo ABS

Legenda colori cavi	
Lettera/e	Colore
R	Rosso
Y	Giallo
B	Blu
G	Verde
W	Bianco
Bk	Nero
P	Rosa
V	Viola
Sb	Azzurro
Gr	Grigio
O	Arancio
Br	Marrone

Nei colori combinati è indicato il colore di fondo e la marcatura. Es.: Br/Bk.

Legenda fusibili		
Rif.	Amperaggio (A)	Utilizzo
F1	15	Pompa benzina - Bobine
F2	7.5	Sonda Lambda - Iniettori
F3	7.5	Luci di posizione - Luce targa
F4	15	Ballast faro anteriore
F5	15	Relé principale - Sensori velocità - Cruscotto - Sensore assetto - TPMS - Centralina sospensioni
F6	15	Intermittenza - Avvisatore acustico - Luce stop - Diagnostica - TSS - Luce abbagliante
F7	15	Ventole di raffreddamento
F8	40	Ricarica batteria
F9	40	Scorta per ricarica batteria
F10	15	Sistema ABS
F11	25	Sistema ABS

Parts list		Parts list		Parts list		Parts list		Parts list	
Ref.	Description	Ref.	Description	Ref.	Description	Ref.	Description	Ref.	Description
1	Power unit	16	Coil	31	Heater fan	44	Light relay	58-59	Lower injectors
2	Plate light	17	Alternator	32	Side stand switch	45	Exhaust valve actuator	60-61	
3	Rear turn indicator, right hand	18	Rear speed sensor	33	Rear brake switch	46	Immobilizer Antenna	62	TPMS connection
4	Front turn indicator, left hand	19	Solenoid starter	34	Key switch	47	Heater fan relay	63	Lean angle sensor
5	Diagnosis connector	20	Main relay	35	Safety and front brake switch	48	Battery recharge	64	DBW (Drive by Wire) position
6	Main relay	21	Intermittence	36	Front turn indicator, right hand	49	Clutch switch	65	DBW (Drive by Wire) actuator
7	Brake light	22-23	Upper injectors	37	Front light	50	Starter	66	Suspension management unit (only for F4 RR)
8	Gear sensor	24-25		38	Display	51	Engine ground	67	Water temperature sensor for heater fan
9-10	Battery	26	Throttle potentiometer	39	Air pressure sensor	52	Voltage regulator	68	SET/OK button
11	Pump - Low fuel probe	27	Water temperature sensor for power unit	40	Rear turn indicator, left hand	53	TSS valve	69	ABS unit
12	Engine rpm sensor	28	Oil switch	41	Horn	54	Front speed sensor		
13	Coil	29	Heater fan	42	Air temperature sensor	55	Position lights		
14	Coil	30	Fuses	43	Light switch	56	Quick Shift		
15	Coil					57	Lambda sensor		

Wire colors list	
Letter(s)	Color
R	Red
Y	Yellow
B	Blue
G	Green
W	White
Bk	Black
P	Pink
V	Violet
Sb	Sky blue
Gr	Grey
O	Orange
Br	Brown

In combined colors, background and marking colors have been pointed out. E.g.: Br/Bk.

Fuses list		
Ref.	Amperage (A)	Application
F1	15	Fuel pump - Coils
F2	7.5	Lambda sensor - Injectors
F3	7.5	Position lights - Plate light
F4	15	Front light ballast
F5	15	Main relay - Speed sensors - Dashboard - Lean angle sensor - TPMS - Suspension unit
F6	15	Intermittence - Horn - Stop light - Diagnostic - TSS - High beam
F7	15	Electric fans
F8	40	Battery recharge
F9	40	Battery recharge supply
F10	15	ABS System
F11	25	ABS System

Légende des composants		Légende des composants		Légende des composants		Légende des composants		Légende des composants	
Réf.	Description	Réf.	Description	Réf.	Description	Réf.	Description	Réf.	Description
1	Boîtier d'allumage	16	Bobine	31	Electroventilateur	44	Relais feux	57	Sonde Lambda
2	Eclaireur de plaque	17	Alternateur	32	Contacteur de béquille latérale	45	Actuateur soupape d'échappement	58-59	Injecteurs inférieurs
3	Clignotant arrière D	18	Capteur de vitesse arrière	33	Contacteur de stop arrière	46	Antenne système Immobilizer	60-61	
4	Clignotant avant G.	19	Télérupteur	34	Contacteur principal à clé	47	Relais ventilateurs	62	Connecteur TPMS
5	Connecteur diagnostic	20	Relais alimentation générale	35	Contacteur de sûreté et stop avant	48	Charge batterie	63	Capteur d'inclinaison
6	Relais principal	21	Centrale clignotante	36	Clignotant avant D.	49	Contacteur embrayage	64	Position DBW (Drive by Wire)
7	Feu arrière "Stop"	22-23	Injecteurs supérieurs	37	Feu avant	50	Démarrateur électrique	65	Actuateur DBW (Drive by Wire)
8	Capteur boîte de vitesse	24-25		38	Tableau de bord	51	Masse moteur	66	Unité de gestion des suspensions (seulement pour F4 RR)
9-10	Batterie	26	Potentiomètre papillon	39	Capteur pour pression air	52	Régulateur de tension	67	Capteur de température d'eau pour ventilateur
11	Pompe - Sonde essence	27	Capteur de température d'eau pour boîtier	40	Clignotant arrière G.	53	Valve TSS	68	Bouton SET/OK
12	Capteur compte tours	28	Manocontact d'huile	41	Avertisseur sonore	54	Capteur de vitesse avant	69	Module ABS
13	Bobine	29	Electroventilateur	42	Capteur pour température air	55	Feux de position		
14	Bobine	30	Fusibles	43	Contacteur d'éclairage	56	Changement de vitesse rapide		

Légende couleur des câbles	
Lettre(s)	Couleur
R	Rouge
Y	Jaune
B	Bleu
G	Vert
W	Blanc
Bk	Noir
P	Rose
V	Violet
Sb	Bleu ciel
Gr	Gris
O	Orange
Br	Marron

Pour les couleurs combinés, la couleur de fond et le marquage sont indiqués. Par ex. Br/Bk.

Légende des fusibles		
Réf.	Ampérage (A)	Emploi
F1	15	Pompe à carburante - Bobines
F2	7.5	Sonde Lambda - Injecteurs
F3	7.5	Feux de position - Feu éclaireur de plaque
F4	15	Ballast feu avant
F5	15	Relais principal - Capteurs de vitesse - Tableau de bord - Capteur d'inclinaison - TPMS - Unité suspensions
F6	15	Centrale clignotante - Claxon - Feu stop - Diagnostic - TSS - Feu de route
F7	15	Electroventilateurs
F8	40	Charge batterie
F9	40	Réserve recharge batterie
F10	15	Système ABS
F11	25	Système ABS

Zeichenerklärung Bauteile		Zeichenerklärung Bauteile		Zeichenerklärung Bauteile		Zeichenerklärung Bauteile		Zeichenerklärung Bauteile	
Nr.	Beschreibung	Nr.	Beschreibung	Nr.	Beschreibung	Nr.	Beschreibung	Nr.	Beschreibung
1	Zündbox	16	Spule	31	Gebälse	44	Relais Beleuchtung	58-59	Untere Einspritzdüsen
2	Nummernschildbeleuchtung	17	Lichtmaschine	32	Schalter Seitenständer	45	Trieb Auslassventil	60-61	
3	Hinterer rechter Blinker	18	Hinterer Geschwindigkeitssensor	33	Hinterer Bremslichtschalter	46	Immobilizer -Antenna	62	Anschluss TPMS
4	Vorderer linker Blinker	19	Fernrelais	34	Zündschloß	47	Gebälserelais	63	Neigung-Sensor
5	Diagnoseanschluß	20	Relais Hauptversorgung	35	Sicherheits- und vorderer Bremslichtschalter	48	Batterieladung	64	Position DBW (Drive by Wire)
6	Hauptrelais	21	Blinkgeber	36	Vorderer rechter Blinker	49	Kupplungsschalter	65	Trieb DBW (Drive by Wire)
7	Rücklicht - Bremslicht	22-23	Obere Einspritzdüsen	37	Vorderer Scheinwerfer	50	Anlassermotor	66	Steuerung-Einheit für Federung (nur für F4 RR)
8	Gangsensor	24-25		38	Armaturenbrett	51	Masse Motor	67	Temperaturfühler Wassertemperatur für Gebläse
9-10	Batterie	26	Potentiometer Drosselventil	39	Drucksensor von Luft	52	Spannungs-Regler		
11	Pumpe - Benzinstandgeber	27	Temperaturfühler Wassertemperatur für Zündbox	40	Hinterer linker Blinker	53	Ventil TSS	68	Taste SET/OK
12	Sensor Motordrehzahl	28	Öldruckschalter	41	Hupe	54	Vorderer Geschwindigkeitssensor	69	ABS-Einheit
13	Spule	29	Gebälse	42	Sensor für Lufttemperatur	55	Standlicht		
14	Spule	30	Sicherungen	43	Lichtschalter	56	Schnelle Gangwechsel		
15	Spule					57	Lambdasonde		

Zeichenerklärung Kabelfarben	
Buchstabe(n)	Farbe
R	Rot
Y	Gelb
B	Blau
G	Grün
W	Weiß
Bk	Schwarz
P	Rose
V	Violett
Sb	Hellblau
Gr	Grau
O	Orange
Br	Braun

Bei Farbkombinationen wird die Grundfarbe und die Markierung angegeben. Z. B. Br/Bk.

Zeichenerklärung Sicherungen		
Nr.	Ampereleistung (A)	Einsatz
F1	15	Benzinpumpe - Spulen
F2	7.5	Lambda-Sonde - Einspritzventile
F3	7.5	Standlicht - Nummernschildbeleuchtung
F4	15	Ballast vorderer Scheinwerfer
F5	15	Hauptrelais - Geschwindigkeitssensoren - Armaturenbrett - Neigung-Sensor - TPMS - Federung-Einheit
F6	15	Blinkgeber - Hupe - Bremslicht - Diagnose - TSS - Fernlicht
F7	15	Gebälse
F8	40	Batterieladung
F9	40	Ersatz für Batterieladung
F10	15	ABS-System
F11	25	ABS-System

Leyenda Componentes		Leyenda Componentes		Leyenda Componentes		Leyenda Componentes		Leyenda Componentes	
Ref.	Descripción	Ref.	Descripción	Ref.	Descripción	Ref.	Descripción	Ref.	Descripción
1	Central	16	Bobina	31	Electroventilador	44	Relé de las luces	58-59	Inyectores inferiores
2	Luz matrícula	17	Alternador	32	Interruptor pata lateral	45	Accionador válvula de escape	60-61	
3	Indicador trasero derecho	18	Sensor trasero velocidad	33	Interruptor stop trasero	46	Antena Immobilizer	62	Conexión TPMS
4	Indicador delantero izquierdo	19	Teleruptor	34	Interruptor llave	47	Relé ventiladores	63	Sensor de inclinación
5	Conector diagnóstico	20	Relé alimentación general	35	Interruptor de seguridad y stop delantero	48	Recarga batería	64	Posición DBW (Drive by Wire)
6	Relé principal	21	Intermitencia	36	Indicador delantero derecho	49	Interruptor embrague	65	Accionador DBW (Drive by Wire)
7	Faro trasero - Stop	22-23	Inyectores superiores	37	Faro delantero	50	Motor de arranque	66	Central gestión suspensiones (sólo para F4 RR)
8	Sensor cambio	24-25		38	Cuadro mandos	51	Masa motor	67	Sensor temperatura agua para ventilador
9-10	Batería	26	Potenciómetro mariposa	39	Sensor presión aire	52	Regolador de tensión		
11	Bomba - Sonda gasolina	27	Sensor temperatura agua para central	40	Indicador trasero izquierdo	53	Válvula TSS	68	Pulsador SET/OK
12	Sensor revoluciones motor	28	Interruptor aceite	41	Claxon	54	Sensor delantero velocidad	69	Módulo ABS
13	Bobina	29	Electroventilador	42	Sensor temperatura aire	55	Luces de posición		
14	Bobina	30	Fusibles	43	Interruptor luces	56	Cambio rápido		
15	Bobina					57	Sonda Lambda		

Leyenda colores cables	
Letra/s	Color
R	Rojo
Y	Amarillo
B	Azul marino
G	Verde
W	Blanco
Bk	Negro
P	Rosa
V	Violeta
Sb	Azul
Gr	Gris
O	Naranja
Br	Marrón

En los colores combinados se indica el color de fondo y la marcación Ej. Br/Bk.

Leyenda fusibles		
Ref.	Amperaje (A)	Utilización
F1	15	Bomba carburante - Bobinas
F2	7.5	Sonda Lambda - Inyectores
F3	7.5	Luz posición - Luz matrícula
F4	15	Ballast faro delantero
F5	15	Relé principal - Sensor velocidad - Cuadro mandos - Sensor inclinación - TPMS - Central suspensiones
F6	15	Intermitencia - Claxon - Luz stop - TSS - Luz de carretera
F7	15	Electroventiladores
F8	40	Recarga batería
F9	40	Repuesto recarga batería
F10	15	Sistema ABS
F11	25	Sistema ABS

IT Fase 1: Effettuare la carica iniziale della batteria secondo le istruzioni riportate nella rispettiva confezione.

Fase 2: Inserire la chiave della motocicletta nella serratura posteriore. Ruotare la chiave in senso orario e contemporaneamente rimuovere la sella passeggero. Successivamente rimuovere la sella pilota come mostrato in figura.

Fase 3: Rimuovere la piastra del telaio allo scopo di facilitare le operazioni successive.

Fase 4: Rimuovere la vite di fissaggio del teleruttore di avviamento per permettere l'inserimento della batteria.

Fase 5: Inserire la batteria nell'apposito vano.

Fase 6: Montare il terminale positivo (+) sul relativo polo della batteria rispettando l'ordine indicato in figura. Ruotare la vite del terminale positivo ed effettuare il serraggio ad una coppia pari a $7 \div 8 \text{ Nm}$, quindi sistemare la **cuffia di protezione** sul polo positivo.

Fase 7: Montare il terminale negativo (-) sul relativo polo della batteria rispettando la disposizione mostrata in figura. Ruotare la vite del terminale negativo ed effettuare il serraggio ad una coppia pari a $7 \div 8 \text{ Nm}$.

Fase 8: Rimontare i componenti precedentemente rimossi seguendo in senso inverso le operazioni descritte nella fasi 2-3-4.

GB Phase 1: Perform the initial charge of the battery according to the instruction sheet enclosed in its package.

Phase 2: Insert the motorcycle key in the rear lock. Rotate the key clockwise while removing the pillion. Then remove the rider's saddle as shown in the picture.

Phase 3: Remove the frame plate to facilitate the following operations.

Phase 4: Remove the solenoid starter securing screw to allow the insertion of the battery.

Phase 5: Insert the battery in its proper compartment.

Phase 6: Fit the positive terminal (+) on the corresponding battery pole, respecting its disposition as shown in the figure. Rotate the positive terminal screw and tighten it at a torque equal to $7 \div 8 \text{ Nm}$. Afterwards, fit the **protective cap** on the positive pole.

Phase 7: Fit the negative terminal (-) on the corresponding battery pole, respecting its disposition as shown in the figure. Rotate the negative terminal screw and tighten it at a torque equal to $7 \div 8 \text{ Nm}$.

Phase 8: Reinstall disassembled parts by inversely performing the operations described in the phases 2-3-4.

FR Etape 1: Exécutez la charge initiale de la batterie selon les instructions incluses en son paquet.

Etape 2: Introduire la clé de la motocyclette dans la serrure postérieure. Tourner la clé dans le sens des aiguilles d'une montre et simultanément déposer la selle du passager. Ensuite déposer la selle du pilote comme montré en figure.

Etape 3: Déposer la plaque du petit châssis afin de faciliter les opérations suivantes.

Etape 4: Déposer la vis de fixation du telerupteur du démarreur per permettre l'insertion de la batterie.

Etape 5: Introduire la batterie dans son compartiment.

Etape 6: Monter la borne positive (+) sur le pôle correspondant de la batterie en respectant l'ordre indiqué dans la figure. Tourner la vis de la borne positive et la serrer à un couple égal à $7 \div 8 \text{ Nm}$, ensuite placer le **protecteur** sur le pôle positif.

Etape 7: Monter la borne négative (-) sur le pôle correspondant de la batterie en respectant la disposition indiquée sur la figure. Tourner la vis de la borne négative et la serrer à un couple égal à $7 \div 8 \text{ Nm}$.

Etape 8: Remettre en place les pièces enlevées en procédant dans l'ordre inverse par rapport aux opérations décrites aux étapes 2-3-4.

DE Phase 1: Führen Sie die Batterieaufladung, nach Instruktionen aus, die in seinem Paket eingeschlossen sind.

Phase 2: Den Motorradschlüssel in das hintere Schloss einstecken. Den Schlüssel in Uhrzeigersinn drehen und die Beifahrer-Sitzbank ausbauen. Anschließend die Fahrer-Sitzbank wie in der Abbildung gezeigt entfernen.

Phase 3: Die platte des Rahmen entfernen, zur Erleichterung der folgenden Vorgänge.

Phase 4: Die Befestigungsschrauben der Anlasser fernrelais entfernen, für die Einfügung der Batterie können.

Phase 5: Die Batterie in den dazu geeigneten Raum anbringen.

Phase 6: Die Plusendverschluss (+) auf den jeweiligen Pol der Batterie unter Berücksichtigung der auf der Abbildung angegebenen Anordnung montieren. Die Schraube der Plusendverschluss drehen und mit einem Drehmoment von $7 \div 8 \text{ Nm}$ festziehen. Nach der Montage den **Schutzkasten** auf dem Pluspol anlegen.

Phase 7: Die Minusendverschluss (-) auf den jeweiligen Pol der Batterie bei Berücksichtigung der auf der Abbildung angezeigten Anordnung montieren. Die Schraube der Minusendverschluss drehen und mit einem Drehmoment von $7 \div 8 \text{ Nm}$ festziehen.

Phase 8: Die losgemachten Einzelteile wieder anbringen die unter Phasen 2-3-4 angegebenen Vorgänge in umgekehrter Reihenfolge durchführen.

ES Fase 1: Realice la carga inicial de la batería según las instrucciones incluidas en su paquete.

Fase 2: Introducir la llave de la motocicleta en la cerradura posterior. Girar la llave en sentido de las agujas del reloj y al mismo tiempo extraer el sillín del pasajero. Luego extraer el sillín del piloto como se muestra en la foto.

Fase 3: Extraer la placa del bastidor para facilitar las operaciones siguientes.

Fase 4: Extraer el tornillo de sujeción del teleruptor de arranque para permitir la inserción de la batería.

Fase 5: Colocar la batería en su alojamiento.

Fase 6: Montar el terminal positivo (+) en el correspondiente polo de la batería respetando el orden indicado en la figura. Girar el tornillo del terminal positivo y efectuar el apriete a un par igual a $7 \div 8 \text{ Nm}$, luego colocar la **protección** en el polo positivo.

Fase 7: Montar el terminal negativo (-) en el correspondiente polo de la batería respetando la disposición mostrada en la figura. Girar el tornillo del terminal negativo y efectuar el apriete a un par igual a $7 \div 8 \text{ Nm}$.

Fase 8: Volver a montar nuevamente las partes precedentemente removidas siguiendo el sentido contrario a las operaciones descritas en la fases 2-3-4.

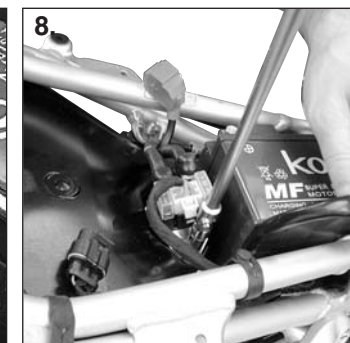
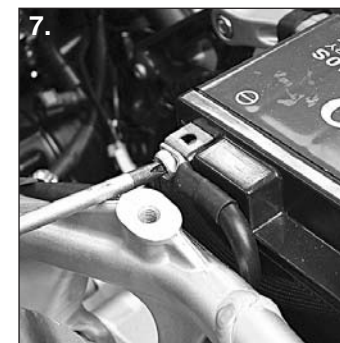
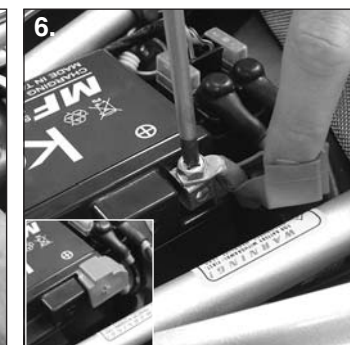
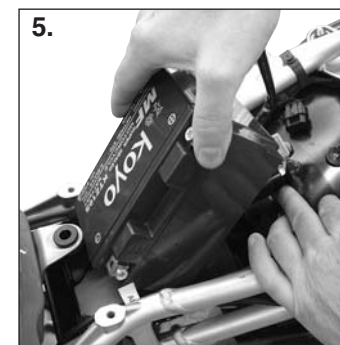
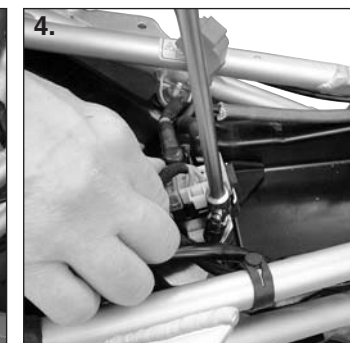
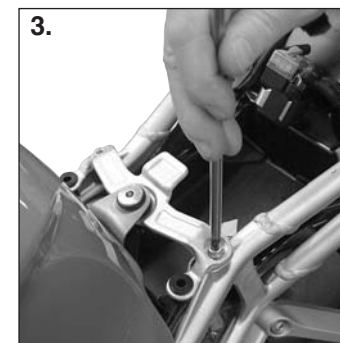
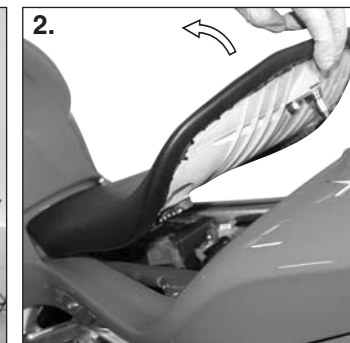
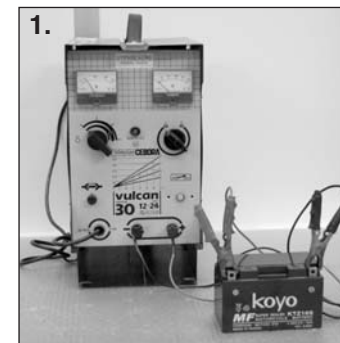

POLO POSITIVO (+)
POSITIVE POLE (+)
POLE POSITIF (+)
PLUSPOL (+)
POLO POSITIVO (+)

CAVO NEGATIVO (-)
NEGATIVE CABLE (-)
CABLE NEGATIF (-)
MINUSKABEL (-)
CABLE NEGATIVO (-)

POLO NEGATIVO (-)
NEGATIVE POLE (-)
POLE NEGATIF (-)
MINUSPOL (-)
POLO NEGATIVO (-)

CAVO POSITIVO (+)
POSITIVE CABLE (+)
CABLE POSITIF (+)
PLUSKABEL (+)
CABLE POSITIVO (+)

CAPPUCCIO DI PROTEZIONE
PROTECTIVE CAP
CAPUCHON DE PROTECTION
SCHUTZKASTEN
CAPUCHON DE PROTECCION



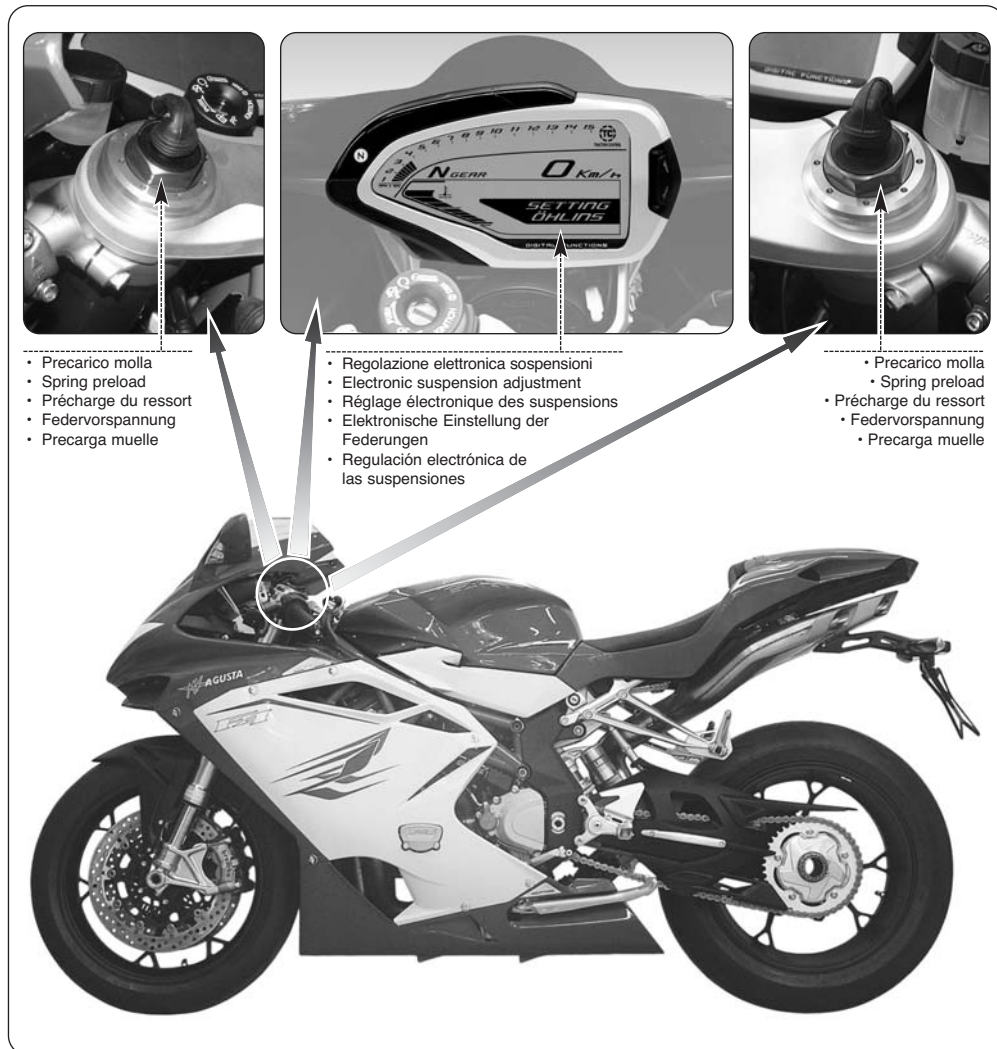

- Precarico molla
- Spring preload
- Précharge du ressort
- Federvorspannung
- Precarga muelle

- Regolazione elettronica sospensioni
- Electronic suspension adjustment
- Réglage électronique des suspensions
- Elektronische Einstellung der Federungen
- Regulación electrónica de las suspensiones

- Precarico molla
- Spring preload
- Précharge du ressort
- Federvorspannung
- Precarga muelle

(*) : La regolazione di questo parametro può essere effettuata solo tramite le funzioni digitali del cruscotto (vedi Manuale utente).
 - The adjustment of this parameter can be performed only by operating the digital functions of the dashboard (see User's manual).
 - Le réglage de ce paramètre peut être effectué que par l'utilisation des fonctions digitales du tableau de bord (voir Manuel d'utilisation).
 - Die Einstellung dieser Parameter kann nur durch Betätigung der digitalen Funktionen des Armaturenbretts durchgeführt werden (siehe Bedienungsanleitung).
 - El ajuste de este parámetro se puede realizar sólo utilizando las funciones digitales del tablero de instrumentos (ver Manual de uso).

(**) : Per l'utilizzo del veicolo in questa configurazione si consiglia di aumentare il precarico molla dell'ammortizzatore posteriore di **1 mm**. Questa operazione deve essere tassativamente eseguita da un concessionario MV Agusta. - To use the vehicle in this configuration, we suggest to increase the rear suspension spring preload of **1 mm**. This operation must be performed only by a MV Agusta authorized dealer. - Pour utiliser le véhicule dans cette configuration, nous suggérons d'augmenter la précharge de ressort de la suspension arrière de **1 mm**. Cette intervention doit être impérativement effectuée par un concessionnaire officiel MV Agusta. - Für das Verwenden des Trägers in dieser Konfiguration, schlagen wir vor, um die hintere Federungsfedervorspannung von **1 mm** zu erhöhen. Änderungen an der Trimmlage dürfen ausschließlich von MV Agusta Vertragshändlern vorgenommen werden. - Para usar el vehículo en esta configuración, sugerimos el aumento de la precarga del resorte de la suspensión trasera de **1 mm**. Dicha intervención debe ser realizada por un concesionario oficial MV Agusta.

			
Tipo di assetto - Type of geometry - Type d'assiette - Einstellungsart - Tipo de equilibrado			
F4 RR			
Sospensione anteriore Front suspension Suspension avant Vordere Federung Suspensión delantera	Normale Normal Normal Normal Normal	Sportiva ** Sport ** Sportif ** Sport ** Sportiva **	Pioggia Rain Pluie Regen Lluvia
Precarico molla Spring preload Précharge du ressort Federvorspannung Precarga muelle	7 giri turns tours Drehzahl revoluciones	8 giri turns tours Drehzahl revoluciones	7 giri turns tours Drehzahl revoluciones
Freno in compressione* Compression damping* Frein en compression* Kompressionsbremse* Freno en compresión*	10 scatti clicks emboîtements Rasten disparos	6 scatti clicks emboîtements Rasten disparos	20 scatti clicks emboîtements Rasten disparos
Freno in estensione* Rebound damping* Frein en détente* Ausdehnungsbremse* Freno en extensión*	13 scatti clicks emboîtements Rasten disparos	12 scatti clicks emboîtements Rasten disparos	18 scatti clicks emboîtements Rasten disparos
Ammortizzatore di sterzo* Steering vibration damper* Amortisseur de direction* Steuerungsdämpfer* Amortiguador de dirección*	Normale Normal Normal Normal Normal	Sportiva ** Sport ** Sportif ** Sport ** Sportiva **	Pioggia Rain Pluie Regen Lluvia
	10 scatti clicks emboîtements Rasten disparos	10 scatti clicks emboîtements Rasten disparos	10 scatti clicks emboîtements Rasten disparos
Sospensione posteriore Rear suspension Suspension arrière Hintere Federung Suspensión trasera	Normale Normal Normal Normal Normal	Sportiva ** Sport ** Sportif ** Sport ** Sportiva **	Pioggia Rain Pluie Regen Lluvia
Freno in compressione* Compression damping* Frein en compression* Kompressionsbremse* Freno en compresión*	17 scatti clicks emboîtements Rasten disparos	6 scatti clicks emboîtements Rasten disparos	22 scatti clicks emboîtements Rasten disparos
Freno in estensione* Rebound damping* Frein en détente* Ausdehnungsbremse* Freno en extensión*	15 scatti clicks emboîtements Rasten disparos	13 scatti clicks emboîtements Rasten disparos	18 scatti clicks emboîtements Rasten disparos



MV Agusta Motor S.p.A. - Via G. Macchi, 144
21100 - Schiranna (VA) - ITALY
www.mvagusta.it
Part. N. 8000B7637 Ed. n° 1