

FORD **ECOSPORT** Owner's Manual



The information contained in this publication was correct at the time of going to print. In the interest of continuous development, we reserve the right to change specifications, design or equipment at any time without notice or obligation. No part of this publication may be reproduced, transmitted, stored in a retrieval system or translated into any language in any form by any means without our written permission. Errors and omissions excepted.

© Ford Motor Company 2013

All rights reserved.

Part Number: CG3590en 08/2013 20130821212701

Table of Contents

Introduction

About This Manual.....	5
Symbols Glossary.....	5
Data Recording.....	7
Replacement Parts Recommendation.....	8
Mobile Communications Equipment.....	8

At a Glance

Front Exterior Overview.....	10
Vehicle Interior Overview.....	11
Instrument Panel Overview - Vehicles With: LHD.....	12
Instrument Panel Overview - Vehicles With: RHD.....	13
Rear Exterior Overview.....	15

Child Safety

Installing Child Seats.....	17
Child Seat Positioning.....	20
Child Safety Locks.....	24

Safety Belts

Fastening the Safety Belts.....	25
Safety Belt Height Adjustment.....	26
Safety Belt Minder.....	26

Supplementary Restraints System

Principle of Operation.....	28
Driver Airbag.....	28
Passenger Airbag.....	29
Side Airbags.....	30
Driver Knee Airbag.....	30
Side Curtain Airbags.....	30

Keys and Remote Controls

General Information on Radio Frequencies.....	32
--	----

Remote Control.....	32
Replacing a Lost Key or Remote Control.....	34

Locks

Locking and Unlocking.....	35
Keyless Entry.....	36
Tailgate.....	38

Security

Passive Anti-Theft System.....	40
Anti-Theft Alarm.....	40

Steering Wheel

Adjusting the Steering Wheel.....	43
Audio Control.....	43
Voice Control.....	44
Cruise Control.....	44

Wipers and Washers

Windshield Wipers.....	45
Autowipers.....	45
Windshield Washers.....	46
Rear Window Wiper and Washers.....	46

Lighting

General Information.....	48
Lighting Control.....	48
Autolamps.....	49
Daytime Running Lamps.....	49
Direction Indicators.....	50
Interior Lamps.....	50
Front Fog Lamps.....	50
Rear Fog Lamps.....	51
Headlamp Leveling.....	51

Windows and Mirrors

Power Windows.....	52
Exterior Mirrors.....	53

Table of Contents

Interior Mirror.....	54
----------------------	----

Instrument Cluster

Gauges.....	55
Warning Lamps and Indicators.....	56
Audible Warnings and Indicators.....	59

Information Displays

General Information.....	61
Trip Computer.....	62
Information Messages.....	63

Climate Control

Principle of Operation.....	69
Air Vents.....	69
Automatic Climate Control.....	70
Hints on Controlling the Interior Climate.....	71
Heated Windows.....	74

Seats

Sitting in the Correct Position.....	75
Head Restraints.....	75
Manual Seats.....	76
Rear Seats.....	77
Front Seat Armrest.....	79

Auxiliary Power Points

Auxiliary Power Points.....	80
Cigar Lighter.....	80

Storage Compartments

Center Console.....	82
Glasses Holder.....	82

Starting and Stopping the Engine

General Information.....	83
Ignition Switch.....	83
Keyless Starting.....	83

Steering Wheel Lock.....	85
Starting a Gasoline Engine.....	85
Starting a Diesel Engine.....	86
Diesel Particulate Filter.....	87
Switching Off the Engine.....	88

Fuel and Refueling

Safety Precautions.....	89
Fuel Quality - Gasoline.....	89
Fuel Quality - Diesel.....	90
Catalytic Converter.....	90
Running Out of Fuel.....	90
Refueling.....	91
Fuel Consumption.....	92
Fuel Consumption Figures - 1.0L EcoBoost™.....	92
Fuel Consumption Figures - 1.5L Duratec-16V Ti-VCT (81kW/110PS) - Sigma, Vehicles With: 5-Speed Manual Transmission.....	93
Fuel Consumption Figures - 1.5L Duratec-16V Ti-VCT (81kW/110PS) - Sigma, Vehicles With: 6-Speed Automatic Transmission.....	94
Fuel Consumption Figures - 1.5L Duratorq-TDCI.....	95

Transmission

Manual Transmission.....	96
Automatic Transmission.....	96
Hill Start Assist.....	99

Brakes

General Information.....	101
Hints on Driving With Anti-Lock Brakes.....	101
Parking Brake.....	101

Traction Control

Principle of Operation.....	103
Using Traction Control.....	103

Table of Contents

Stability Control

Principle of Operation.....	104
Using Stability Control.....	104

Parking Aids

Principle of Operation.....	105
Parking Aid.....	105

Cruise Control

Principle of Operation.....	107
Using Cruise Control.....	107

Driving Aids

Steering.....	108
---------------	-----

Load Carrying

General Information.....	109
Luggage Anchor Points.....	109
Luggage Covers.....	109
Roof Racks and Load Carriers.....	109

Towing

Towing a Trailer.....	111
Towing Points.....	111
Towing the Vehicle on Four Wheels.....	112

Driving Hints

Breaking-In.....	113
Economical Driving.....	113
Cold Weather Precautions.....	113
Driving Through Water.....	113
Floor Mats.....	114

Roadside Emergencies

Hazard Warning Flashers.....	115
Fuel Shutoff.....	115
Warning Triangle.....	115
Jump-Starting the Vehicle.....	115

Fuses

Fuse Box Locations.....	117
Fuse Specification Chart.....	118
Changing a Fuse.....	126

Maintenance

General Information.....	127
Opening and Closing the Hood.....	127
Under Hood Overview - 1.0L EcoBoost™.....	129
Under Hood Overview - 1.5L Duratec-16V Ti-VCT (81kW/110PS) - Sigma.....	130
Under Hood Overview - 1.5L Duratorq-TDCi (67kW/91PS).....	131
Engine Oil Dipstick - 1.0L EcoBoost™.....	132
Engine Oil Dipstick - 1.5L Duratec-16V Ti-VCT (81kW/110PS) - Sigma.....	132
Engine Oil Dipstick - 1.5L Duratorq-TDCi (67kW/91PS).....	132
Engine Oil Check.....	132
Engine Coolant Check.....	134
Brake and Clutch Fluid Check.....	134
Washer Fluid Check.....	135
Changing the 12V Battery.....	135
Changing a Bulb.....	136
Checking the Wiper Blades.....	140
Changing the Wiper Blades.....	140
Removing a Headlamp.....	142
Bulb Specification Chart.....	142
Changing the Engine Air Filter.....	143
Technical Specifications - 1.0L EcoBoost (90kW/120PS).....	143
Technical Specifications - 1.5L Duratec-16V Ti-VCT (81kW/110PS) - Sigma.....	144
Technical Specifications - 1.5L Duratorq-TDCi (67kW/91PS).....	145

Vehicle Care

Cleaning the Exterior.....	147
Cleaning the Interior.....	147

Table of Contents

Repairing Minor Paint Damage.....	148
Cleaning the Alloy Wheels.....	148

Wheels and Tires

General Information.....	149
Tire Care.....	149
Using Winter Tires.....	149
Using Snow Chains.....	149
Tire Pressure Monitoring System.....	150
Changing a Road Wheel.....	153
Technical Specifications.....	157

Capacities and Specifications

Vehicle Identification Plate.....	159
Vehicle Identification Number.....	160
Technical Specifications.....	160

Audio System

General Information.....	161
Audio unit - Vehicles With:	
AM/FM/CD.....	162
Audio unit.....	167
Compact Disc Player.....	171
Auxiliary Input Jack.....	175
USB Port.....	176
Audio Troubleshooting.....	176

SYNC™

General Information.....	177
Using Voice Recognition.....	178
Using SYNC™ With Your Phone.....	181
SYNC™ Applications and Services.....	191
Using SYNC™ With Your Media Player.....	196
SYNC™ Troubleshooting.....	200

Appendices

Electromagnetic compatibility.....	208
End User License Agreement.....	209

Introduction

ABOUT THIS MANUAL

Thank you for choosing Ford. We recommend that you take some time to get to know your vehicle by reading this manual. The more that you know about it, the greater the safety and pleasure you will get from driving it.

WARNING



Driving while distracted can result in loss of vehicle control, crash and injury. We strongly recommend that you use extreme caution when using any device that may take your focus off the road. Your primary responsibility is the safe operation of your vehicle. We recommend against the use of any handheld device while driving and encourage the use of voice-operated systems when possible. Make sure you are aware of all applicable local laws that may affect the use of electronic devices while driving.

Note: This manual describes product features and options available throughout the range of available models, sometimes even before they are generally available. It may describe options not fitted to your vehicle.

Note: Some of the illustrations in this manual may be used for different models, so may appear different to you on your vehicle. However, the essential information in the illustrations is always correct.

Note: Always use and operate your vehicle in line with all applicable laws and regulations.

Note: Pass on this manual when selling your vehicle. It is an integral part of the vehicle.

This manual may qualify the location of a component as left-hand side or right-hand side. The side is determined when facing forward in the seat.



E154903

- A Right-hand side
- B Left-hand side

Protecting the Environment

You must play your part in protecting the environment. Correct vehicle usage and the authorized disposal of waste, cleaning and lubrication materials are significant steps toward this aim.

SYMBOLS GLOSSARY

These are some of the symbols you may see on your vehicle.



Safety alert



See Owner's Manual



Air conditioning system



Anti-lock braking system



Avoid smoking, flames or sparks



Battery

Introduction



Battery acid



Explosive gas



Brake fluid - non petroleum based



Fan warning



Brake system



Fasten safety belt



Cabin air filter



Front airbag



Check fuel cap



Front fog lamps



Child safety door lock or unlock



Fuel pump reset



Child seat lower anchor



Fuse compartment



Child seat tether anchor



Hazard warning flashers



Cruise control



Heated rear window



Do not open when hot



Heated windshield



Engine air filter



Interior luggage compartment release



Engine coolant



Jack



Engine coolant temperature



Keep out of reach of children



Engine oil



Lighting control



Low tire pressure warning

Introduction



Maintain correct fluid level



Note operating instructions



Panic alarm



Parking aid



Parking brake



Power steering fluid



Power windows front/rear



Power window lockout



Service engine soon



Side airbag



Shield the eyes



Stability control



Windshield wash and wipe

DATA RECORDING

A large number of electronic components of your vehicle contain data storage modules temporarily or permanently storing technical data about the condition of the vehicle, events and errors.

In general, this technical information documents the condition of parts, modules, systems or the environment:

- Operating conditions of system components (e.g. filling levels).
- Status messages of the vehicle and its individual components (e.g. number of wheel revolutions/rotational speed, deceleration, lateral acceleration).
- Malfunction and defects in important system components (e.g. lighting and brake system).
- Vehicle reactions in particular driving situations (e.g. inflation of an airbag, activation of the stability regulation system).
- Environmental conditions (e.g. temperature).

These data are exclusively technical and help identification and correction of errors as well as optimisation of vehicle functions. Motion profiles indicating travelled routes cannot be created with these data.

If services are used (e.g. repair works, service processes, warranty cases, quality assurance), employees of the service network (including manufacturers) are able to read out this technical information from the event and error data storage modules using special diagnostic devices. If required, you will receive further information. After an error has been corrected, these data are deleted from the error storage module or they are constantly overwritten.

Introduction

When using the vehicle, situations may occur in which these technical data related to other information (accident report, damages on the vehicle, witness statements etc.) may be associated with a specific person - possibly, with the assistance of an expert.

Additional functions contractually agreed upon with the client (e.g. vehicle location in emergency cases) allow the transmission of particular vehicle data from the vehicle.

REPLACEMENT PARTS RECOMMENDATION

Your vehicle has been built to the highest standards using quality parts. We recommend that you demand the use of genuine Ford and Motorcraft parts whenever your vehicle requires scheduled maintenance or repair. You can clearly identify genuine Ford and Motorcraft parts by looking for the Ford, FoMoCo or Motorcraft branding on the parts or their packaging.

Scheduled Maintenance and Mechanical Repairs

One of the best ways for you to make sure that your vehicle provides years of service is to have it maintained in line with our recommendations using parts that conform to the specifications detailed in this Owner's Manual. Genuine Ford and Motorcraft parts meet or exceed these specifications.

Collision Repairs

We hope that you never experience a collision, but accidents do happen. Genuine Ford replacement collision parts meet our stringent requirements for fit, finish, structural integrity, corrosion protection and dent resistance. During vehicle

development we validate these parts deliver the intended level of protection as a whole system. A great way to know for sure you are getting this level of protection is to use genuine Ford replacement collision parts.

Warranty on Replacement Parts

Genuine Ford and Motorcraft replacement parts are the only replacement parts that benefit from a Ford Warranty. Damage caused to your vehicle as a result of the failure of non-Ford parts may not be covered by the Ford Warranty. For additional information, refer to the terms and conditions of the Ford Warranty.

MOBILE COMMUNICATIONS EQUIPMENT

Using mobile communications equipment is becoming increasingly important in the conduct of business and personal affairs. However, you must not compromise your own or others' safety when using such equipment. Mobile communications can enhance personal safety and security when appropriately used, particularly in emergency situations. Safety must be paramount when using mobile communications equipment to avoid negating these benefits. Mobile communication equipment includes, but is not limited to, cellular phones, pagers, portable email devices, text messaging devices and portable two-way radios.

Introduction

WARNING



Driving while distracted can result in loss of vehicle control, crash and injury. We strongly recommend that you use extreme caution when using any device that may take your focus off the road. Your primary responsibility is the safe operation of your vehicle. We recommend against the use of any hand-held device while driving and encourage the use of voice-operated systems when possible. Make sure you are aware of all applicable local laws that may affect the use of electronic devices while driving.

At a Glance

FRONT EXTERIOR OVERVIEW

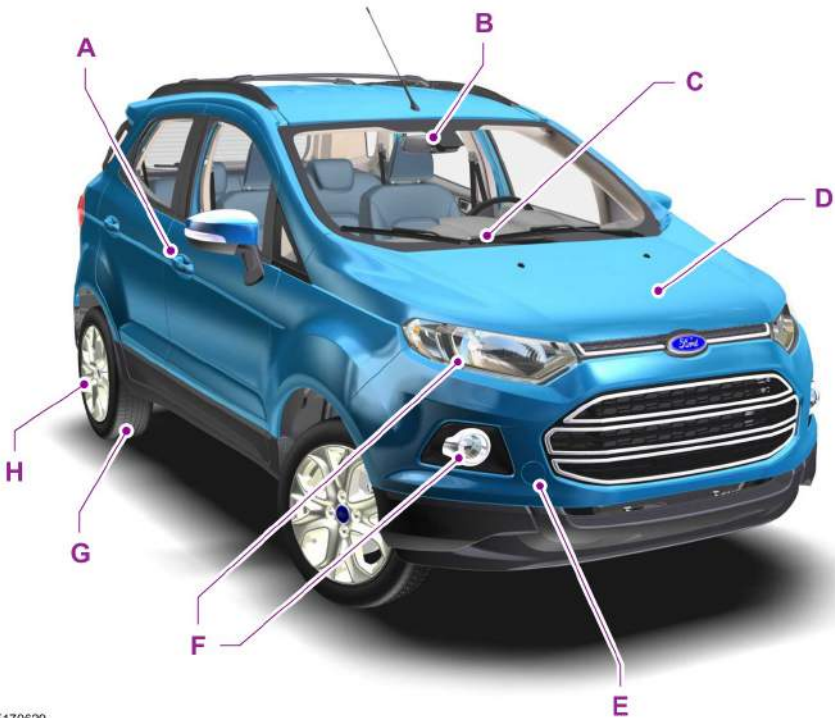

E170629

- A See **Locking and Unlocking** (page 35).
- B See **Interior Mirror** (page 54).
- C See **Changing the Wiper Blades** (page 140).
- D See **Maintenance** (page 127).
- E See **Towing Points** (page 111).
- F See **Changing a Bulb** (page 136).
- G Tire pressures. See **Technical Specifications** (page 157).
- H See **Changing a Road Wheel** (page 153).

At a Glance

VEHICLE INTERIOR OVERVIEW

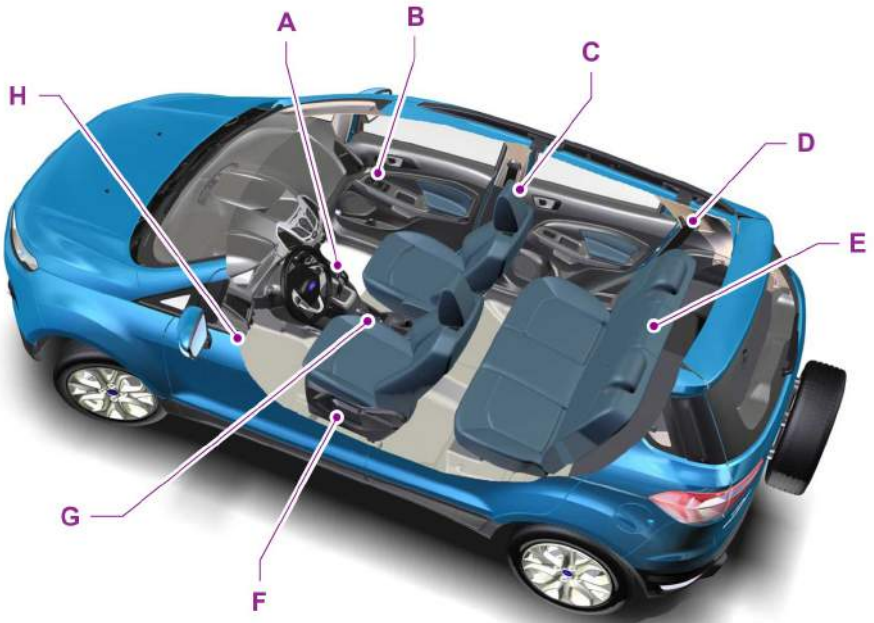

E170630

- A See **Manual Transmission** (page 96). See **Automatic Transmission** (page 96).
- B See **Power Windows** (page 52). See **Exterior Mirrors** (page 53).
- C See **Head Restraints** (page 75).
- D See **Fastening the Safety Belts** (page 25).
- E See **Rear Seats** (page 77).
- F See **Manual Seats** (page 76).
- G See **Parking Brake** (page 101).
- H See **Opening and Closing the Hood** (page 127).

At a Glance

INSTRUMENT PANEL OVERVIEW - VEHICLES WITH: LHD

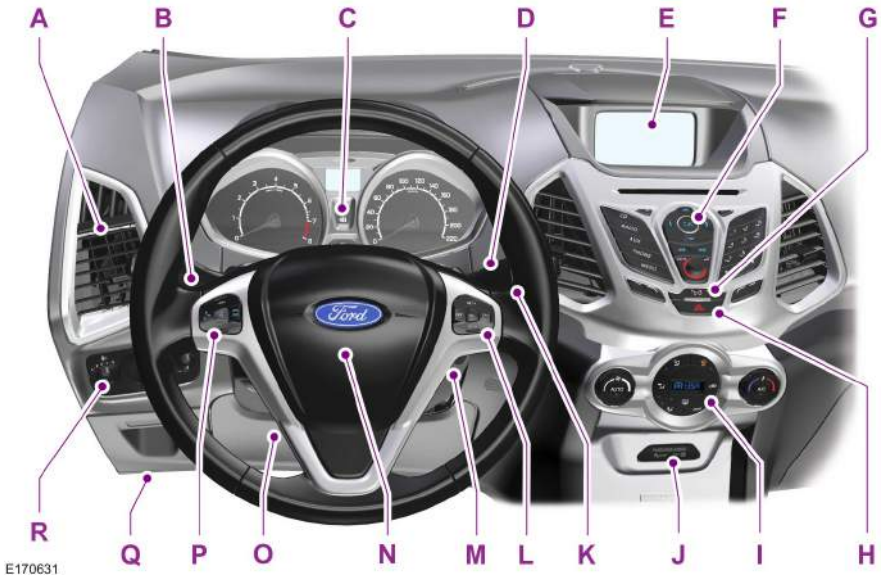

E170631

- A Air vents. See **Air Vents** (page 69).
- B Direction indicators. See **Direction Indicators** (page 50).
- C Instrument cluster. See **Gauges** (page 55). See **Warning Lamps and Indicators** (page 56).
- D Wiper lever. See **Wipers and Washers** (page 45).
- E Information and entertainment display. See **Information Displays** (page 61).
- F Audio unit. See **Audio System** (page 161).
- G Door lock button. See **Locking and Unlocking** (page 35).
- H Hazard warning flasher switch. See **Hazard Warning Flashers** (page 115).
- I Climate controls. See **Climate Control** (page 69).
- J Passenger airbag deactivation warning lamp. See **Passenger Airbag** (page 29).
- K Push button ignition switch. See **Starting and Stopping the Engine** (page 83).

At a Glance

- L Cruise control switches. See **Using Cruise Control** (page 107).
- M Ignition switch. See **Ignition Switch** (page 83).
- N Horn.
- O Steering wheel adjustment. See **Adjusting the Steering Wheel** (page 43).
- P Audio control. See **Audio Control** (page 43).
- Q Hood release lever. See **Opening and Closing the Hood** (page 127).
- R Lighting control. See **Lighting Control** (page 48).

INSTRUMENT PANEL OVERVIEW - VEHICLES WITH: RHD

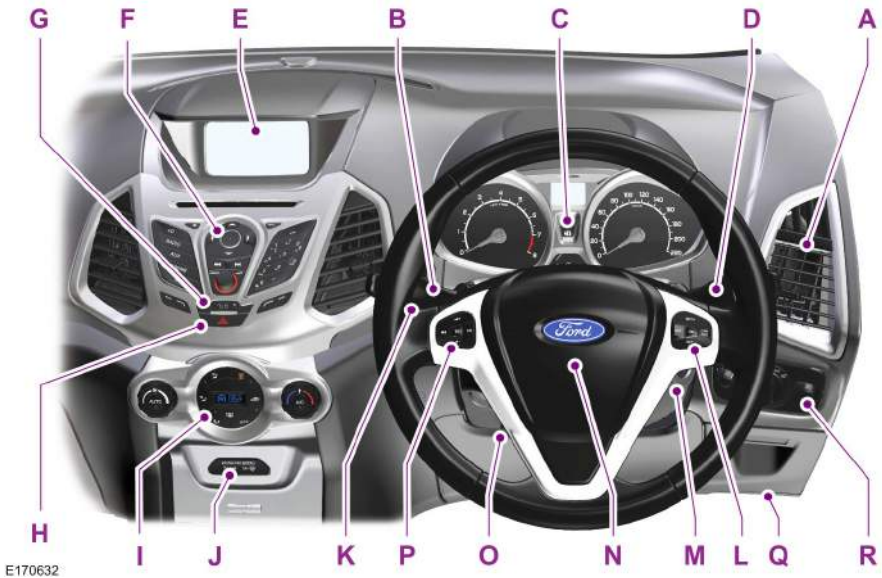

- A Air vents. See **Air Vents** (page 69).
- B Direction indicators. See **Direction Indicators** (page 50).
- C Instrument cluster. See **Gauges** (page 55). See **Warning Lamps and Indicators** (page 56).
- D Wiper lever. See **Wipers and Washers** (page 45).

At a Glance

- E Information and entertainment display. See **Information Displays** (page 61).
- F Audio unit. See **Audio System** (page 161).
- G Door lock button. See **Locking and Unlocking** (page 35).
- H Hazard warning flasher switch. See **Hazard Warning Flashers** (page 115).
- I Climate controls. See **Climate Control** (page 69).
- J Passenger airbag deactivation warning lamp. See **Passenger Airbag** (page 29).
- K Push button ignition switch. See **Starting and Stopping the Engine** (page 83).
- L Cruise control switches. See **Using Cruise Control** (page 107).
- M Ignition switch. See **Ignition Switch** (page 83).
- N Horn.
- O Steering wheel adjustment. See **Adjusting the Steering Wheel** (page 43).
- P Audio control. See **Audio Control** (page 43).
- Q Hood release lever. See **Opening and Closing the Hood** (page 127).
- R Lighting control. See **Lighting Control** (page 48).

At a Glance

REAR EXTERIOR OVERVIEW

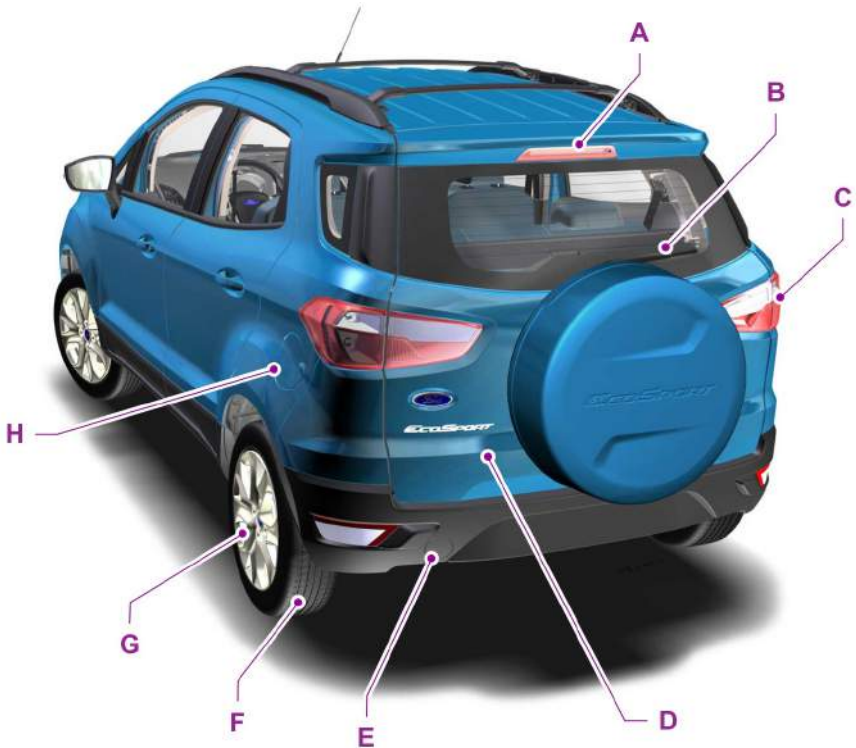

E171482

- A See **Changing a Bulb** (page 136).
- B See **Changing the Wiper Blades** (page 140).
- C See **Tailgate** (page 38). See **Changing a Bulb** (page 136).
- D See **Warning Triangle** (page 115). Spare wheel. See **Rear Exterior Overview** (page 15). Jack. See **Rear Exterior Overview** (page 15).
- E See **Towing Points** (page 111).
- F Tire pressures. See **Technical Specifications** (page 157).

At a Glance

- G See **Rear Exterior Overview** (page 15).
- H See **Refueling** (page 91).

Child Safety

INSTALLING CHILD SEATS



E161855



E133140





E68916

WARNINGS

 Extreme Hazard! Do not use a rearward facing child seat on a seat protected by an active airbag in front of it!

WARNINGS

 Your vehicle has a passenger airbag deactivation switch. See **Passenger Airbag** (page 29). You must switch the airbag off when using a rearward facing child seat on the front seat. Make sure you switch the airbag back on following removal of the rearward facing child seat. Failure to follow this warning could result in serious personal injury or death.

 Use an approved child seat to secure children less than 59 inches (150 centimeters) tall on the rear seat. Failure to follow this warning could result in serious personal injury or death.

 Read and follow the manufacturer's instructions when you are installing a child seat. Failure to follow this warning could result in serious personal injury or death.

 Do not modify child seats in any way. Failure to follow this warning could result in serious personal injury or death.

 Do not hold a child on your lap when your vehicle is moving. Failure to follow this warning could result in serious personal injury or death.

 Do not leave unattended children in your vehicle. Failure to follow this warning could result in serious personal injury or death.

 If your vehicle has been involved in a crash, have the child seats checked by an authorized dealer. Failure to follow this warning could result in serious personal injury or death.

Only child seats certified to ECE-R131 or ECE-R44.03 (or later) have been tested and approved for use in your vehicle. A choice of these are available from an authorized dealer.

Child Safety

Note: *Mandatory use of child seats varies from country to country.*

Child Seats for Different Mass Groups

Use the correct child seat as follows:

Rearward Facing Baby Safety Seat



E68918

Secure children that weigh less than 29 pounds (13 kilograms) in a rearward facing baby safety seat (Group 0+) on the rear seat.

Child Safety Seat









E68920

Secure children that weigh between 29 pounds (13 kilograms) and 40 pounds (18 kilograms) in a child safety seat (Group 1) on the rear seat.

Booster Seats

WARNINGS

-  Do not install a booster seat or a booster cushion with only the lap strap of the safety belt. Failure to follow this warning could result in serious personal injury or death.
-  Do not install a booster seat or a booster cushion with a safety belt that is slack or twisted. Failure to follow this warning could result in serious personal injury or death.
-  Do not put the safety belt under your child's arm or behind their back. Failure to follow this warning could result in serious personal injury or death.
-  Do not use pillows, books or towels to boost your child's height. Failure to follow this warning could result in serious personal injury or death.
-  Make sure that your child sits in an upright position. Failure to follow this warning could result in serious personal injury or death.
-  Make sure the child seat rests tightly against the vehicle seat. If necessary, adjust the seatback to an upright position. It may also be necessary to lift or remove the head restraint. See **Head Restraints** (page 75). Failure to follow this warning could result in serious personal injury or death.
-  You must reinstall the head restraint following the removal of the child seat. See **Head Restraints** (page 75). Failure to follow this warning could result in serious personal injury or death.

Child Safety

Secure children that weigh more than 33 pounds (15 kilograms) but are less than 59 inches (150 centimeters) tall in a booster seat or a booster cushion.

Booster Seat (Group 2)



E70710

We recommend that you use a booster seat that combines a cushion with a backrest instead of a booster cushion only. The raised seating position will allow you to position the shoulder strap of the adult safety belt over the center of your child's shoulder and the lap strap tightly across their hips.

Booster Cushion (Group 3)



E68924

ISOFIX Anchor Points



E171403

WARNING



Use an anti-rotation device when using the ISOFIX system. We recommend the use of a top tether or support leg. Failure to follow this warning could result in serious personal injury or death.

Your vehicle has ISOFIX anchor points that accommodate universally approved ISOFIX child seats.

The ISOFIX system has two rigid attachment arms on the child seat. These attach to anchor points on the second row seats, where the cushion and backrest meet. For child seats with a top tether, tether anchor points are on the rear of the second row seats.

Note: When you are purchasing an ISOFIX seat, make sure that you know the correct mass group and ISOFIX size class for the intended seating locations. See **Child Seat Positioning** (page 20).

Child Safety

Attaching a Child Seat With Top Tethers

WARNING



Do not attach the top tether strap to anything other than the correct top tether strap anchor point. Failure to follow this warning could result in serious personal injury or death.

Follow the child seat manufacturer's instructions for installing a child seat with a top tether.



E171410

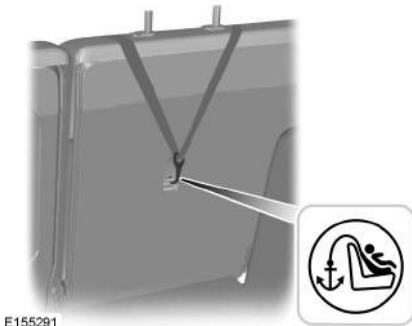

E155291

Attaching a Child Seat With a Support Leg

WARNINGS



Make sure the support leg is long enough to reach the vehicle floor. Failure to follow this warning could result in serious personal injury or death.



Make sure that the child seat manufacturer lists your vehicle as suitable for use with this type of child seat. Failure to follow this warning could result in serious personal injury or death.

Follow the child seat manufacturer's instructions for installing a child seat with a support leg.

CHILD SEAT POSITIONING

WARNINGS



See an authorized dealer for the latest details relating to our recommended child seats. Failure to follow this warning could result in serious personal injury or death.



Extreme Hazard! Do not use a rearward facing child seat on a seat protected by an airbag in front of it!



When using a child seat with a support leg, the support leg must rest securely on the floor. Failure to follow this warning could result in serious personal injury or death.



When using a child seat with a safety belt, make sure that the safety belt is not slack or twisted. Failure to follow this warning could result in serious personal injury or death.

Child Safety

WARNINGS



Make sure the child seat rests tightly against the vehicle seat. If necessary, adjust the seatback to an upright position. It may also be necessary to lift or remove the head restraint. See **Head Restraints** (page 75). Failure to follow this warning could result in serious personal injury or death.



You must reinstall the head restraint following the removal of the child seat. See **Head Restraints** (page 75). Failure to follow this warning could result in serious personal injury or death.

Note: When using a child seat on a front seat, always adjust the front passenger seat as far back as possible. If it proves difficult to tighten the lap section of the safety belt without slack remaining, adjust the seatback to the fully upright position and raise the height of the seat. See **Seats** (page 75).

Seating positions	Mass group categories				
	0	0+	1	2	3
	Up to 22 lbs (10 kg)	Up to 29 lbs (13 kg)	20 - 40 lbs (9 - 18 kg)	33 - 55 lbs (15 - 25 kg)	46 - 79 lbs (22 - 36 kg)
Front passenger seat with airbag ON	X	X	UF ¹	UF ¹	UF ¹
Front passenger seat with airbag OFF	U ¹	U ¹	U ¹	U ¹	U ¹
Rear seats	U	U	U	U	U

X Not suitable for children in this mass group.

U Suitable for universal category child restraints approved for use in this mass group.

U¹ Suitable for universal category child restraints approved for use in this mass group. We recommend that you secure children in a government approved child seat, on a rear seat.

UF¹ Suitable for universal category forward facing child seats approved for use in this mass group. We recommend that you secure children in a government approved child seat, on a rear seat.

Child Safety

ISOFIX Child Seats

Seating positions		Mass group categories			
		0	0+	I	
		Rear facing		Front facing	Rear facing
		Up to 29 lbs (13 kg)		20 - 40 lbs (9 - 18 kg)	
Front passenger seat	Size class	Not ISOFIX equipped			
	Size type				
Rear outboard seat ISOFIX	Size class	D, E ¹	A, B, B ¹	D ¹	
	Size type	IL ²	IL ² , IUF ³	IL ²	
Rear center seat	Size class	Not ISOFIX equipped			
	Size type				

IL Suitable for use with particular ISOFIX child restraints systems in the semi-universal category. Refer to the child restraint system manufacturer vehicle recommendation list for additional information.

IUF Suitable for use with forward facing ISOFIX child restraints systems in the universal category.

¹The capital letters A to G define the ISOFIX size class for both universal and semi-universal child restraints systems. You can see the identification letters on ISOFIX child restraints.

²At the time of going to print, the recommended Group O+ ISOFIX baby safety seat is the Britax Roemer Baby Safe. See an authorized dealer for the latest details relating to Ford recommended child seats.

³At the time of going to print, the recommended Group 1 ISOFIX child seat is the Britax Roemer Duo. See an authorized dealer for the latest details relating to Ford recommended child seats.

Child Safety

i-Size Child Seats

	Front passenger seat	Rear outboard seats	Rear center seat
i-Size Child Restraint Systems	X	i-U	X

i-U Suitable for use with forward and rearward facing i-Size child restraint systems.

X Not suitable for use with i-Size child restraint systems.

Child Safety

CHILD SAFETY LOCKS

WARNING

 You cannot open the doors from inside if you have put the child safety locks on.

Note: On vehicles with keyless entry, use the spare key. See **Keyless Entry** (page 36).



E155292

Left-hand side

Turn anti-clockwise to lock and clockwise to unlock.

Right-hand side

Turn clockwise to lock and anti-clockwise to unlock.

Safety Belts

FASTENING THE SAFETY BELTS

WARNINGS



Insert the tongue into the buckle until you hear a distinct click. You have not fastened the safety belt properly if you do not hear a click.



Make sure that your safety belt is securely stored and is not outside the vehicle when closing the door.

Note: *Fasten the safety belt only with the vehicle at a standstill, and never when the vehicle is moving.*

Always use the safety belts and child restraint systems.

The upper belt strap should rest on the shoulder, never over the neck. The lower belt strap should be placed over the pelvic area, never over the stomach.

Never use one belt for more than one person. Make sure the belts are not twisted or loose, nor obstructed by other passengers or packages.

Do not recline the front seat backrests excessively, as the safety belts only provide maximum protection when the backrests are in a nearly vertical position.

Retractable-inertial three-point safety belts

This belt type is available with the front seats of all models, and with the rear seat of some versions. Keep the belt retention buckle on the rear floor free from luggage or objects.

Buckling the safety belt

Pull the belt with a steady movement to avoid a block. Insert the buckle tab into the belt lock until you hear a click, and make sure it is locked in place.

Releasing the safety belt

Press the red button on the buckle, then let the belt roll up smoothly and completely.



E74124

Fixed rear center lap belt

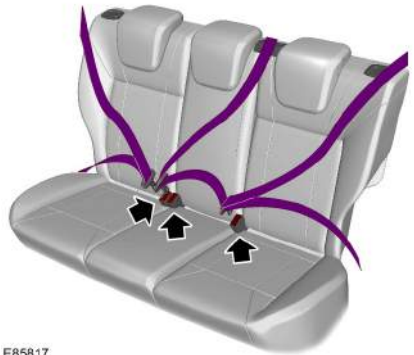

E85817

When buckling, make sure you hear a click confirming that the tab is latched into the belt lock. To tighten it, pull the loose end through the buckle until the belt is comfortably adjusted around the hips.

Safety Belts

Pull the belt out steadily. It may lock if you pull it sharply or if the vehicle is on a slope.

Note: Some models have a rear center lap belt.

Press the red button on the buckle to release the belt. Let it retract completely and smoothly.

Using Safety Belts During Pregnancy

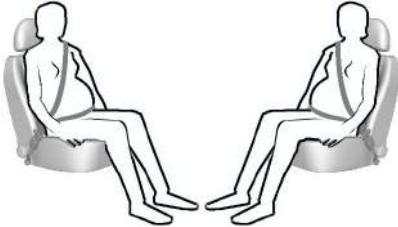

E68587

WARNING



Position the safety belt correctly for your safety and that of your unborn child. Do not use only the lap strap or the shoulder strap.

Position the lap strap comfortably across your hips and low beneath your pregnant abdomen. Position the shoulder strap between your breasts, above and to the side of your pregnant abdomen.

SAFETY BELT HEIGHT ADJUSTMENT (IF EQUIPPED)

WARNING



Position the safety belt height adjuster so that the belt rests across the middle of your shoulder. Failure to adjust the safety belt properly could reduce the effectiveness of the safety belt and increase the risk of injury in a crash.

Adjust the height of the shoulder belt so the belt rests across the middle of your shoulder.



E145664

To adjust the shoulder belt height:

1. Pull the button and slide the height adjuster up or down.
2. Release the button and pull down on the height adjuster to make sure it is locked in place.

SAFETY BELT MINDER

WARNING



The system will only provide protection when you use the safety belt correctly.

The warning lamp illuminates and an audible warning will sound when the following conditions have been met:

- The front safety belts have not been fastened.
- Your vehicle exceeds a relatively low speed.

It will also illuminate when a front safety belt is not fastened when your vehicle is moving.

If you do not fasten your safety belt both the audible and visual warnings will switch off automatically after approximately five minutes.

Safety Belts

Turning the Safety Belt Minder Off

See an authorized dealer.

Supplementary Restraints System

PRINCIPLE OF OPERATION

WARNINGS

 Extreme Hazard! Never use a rearward facing child restraint on a seat protected by an active airbag in front of it. Death or serious injury to the child can occur.

 Do not modify the front of your vehicle in any way. This could adversely affect deployment of the airbags. Failure to adhere to this warning could result in serious personal injury or death.

 Wear a safety belt and keep sufficient distance between yourself and the steering wheel. Only when you use the safety belt correctly, can it hold you in a position that allows the airbag to achieve its optimum effect. See **Sitting in the Correct Position** (page 75). Failure to adhere to this warning could result in serious personal injury or death.

 Repairs to the steering wheel, steering column, seats, airbags and safety belts must be carried out by an authorized dealer. Failure to adhere to this warning could result in serious personal injury or death.

 Keep the areas in front of the airbags free from obstruction. Do not affix anything to or over the airbag covers. In the event of a crash, hard objects could cause serious personal injury or death.

 Do not puncture the seat with sharp objects. This could damage and adversely affect deployment of the airbags. Failure to adhere to this warning could result in serious personal injury or death.

 Use seat covers designed for seats with side airbags. Have these fitted by an authorized dealer. Failure to adhere to this warning could result in serious personal injury or death.

Note: You will hear a loud bang and see a cloud of harmless powdery residue if an airbag deploys. This is normal.

Note: Only wipe airbag covers with a damp cloth.

DRIVER AIRBAG

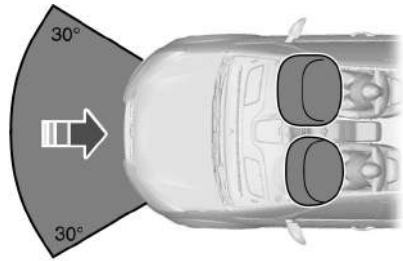

E74302

The airbag will deploy during significant frontal collisions or collisions that are up to 30 degrees from the left or the right. The airbag will inflate within a few thousandths of a second and deflate on contact with the occupant, thus cushioning forward body movement. During minor frontal collisions, overturns, rear collisions and side collisions, the airbag will not deploy.

Supplementary Restraints System

PASSENGER AIRBAG

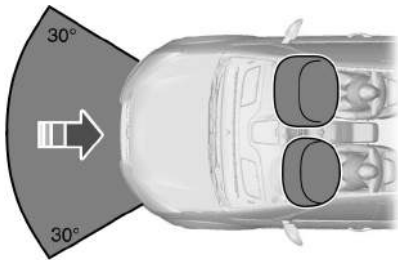

E74302

The airbag will deploy during a significant frontal crash or crashes that are up to 30 degrees from the left or the right. The airbag will inflate within a few thousandths of a second and deflate on contact with the occupant cushioning forward body movement. During minor frontal crashes, sideways crashes, rear crashes or overturns, the airbag will not deploy.

Switching the Passenger Airbag Off

WARNING



Extreme Hazard! You must switch the passenger airbag off when you are using a rearward facing child seat on the front passenger seat. Never use a rearward facing child restraint on a seat protected by an active airbag in front of it. Death or serious injury to the child can occur.



E164753



E170613

The key switch and the airbag deactivation warning lamp are located in the instrument panel.

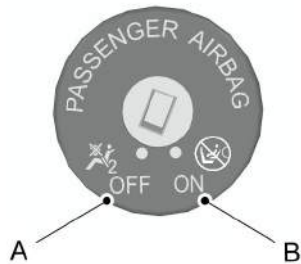

E144007

- A Switch off
- B Switch on

Turn the switch to position A.

When you switch the ignition on check that the airbag deactivation warning **OFF** lamp illuminates.

Supplementary Restraints System

Switching the Passenger Airbag On

WARNING

 You must switch the passenger airbag on when you are not using a rearward child seat on the front passenger seat. Failure to adhere to this warning could result in serious personal injury or death.

Turn the switch to position B.

When you switch the ignition on check that the airbag deactivation warning **ON** lamp illuminates.

SIDE AIRBAGS (IF EQUIPPED)

WARNING

 Use seat covers designed for seats with side airbags. Have these fitted by an authorized dealer.



E72658

The airbags are located inside the seatback of the front seats. There is a label attached to the side of the seatback to indicate this.

The airbag will deploy during significant lateral collisions. The airbag will not deploy in minor lateral and frontal collisions, rear collisions, or overturns.

DRIVER KNEE AIRBAG

WARNING

 Do not attempt to open the airbag cover.

The airbag will deploy during frontal collisions or collisions that are up to 30 degrees from the left or the right. The airbag will inflate within a few thousandths of a second and deflate on contact with the occupants, thus providing a cushion between the driver's knees and the steering column. During overturns, rear collisions and side collisions, the knee airbag will not deploy.

For item location: See **Instrument Panel Overview** (page 12).

Note: *The airbag has a lower deployment threshold than the front airbags. During a minor collision, it is possible that only the knee airbag will deploy.*

SIDE CURTAIN AIRBAGS (IF EQUIPPED)

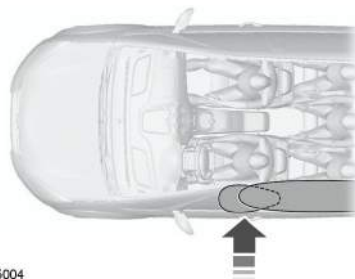

E75004

The airbags are located over the front and rear side windows.

Supplementary Restraints System

The airbag will deploy during significant lateral collisions. It will also deploy during significant frontal angled collisions. The curtain airbag will not deploy in minor lateral and frontal collisions, rear collisions, or overturns.

Keys and Remote Controls

GENERAL INFORMATION ON RADIO FREQUENCIES

Note: Changes or modifications not expressly approved by the party responsible for compliance could void the user's authority to operate the equipment.

The typical operating range for your transmitter is approximately 33 ft (10 m).

A decrease in operating range could be caused by:

- weather conditions
- nearby radio towers
- structures around your vehicle
- other vehicles parked next to your vehicle.

The radio frequency used by your remote control can also be used by other short distance radio transmissions (e.g. amateur radios, medical equipment, wireless headphones, remote controls and alarm systems). If the frequencies are jammed, you will not be able to use your remote control. You can lock and unlock the doors with the key.

Note: Make sure your vehicle is locked before leaving it unattended.

Note: If you are in range, the remote control will operate if you press any button unintentionally.

REMOTE CONTROL

You can program a maximum of eight remote controls to your vehicle. This includes any that were supplied with your vehicle. See an authorized dealer.

Reprogramming the Unlocking Function

Note: When you press the unlock button either all the doors are unlocked or only the driver's door is unlocked. Pressing the unlock button again unlocks all the doors.

Press and hold the unlock and lock buttons on the remote key simultaneously for at least four seconds with the ignition off. The direction indicators will flash twice to confirm the change.

To return to the original unlocking function, repeat the process.

Changing the Remote Control Battery



Make sure that you dispose of old batteries in an environmentally friendly way. Seek advice from your local authority regarding recycling.

Remote Control With a Folding Key Blade

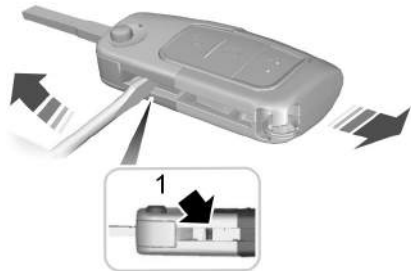

E74383

1. Insert a screwdriver as far as possible into the slot on the side of the remote control, push it toward the key blade and remove the key blade.

Keys and Remote Controls



E74384

2. Twist the screwdriver in the position shown to start separating the two halves of the remote control.

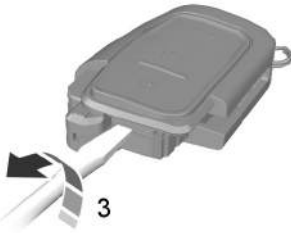

E74385

3. Twist the screwdriver in the position shown to separate the two halves of the remote control.

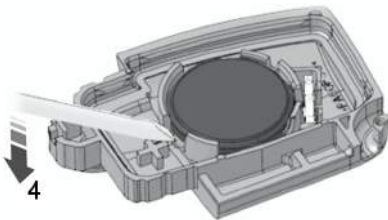

E126280

Note: Do not touch the battery contacts or the printed circuit board with the screwdriver.

4. Carefully remove the battery with the screwdriver.
5. Install a new battery (3V CR 2032) with the + facing downward.
6. Assemble the two halves of the remote control.
7. Install the key blade.

Remote Control Without a Folding Key Blade



E87964

1. Press and hold the buttons on the edges to release the cover. Carefully remove the cover.
2. Remove the key blade.



E105362

3. Twist a flat-bladed screwdriver in the position shown to separate the two halves of the remote control.

Keys and Remote Controls

REPLACING A LOST KEY OR REMOTE CONTROL

Replacement keys or remote controls can be purchased from an authorized dealer. Authorized dealers can program remote controls for your vehicle. See **Passive Anti-Theft System** (page 40).

To re-program the passive anti-theft system see an authorized dealer.



E119190

- Carefully insert the screwdriver in the position shown to open the remote control.



E125860

Note: Do not touch the battery contacts or the printed circuit board with the screwdriver.

- Carefully remove the battery with the screwdriver.
- Install a new battery (3V CR 2032) with the **+** facing downward.
- Assemble the two halves of the remote control.
- Install the key blade.

Locks

LOCKING AND UNLOCKING

Note: All doors will be automatically unlocked when the airbag deploys due to impact and following this the hazard warning flashers will flash.

Power Door Locks (If Equipped)



E146263

The power door lock control is located on the instrument panel near the radio.

- Press the button once. The doors will lock.
- Press the button again. The doors will unlock.

For item location. See **At a Glance** (page 10).

Autolock

The autolock feature will lock all the doors when:

- all doors and tailgate are closed,
- the ignition is on,
- you shift into any gear putting the vehicle in motion, and
- the vehicle attains a speed greater than 20 km/h.

If one or more doors are opened, the autolock feature will repeat when:

- the vehicle speed has been 15 km/h for at least two seconds; and
- the conditions for autolock are met again.

Deactivating and Activating Autolock

Note: Your authorized dealer can perform this procedure, or you can do the procedure yourself

To enable or disable these features, do the following:

Note: You will have 30 seconds to complete the procedure.

1. Switch the ignition on.
2. Press the power door lock button three times.
3. Switch the ignition off.
4. Press the power door lock button three times.
5. Switch the ignition on. A chime will sound indicating the programming mode has been entered.

Once in programming mode, each subsequent short press (less than 1 second) of the power door lock button will toggle autolock between on and off.

Remote Control

The remote control can be used any time the vehicle is not running.

Unlocking the Doors

Note: You can unlock the driver's door with the key. Use the key when the remote control is not functioning.

Note: When you lock your vehicle for several weeks, the remote control will be switched off. Your vehicle must be unlocked and the engine started using the key. Unlocking and starting your vehicle once will enable the remote control.



Press the button to unlock the driver's door. The turn signals will flash once.

Press the button again within three seconds to unlock all doors. The turn signals will flash once.

Locks

Reprogramming the Unlocking Function

You can reprogram the unlocking function so that all doors will unlock when you press the button once. See **Remote Control** (page 32).

Locking the Doors



Press the button to lock all the doors. The turn signals will flash once.

Press the button again within three seconds to confirm that all the doors are closed. The doors will lock again and the turn signals will flash once if all the doors and the luggage compartment are closed.

Note: If any door or the luggage compartment is not closed, or if the hood is not closed on vehicles equipped with an anti-theft alarm, the lamps will not flash.

Automatic Relocking (If Equipped)

The doors will relock automatically if you do not open a door within 45 seconds of unlocking the doors with the remote control. The door locks and the alarm will return to their previous state.

Locking and Unlocking the Doors from Inside



Press the button. For item location. See **Instrument Panel Overview** (page 12).

Locking and Unlocking the Doors with the Key

Note: Do not leave your keys in your vehicle.

Locking with the Key

Turn the top of the key toward the front of your vehicle and rotate the key a clockwise direction.

Unlocking with the key

Note: If the child safety locks are on and you pull the interior handle, you will only switch off the emergency locking, not the child safety lock. You can only open the doors using the external door handle.

Note: If the doors have been unlocked using this method, the doors must be locked individually until the central locking function has been repaired.

Unlock the driver's door using the key. You can unlock all other doors individually by pulling the interior door handles.

Note: When the central locking function fails to operate, lock the doors individually using the key in the position shown.

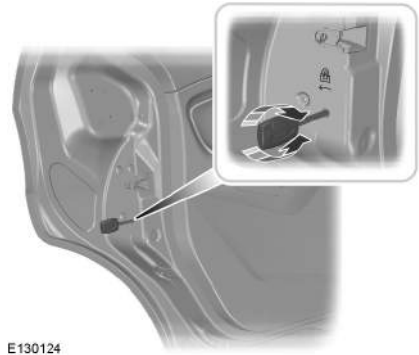

E130124

Push to lock.

KEYLESS ENTRY (IF EQUIPPED)

General Information

WARNING



The system may not function if the key is close to metal objects or electronic devices such as cell phones.

Locks

The system will not function if:

- Your vehicle battery has no charge.
- The passive key frequencies are jammed.
- The passive key battery is flat.

Note: *If the system does not function, you will need to use the key blade to lock and unlock your vehicle.*

The system allows you to operate your vehicle without the use of a key or remote control.



E158474

Passive locking and unlocking requires a valid passive key to be located within one of the two external detection ranges. These are located approximately five feet (one and a half meters) from the front door handles.

Passive Key

Your vehicle can be locked and unlocked with the passive key. You can use the passive key as a remote control. See **Locking and Unlocking** (page 35).

Locking Your Vehicle

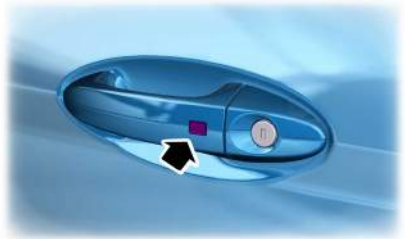

E87384

WARNING



Your vehicle does not lock itself automatically. If you do not press a locking button your vehicle will remain unlocked.

Locking buttons are located on each of the front doors.

For central locking and to arm the alarm:

- Press a locking button once.

Note: *Your vehicle will remain locked for approximately three seconds. When the delay period is over, you can open the doors again, provided the passive key is within the respective detection range.*

Two short flashes of the direction indicators confirms that all the doors have been locked and that the alarm has been armed.

Unlocking Your Vehicle

Note: *Your vehicle remains locked for longer than three days, the system will enter an energy-saving mode. This is to reduce the discharge of your vehicle battery. When your vehicle is unlocked while in this mode, the reaction time of the system may be a little longer than normal. To exit the energy-saving mode, unlock your vehicle.*

Locks

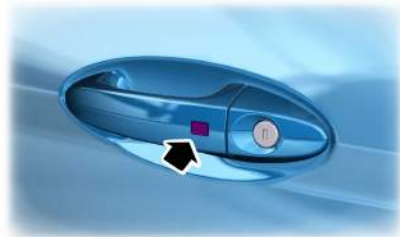

E87384

Press a locking button once.

Note: A valid passive key must be located within the detection range of that door.

One long flash of the direction indicators confirms that all the doors have been unlocked and that the alarm has been disarmed.

Unlocking Only the Driver's Door

If the unlocking function is reprogrammed so that only the driver's door is unlocked See **Remote Control** (page 32). Note the following:

If the driver's door is the first door which is opened, the other doors will remain locked. All the other doors can be unlocked from inside your vehicle by pressing the unlock button on the instrument panel. For item location: See **At a Glance** (page 10). Doors can be unlocked individually by pulling the interior door handles on those doors.

If the front passenger's door is the first door which is opened, all the doors will be unlocked.

Disabled Keys

Any keys left inside your vehicle interior when it is locked will be disabled.

You cannot use a disabled key to switch the ignition on or start the engine.

You must enable all passive keys again in order to use them.

To enable all your passive keys, unlock your vehicle using a passive key or the remote control unlocking function.

All passive keys will then be enabled if you switch the ignition on or your vehicle is started using a valid key.

Locking and Unlocking the Doors with the Key Blade (If Equipped)



E87964

1. Carefully remove the cover.
2. Remove the key blade and insert it into the lock.

Note: Only the driver's door handle has a lock cylinder.

TAILGATE

Opening the Tailgate



E162987

Locks

Note: *You must unlock your vehicle in order to open the tailgate.*

1. Unlock your vehicle.
2. Press the button located on the right-hand tail lamp and open the tailgate.

Security

PASSIVE ANTI-THEFT SYSTEM

Principle of Operation

The system prevents someone from starting the engine with an incorrectly coded key.

Coded Keys

If you lose a key, you can obtain a replacement from an authorized dealer. If possible, provide them with the key number from the tag provided with the original keys. You can also obtain extra keys from an authorized dealer.

Note: Have all of your remaining keys erased and recoded if you lose a key. Have replacement keys coded together with recoding your remaining keys. See an authorized dealer for further information.

Note: Do not shield your keys with metal objects. This may prevent the receiver from recognizing a coded key.

Arming the Engine Immobilizer

When you switch the ignition off the engine immobilizer will arm automatically after a short time.

Disarming the Engine Immobilizer

When you switch the ignition on the engine immobilizer will disarm automatically if a correctly coded key is used.

If you are unable to start the engine with a correctly coded key, have your vehicle checked by an authorized dealer.

ANTI-THEFT ALARM (IF EQUIPPED)

Alarm System

Your vehicle may have one of the following alarm systems:

- Perimeter alarm.
- Perimeter alarm with interior sensors.
- Category one alarm with interior sensors and battery back-up sounder.

Perimeter Alarm

The perimeter alarm is a deterrent against unauthorized access to your vehicle through the doors and the hood. It also protects the audio unit.

Interior Sensors



E71401

WARNINGS



Do not cover up the interior lamp unit sensors.



Do not arm the alarm with full guard if passengers, animals or other moving objects are inside your vehicle.

The sensors act as a deterrent against unauthorized intrusion by sensing any movement within your vehicle.

Battery Back-up Sounder

The battery back-up sounder is an extra alarm system which will sound a siren when the alarm is triggered. When you lock your vehicle the system is armed. The sounder has its own battery and will sound an alarm siren even if someone disconnects your vehicle battery or the battery back-up sounder itself.

Security

Triggering the Alarm

Once armed, the alarm is triggered in any of the following ways:

- If someone opens a door, the liftgate or the hood without a valid key or remote control.
- If someone removes the audio or navigation system.
- If you switch the ignition on without a valid key.
- If the interior sensors detect movement within your vehicle.
- On vehicles with a battery back-up sounder, if someone disconnects your vehicle battery or the battery back-up sounder itself.

If the alarm is triggered, the alarm horn will sound for 30 seconds and the hazard warning flasher will flash for five minutes.

Any further attempts to perform one of the above will trigger the alarm again.

Full and Reduced Guard

Full Guard

Full guard is the standard setting.

In full guard, the interior sensors are on when you arm the alarm.

Note: *This may result in false alarms if animals or moving objects are inside your vehicle.*

Reduced Guard

In reduced guard, the interior sensors are off when you arm the alarm.

Note: *You can set the alarm to reduced guard for the current ignition cycle only. The alarm will reset to full guard the next time you switch the ignition on.*

Ask on Exit (If Equipped)

You can set the information display to ask you each time which level of guard you wish to set.

If you select **Ask on Exit**, the message **Reduced guard?** appears in the information display each time you switch the ignition off. See **Information Messages** (page 63).

If you wish to arm the alarm with reduced guard, press the **OK** button when this message appears.

If you wish to arm the alarm with full guard, leave your vehicle without pressing the **OK** button.

Selecting Full or Reduced Guard

Note: *Selecting **Reduced** does not set the alarm permanently to reduced guard. It sets it to reduced guard only for the current ignition cycle. If you regularly set the alarm to reduced guard, select **Ask on Exit**.*

You can select full or reduced guard using the information display. See **General Information** (page 63).

Arming the Alarm

To arm the alarm, lock your vehicle. See **Locks** (page 35).

Disarming the Alarm

Vehicles Without Keyless Entry

Perimeter Alarm

Disarm and silence the alarm by unlocking the doors with the key and switching the ignition on with a correctly coded key or unlocking the doors with the remote control.

Security

Category One Alarm

Disarm and silence the alarm by unlocking the doors with the key and switching the ignition on with a correctly coded key within 12 seconds or unlocking the doors with the remote control.

Vehicles with Keyless Entry

Note: *A valid passive key must be located within the detection range of that door for keyless entry. See **Keyless Entry** (page 36).*

Perimeter Alarm

Disarm and silence the alarm by unlocking the doors and switching the ignition on or unlocking the doors with the remote control.

Category One Alarm

Disarm and silence the alarm by unlocking the doors and switching the ignition on within 12 seconds or unlocking the doors or the liftgate with the remote control.

Steering Wheel

ADJUSTING THE STEERING WHEEL

WARNING

 Do not adjust the steering wheel when your vehicle is moving.

Note: Make sure that you are sitting in the correct position. See **Sitting in the Correct Position** (page 75).



E95178

1. Unlock the steering column.
2. Adjust the steering wheel to the desired position.



E95179

3. Lock the steering column.

AUDIO CONTROL

Select the required source on the audio unit.

You can operate the following functions with the control:

Type 1

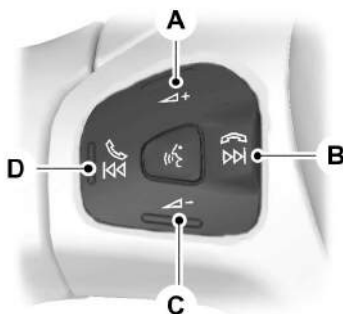

E164289

- A Volume up
- B Seek up, next or end call

Steering Wheel

- C Volume down
- D Seek down, previous or accept call

Type 2

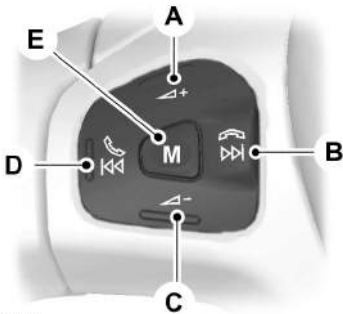

E164290

- A Volume up
- B Seek up or next
- C Volume down
- D Seek down or previous
- E Mode

Press **M** to select the audio source.

Seek, Next or Previous

Press the seek button to:

- tune the radio to the next or previous stored preset.
- play the next or the previous track.

Press and hold the seek button to:

- tune the radio to the next station up or down the frequency band.
- seek through a track.

VOICE CONTROL (IF EQUIPPED)



E141533

Push the control to switch on or off the voice control.

CRUISE CONTROL (IF EQUIPPED)



E141961

See **Cruise Control** (page 107).

Wipers and Washers

WINDSHIELD WIPERS

Note: Fully defrost the windshield before switching on the windshield wipers.

Note: Make sure you switch off the windshield wipers before entering a car wash.

Note: Install new wiper blades as soon as they begin to leave bands of water and smears on the windshield.

Note: Do not operate the wipers on a dry windshield. This may scratch the glass, damage the wiper blades or cause the wiper motor to burn out. Always use the windshield washers before wiping a dry windshield.



E102032

- A Single wipe
- B Intermittent wipe
- C Normal wipe
- D High speed wipe

Intermittent Wipe



E102033

- A Short wipe interval
- B Intermittent wipe
- C Long wipe interval

Use the rotary control to adjust the intermittent wipe interval.

Speed Dependent Wipers (If Equipped)

When your vehicle speed increases, the interval between wipes will decrease.

AUTOWIPERS

Note: Make sure you switch off the windshield wipers before entering a car wash.

Note: Install new wiper blades as soon as they begin to leave bands of water and smears on the windshield.

Note: When the autowipers detect enough moisture on the windshield for normal speed wipe and you have the autolamps feature switched on, the low-beam headlamps will also turn on automatically.

Note: During wet or winter driving conditions with ice, snow or a salty road mist, inconsistent or unexpected wiping or smearing may occur.

Wipers and Washers

In these conditions, you can do the following:

- Lower the sensitivity of the autowipers to reduce the amount of smearing.
- Switch to normal or high-speed wipe.
- Switch the autowipers off.

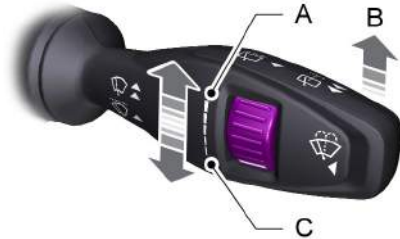

E102033

- A High sensitivity
- B On
- C Low sensitivity

The rain sensor monitors the amount of moisture on the windshield and automatically turns on the wipers. It will adjust the wiper speed by the amount of moisture that the sensor detects on the windshield.

Use the rotary control to adjust the sensitivity of the rain sensor. Set the control to low sensitivity, and the wipers will turn on when the rain sensor detects a large amount of moisture on the windshield. Set the control to high sensitivity, and the wipers will turn on when the rain sensor detects a small amount of moisture on the windshield.

Keep the outside of the windshield clean because the rain sensor is very sensitive. If the area around the interior mirror is dirty, then the wipers may turn on, for example, if dirt, mist or insects hit the windshield.

You can switch this feature on and off through the information display. See **General Information** (page 61).

WINDSHIELD WASHERS

Note: Do not operate the washers when the washer reservoir is empty. This may cause the washer pump to overheat.



E102051

Push the button to operate the washers. When you release the button, the wipers will operate for a short time.

REAR WINDOW WIPER AND WASHERS (IF EQUIPPED)

Intermittent Wipe



E102052

Pull the lever toward you.

Wipers and Washers

Reverse Gear Wipe (If Equipped)

The rear wiper will turn on automatically when selecting reverse gear if:

- the rear wiper is not already switched on
- the wiper lever is in position A, B, C or D
- the front wiper is operating (when set to position B).

The rear wiper will follow the front wiper interval (at intermittent or normal speed).

Rear Window Washer

Note: *Do not operate the washers when the washer reservoir is empty. This may cause the washer pump to overheat.*



E102053

Pull the lever toward you to operate the washers. They will operate for a maximum of 10 seconds. When you release the lever, the wiper will operate for a short time.

Lighting

GENERAL INFORMATION

Condensation in Lamp Assemblies

Exterior lamps have vents to accommodate normal changes in air pressure.

Condensation can be a natural by-product of this design. When moist air enters the lamp assembly through the vents, there is a possibility that condensation can occur when the temperature is cold. When normal condensation occurs, a fine mist can form on the interior of the lens. The fine mist eventually clears and exits through the vents during normal operation.

Clearing time may take as long as 48 hours under dry weather conditions.

Examples of acceptable condensation are:

- The presence of a fine mist (no streaks, drip marks or large droplets).
- A fine mist covers less than 50% of the lens.

Examples of unacceptable condensation are:

- A water puddle inside the lamp.
- Streaks, drip marks or large droplets present on the interior of the lens.

If you see any unacceptable condensation, have your vehicle checked by an authorized dealer.

LIGHTING CONTROL

Lighting control positions

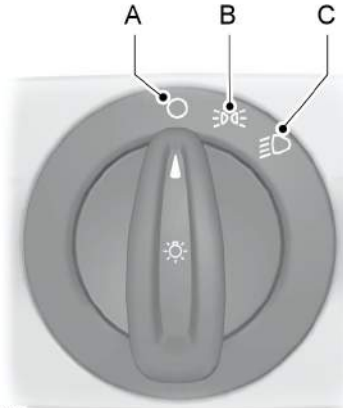

E70718

- A Off
- B Parking lamps, instrument panel lamps, licence plate lamps and rear lamps
- C Headlamps

Parking lamps

Note: Prolonged use of the parking lamps will cause the battery to run out of charge.

To operate the parking lamps turn the lighting control to position B. The parking lamps operate with the ignition on or off.

Lighting

High and low beam



E101829

Pull the lever fully towards the steering wheel to switch between high and low beam.

Headlamp flasher

Pull the lever slightly towards the steering wheel.

Home safe lighting (If Equipped)

Switch the ignition off and pull the direction indicator lever towards the steering wheel to switch the headlamps on. You will hear a short tone. The headlamps will go off automatically after three minutes with any door open, or 30 seconds after the last door has been closed.

With all doors closed, but within the 30 second delay, opening any door will result in the three minute timer starting again.

The home safe lights can be cancelled by either pulling the direction indicator lever towards the steering wheel again or by switching the ignition switch on.

AUTOLAMPS (IF EQUIPPED)



E70719

Note: *If you have switched the autolamps on, you can only switch the high beam on when the autolamps has switched the headlamps on.*

The headlamps will come on and go off automatically depending on the ambient light.

DAYTIME RUNNING LAMPS

WARNING



Always remember to switch your headlamps on in low light situations or during inclement weather. The system does not turn on the tail lamps and may not provide adequate lighting during these conditions. Failure to switch the headlamps on under these conditions may result in a crash.

The system switches daytime running lamps on whenever the ignition is on and low beam headlamps are off.

If your vehicle has autolamps, the system switches between daytime running lamps and low beam headlamps depending on ambient light conditions.

Lighting

DIRECTION INDICATORS



E102016

Move the turn signal lever in the upward or downward position.

- Push down to activate the left turn signal.
- Push up to activate the right turn signal.

Note: Tap the lever up or down to make the direction indicators flash only three times.

INTERIOR LAMPS

Courtesy lamp

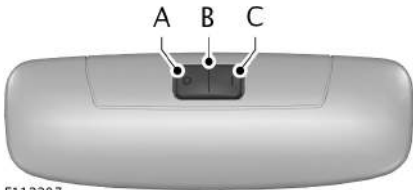

E112207

- A Off
- B Door contact
- C On

If you set the switch to position **B**, the courtesy lamp will come on when you unlock or open a door or the luggage compartment lid. If you leave a door open with the ignition switch off, the courtesy lamp will go off automatically after some time to prevent the vehicle battery from discharging. To switch it back on, switch on the ignition for a short time.

The courtesy lamp will also come on when you switch off the ignition. It will go off automatically after a short time or when you start or restart the engine.

If you set the switch to position **C** with the ignition switch off, the courtesy lamp will come on. It will go off automatically after a short time to prevent the vehicle battery from discharging. To switch it back on, switch on the ignition for a short time.

Reading lamps



E112208

If you switch off the ignition, the reading lamps will go off automatically after some time to prevent the vehicle battery from discharging. To switch them back on, switch on the ignition for a short time.

FRONT FOG LAMPS (IF EQUIPPED)



E70721

Lighting

WARNING

 Only use the front fog lamps when visibility is considerably restricted by fog, snow or rain.

REAR FOG LAMPS (IF EQUIPPED)



E70720

WARNINGS

 Only use the rear fog lamps when visibility is restricted to less than 50 meters (164 feet).

 Do not use the rear fog lamps when it is raining or snowing and visibility is more than 50 meters (164 feet).

HEADLAMP LEVELING

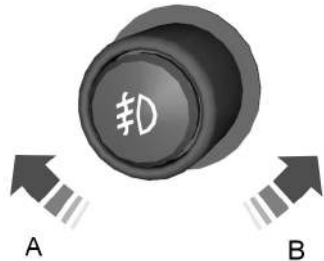

E70722

- A Raised headlamp beams
- B Lowered headlamp beams

You can adjust the level of the headlamp beams according to the vehicle load.

Recommended headlamp leveling control positions

Load		Load in luggage compartment ¹	Control position
Front seats	Rear seats		
1-2	-	-	0
1-2	3	-	1
1-2	3	Max	2
1	-	Max	3

¹ See **Vehicle Identification Plate** (page 159).

Windows and Mirrors

POWER WINDOWS

WARNINGS



Do not leave children unattended in your vehicle and do not let them play with the power windows. They may seriously injure themselves.



When closing the power windows, you should verify they are free of obstructions and make sure that children and pets are not in the proximity of the window openings.

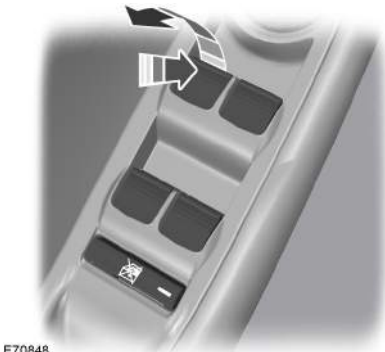

E70848

Note: You may hear a rumbling noise when just one of the windows are open. Lower the opposite window slightly to reduce this noise.

Press the switch to open the window.

Lift the switch to close the window.

One-Touch Down (If Equipped)

Press the switch fully and release it. Press again or lift it to stop the window.

One-Touch Up (If Equipped)

Lift the switch fully and release it. Press or lift it again to stop the window.

Window Lock



E70850

Press the control to lock or unlock the rear window controls. It will illuminate when the rear window controls are locked.

Bounce-Back (If Equipped)

The window will stop automatically while closing. It will reverse some distance if there is an obstacle in the way.

Overriding the Bounce-Back Feature

WARNING



When you override the bounce-back feature the window will not reverse if it detects an obstacle. Take care when closing the windows to avoid personal injury.

Proceed as follows to override this protection feature when there is a resistance, for example in winter:

1. Close the window twice until it reaches the point of resistance and let it reverse.

Windows and Mirrors

2. Close the window a third time to the point of resistance. The bounce-back feature is now disabled and you can close the window manually. The window will go past the point of resistance and you can close it fully.

See an authorized dealer as soon as possible if the window does not close after the third attempt.

Resetting the Bounce-Back Feature

WARNING



The bounce-back feature remains turned off until you reset the memory.

If you have disconnected the battery, you must reset the bounce-back memory separately for each window.

1. Lift and hold the switch until the window is fully closed.
2. Release the switch.
3. Lift the switch again for one more second.
4. Press and hold the switch until the window is fully open.
5. Release the switch.
6. Lift and hold the switch until the window is fully closed.
7. Open the window and then try to close it automatically.
8. Reset and repeat the procedure if the window does not close automatically.

EXTERIOR MIRRORS

Power Exterior Mirrors (If Equipped)

WARNING



Do not adjust the mirrors when your vehicle is moving.

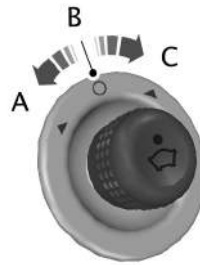

E71280

- A Left-hand mirror
- B Off
- C Right-hand mirror



E71281

Move in the direction of the arrows to tilt the mirror.

Fold-Away Exterior Mirrors (If Equipped)

Push the mirror toward the door window glass. Make sure that you fully engage the mirror in its support when returning it to its original position.

Integrated Blind Spot Mirrors (If Equipped)

WARNING



Objects in the blind spot mirror are closer than they appear.

Windows and Mirrors

Blind spot mirrors have the outboard section of the mirror that curves aspheric. They are designed to increase your visibility along the side of your vehicle.

Check the main mirror first before a lane change, then check the blind spot mirror. If no vehicles are present in the blind spot mirror and the traffic in the adjacent lane is at a safe distance, signal that you intend to change lanes. Glance over your shoulder to verify traffic is clear and carefully change lanes.

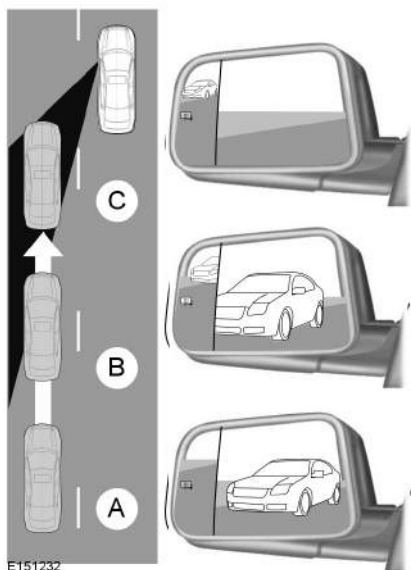

The image of the approaching vehicle is small and near the inboard edge of the main mirror when it is at a distance. The image becomes larger and begins to move outboard across the main mirror as the vehicle approaches (A). The image will transition from the main mirror and begin to appear in the blind spot mirror as the vehicle approaches (B). The vehicle will transition to your peripheral field of view as it leaves the blind spot mirror (C).

INTERIOR MIRROR

WARNING



Do not adjust the mirror when your vehicle is moving.

Note: Do not clean the housing or glass of any mirror with harsh abrasives, fuel or other petroleum or ammonia-based cleaning products.

You can adjust the interior mirror to your preference. Some mirrors also have a second pivot point. This lets you move the mirror head up or down and from side to side.

Pull the tab below the mirror toward you to reduce glare at night.

Auto-Dimming Mirror (If Equipped)

Note: Do not block the sensors on the front and back of the mirror. Mirror performance may be affected. A rear center passenger or raised rear center head restraint may also block light from reaching the sensor.

The mirror will dim automatically to reduce glare when bright lights are detected from behind your vehicle. It will automatically return to normal reflection when you select reverse gear to make sure you have a clear view when backing up.

Instrument Cluster

GAUGES

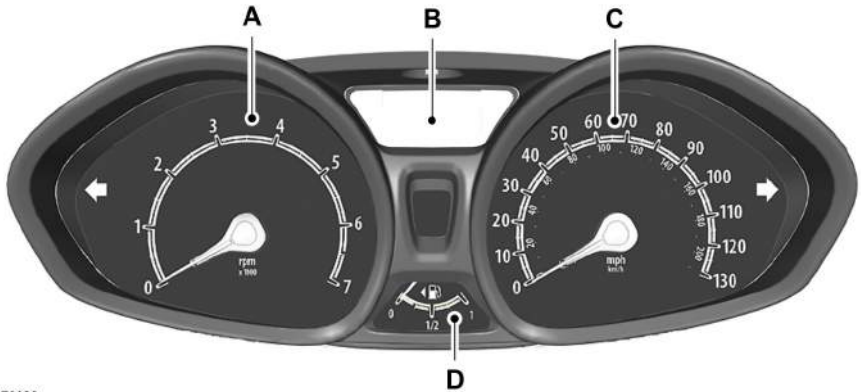

E170928

- A Tachometer
- B Information display and engine coolant temperature gauge
- C Speedometer
- D Fuel gauge

Engine Coolant Temperature Gauge



E140760

Displays the temperature of the engine coolant. At normal operating temperature the indicator will remain in the center section.

Fuel Gauge

Switch the ignition on. The fuel gauge will indicate approximately how much fuel is left in the fuel tank. The fuel gauge may vary slightly when your vehicle is moving or on a gradient. The arrow adjacent to the fuel pump symbol indicates on which side of your vehicle the fuel filler door is located.

Instrument Cluster

WARNING LAMPS AND INDICATORS

The following warning lamps and indicators will alert you to a vehicle condition that may become serious. Some lamps will illuminate when you start your vehicle to make sure they work. If any lamps remain on after starting your vehicle, refer to the respective system warning lamp for further information.

Note: *Some warning indicators appear in the information display and function the same as a warning lamp but do not display when you start your vehicle.*

Anti-Lock Braking System Warning Lamp



If it illuminates when you are driving, this indicates a malfunction. You will continue to have the normal braking system (without anti-lock braking system) unless the brake system warning lamp is also illuminated. Have your vehicle checked by an authorized dealer.

Automatic High Beam Indicator (if Equipped)



It will illuminate when this feature is on. See **Autolamps** (page 49).

Anti-theft System Indicator



Flashes when the Anti-theft System (PATS) has been activated.

Battery Warning Lamp



If it illuminates when driving, this indicates a malfunction. Switch off all unnecessary electrical equipment. Have the system checked by an authorized dealer immediately.

Brake System Warning Lamp



It will illuminate when you engage the parking brake with the ignition on.

If it illuminates when you are driving, check that the parking brake is not engaged. If the parking brake is not engaged, this indicates low brake fluid level or a brake system malfunction. Have your vehicle checked by an authorized dealer immediately.

WARNING



Driving your vehicle with the warning lamp on is dangerous. A significant decrease in braking performance may occur. It will take you longer to stop your vehicle. Have your vehicle checked by an authorized dealer immediately. Driving extended distances with the parking brake engaged can cause brake failure and the risk of personal injury.

Coolant Temperature Warning Lamp

WARNING



Do not resume your journey if it illuminates in red color despite the level being correct. Have the system checked by an authorized dealer immediately.

Instrument Cluster



If the red lamp stays on or illuminates after starting the engine or while driving, this indicates an engine coolant malfunction. Stop your vehicle as soon as it is safe to do so and switch the engine off. Check the coolant level. See **Engine Coolant Check** (page 134).

Cruise Control Indicator (If Equipped)



It will illuminate when you have set a speed using the cruise control system. See **Using**

Cruise Control (page 107).

Direction Indicator



Illuminates when the left or right direction indicator or the hazard warning flasher is turned on. If the indicators stay on or flash faster, check for a burnt out bulb. See **Changing a Bulb** (page 136).

Doors Open Warning Lamp (If Equipped)



Illuminates when the ignition is switched on and any door, the hood or the luggage compartment is not closed properly.

Diesel Particulate Filter Warning Lamp



If this illuminates, have the system checked by a properly trained technician as soon as possible.

Engine Oil Warning Lamp

WARNING



Do not resume your journey if it illuminates despite the level being correct. Have the system checked by an authorized dealer immediately.



If it illuminates with the engine running or when you are driving, this indicates a malfunction. Stop your vehicle as soon as it is safe to do so and switch the engine off. Check the engine oil level. See **Engine Oil Check** (page 132).

Engine Warning Lamps

Malfunction Indicator Lamp



Powertrain Warning Lamp



All Vehicles

If either lamp illuminates when the engine is running, this indicates a fault. The engine will continue to run but it may have limited power. If it flashes when you are driving, reduce the speed of your vehicle immediately. If it continues to flash, avoid heavy acceleration or deceleration. Have the system checked by a properly trained technician immediately.

WARNING



Have this checked immediately.

If both lamps illuminate together, stop your vehicle as soon as it is safe to do so (continued use may cause reduced power and cause the engine to stop). Turn the ignition off and attempt to restart the engine. If the engine restarts have the system checked by a properly trained technician immediately. If the engine does not restart the vehicle must be checked before continuing your journey.

Instrument Cluster

Front Airbag Warning Lamp (If Equipped)



If it illuminates when driving, this indicates a malfunction. Have the system checked by an authorized dealer..

Front Fog Lamps Indicator (If Equipped)



It will illuminate when you switch the front fog lamps on.

Frost Warning Lamp

WARNING



Even if the temperature rises to above +39°F (4°C) there is no guarantee that the road is free of hazards caused by inclement weather.



It will illuminate and glow orange when the outside air temperature is equal to or below 39°F (4°C).

Glow Plug Indicator (If Equipped)



If it illuminates, wait until the light goes off before starting.

Headlamp and Parking Lamp Indicator



It will illuminate when you switch the headlamp beam or the parking lamps on.

High Beam Indicator



It will illuminate when you switch the headlamp main beam on. It will flash when you use the headlamp flasher.

Hill Start Assist Indicator (If Equipped)



If it illuminates when you are driving this indicates a malfunction.

Low Fuel Level Indicator



If it illuminates when driving, refuel as soon as possible.

Low Tire Pressure Warning Lamp



If it illuminates when driving, this indicates a tire pressure warning. Stop your vehicle as soon as it is safe to do so, check the tires and inflate them to the correct pressure. If it flashes, this indicates a malfunction. Have your vehicle checked by an authorized dealer as soon as possible. See **Tire Pressure Monitoring System** (page 150).

Oil Dilution Warning Lamp (If Equipped)



It will illuminate when the Oil has been diluted by fuel. Have the system checked by an authorized dealer as soon as possible. See **Engine Oil Check** (page 132).

Power Steering Warning Lamp



If it illuminates when driving, this indicates a malfunction of the power steering system. You will continue to have full steering but will need to exert greater force on the steering wheel. Have the system checked by an authorized dealer as soon as possible.

Rear Fog Lamps Indicator (If Equipped)



It will illuminate when you switch the rear fog lamps on.

Instrument Cluster

Safety Belt Minder Warning Lamp

(If Equipped)



See **Safety Belt Minder** (page 26).

Shift Indicator



It will illuminate to inform you that shifting to a higher gear may give better fuel economy and lower CO2 emissions. It will not illuminate during periods of high acceleration, braking or when the clutch pedal is pressed.

Stability Control Off Indicator (If

Equipped)



It will illuminate when you switch the system off. It will go out when you switch the system back on or when you switch the ignition off.

Stability Control Warning Lamp (If

Equipped)



It will flash when the system is active. If it remains illuminated or does not illuminate when you switch the ignition on, this indicates a malfunction. During a malfunction the system will switch off. Have your vehicle checked by an authorized dealer immediately.

AUDIBLE WARNINGS AND INDICATORS

Anti-theft Alarm (If Equipped)

Category One Alarm

Sounds when you unlock and open the driver door using the key in the door lock. The chime will stop when the ignition is turned on with a valid key. The chime will sound for 12 seconds before the vehicle alarm is triggered.

Door Ajar (If Equipped)

Sounds if the vehicle's speed exceeds the pre-determined limit and any of the doors are open or ajar. The chime will only sound once per ignition key cycle.

Headlamps On (If Equipped)

Sounds when you turn the key to off and open the driver's door and you have left the headlamps or parking lamps on.

Headlight Exit Delay (If Equipped)

Sounds when the headlight exit delay has been activated.

Ignition Left On (Keyless Vehicles Only) (If Equipped)

Sounds if the ignition is left on and the vehicle driver's door is ajar or opened. The chime will stop once the door is closed or the ignition is turned off.

Low Fuel Level (If Equipped)

Sounds if the fuel level reaches the low level (1/16)th of the capacity. Sounds once per ignition key cycle.

Instrument Cluster

Message Center Display (If Equipped)

Sounds every time that the message center displays a warning message.

Parking Brake

Sounds if the vehicle's speed exceeds the pre-determined limit with the parking brake engaged. It will stop as soon as the vehicle is stopped or the parking brake is released.

Safety Belt Minder (If Equipped)

WARNINGS



The safety belt minder remains in stand-by mode when the driver and the front passenger (if equipped) safety belts have been fastened. It will be reactivated if the driver or front passenger (if equipped) safety belt is unfastened.



Do not sit on top of a fastened safety belt to prevent the safety belt minder from coming on. The occupant protection system will only provide optimum protection when you use the safety belt properly.

Sounds when the vehicle's speed exceeds the pre-determined limit, and the driver or front passenger (if equipped) safety belts are unfastened. The chime will stop after five minutes.

Speed Alarm (If Equipped)

When the speed alarm is active, every time the vehicle reaches the selected speed a warning will be sounded and the display will flash.

If the vehicle speed is at least 5 km/h above the selected speed, a double beep will be sounded every 10 seconds.

Vehicle Not in Park

Sounds if the vehicle is out of **P** park and driver's door is ajar or opened. The chime will stop once the vehicle is put in **P** park or if the driver's door is closed properly.

Information Displays

GENERAL INFORMATION

WARNING



Driving while distracted can result in loss of vehicle control, crash and injury. We strongly recommend that you use extreme caution when using any device that may take your focus off the road. Your primary responsibility is the safe operation of your vehicle. We recommend against the use of any hand-held device while driving and encourage the use of voice-operated systems when possible. Make sure you are aware of all applicable local laws that may affect the use of electronic devices while driving.

Various systems on your vehicle can be controlled using the information display controls on your audio unit. Corresponding information is displayed in the information display.

Information Display Controls (If

Equipped)



E103626

- Press the up and down arrow buttons to scroll through and highlight the options within a menu.
- Press the right arrow button to enter a sub-menu.
- Press the left arrow button to exit a menu.
- Press the **OK** button to choose and confirm settings or messages.

Press the **MENU** button on the radio to access some configurable features. Use the control arrow to the following features:

- SYNC-config. Access general SYNC configurations. See **SYNC™** (page 177).
- SYNC-applications. Access SYNC applications. See **SYNC™** (page 177).
- Audio configuration. Defines the audio configurations. See **Audio unit** (page 167).
- Vehicle configurations. Allow you to configure these features:
 - Traction control. You can activate or deactivate traction control. See **Principle of Operation** (page 103).
 - Alarm. You can activate the perimeter alarm.
 - Lane change indicator. You can set the lane change indicator to blink once or three times when changing lanes while driving. See **Direction Indicators** (page 50).
 - Chimes. You can set if an audible warning will sound for some information messages. See **Information Messages** (page 63).
- Clock. Allows you to adjust the time and date.
- Display. Allows you to set the language on the display and in the voice recognition system.
- System. Allows you to see current active information messages.

Adjusting the Clock

1. Press the **MENU** button on the radio.
2. Select **Clock** then press **OK**.
3. Select **Adjust Clock** then press **OK**.
4. Use the up or down arrows to increase or decrease the hour and minutes.

Information Displays

5. Use the left or right arrows to alternate between hour or minute adjustment.
 6. Press **OK** when done.
- or
1. Press the **#** symbol on the radio to access the clock adjustment.
 2. Use the up or down arrows to increase or decrease the hour and minutes.
 3. Use the left or right arrows to alternate between hour or minute adjustment.
 4. Press **OK** when done.

Adjusting the Date

1. Press the **MENU** button on the radio.
2. Select **Clock** then press **OK**.
3. Select **Adjust Date** then press **OK**.
4. Use the up or down arrows to increase or decrease the day, month and year.
5. Use the left or right arrows to alternate between day, month and year adjustment.
6. Press **OK** when done.

24 Hour Mode

1. Press the **MENU** button on the radio.
2. Select **Clock** then press **OK**.
3. Choose **24h Mode**.
4. Check the selection box with the **OK** button to enable 24h mode or uncheck to enable 12h mode.

TRIP COMPUTER



E102759

Press the button to scroll through the displays.

You can reset the trip, average fuel consumption and average speed. Scroll to the required display, then press and hold the button, this will reset the trip computer.

The trip computer includes the following information displays:

Temperature

Indicates the outside ambient temperature.

Trip Odometer

MI TRIP Registers the distance traveled of individual journeys.

KM TRIP

Distance to Empty

MI TO 0 Indicates the approximate distance your vehicle will travel on the fuel remaining in the tank. The distance to empty displayed may vary depending on driving style and road conditions.

KM TO 0

Information Displays

Average Fuel Consumption

\emptyset MPG Indicates the average fuel consumption since the function was last reset.

$\frac{\emptyset L}{100KM}$

Instantaneous Fuel Consumption

MPG Indicates the current fuel consumption.

$\frac{L}{100KM}$

Stationary Fuel Consumption

$\frac{G}{H}$ Indicates the current fuel consumption while stationary.

$\frac{L}{H}$

Average Speed

\emptyset MPH Indicates the average speed calculated since the function was last reset.

$\frac{\emptyset KM}{H}$

Distance Odometer

MI Registers the total distance your vehicle has traveled.

KM

INFORMATION MESSAGES

Note: Depending on the vehicle options equipped with your vehicle, not all of the messages will display or be available. Certain messages may be abbreviated or shortened depending upon which cluster type you have.



E103626

Press the OK button to acknowledge and remove some messages from the information display. Other messages will be removed automatically after a short time.

Certain messages need to be confirmed before you can access the menus.

 The message indicator illuminates to supplement some messages. It will be red or amber depending on the severity of the message and will remain on until the cause of the message has been rectified.

Some messages will be supplemented by a system specific symbol with a message indicator.

Information Displays

Airbag

Message	Message indicator	Action
Airbag malfunction service now	amber	Have the system checked by a authorized dealer as soon as possible.

Alarm

Message	Message indicator	Action
Alarm triggered check vehicle	amber	See Security (page 40).
Alarm system malfunction service required	-	Have the system checked by a authorized dealer.

Diesel

Message	Message indicator	Action
Engine preheating	amber	See Starting a Diesel Engine (page 86).
Diesel filter overloaded Refer to handbook	amber	See Starting a Diesel Engine (page 86).

Doors Open

Message	Message indicator	Action
Driver door open	red	Vehicle is moving. Stop your vehicle as soon as safely possible and close.
Driver side rear door open	red	Vehicle is moving. Stop your vehicle as soon as safely possible and close.
Passenger door open	red	Vehicle is moving. Stop your vehicle as soon as safely possible and close.

Information Displays

Message	Message indicator	Action
Passenger side rear door open	red	Vehicle is moving. Stop your vehicle as soon as safely possible and close.
Boot open	red	Vehicle is moving. Stop your vehicle as soon as safely possible and close.
Bonnet open	red	Vehicle is moving. Stop your vehicle as soon as safely possible and close. See Opening and Closing the Hood (page 127).
Driver door open	amber	Vehicle not moving. Close.
Drivers side rear door open	amber	Vehicle not moving. Close.
Passenger door open	amber	Vehicle not moving. Close.
Passenger side rear door open	amber	Vehicle not moving. Close.
Boot open	amber	Vehicle not moving. Close.
Bonnet open	amber	Vehicle not moving. Close. See Opening and Closing the Hood (page 127).

Engine Immobilizer

Message	Message indicator	Action
Immobilizer malfunction service now	red	Have the system checked by a authorized dealer as soon as possible.

Information Displays

Keyless System

Message	Message indicator	Action
Key battery low replace battery	amber	See Remote Control (page 32).
Turn ignition off use POWER button	amber	See Keyless Starting (page 83).
Press brake to start	-	See Keyless Starting (page 83).
Press clutch to start	-	See Keyless Starting (page 83).

Lighting

Message	Message indicator	Action
Left indicator malfunction change bulb	-	See Changing a Bulb (page 136).
Right indicator malfunction change bulb	-	See Changing a Bulb (page 136).

Maintenance

Message	Message indicator	Action
Brake fluid level low service now	red	See Brake and Clutch Fluid Check (page 134).
Brake system malfunction stop safely	red	Have the system checked by a authorized dealer immediately.
Engine oil pressure low stop safely	red	See Engine Oil Check (page 132).
Engine malfunction service now	amber	Have the system checked by a authorized dealer as soon as possible.
Auto wiper/lights malfunction service required	amber	Have the system checked by a authorized dealer.
Engine oil change due service required	-	Have the system checked by a authorized dealer.

Information Displays

Steering

Message	Message indicator	Action
Steering lock malfunction stop safely	red	Have the system checked by a authorized dealer immediately.
Power steering malfunction service now	amber	Full steering will be maintained but you will need to exert greater force on the steering wheel. Have the system checked by a authorized dealer as soon as possible.

Transmission

Message	Message indicator	Action
Transmission malfunction service now	red	Have the system checked by a authorized dealer immediately.
Transmission overtemperature stop safely	red	Under certain driving conditions it is possible that the clutches in the transmission can overheat. In these circumstances it is necessary to press the brake pedal and stop your vehicle to prevent damage to the transmission. Select N or P and apply the parking brake until the transmission has cooled and the message disappears from the display.
Vehicle not in park select P	-	See Automatic Transmission (page 96). See Starting and Stopping the Engine (page 83).
To start select N or P	-	See Automatic Transmission (page 96). See Starting and Stopping the Engine (page 83).
Press brake to start	-	See Starting and Stopping the Engine (page 83).
To start select N	-	See Automatic Transmission (page 96). See Starting and Stopping the Engine (page 83).

Information Displays

Message	Message indicator	Action
Door open apply brake	-	See Automatic Transmission (page 96). See Starting and Stopping the Engine (page 83).
Cranking time exceeded		See Starting a Gasoline Engine (page 85).
Hill start assist active		See Hill Start Assist (page 99).
Hill start assist off		See Hill Start Assist (page 99).

Stability Control

Message	Message indicator	Action
ABS malfunction service now	amber	Have the system checked by a authorized dealer as soon as possible.
Reduced electronic stability control	-	Have the system checked by a authorized dealer.
Electronic stability control off	-	See Using Stability Control (page 104).

Climate Control

PRINCIPLE OF OPERATION

Outside Air

Keep the air intakes in front of the windshield free from obstruction (such as snow or leaves) to allow the climate control system to function effectively.

Recirculated Air

WARNING



Prolonged use of recirculated air may cause the windows to mist up. If the windows mist up, follow the settings for demisting the windshield.

The air currently in the passenger compartment recirculates. Outside air does not enter your vehicle.

Heating

Heating performance depends on the temperature of the engine coolant.

Air Conditioning

Note: *The air conditioning operates only when the temperature is above 39°F (4°C).*

Note: *When you use air conditioning, your vehicle uses more fuel.*

The system directs air through the evaporator for cooling. The evaporator extracts humidity from the air to help keep the windows free of mist. The system directs the resulting condensation to the outside of your vehicle, which may cause a small pool to form under your vehicle. This is normal.

General Information on Controlling the Interior Climate

Fully close all the windows.

Warming the Interior

Direct the air toward your feet. In cold or humid weather conditions, direct some of the air toward the windshield and the door windows.

Cooling the Interior

Direct the air toward your face.

AIR VENTS

Center Air Vents

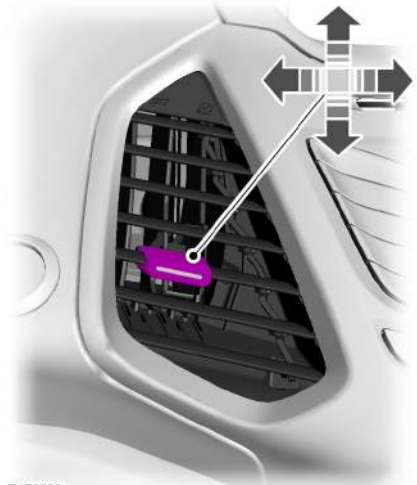

E170290

Climate Control

Side Air Vents



E170291

AUTOMATIC CLIMATE CONTROL (IF EQUIPPED)

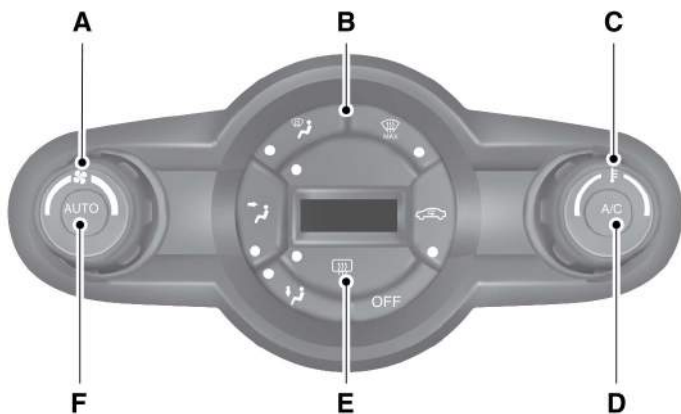

E144831

Climate Control

- A Controls the volume of air circulated in your vehicle. Rotate the control to select the desired fan speed. The setting appears in the display.
- B Adjust to select the desired air distribution. **OFF** turns off the system. Press the recirculated air button to switch between outside air and recirculated air. When you select recirculated air, the button illuminates and the air currently in the passenger compartment recirculates. This can reduce the time needed to cool the interior and reduce unwanted odors from entering your vehicle.
- C Controls the temperature of the air circulated in your vehicle. Adjust to select the desired temperature. The setting appears in the display.
- D Press the button to switch the air conditioning on and off. Air conditioning cools your vehicle using outside air or recirculated air. To improve air conditioning when starting your vehicle, drive with the windows slightly open for two to three minutes and select recirculated air.
- E Press the button to defog and clear the rear screen of a thin covering of mist.
- F Press the button to select automatic operation. The system automatically controls the temperature, amount and distribution of the air to reach and maintain your previously selected temperature.

HINTS ON CONTROLLING THE INTERIOR CLIMATE

General Hints

Note: *Prolonged use of recirculated air may cause the windows to fog up.*

Note: *You may feel a small amount of air from the footwell air vents regardless of the air distribution setting.*

Note: *To reduce humidity build-up inside your vehicle, do not drive with the system switched off or with recirculated air always switched on.*

Note: *Do not place objects under the front seats as this may interfere with the airflow to the rear seats.*

Note: *Remove any snow, ice or leaves from the air intake area at the base of the windshield.*

To minimize humidity in the air conditioning system and reduce unpleasant odors, switch off the air conditioning and keep the fan going for at least two minutes before switching off the engine. Do the following:

1. Keep the engine running.
2. Switch off the air conditioning by pressing the **A/C** button.
3. Keep the fan switched on.
4. Set the temperature to the full hot position.
5. Use outside air, not recirculated air.
6. Wait one to two minutes, and then switch off the engine.

Climate Control

Heating the Interior Quickly

	Vehicle with manual climate control	Vehicle with automatic climate control
1	Adjust the fan speed to the highest speed setting.	Adjust the fan speed to the highest speed setting.
2	Adjust the temperature control to the highest setting.	Adjust the temperature control to the highest setting.
3	Adjust the air distribution control to the footwell air vents position.	Press the footwell button to distribute air to the footwell air vents.

Recommended Settings for Heating

	Vehicle with manual climate control	Vehicle with automatic climate control
1	Adjust the fan speed to the second speed setting.	Press the AUTO button.
2	Adjust the temperature control to the midway point of the hot settings.	Adjust the temperature control setting to the desired setting.
3	Adjust the air distribution control to the footwell and windshield air vents position.	

Cooling the Interior Quickly

	Vehicle with manual climate control	Vehicle with automatic climate control
1	Adjust the fan speed to the highest speed setting.	Press the AUTO button.
2	Adjust the temperature control to the MAX A/C position.	Adjust the temperature control setting to low.
3	Adjust the air distribution control to the instrument panel air vents position.	

Climate Control

Recommended Settings for Cooling

	Vehicle with manual climate control	Vehicle with automatic climate control
1	Adjust the fan speed to the second speed setting.	Press the AUTO button.
2	Adjust the temperature control to the midway point of the cold settings.	Adjust the temperature control to the desired setting.
3	Adjust the air distribution control to the instrument panel air vents position.	Open all instrument panel air vents and direct as desired.

Vehicle Stationary for Extended Periods during Extreme High Ambient Temperatures

	Vehicle with manual climate control	Vehicle with automatic climate control
1	Apply the parking brake.	Apply the parking brake.
2	Move the transmission selector lever to position P (automatic transmission) or neutral (manual transmission).	Move the transmission selector lever to position P (automatic transmission) or neutral (manual transmission).
3	Adjust the fan speed to the desired setting.	Press the AUTO button.
4	Adjust the temperature control to the MAX A/C position.	Adjust the temperature control setting to low.
5	Adjust the air distribution control to the instrument panel air vents position.	Adjust the air distribution control to the instrument panel air vents position.

Windshield and Side Window Defrosting or Defogging in Cold Weather

	Vehicle with manual climate control	Vehicle with automatic climate control
1	Press the windshield defrosting and defogging button.	Press the maximum windshield defrosting and defogging button.
2	Adjust the temperature control to the desired setting.	Adjust the temperature control to the desired setting.
3	Direct the outboard instrument panel air vents toward the side windows.	Direct the outboard instrument panel air vents toward the side windows.
4	Adjust the fan speed to the highest setting.	

Climate Control

HEATED WINDOWS

Use the heated windows to demist the rear window.

Note: *The heated windows operate only when the engine is running.*

Heated Rear Window (If Equipped)





Seats

SITTING IN THE CORRECT POSITION

WARNINGS

 Do not recline the seatback too far as this can cause the occupant to slide under the safety belt, resulting in serious injury in the event of a collision.

 Sitting improperly, out of position or with the seatback reclined too far, can result in serious injury or death in the event of a collision. Always sit upright against your seatback, with your feet on the floor.

 Do not place objects higher than the seatback to reduce the risk of serious injury in the event of a collision or during heavy braking.

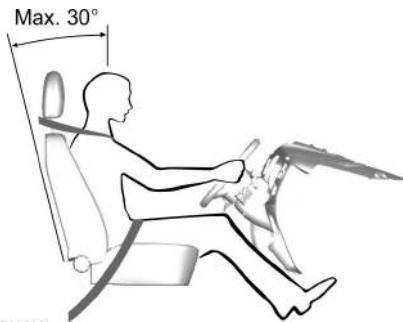

E68595

When you use them properly, the seat, head restraint, safety belt and air bags will provide optimum protection in the event of a collision.

We recommend that you follow these guidelines:

- Sit in an upright position with the base of your spine as far back as possible.
- Do not recline the seatback more than 30 degrees.

- Adjust the head restraint so that the top of it is level with the top of your head and as far forward as possible. Make sure that you remain comfortable.
- Keep sufficient distance between yourself and the steering wheel. We recommend a minimum of 10 inches (25 centimeters) between your breastbone and the air bag cover.
- Hold the steering wheel with your arms slightly bent.
- Bend your legs slightly so that you can press the pedals fully.
- Position the shoulder strap of the safety belt over the center of your shoulder and position the lap strap tightly across your hips.

Make sure that your driving position is comfortable and that you can maintain full control of your vehicle.

HEAD RESTRAINTS

WARNINGS

 Raise the rear head restraint when the rear seat is occupied by a passenger.

 When front seats are in use the head restraints must not be removed.

Adjusting the head restraints

Adjust the head restraint so that the top of it is level with the top of your head.

Seats

Removing the head restraints

Front head restraints



E140447

Press locking button 1 and at the same time release the retaining clip 2 using a suitable implement.

Rear outer head restraints





E151804

Pull to move the head restraint upward. Press the locking button 1 to lower the head restraint or to remove the head restraint.

MANUAL SEATS

WARNINGS

 Do not place any objects behind the seat back before returning it to the original position. Pull on the seat back to make sure that it has fully latched after returning the seat back to its original position. An unlatched seat may become dangerous if you stop suddenly or have a collision.

 Rock the seat backward and forward after releasing the lever to make sure that it is fully engaged in its catch.

Moving the Seat Backward and Forward



E149153

Seats

Adjusting the Lumbar Support (If Equipped)



E70729

Adjusting the Height of the Driver's Seat (If Equipped)



E142198

Recline Adjustment



E157024

REAR SEATS

Reclining the Seat Back (If Equipped)

Your vehicle may have split seat backs that can be folded individually.



E152354

With the seat occupied, pull the strap up to recline the seat back.

Folding the Seat Back (If Equipped)

WARNINGS



When folding the seat backs down, take care not to get your fingers caught between the seat back and seat frame.

Seats

WARNINGS



Do not attempt to fold the rear seat cushion forwards.



Lower the head restraints. See **Head Restraints** (page 75).



E151158

With the seat unoccupied, lift the strap located on the side of the seat to fold the seatback flat.



E151159

Lift the strap all the way up until the seat releases from the floor. Rotate the seat forward to increase trunk capacity.



E151172

Attach the tether strap to the front head restraints to hold the folded seats in the upright position. This will help to prevent unintentional rear seat returns.



E151161

To return the seatback to the floor from tumbled position, rotate the seat down until you hear it latching to the floor.



E151160

Lift the seatback toward the rear of the vehicle, and rotate the seatback until you hear a click, locking it in the upright position.

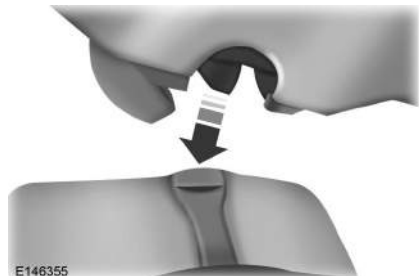

E146355

Ensure that the rear latch hooks are properly engaged with the floor striker.

Seats

Note: *Ensure that the seat and seat back are latched securely in position. Keep floor area free of objects that would prevent proper seat engagement.*

WARNINGS



When folding the seat backs up, make sure that the belts are visible to an occupant and not caught behind the seat.



Make sure that the seats and the seat backs are secure and fully engaged in their catches.

FRONT SEAT ARMREST (IF EQUIPPED)



E156683

Auxiliary Power Points

WARNING



Do not plug optional electrical accessories into the cigar lighter socket (if equipped). Improper use of the lighter can cause damage not covered by your warranty, and can result in fire or serious injury.

Note: When the ignition is switched on, you can use the socket to power 12 volt appliances with a maximum current rating of 10 Amps.

Note: Do not insert objects other than an accessory plug into the power point. This will damage the outlet and blow the fuse.

Note: Do not hang any type of accessory or accessory bracket from the plug.

Note: Do not use the power point for operating a cigar lighter element.

Note: Improper use of the power point can cause damage not covered by your warranty.

Note: Always keep the power point caps closed when not in use.

Run the engine for full capacity use of the power point. To prevent the battery from being discharged:

- Do not use the power point longer than necessary when the engine is not running.
- It is strongly recommended that you always disconnect the accessories from the power point (12 volt) when leaving the vehicle.

Location

Power point may be found:



E147757

in the center console.



E147758

next to the rear seat on the right hand side (if equipped).

CIGAR LIGHTER (IF EQUIPPED)

Note: Do not hold the cigar lighter element pressed in.

Note: If you use the socket when the engine is not running, the battery may discharge.

Note: When the ignition is switched on, you can use the socket to power 12 volt appliances with a maximum current rating of 20 amps.

Note: Use only Ford accessory connectors or connectors specified for use with SAE standard sockets.

Auxiliary Power Points



E103382

Press the element in to use the cigar lighter. It will pop out automatically.

Storage Compartments

CENTER CONSOLE

WARNING



Use only soft cups in the cup holders. Hard objects can injure you in a collision.

Your vehicle may be equipped with a variety of console features. These include:

- front cup holders
- rear cup holders
- auxiliary input jack (if equipped)
- USB (if equipped)
- auxiliary power point.

GLASSES HOLDER (IF EQUIPPED)



E150040

The glasses must be placed in the glasses holder with the lenses facing downward as shown in the picture. If not, the glasses can fall down when the glasses holder is open.

Starting and Stopping the Engine

GENERAL INFORMATION

WARNINGS

 Extended idling at high engine speeds can produce very high temperatures in the engine and exhaust system, creating the risk of fire or other damage.

 Do not park, idle or drive your vehicle on dry grass or other dry ground cover. The emission system heats up the engine compartment and exhaust system, creating the risk of fire.

 Do not start the engine in a closed garage or in other enclosed areas. Exhaust fumes can be toxic. Always open the garage door before you start the engine.

 If you smell exhaust fumes inside your vehicle, have your vehicle checked by an authorized dealer immediately. Do not drive your vehicle if you smell exhaust fumes.

If you disconnect the battery, your vehicle may exhibit some unusual driving characteristics for approximately 5 miles (8 kilometers) after you reconnect it. This is because the engine management system must realign itself with the engine. You can disregard any unusual driving characteristics during this period.

The powertrain control system meets all Canadian interference-causing equipment standard requirements regulating the impulse electrical field or radio noise.

When you start the engine, avoid pressing the accelerator pedal before and during operation. Only use the accelerator pedal when you have difficulty starting the engine.

IGNITION SWITCH



E72128

0 (off) - The ignition is off.

I (accessory) - Allows the electrical accessories to operate while the engine is not running.

Note: Do not leave the ignition key in this position for too long to avoid your vehicle battery losing charge.

II (on) - All the electrical circuits are operational. Warning lamps and indicators illuminate.

III (start) - cranks the engine. Release the key as soon as the engine starts.

KEYLESS STARTING

WARNING

 Always check that the steering wheel lock is deactivated before attempting to move your vehicle. Failure to deactivate the steering wheel lock could result in a crash.

Note: The system may not function if the remote control is close to metal objects or electronic devices such as cell phones.

Note: The ignition will automatically switch off if your vehicle is left unattended. This is to prevent the vehicle battery from losing charge.

Note: A valid passive key must be located inside your vehicle to switch the ignition on and start the engine.

Starting and Stopping the Engine

Switching the Ignition On (Accessory Mode)



E142318

Press the button once without your foot on the brake or clutch pedal. It is located on the instrument panel near the steering wheel. All electrical circuits and accessories are operational and the warning lamps and indicators illuminate.

Press the button again without your foot on the brake or clutch pedal to turn your vehicle off completely.

Starting Your Vehicle

Manual Transmission

1. Fully depress the clutch pedal.
2. Briefly press the button.

Note: Releasing the clutch pedal during engine start will stop the engine cranking and return to ignition on.

Automatic Transmission

1. Move the transmission selector lever to park.
2. Fully depress the brake pedal.
3. Briefly press the button.

Note: Releasing the brake pedal during engine start will stop the engine cranking and return to ignition on.

Diesel Engine

Note: Engine cranking will not commence until the engine glow plug cycle has been completed. This may take several seconds in extremely cold conditions.

Failure to Start

The system does not function if:

- The passive key frequencies are jammed.
- The passive key battery has no charge.

If you are unable to start your vehicle, do the following.

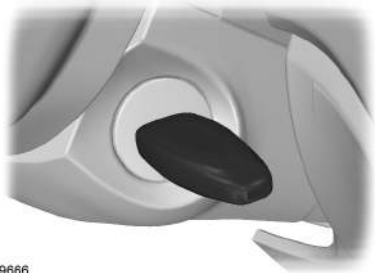

E99666

1. Hold the passive key next to the symbol on the steering column.
2. With the passive key in this position, you can use the button to switch the ignition on and start your vehicle.

Manual Transmission

If the engine does not crank when the clutch pedal has been fully depressed and the button is pressed:

1. Fully depress both the clutch and brake pedals.
2. Press the button until the engine has started.

Note: Releasing the clutch pedal during engine start will stop the engine cranking and return to ignition on. A message will be shown in the display.

Starting and Stopping the Engine

Stopping the Engine When Your Vehicle is Stationary

Note: *The ignition, all electrical circuits warning lamps and indicators will be switched off.*

Manual Transmission

Briefly press the button.

Automatic Transmission

1. Move the transmission selector lever to park.
2. Press the button.

Stopping the Engine When Your Vehicle is Moving

WARNING



Stopping the engine when your vehicle is moving will result in a loss of brake and steering assistance. The steering will not lock, but higher effort will be required. When the ignition is switched off some electrical circuits, warning lamps and indicators may also be off.

1. Press and hold the button for a moment, or press it three times within two seconds.
2. Move the transmission selector lever to neutral and use the brakes to bring your vehicle to a safe stop.
3. When your vehicle has stopped, move the transmission selector lever to park and switch the ignition off.

STEERING WHEEL LOCK

WARNING



Always check that the steering is unlocked before attempting to move your vehicle.

Vehicles without Keyless Starting

To lock the steering wheel:

1. Remove the key from the ignition switch.
2. Rotate the steering wheel slightly to engage the lock.

Vehicles with Keyless Starting

Note: *The steering wheel lock does not engage when the ignition is on or if your vehicle is moving.*

Your vehicle has an electronically controlled steering wheel lock. This operates automatically.

The steering wheel lock engages after a short period after you have parked your vehicle and the passive key is outside of your vehicle.

Unlocking the Steering Wheel

Vehicles with Automatic Transmission

Switch the ignition on or press the brake pedal.

Vehicles with Manual Transmission

Switch the ignition on or press the clutch pedal.

STARTING A GASOLINE ENGINE

Note: *You can only operate the starter for a limited period of time, for example 10 seconds. The number of start attempts is limited to approximately six. If you exceed this limit, the system will not allow you to try again until a period of time has elapsed, for example 30 minutes.*

Starting and Stopping the Engine

Cold or Hot Engine

Vehicles with Manual Transmission

Note: Do not touch the accelerator pedal.

Note: Releasing the clutch pedal while the engine is starting will stop the engine cranking and return to ignition on.

1. Fully depress the clutch pedal.
2. Start the engine.

Vehicles with Automatic Transmission

Note: Do not touch the accelerator pedal.

1. Move the transmission selector lever to position **P** or **N**.
2. Start the engine.

All Vehicles

If the engine does not start within 10 seconds, wait for a short period and try again.

If the engine does not start after three attempts, wait 10 seconds and follow the flooded engine procedure.

If you have difficulty starting the engine when the temperature is below -13°F (-25°C), press the accelerator pedal to the mid-way point of its travel and try again.

Flooded Engine

Vehicles with Manual Transmission

1. Fully depress the clutch pedal.
2. Fully depress the accelerator pedal and hold it there.
3. Start the engine.

Vehicles with Automatic Transmission

1. Move the transmission selector lever to position **P** or **N**.
2. Fully depress the accelerator pedal and hold it there.

3. Start the engine.

All Vehicles

If the engine does not start, repeat the cold or hot engine procedure.

Engine Idle Speed after Starting

The speed at which the engine idles immediately after starting is optimized to minimize vehicle emissions and maximize cabin comfort and fuel economy.

The idle speed will vary depending on certain factors. These include vehicle component and ambient temperatures as well as electrical and climate system demands.

Failure to Start

Vehicles with Manual Transmission

If the engine does not crank when the clutch pedal has been fully depressed and the ignition key is turned to position **III**.

1. Fully depress the clutch and brake pedals.
2. Turn the key to position **III** until the engine has started.

STARTING A DIESEL ENGINE

Cold or Hot Engine

All Vehicles

Note: When the temperature is below 5°F (-15°C), you may need to crank the engine for up to 10 seconds.

Note: You can only operate the starter for a limited period of time.

Note: After a limited number of attempts to start your engine, the system will not allow you to try again until a period of time has elapsed, for example 30 minutes.

Starting and Stopping the Engine



Switch the ignition on and wait until the glow plug indicator goes off.

Vehicles With Manual Transmission

Note: Do not touch the accelerator pedal.

Note: Releasing the clutch pedal while the engine is starting will stop the engine cranking and return to ignition on.

1. Fully depress the clutch pedal.
2. Start the engine.

Vehicles With Automatic Transmission

Note: Do not touch the accelerator pedal.

Note: Releasing the brake pedal while the engine is starting will stop the engine cranking and return to ignition on.

1. Move the transmission selector lever to position **P** or **N**.
2. Fully depress the brake pedal.
3. Start the engine.

Failure to Start

Vehicles With Manual Transmission

If the engine does not crank when the clutch pedal has been fully depressed and the ignition key is turned to position **III**.

1. Fully depress the clutch and brake pedals.
2. Turn the key to position **III** until the engine has started.

DIESEL PARTICULATE FILTER

The filter forms part of the emissions reduction system on your vehicle. It filters harmful diesel particulates (soot) from the exhaust gas.

Regeneration

WARNINGS



Do not park or idle your vehicle over dry leaves, dry grass or other combustible materials. The regeneration process creates very high exhaust gas temperatures and the exhaust will radiate a considerable amount of heat during and after regeneration and after you have switched the engine off. This is a potential fire hazard.



Avoid running out of fuel.

Note: During regeneration at low speed or engine idle, you may smell a hot metallic odor and could notice a clicking metallic sound. This is due to the high temperatures reached during regeneration and is normal.

Note: After you have switched your engine off the fans may continue to run for a short period of time.

A normal filter requires periodic replacement. The diesel particulate filter on your vehicle requires periodic regeneration to maintain its correct function. Your vehicle will carry out this process automatically.

If your journeys meet one of the following conditions:

- You drive only short distances.
- You frequently switch the ignition on and off.
- Your journeys contain a high level of acceleration and deceleration.

Starting and Stopping the Engine

You must carry out occasional trips with the following conditions to assist the regeneration process:

- Drive your vehicle in more favorable conditions, which you will find at higher vehicle speeds in normal driving, on a main road or freeway for a minimum of 20 minutes. This drive may include short stops that will not affect the regeneration process.
- Avoid prolonged idling and always observe speed limits and road conditions.
- Do not switch the ignition off.
- Select a suitable gear to ideally maintain engine speed between 1500 and 3000 RPM.

SWITCHING OFF THE ENGINE

Vehicles With a Turbocharger

WARNING



Do not switch the engine off when it is running at high speed. If you do, the turbocharger will continue running after the engine oil pressure has dropped to zero. This will lead to premature turbocharger bearing wear.

Release the accelerator pedal. Wait until the engine has reached idle speed and then switch it off.

Fuel and Refueling

SAFETY PRECAUTIONS

WARNINGS



Do not overfill the fuel tank. The pressure in an overfilled tank may cause leakage and lead to fuel spray and fire.



Automotive fuels can cause serious injury or death if misused or mishandled.



The flow of fuel through a fuel pump nozzle can produce static electricity, which can cause a fire if fuel is pumped into an ungrounded fuel container.



Fuel ethanol and gasoline may contain benzene, which is a cancer-causing agent.



When refueling always shut the engine off and never allow sparks or open flames near the filler neck.

Never smoke while refueling. Fuel vapor is extremely hazardous under certain conditions. Care should be taken to avoid inhaling excess fumes.

Observe the following guidelines when handling automotive fuel:

- Extinguish all smoking materials and any open flames before refueling your vehicle.
- Always turn off the vehicle before refueling.
- Automotive fuels can be harmful or fatal if swallowed. Fuel such as gasoline is highly toxic and if swallowed can cause death or permanent injury. If fuel is swallowed, call a physician immediately, even if no symptoms are immediately apparent. The toxic effects of fuel may not be visible for hours.

- Avoid inhaling fuel vapors. Inhaling too much fuel vapor of any kind can lead to eye and respiratory tract irritation. In severe cases, excessive or prolonged breathing of fuel vapor can cause serious illness and permanent injury.
- Avoid getting fuel liquid in your eyes. If fuel is splashed in the eyes, remove contact lenses (if worn), flush with water for 15 minutes and seek medical attention. Failure to seek proper medical attention could lead to permanent injury.
- Fuels can also be harmful if absorbed through the skin. If fuel is splashed on the skin, clothing or both, promptly remove contaminated clothing and wash skin thoroughly with soap and water. Repeated or prolonged skin contact with fuel liquid or vapor causes skin irritation.

FUEL QUALITY - GASOLINE

WARNINGS



Do not mix gasoline with oil, diesel or other liquids. This could cause a chemical reaction.



Do not use leaded gasoline or gasoline with additives containing other metallic compounds (e.g. manganese-based). They could damage the emission system.

Note: We recommend that you use only high quality fuel.

Note: We do not recommend the use of additional additives or other engine treatments for normal vehicle use.

Use minimum 95 octane unleaded gasoline that meets the specification defined by EN 228 or the equivalent national specification.

Fuel and Refueling

Your vehicle is suitable for use with ethanol blends up to 10% (E5 and E10).

Long-Term Storage

Most gasoline contains ethanol. We recommend that you fill the fuel tank with fuel that does not contain ethanol if you intend to store your vehicle for more than two months. Alternatively, we recommend that you seek advice from an authorized dealer.

FUEL QUALITY - DIESEL

WARNINGS



Do not mix diesel with oil, gasoline or other liquids. This could cause a chemical reaction.



Do not add kerosene, paraffin or gasoline to diesel. This could cause damage to the fuel system.



Use diesel that meets the specification defined by EN 590 or the relevant national specification.

Note: We recommend that you use only high quality fuel.

Note: We do not recommend the use of additional additives or other engine treatments for normal vehicle use.

Note: We do not recommend the use of additional additives to prevent fuel waxing.

Long-Term Storage

Most diesel fuels contain biodiesel. We recommend that you fill the fuel tank with fuel that does not contain biodiesel if you intend to store your vehicle for more than two months. Alternatively, we recommend that you seek advice from your dealer.

CATALYTIC CONVERTER

WARNING



Do not park or idle your vehicle over dry leaves, dry grass or other combustible materials. The exhaust will radiate a considerable amount of heat during use, and after you have switched the engine off. This is a potential fire hazard.

Driving with a Catalytic Converter

WARNINGS



Avoid running out of fuel.



Do not crank the engine for long periods.



Do not run the engine when a spark plug lead is disconnected.



Do not push-start or tow-start your vehicle. Use booster cables. See **Jump-Starting the Vehicle** (page 115).



Do not switch the ignition off when driving.

RUNNING OUT OF FUEL

Avoid running out of fuel because this situation may have an adverse effect on powertrain components.

If you have run out of fuel:

Fuel and Refueling

- You may need to cycle the ignition from off to on several times after refuelling to allow the fuel system to pump the fuel from the tank to the engine. On restarting, cranking time will take a few seconds longer than normal. With keyless ignition, just start the engine. Crank time will be longer than usual.
- Normally, adding 3.8 litres of fuel is enough to restart the engine. If your vehicle is out of fuel and on a steep grade, more than 3.8 litres may be required.

Refilling with a Portable Fuel Container

WARNING

 Do not pump fuel into an ungrounded fuel container, as the static electricity produced during the flow of petrol through the nozzle may cause fire.

To avoid static build up:

- Place the approved fuel container on the ground.
- Do not fill the container whilst in the vehicle or utility tray.
- Keep the nozzle in contact with the fuel container whilst filling.

REFUELING

WARNINGS

 Do not attempt to start the engine if you have filled the fuel tank with the incorrect fuel. This could damage the engine. Have the system checked immediately by a Ford Dealer.

 Do not use any kind of flames or heat near the fuel system. The fuel system is under pressure. There is a risk of injury if the fuel system is leaking.

WARNINGS

 If you use a high pressure spray to wash your vehicle, only spray the fuel filler flap briefly from a distance not less than 20 centimeters.

Note: *Flex fuel vehicles can be fueled with gasoline, ethanol or a mixture of both.*

If you are refueling with a different fuel than that used previously, we recommend that you drive the vehicle immediately after refueling for at least 10 minutes. This is necessary because the engine control module needs to adapt itself to the fuel present in the tank. This procedure is especially important when the fuel level gauge indicates less than half before refueling.

If your vehicle stopped due to lack of fuel (empty tank) you should refuel preferably with gasoline.

Fuel Filler Cap

Your fuel tank filler cap has a regular turn style design, with two to three turns on or off.

When fueling your vehicle:

1. Turn the engine off.
2. Carefully turn the filler cap counterclockwise two to three turns, until it opens.
3. Hang the fuel cap tether cord on the filler door hook.
4. After refueling, to install the cap, align it with the filler pipe.
5. Turn the filler cap clockwise two to three turns until it clicks twice.

If you must replace the fuel filler cap, replace it with a fuel filler cap that is designed for your vehicle. The customer warranty may be void for any damage to the fuel tank or fuel system if the correct genuine Ford fuel filler cap is not used.

Fuel and Refueling

FUEL CONSUMPTION

Note: *The amount of usable fuel in the empty reserve varies and should not be relied upon to increase driving range. When refueling your vehicle after the fuel gauge indicates empty, you might not be able to refuel the full amount of the advertised capacity of the fuel tank due to the empty reserve still present in the tank.*

Indicated capacity is the difference in the amount of fuel in a full tank and a tank when the fuel gauge indicates empty. Empty reserve is the amount of fuel in the tank after the fuel gauge indicates empty.

Your dealer can give you advice on improving your fuel consumption.

Filling the Tank

For consistent results when filling the fuel tank:

- Turn the ignition off before fueling; an inaccurate reading results if the engine is left running.
- Use the same fill rate (low-medium-high) each time the tank is filled.
- The maximum tank capacity, during fueling, is reached when the pump is automatically cut off for the second time.

Results are most accurate when the filling method is consistent.

Calculating Fuel Economy

Do not measure fuel economy during the first 1600 kilometers of driving (this is your engine's break-in period); a more accurate measurement is obtained after 3200 kilometers - 4800 kilometers. Also, fuel expense, frequency of fill ups or fuel gauge readings are not accurate ways to measure fuel economy.

1. Fill the fuel tank completely and record the initial odometer reading.
2. Each time you fill the tank, record the amount of fuel added.
3. After at least three to five tank fill ups, fill the fuel tank and record the current odometer reading.
4. Subtract your initial odometer reading from the current odometer reading.
5. Calculate fuel economy by multiplying liters used by 100, and then dividing it by the traveled kilometers.

Keep a record for at least one month and record the type of driving (city or highway). This provides an accurate estimate of the vehicle's fuel economy under current driving conditions. Additionally, keeping records during summer and winter show how temperature impacts fuel economy. In general, lower temperatures mean lower fuel economy.

FUEL CONSUMPTION FIGURES - 1.0L ECOBOOST™

Urban	Extra-Urban	Combined	CO2 Emissions
l/100 km (mpg)	l/100 km (mpg)	l/100 km (mpg)	g/km
6.6 (42.8)	4.7 (60.1)	5.3 (53.3)	125

Fuel and Refueling

FUEL CONSUMPTION FIGURES - 1.5L DURATEC-16V TI-VCT (81KW/110PS) - SIGMA, VEHICLES WITH: 5-SPEED MANUAL TRANSMISSION

Urban	Extra-Urban	Combined	CO2 Emissions
l/100 km (mpg)	l/100 km (mpg)	l/100 km (mpg)	g/km
8.1 (34.9)	5.2 (54.3)	6.3 (44.8)	149

Fuel and Refueling

FUEL CONSUMPTION FIGURES - 1.5L DURATEC-16V TI-VCT (81KW/110PS) - SIGMA, VEHICLES WITH: 6-SPEED AUTOMATIC TRANSMISSION

Urban	Extra-Urban	Combined	CO2 Emissions
l/100 km (mpg)	l/100 km (mpg)	l/100 km (mpg)	g/km
7.9 (35.8)	5.3 (53.3)	6.3 (44.8)	149

Fuel and Refueling

FUEL CONSUMPTION FIGURES - 1.5L DURATORQ-TDCI

Urban	Extra-Urban	Combined	CO2 Emissions
l/100 km (mpg)	l/100 km (mpg)	l/100 km (mpg)	g/km
4.9 (57.6)	4.4 (64.2)	4.6 (61.4)	120

Transmission

MANUAL TRANSMISSION

Selecting Reverse Gear

Do not engage reverse gear when your vehicle is moving. This can cause damage to the transmission.

AUTOMATIC TRANSMISSION

WARNINGS



Always set the parking brake fully and make sure you move the transmission selector lever to position **P**. Switch the ignition off and remove the key whenever you leave your vehicle.



Do not apply the brake pedal and accelerator pedal simultaneously. Applying both pedals simultaneously for more than three seconds will limit engine rpm, which may result in difficulty maintaining speed in traffic and could lead to serious injury.

Note: *The system performs a series of checks when you switch the ignition off. You may hear a slight clicking sound. This is normal.*

Selector Lever Positions



E161746

- P Park
- R Reverse
- N Neutral
- D Drive
- S Sport mode and manual shifting
- + Manual shift up
- Manual shift down

WARNING



Apply the brakes before moving the transmission selector lever and keep them applied until you are ready to move off.

Press the button on the transmission selector lever to change to each position. The transmission selector lever position will be shown in the information display.

P (Park)

WARNINGS



Move the transmission selector lever to park only when your vehicle is stationary.

Transmission

WARNINGS



Apply the parking brake and move the transmission selector lever to park before leaving your vehicle.

Make sure that the transmission selector lever is latched in position.

Note: *An audible warning will sound if you open the driver's door and you have not moved the transmission selector lever to park.*

In this position, power is not transmitted to the drive wheels and the transmission is locked. You can start the engine with the transmission selector lever in this position.

R (Reverse)

WARNINGS



Move the transmission selector lever to reverse only when your vehicle is stationary and the engine is at idle speed.



Always come to a complete stop before shifting the transmission selector lever out of reverse.

Move the transmission selector lever to reverse to allow your vehicle to move backward.

N (Neutral)

In this position, power is not transmitted to the drive wheels but the transmission is not locked. You can start the engine with the transmission selector lever in this position.

D (Drive)

Note: *A shift will occur only when your vehicle speed and the engine speed are appropriate.*

Note: *You may temporarily override the current gear selected using the + and - buttons.*

Select drive to shift automatically through the forward gears.

The transmission will select the appropriate gear for optimum performance based on ambient temperature, road gradient, vehicle load and your input.

Sport Mode and Manual Shifting

Sport Mode

Note: *In sport mode the transmission operates as normal but gears are selected more quickly and at higher engine speeds.*

Note: *In sport mode S will be shown in the information display.*

Switch on sport mode by moving the transmission selector lever to position **S**. Sport mode will remain on until either you shift manually up or down the gears using **+** and **-** or move the transmission selector lever to position **D**.

Manual Shifting

WARNINGS



Do not hold the buttons permanently in **-** or **+**.



The transmission will automatically downshift when the engine speed is too low.

Press the **-** button to shift down and press the **+** button to shift up.

Gears may be skipped by pressing the buttons repeatedly at short intervals.

Manual mode also provides a kickdown function. See Kickdown.

Transmission

Hints on Driving With an Automatic Transmission

WARNING



Do not idle the engine for long periods of time in drive with the brakes applied.

Moving Off

1. Release the parking brake.
2. Release the brake pedal and press the accelerator pedal.

Stopping

1. Release the accelerator pedal and press the brake pedal.
2. Apply the parking brake.
3. Move the transmission selector lever to **N** or **P**.

Kickdown

Press the accelerator pedal fully with the transmission selector lever in the drive position to select the next lowest gear for optimum performance. Release the accelerator pedal when you no longer require kickdown.

If Your Vehicle Gets Stuck In Mud or Snow

Note: Do not rock your vehicle if the engine is not at normal operating temperature or damage to the transmission may occur.

Note: Do not rock your vehicle for more than a minute or damage to the transmission and tires may occur, or the engine may overheat.

If your vehicle gets stuck in mud or snow, it may be rocked out by shifting between forward and reverse gears, stopping between shifts in a steady pattern. Press lightly on the accelerator in each gear.

Emergency Park Position Release Lever

WARNINGS



Do not drive your vehicle until you verify that the brake lamps are working.



If the parking brake is fully released, but the brake warning lamp remains illuminated, the brakes may not be working correctly. See an authorized dealer.

Use the lever to move the transmission selector lever from the park position in the event of an electrical malfunction or if your vehicle battery has no charge.

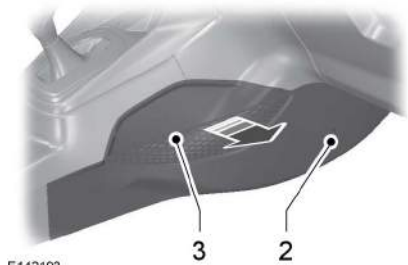

E142193

1. Apply the parking brake and switch the ignition off before performing this procedure.
2. Remove the retaining screw.
3. Remove the center console side panel.

Transmission

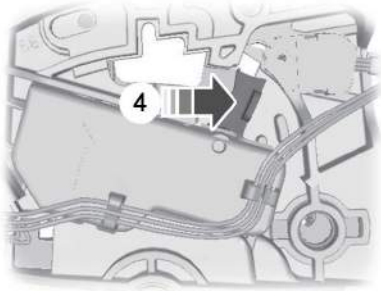

E142214

Note: *The lever is pink.*

4. Apply the brake pedal. Using a suitable tool rotate the lever forward while pulling the transmission selector lever out of the park position and into the neutral position.

Note: *See an authorized dealer as soon as possible if this procedure is used.*

HILL START ASSIST (IF EQUIPPED)

WARNINGS

 The hill start assist feature does not replace the parking brake. When you leave the vehicle, always apply the parking brake.

 You must remain in the vehicle once you have activated the hill start assist feature.

 During all times, you are responsible for controlling the vehicle, supervising the hill start assist system and intervening, if required.

 If the engine is revved excessively, or if a malfunction is detected when the hill start assist feature is active, the hill start assist feature will be deactivated.

This feature makes it easier to pull away when the vehicle is on a slope without the need to use the parking brake.

When this feature is active, the vehicle will remain stationary on the slope for two to three seconds after you release the brake pedal. This allows you time to move your foot from the brake to the accelerator pedal. The brakes are released automatically once the engine has developed sufficient drive to prevent the vehicle from rolling down the slope. This is an advantage when pulling away on a slope, (for example from a car park ramp, traffic lights or when reversing uphill into a parking space).

This feature is activated automatically on any slope that can result in significant vehicle rollback.

Activating Hill Start Assist

Note: *If the engine is revved excessively, hill start assist will be deactivated.*

1. Press the brake pedal to bring the vehicle to a complete standstill. Keep the brake pedal pressed.
2. If the sensors detect that the vehicle is on a slope, the hill start assist feature will be activated automatically.
3. When you remove your foot from the brake pedal, the vehicle will remain on the slope without rolling away for approximately two or three seconds. This hold time will automatically be extended if you are in the process of driving off.
4. Drive off in the normal manner. The brakes will be released automatically.

Transmission

Deactivating Hill Start Assist

Perform one of the following:

- To deactivate hill start assist, Drive off uphill without reapplying the brake.
- Wait for two to three seconds until the hill start assist system deactivates automatically.
- If a forward gear was selected when the system is active on, select reverse gear.
- If reverse gear was selected when the system is active, select a forward gear.

Brakes

GENERAL INFORMATION

Disc Brakes

Wet brake discs result in reduced braking efficiency. Dab the brake pedal when driving from a car wash to remove the film of water.

Emergency Brake Assist

WARNING



The system does not relieve you of your responsibility to drive with due care and attention.

The system will detect when you brake heavily by measuring the rate at which you press the brake pedal. It will provide maximum braking efficiency as long as you press the pedal.

Anti-lock Brakes (If Equipped)

WARNING



The system does not relieve you of your responsibility to drive with due care and attention.

The system helps you to maintain steering and directional stability when you brake heavily in an emergency, by preventing the road wheels from locking.

HINTS ON DRIVING WITH ANTI-LOCK BRAKES

Note: When the system is operating, the brake pedal will pulse and may travel further. Maintain pressure on the brake pedal. You may also hear a noise from the system. This is normal.

The anti-lock braking system will not eliminate the risks when:

- you drive too closely to the vehicle in front of you
- your vehicle is hydroplaning
- you take corners too fast
- the road surface is poor.

PARKING BRAKE

Vehicles With Automatic Transmission

WARNING



Always set the parking brake fully and leave your vehicle with the transmission selector lever in position P.

Note: If you park your vehicle on a hill and facing uphill move the transmission selector lever to position P and turn the steering wheel away from the curb.

Note: If you park your vehicle on a hill and facing downhill move the transmission selector lever to position P and turn the steering wheel toward the curb.

Vehicles With Manual Transmission

Note: If you park your vehicle on a hill and facing uphill select first gear and turn the steering wheel away from the curb.

Note: If you park your vehicle on a hill and facing downhill select reverse gear and turn the steering wheel toward the curb.

All Vehicles

Note: Do not press the release button while pulling the lever up.

To apply the parking brake:

1. Press the foot brake pedal firmly.

Brakes

2. Pull the parking brake lever up to its fullest extent.

To release the parking brake:

1. Press the brake pedal firmly.
2. Pull the lever up slightly.
3. Press the release button and push the lever down.

Traction Control (If Equipped)

PRINCIPLE OF OPERATION

The traction control system helps avoid drive wheel spin and loss of traction.

If your vehicle begins to slide, the system applies the brakes to individual wheels and, when needed, reduces engine power at the same time. If the wheels spin when accelerating on slippery or loose surfaces, the system reduces engine power in order to increase traction.

USING TRACTION CONTROL

In certain situations for example, stuck in snow or mud, turning the traction control off may be beneficial as this allows the wheels to spin with full engine power. Depending on the type of system you have on your vehicle, you can either turn the system off using the information display or by pressing the button.

Switching the System Off Using the Information Display Controls

(If Equipped)

Your vehicle comes with this feature already enabled. If required, you can switch this feature off using the information display controls. See **Principle of Operation** (page 103).

Switching the System Off Using a Switch (If Equipped)

The button is located in the instrument panel.

Press the button. You will see a message in conjunction with an illuminated icon in the display. Press the button again to return the system to normal mode.

When you switch the traction control system off, stability control remains fully active.

System Indicator Lights and Messages

WARNING



If a failure has been detected within the AdvanceTrac system, the stability control light will illuminate steadily. Verify that the AdvanceTrac system was not manually disabled through the information display. If the stability control light still illuminates steadily, have the system serviced by an authorized dealer immediately. Operating your vehicle with AdvanceTrac disabled could lead to an increased risk of loss of vehicle control, vehicle rollover, personal injury and death.



The stability control light temporarily illuminates on engine start-up and flashes when a driving condition activates the stability system.



The stability control off light temporarily illuminates on engine start-up and stays on when you turn the traction control system off.

When you turn the traction control system off or on, a message appears in the information display showing system status.

Stability Control (If Equipped)

PRINCIPLE OF OPERATION

Electronic Stability Program

WARNING



The system does not relieve you of your responsibility to drive with due care and attention. Failure to do so could result in loss of vehicle control, personal injury or death.

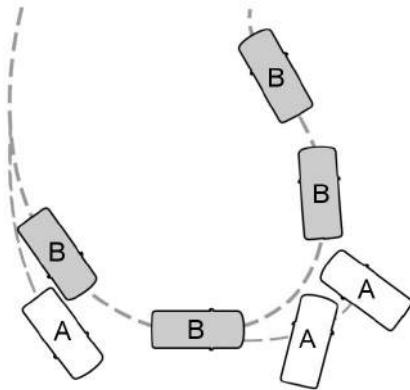

E72903

- A Without ESP
- B With ESP

The system supports stability when your vehicle starts to slide away from your intended path. The system performs this by braking individual wheels and reducing engine torque as required.

The system also provides an enhanced traction control function by reducing engine torque if the wheels spin when you accelerate. This improves your ability to pull away on slippery roads or loose surfaces, and improves comfort by limiting wheel spin in hairpin bends.

Stability Control Warning Lamp

While driving, it flashes when the system is operating. See **Warning Lamps and Indicators** (page 56).

USING STABILITY CONTROL





Note: *The system is automatically activated when you start the engine.*

The traction control portion of the system can be turned off through the information display. See **Using Traction Control** (page 103).

Parking Aids (If Equipped)

PRINCIPLE OF OPERATION

WARNINGS

-  The parking aid does not relieve you of your responsibility to drive with due care and attention.
-  The sensors may not detect objects in heavy rain or other conditions that cause disruptive reflections.
-  The sensors may not detect objects with surfaces that absorb ultrasonic waves.
-  The parking aid does not detect obstacles moving away from the vehicle. They will only be detected shortly after they start to move towards the vehicle again.
-  Take particular care when reversing with rear fitted accessories e.g. a bicycle carrier, as the rear parking aid will only indicate the distance from the bumper to the obstacle.
-  If you use a high pressure spray to wash your vehicle, only spray the sensors briefly from a distance not less than 8 inches (20 centimeters).





Note: Keep the sensors free from dirt, ice and snow. Do not clean with sharp objects.

Note: The parking aid may emit false tones if it detects a signal using the same frequency as the sensors or if the vehicle is fully laden.

Note: The outer sensors may detect the side walls of a garage. If the distance between the outer sensor and the side wall remains constant for three seconds, the tone will switch off. As you continue, the inner sensors will detect rearward objects.

PARKING AID

WARNINGS

-  To help avoid personal injury, read and understand the limitations of the system as contained in this section. Sensing is only an aid for some (generally large and fixed) objects when moving in reverse on a flat surface at parking speeds. Traffic control systems, inclement weather, air brakes and external motors and fans may also affect the function of the sensing system. This may include reduced performance or a false activation.
-  To help avoid personal injury, always use caution when moving in reverse and when using the sensing system.
-  This system is not designed to prevent contact with small or moving objects. The system is designed to provide a warning to assist the driver in detecting large stationary objects to avoid damaging the vehicle. The system may not detect smaller objects, particularly those close to the ground.
-  Certain add-on devices such as large trailer hitches, bike or surfboard racks and any device that may block the normal detection zone of the system, may create false audible warnings.

Note: Keep the sensors located on the bumper or fascia free from snow, ice and large accumulations of dirt. If the sensors are covered, the system's accuracy can be affected. Do not clean the sensors with sharp objects.

Note: If your vehicle sustains damage to the bumper or fascia, leaving it misaligned or bent, the sensing zone may be altered causing inaccurate measurement of obstacles or false alarms.

The system warns you of obstacles within a certain range of the bumper area.

Parking Aids (If Equipped)

When receiving a detection warning, the radio volume is reduced to a predetermined level. After the warning goes away, the radio volume returns to the previous level.

Rear Sensing System

The rear sensors are only active when you move the transmission selector lever to position **R** (reverse). As your vehicle moves closer to the obstacle, the rate of the audible warning increases. When the obstacle is fewer than 12 inches (30 centimeters) away, the audible warning sounds continuously. If a stationary or receding object is detected farther than 12 inches (30 centimeters) from the side of your vehicle, the audible warning sounds for only three seconds. Once the system detects an object approaching, the audible warning sounds again.

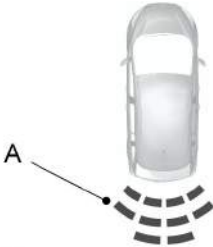

E130178

- A Coverage area of up to 72 inches (183 centimeters) from the rear bumper (with a decreased coverage area at the outer corners of the bumper).

The system detects certain objects when you move the transmission selector lever to position **R** (reverse):

- and your vehicle is moving toward a stationary object at a speed of 3 mph (5 km/h) or less
- but your vehicle is not moving, and a moving object is approaching the rear of your vehicle at a speed of 3 mph (5 km/h) or less
- and your vehicle is moving at a speed of less than 3 mph (5 km/h) and a moving object is approaching the rear of your vehicle at a speed of less than 3 mph (5 km/h).

Move the transmission selector lever from position **R** (reverse) to turn the system off. If a fault is present in the system, a warning message appears in the information display and does not allow you to switch the system on.

Cruise Control (If Equipped)

PRINCIPLE OF OPERATION

Cruise control lets you maintain a set speed without keeping your foot on the accelerator pedal.

USING CRUISE CONTROL

WARNINGS



Do not use cruise control in heavy traffic, on winding roads or when the road surface is slippery. This could result in loss of vehicle control, serious injury or death.



When you are going downhill, your speed may increase above the set speed. The system will not apply the brakes. Change down a gear to assist the system in maintaining the set speed. Failure to do so could result in loss of vehicle control, serious injury or death.

Note: *Cruise control will disengage if your vehicle speed decreases more than 10 mph (16 km/h) below your set speed while driving uphill.*



E102679

The cruise controls are located on the steering wheel.

Switching Cruise Control On

Press and release **ON**.



The indicator will display in the instrument cluster.

Setting a Speed

1. Accelerate to the desired speed.
2. Press and release **SET+**.
3. Take your foot off the accelerator pedal.

Changing the Set Speed

- Press and hold **SET+** or **SET-**. Release the control when you reach the desired speed.
- Press and release **SET+** or **SET-**. The set speed will change in approximately 1 mph (2 km/h) increments.
- Press the accelerator or brake pedal until you reach the desired speed. Press and release **SET+**.

Canceling the Set Speed

Press and release **CAN**, or tap the brake pedal. The set speed will not be erased.

Resuming the Set Speed

Press and release **RES**.

Switching Cruise Control Off

Note: *You will erase the set speed if you switch the system off.*

Press and release **OFF** or switch the ignition off.

Driving Aids

STEERING

Electric Power Steering

WARNINGS



The electric power steering system has diagnostic checks that continuously monitor the system to ensure proper operation. When a system error is detected a steering message will appear in the information display.



The electric power steering system has diagnostic checks that continuously monitor the system to ensure proper operation of the electronic system. When an electronic error is detected, a message will be displayed in the information display. If this happens, stop the vehicle in a safe place, and turn off the engine. After at least 10 seconds, reset the system by restarting the engine, and watch the information display for a steering message. If a steering message returns, or returns while driving, take the vehicle to your dealer to have it checked.



Obtain immediate service if a system error is detected. You may not notice any difference in the feel of your steering, but a serious condition may exist. Failure to do so may result in loss of steering control.

Your vehicle is equipped with an electric power-assisted steering system. There is no fluid reservoir to check or fill.

If your vehicle loses electrical power while you are driving (or if the ignition is turned off), you can steer the vehicle manually, but it takes more effort. Extreme continuous steering may increase the effort it takes for you to steer. This occurs to prevent internal overheating and permanent damage to your steering

system. If this should occur, you will neither lose the ability to steer the vehicle manually nor will it cause permanent damage. Typical steering and driving maneuvers will allow the system to cool and steering assist will return to normal.

Steering Tips

If the steering wanders or pulls, check for:

- an improperly inflated tire
- uneven tire wear
- loose or worn suspension components
- loose or worn steering components
- improper vehicle alignment

A high crown in the road or high crosswinds may also make the steering seem to wander or pull.

Adaptive Learning

The EPS system adaptive learning helps correct for road irregularities and improves overall handling and steering feel. It communicates with the vehicle's brake system to help operate advanced stability control and accident avoidance systems. Additionally, whenever the battery is disconnected or a new battery installed, the vehicle must be driven a short distance before the strategy is relearned and all systems are reactivated.

Load Carrying

GENERAL INFORMATION

WARNINGS



Use load securing straps to an approved standard, e.g. DIN.



Make sure that you secure all loose items properly.



Place luggage and other loads as low and as far forward as possible within the luggage or loadspace.



Do not drive with the liftgate or rear door open. Exhaust fumes may enter your vehicle.



Do not exceed the maximum front and rear axle loads for your vehicle. See **Vehicle Identification Plate** (page 159).



Do not allow items to contact the rear windows.

Note: When loading long objects in to your vehicle, for example pipes, timber or furniture be careful not to damage the interior trim.

LUGGAGE ANCHOR POINTS



E142324

LUGGAGE COVERS

WARNING



Do not place objects on the luggage cover.

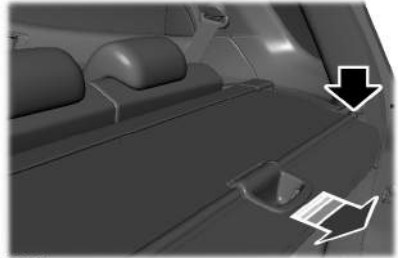

E156538

Pull out the cover and secure it in the retaining points.

Release it from the retaining points and let it roll back into the case.

ROOF RACKS AND LOAD CARRIERS

WARNING



When loading the roof rail crossbars, it is recommended to evenly distribute the load, as well as maintain a low center of gravity. Loaded vehicles, with higher centers of gravity, may handle differently than unloaded vehicles. Extra precautions, such as slower speeds and increased stopping distance, should be taken when driving a heavily loaded vehicle.

The maximum recommended load, evenly distributed on the crossbars, is:

- 20 kilograms.

Load Carrying

Note: *Loads should never be placed directly on the roof panel. The roof panel is not designed to directly carry a load.*

For proper function of the roof rack system, loads must be placed directly on crossbars affixed to the roof rack side rails. Your vehicle may be equipped with factory-installed crossbars. Ford Genuine Accessory crossbars, designed specifically for your vehicle, are also recommended for use with your roof rack system.

Make sure that the load is securely fastened. Check the tightness of the load before driving and at each fuel stop.

Adjusting the Crossbar (If Equipped)

Note: *Wind noise can be minimized by either removing or repositioning the crossbar when not in use. Position the front crossbar in the intermediate position to minimize wind noise. The crossbar can be adjusted or removed using the steps below.*

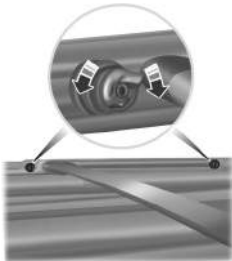

E142448

1. Remove the crossbar thumbwheels at both sides of the crossbar by turning them counterclockwise.
2. Remove the crossbar by rotating it clockwise and sliding the ends off of the shoulder bolts in the side rails.
3. Move the front crossbar to the new side rail position and slide the crossbar onto the shoulder bolt at that position.
4. Replace and tighten the thumbwheels at both sides of the crossbar by turning them clockwise until tight.

Make sure to check that the thumbwheels are tight each time load is added or removed from the roof rack, and periodically while traveling. Make sure that the load is secure before traveling.

Towing

TOWING A TRAILER

WARNINGS



Do not exceed 62 mph (100 km/h).



The rear tire pressures must be increased by 3 psi (0.2 bar) above specification. See **Technical Specifications** (page 157).



Do not exceed the maximum gross train weight stated on your vehicle identification plate. See **Vehicle Identification Plate** (page 159).



Do not exceed the maximum permissible nose weight, i.e. vertical weight on the tow ball, of 110 pounds (50 kilograms).



The electrical system is not suitable for towing trailers with more than one rear fog lamp.

Note: *Not all vehicles are suitable or approved to have tow bars fitted. Check with your dealer first.*

Place loads as low and central to the axle(s) of the trailer as possible. If you are towing with an unladen vehicle, the load in the trailer should be placed toward the nose, within the maximum nose load, as this gives the best stability.

The stability of your vehicle to trailer combination is very much dependant on the quality of the trailer.

In high altitude regions above 3 281 feet (1 000 meters), the stipulated maximum permitted gross train weight must be reduced by 10% for every additional 3 281 feet (1 000 meters).

Steep Gradients

WARNING



The anti-lock braking system does not control the overrun brake on the trailer.

Change down a gear before you reach a steep downhill gradient.

TOWING POINTS (IF EQUIPPED)

Front Towing Eye



E156610

The towing eye is located in the luggage compartment under the floor cover.

The towing eye must always be carried in the vehicle.

Pry off the cover and install the towing eye.

Note: *The screw-in towing eye has a left-hand thread. Turn it anti-clockwise to install it. Make sure that the towing eye is fully tightened.*

Towing

Rear Towing Hook

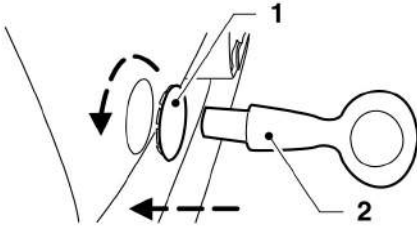

E146284





Insert a suitable object into the hole on the underside of the cover and pry off the cover.

Note: The screw-in towing eye has a left-hand thread. Turn it anti-clockwise to install it. Make sure that the towing eye is fully tightened.

TOWING THE VEHICLE ON FOUR WHEELS

All Vehicles





WARNINGS

-  You must switch the ignition on when your vehicle is being towed.
-  The brake and steering assistance will not operate unless the engine is running. Press the brake pedal harder and allow for increased stopping distances and heavier steering.
-  Too much tension in the tow rope could cause damage to your vehicle or the vehicle that is towing.
-  Do not use a rigid tow bar on the front towing eye.
-  When towing your vehicle you must select neutral.

Drive off slowly and smoothly without jerking the towed vehicle.

Vehicles with Automatic Transmission

WARNINGS

-  If a speed of 12 mph (20 km/h) and a distance of 12 miles (20 kilometers) is to be exceeded the drive wheels must be lifted clear of the ground.
-  It is recommended not to tow with the drive wheels on the ground. However, if it is required to move your vehicle from a dangerous location, do not tow your vehicle faster than 12 mph (20 km/h) or further than 12 miles (20 kilometers).
-  Do not tow your vehicle backward.
-  In the event of a mechanical failure of the transmission the drive wheels must be lifted clear of the ground.
-  Do not tow your vehicle if the ambient temperature is below 32°F (0°C).

Driving Hints

BREAKING-IN

Tires

WARNING



New tires need to be run-in for approximately 300 miles (500 kilometers). During this time, you may experience different driving characteristics.

Brakes and Clutch

WARNING



Avoid heavy use of the brakes and clutch if possible for the first 100 miles (150 kilometers) in town and for the first 1000 miles (1500 kilometers) on freeways.

Engine

WARNING



Avoid driving too fast during the first 1000 miles (1500 kilometers). Vary your speed frequently and change up through the gears early. Do not labor the engine.

ECONOMICAL DRIVING

The following will help to improve fuel consumption.

Tire Pressures

Check your tire pressures regularly to optimize fuel economy. For best results use the economy pressures. See **Technical Specifications** (page 157).

Gear Shifting

Use the highest drivable gear appropriate for the road conditions.

Anticipation

Adjust your vehicle speed and the distance to other vehicles without the need for heavy braking or acceleration.

Efficient Speed

Higher speeds use more fuel. Reduce your cruising speed on open roads.

Accessories

Try not to add unnecessary accessories to the exterior of your vehicle. If you use a roof rack, remember to fold it down or remove it when not in use.

Electrical Systems

Switch off all electrical systems when not in use, for example air conditioning. Make sure you unplug any accessories from the auxiliary power points when not in use.

COLD WEATHER PRECAUTIONS

The functional operation of some components and systems can be affected at temperatures below -13°F (-25°C).

DRIVING THROUGH WATER

WARNINGS



Drive through water in an emergency only and not as part of normal driving.



Engine damage can occur if water enters the air filter.

Driving Hints

In an emergency, you can drive your vehicle through water to a maximum depth of 8 inches (200 millimeters) and at a maximum speed of 6 mph (10 km/h). You must take extra care when driving through flowing water.

When driving in water, maintain a low speed and do not stop your vehicle. After driving through water and as soon as it is safe to do so:

- Depress the brake pedal lightly to check that the brakes are functioning correctly.
- Check that the horn works.
- Check that your vehicle's lamps are fully operational.
- Check the power assistance of the steering system.

FLOOR MATS









E142666

WARNINGS

 Always use floor mats that are designed to fit the foot well of your vehicle, leaving the pedal area unobstructed, and which can be firmly secured to retention posts so that they cannot slip out of position and interfere with the pedals or impair safe operation of your vehicle in other ways.

WARNINGS

-  Incorrectly fitted floor mats can cause the accelerator pedal to become stuck in the open position. This can cause loss of vehicle control.
-  Always correctly install the floor mats to the retention posts so that they cannot slip out of position or obstruct pedal operation.
-  Do not place unsecured floor mats or any other covering in the foot well.
-  Do not place additional floor mats or any other covering on top of the original floor mats. This will reduce the pedal clearance and interfere with the pedal operation.
-  Do not allow objects to fall or become trapped under the pedals of your vehicle. This can cause loss of vehicle control.
-  Carry out regular inspections to make sure the floor mats are secure.

To install the floor mats, position the floor mat eyelet over the retention post and press down to lock in position.

Remove in reverse order.

Roadside Emergencies

HAZARD WARNING FLASHERS



The hazard warning button is located on the instrument panel. Use it when your vehicle is creating a safety hazard for other motorists.

Press the button to turn on the hazard warning function, and the front and rear direction indicators will flash.

Press the button again to turn them off.

Note: *If used when the engine is not running, the battery will lose charge. There may be insufficient power to restart your engine.*

Note: *Depending on applicable laws and regulations in the country for which your vehicle was originally built, the hazard warning flashers may flash if you brake heavily.*

FUEL SHUTOFF

WARNING



Failure to inspect and, if necessary, repair fuel leaks after a collision may increase the risk of fire and serious injury. Ford Motor Company recommends that the fuel system be inspected by an authorized dealer after any collision.

In the event of a moderate to severe collision, this vehicle is equipped with a fuel pump shut-off feature that stops the flow of fuel to the engine. Not every impact will cause a shut-off.

Should your vehicle shut off after a collision, you may restart your vehicle by doing the following:

1. Turn the ignition off.
2. Turn the ignition to crank.

3. Turn the ignition off.
4. Turn the ignition on again to re-enable the fuel pump.

For vehicles equipped with a push button start system:

1. Press the **START/STOP** button to turn the ignition off.
2. Press the brake pedal and press the **START/STOP** button (crank attempt).
3. Remove your foot from the brake pedal and press the **START/STOP** button (ignition off).
4. Press the **START/STOP** button again to re-enable the fuel system.

WARNING TRIANGLE

Space is provided in the luggage compartment.

JUMP-STARTING THE VEHICLE

WARNINGS



Do not use fuel lines, engine rocker covers or the intake manifold as grounding points.



Connect batteries with only the same nominal voltage.



Always use booster cables with insulated clamps and adequate size cable.

Note: *Do not disconnect the battery from your vehicle's electrical system.*

Roadside Emergencies

To Connect the Booster Cables

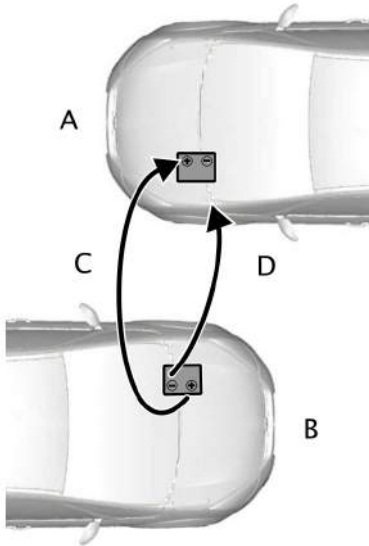

E102925

- A Vehicle with low charge battery
- B Booster battery vehicle
- C Positive connection cable
- D Negative connection cable

1. Position the vehicles so that they do not touch one another.
2. Switch off the engine and any electrical equipment.
3. Connect the positive (+) terminal of vehicle B with the positive (+) terminal of vehicle A (cable C).



E102923

4. Connect the negative (-) terminal of vehicle B to the ground connection of vehicle A (cable D).

WARNINGS



Do not connect directly to the negative (-) terminal of the battery with low charge.



Make sure that the cables are clear of any moving parts and fuel delivery system parts.

To Start the Engine

1. Run the engine of vehicle B at a moderately high speed.
2. Start the engine of vehicle A.
3. Run both vehicles for a minimum of three minutes before disconnecting the cables.

WARNING



Do not switch on the headlamps when disconnecting the cables. The peak voltage could blow the bulbs.

Disconnect the cables in the reverse order.

Fuses

FUSE BOX LOCATIONS

Engine Compartment Fuse Box

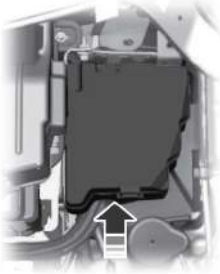

E146269

This fuse box is located in the engine compartment.

Passenger Compartment Fuse Box



E159184

This fuse box is located behind the glove box. To access the fuse box, do the following:

1. Open the glove box and empty the contents.
2. Remove the four screws and then remove the shelf in the glove box.
3. Remove the side cover.
4. Remove the glove box assembly.

Note: Any improper modification to the electrical system can compromise the safety of the vehicle, implying risk of fire or engine damage. For any clarifications or questions, contact a Ford Distributor.

Battery Fuse Box



E146270

This fuse box is attached to the battery positive terminal.

Fuses

FUSE SPECIFICATION CHART

Engine Compartment Fuse Box

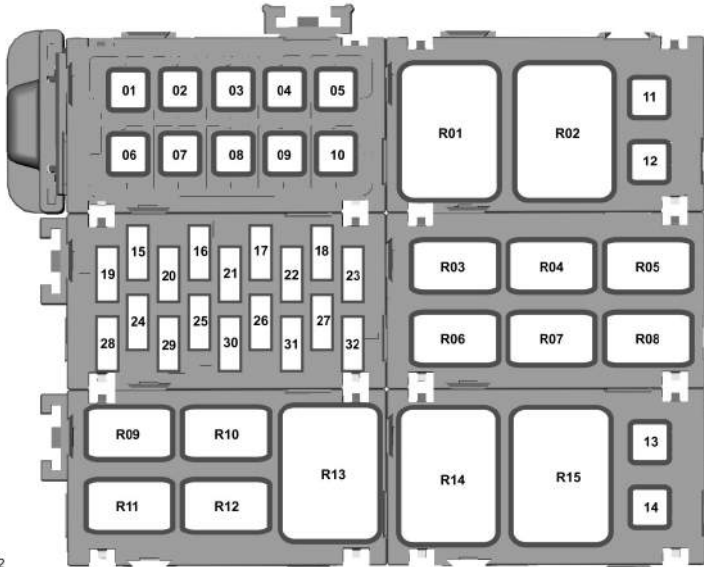

E167752

Fuse	Fuse rating	Circuits protected
1	60 A	Engine compartment fuse box supply: 15, 16, 17, 18, 24, 25, 26 and 27
2	40 A	Anti-lock braking system
3	60 A	Engine compartment fuse box supply: 19, 20, 21, 22 and 23 Powertrain control module relay
4	40 A	Heater fan and blower
5	60 A	Passenger compartment fuse box supply: 10, 11, 12, 13, 14, 15, 16, 17, 18, 31 and 32
6	30 A	Power door locks Alarm horn

Fuses

Fuse	Fuse rating	Circuits protected
7	60 A	Ignition relay Passenger compartment fuse box supply: 1, 2, 3, 4, 5, 6, 7, 8, 9, 34 and 35
8	30 A	Starter motor
9	60 A	High-speed cooling fan Fuse box in the engine compartment: 13
10	30 A	Automatic transmission control module
10	60 A	Glow plug Heater front windows
10	40 A	Low-speed cooling fan (1.0L EcoBoost)
11	30 A	Left heater front windows
12	30 A	Right heater front windows
13	30 A	Low-speed cooling fan (1.5L Duratec-16V Ti-VCT and 1.5L Duratorq-TDCi)
14	30 A	Automatic transmission
15	15 A	Battery saver Front fog lamps Headlamp high beam Interior lights Low beam right-hand side Passenger airbag deactivation warning lamp
16	15 A	Low beam left-hand side Position lamp Rear fog lamp Daytime running lamps
17	15 A	Headlamp high beam
18	20 A	Horn
19	20 A	Electronic pump
20	7.5 A	Automatic transmission control module Powertrain control module
21	20 A	Fuel pump and injectors relay
22	15 A	Front fog lamps

Fuses

Fuse	Fuse rating	Circuits protected
		Headlamp high beam Interior lights Direction indicators Heated windshield
23	10 A	Battery backup sounder and alarm
23	15 A	Horn relay
24	20 A	Heated rear window and heated exterior mirrors
25	7.5 A	Air conditioning relay
25	10 A	Air conditioning relay (1.0L EcoBoost)
26	20 A	Anti-lock braking system with electronic stability system
27	15 A	Front fog lamp
28	10 A	Water pump (1.0L EcoBoost)
29	15 A	Ignition coil
29	20 A	Ignition coil (1.0L EcoBoost)
30	15 A	Low- and high-speed cooling fan relay Powertrain control module Purge valve
31	15 A	Cold start valve Heated oxygen sensors
31	20 A	Powertrain control module (1.5L Duratorq-TDCi)
32	-	Not used

Relay	Circuits switched
R1	High-speed cooling fan
R2	Heated windshield
R3	Fog lamp
R4	Fuel pump (1.5L Duratorq-TDCi)

Fuses

Relay	Circuits switched
R5	Reversing lamp (automatic transmission only)
R6	Headlamp high beam
R7	Air conditioning
R8	Horn
R9	Low-speed cooling fan
R10	Starter motor
R11	Fuel pump (1.0L EcoBoost and 1.5L Duratec-16V Ti-VCT) Fuel heater (1.5L Duratorq-TDCI)
R12	Heater fan and blower
R13	Powertrain control module
R14	Engine block heater
R15	Engine block heater

Fuses

Passenger Compartment Fuse Box



E144835

Fuse	Fuse rating	Circuits protected
1	7.5 A	Air conditioning clutch Rain sensor Interior mirror
2	10 A	Brake lamps
3	7.5 A	Reversing lamp
4	7.5 A	Headlamp leveling
5	20 A	Windshield wipers
6	15 A	Rear window wiper
7	15 A	Washer pump
8	15 A	Driver heated seat
9	15 A	Passenger heated seat

Fuses

Fuse	Fuse rating	Circuits protected
10	15 A	Ignition switch or keyless ignition relay Keyless accessory relay
11	3 A	Instrument cluster
12	15 A	Data link connector
13	7.5 A	Heating control head (manual A/C) Electronic automatic temperature control Alarm sensor Receiver remote (vehicles with keyless system) Integrated control panel Information and entertainment display
14	15 A	Audio SYNC GPS module for Emergency Assistance
15	3 A	Power exterior mirrors Power windows
16	20 A	Keyless vehicle module
17	20 A	Keyless vehicle module
18	-	Not used
19	7.5 A	Instrument cluster
20	-	Not used
21	3 A	Passenger airbag deactivation warning lamp
22	7.5 A	Heated mirrors
23	-	Not used
24	-	Not used
25	7.5 A	Air conditioning control module Heater blower relay Front fog lamp relay Engine block heater
26	3 A	Airbag control module
27	10 A	Parking aid Body control module (ignition) Passive anti-theft system (for vehicles without keyless system)

Fuses

Fuse	Fuse rating	Circuits protected
		Anti-lock brake system Ignition (for vehicles without keyless system) Cluster (ignition) Electrical power assist steering (ignition) Washer pump
28	7.5 A	Accelerator pedal, fuel pump Powertrain control module (ignition) Automatic transmission module
29	-	Not used
30	-	Not used
31	20 A	Cigar lighter and front power point
32	20 A	Rear power point
33	-	Not used
34	30 A	Power driver and passenger windows
35	30 A	Power rear windows
36	-	Not used

Relay	Circuits switched
R1	Ignition
R2	Keyless system ignition
R3	Keyless system accessory

Fuses

Battery Fuse Box

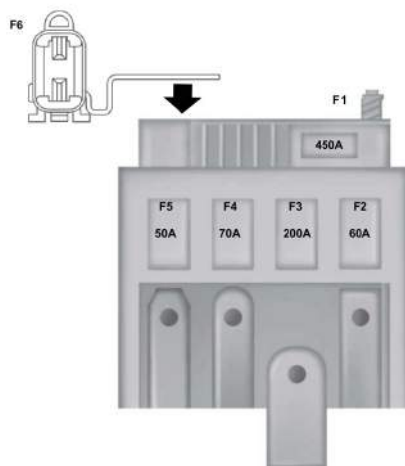

E163706

Fuse	Fuse rating	Circuits protected
1	450 A	Starter
2	60 A	Electric power assist steering
3	200 A	Engine junction box
4	70 A	Engine block heater
5	50 A	Engine block heater
6	3 A	Battery monitor system

Fuses

CHANGING A FUSE

WARNINGS



Do not modify the electrical system of your vehicle in any way. Have repairs to the electrical system and the replacement of relays and high current fuses carried out by an authorized dealer.



Switch the ignition and all electrical equipment off before attempting to change a fuse.



Always replace a fuse with one that has the specified amperage rating. Using a fuse with a higher amperage rating can cause severe wire damage and could start a fire.

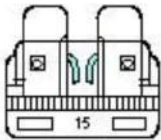

E142430

If electrical components in your vehicle are not working, a fuse may have blown. A break in the fuse wire will indicate a blown fuse. Check the appropriate fuses before replacing any electrical components.

Maintenance

GENERAL INFORMATION

Have your vehicle serviced regularly to help maintain its roadworthiness and resale value. There is a large network of Ford authorized repairers that are there to help you with their professional servicing expertise. Authorized repairers are best qualified to service your vehicle properly and expertly, with a wide range of highly specialized tools.

In addition to regular servicing, we recommend that you carry out the following checks.

WARNINGS



Switch the ignition off before touching or attempting adjustment of any kind.



Do not touch the electronic ignition system parts after you have switched the ignition on or when the engine is running. The system operates at high voltage.



Keep your hands and clothing clear of the engine cooling fan. Under certain conditions, the fan may continue to run for several minutes after you have switched the engine off.



Make sure that you fit filler caps securely after carrying out maintenance checks.

Daily Checks

- Exterior lamps.
- Interior lamps.
- Warning lamps and indicators.

Check When Refueling

- Engine oil level. See **Engine Oil Check** (page 132).
- Brake fluid level. See **Brake and Clutch Fluid Check** (page 134).

- Washer fluid level. See **Washer Fluid Check** (page 135).
- Tire pressures (when cold). See **Technical Specifications** (page 157).
- Tire condition. See **Wheels and Tires** (page 149).

Monthly Checks

- Engine coolant level (engine cold). See **Engine Coolant Check** (page 134).
- Pipes, hoses and reservoirs for leaks.
- Air conditioning operation.
- Parking brake operation.
- Horn operation.
- Tightness of lug nuts. See **Technical Specifications** (page 157).

OPENING AND CLOSING THE HOOD

Opening the Hood



E102165

Maintenance



E154746

Move the catch to the right.

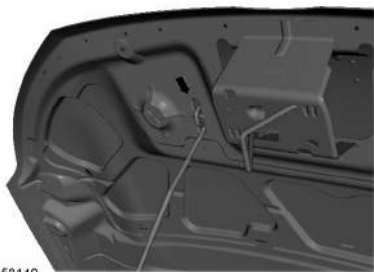

E158140

Open the hood and support it with the hood prop rod. Attach the prop rod to the hood, the correct location is indicated by an arrow.

Closing the Hood

Note: *You must secure the hood prop correctly after use.*

Note: *Make sure that the hood is closed properly.*

Lower the hood and allow it to drop from under its own weight for the last 20-30 centimeters.

Maintenance

UNDER HOOD OVERVIEW - 1.0L ECOBOOST™

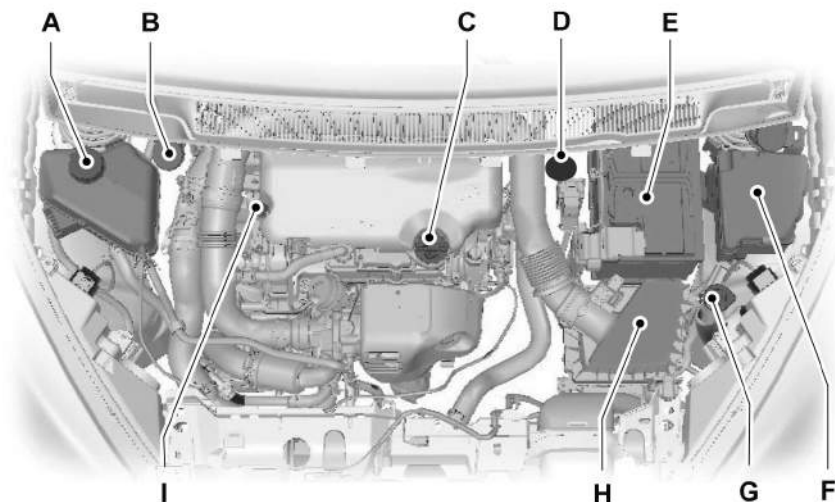

E151694

- A Engine coolant reservoir*: See **Engine Coolant Check** (page 134).
- B Brake and clutch fluid reservoir (right-hand drive)*: See **Brake and Clutch Fluid Check** (page 134).
- C Engine oil filler cap*: See **Engine Oil Check** (page 132).
- D Brake and clutch fluid reservoir (left-hand drive)*: See **Brake and Clutch Fluid Check** (page 134).
- E Battery: See **Changing the 12V Battery** (page 135).
- F Engine compartment fuse box. See **Fuses** (page 117).
- G Windshield and rear window washer fluid reservoir: See **Washer Fluid Check** (page 135).
- H Air cleaner: No maintenance necessary.
- I Engine oil dipstick*: See **Engine Oil Check** (page 132).

* The filler caps and the engine oil dipstick are colored for easy identification.

Maintenance

UNDER HOOD OVERVIEW - 1.5L DURATEC-16V TI-VCT (81KW/110PS) - SIGMA

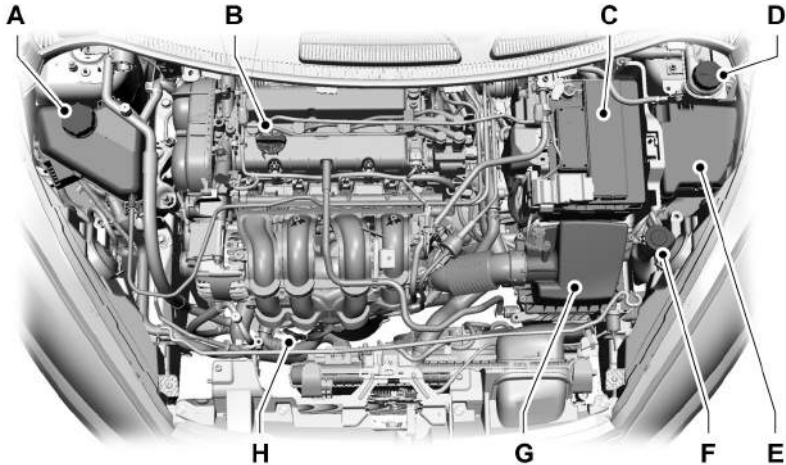

E161500

- A Engine coolant reservoir*: See **Engine Coolant Check** (page 134).
- B Engine oil filler cap*: See **Engine Oil Check** (page 132).
- C Battery: See **Changing the 12V Battery** (page 135).
- D Brake and clutch fluid reservoir (left-hand drive)*: See **Brake and Clutch Fluid Check** (page 134).
- E Engine compartment fuse box. See **Fuses** (page 117).
- F Windshield and rear window washer fluid reservoir: See **Washer Fluid Check** (page 135).
- G Air cleaner: No maintenance necessary.
- H Engine oil dipstick*: See **Engine Oil Check** (page 132).

* The filler caps and the engine oil dipstick are colored for easy identification.

Maintenance

UNDER HOOD OVERVIEW - 1.5L DURATORQ-TDCI (67KW/91PS)

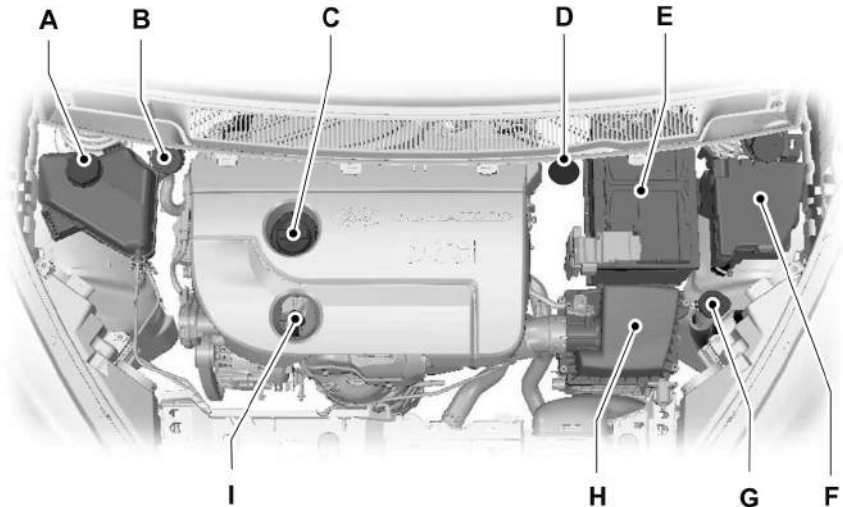

E151697

- A Engine coolant reservoir*: See **Engine Coolant Check** (page 134).
- B Brake and clutch fluid reservoir (right-hand drive)*: See **Brake and Clutch Fluid Check** (page 134).
- C Engine oil filler cap*: See **Engine Oil Check** (page 132).
- D Brake and clutch fluid reservoir (left-hand drive)*: See **Brake and Clutch Fluid Check** (page 134).
- E Battery: See **Changing the 12V Battery** (page 135).
- F Engine compartment fuse box. See **Fuses** (page 117).
- G Windshield and rear window washer fluid reservoir: See **Washer Fluid Check** (page 135).
- H Air cleaner: No maintenance necessary.
- I Engine oil dipstick*: See **Engine Oil Check** (page 132).

* The filler caps and the engine oil dipstick are colored for easy identification.

Maintenance

ENGINE OIL DIPSTICK - 1.0L ECOBOOST™

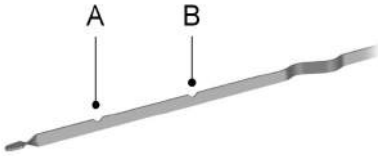

E141337

- A Minimum
- B Maximum

ENGINE OIL DIPSTICK - 1.5L DURATEC-16V TI-VCT (81KW/110PS) - SIGMA

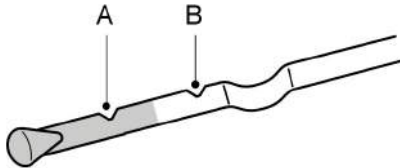

E95540

- A Minimum
- B Maximum

ENGINE OIL DIPSTICK - 1.5L DURATORQ-TDCI (67KW/91PS)

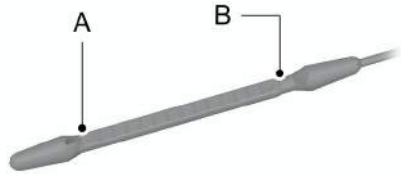



E140423

- A Minimum
- B Maximum

ENGINE OIL CHECK

WARNINGS

-  Do not use oil additives or other engine treatments. Under certain conditions, they could damage the engine and it is not covered under warranty.
-  Empty engine oil containers should not be disposed of in domestic trash bins. Use only proper containers to dispose of this type of waste.
-  When changing your oil, ensure that the oil used is the same as specified and the correct amount. Do not use unknown types of oil or from already opened containers.

Note: The oil consumption of new engines reaches its normal level after approximately 5000 kilometers.

Checking the Oil Level

Note: Check the level before starting the engine.

Maintenance

Note: Make sure that the level is between the MIN and the MAX marks.

Note: Level measurement will not be accurate if this procedure is not followed.

1. Make sure that your vehicle is on level ground.
2. If the engine is running turn it off and wait 15 minutes for the oil to drain into the oil pan.
3. Remove the dipstick and wipe it with a clean, lint free cloth. Replace the dipstick and remove it again to check the oil level.

If the level is at the MIN mark, top up immediately.

Topping Up

WARNINGS



Only top up when the engine is cold. If the engine is hot, wait 15 minutes for the engine to cool down.



Do not remove the filler cap when the engine is running.

Remove the filler cap.

WARNING



Do not top up further than the MAX mark.

Note: Oil expands when it is hot. Checking the oil level when hot will be above the MAX mark.

Note: Soak up any spillage with an absorbent cloth immediately.

Top up with fluid that meets the Ford specification. See **Technical Specifications** (page 160).

Replace the filler cap. Turn it until you feel a strong resistance.

Engine severe usage conditions

In case of vehicle severe usage, engine oil should be changed every 5000 km or 3 months, whichever occurs first.

Severe usage conditions:

- Short distances (less than 5 km), in which the engine does not reach normal operating temperature,
- Frequent usage of vehicle on dusty roads or in mountain areas,
- Usage in heavy urban traffic,
- Usage as driving instructors vehicle, taxi vehicle, ambulance, military usage or similar activities,
- Extended usage with contaminated fuel.

Oil Consumption

In the first 5,000 km (run-in period) the oil consumption is higher, and therefore the oil level should be checked more frequently. O maximum acceptable consumption in this period is one liter. After the break-in period the engine can consume up to one liter every 10,000 km. If the consumption is higher, go to your Ford Dealer.

Oil consumption also depends on driving style and vehicle use. Special operating conditions such as, operating your vehicle frequently at high speeds, could increase oil consumption.

Oil Filter

The oil filter's function is to filter out harmful particles without obstructing the flow of oil to vital parts. Use of oil filters not meeting Ford specifications could damage the engine.

Maintenance

ENGINE COOLANT CHECK

WARNING



Do not allow the fluid to touch your skin or eyes. If this happens, rinse the affected areas immediately with plenty of water and contact your physician.

Note: Make sure that the level is between the MIN and the MAX marks.

Note: Coolant expands when it is hot. The level may therefore extend beyond the MAX mark.

If the level is at the MIN mark, add coolant immediately.

Adding Engine Coolant

WARNINGS



Only add coolant when the engine is cold. If the engine is hot, wait 10 minutes for the engine to cool down.



Do not remove the filler cap when the engine is running.



Do not remove the filler cap when the engine is hot. Wait for the engine to cool down.



Undiluted coolant is flammable and may ignite if spilt on a hot exhaust.

Note: Inspect or replace the lid with the car turned off and the engine cold, to avoid injuries or burns.

Note: In an emergency, you can add just water to the cooling system to reach a vehicle service station. Have the system checked by a Ford Dealer as soon as possible.

Note: Prolonged use of incorrect dilution of the coolant can cause engine damage from corrosion, overheating or freezing.

Note: Do not add coolant further than the MAX mark.

Note: If coolant levels are outside the standard operational range, the performance of the system may be compromised; seek a Ford Dealer immediately.

Note: The cooling system expansion reservoir lid should be inspected and cleaned every 3 years approximately. If there are any evidences of deterioration of the sealing ring, the lid should be replaced.

Note: It is normal to see some air bubbles in the coolant reservoir fluid.

1. Remove the filler cap. Any pressure will escape slowly as you unscrew the cap.
2. Add a mixture of 50% coolant and 50% water using fluid that meets the Ford specifications. See **Technical Specifications** (page 143).
3. Replace the filler cap. Turn it until you feel a strong resistance.

BRAKE AND CLUTCH FLUID CHECK

WARNINGS



Use of any fluid other than the recommended brake fluid may reduce brake efficiency and not meet Ford's performance standards.



Do not allow the fluid to touch your skin or eyes. If this happens, rinse the affected areas immediately with plenty of water and contact your doctor.



Clean the filler cap before removing. Use only fluid that meets Ford specifications and from a sealed container.

Maintenance

Note: Keep brake fluid clean and dry. Contamination with dirt, water, petroleum products or other materials may result in brake system damage and possible failure.

Note: The brake and the clutch systems are supplied from the same reservoir.

The fluid level will drop slowly as the brakes wear, and will rise when the brake components are replaced.

Fluid levels between the MIN and MAX lines are within the normal operating range; there is no need to add fluid.

If the fluid levels are outside of the normal operating range, the performance of the system could be compromised; seek service from you authorized dealer immediately.

Top up with fluid that meets the Ford specification. See **Technical Specifications** (page 160).

WASHER FLUID CHECK

Note: The reservoir supplies the front and rear washer systems.

When adding fluid, use a mixture of washer fluid and water to help prevent freezing in cold weather and improve the cleaning capability. We recommend that you use only high quality washer fluid.

For information on fluid dilution, refer to the product instructions.

CHANGING THE 12V BATTERY



Make sure that you dispose of old batteries in an environmentally friendly way. Seek advice from your local authority regarding recycling.

WARNING



You must replace the battery with one of exactly the same specification.

Note: For vehicles with a manual transmission, if the battery goes flat or you install a new battery, the engine will not start until you press and hold the clutch pedal down for two seconds then release the clutch pedal and wait two seconds with the key turned to the on position and the engine is off.

The battery is located in the engine compartment. See **Maintenance** (page 127).

To remove and install the battery:

Note: Do not loosen the powertrain control module from the bracket.

Note: Do not disconnect the powertrain control module from the connector.

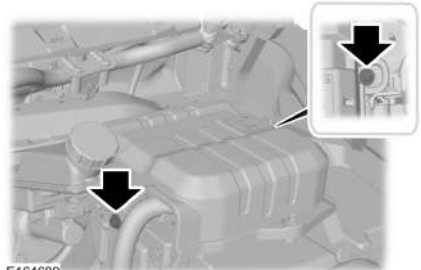

E164689

1. Remove the two screws from the powertrain control module cover.

Maintenance

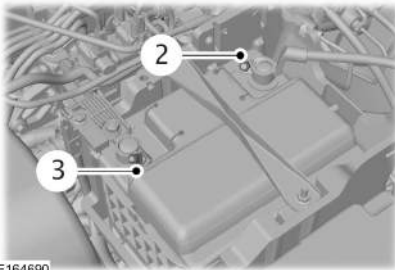

E164690

2. Remove the negative battery cable.
3. Remove the positive battery cable.

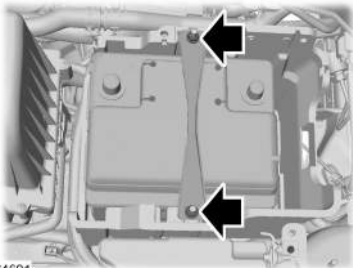

E164691

4. Remove the two nuts from the clamp.
5. Remove the battery.
6. Install in the reverse order.

CHANGING A BULB

WARNINGS



Switch the lights and the ignition off.



Let the bulb cool down before removing it.



Do not touch the glass of the new bulb.

Note: Only fit bulbs of the correct specification.

Note: The following instructions describe how to remove the bulbs. Fit replacements in the reverse order unless otherwise stated.

Headlamp

Note: Disconnect the bulb electrical connectors and remove the covers to gain access to the bulbs.

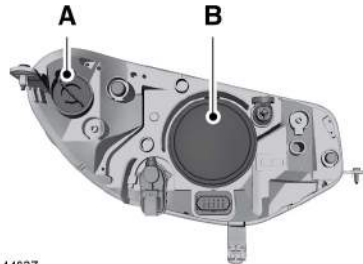

E144837

- A Direction indicator
- B Headlamp main beam

Direction Indicator

1. Open the hood.

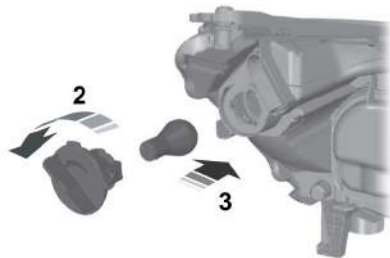

E144838

2. Turn the bulb holder anti-clockwise and remove it.
3. Gently press the bulb into the bulb holder, turn it anti-clockwise and remove it.

Maintenance

Headlamp Main Beam

Note: Do not touch the glass of the bulb.

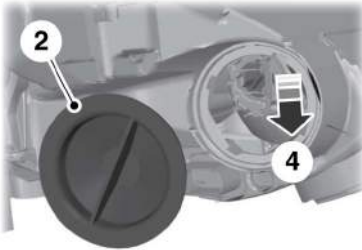

E144839

1. Open the hood.
2. Remove the cover.
3. Disconnect the electrical connector.
4. Release the clip and remove the bulb.

Side Lamp

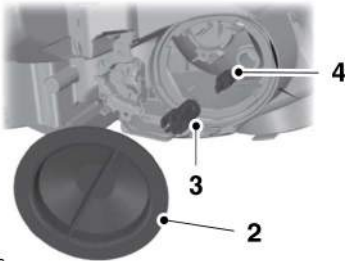

E144840

1. Remove the cover.
2. Remove the bulb holder.
3. Remove the bulb.

Vanity Lamp

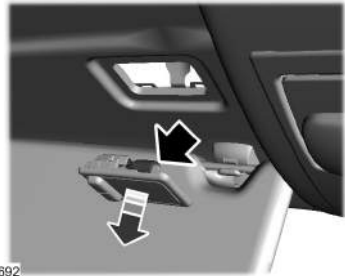

E164692

1. Position the visor in the down position.
2. When removing the vanity lamp, be careful not to damage the roof trim. Using appropriate plastic spatula, insert it between the vanity mirror and the roof trim and release the metal retaining clip.
3. Remove the lamp.
4. Remove the bulb.

Front Fog Lamps

Note: Do not separate the fog lamp bulb from the bulb holder

Maintenance

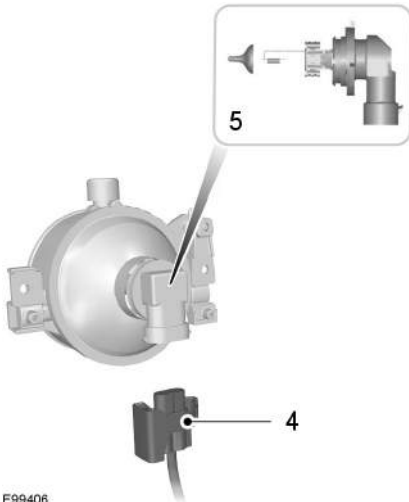

E99406

Note:

1. Disconnect the electrical connector.
2. Turn the bulb holder anti-clockwise.
3. Remove the fog lamp bulb and holder assembly.
4. Connect the electrical connector.
5. Install a new fog lamp assembly.

Rear Lamps

Direction Indicator, Tail and Brake Lamp



E163920

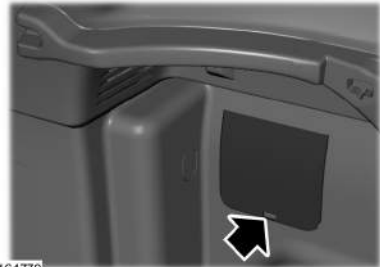

E164779

1. Remove the trim panel.

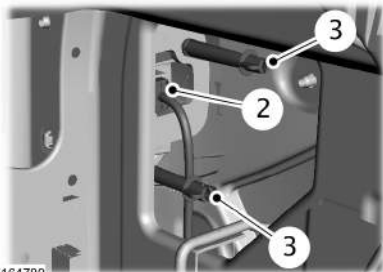

E164780

2. Disconnect the electrical connector.
3. Remove the wing nuts.
4. Remove the lamp.

Maintenance

5. Remove the bulb holder.
6. Gently press the bulb into the bulb holder, turn it anti-clockwise and remove it.

Reversing Lamp and Fog Lamp

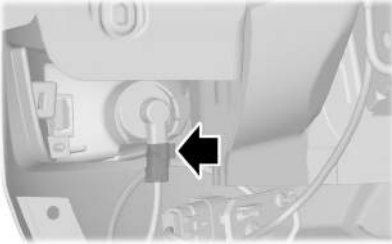

E160639

1. Disconnect the electrical connector.

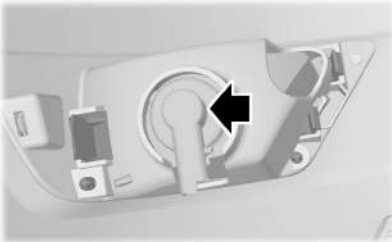

E160638

2. Turn the bulb holder anti-clockwise and remove the bulb holder from the housing.
3. Remove the bulb from the holder.
4. Gently press the new bulb into the bulb holder, install new bulb and holder into the housing, turning it clockwise.

Central High Mounted Brake Lamp

Note: On some vehicles the lamps are LED. They are not serviceable items, please consult a Ford Dealer if they fail.

Number Plate Lamp

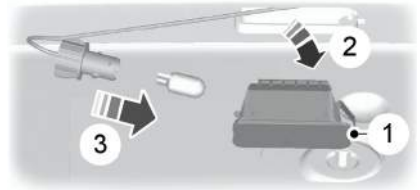

E72789

1. Carefully release the spring clip.
2. Remove the lamp.
3. Turn the bulb anti-clockwise and remove it.

Interior Lamp

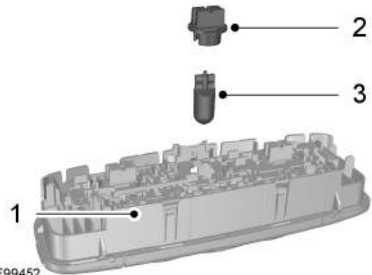

E99452

1. Carefully remove the lamp.
2. Turn the bulb holder counter-clockwise and remove it.
3. Remove the bulb.

Maintenance

Reading Lamps

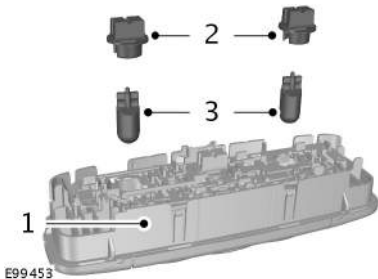

1. Carefully remove the lamp.
2. Turn the bulb holder counterclockwise and remove it.
3. Remove the bulb.

Map Lamp (driver side)

1. Position the visor down.
2. Carefully remove the lamp.
3. Turn the bulb holder counterclockwise and remove it.
4. Remove the bulb.

Luggage Compartment Lamp, Footwell Lamp and Tailgate Lamp (If Equipped)



1. Carefully remove the lamp.
2. Remove the bulb.

CHECKING THE WIPER BLADES



Run the tip of your fingers over the edge of the blade to check for roughness.

Clean the wiper blades with washer fluid or water applied with a soft sponge or cloth.

CHANGING THE WIPER BLADES

Windshield Wiper Blades

Note: *The windshield wiper blades are different in length. If you install wiper blades of the wrong length, the rain sensor may not work correctly.*

Changing the Windshield Wiper Blades

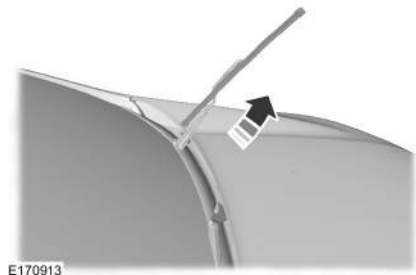

Maintenance

1. Lift the wiper arm up to its service position (close to a 90 degree angle).
2. Firmly hold the wiper arm tip with one hand and disassemble the old wiper blade with your other hand.



E147761

3. To remove the wiper blade, press the plastic adaptor (1) and pull (2) the wiper blade.

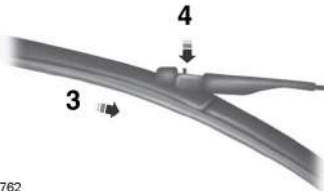

E147762

1. To assemble the wiper blade, slide (3) the new blade onto the wiper arm until you here a snap (4).
2. Lower the wiper arm back to it's working position.

Changing the Rear Window Wiper Blade

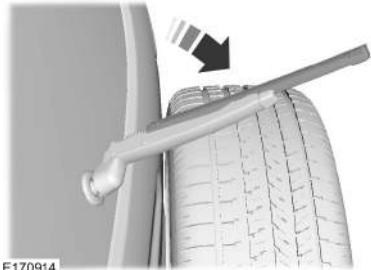

E170914

1. Lift the wiper arm up to its service position (close to a 90 degree angle).
2. Firmly hold the wiper arm tip with one hand and disassemble the old wiper blade with your other hand.



E147761

3. To remove the wiper blade, press the plastic adaptor (1) and pull (2) the wiper blade.

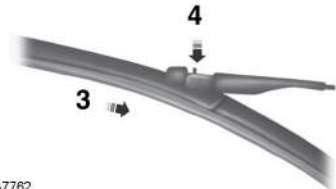

E147762

1. To assemble the wiper blade, slide (3) the new blade onto the wiper arm until you here a snap (4).
2. Lower the wiper arm back to it's working position.

Maintenance

REMOVING A HEADLAMP

1. Open the hood. See **Opening and Closing the Hood** (page 127).

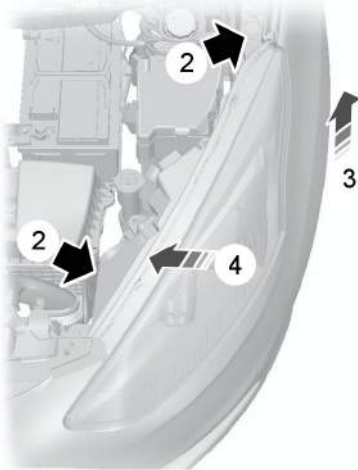

E144433

2. Remove the screws and push pins.

3. Lift the outer side of the headlamp to disengage it from the lower fixing point.
4. Pull the headlamp as far as possible toward the center of your vehicle and remove.

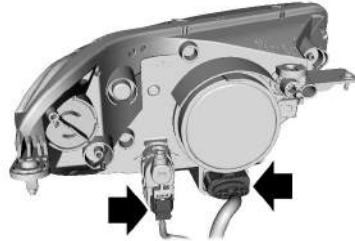

E164963

5. Disconnect the two electrical connectors.

Note: When fitting the headlamp, make sure that you reconnect the electrical connector correctly.

Note: When fitting the headlamp, make sure that you fully engage the headlamp in the lower fixing point.

BULB SPECIFICATION CHART

Lamp	Specification	Power (watt)
Front direction indicator	PY21W	21
Headlamp main beam / dipped beam	H4	55 / 60W
Front fog lamp	H11	55
Side repeater	WY5W	5
Rear direction indicator	PY21W	21
Brake and tail lamp	P21/5W	21/5
Rear fog lamp	P21W	21
Reversing lamp	P21W	21

Maintenance

Lamp	Specification	Power (watt)
Number plate lamp	W5W	5
Luggage compartment lamp	W5W	5
Vanity lamp	W5W	5

Note: *On some vehicles the lamps are LED. These are not serviceable items, please consult your dealer if they fail.*

CHANGING THE ENGINE AIR FILTER

WARNING



To reduce the risk of vehicle damage and/or personal burn injuries do not start your engine with the air cleaner removed and do not remove it while the engine is running.

Note: *Failure to use the correct air filter element may result in severe engine damage.*

Changing the Air Filter Element

1. Remove the four screws that secure the air filter housing cover.
2. Carefully separate the two halves of the air filter housing.
3. Remove the air filter element from the air filter housing.
4. Wipe the air filter housing and cover clean to remove any dirt or debris and to ensure good sealing.
5. Install a new air filter element. Be careful not to crimp the filter element edges between the air filter housing and cover. This could cause filter damage and allow unfiltered air to enter the engine if not properly seated.
6. Replace the air filter housing cover and install the screws.

TECHNICAL SPECIFICATIONS - 1.0L ECOBOOST (90KW/120PS)

Capacities

Item	Capacity in gallons (liters)
Engine cooling system	1.4 (6.3)
Engine lubrication system - including the oil filter	0.9 (4.1)
Engine lubrication system - excluding the oil filter	0.9 (4)
Engine oil top-up - raise the level on the dipstick from minimum to maximum	0.2 (0.8)
Fuel tank	10.6 (48)
Windshield and rear window washer system - including headlamp washer	0.6 (2.7)

Maintenance

Specifications

Materials

Name	Specification
Engine Oil - 5W-20	WSS-M2C948-B
Transmission Oil - 75W-90 BO 97SX-M2C200-AA/BB/CB	WSD-M2C200-C
Transmission Oil - 75W FE 7U7J-M2C200-BA/CA	WSS-M2C200-D2
Brake Fluid DOT 4 LV High Performance BU7J-M6C65-xxxx	WSS-M6C65-A2
Antifreeze Super Plus Premium 4U7J-19544-xxxx	WSS-M97B44-D

Use oil and fluids that meet the defined specification and viscosity grades.

If you use oil and fluids that do not meet the defined specification and viscosity grades this may lead to:

- Component damage which may not be covered by the vehicle Warranty.
- Longer engine cranking periods.
- Increased emission levels.

- Reduced engine performance.
- Reduced fuel economy.



We recommend that you use Castrol or Ford engine oil.

TECHNICAL SPECIFICATIONS - 1.5L DURATEC-16V TI-VCT (81KW/110PS) - SIGMA

Capacities

Item	Capacity in gallons (liters)
Engine cooling system	1.2 (5.5)
Engine lubrication system - including the oil filter	0.9 (4.1)
Engine lubrication system - excluding the oil filter	0.8 (3.8)
Engine oil top-up - raise the level on the dipstick from minimum to maximum	0.2 (0.8)
Fuel tank	10.6 (48)
Windshield and rear window washer system - including headlamp washer	0.6 (2.7)

Maintenance

Specifications

Materials

Name	Specification
Engine Oil - 5W-20	WSS-M2C948-B
Transmission Oil - 75W-90 BO 97SX-M2C200-AA/BB/CB	WSD-M2C200-C
Transmission Oil - 75W FE 7U7J-M2C200-BA/CA	WSS-M2C200-D2
Brake Fluid DOT 4 LV High Performance BU7J-M6C65-xxxx	WSS-M6C65-A2
Antifreeze Super Plus Premium 4U7J-19544-xxxx	WSS-M97B44-D

Use oil and fluids that meet the defined specification and viscosity grades.

If you use oil and fluids that do not meet the defined specification and viscosity grades this may lead to:

- Component damage which may not be covered by the vehicle Warranty.
- Longer engine cranking periods.
- Increased emission levels.

- Reduced engine performance.
- Reduced fuel economy.



We recommend that you use Castrol or Ford engine oil.

TECHNICAL SPECIFICATIONS - 1.5L DURATORQ-TDCI (67KW/91PS)

Capacities

Item	Capacity in gallons (liters)
Engine cooling system	1.3 (6)
Engine lubrication system - including the oil filter	0.8 (3.8)
Engine lubrication system - excluding the oil filter	0.8 (3.4)
Engine oil top-up - raise the level on the dipstick from minimum to maximum	0.4 (1.6)
Fuel tank	10.3 (47)
Windshield and rear window washer system - including headlamp washer	0.6 (2.7)

Maintenance

Specifications

Materials

Name	Specification
Engine Oil - 5W-30	WSS-M2C913-C
Transmission Oil - 75W-90 BO 97SX-M2C200-AA/BB/CB	WSD-M2C200-C
Transmission Oil - 75W FE 7U7J-M2C200-BA/CA	WSS-M2C200-D2
Brake Fluid DOT 4 LV High Performance BU7J-M6C65-xxxx	WSS-M6C65-A2
Antifreeze Super Plus Premium 4U7J-19544-xxxx	WSS-M97B44-D

Use oil and fluids that meet the defined specification and viscosity grades.

If you use oil and fluids that do not meet the defined specification and viscosity grades this may lead to:

- Component damage which may not be covered by the vehicle Warranty.
- Longer engine cranking periods.
- Increased emission levels.
- Reduced engine performance.
- Reduced fuel economy.







We recommend that you use Castrol or Ford engine oil.

Vehicle Care

CLEANING THE EXTERIOR



WARNINGS

-  If you use a car wash with a waxing cycle, make sure that you remove the wax from the windshield.
-  Prior to using a car wash facility check the suitability of it for your vehicle.
-  Some car wash installations use water at high pressure. This could damage certain parts of your vehicle.
-  Remove the aerial before using an automatic car wash.
-  Switch the heater blower off to prevent contamination of the fresh air filter.

We recommend that you wash your vehicle with a sponge and lukewarm water containing a car shampoo.

Cleaning the Headlamps

WARNINGS

-  Do not scrape the headlamp lenses or use abrasives, alcoholic solvents or chemical solvents to clean them.
-  Do not wipe the headlamps when they are dry.

Cleaning the Rear Window



WARNING

-  Do not scrape the inside of the rear window or use abrasives or chemical solvents to clean it.

Use a clean, lint free cloth or a damp chamois leather to clean the inside of the rear window.



Cleaning the Chrome Trim

WARNINGS

-  Do not use abrasives or chemical solvents. Use soapy water.
-  Do not apply cleaning product to hot surfaces and do not leave cleaning product on chrome surfaces for a period of time exceeding that which is recommended.
-  Industrial-strength (heavy-duty) cleaners, or cleaning chemicals, may cause damage over a period of time.

Body Paintwork Preservation

WARNINGS

-  Do not polish your vehicle in strong sunshine.
-  Do not allow polish to touch plastic surfaces. It could be difficult to remove.
-  Do not apply polish to the windshield or rear window. This could cause the wipers to become noisy and they may not clear the window properly.

We recommend that you wax the paintwork once or twice a year.

CLEANING THE INTERIOR

Note: Do not allow air fresheners and hand sanitizers to spill on interior surfaces. If a spill occurs, wipe off immediately. Damage may not be covered by your warranty.

Safety Belts

WARNINGS

-  Do not use abrasives, or chemical solvents to clean them.

Vehicle Care

WARNINGS



Do not allow moisture to penetrate the safety belt retractor mechanism.

Clean them with interior cleaner or water applied with a soft sponge. Let them dry naturally, away from artificial heat.

Instrument Cluster Screens, LCD Screens and Radio Screens

WARNING



Do not use abrasives, alcoholic solvents or chemical solvents to clean them.

Rear Windows

WARNING



Do not use any abrasive materials to clean the interior of the rear windows.

Note: Do not install stickers or labels to the interior of the rear windows.

REPAIRING MINOR PAINT DAMAGE

You should repair paintwork damage caused by stones from the road or minor scratches as soon as possible. A choice of products are available from an authorized dealer.

Remove particles such as bird droppings, tree sap, insect deposits, tar spots, road salt and industrial fallout before repairing paint chips.

Always read and follow the manufacturer's instructions before using the products.

CLEANING THE ALLOY WHEELS

Note: Do not apply a cleaning chemical to warm or hot wheel rims and covers.

Note: Industrial-strength (heavy-duty) cleaners, or cleaning chemicals, in combination with brush agitation to remove brake dust and dirt, could wear away the clear coat finish over a period of time.

Note: Do not use hydrofluoric acid-based or high caustic-based wheel cleaners, steel wool, fuels or strong household detergent.

Note: If you intend parking your vehicle for an extended period after cleaning the wheels with a wheel cleaner, drive your vehicle for a few minutes before doing so. This will reduce the risk of increased corrosion of the brake discs, brake pads and linings.

Note: Some automatic car washes may cause damage to the finish on your wheel rims and covers.

Alloy wheels and wheel covers are coated with a clear coat paint finish. To maintain their condition we recommend that you:

- Clean them weekly with the recommended wheel and tire cleaner.
- Use a sponge to remove heavy deposits of dirt and brake dust accumulation.
- Rinse them thoroughly with a pressurized stream of water when you have completed the cleaning process.

We recommend that you use Ford service wheel cleaner. Make sure that you read and follow the manufacturer's instructions.

Using other non-recommended cleaning products can result in severe and permanent cosmetic damage.

Wheels and Tires

GENERAL INFORMATION

A decal with tire pressure data is located in the driver's door opening.

Check and set the tire pressure at the ambient temperature in which you are intending to drive your vehicle and when the tires are cold.

Note: Check your tire pressures regularly to optimize fuel economy.

Note: Use only approved wheel and tire sizes. Using other sizes could damage your vehicle and will make the National Type Approval invalid.

Note: If you change the diameter of the tires from that fitted at the factory, the speedometer may not display the correct speed. Take your vehicle to an authorized dealer to have the engine management system reprogrammed.

Note: If you intend to change the size of the wheels from that fitted at the factory, check the suitability with an authorized dealer.

TIRE CARE



E70415

To make sure the front and rear tires of your vehicle wear evenly and last longer, we recommend that you swap the tires from front to rear and vice versa at regular intervals of between 3000 and 6000 miles (5000 and 10000 kilometers).

WARNING



Do not scrub the sidewalls of the tires when you are parking.

If you have to mount a curb, do so slowly and approach it with the wheels at right-angles to the curb.

Examine the tires regularly for cuts, foreign objects and uneven wear of the tread. Uneven wear could mean that the wheel alignment is outside specification.

Check the tire pressures (including the spare) when cold, every two weeks.

USING WINTER TIRES

WARNING



When you use winter tires on your vehicle, you must make sure that you use the correct lug nuts.

If winter tires are used, you must make sure that you use the correct tire pressures. See **Technical Specifications** (page 157).

USING SNOW CHAINS

WARNINGS



Do not exceed 30 mph (50 km/h).



Do not use snow chains on snow-free roads.



Only fit snow chains to specified tires. See **Technical Specifications** (page 157).



If your vehicle has wheel trims, remove them before fitting snow chains.

Only use snow chains of 10 millimeters or smaller.

Wheels and Tires

Only use snow chains on the front wheels.

Note: *The anti-lock braking system will continue to operate normally.*

Vehicles with Stability Control

When stability control is on, your vehicle may exhibit some unusual driving characteristics. To reduce this, switch traction control off. See **Using Stability Control** (page 104).

TIRE PRESSURE MONITORING SYSTEM

WARNING



The tire pressure monitoring system is not a substitute for manually checking tire pressures. The tire pressure should be checked periodically using a tire gauge, see **When Inflating the Tires** in this chapter. Failure to correctly maintain tire pressures could increase the risk of tire failure, loss of control, vehicle rollover and personal injury.



You must check the tire pressures (including the spare tire where applicable) every two weeks when the tires are cold. Tires must be inflated to the correct pressure. See **Wheels and Tires** (page 149). The tire pressures are also on the tire inflation pressure label (located on the edge of driver door or the B-Pillar).

As a driver assistance feature, your vehicle has a tire pressure monitoring system. A warning lamp will illuminate when one or more of the tires are significantly under-inflated. If the low tire pressure warning lamp illuminates, you should stop your vehicle as soon as it is safe to do so, check the tires and inflate them to the correct pressure.

Driving on under-inflated tires can:

- Cause them to overheat.
- Lead to tire failure.
- Reduce fuel efficiency.
- Reduce tire life.
- Affect vehicle handling or stopping ability.

The system is not a substitute for correct tire maintenance. Correct tire pressures must be maintained, even if under-inflation has not illuminated the warning lamp.

Your vehicle has a system malfunction indicator to indicate when the system is not operating correctly. The malfunction indicator and low tire pressure warning lamp are combined. When the system detects a malfunction, the warning lamp will flash for approximately one minute and then remain illuminated. This sequence will occur every time you switch the ignition on while the malfunction remains. Have your vehicle checked by an authorized dealer as soon as possible.

When the malfunction indicator is illuminated, the system may not be able to detect or signal low tire pressures. A malfunction may occur for a variety of reasons, including the installation of a replacement tire or wheel that prevents the system from functioning correctly. Always check the tire pressure monitoring system malfunction warning after replacing one or more tires or wheels on your vehicle. Make sure the replacement tires or wheels allow the system to continue to function correctly.

Wheels and Tires

Changing Tires With a Tire Pressure Monitoring System



E142549

Note: Each road wheel and tire is equipped with a tire pressure sensor located inside the wheel and tire assembly cavity. The pressure sensor is attached to the valve stem. The pressure sensor is covered by the tire and is not visible unless the tire is removed. Take care when changing the tire to avoid damaging the sensor. Failure to correctly maintain tire pressures could increase the risk of tire failure, loss of control, vehicle rollover and personal injury.

You should always have tires serviced by an authorized dealer.

Understanding the Tire Pressure Monitoring System

The system measures the pressure in the four road tires and sends the tire pressure readings to your vehicle. The low tire pressure warning lamp will illuminate if any of the tire pressures are significantly low. If the warning lamp is on you must inflate one or more of the tires to the correct pressure.

When the Spare Tire is Installed

If a road wheel and tire needs to be replaced with the spare wheel, the system will continue to identify a defect. You must reset the system to make sure the sensor in the spare wheel works correctly.

For additional information, see **Tire Pressure Monitoring System Reset Procedure** in this section.

When You Believe the System is Not Operating Correctly

The main function of the system is to warn you when the tire pressures are low. It can also warn you in the event the system is no longer capable of operating correctly. See the following chart for information concerning the system:

Wheels and Tires

Low tire pressure warning lamp	Possible cause	Action required
Solid warning lamp	Tire(s) under-inflated	1. Make sure tires are at the correct pressure. See When Inflating the Tires in this chapter. 2. After inflating the tires to the correct pressure. See Wheels and Tires (page 149). The tire pressures are also on the tire inflation pressure label (located on the edge of driver door or the B-Pillar).
	Spare tire in use	You must reset the system to make sure the sensor in the spare wheel works correctly. See Tire Pressure Monitoring System Reset Procedure in this section.
	Tire pressure monitoring system malfunction	If the tires are correctly inflated and the spare tire is not in use but the light remains on, have your vehicle checked by an authorized dealer as soon as possible.
Flashing warning lamp	Spare tire in use	You must reset the system to make sure the sensor in the spare wheel works correctly. See Tire Pressure Monitoring System Reset Procedure in this section.
	Tire pressure monitoring system malfunction	If the tires are correctly inflated and the spare tire is not in use but the light remains on, have your vehicle checked by an authorized dealer as soon as possible.

Tire Pressure Monitoring System Reset Procedure

Overview

The system reset procedure must be carried out after each tire replacement or adjustment of the tire pressures.

To maintain your vehicle load carrying capability, your vehicle requires different tire pressures in the front tires compared to the rear tires. The system on your vehicle is designed to illuminate the warning lamp at different pressures for the front and rear tires.

Wheels and Tires

The tires need to be periodically rotated to provide consistent performance and maximum tire life, the system needs to know when the tires have been rotated to determine which set of tires are on the front and rear axles. With this information, the system can detect and correctly warn of low tire pressures.

Carrying Out the System Reset Procedure

1. Switch the ignition on.
2. Using the information display control, navigate to **Menu, Vehicle settings, Driver assist, Tyre Monitor**.
3. Press and hold the **OK** button until confirmation appears.

Alternatively, if your vehicle has a tire pressure monitoring system reset button, press and hold the button until confirmation appears.

How Temperature Affects the Tire Pressures

While driving in a normal manner, tire pressures may increase up to 0.3 bar (4 psi) from a cold start situation. If the vehicle is stationary overnight and the temperature significantly lower than the daytime temperature, tire pressures may decrease up to 0.2 bar (3 psi) for a drop of 17°C (30°F) in ambient temperature. This lower pressure value will be detected by the system as being significantly lower than the correct inflation pressure and the warning lamp will illuminate.

When Inflating the Tires

When inflating the tires the system may not respond immediately to the air added to the tires.

If the Warning Lamp Is On:

1. Check each tire to verify that none are flat.

2. If one or more tires are flat, repair as necessary.
3. Check the tire pressures and inflate all the tires to the correct pressure.
4. Carry out the tire pressure monitoring system reset procedure.

CHANGING A ROAD WHEEL

Vehicles With a Spare Wheel

If the spare wheel is the same type and size as your vehicle road wheel, you can fit the spare wheel and continue to drive in the normal manner.

If the spare wheel is not the same type and size as your vehicle road wheel, it will have a label showing the maximum speed limit.

See the following information before changing the wheel.

WARNINGS



Drive the shortest possible distances.



Do not fit more than one spare wheel on your vehicle at any one time.



Do not carry out any tire repairs on a spare wheel.



Do not drive through an automatic car wash.



If you are not sure what type of spare wheel you have, do not exceed 50 mph (80 km/h).



The ground clearance of your vehicle may be reduced. Take care when parking next to a curb.

Note: *Your vehicle may exhibit some unusual driving characteristics.*

Wheels and Tires

Scissor Lift Hoist

WARNING

- ⚠ Use a suitable rubber block while lifting the vehicle on a scissor lift to avoid damage to the fuel tank or vehicle.

Vehicle Jack

WARNINGS

- ⚠ Only use the vehicle jack supplied with your vehicle when changing a wheel in an emergency.
- ⚠ The vehicle jack must not be damaged or deformed and the thread lubricated and free from foreign material.
- ⚠ Never place anything between the vehicle jack and the ground.
- ⚠ Never place anything between the vehicle jack and your vehicle.
- ⚠ Make sure that the vehicle jack is vertical to the jacking point and the base is flat on the ground.
- ⚠ Do not work on your vehicle when the jack is the only support. If the vehicle slips off the jack, you or someone else could be seriously injured.

Jack and Associated Tools

Your vehicle's jack, wheel brace, recovery hook, warning triangle and locking wheel nut key are located in the luggage compartment under the floor cover, in a tool kit.

Jacking and Lifting Points

WARNING

- ⚠ You must use the specified jacking points.

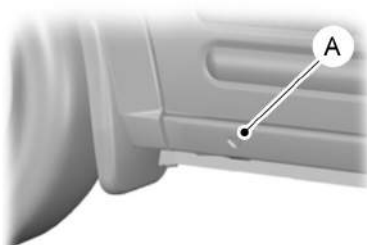

E93302

- A Small arrow-shaped marks on the sills show the location of the jacking points.

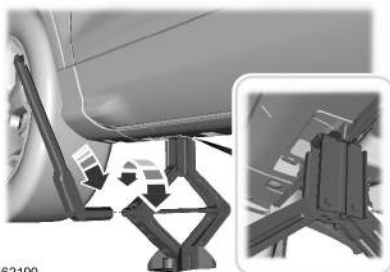

E 162190

Removing a Road Wheel

WARNINGS

- ⚠ Park your vehicle so that you do not obstruct the flow of traffic or place yourself in any danger and set up a warning triangle.
- ⚠ Make sure that your vehicle is on firm and level ground with the front wheels pointing straight ahead.
- ⚠ Switch off the ignition and apply the parking brake.

Wheels and Tires

WARNINGS

 If your vehicle has a manual transmission, move the transmission selector lever to first or reverse gear. If your vehicle has an automatic transmission, move the transmission selector lever to park (P).

 Make sure all passengers are out of your vehicle.

 Chock the diagonally opposite wheel to the punctured tire with an appropriate block or wheel chock. A wheel chock may be located in the B-pillar or in a storage compartment in the front right-hand side stepwell.

 Make sure that the arrows on directional tires point in the direction of rotation when your vehicle is moving forward. If you have to fit a spare tire with the arrows pointing in the opposite direction have the tire refitted as soon as possible.

 Do not work on your vehicle when the jack is the only support. If the vehicle slips off the jack, you or someone else could be seriously injured.

 Make sure that the jack is vertical to the jacking point and the base is flat on the ground.

Note: *Do not lay alloy wheels face down on the ground, this will damage the paint.*



E170792

Remove the spare wheel cover and remove the spare wheel:

1. Flip the lock forward to open the spare wheel cover.
2. When the lock is completely open, grab the cover to release from the inner carrier.
3. Release the cover at the bottom first, then release the cover at the top.

To remove the road wheel, slacken the lug nuts (including the locking nut).

1. Loosen the remaining lug nuts, but do not remove them.
2. Raise your vehicle until the wheel and tire is clear of the ground.
3. Remove the lug nuts and the road wheel.

Removing a Spare Wheel

To remove and install the spare wheel:

Wheels and Tires

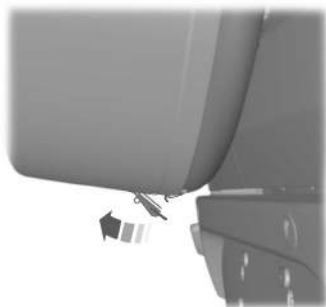

E162830

1. Unlock the outer cover and the inner cover together with the lock bracket at the bottom.



E162831

2. Pull out the outer cover.

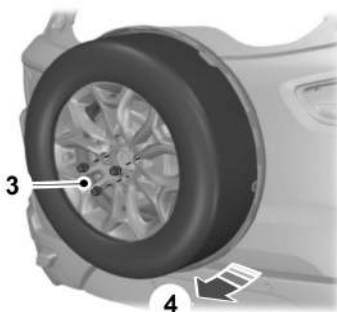



E162832

3. Remove the three nuts.
4. Remove the spare wheel.
5. Install in the reverse order.

Installing a Road Wheel

WARNINGS

 Use only approved wheel and tire sizes. Using other sizes could damage your vehicle. See **Technical Specifications** (page 157).

 Do not fit run flat tires on vehicles that were not originally fitted with them. See an authorized dealer for more details regarding compatibility.

WARNINGS

 Do not install alloy wheels using lug nuts designed for use with steel wheels.

 Make sure there is no lubrication (grease or oil) on the threads or the surface between the wheel lugs and nuts. This can cause the lug nuts to loosen while driving.

Note: Make sure the wheel and hub contact surfaces are free from foreign matter.

Wheels and Tires

Note: Make sure that the cones on the lug nuts are against the wheel.

1. Install the wheel.

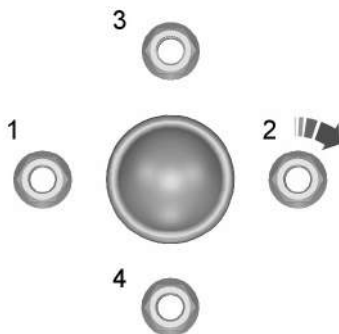

2. Install all of the lug nuts and partially tighten them in the sequence shown.
3. Lower your vehicle and remove the vehicle jack.
4. Fully tighten the lug nuts in the sequence shown. See **Technical Specifications** (page 157).

Note: Have the lug nuts checked for tightness and the tire pressure checked as soon as possible.

E90589

TECHNICAL SPECIFICATIONS

Lug Nut Torque

Wheel type	lb.ft (Nm)
Road wheels	100 lb.ft (135 Nm)
Spare wheel when mounted on the tailgate	41 lb.ft (55 Nm)

Tire Pressures (Cold Tires)

Variant	Tire size	Normal load		Full load	
		Front	Rear	Front	Rear
		psi (bar)	psi (bar)	psi (bar)	psi (bar)
All engines	205/60 R16	30 psi (2.1 bar)	26 psi (1.8 bar)	35 psi (2.4 bar)	39 psi (2.7 bar)
All engines	205/50 R17	30 psi (2.1 bar)	26 psi (1.8 bar)	35 psi (2.4 bar)	39 psi (2.7 bar)

Wheels and Tires

Snow Chain Wheel

Variant	Tire size	Normal load		Full load	
		Front	Rear	Front	Rear
		psi (bar)	psi (bar)	psi (bar)	psi (bar)
All engines	195/65 R15	30 psi (2.1 bar)	30 psi (2.1 bar)	35 psi (2.4 bar)	39 psi (2.7 bar)

Capacities and Specifications

VEHICLE IDENTIFICATION PLATE

Note: Your vehicle identification plate design may vary to that shown.

Note: The information shown on the vehicle identification plate is dependent upon market requirements.

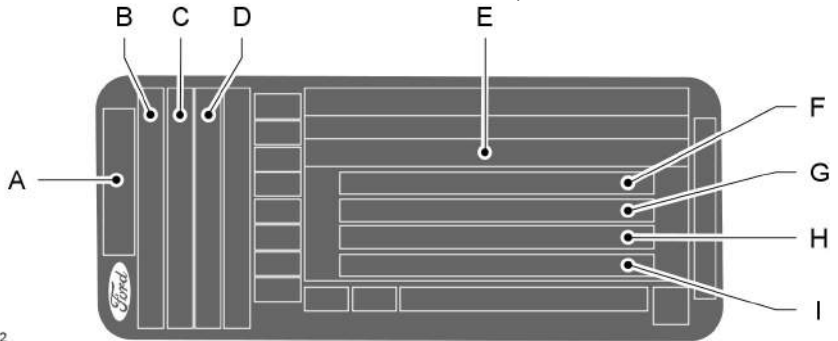

E135662

- A Model
- B Variant
- C Engine designation
- D Engine power and emission level
- E Vehicle identification number
- F Gross vehicle weight
- G Gross train weight
- H Maximum front axle weight
- I Maximum rear axle weight

Your vehicle identification number and maximum weights are shown on a plate, located at the bottom of the lock side of the right-hand door aperture.

Capacities and Specifications

VEHICLE IDENTIFICATION NUMBER

The vehicle identification number is stamped into the floor panel on the right-hand side, beside the front seat. It is also shown on the left-hand side of the instrument panel.



E87496

TECHNICAL SPECIFICATIONS

Vehicle Dimensions

Dimension description	in (mm)
Maximum length	168 in (4,273 mm)
Overall width including exterior mirrors	81 in (2,057 mm)
Overall height	64–65 in (1,628–1,658 mm)
Wheelbase	99 in (2,519 mm)
Front track	60 in (1,529 mm)
Rear track	60 in (1,532 mm)

Audio System

GENERAL INFORMATION

Radio Frequencies and Reception Factors

AM and FM frequencies are established by the Federal Communications Commission (FCC) and the Canadian Radio and Telecommunications Commission (CRTC). Those frequencies are:

- AM: 530, 540-1700, 1710 kHz
- FM: 87.9-107.7, 107.9 MHz

Radio Reception Factors	
Distance and strength	The further you travel from an FM station, the weaker the signal and the weaker the reception.
Terrain	Hills, mountains, tall buildings, bridges, tunnels, freeway overpasses, parking garages, dense tree foliage and thunderstorms can interfere with the reception.
Station overload	When you pass a ground-based broadcast repeating tower, a stronger signal may overtake a weaker one and result in the audio system muting.

CD and CD Player Information

Note: *CD units play commercially pressed 4.75-inch (12 centimeter) audio compact discs only. Due to technical incompatibility, certain recordable and re-recordable compact discs may not function correctly when used in Ford CD players.*

Note: *Do not insert CDs with homemade paper (adhesive) labels into the CD player as the label may peel and cause the CD to become jammed. You should use a permanent felt tip marker rather than adhesive labels on your homemade CDs. Ballpoint pens may damage CDs. Please contact an authorized dealer for further information.*

Note: *Do not use any irregularly shaped discs or discs with a scratch protection film attached.*

Always handle discs by their edges only. Clean the disc with an approved CD cleaner only. Wipe it from the center of the disc toward the edge. Do not clean in a circular motion.

Do not expose discs to direct sunlight or heat sources for extended periods.

MP3 Track and Folder Structure

Audio systems capable of recognizing and playing MP3 individual tracks and folder structures work as follows:

- There are two different modes for MP3 disc playback: MP3 track mode (system default) and MP3 folder mode.
- MP3 track mode ignores any folder structure on the MP3 disc. The player numbers each MP3 track on the disc (noted by the .mp3 file extension) from T001 to a maximum of T255. The maximum number of playable MP3 files may be less depending on the structure of the CD and exact model of radio present.

Audio System

- MP3 folder mode represents a folder structure consisting of one level of folders. The CD player numbers all MP3 tracks on the disc (noted by the .mp3 file extension) and all folders containing MP3 files, from F001 (folder) T001 (track) to F253 T255.
- Creating discs with only one level of folders helps with navigation through the disc files.

If you are burning your own MP3 discs, it is important to understand how the system reads the structures you create. While various files may be present, (files with extensions other than mp3), only files with the .mp3 extension are played; other files are ignored by the system. This enables you to use the same MP3 disc for a variety of tasks on your work computer, home computer and your in-vehicle system.

In track mode, the system displays and plays the structure as if it were only one level deep (all .mp3 files play, regardless of being in a specific folder). In folder mode, the system only plays the .mp3 files in the current folder.

AUDIO UNIT - VEHICLES WITH: AM/FM/CD

WARNINGS



Radio sound levels can go above 85dB. Listening to sounds about 85 decibels can harm the human auditory system.



Driving while distracted can result in loss of vehicle control, crash and injury. We strongly recommend that you use extreme caution when using any device that may take your focus off the road. Your primary responsibility is the safe operation of your vehicle. We recommend against the use of any hand-held device while driving and encourage the use of voice-operated systems when possible. Make sure you are aware of all applicable local laws that may affect the use of electronic devices while driving.

Note: *Some systems do not have a CD player.*

Audio System

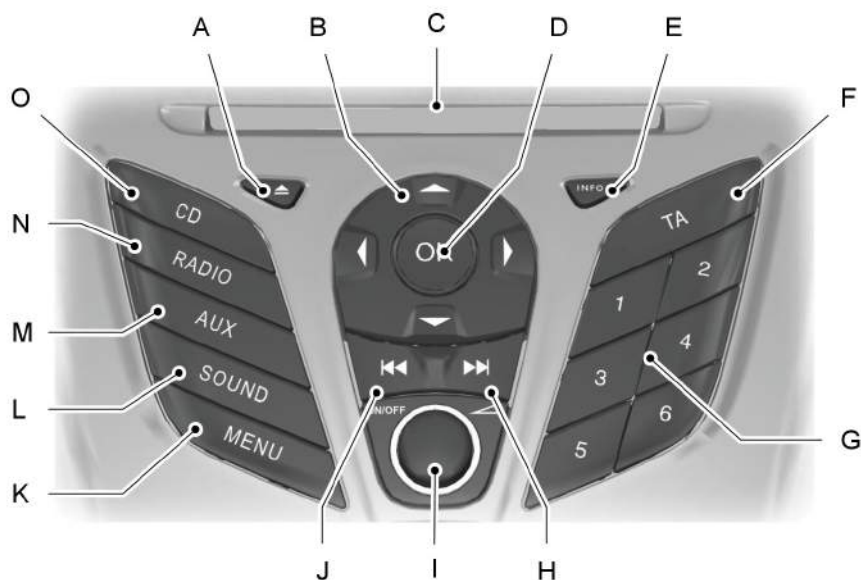

E130324

- A Ejects a CD.
- B Cursor arrows allow you to scroll through on-screen choices.
- C CD slot is where you insert a CD.
- D OK confirms on-screen selections.
- E INFO allows you to access radio, CD, USB and iPod information.
- F TA allows you to turn traffic announcements on or off and cancels announcements during an active announcement.
- G Number block allows you to store your favorite radio stations. When tuned to a station, press and hold a button until sound returns. Press to recall a previously stored station.
- H Seek allows you to go to the next station up the radio frequency band or the next track on a CD.
- I ON/OFF and Volume allows you to switch the audio system on or off by pressing the button. Turn the dial to adjust the volume.
- J Seek allows you to go to the next station down the radio frequency band or the previous track on a CD.

Audio System

- K MENU allows you to access different audio system features.
- L SOUND allows you to adjust the sound settings for Treble, Middle, Bass, Fade and Balance.
- M AUX allows you to access the AUX and SYNC features, and cancels menu or list browsing.
- N RADIO allows you to select different radio bands, and cancels menu or list browsing.
- O Change source to CD, and cancels menu or list browsing.

Sound Button

This allows you to adjust the sound settings (such as bass, middle and treble).

1. Press **SOUND**.
2. Use the up and down arrow buttons to select the required setting.
3. Use the left and right arrow buttons to make the necessary adjustment. The display indicates the level selected.
4. Press the **OK** button to confirm the new settings.

Waveband Button

Press **RADIO** to select from the wavebands available.

You can use the selector to return to radio reception when you have been listening to another source.

Alternatively, press the left arrow button to display the available wavebands. Scroll to the required waveband and press **OK**.

Station Tuning Control

Seek Tuning

Select a waveband and briefly press one of the seek buttons. The unit stops at the first station it finds in the direction you have chosen.

Manual Tuning

1. Press **MENU**.
2. Select RADIO mode, and then MANUAL TUNE.
3. Use the left and right arrow buttons to tune down or up the waveband in small increments or press and hold to increment quickly, until you find the desired station.
4. Press **OK** to continue listening to a station.

Scan Tuning

Scan allows you to listen to a few seconds of each station detected.

1. Press **MENU**.
2. Select RADIO mode and then SCAN.
3. Use the seek buttons to scan up or down the selected waveband.
4. Press **OK** to continue listening to a station.

Station Preset Buttons

This feature allows you to store your favorite stations. You can recall them by selecting the appropriate waveband and pressing one of the preset buttons.

1. Select a waveband.
2. Tune to the station required.

Audio System

3. Press and hold one of the preset buttons. A progress bar and message appear. When the progress bar completes the station has been stored. The audio unit briefly mutes as confirmation.

You can repeat this on each waveband and for each preset button.

Note: *When you drive to another part of the country, stations that broadcast on alternative frequencies, and are stored on preset buttons, may update with the correct frequency and station name for that area.*

Autostore Control

Note: *This stores up to a maximum of the 10 strongest signals available, either from the AM or the FM waveband, and overwrite the previously stored stations. You can also store stations manually in the same way as other wavebands.*

- Press **MENU**, select RADIO mode, then press AUTOSTORE.
- When the search is complete, sound returns and the strongest signals are stored on the autostore presets.

Traffic Information Control

Many stations that broadcast on the FM waveband have a TP code to signify that they carry traffic program information.

Turning Traffic Announcements On and Off

Before you can receive traffic announcements, you must press either the **TA** or **TRAFFIC** button. A TA display appears to show the feature is on.

If you are listening to a station that broadcasts traffic information, TP also displays. Otherwise, the unit searches for a traffic program.

When traffic information broadcasts, it automatically interrupts normal radio or CD playback and Traffic announcement appears in the display.

If you select a non-traffic station using a preset button, the audio unit remains on that station unless you turn TA or TRAFFIC off, then on again.

Note: *If traffic announcement is on and you select a preset or manually tune to a non-traffic announcement station, you do not hear traffic announcements.*

Note: *When you are listening to a non-traffic announcement station and turn traffic announcement off and on again, a TP seek occurs.*

Traffic Announcement Volume

Traffic announcements interrupt normal broadcasts at a preset minimum level that is usually louder than normal listening volumes.

To adjust the preset volume:

- Use the volume control to make the necessary adjustment during an incoming traffic announcement broadcast. The display shows the selected level.

Ending Traffic Announcements

The audio unit returns to normal operation at the end of each traffic announcement. To end the announcement prematurely, press **TA** or **TRAFFIC** during the announcement.

Note: *If you press TA or TRAFFIC at any other time, it switches all announcements off.*

Automatic Volume Control

When available, automatic volume control adjusts the volume level to compensate for engine noise and road speed noise.

Audio System

1. Press **MENU**, and then select AUDIO or AUDIO SETTINGS.
2. Select AVC LEVEL or ADAPTIVE VOL.
3. Use the left or right arrow button to adjust the setting.
4. Press **OK** to confirm your selection.
5. Press **MENU** to return.

News Broadcasts

Your audio unit may interrupt normal reception to broadcast news bulletins from stations on the FM waveband, radio data system or other enhanced network linked stations.

The display indicates there is an incoming announcement during news broadcasts. When the audio unit interrupts for a news broadcast, the preset volume level is the same as traffic announcements.

1. Press **MENU**.
2. Select AUDIO or AUDIO SETTINGS.
3. Scroll to NEWS and turn on or off by pressing **OK**.
4. Press **MENU** to return.

Alternative Frequencies

The majority of programs that broadcast on the FM waveband have a program identification code that audio units can recognize.

When your vehicle moves from one transmission area to another with the alternative frequencies tuning switched on, this function searches for the strongest station signal.

Under certain conditions, however, alternative frequencies tuning may temporarily disrupt normal reception.

When selected, the unit continually evaluates signal strength and if a better signal becomes available, the unit switches to that alternative. It mutes while it checks a list of alternative frequencies and if necessary, it searches once across the selected waveband for a genuine alternative frequency.

It restores radio reception when it finds one or, if it cannot find one, returns to the original stored frequency.

When selected, **AF** appears in the display.

1. Press **MENU**.
2. Select AUDIO or AUDIO SETTINGS.
3. Scroll to ALTERNAT FREQ. or ALTERNATIVE FREQ. and turn on or off by pressing **OK**.
4. Press **MENU** to return.

Regional Mode

Regional mode controls the behavior of alternative frequencies switching between regionally related networks of a parent broadcaster. A broadcaster may run a large network across a large part of the country. At various times of the day this large network may be broken down into a number of smaller regional networks, typically centered on major towns or cities. When not split into these smaller variants, the whole network carries the same programming.

Regional mode ON: This prevents random alternative frequency switches when neighboring regional networks are not carrying the same programming.

Regional mode OFF: This allows a larger coverage area if neighboring regional networks carry the same programming, but it can cause random alternative frequency switches if they are not.

1. Press **MENU**.
2. Select AUDIO or AUDIO SETTINGS.

Audio System

3. Scroll to RDS REGIONAL and turn on or off by pressing **OK**.
4. Press **MENU** to return.

AUDIO UNIT

WARNINGS

 Radio sound levels can go above 85dB and listening to sounds above 85 decibels can harm the human auditory system. Law 11.291/2006.

WARNINGS

 Driving while distracted can result in loss of vehicle control, crash and injury. We strongly recommend that you use extreme caution when using any device that may take your focus off the road. Your primary responsibility is the safe operation of your vehicle. We recommend against the use of any hand-held device while driving and encourage the use of voice-operated systems when possible. Make sure you are aware of all applicable local laws that may affect the use of electronic devices while driving.

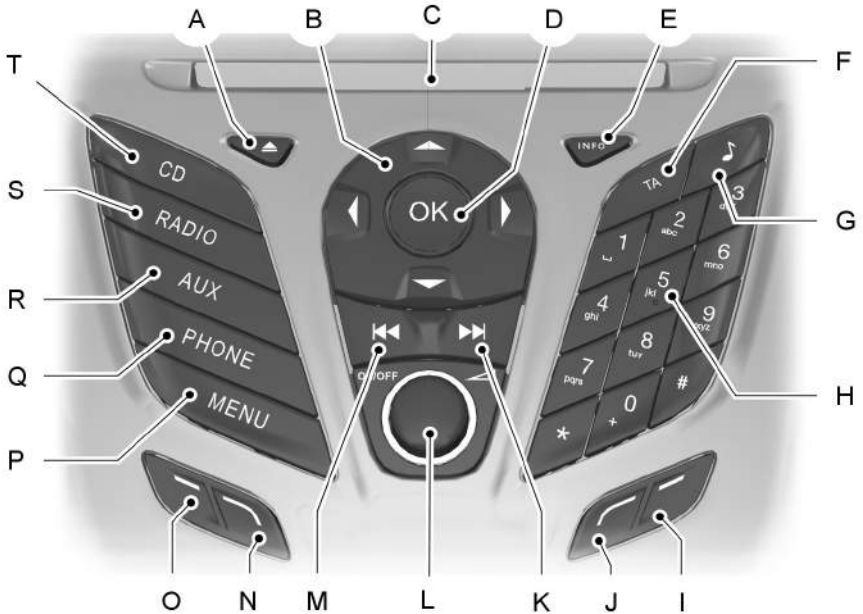

E130142

- A Ejects a CD.
- B Arrow keys let you navigate through the options displayed on the display.
- C Opening access for CD.

Audio System

- D OK confirms the selections shown on the display.
- E INFO let you access information from CD, USB and iPod.
- F TA allows you to turn traffic announcements on or off and cancels announcements during an active announcement.
- G SOUND lets you adjust the sound settings for Treble, Mid, Low, Fade, Balance, Equalizer Settings and DSP.
- H Number block can store your favorite radio stations. When turned to a station, press and hold the button until the station is memorized. Press to go to a station previously stored. In CD mode, press a number to select a track. In phone mode, use the buttons to dial a phone number.
- I Function button allows you to select four different functions of the audio system depending on the mode (i.e. radio, CD, AUX, USB, iPod, phone or Bluetooth) where you are.
- J Function button allows you to select three different functions of the audio system depending on the mode (i.e. radio, CD, AUX, USB, iPod, phone or Bluetooth) where you are.
- K Seek allows you to go to the next station up the radio frequency band, or to the next track on a CD, USB, iPod and Bluetooth audio (if your device supports Bluetooth).
- L ON/OFF and Volume allows you to turn on or off the audio system by pressing the button. Turn the knob to adjust the volume.
- M Seek allows you to go to the next station down the radio frequency band or the previous track on a CD, USB, iPod and Bluetooth audio (if your device supports Bluetooth).
- N Function button allows you to select two different functions of the audio system depending on the mode (i.e. radio, CD, AUX, USB, iPod, phone or Bluetooth) where you are.
- O Function button allows you to select different functions of the audio system depending on which mode (i.e. radio, CD, AUX, USB, iPod, phone or Bluetooth) where you are.
- P MENU allows you to access different audio system features.
- Q PHONE allows you to access the phone features of the SYNC system. See separate manual.
- R AUX allows you to access the AUX, USB, iPod, Bluetooth Audio, SYNC and also cancels the scrolling menu or list. See separate manual.
- S RADIO lets you select different radio bands and will also cancel the scrolling menu or list.
- T Change source to CD, will also cancel menu or list browsing.

Audio System

Sound Button

This will allow you to adjust the sound settings (for example bass, middle and treble).

1. Press the sound button.
2. Use the up and down arrow buttons to select the required setting.
3. Use the left and right arrow buttons to make the necessary adjustment. The display indicates the level selected.
4. Press the OK button to confirm the new settings.

Frequency Band Button

Press RADIO to select one of the frequency bands available: AM, AM AST, FM, FM AST.

You can use the selector to return to radio reception when you have been listening to another source.

Alternatively, press the left arrow button to display the available frequency bands. Scroll to the required frequency band and press OK.

Station Tuning Control

Seek Tuning

Select a frequency band and briefly press one of the seek buttons. The unit will stop at the first station it finds in the direction you have chosen.

Manual Tuning

1. Press function button 2.
2. Use the left and right arrow buttons to tune down or up the frequency band in small increments or press and hold to increment quickly, until you find a station you want to listen to.
3. Press OK to continue listening to a station.

Scan Tuning

Scan allows you to listen to a few seconds of each station detected.

1. To activate, press the function button 3.
2. Use the seek buttons to scan up or down the frequency band.
3. To deactivate, press the function button 3 again or OK to continue listening to a station.

Station Preset Buttons

This feature allows you to store your favorite stations, they can be recalled by selecting the appropriate frequency band and pressing one of the preset buttons.

1. Select a frequency band.
2. Tune to the station required.
3. Press and hold one of the preset buttons. A progress bar and message will appear. When the progress bar completes the station has been stored. The audio unit will also mute momentarily as confirmation.

You can repeat this on each frequency band and for each preset button.

Note: *When you drive to another part of the country, stations that broadcast on alternative frequencies, and are stored on preset buttons, may be updated with the correct frequency and station name for that area.*

Autostore Control

Note: *Stores the 10 strongest signals available in the frequency band AM AST or FM AST, and overwrites the previously stored stations. You can also manual store a station in the same manner as other frequency bands.*

Audio System

- Press and hold the function button 1. A progress bar and a message will be displayed.
- When the search is complete, sound is restored and the strongest signals are stored on the autostore presets.

Traffic Information Control (if

Equipped)

To receive alerts about traffic, you must press the TA button. A TA symbol is displayed to show that the feature was activated.

Turning Traffic Announcements On and Off

Before you can receive traffic announcements, you must press either the TA button. A TA display will appear to show the feature is switched on.

If you are already tuned to a station that broadcasts traffic information, TP will also be displayed. Otherwise the unit will search for a traffic program.

When traffic information is broadcast, it will automatically interrupt normal radio or CD playback and Traffic announcement will appear in the display.

If a non-traffic station is selected or recalled using a preset button, the audio unit will remain on that station unless TA is turned off, then on again.

Note: *If traffic announcement is on and you select a preset or manual tune to a non traffic announcement station no traffic announcement will be heard.*

Note: *When you are listening to a non traffic announcement station and turn traffic announcement off and on again a TP seek will occur.*

Traffic Announcement Volume

Traffic announcements interrupt normal broadcasts at a preset minimum level that is usually louder than normal listening volumes.

To adjust the preset volume:

- Use the volume control to make the necessary adjustment during an incoming traffic announcement broadcast. The display will show the level selected.

End of Transit Notification

The audio unit will return to normal operation at the end of each traffic announcement. To end the announcement prematurely, press TA during the announcement.

Note: *If you press TA at any other time it will switch all announcements off.*

Automatic Volume Control

When available, automatic volume control adjusts the volume level to compensate for engine noise and road speed noise.

1. Press the MENU button and AUDIO SETTINGS.
2. Select VOL. ADJUSTABLE.
3. Use the arrow button, left or right, to adjust the setting.
4. Press the OK button to confirm your selection.
5. Press the MENU button to return.

News Broadcasts

Your audio unit may interrupt normal reception to broadcast news bulletins from stations on the FM frequency band, radio data system or other enhanced network linked stations.

Audio System

The display will indicate there is an incoming announcement, during news broadcasts. When the audio unit interrupts for a news broadcast the preset volume level will be the same as traffic announcements.

1. Press the MENU button.
2. Select AUDIO SETTINGS.
3. Scroll to NEWS and turn on or off with the OK button.
4. Press the MENU button to return.

Alternative Frequencies

The majority of programs that broadcast on the FM frequency band have a program identification code, it can be recognized by audio units.

When your vehicle moves from one transmission area to another with the alternative frequencies tuning switched on, this function will search for the strongest station signal.

Under certain conditions, however, alternative frequencies tuning may temporarily disrupt normal reception.

When selected, the unit continually evaluates signal strength and, if a better signal becomes available, the unit will switch to that alternative. It mutes while it checks a list of alternative frequencies and if necessary, it will search once across the selected frequency band for a genuine alternative frequency.

It will restore radio reception when it finds one or if one is not found, the unit will return to the original stored frequency.

When selected, AF will be shown in the display.

1. Press the MENU button.
2. Select AUDIO SETTINGS.

3. Scroll to ALTERNAT FREQ. or ALTERNATIVE FREQ. and turn on or off with the OK button.
4. Press the MENU button to return.

Regional Mode

The regional mode controls the behavior of switching between alternative frequencies list of regional networks of a station. The station can maintain a fairly wide network coverage over a large part of the country. At various times of the day this large network can be separated into several smaller regional networks, typically centralized in major cities or areas. When the network is not divided into regional variants, the entire network broadcasts the same programming.

Regional mode ON: This prevents random alternative frequency switches when neighboring regional networks are not carrying the same programming.

Regional mode OFF: This allows a larger coverage area if neighboring regional networks are carrying the same programming, but can cause random alternative frequency switches if they are not.

1. Press the MENU button.
2. Select AUDIO SETTINGS.
3. Scroll to RDS REGIONAL and turn on or off with the OK button.
4. Press the MENU button to return.

COMPACT DISC PLAYER

Compact Disc Playback

Note: *During playback, the display indicates the disc, track and time that have elapsed since the start of the track.*

During radio reception, press **CD** once to start CD playback.

Audio System

After a disc is loaded, playback starts immediately.

Track Selection

- Press the seek down button once to replay the current track. If pressed within two seconds of the start of a track, the previous track plays.
- Press the up or down arrow buttons to select the required track, then press **OK**.

You can select a track by using the numeric keypad. Dial the required track number until complete (for example, 1 then 2 for track 12), or dial the number and directly press **OK**.

Fast Forward and Reverse

Press and hold the seek down or up buttons to search backward or forward within the tracks on the disc.

Shuffle and Random

Random track playback, also known as shuffle, plays all tracks on the CD in random order.

Press function button 2.

Note: *When an MP3 CD is playing, you can have the system shuffle tracks for the whole CD, or within the current folder. Pressing function button 2 toggles these options.*

Use the seek up or down button to select the next track to shuffle, if required.

Repeat Compact Disc Tracks

Press function button 1.

Note: *When an MP3 or WMA CD is playing, you can have the system repeat the current track or all tracks within the current folder. Pressing function button 1 toggles these options.*

Compact Disc Track Scanning

Press function button 3.

Note: *When an MP3 or WMA CD is playing, you can have the system scan tracks on the CD or within the current folder. Pressing function button 3 toggles these options.*

MP3 and WMA File Playback

MP3 (MPEG 1 Audio Layer-3) or WMA (Windows media audio) is a standard technology and format for compressing audio data. This allows a more efficient use of the media.

You can play MP3 files recorded on CD-ROM, CD-R and CD-RW formats. The disc must be in the ISO 9660 level 1 or level 2 format, or Joliet or Romeo in the expansion format. You can also use a disc recorded in multi session.

ISO 9660 Format

This is the most common international standard for the logical format of files and folders on a CD-ROM.

There are several specification levels. In Level 1, file names must be in the 8.3 format (no more than eight characters in the name, no more than three characters in the extension .MP3 and .WMA) and in capital letters.

Folder names can be no longer than eight characters. There can be no more than eight folder levels (trees). Level 2 specifications allow file names up to 31 characters long.

Each folder can have up to eight trees.

For Joliet or Romeo in the expansion format, consider these restrictions when configuring your CD writing software.

Multi Session

This recording method enables adding of data using the track-at-once method.

Audio System

Conventional CDs begin at a CD control area called the lead-in and end at an area called lead-out. A multi session CD is a CD having multiple sessions, with each segment from lead-in to lead-out regarded as a single session.

CD-Extra: The format that records audio (audio CD data) as tracks on session 1, and records data as tracks on session 2.

Mixed CD: In this format, data records as track 1 and audio (audio CD data) records as track 2.

File Formats

With formats other than ISO 9660 level 1 and level 2, folder names or file names may not display correctly.

When naming, be sure to add the file extension .MP3 or .WMA to the file name.

If you put the extension .MP3 or .WMA to a file other than MP3 or WMA, the unit cannot recognize the file correctly and generates random noise that could damage your speakers.

The following discs take a longer time to start playback.

- A disc recorded with complicated tree structure.
- A disc recorded in multi session.
- A non-finalized disc, where you can add more data.

Playing a Multi Session Disc

When the first track of the first session is audio CD data only, the audio CD data of the first session plays. Non-audio CD data, MP3 or WMA file information (such as track number and time) displays with no sound.

When the first track of the first session is not audio CD data:

- If an MP3 or WMA file is on the disc, the system skips these file and other data. Audio CD data is not recognized.
- If no MP3 or WMA file is in the disc, nothing plays. Audio CD data is not recognized.

MP3 and WMA Files Playback Order

The playback order of the folders and files are as shown.

Note: *The system skips any folder that does not include an MP3 or WMA file.*

To specify a desired playback order before the folder or file name, input the order by number (for example, 01 or 02) then record the contents onto a disc. The order differs depending on the writing software.

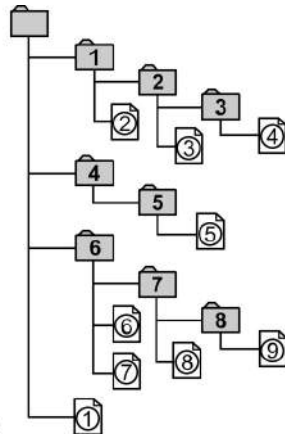

E104206

ID3 Tag Version 2

The following occurs when an MP3 or WMA file containing a tag plays:

Audio System

- When skipping a portion of a tag (at the beginning of the track) there is no sound output. Skip time changes depending on the tag capacity. Example: At 64 kbytes, it is about 2 seconds (with RealJukebox).
- The displayed elapsed playing time when skipping a portion of the tag is inaccurate. For MP3 files of a bit rate other than 128 kbps, time does not display accurately during playback.
- When an MP3 file is created with MP3 conversion software (such as RealJukebox - a registered trademark of RealNetworks Inc.), the tag generates automatically.

MP3 or WMA Navigation

You can record MP3 tracks on the CD in several ways. You can place them in the root directory like a conventional audio CD, or in folders that may represent categories, such as album, artist, or genre.

The normal playing sequence on CDs with multiple folders is:

- Play the tracks within the root (top level) first
- Then the tracks in any folder(s) within the root
- Then move onto the second folder, and so forth.

To navigate to a track:

1. Press the up or down arrow buttons to enter the track list.
2. Navigate the hierarchy using the arrow buttons to select another folder or track (file).
3. Press **OK** to select a highlighted track.

MP3 and WMA Display Options

When an MP3 or WMA disc is playing, certain information encoded in each track can display. Such information normally includes:

- The file name.
- The folder name.
- ID3 information, which might be the album or artist name.

The unit normally shows the file name that is playing. To select one of the other items of information, press **INFO** repeatedly until the required item appears in the display.

Note: *If the ID3 information selected is unavailable, **NO MP3** or **WMA TAG** appears in the display.*

CD Text Display Options

When an audio disc with CD text is playing, limited information encoded in each track can display. Such information normally includes:

- The disc name.
- The artist name.
- The track name.

Note: *You can select these display options in the same way as MP3 displays. **NO DISC NAME** or **NO TRACK NAME** appears in the display if there is no encoded information.*

Ending Compact Disc Playback

To restore radio reception on all units, press **RADIO**.

Note: *The CD does not eject. The disc pauses at the point where radio reception returned.*

To resume CD playback, press **CD** again.

Audio System

AUXILIARY INPUT JACK

WARNINGS



Driving while distracted can result in loss of vehicle control, accident and injury. We strongly recommend that you use extreme caution when using any device or feature that may take your focus off the road. Your primary responsibility is the safe operation of your vehicle. We recommend against the use of any handheld device while driving and encourage the use of voice-operated systems when possible. Make sure that you are aware of applicable state and local laws that may affect use of electronic devices while driving.



For safety reasons, do not connect or adjust the settings on your portable music player while your vehicle is moving.



Store the portable music player in a secure location, such as the center console or the glove box, when your vehicle is moving. Hard objects may become projectiles in a collision or sudden stop, which may increase the risk of serious injury. The audio extension cable must be long enough to allow the portable music player to be safely stored while your vehicle is moving.

Note: *You cannot index songs using the auxiliary input jack.*

The auxiliary input jack allows you to connect and play music from your portable music player through your vehicle speakers. You can use any portable music player designed for use with headphones. Your audio extension cable must have male 1/8th-inch (3.5 millimeter) connectors at each end.

1. Switch off the engine, radio and portable music player. Set the parking brake and put the transmission in position **P** (vehicle with an automatic transmission) or neutral (vehicle with a manual transmission).
2. Plug the extension cable from the portable music player into the auxiliary input jack.
3. Switch the radio on. Select either a tuned FM station or a CD.
4. Adjust the volume as desired.
5. Switch your portable music player on and adjust its volume to half its maximum level.
6. Press **AUX** until **LINE** or **LINE IN** appears in the display. You should hear music from your device even if it is low.
7. Adjust the volume on your portable music player until it reaches the volume level of the FM station or CD. Do this by switching back and forth between the AUX and FM or CD controls.



E146367

Audio System

USB PORT (IF EQUIPPED)

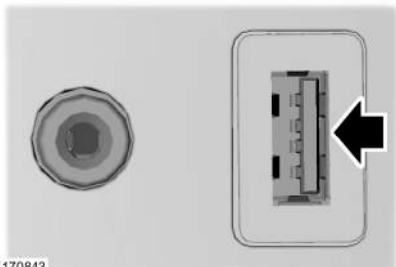

E170843

The USB port allows you to plug in media playing devices, memory sticks and charge devices (if supported). See **SYNC™** (page 177).

AUDIO TROUBLESHOOTING

Audio unit display	Rectification
PLEASE CHECK CD	General error message for CD fault conditions, such as cannot read the CD, data-CD inserted, etc. Make sure the disc is loaded correct way up. Clean and re-try, or replace disc with known music disc. If error persists contact your dealer.
CD DRIVE MALFUNCTION	General error message for CD fault conditions such as possible mechanism fault.
CD DRIVE HIGH TEMP	Ambient temperature too hot – unit will not work until it has cooled down.

GENERAL INFORMATION

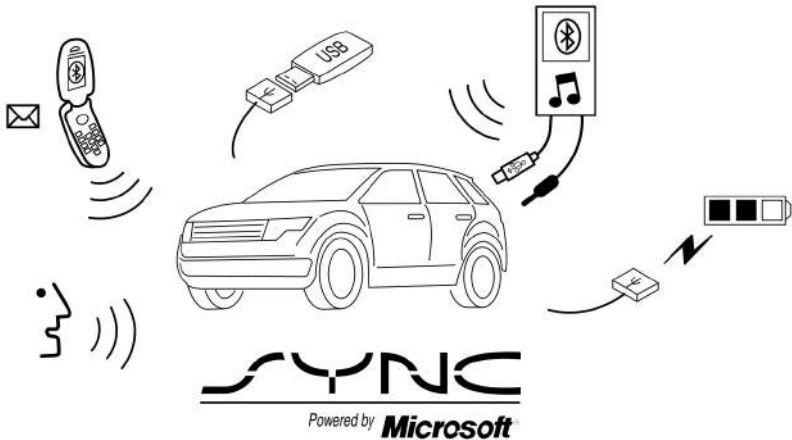

E142598

SYNC is an in-vehicle communications system that works with your Bluetooth-enabled cell phone and portable media player.

This allows you to:

- Make and receive calls
- Access and play music from your media player
- Use Emergency Assistance
- Access phonebook contacts and music using voice commands
- Stream music from your connected cell phone
- Select pre-defined text messages

- Use the advanced voice recognition system
- Charge your USB device (if your device supports this).

Make sure that you review your device's manual before using it with SYNC.

Support

For further support, see an authorized dealer. For more information, visit the regional Ford website.

Safety Information

WARNING



Driving while distracted can result in loss of vehicle control, crash and injury. We strongly recommend that you use extreme caution when using any device that may take your focus off the road. Your primary responsibility is the safe operation of your vehicle. We recommend against the use of any hand-held device while driving and encourage the use of voice-operated systems when possible. Make sure you are aware of all applicable local laws that may affect the use of electronic devices while driving.

When using SYNC:

- Do not operate playing devices if the power cords or cables are broken, split or damaged. Carefully place cords and cables where you cannot step on them or they do not interfere with the operation of pedals, seats, compartments or safe driving abilities.
- Do not leave playing devices in your vehicle during extreme conditions as it could cause them damage. Refer to your device's manual for further information.
- Do not attempt to service or repair the system. See an authorized dealer.

Privacy Information

When a cell phone is connected to SYNC, the system creates a profile that is linked to that cell phone. The system creates the profile to offer you more mobile features and to operate more efficiently. Among other things, this profile may contain data about your phonebook, text messages (read and unread) and call history. This will include the history of calls when your cell phone was not connected to the system. If you connect a media player, the system creates and retains an index of

supported media content. The system also records a short development log of approximately 10 minutes of all recent system activity. The log profile and other system data may be used to improve the system and help diagnose any problems that may occur.

The cell phone profile, media player index and development log will remain in the system unless deleted. They are generally accessible in your vehicle only when you connect your cell phone or media player. If you no longer plan to use the system or your vehicle, we recommend you complete a master reset to erase all stored information. See **Information Displays** (page 61).

Special equipment is required to access system data. Access to your vehicle's SYNC module is also required. We will not access the system data for any purpose other than as described without consent. Examples where system data can be accessed are for a court order, where required by law enforcement, other government authorities or other third parties acting with lawful authority. Other parties may seek to access the information independently of us. Further privacy information is available. See **SYNC™ Applications and Services** (page 191).

USING VOICE RECOGNITION

This system helps you control many features using voice commands. This allows you to keep your hands on the steering wheel and focus on what is around you.

Helpful Hints

Make sure the interior of your vehicle is as quiet as possible. Wind noise from open windows and road vibrations may prevent the system from correctly recognizing spoken commands.

Before giving a voice command, wait for the system announcement to finish followed by a single beep. Any command spoken before this does not register with the system.

Speak naturally, without long pauses between words.

You can interrupt the system at any time while it is speaking by pressing the voice button. You can also cancel a voice session at any time by pressing and holding the voice button.

Initiating a Voice Session



Press the voice button. A list of available commands appears in the display.

Say	If you want to
"Bluetooth Audio"	Stream audio from your cell phone.
"Cancel"	Cancel the requested action.
"Line in"	Access the device connected to the auxiliary input jack.
"Phone"	Make calls.
"SYNC"	Return to the main menu.
"USB"	Access the device connected to your USB port.
"Voice settings"	Adjust the level of voice interaction and feedback.
"Help"	Hear a list of voice commands available in the current mode.

System Interaction and Feedback

The system provides feedback through audible tones, prompts, questions and spoken confirmations depending on the situation and your chosen level of interaction. You can customize the voice recognition system to provide more or less instruction and feedback.

The default setting is to a higher level of interaction in order to help you learn to use the system. You can change these settings at any time.

Adjusting the Interaction Level



Press the voice button. Say "Voice settings" when prompted, then any of the following:

When you say	The system
"Interaction mode advanced"	Provides less audible interaction and more tone prompts.
"Interaction mode standard"	Provides more detailed interaction and guidance.

The system defaults to the standard interaction mode.

Confirmation prompts are short questions the system asks when it is not sure of your request or when there is more than one possible response to your request. For example, the system may ask if the

command phone is correct.

Press the voice button to change the confirmation prompt setting. Say "Voice settings" when prompted, then any of the following:

When you say	The system
"Confirmation prompts off"	Makes a best guess from the command. You may still occasionally be asked to confirm settings.
"Confirmation prompts on"	Clarifies your voice command with a short question.

The system creates suggestion lists when it has the same confidence level of several options based on your voice commands. When switched on, the system may prompt you with as many as four possibilities for clarification.

For example, say "one" after the tone to call John Doe at home. Say "two" after the tone to call Johnny Doe on mobile. Say "three" after the tone to call Jane Doe at home.

The same logic applies to media content. For example, say "one" after the tone to play John Doe. Say "two" after the tone to play Johnny Doe. Say "three" after the tone to play Jane Doe.

When you say	The system
"Media candidate lists off"	Makes a best guess from the media suggestion list. The system may occasionally ask you questions.
"Media candidate lists on"	Clarifies your voice command for media suggestions.
"Phone candidate lists off"	Makes a best guess from the cell phone suggestion list. The system may occasionally ask you questions.
"Phone candidate lists on"	Clarifies your voice command for cell phone suggestions.

Changing the Voice Settings

You can change the voice settings using the information and entertainment display.

1. Press the **MENU** button.

2. Select **SYNC-Settings**.
3. Select **Voice Settings**.

USING SYNC™ WITH YOUR PHONE

Hands-free calling is one of the main features of SYNC. While the system supports a variety of features, many are dependent on your cell phone's functionality.

At a minimum, most cell phones with Bluetooth wireless technology support the following functions:

- Answering an incoming call.
- Ending a call.
- Using privacy mode.
- Dialing a number.
- Redialing.
- Call waiting notification.
- Caller ID.

Other features such as text messaging, using Bluetooth and automatic phonebook download are cell phone dependent features. To check your cell phone's compatibility, refer to your device's manual or visit the regional Ford website.

Pairing a Cell Phone for the First Time

Note: *You must switch the ignition and radio on.*

Note: *To scroll through the menus, press the up or down arrows on your audio system.*

Wirelessly pairing your cell phone with the system allows you to make and receive hands-free calls.

1. Make sure you switch on the Bluetooth feature on your cell phone before starting the search. Refer to your device's manual if necessary.
2. Press the **PHONE** button. When the audio display indicates that there are no paired phones, select the option to add a phone.

3. When a message to begin pairing appears in the audio display, search for SYNC on your cell phone to start the pairing process.
4. When prompted on your cell phone's display, enter the six-digit PIN provided by the system in the audio display. The display indicates when the pairing is successful.

Depending on your cell phone's capability and your market, the system may prompt you with questions such as setting the current cell phone as the primary cell phone (the cell phone the system automatically tries to connect with first when you switch the ignition on), downloading your phonebook, etc.

Pairing Subsequent Cell Phones

Note: *You must switch the ignition and radio on.*

Note: *To scroll through the menus, press the up or down arrows on your audio system.*

1. Make sure you switch on the Bluetooth feature on your cell phone before starting the search. Refer to your device's manual if necessary.
2. Press the **PHONE** button.
3. Select the option for Bluetooth devices.
4. Press the **OK** button.
5. Select the option to add. This starts the pairing process.
6. When a message to begin pairing appears in the audio display, search for SYNC on your device to start the pairing process.
7. When prompted on your cell phone's display, enter the six-digit PIN provided by the system in the audio display. The display indicates when the pairing is successful.

The system may prompt you with questions such as setting the current cell

phone as the primary cell phone, downloading your phonebook, etc.

Cell Phone Voice Commands

"Phone"	
"Call <name>" ¹	"Go to privacy"
"Call <name> at home" ¹	"Hold"
"Call <name> at work" ¹	"Join"
"Call <name> in office" ¹	"Menu" ^{2,4}
"Call <name> on cell" ¹	"Phonebook <name>" ²
"Call <name> on other" ¹	"Phonebook <name> at home" ²
"Call history incoming" ²	"Phonebook <name> in office" ²
"Call history missed" ²	"Phonebook <name> at work" ²
"Call history outgoing" ²	"Phonebook <name> on cell" ²
"Connections" ²	"Phonebook <name> on other" ²
"Dial" ^{1,3}	-

¹ You do not need to say "phone" before saying these commands.

² These commands are not available until your cell phone information has completely downloaded using Bluetooth.

³ See **Dial** table.

⁴ See **Menu** table.

Phonebook Commands

When you ask the system to access something such as a phonebook name or number, the requested information appears in the audio display. Press the voice button and say, "call" to call the contact.

SYNC™

"Dial"
"112" (one-one-two)
"700" (seven hundred)
"800" (eight hundred)
"900" (nine hundred)
"Pound", (#)
"Number <0-9>"
"Asterisk" (*)
"Clear" (deletes all entered digits)
"Delete" (deletes one digit)
"Plus"
"Star"

Note: To exit dial mode, press and hold the phone button or any button on the audio unit.

"Menu"
"(Phone) connections"
"(Phone) settings (message) notification off"
"(Phone) settings (message) notification on"
"(Phone) settings (set) phone ringer"
"(Phone) settings (set) ringer 1"
"(Phone) settings (set) ringer 2"
"(Phone) settings (set) ringer 3"
"(Phone) settings (set) ringer off"
"Phone name"
"Text message inbox"

Words in parenthesis are optional and do not have to be spoken for the system to understand the command.

Making a Call

1. Press the voice button. When prompted, say, "call <name>" or "dial" followed by a number.
2. When the system confirms the number, say, "dial" again to initiate the call.

To erase the last spoken digit, say, "delete" or press the left arrow button on the audio unit. To erase all spoken digits, say "clear" or press and hold the left arrow button on the audio unit.

To end the call, press the end call button on the steering wheel or select the end call option in the audio display and press **OK**.

Receiving a Call

When receiving a call, you can:

- Answer the call by pressing the accept call button on the steering wheel or by selecting the accept call option in the audio display. Press the **OK** button.
- Reject the call by pressing the reject call button on the steering wheel or by selecting the reject call option in the audio display. Press the **OK** button.
- Ignore the call by doing nothing.

Cell Phone Options During an Active Call

During an active call, you have extra menu features that become available such as putting a call on hold and joining calls.

To access this menu, choose one of the options available at the bottom of the audio display or select the option for more.

When you select	You can
Mic. off	Turn off your vehicle's microphone. To turn the microphone on, select the option again.
Privacy	Switch a call from an active hands-free environment to your cell phone for a more private conversation. When selected, the audio display indicates the call is private.
Hold	Put an active call on hold. When selected, the audio display indicates the call is on hold.
Dial a number	Enter numbers using the audio system numeric keypad, for example numbers for passwords.
Join Calls	Join two separate calls. The system supports a maximum of three callers on a multi-party or conference call. 1. Select the option for more. 2. Access the desired contact through the system or use voice commands to place the second call. Once actively in the second call, select the option for more.

When you select	You can
	3. Scroll to the option to join calls and press the OK button.
Phonebook	Access your phonebook contacts. 1. Select the option for more. 2. Scroll to the option for phonebook and press the OK button. 3. Scroll through your phonebook contacts. 4. Press the OK button again when the desired selection appears in the audio display. 5. Press the OK button or dial button to call the selection.
Call History	Access your call history log. 1. Select the option for more. 2. Scroll to the option for call history and press the OK button. 3. Scroll through your call history options (incoming, outgoing or missed). 4. Press the OK button again when the desired selection appears in the audio display. 5. Press the OK button or dial button to call the selection.

Accessing Features Through the Cell Phone Menu

You can access your call history, phonebook, sent text messages as well as access cell phone and system settings.

1. Press the **PHONE** button to enter the cell phone menu.
2. Select one of the options available.

When you select	You can
Dial a number	Dial a number using the audio system numeric keypad.
Redial	Redial the last number called (if available). Press the OK button to select.
Phonebook*	Access your downloaded phonebook. 1. Press the OK button to confirm and enter. You can use the options at the bottom of the screen to access an alphabetical category quickly. You can also use the letters on the keypad to jump in the list. 2. Scroll through your phonebook contacts. 3. Press the OK button again when the desired selection appears in the audio display. 4. Press the OK button or dial button to call the selection.
Call History*	Access any previously dialed, received or missed calls.

When you select	You can
	<ol style="list-style-type: none"> 1. Press the OK button to select. 2. Scroll to select incoming calls, outgoing calls or missed calls. Press the OK button to make your selection. 3. Press the OK button or dial button to call the selection. The system attempts to automatically re-download your phonebook and call history each time your cell phone connects to the system. You must switch on the auto download feature if your cell phone supports it.
Speed Dial	Select one of 10 speed dial entries. To set a speed dial entry, go to the phonebook and press and hold one of the numbers on the audio system numeric keypad.
Text message*	Send, download and delete text messages.
BT Devices	Access the option for Bluetooth device menu listings (add, connect, set as primary, on or off, delete).
Phone settings *	View various settings and features on your cell phone.

* This is a cell phone dependent feature.

Text Messaging

Note: *This is a cell phone dependent feature.*

The system allows you to receive, send, download and delete text messages. The system can also read incoming text messages to you so that you do not have to take your eyes off the road.

Receiving a Text Message

Note: *Your cell phone must support downloading text messages using Bluetooth to receive incoming text messages.*

Note: *The system allows only one recipient per text message.*

When a new message arrives, an audible tone sounds and the audio display indicates you have a new message.

You have these options:

- Select the listen option to have the system read the message to you.
- Select the view option to open the text message. Select the ignore option or do nothing and the message goes into your text message inbox. Once selected, you have the ability to have the message read out to you, to view other messages or to select the more option.

- Press the voice button and say "Read text message".
- Select the more option and use the arrow buttons to scroll through further options. Choose from the following:
 - **Reply to sender:** Press the **OK** button to access and then scroll through the list of pre-defined messages to send.
 - **Call sender:** Press the **OK** button to call the sender of the message.
 - **Forward msg:** Press the **OK** button to forward the message to anyone in your phonebook or call history. You can also choose to enter a number.
- **Delete** allows you to delete current text messages from the system (not your cell phone). The audio display indicates when all your text messages have been deleted.
- **More** allows you to delete all messages or to trigger a download of all unread messages from your cell phone manually.

When you select the option to send a text message, a list of pre-defined messages appears in the audio display.

Sending a Text Message

1. Select the send option when the audio display highlights your desired selection.
2. Select the confirmation option when the contact appears and press the **OK** button again to confirm when the system asks if you would like to send the message. The system sends each text message with a pre-defined signature.

Note: *You can send text messages either by choosing a contact from the phonebook and selecting the text option from the audio display or by replying to a received message in the inbox.*

Accessing Your Cell Phone Settings

These are cell phone dependent features. Your cell phone settings allow you to access and adjust features such as your ringtone, text message notification, modify your phonebook and set up automatic download.

1. Press the **PHONE** button.
2. Scroll until the phone settings option appears, then press the **OK** button.
3. Scroll to select from the following options:

Sending, Downloading and Deleting Your Text Messages

1. Press the **PHONE** button.
2. Select the text messaging option, and then press the **OK** button.

A list of all available text messages appears.

You can choose from the following options:

- **New** allows you to send a new text message based on a pre-defined set of 15 messages.
- **View** allows you to read the full message and provides the option to have the message read out to you by the system. To go to the next message select the more option. This allows you to reply to the sender, call the sender or forward the message.

When you select	You can
Set as master	If this option is checked, the system will use this cell phone as the master when there is more than one cell phone paired to the system. This option can be changed for all paired cell phones (not only for the active one) using the Bluetooth devices menu.
Phone Status	See the cell phone name, provider name, cell phone number, signal level and battery level. When done, press the left arrow button to return to the cell phone status menu.
Set ringtone	Select which ringtone sounds during an incoming call (one of the system's or your cell phone's). 1. Press the OK button to select and scroll to hear each ringtone. 2. Press the OK button to select. If your cell phone supports in-band ringing, your cell phone's ringtone sounds when you choose the cell phone ringtone option.
Text msg notify	Have the option of hearing an audible tone to notify you when a text message arrives. Press the OK button to adjust the setting for the audible tone.
Phonebook pref.	Modify the contents of your phonebook (such as add, delete or download). Press the OK button to select and scroll between the settings: Add contacts: Press the OK button to add more contacts from your phonebook. Push the desired contacts on your cell phone. Refer to your device's manual on how to push contacts. Delete: Press the OK button to delete the current phonebook and call history. When a message asking you to delete appears, select the option to confirm. The system takes you back to the menu for phone settings. Download now: Press the OK button to select and download your phonebook to the system. Auto-download: Check or uncheck this option to download your phonebook each time your cell phone connects to the system. Downloading times are cell phone dependent and quantity dependent. When you switch on automatic downloading, the system deletes any changes, additions or deletions saved in the system since your last download.

When you select	You can
	<p>When you switch off automatic downloading, the system does not download your phonebook when your cell phone connects to the system.</p> <p>Your phonebook, call history and text messages can only be accessed when your paired cell phone is connected to the system.</p>

Bluetooth Devices

This menu provides access to your Bluetooth devices. Use the arrow buttons to scroll through the menu options. It allows you to add, connect and delete devices and set a cell phone as primary.

Bluetooth Devices Menu Options

1. Press the **PHONE** button.
2. Scroll until the Bluetooth device option appears, then press the **OK** button.
3. Scroll to select from the following options:

When you select	You can
Add	<p>Pair more cell phones to the system.</p> <ol style="list-style-type: none"> 1. Select the option to add to start the pairing process. 2. When a message to begin pairing appears in the audio display, search for SYNC on your cell phone. Refer to your device's manual if necessary. 3. When prompted on your cell phone's display, enter the six-digit PIN provided by the system in the audio display. The display indicates when the pairing is successful. 4. When the option to set the cell phone as the primary cell phone appears, select either yes or no. 5. Depending on the functionality of your cell phone, the system may ask you extra questions (for example, if you would like to download your phonebook). Select either yes or no to confirm your response.
Delete	<p>Delete a paired cell phone.</p> <p>Select the delete option and confirm when the system asks to delete the selected device. After deleting a cell phone from the list, you need to repeat the full pairing process to connect a phone.</p>
Master	<p>Set a previously paired cell phone as your primary cell phone.</p> <p>Select the master option to confirm the primary cell phone.</p>

SYNC™

When you select	You can
	The system attempts to connect with the primary cell phone every time you switch on the ignition. When you select a cell phone as primary, it appears first in the list and marked with an asterisk.
Conn.	Connect a previously paired cell phone. You can only have one cell phone connected at a time to use the cell phone functionality. When another cell phone is connected, the system disconnects the previous cell phone from the telephone services. The system allows you to use different Bluetooth devices for the cell phone functionality and the Bluetooth audio music playback feature at the same time. Select this option to connect to the selected previously paired cell phone.
Discon.	Disconnects the selected cell phone. Select this option and confirm when asked to. After disconnecting a cell phone, you can reconnect it without repeating the full pairing process.

System Settings

1. Press the **MENU** button.

2. Select the SYNC settings option, and then press the **OK** button.

When you select	You can
Bluetooth on	Check or uncheck this option to turn the Bluetooth interface of the system on or off. Select this option then press the OK button to change the option's status.
Set defaults	Return to the factory default settings. This selection does not erase your indexed information (phonebook, call history, text messages and paired devices). Select this option and confirm when Set defaults? appears in the audio display.
Master reset	Completely erase all information stored on the system (phonebook, call history, text messages and paired devices) and return to the factory default settings. Select this option and confirm when Master reset? appears in the audio display. The display indicates when complete and the system takes you back to the SYNC-Settings menu.
Install on SYNC	Install applications or software updates you have downloaded.

When you select	You can
	Select this option and confirm when Install on SYNC appears in the audio display. There must be a valid SYNC application or update available on the USB thumb drive in order to finish an installation successfully.
System info	Display the system's version numbers as well as its serial number. Press the OK button to select.
Voice settings	The voice settings submenu contains various options. See Using Voice Recognition (page 178).
Browse USB	Browse the actual menu structure of the connected USB device. Press the OK button and use the up or down arrows to scroll through the folders and files. Use the left or right arrows to enter and leave a folder. You can directly select media content for playback from this menu.

SYNC™ APPLICATIONS AND SERVICES

1. Press the **MENU** button to enter the system's menu.
2. Scroll to **SYNC Applications**, and then press **OK**.

A list of available applications appears. Each application might have its own specific settings.

SYNC Emergency Assistance

WARNINGS



For this feature to work, your cell phone must have Bluetooth and be compatible with the system.



Always place your cell phone in a secure location inside your vehicle. Failure to do so may cause serious injury to someone or damage the cell phone which could prevent this feature from working correctly.

WARNINGS



Unless the feature setting is switched on prior to a crash, the system will not attempt to place an emergency call which could delay the response time, potentially increasing the risk of serious injury or death. Do not wait for the system to make an emergency call if you can do it yourself. Dial emergency services immediately to avoid a delayed response time. If you do not hear Emergency Assistance within five seconds of the crash, the system or cell phone may be damaged or non-functional.

Note: Before selecting this feature, you must read the Emergency Assistance privacy notice later in this section for important information.

Note: When you switch this feature on or off, that setting applies for all paired cell phones. If you have turned this feature off and a previously paired phone connects when you switch on the ignition, either a voice message plays, a display message or icon is shown or both.

Note: Every cell phone operates differently. While this feature works with most cell phones, some cell phones may experience difficulties using this feature.

Note: Make sure you are familiar with the information about airbag deployment. See **Supplementary Restraints System** (page 28).

If a crash deploys an airbag or triggers the fuel pump shut off, the system may contact emergency services by dialing 112 (the wireless emergency number that works in most European countries) through a paired and connected cell phone. For more information about the system and Emergency Assistance, visit the regional Ford website.

Switching Emergency Assistance On and Off

1. Press the **MENU** button.
2. Select the **SYNC Applications** option and press **OK**.
3. Select the **Emergency Assistance** option and press **OK**.
4. Select the option you require and press **OK**.

Note: Some versions of SYNC may operate differently. Press the **PHONE** button instead of the **MENU** button to access the Emergency Assistance menu.

Display Options

If you switch on this feature, a confirmation message appears in the display.

If you switch off this feature, a dialog will appear in the display, which allows you to set a voice reminder.

Off with voice reminder provides a display and voice reminder when your cell phone connects and your vehicle starts.

Off without voice reminder provides a display reminder only without a voice reminder when your cell phone connects.

To make sure that Emergency Assistance works correctly:

- The system must have power and be working correctly at the time of the crash and during feature activation and use.
- You must switch on the feature before a crash.
- You must have a cell phone connected to the system.
- In certain countries, it may be necessary to have a valid and registered SIM card with credit in order to place and maintain an emergency call.
- A connected cell phone must have the ability to make and maintain an outgoing call at the time of the crash.
- A connected cell phone must have adequate network coverage, battery power and signal strength.
- Your vehicle must have battery power.

Note: This feature only works in a European country or region where SYNC Emergency Assistance can call the local emergency services. Visit the regional Ford website for details.

In the Event of a Crash

Note: Not every crash deploys an airbag or triggers the fuel pump shut off (which may turn on Emergency Assistance). However, if Emergency Assistance is triggered the system tries to contact the emergency services. If a connected cell phone sustains damage or loses connection to the system, it searches for and tries to connect to any available previously paired cell phone. The system attempts to dial 112.

Before making a call:

- If you do not cancel the call and SYNC makes a successful call, an introductory message plays for the emergency operator. After this message, there is hands-free communication between your vehicle's occupants and the operator.
- The system provides a short window of time (approximately 10 seconds) to cancel the call. If you do not cancel the call, the system attempts to dial 112.
- The system plays a message letting you know when it attempts to make an emergency call. You can cancel the call by selecting the relevant function button or by pressing the end call button on the steering wheel.

During a call:

- Emergency Assistance uses your vehicle GPS or cellular network information when available to determine the most appropriate language to use. It alerts the emergency operator of the crash and delivers the introductory message. This may include your vehicle GPS coordinates.
- The language the system uses to interact with the occupants of your vehicle may differ from the language used to deliver information to the emergency operator.
- After the delivery of the introductory message the voice line opens so that you can speak hands-free with the emergency operator.
- When the line is connected, you must be prepared to provide your name, phone number and location information immediately.

Note: While the system provides information to the emergency operator, the system plays a message letting you know it is sending important information. It then lets you know when the line is open to start hands-free communication.

Note: During an Emergency Assistance call, an emergency priority screen appears which contains vehicle GPS coordinates when available.

Note: It is possible that GPS location information is not available at the time of the crash; in this case, Emergency Assistance will still attempt to place an emergency call.

Note: It is possible that the emergency services will not receive the GPS coordinates; in this case, hands-free communication with an emergency operator is available.

Note: The emergency operator may also receive information from the cellular network such as cell phone number, cell phone location and cell phone carrier name independent from SYNC Emergency Assistance.

Emergency Assistance may not work if:

- Your cell phone or Emergency Assistance hardware sustains damage in the crash.
- The vehicle battery or the system has no power.
- A crash ejects your cell phone from your vehicle.
- You do not have a valid and registered SIM card with credit in your cell phone.
- You are in a European country or region where the SYNC Emergency Assistance cannot place the call. Visit the regional Ford website for details.

Important Information about the Emergency Assistance Feature

Emergency Assistance does not currently call emergency services in the following markets: Albania, Belarus, Bosnia and Herzegovina, Macedonia, Netherlands, Ukraine, Moldova and Russia.

Visit the regional Ford website for latest details.

Emergency Assistance Privacy Notice

When you switch on Emergency Assistance, it may disclose to emergency services that your vehicle has been in a crash involving the deployment of an airbag or activation of the fuel pump shut off. This feature has the capability to disclose your location information to the emergency operator or other details about your vehicle or crash to provide the most appropriate emergency services.

If you do not want to disclose this information, do not switch on the feature.

SYNC AppLink

The system enables voice and manual control of SYNC AppLink enabled smartphone apps. Once an app is running through AppLink, you can control main features of the app through voice commands and manual controls.

Note: You must pair and connect your smartphone to SYNC to access AppLink.

Note: iPhone users need to connect the phone to the USB port.

Note: Android users need to connect the phone to SYNC using Bluetooth.

Note: For information on available apps, supported smartphone devices and troubleshooting tips please visit the Ford website.

Note: Make sure you have an active account for the app that you have downloaded. Some apps will work automatically with no setup. Other apps will want you to configure your personal settings and personalize your experience by creating stations or favorites. We recommend you do this at home or outside of your vehicle.

To Access Using the SYNC Menu

1. Press the **MENU** button to access the menu on-screen.
2. Select **SYNC Applications**.
3. Select **Mobile Apps**.
4. Scroll through the list of available applications and press **OK** to select a particular app or select **Find New Apps**.

Note: If a SYNC AppLink compatible app cannot be found, make sure the required app is running on the mobile device.

5. Once an app is running through SYNC, press the right arrow button to access the app menu.
6. You can access various app features from here, for example thumbs up and thumbs down.
7. Press the left arrow button to exit the app menu.

To Access Using Voice Commands

1. Press the voice button.
2. When prompted, say "Mobile Apps".
3. Say the name of the application after the tone.
4. The application will start. While an app is running through SYNC, you can press the voice button and speak commands specific to the app, for example "Play Playlist Road Trip". Say "Help" to discover the available voice commands.

The following voice commands are always available:

- "Mobile Apps" - the system will prompt you to say the name of the app to start it.
- "List Mobile Apps" - the system will list all of the currently available mobile apps.
- "Find New Apps" - the system will search your connected mobile device for SYNC compatible apps.
- "<the name of the app>" - say the name of an app to start it on SYNC.
- "<the name of the app> Help" - the system will list the available voice commands for the requested app.

Enabling and Disabling Push Notifications

Some apps can send push notifications. A push notification is an alert from an app running in the background and is delivered by voice, pop up or both. This may be particularly useful for news or location based apps.

1. Press the **MENU** button to access the SYNC menu.
2. Select **SYNC Applications**.
3. Select **Mobile Apps**.
4. Select **Settings**.
5. Select the required app or **All Apps**.
6. If push notifications are supported this setting will be listed. Select to enable or disable the feature as required.

Enabling SYNC Mobile Apps

To use the system you must consent to send and receive app authorization information and updates, using the data plan associated with the connected device.

Data is sent to Ford in the United States through the connected device. The information is encrypted and includes your VIN, SYNC module number, anonymous usage statistics and debugging information. Updates may take place automatically.

Note: *You must enable mobile apps for each connected device the first time you select a mobile app using the system.*

Note: *Standard data rates will apply. Ford is not responsible for any additional charges you may receive from your service provider, when your vehicle sends or receives data through the connected device. This includes any additional charges incurred due to driving in areas when roaming out of a home network.*

App Status

You can view the current status of an app in the settings menu.

There are three possible statuses:

- **Update Needed** - the system has detected a new app requiring authorization or a general permissions update is required.
- **Up-To-Date** - no update is required.
- **Updating...** - the system is trying to receive an update.

If an update is required and you want to manually request this update, for example when in a Wi-Fi hotspot, select **Request Update** in the settings menu.

You can disable automatic updates by selecting **Disable Updates** in the settings menu.

App Permissions

Permissions are divided by groups. You can grant these group permissions individually. You can change a permission group status any time when not driving, by using the settings menu.

When you launch an app using SYNC, the system may ask you to grant certain permissions, for example:

- To allow your vehicle to provide vehicle information to the app including, but not limited to: Fuel level, fuel consumption, engine speed, battery voltage, odometer, VIN, external temperature, gear position, tire pressure, ambient temperature, date and time.
- To allow your vehicle to provide driving characteristic information, including, but not limited to: MyKey, seat belt status, engine speeds, braking events, brake pedal switch, acceleration, accelerator pedal position, clutch pedal switch, trip length, trip time, trip cost, percent engine on time, and percent of time at speed.
- To allow your vehicle to provide location information, including: GPS and speed.
- To allow the app to send push notifications using the vehicle display and voice capabilities while running in a background state.

Note: *You will only need to grant permissions the first time you use an app with SYNC.*

Note: *We are not responsible or liable for any damages or loss of privacy relating to usage of an app, or dissemination of any vehicle data that you approve us to provide to an app.*

USING SYNC™ WITH YOUR MEDIA PLAYER

You can access and play music from your media player through your vehicle's speaker system using the system's media menu or voice commands. You can also sort and play your music by specific categories such as artist or albums.

SYNC is capable of hosting nearly any media player including: iPod, Zune, Plays from device players, and most USB drives. SYNC also supports audio formats such as MP3, WMA, WAV and ACC.

Connecting Your Media Player to the USB Port

Note: *If your media player has a power switch, make sure you switch on the device.*

To Connect Using Voice Commands

1. Plug the device into your vehicle's USB port.
2. Press the voice button and when prompted, say "USB".
3. You can now play music by saying any of the appropriate voice commands. Refer to the media voice commands.

To Connect Using the System Menu

1. Plug the device into your vehicle's USB port.
2. Press the **AUX** button until an initializing message appears in the display.
3. Depending on how many media files are on your connected device, an indexing message may appear in the display. When indexing is complete, the screen returns to the **Play** menu.

Press **Browse**. Now you can scroll through the list:

- **Play all.**
- **Playlists.**
- **Songs.**
- **Artists.**
- **Albums.**
- **Genres.**
- **Browse USB.**
- **Reset USB.**
- **Exit.**

What's Playing?

At any time during playback, you can press the voice button and ask the system what is playing. The system reads the metadata tags (if populated) of the current track.

Media Voice Commands



Press the voice button and when prompted say "USB", and then any of the following:

"USB"	
"Pause"	"Play track <name>" ^{1,2}
"Play"	"Repeat off"
"Play album <name>" ^{1,2}	"Repeat on"
"Play All"	"Search album <name>" ^{1,2}
"Play artist <name>" ^{1,2}	"Search artist <name>" ^{1,2}
"Play genre <name>" ^{1,2}	"Search genre <name>" ¹
"Play next folder" ³	"Search song <name>" ¹
"Play next track"	"Search track <name>" ^{1,2}
"Play playlist <name>" ^{1,2}	"Shuffle off"
"Play previous folder" ³	"Shuffle on"
"Play previous track"	"Similar music"
"Play song <name>" ¹	"What's playing?"

¹ <name> is a dynamic listing, meaning that it could be the name of anything such as desired group, artist or song.

² Voice commands that are not available until indexing is complete.

³ Voice commands that are only available in folder mode.

Voice command guide	
"Search genre" or "Play genre"	The system searches all the data from your indexed music and if available, begins to play the chosen type of music. You can only play genres of music that are present in the genre metadata tags that you have on your media player.
"Similar music"	The system compiles a playlist and then plays similar music to what is currently playing from the USB port using indexed metadata information.
Search or Play, "Artist", "Track, or "Album"	The system searches for a specific artist, track or album from the music indexed through the USB port.

The system is also capable of playing music from your cell phone via Bluetooth.

To switch on the Bluetooth audio, use the **AUX** or **Source** button or press the voice button. When prompted say, "Bluetooth audio", then any of the following:

"Bluetooth Audio"
"Connections"
"Pause"
"Play"
"Play next track"
"Play previous track"

Media Menu Features

The media menu allows you to select how to play your music (such as by artist, genre, shuffle or repeat) and to find similar music or reset the index of your USB devices.

1. Press **AUX** to select USB playback and then **Options** to enter the **Media** menu.
2. Scroll to cycle through:

SYNC™

When you select	You can
Shuffle playlist and Repeat track	Choose to shuffle or repeat your music. Once you make your choice, it remains on until you switch it off.
Similar music	You can play similar types of music to the current playlist from the USB port. The system uses the metadata information of each track to compile a playlist. The system then creates a new list of similar tracks and then begins playing. Each track must have the metadata tags populated for this feature. With certain playing devices, if your metadata tags are not populated, the tracks will not be available in voice recognition, play menu or similar music. However, if you place these tracks onto your playing device in mass storage device mode they are available in voice recognition, Play menu browsing and Similar Music. The system places Unknowns into any unpopulated metadata tag.
Reset SYNC USB	Resets the USB index. After the new indexing is complete you can choose what to play from the USB song library.

Accessing Your USB Song Library

This menu allows you to select and play your media files by artist, album, genre, playlist and track or even to browse what is on your USB device.

1. Make sure you plug your device into your vehicle's USB port and switch it on.
2. Press **AUX** to select USB playback and then **Browse**.

If there are no media files to access, the display indicates there is no media. If there are media files, you have the following options to scroll through and select:

When you select	You can
Play all	Play all indexed media files from your playing device one at a time in numerical order.* Press OK to select. The first track title appears in the display.
Playlists	Access your playlists (from formats such as .ASX, .M3U, .WPL or .MTP).* 1. Press OK to select. 2. Scroll to select the desired playlist, and then press OK .
Songs	Search for and play a specific indexed track.* 1. Press OK to select.

SYNC™

When you select	You can
	2. Scroll to select the desired track, and then press OK .
Artists	Sort all indexed media files by artist. Once selected, the system lists and then plays all artists and tracks alphabetically.* 1. Press OK to select. 2. Scroll to select the desired artist, and then press OK .
Albums	Sort all indexed media files by albums.* 1. Press OK to select. 2. Scroll to select the desired albums, and then press OK .
Genres	Sort indexed music by genre (category) type.* 1. Press OK to select. 2. Scroll to select the desired genre, and then press OK .
Browse USB	Browse all supported media files on your media player connected to the USB port. You can only view media files that are compatible with SYNC; other saved files are not visible. 1. Press OK to select. 2. Scroll to browse indexed media files on your flash drive, and then press OK .
Reset USB	Resets the USB index. After the new indexing is complete, you can choose what to play from the USB song library.

* You can use the buttons at the bottom of the audio display to jump to a certain alphabetical category quickly. You can also use the letters on the numeric keypad to jump in the list.

Bluetooth Devices and System Settings

You can access these menus using the audio display. See **Using SYNC™ With Your Phone** (page 181).

SYNC™ TROUBLESHOOTING

Your SYNC system is easy to use. However, should questions arise, please refer to the tables below.

To check your cell phone's compatibility, visit the regional Ford website.

SYNC™

Cell phone issues		
Issue	Possible cause	Possible solution
A lot of background noise during a phone call.	The audio control settings on your cell phone may be affecting SYNC performance.	Refer to your device's manual about audio adjustments.
During a call, I can hear the other person but they cannot hear me.	Possible cell phone malfunction.	Try switching off your cell phone, resetting it or removing the battery, then trying again. Make sure that the microphone for SYNC is not set to off.
SYNC is not able to download my phonebook.	This is a cell phone-dependent feature.	Check your cell phone's compatibility.
	Possible cell phone malfunction.	Try switching off your cell phone, resetting it or removing the battery, then trying again.
		Try pushing your phonebook contacts to SYNC by selecting the option to add.
		You must switch on your cell phone and the automatic phonebook download feature on SYNC.
The system says "Phonebook downloaded" but my SYNC phonebook is empty or is missing contacts.	Limitations on your cell phone's capability.	Try pushing your phonebook contacts to SYNC by selecting the option to add.
		If the missing contacts are stored on your SIM card, try moving them to your cell phone's memory.
		Remove any pictures or special ring tones associated with the missing contact.
		You must switch on your cell phone and the automatic phonebook download feature on SYNC.
I am having trouble connecting my cell phone to SYNC.	This is a cell phone-dependent feature.	Check your cell phone's compatibility.
	Possible cell phone malfunction.	Try switching off your cell phone, resetting it or removing the battery, then trying again.

SYNC™

Cell phone issues		
Issue	Possible cause	Possible solution
		Try deleting your device from SYNC and deleting SYNC from your device, then trying again.
		Always check the security and auto accept prompt settings relative to the SYNC Bluetooth connection on your cell phone.
		Update your cell phone's firmware.
		Switch off the auto download setting.
Text messaging is not working on SYNC.	This is a cell phone-dependent feature.	Check your cell phone's compatibility.
	Possible cell phone malfunction.	Try switching off your cell phone, resetting it or removing the battery, then trying again.
Audible text messages do not work on my cell phone.	This is a cell phone-dependent feature.	Your cell phone must support downloading text messages through Bluetooth to receive incoming text messages.
		Access the text messaging menu of SYNC to see if your cell phone supports the feature. Press the PHONE button and then scroll and select the option for text messaging, then press OK .
	This is a cell phone limitation.	Because each cell phone is different, refer to your device's manual for the specific cell phone you are pairing. In fact, there can be differences between cell phones due to brand, model, service provider and software version.

USB and media issues		
Issue	Possible cause	Possible solution
I am having trouble connecting my device.	Possible device malfunction.	Try switching off the device, resetting it or removing the battery, then trying again.
		Make sure you are using the manufacturer's cable.
		Make sure correctly insert the USB cable to the device and your vehicle's USB port.
		Make sure that the device does not have an auto-install program or active security settings.
SYNC does not recognize my device when I start my vehicle.	This is a device limitation.	Make sure you are not leaving the device in your vehicle during very hot or cold temperatures.
Bluetooth audio does not stream.	This is a device-dependent feature.	Make sure you connect the device to SYNC and press play on your device.
	The device is not connected.	
SYNC does not recognize music that is on my device.	Your music files may not contain the correct artist, song title, album or genre information.	Make sure that all song details are populated.
	The file may be corrupted.	Try replacing the corrupt file with a new version.
	The song may have copyright protection that does not allow it to play.	Some devices require you to change the USB settings from mass storage to media transfer protocol class.
When I connect my iPhone or iPod Touch through the USB and Bluetooth Audio at the same time, I sometimes do not hear any sound.	This is a device limitation.	From the iPhone or iPod Touch music now playing screen, select the audio device airplay icon at the very bottom of your iPhone or iPod Touch screen.
		To listen to the iPhone or iPod Touch through Bluetooth Audio, select SYNC.
		To listen to the iPhone or iPod Touch through USB, select Dock Connector.

Voice command issues		
Issue	Possible cause	Possible solution
SYNC does not understand what I am saying.	You may be using the wrong voice commands.	Review the cell phone voice commands and the media voice commands at the beginning of their respective sections.
		Refer to the audio display during an active voice session to find a list of voice commands there.
	You may be speaking too soon or at the wrong time.	The microphone for the system is either in your rear view mirror or in the headliner just above the windshield.
SYNC does not understand the name of a song or artist.	You may be using the wrong voice commands.	Review the media voice commands at the beginning of the media section.
	You may not be saying the name exactly as the system saved it.	Say the song or artist exactly as the system saved it. If you say, "Play Artist Prince", the system does not play music by Prince and the Revolution or Prince and the New Power Generation.
		Make sure you are saying the complete title such as "California remix featuring Jennifer Nettles".
	If the song titles are in capital letters, you have to spell them. LOLA requires you to say "L-O-L-A".	
	The system may not be reading the name the same way you are saying it.	Do not use special characters in the title, as the system does not recognize them.
SYNC does not understand or is calling the wrong contact when I want to make a call.	You may be using the wrong voice commands.	Review the cell phone voice commands at the beginning of the cell phone section.
		You can also use the cell phone and media suggestion lists to get a list of possible suggestions when the system cannot fully understand you. See Using Voice Recognition (page 178).

SYNC™

Voice command issues		
Issue	Possible cause	Possible solution
	You may not be saying the name exactly as the system saved it.	Make sure you are saying the name exactly as the system saved it. For example, if the contact name is Joe Wilson, say "Call Joe Wilson".
		The system works better if you list full names such as "Joe Wilson" rather than "Joe".
	Contacts in your phonebook may be very short and similar or they may contain special characters.	Do not use special characters such as 123 or ICE as the system does not recognize them.
	Your phonebook contacts may be in capital letters.	If the contacts are in capital letters, you have to spell them. JAKE requires you to say "Call J-A-K-E".
The SYNC voice control system is having trouble recognizing foreign names stored on my cell phone.	You may be saying the foreign names using the currently selected language for SYNC.	<p>SYNC applies the phonetic pronunciation rules of the selected language to the contact names stored on your cell phone.</p> <p>Helpful Hint: You can select your contact manually. Press PHONE. Select the option for phonebook and then contact name. Press the soft-key option to hear it. SYNC will read the contact name to you, giving you some idea of the pronunciation it is expecting.</p>
The SYNC voice control system is having trouble recognizing foreign tracks, artists, albums, genres and playlist names from my media player or USB flash drive.	You may be saying the foreign names using the currently selected language for SYNC.	<p>SYNC applies the phonetic pronunciation rules of the selected language to the names stored on your media player or USB flash drive. It is able to make some exceptions for very popular artist names (for example, U2) such that you can always use the English pronunciation for these artists.</p>

SYNC™

Voice command issues		
Issue	Possible cause	Possible solution
The system generates voice prompts and the pronunciation of some words may not be accurate for my language.	SYNC uses text-to-speech voice prompt technology.	SYNC uses a synthetically generated voice rather than pre-recorded human voice.
		SYNC offers several new voice control features for a wide range of languages. Dialing a contact name directly from the phonebook without pre-recording (for example, "call John Smith") or selecting a track, artist, album, genre or playlist directly from your media player (for example, "play artist Madonna).
My previous Bluetooth voice control system allowed me to control the radio, CD, and climate control systems. Why can I not control these systems with SYNC?	The focus of SYNC is to control your mobile devices and the content stored on them.	SYNC offers significant capability beyond the previous system such as dialing a contact name directly from the phonebook without pre-recording (for example, "call John Smith") or selecting a track, artist, album, genre or playlist directly from your media player (for example, "play artist Madonna).

SYNC™

General		
Issue	Possible cause	Possible solution
The language selected for the instrument cluster and information and entertainment display does not match the SYNC language (phone, USB, Bluetooth audio, voice control and voice prompts).	SYNC does not support the currently selected language for the instrument cluster and information and entertainment display.	SYNC only supports four languages in a single module for text display, voice control and voice prompts. The country where you bought your vehicle dictates the four languages based on the most popular languages spoken. If the selected language is not available, SYNC remains in the current active language.
		SYNC offers several new voice control features for a wide range of languages. Dialing a contact name directly from the phonebook without pre-recording (for example, "call John Smith") or selecting a track, artist, album, genre or playlist directly from your media player (for example, play artist Madonna).

Appendices

ELECTROMAGNETIC COMPATIBILITY

WARNINGS

 Your vehicle has been tested and certified to legislation relating to electromagnetic compatibility (72/245/EEC, UN ECE Regulation 10 or other applicable local requirements). It is your responsibility to make sure that any equipment you have fitted complies with applicable local legislation. Have any equipment fitted by an authorized dealer.

 Radio frequency transmitter equipment (e.g. cell phones, amateur radio transmitters etc.) may only be fitted to your vehicle if they comply with the parameters shown in the table below. There are no special provisions or conditions for installations or use.

WARNINGS

 Do not mount any transceiver, microphones, speakers, or any other item in the deployment path of the airbag system.

 Do not fasten antenna cables to original vehicle wiring, fuel pipes and brake pipes.

 Keep antenna and power cables at least 4 inches (10 centimeters) from any electronic modules and airbags.

Note: *Only fit antennae in the positions shown to the roof of your vehicle.*

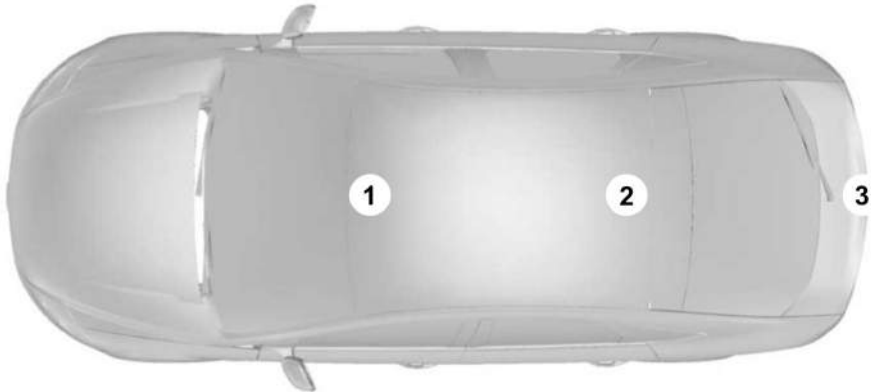

E170906

Appendices

Frequency Band MHz	Maximum output power Watt (Peak RMS)	Antenna Positions
1 – 30	50 W	2, 3
30 – 54	50 W	1, 2
68 – 87.5	50 W	1, 2
142 – 176	50 W	1, 2
380 – 512	50 W	1, 2
806 – 940	10 W	1, 2
1200 – 1400	10 W	1, 2
1710 – 1885	10 W	1, 2
1885 – 2025	10 W	1, 2

Note: After the installation of radio frequency transmitters, check for disturbances from and to all electrical equipment in your vehicle, both in the standby and transmit modes.

Check all electrical equipment:

- with the ignition on
- with the engine running
- during a road test at various speeds.

Check that electromagnetic fields generated inside your vehicle cabin by the transmitter installed do not exceed applicable human exposure requirements.

END USER LICENSE AGREEMENT

SYNC® End User License Agreement (EULA)

- You have acquired a device ("DEVICE") that includes software licensed by Ford Motor Company and its affiliates ("FORD MOTOR COMPANY") from an affiliate of Microsoft Corporation ("MS"). Those installed software products of MS origin, as well as associated media, printed materials,

Appendices

and "online" or electronic documentation ("MS SOFTWARE") are protected by international intellectual property laws and treaties. The MS SOFTWARE is licensed, not sold. All rights reserved.

- The MS SOFTWARE may interface with and/or communicate with, or may be later upgraded to interface with and/or communicate with additional software and/or systems provided by FORD MOTOR COMPANY. The additional software and systems of FORD MOTOR COMPANY origin, as well as associated media, printed materials, and "online" or electronic documentation ("FORD SOFTWARE") are protected by international intellectual property laws and treaties. The FORD SOFTWARE is licensed, not sold. All rights reserved.
- The MS SOFTWARE and/or FORD SOFTWARE may interface with and/or communicate with, or may be later upgraded to interface with and/or communicate with additional software and/or systems provided by third party software and service suppliers. The additional software and services of third party origin, as well as associated media, printed materials, and "online" or electronic documentation ("THIRD PARTY SOFTWARE") are protected by international intellectual property laws and treaties. The THIRD PARTY SOFTWARE is licensed, not sold. All rights reserved.
- The MS SOFTWARE, FORD SOFTWARE and THIRD PARTY SOFTWARE hereinafter collectively and individually will be referred to as "SOFTWARE".

IF YOU DO NOT AGREE TO THIS END USER LICENSE AGREEMENT ("EULA") DO NOT USE THE DEVICE OR COPY THE SOFTWARE. ANY USE OF THE SOFTWARE, INCLUDING BUT NOT LIMITED TO USE ON THE DEVICE, WILL CONSTITUTE YOUR AGREEMENT TO THIS EULA (OR RATIFICATION OF ANY PREVIOUS CONSENT).

GRANT OF SOFTWARE LICENSE: This EULA grants you the following license:

- You may use the SOFTWARE as installed on the DEVICE and as otherwise interfacing with systems and/or services provide by or through FORD MOTOR COMPANY or its third party software and service providers.

Description of Other Rights and Limitations

- **Speech Recognition:** If the SOFTWARE includes speech recognition component(s), you should understand that speech recognition is an inherently statistical process and that recognition errors are inherent in the process. Neither FORD MOTOR COMPANY nor its suppliers shall be liable for any damages arising out of errors in the speech recognition process.
- **Limitations on Reverse Engineering, Decompilation and Disassembly:** You may not reverse engineer, decompile, or disassemble nor permit others to reverse engineer, decompile or disassemble the SOFTWARE, except and only to the extent that such activity is expressly permitted by applicable law notwithstanding this limitation.

Appendices

- **Limitations on Distributing, Copying, Modifying and Creating Derivative Works:** You may not distribute, copy, make modifications to or create derivative works based on the SOFTWARE, except and only to the extent that such activity is expressly permitted by applicable law notwithstanding this limitation.
- **Single EULA:** The end user documentation for the DEVICE and related systems and services may contain multiple EULAs, such as multiple translations and/or multiple media versions (e.g., in the user documentation and in the software). Even if you receive multiple EULAs, you are licensed to use only one (1) copy of the SOFTWARE.
- **SOFTWARE Transfer:** You may permanently transfer your rights under this EULA only as part of a sale or transfer of the DEVICE, provided you retain no copies, you transfer all of the SOFTWARE (including all component parts, the media and printed materials, any upgrades, and, if applicable, the Certificate(s) of Authenticity), and the recipient agrees to the terms of this EULA. If the SOFTWARE is an upgrade, any transfer must include all prior versions of the SOFTWARE.
- **Termination:** Without prejudice to any other rights, FORD MOTOR COMPANY or MS may terminate this EULA if you fail to comply with the terms and conditions of this EULA.
- **Security Updates/Digital Rights Management:** Content owners use the WMDRM technology included in your DEVICE to protect their intellectual property, included copyrighted content. Portions of the SOFTWARE on your DEVICE use WMDRM software to access WMDRM-protected content. If the WMDRM software fails to protect the

content, content owners may ask Microsoft to revoke the SOFTWARE's ability to use WMDRM to play or copy protected content. This action does not affect unprotected content. When your DEVICE downloads licenses for protected content, you agree that Microsoft may include a revocation list with the licenses. Content owners may require you to upgrade the SOFTWARE on your DEVICE to access their content. If you decline an upgrade, you will not be able to access content that requires the upgrade.

- **Consent to Use of Data:** You agree that MS, Microsoft Corporation, FORD MOTOR COMPANY, third party software and systems suppliers, their affiliates and/or their designated agent may collect and use technical information gathered in any manner as part of product support services related to the SOFTWARE or related services. MS, Microsoft Corporation, FORD MOTOR COMPANY, third party software and services suppliers, their affiliates and/or their designated agent may use this information solely to improve their products or to provide customized services or technologies to you. MS, Microsoft Corporation, FORD MOTOR COMPANY, third party software and systems suppliers, their affiliates and/or their designated agent may disclose this information to others, but not in a form that personally identifies you.

Appendices

- **Internet-Based Services Components:** The SOFTWARE may contain components that enable and facilitate the use of certain Internet-based services. You acknowledge and agree that MS, Microsoft Corporation, FORD MOTOR COMPANY, third party software and service suppliers, their affiliates and/or their designated agent may automatically check the version of the SOFTWARE and/or its components that you are utilizing and may provide upgrades or supplements to the SOFTWARE that may be automatically downloaded to your DEVICE.
- **Additional Software/Services:** The SOFTWARE may permit FORD MOTOR COMPANY, third party software and service suppliers, MS, Microsoft Corporation, their affiliates and/or their designated agent to provide or make available to you SOFTWARE updates, supplements, add-on components, or Internet-based services components of the SOFTWARE after the date you obtain your initial copy of the SOFTWARE ("Supplemental Components").

If FORD MOTOR COMPANY or third party software and services suppliers provide or make available to you Supplemental Components and no other EULA terms are provided along with the Supplemental Components, then the terms of this EULA shall apply.

If MS, Microsoft Corporation, their affiliates and/or their designated agent make available Supplemental Components, and no other EULA terms are provided, then the terms of this EULA shall apply, except that the MS, Microsoft Corporation or affiliate entity providing the Supplemental Component(s) shall be the licensor of the Supplemental Component(s).

FORD MOTOR COMPANY, MS, Microsoft Corporation, their affiliates and/or their designated agent reserve the right to discontinue without liability any Internet-based services provided to you or made available to you through the use of the SOFTWARE.

- **Links to Third Party Sites:** The MS SOFTWARE may provide you with the ability to link to third party sites through the use of the SOFTWARE. The third party sites are not under the control of MS, Microsoft Corporation, their affiliates and/or their designated agent. Neither MS nor Microsoft Corporation nor their affiliates nor their designated agent are responsible for (i) the contents of any third party sites, any links contained in third party sites, or any changes or updates to third party sites, or (ii) webcasting or any other form of transmission received from any third party sites. If the SOFTWARE provides links to third party sites, those links are provided to you only as a convenience, and the inclusion of any link does not imply an endorsement of the third party site by MS, Microsoft Corporation, their affiliates and/or their designated agent.
- **Obligation to Drive Responsibly:** You recognize your obligation to drive responsibly and keep attention on the road. You will read and abide with the DEVICE operating instructions particularly as they pertain to safety and assumes any risk associated with the use of the DEVICE.

UPGRADES AND RECOVERY MEDIA: If the SOFTWARE is provided by FORD MOTOR COMPANY separate from the DEVICE on media such as a ROM chip, CD ROM disk(s) or via web download or other means, and is labeled "For Upgrade Purposes Only" or "For Recovery Purposes Only" you may install one (1) copy of such

Appendices

SOFTWARE onto the DEVICE as a replacement copy for the existing SOFTWARE, and use it in accordance with this EULA, including any additional EULA terms accompanying the upgrade SOFTWARE.

INTELLECTUAL PROPERTY RIGHTS:

All title and intellectual property rights in and to the SOFTWARE (including but not limited to any images, photographs, animations, video, audio, music, text and "applets" incorporated into the SOFTWARE), the accompanying printed materials, and any copies of the SOFTWARE, are owned by MS, Microsoft Corporation, FORD MOTOR COMPANY, or their affiliates or suppliers. The SOFTWARE is licensed, not sold. You may not copy the printed materials accompanying the SOFTWARE. All title and intellectual property rights in and to the content which may be accessed through use of the SOFTWARE is the property of the respective content owner and may be protected by applicable copyright or other intellectual property laws and treaties. This EULA grants you no rights to use such content. All rights not specifically granted under this EULA are reserved by MS, Microsoft Corporation, FORD MOTOR COMPANY, third party software and service providers, their affiliates and suppliers. Use of any on-line services which may be accessed through the SOFTWARE may be governed by the respective terms of use relating to such services. If this SOFTWARE contains documentation that is provided only in electronic form, you may print one copy of such electronic documentation.

EXPORT RESTRICTIONS: You acknowledge that the SOFTWARE is subject to U.S. and European Union export jurisdiction. You agree to comply with all applicable international and national laws that apply to the SOFTWARE, including

the U.S. Export Administration Regulations, as well as end-user, end-use and destination restrictions issued by U.S. and other governments. For additional information, see <http://www.microsoft.com/exporting/>.

TRADEMARKS: This EULA does not grant you any rights in connection with any trademarks or service marks of FORD MOTOR COMPANY, MS, Microsoft Corporation, third party software or service providers, their affiliates or suppliers.

PRODUCT SUPPORT: Product support for the SOFTWARE is not provided by MS, its parent corporation Microsoft Corporation, or their affiliates or subsidiaries. For product support, please refer to FORD MOTOR COMPANY instructions provided in the documentation for the DEVICE. Should you have any questions concerning this EULA, or if you desire to contact FORD MOTOR COMPANY for any other reason, please refer to the address provided in the documentation for the DEVICE.

No Liability for Certain Damages: EXCEPT AS PROHIBITED BY LAW, FORD MOTOR COMPANY, ANY THIRD PARTY SOFTWARE OR SERVICES SUPPLIERS, MS, MICROSOFT CORPORATION AND THEIR AFFILIATES SHALL HAVE NO LIABILITY FOR ANY INDIRECT, SPECIAL, CONSEQUENTIAL OR INCIDENTAL DAMAGES ARISING FROM OR IN CONNECTION WITH THE USE OR PERFORMANCE OF THE SOFTWARE. THIS LIMITATION SHALL APPLY EVEN IF ANY REMEDY FAILS OF ITS ESSENTIAL PURPOSE. IN NO EVENT SHALL MS, MICROSOFT CORPORATION AND/OR THEIR AFFILIATES BE LIABLE FOR ANY AMOUNT IN EXCESS OF U.S. TWO HUNDRED FIFTY DOLLARS (U.S. \$250.00).

Appendices

- THERE ARE NO WARRANTIES OTHER THAN THOSE THAT MAY EXPRESSLY BE PROVIDED FOR YOUR NEW VEHICLE.

Adobe

Contains Adobe® [Flash® Player] or [AIR®] technology by Adobe Systems Incorporated. This [Licensee Product] contains [Adobe® Flash® Player] [Adobe® AIR®] software under license from Adobe Systems Incorporated, Copyright ©1995-2009 Adobe Macromedia Software LLC. All rights reserved. Adobe, Flash and AIR are trademarks of Adobe Systems Incorporated.

End User Notice

Microsoft® Windows® Mobile for Automotive Important Safety Information

This system Ford SYNC™ contains software that is licensed to Manufacturer FORD MOTOR COMPANY by an affiliate of Microsoft Corporation pursuant to a license agreement. Any removal, reproduction, reverse engineering or other unauthorized use of the software from this system in violation of the license agreement is strictly prohibited and may subject you to legal action.

Read and follow instructions: Before using your Windows Automotive-based system, read and follow all instructions and safety information provided in this end user manual ("User's Guide"). Not following precautions found in this User's Guide can lead to an accident or other serious consequences.

Keep User's Guide in vehicle: When kept in the vehicle, the User's Guide will be a ready reference for you and other users unfamiliar with the Windows Automotive-based system. Please make certain that before using the system for the first time, all persons have access to the User's Guide and read its instructions and safety information carefully.

WARNING



Operating certain parts of this system while driving can distract your attention away from the road, and possibly cause an accident or other serious consequences. Do not change system settings or enter data non-verbally (using your hands) while driving. Stop the vehicle in a safe and legal manner before attempting these operations. This is important since while setting up or changing some functions you might be required to distract your attention away from the road and remove your hands from the wheel.

General Operation

Voice Command Control: Functions within the Windows Automotive-based system may be accomplished using only voice commands. Using voice commands while driving allows you to operate the system without removing your hands from the wheel.

Prolonged Views of Screen: Do not access any function requiring a prolonged view of the screen while you are driving. Pull over in a safe and legal manner before attempting to access a function of the system requiring prolonged attention. Even occasional short scans to the screen may be hazardous if your attention has been diverted away from your driving task at a critical time.

Appendices

Volume Setting: Do not raise the volume excessively. Keep the volume at a level where you can still hear outside traffic and emergency signals while driving. Driving while unable to hear these sounds could cause an accident.

Use of Speech Recognition Functions: Speech recognition software is inherently a statistical process which is subject to errors. It is your responsibility to monitor any speech recognition functions included in the system and address any errors.

Navigation Features: Any navigation features included in the system are intended to provide turn by turn instructions to get you to a desired destination. Please make certain all persons using this system carefully read and follow instructions and safety information fully.

Distraction Hazard: Any navigation features may require manual (non-verbal) setup. Attempting to perform such set-up or insert data while driving can seriously distract your attention and could cause an accident or other serious consequences. Stop the vehicle in a safe and legal manner before attempting these operations.

Let Your Judgment Prevail: Any navigation features are provided only as an aid. Make your driving decisions based on your observations of local conditions and existing traffic regulations. Any such feature is not a substitute for your personal judgment. Any route suggestions made by this system should never replace any local traffic regulations or your personal judgment or knowledge of safe driving practices.

Route Safety: Do not follow the route suggestions if doing so would result in an unsafe or illegal maneuver, if you would be placed in an unsafe situation, or if you would be directed into an area that you consider unsafe. The driver is ultimately responsible for the safe operation of the vehicle and therefore, must evaluate whether it is safe to follow the suggested directions.

Potential Map Inaccuracy: Maps used by this system may be inaccurate because of changes in roads, traffic controls or driving conditions. Always use good judgment and common sense when following the suggested routes.

Emergency Services: Do not rely on any navigation features included in the system to route you to emergency services. Ask local authorities or an emergency services operator for these locations. Not all emergency services such as police, fire stations, hospitals and clinics are likely to be contained in the map database for such navigation features.

TeleNav Software End User License Agreement

Please read these terms and conditions carefully before you use the TeleNav Software. Your use of the TeleNav Software indicates that you accept these terms and conditions. If you do not accept these terms and conditions, do not break the seal of the package, launch, or otherwise use the TeleNav Software.

TeleNav may revise this Agreement and the privacy policy at any time, with or without notice to you. You agree to visit <http://www.telenav.com> from time to time to review the then current version of this Agreement and of the privacy policy.

Appendices

1. Safe and Lawful Use

You acknowledge that devoting attention to the TeleNav Software may pose a risk of injury or death to you and others in situations that otherwise require your undivided attention, and you therefore agree to comply with the following when using the TeleNav Software: (a) observe all traffic laws and otherwise drive safely; (b) use your own personal judgment while driving. If you feel that a route suggested by the TeleNav Software instructs you to perform an unsafe or illegal maneuver, places you in an unsafe situation, or directs you into an area that you consider to be unsafe, do not follow such instructions; (c) do not input destinations, or otherwise manipulate the TeleNav Software, unless your vehicle is stationary and parked; (d) do not use the TeleNav Software for any illegal, unauthorized, unintended, unsafe, hazardous, or unlawful purposes, or in any manner inconsistent with this Agreement; (e) arrange all GPS and wireless devices and cables necessary for use of the TeleNav Software in a secure manner in your vehicle so that they will not interfere with your driving and will not prevent the operation of any safety device (such as an airbag).

You agree to indemnify and hold TeleNav harmless against all claims resulting from any dangerous or otherwise inappropriate use of the TeleNav Software in any moving vehicle, including as a result of your failure to comply with the directions above.

2. Account Information

You agree: (a) when registering the TeleNav Software, to provide TeleNav with true, accurate, current, and complete information about yourself, and (b) to inform TeleNav promptly of any changes to such information, and to keep it true, accurate, current and complete.

3. Software License

Subject to your compliance with the terms of this Agreement, TeleNav hereby grants to you a personal, non-exclusive, non-transferable license (except as expressly permitted below in connection with your permanent transfer of the TeleNav Software license), without the right to sublicense, to use the TeleNav Software (in object code form only) in order to access and use the TeleNav Software. This license shall terminate upon any termination or expiration of this Agreement. You agree that you will use the TeleNav Software only for your personal business or leisure purposes, and not to provide commercial navigation services to other parties.

3.1 License Limitations

You agree not to do any of the following: (a) reverse engineer, decompile, disassemble, translate, modify, alter or otherwise change the TeleNav Software or any part thereof; (b) attempt to derive the source code, audio library or structure of the TeleNav Software without the prior express written consent of TeleNav; (c) remove from the TeleNav Software, or alter, any of TeleNav's or its suppliers' trademarks, trade names, logos, patent or copyright notices, or other notices or markings; (d) distribute, sublicense or otherwise transfer the TeleNav Software to others, except as part of your permanent transfer of the TeleNav Software; or (e) use the TeleNav Software in any manner that (i) infringes the intellectual property or proprietary rights, rights of publicity or privacy or other rights of any party, (ii) violates any law, statute, ordinance or regulation, including but not limited to laws and regulations related to spamming, privacy, consumer and child protection, obscenity or defamation, or (iii) is harmful, threatening, abusive, harassing, tortuous,

Appendices

defamatory, vulgar, obscene, libelous, or otherwise objectionable; and (f) lease, rent out, or otherwise permit unauthorized access by third parties to the TeleNav Software without advanced written permission of TeleNav.

4. Disclaimers

To the fullest extent permissible pursuant to applicable law, in no event will TeleNav, its licensors and suppliers, or agents or employees of any of the foregoing, be liable for any decision made or action taken by you or anyone else in reliance on the information provided by the TeleNav Software. TeleNav also does not warrant the accuracy of the map or other data used for the TeleNav Software. Such data may not always reflect reality due to, among other things, road closures, construction, weather, new roads and other changing conditions. You are responsible for the entire risk arising out of your use of the TeleNav Software. For example but without limitation, you agree not to rely on the TeleNav Software for critical navigation in areas where the well-being or survival of you or others is dependent on the accuracy of navigation, as the maps or functionality of the TeleNav Software are not intended to support such high risk applications, especially in more remote geographical areas.

TELENAV EXPRESSLY DISCLAIMS AND EXCLUDES ALL WARRANTIES IN CONNECTION WITH THE TELENAV SOFTWARE, WHETHER STATUTORY, EXPRESS OR IMPLIED, INCLUDING ALL WARRANTIES WHICH MAY ARISE FROM COURSE OF DEALING, CUSTOM OR TRADE AND INCLUDING, BUT NOT LIMITED TO, THE IMPLIED WARRANTIES OF MERCHANTABILITY, FITNESS FOR A

PARTICULAR PURPOSE AND NON-INFRINGEMENT OF THIRD PARTY RIGHTS WITH RESPECT TO THE TELENAV SOFTWARE. Certain jurisdictions do not permit the disclaimer of certain warranties, so this limitation may not apply to you.

5. Limitation of Liability

TO THE EXTENT PERMITTED UNDER APPLICABLE LAW, UNDER NO CIRCUMSTANCES SHALL TELENAV OR ITS LICENSORS AND SUPPLIERS BE LIABLE TO YOU OR TO ANY THIRD PARTY FOR ANY INDIRECT, INCIDENTAL, CONSEQUENTIAL, SPECIAL OR EXEMPLARY DAMAGES (INCLUDING IN EACH CASE, BUT NOT LIMITED TO, DAMAGES FOR THE INABILITY TO USE THE EQUIPMENT OR ACCESS DATA, LOSS OF DATA, LOSS OF BUSINESS, LOSS OF PROFITS, BUSINESS INTERRUPTION OR THE LIKE) ARISING OUT OF THE USE OF OR INABILITY TO USE THE TELENAV SOFTWARE, EVEN IF TELENAV HAS BEEN ADVISED OF THE POSSIBILITY OF SUCH DAMAGES.

NOTWITHSTANDING ANY DAMAGES THAT YOU MIGHT INCUR FOR ANY REASON WHATSOEVER (INCLUDING, WITHOUT LIMITATION, ALL DAMAGES REFERENCED HEREIN AND ALL DIRECT OR GENERAL DAMAGES IN CONTRACT, TORT (INCLUDING NEGLIGENCE) OR OTHERWISE), THE ENTIRE LIABILITY OF TELENAV AND OF ALL OF TELENAV'S SUPPLIERS SHALL BE LIMITED TO THE AMOUNT ACTUALLY PAID BY YOU FOR THE TELENAV SOFTWARE. SOME STATES AND/OR JURISDICTIONS DO NOT ALLOW THE EXCLUSION OR LIMITATION OF INCIDENTAL OR CONSEQUENTIAL DAMAGES, SO THE ABOVE LIMITATIONS OR EXCLUSIONS MAY NOT APPLY TO YOU.

Appendices

6. Arbitration and Governing Law

You agree that any dispute, claim or controversy arising out of or relating to this Agreement or the TeleNav Software shall be settled by independent arbitration involving a neutral arbitrator and administered by the American Arbitration Association in the County of Santa Clara, California. The arbitrator shall apply the Commercial Arbitration Rules of the American Arbitration Association, and the judgment upon the award rendered by the arbitrator may be entered by any court having jurisdiction. Note that there is no judge or jury in an arbitration proceeding and the decision of the arbitrator shall be binding upon both parties. You expressly agree to waive your right to a jury trial.

This Agreement and performance hereunder will be governed by and construed in accordance with the laws of the State of California, without giving effect to its conflict of laws provisions. To the extent judicial action is necessary in connection with the binding arbitration, both TeleNav and you agree to submit to the exclusive jurisdiction of the courts of the County of Santa Clara, California. The United Nations Convention on Contracts for the International Sale of Goods shall not apply.

7. Assignment

You may not resell, assign, or transfer this Agreement or any of your rights or obligations, except in totality, in connection with your permanent transfer of the TeleNav Software, and expressly conditioned upon the new user of the TeleNav Software agreeing to be bound by the terms and conditions of this Agreement. Any such sale, assignment or transfer that is not expressly permitted under this paragraph will result in immediate termination of this Agreement, without liability to TeleNav, in which case you and all other parties shall immediately

cease all use of the TeleNav Software. Notwithstanding the foregoing, TeleNav may assign this Agreement to any other party at any time without notice, provided the assignee remains bound by this Agreement.

8. Miscellaneous

8.1

This Agreement constitutes the entire agreement between TeleNav and you with respect to the subject matter hereof.

8.2

Except for the limited licenses expressly granted in this Agreement, TeleNav retains all right, title and interest in and to the TeleNav Software, including without limitation all related intellectual property rights. No licenses or other rights which are not expressly granted in this Agreement are intended to, or shall be, granted or conferred by implication, statute, inducement, estoppel or otherwise, and TeleNav and its suppliers and licensors hereby reserve all of their respective rights other than the licenses explicitly granted in this Agreement

8.3

By using the TeleNav Software, you consent to receive from TeleNav all communications, including notices, agreements, legally required disclosures or other information in connection with the TeleNav Software (collectively, "Notices") electronically. TeleNav may provide such Notices by posting them on TeleNav's Website or by downloading such Notices to your wireless device. If you desire to withdraw your consent to receive Notices electronically, you must discontinue your use of the TeleNav Software.

Appendices

8.4

TeleNav's or your failure to require performance of any provision shall not affect that party's right to require performance at any time thereafter, nor shall a waiver of any breach or default of this Agreement constitute a waiver of any subsequent breach or default or a waiver of the provision itself.

8.5

If any provision herein is held unenforceable, then such provision will be modified to reflect the intention of the parties, and the remaining provisions of this Agreement will remain in full force and effect

8.6

The headings in this Agreement are for convenience of reference only, will not be deemed to be a part of this Agreement, and will not be referred to in connection with the construction or interpretation of this Agreement. As used in this Agreement, the words "include" and "including" and variations thereof, will not be deemed to be terms of limitation, but rather will be deemed to be followed by the words "without limitation".

9. Other Vendors Terms and Conditions

The TeleNav Software utilizes map and other data licensed to TeleNav by third party vendors for the benefit of you and other end users. This Agreement includes end-user terms applicable to these companies (included at the end of this Agreement), and thus your use of the TeleNav Software is also subject to such terms. You agree to comply with the following additional terms and conditions, which are applicable to TeleNav's third party vendor licensors:

NavTeq End User License Agreement

END USER TERMS

The content provided ("Data") is licensed, not sold. By opening this package, or installing, copying, or otherwise using the Data, you agree to be bound by the terms of this agreement. If you do not agree to the terms of this agreement, you are not permitted to install, copy, use, resell or transfer the Data. If you wish to reject the terms of this agreement, and have not installed, copied, or used the Data, you must contact your retailer or NAVTEQ North America, LLC ("NT") within thirty (30) days of purchase for a refund of your purchase price. To contact NT, please visit www.navteq.com.

The Data is provided for your personal, internal use only and may not be resold. It is protected by copyright, and is subject to the following terms (this "End User License Agreement") and conditions which are agreed to by you, on the one hand, and NAVTEQ North America, LLC ("NT") and its licensors (including their licensors and suppliers) on the other hand.

The Data for areas of Canada includes information taken with permission from Canadian authorities, including: © Her Majesty the Queen in Right of Canada, © Queen's Printer for Ontario, © Canada Post Corporation, GeoBase®.

NT holds a nonexclusive license from the United States Postal Service® to publish and sell ZIP+4® information.

© United States Postal Service® 2009. Prices are not established, controlled or approved by the United States Postal Service® The following trademarks and registrations are owned by the USPS: United States Postal Service, USPS, and ZIP+4.

The Data for Mexico includes certain Data from Instituto Nacional de Estadística y Geografía.

Appendices

TERMS AND CONDITIONS

License Limitations on Use: You agree that your license to use this Data is limited to and conditioned on use for solely personal, noncommercial purposes, and not for service bureau, timesharing or other similar purposes. Except as otherwise set forth herein, you agree not to otherwise reproduce, copy, modify, decompile, disassemble or reverse engineer any portion of this Data, and may not transfer or distribute it in any form, for any purpose, except to the extent permitted by mandatory laws.

License Limitations on Transfer: Your limited license does not allow transfer or resale of the Data, except on the condition that you may transfer the Data and all accompanying materials on a permanent basis if: (a) you retain no copies of the Data; (b) the recipient agrees to the terms of this End User License Agreement; and (c) you transfer the Data in the exact same form as you purchased it by physically transferring the original media (e.g., the CD-ROM or DVD you purchased), all original packaging, all Manuals and other documentation. Specifically, Multi-disc sets may only be transferred or sold as a complete set as provided to you and not as a subset thereof.

Additional License Limitations: Except where you have been specifically licensed to do so by NT in a separate written agreement, and without limiting the preceding paragraph, your license is conditioned on use of the Data as prescribed in this agreement, and you may not (a) use this Data with any products, systems, or applications installed or otherwise connected to or in communication with vehicles capable of vehicle navigation, positioning, dispatch,

real time route guidance, fleet management or similar applications; or (b) with, or in communication with, including without limitation, cellular phones, palmtop and handheld computers, pagers, and personal digital assistants or PDAs.

WARNING



This Data may contain inaccurate or incomplete information due to the passage of time, changing circumstances, sources used and the nature of collecting comprehensive geographic Data, any of which may lead to incorrect results.

No Warranty: This Data is provided to you "as is", and you agree to use it at your own risk. NT and its licensors (and their licensors and suppliers) make no guarantees, representations or warranties of any kind, express or implied, arising by law or otherwise, including but not limited to, content, quality, accuracy, completeness, effectiveness, reliability, fitness for a particular purpose, usefulness, use or results to be obtained from this Data, or that the Data or server will be uninterrupted or error free.

Disclaimer of Warranty: NT AND ITS LICENSORS (INCLUDING THEIR LICENSORS AND SUPPLIERS) DISCLAIM ANY WARRANTIES, EXPRESS OR IMPLIED, OF QUALITY, PERFORMANCE, MERCHANTABILITY, FITNESS FOR A PARTICULAR PURPOSE OR NON-INFRINGEMENT. Some States, Territories and Countries do not allow certain warranty exclusions, so to that extent the above exclusion may not apply to you.

Disclaimer of Liability: NT AND ITS LICENSORS (INCLUDING THEIR LICENSORS AND SUPPLIERS) SHALL NOT BE LIABLE TO YOU IN RESPECT OF ANY CLAIM, DEMAND OR ACTION, IRRESPECTIVE OF THE NATURE OF THE

Appendices

CAUSE OF THE CLAIM, DEMAND OR ACTION ALLEGING ANY LOSS, INJURY OR DAMAGES, DIRECT OR INDIRECT, WHICH MAY RESULT FROM THE USE OR POSSESSION OF THIS DATA; OR FOR ANY LOSS OF PROFIT, REVENUE, CONTRACTS OR SAVINGS, OR ANY OTHER DIRECT, INDIRECT, INCIDENTAL, SPECIAL OR CONSEQUENTIAL DAMAGES ARISING OUT OF YOUR USE OF OR INABILITY TO USE THIS DATA, ANY DEFECT IN THIS DATA, OR THE BREACH OF THESE TERMS OR CONDITIONS, WHETHER IN AN ACTION IN CONTRACT OR TORT OR BASED ON A WARRANTY, EVEN IF NT OR ITS LICENSORS HAVE BEEN ADVISED OF THE POSSIBILITY OF SUCH DAMAGES. Some States, Territories and Countries do not allow certain liability exclusions or damages limitations, so to that extent the above may not apply to you.

Export Control: You agree not to export from anywhere any part of the Data or any direct product thereof except in compliance with, and with all licenses and approvals required under, applicable export laws, rules and regulations, including but not limited to the laws, rules and regulations administered by the Office of Foreign Assets Control of the U.S. Department of Commerce and the Bureau of Industry and Security of the U.S. Department of Commerce. To the extent that any such export laws, rules or regulations prohibit NT from complying with any of its obligations hereunder to deliver or distribute Data, such failure shall be excused and shall not constitute a breach of this Agreement.

Entire Agreement: These terms and conditions constitute the entire agreement between NT (and its licensors) including their licensors and suppliers) and you pertaining to the subject matter hereof, and supersedes in their entirety any and all written or oral agreements previously existing between us with respect to such subject matter.

Severability: You and NT agree that if any portion of this agreement is found illegal or unenforceable, that portion shall be severed and the remainder of the Agreement shall be given full force and effect.

Governing Law: The above terms and conditions shall be governed by the laws of the State of Illinois, without giving effect to (i) its conflict of laws provisions, or (ii) the United Nations Convention for Contracts for the International Sale of Goods, which is explicitly excluded. You agree to submit to the personal jurisdiction of the State of Illinois for any and all disputes, claims and actions arising from or in connection with the Data provided to you hereunder.

Government End Users: If the Data is being acquired by or on behalf of the United States government or any other entity seeking or applying rights similar to those customarily claimed by the United States government, this Data is a "commercial term" as that term is defined at 48 C.F.R. ("FAR") 2.101, is licensed in accordance with this End User License Agreement, and each copy of Data delivered or otherwise furnished shall be marked and embedded as appropriate with the following "Notice of Use", and be treated in accordance with such Notice:

NOTICE OF USE

CONTRACTOR
(MANUFACTURER/SUPPLIER)

NAME:

Appendices

NAVTEQ

CONTRACTOR
(MANUFACTURER/SUPPLIER)

ADDRESS:

**425 West Randolph Street, Chicago, IL
60606.**

This Data is a commercial item as defined in FAR 2.101

and is subject to the End User License Agreement under

which this Data was provided.

© 2011 NAVTEQ. All rights reserved.

If the Contracting Officer, federal government agency, or any federal official refuses to use the legend provided herein, the Contracting Officer, federal government agency, or any federal official must notify NAVTEQ prior to seeking additional or alternative rights in the Data.

Wi-Fi hotspot data provided by JiWire, © 2013 JiWire.

Gracenote® Copyright

CD and music-related data from Gracenote, Inc., copyright© 2000-2007 Gracenote. Gracenote Software, copyright © 2000-2007 Gracenote. This product and service may practice one or more of the following U.S. Patents #5,987,525, #6,061,680, #6,154,773, #6,161,132, #6,230,192, #6,230,207, #6,240,459, #6,330,593 and other patents issued or pending. Some services supplied under license from Open Globe, Inc. for U.S. Patent: #6,304,523.

Gracenote and CDDB are registered trademarks of Gracenote. The Gracenote logo and logotype, and the "Powered by Gracenote™" logo are trademarks of Gracenote.

Gracenote® End User License Agreement (EULA)

This device contains software from Gracenote, Inc. of 2000 Powell Street Emeryville, California 94608 ("Gracenote").

The software from Gracenote (the "Gracenote Software") enables this device to do disc and music file identification and obtain music-related information, including name, artist, track, and title information ("Gracenote Data") from online servers ("Gracenote Servers"), and to perform other functions. You may use Gracenote Data only by means of the intended End User functions of this device.

This device may contain content belonging to Gracenote's providers. If so, all of the restrictions set forth herein with respect to Gracenote Data shall also apply to such content and such content providers shall be entitled to all of the benefits and protections set forth herein that are available to Gracenote.

You agree that you will use the content from Gracenote ("Gracenote Content"), Gracenote Data, the Gracenote Software, and Gracenote Servers for your own personal, non-commercial use only. You agree not to assign, copy, transfer or transmit the Gracenote Content, Gracenote Software or any Gracenote Data (except in a Tag associated with a music file) to any third party. YOU AGREE NOT TO USE OR EXPLOIT GRACENOTE CONTENT, GRACENOTE DATA, THE GRACENOTE SOFTWARE, OR GRACENOTE SERVERS, EXCEPT AS EXPRESSLY PERMITTED HEREIN.

You agree that your non-exclusive licenses to use the Gracenote Content, Gracenote Data, the Gracenote Software, and Gracenote Servers will terminate if you violate these restrictions. If your licenses terminate, you agree to cease any and all use of the Gracenote Content, Gracenote

Appendices

Data, the Gracenote Software, and Gracenote Servers. Gracenote, respectively, reserve all rights in Gracenote Data, the Gracenote Software, and the Gracenote Servers and Gracenote Content, including all ownership rights. Under no circumstances will either Gracenote become liable for any payment to you for any information that you provide, including any copyrighted material or music file information. You agree that Gracenote may enforce its respective rights, collectively or separately, under this agreement against you, directly in each company's own name.

Gracenote uses a unique identifier to track queries for statistical purposes. The purpose of a randomly assigned numeric identifier is to allow Gracenote to count queries without knowing anything about who you are. For more information, see the web page at www.gracenote.com for the Gracenote Privacy Policy.

THE GRACENOTE SOFTWARE, EACH ITEM OF GRACENOTE DATA AND THE GRACENOTE CONTENT ARE LICENSED TO YOU "AS IS". NEITHER GRACENOTE MAKES ANY REPRESENTATIONS OR WARRANTIES, EXPRESS OR IMPLIED, REGARDING THE ACCURACY OF ANY GRACENOTE DATA FROM THE GRACENOTE SERVERS OR GRACENOTE CONTENT. GRACENOTE COLLECTIVELY AND SEPARATELY RESERVE THE RIGHT TO DELETE DATA AND/OR CONTENT FROM THE COMPANIES' RESPECTIVE SERVERS OR, IN THE CASE OF GRACENOTE, CHANGE DATA CATEGORIES FOR ANY CAUSE THAT GRACENOTE DEEMS SUFFICIENT. NO WARRANTY IS MADE THAT EITHER GRACENOTE CONTENT OR THE GRACENOTE SOFTWARE OR GRACENOTE SERVERS ARE ERROR-FREE OR THAT THE FUNCTIONING OF THE GRACENOTE SOFTWARE OR GRACENOTE SERVERS WILL BE

UNINTERRUPTED. GRACENOTE IS NOT OBLIGATED TO PROVIDE YOU WITH ANY ENHANCED OR ADDITIONAL DATA TYPES THAT GRACENOTE MAY CHOOSE TO PROVIDE IN THE FUTURE AND IS FREE TO DISCONTINUE ITS ONLINE SERVICES AT ANY TIME. GRACENOTE DISCLAIMS ALL WARRANTIES EXPRESS OR IMPLIED, INCLUDING, BUT NOT LIMITED TO, IMPLIED WARRANTIES OF MERCHANTABILITY, FITNESS FOR A PARTICULAR PURPOSE, TITLE, AND NON-INFRINGEMENT. NEITHER GRACENOTE WARRANTS THE RESULTS THAT WILL BE OBTAINED BY YOUR USE OF THE GRACENOTE SOFTWARE OR ANY GRACENOTE SERVER. IN NO CASE WILL GRACENOTE BE LIABLE FOR ANY CONSEQUENTIAL OR INCIDENTAL DAMAGES OR FOR ANY LOST PROFITS OR LOST REVENUES FOR ANY REASON WHATSOEVER.

© Gracenote 2007.

FCC ID: KMHSYNGG2

IC: 1422A-SYNGG2

This device complies with Part 15 of the FCC Rules and with RSS-210 of Industry Canada. Operation is subject to the following two conditions: (1) This device may not cause harmful interference, and (2) this device must accept any interference received, including interference that may cause undesired operation.

WARNING



Changes or modifications not expressly approved by the party responsible for compliance could void the user's authority to operate the equipment. The term "IC" before the radio certification number only signifies that Industry Canada technical specifications were met.

Appendices

The antenna used for this transmitter must not be co-located or operating in conjunction with any other antenna or transmitter.

Index

A

- A/C
 - See: Climate Control.....69
- About This Manual.....5
 - Protecting the Environment.....5
- ABS
 - See: Brakes.....101
- ABS driving hints
 - See: Hints on Driving With Anti-Lock Brakes.....101
- Accessories
 - See: Replacement Parts Recommendation.....8
- Adjusting the Steering Wheel.....43
- Air Conditioning
 - See: Climate Control.....69
- Air Vents.....69
 - Center Air Vents.....69
 - Side Air Vents.....70
- Alarm
 - See: Anti-Theft Alarm.....40
- Anti-Theft Alarm.....40
 - Alarm System.....40
 - Arming the Alarm.....41
 - Disarming the Alarm.....41
 - Full and Reduced Guard.....41
 - Triggering the Alarm.....41
- Appendices.....208
- At a Glance.....10
- Audible Warnings and Indicators.....59
 - Anti-theft Alarm.....59
 - Door Ajar.....59
 - Headlamps On.....59
 - Headlight Exit Delay.....59
 - Ignition Left On (Keyless Vehicles Only).....59
 - Low Fuel Level.....59
 - Message Center Display.....60
 - Parking Brake.....60
 - Safety Belt Minder.....60
 - Speed Alarm.....60
 - Vehicle Not in Park.....60
- Audio Control.....43
 - Type 1.....43
 - Type 2.....44
- Audio System.....161
 - General Information.....161
- Audio Troubleshooting.....176
- Audio unit.....167
 - Alternative Frequencies.....170
 - Automatic Volume Control.....170
 - Autostore Control.....169
 - Frequency Band Button.....169
 - News Broadcasts.....170
 - Regional Mode.....171
 - Sound Button.....169
 - Station Preset Buttons.....169
 - Station Tuning Control.....169
 - Traffic Information Control.....170
- Audio unit - Vehicles With:
 - AM/FM/CD.....162
 - Alternative Frequencies.....166
 - Automatic Volume Control.....165
 - Autostore Control.....165
 - News Broadcasts.....166
 - Regional Mode.....166
 - Sound Button.....164
 - Station Preset Buttons.....164
 - Station Tuning Control.....164
 - Traffic Information Control.....165
 - Waveband Button.....164
- Autolamps.....49
- Automatic Climate Control.....70
- Automatic Transmission.....96
 - Emergency Park Position Release Lever.....98
 - Hints on Driving With an Automatic Transmission.....98
 - Selector Lever Positions.....96
 - Sport Mode and Manual Shifting.....97
- Autowipers.....45
- Auxiliary Input Jack.....175
- Auxiliary Power Points.....80
 - Location.....80

B

- Bonnet Lock
 - See: Opening and Closing the Hood.....127
- Brake and Clutch Fluid Check.....134
- Brakes.....101
 - General Information.....101

Index

Breaking-In.....	113
Brakes and Clutch.....	113
Engine.....	113
Tires.....	113
Bulb Specification Chart.....	142

C

Capacities and Specifications.....	159
Technical Specifications.....	160
Car Wash	
See: Cleaning the Exterior.....	147
Catalytic Converter.....	90
Driving with a Catalytic Converter.....	90
Center Console.....	82
Changing a Bulb.....	136
Central High Mounted Brake Lamp.....	139
Front Fog Lamps.....	137
Headlamp.....	136
Interior Lamp.....	139
Luggage Compartment Lamp, Footwell Lamp and Tailgate Lamp.....	140
Map Lamp (driver side).....	140
Number Plate Lamp.....	139
Reading Lamps.....	140
Rear Lamps.....	138
Side Lamp.....	137
Vanity Lamp.....	137
Changing a Fuse.....	126
Changing a Road Wheel.....	153
Installing a Road Wheel.....	156
Jacking and Lifting Points.....	154
Removing a Road Wheel.....	154
Removing a Spare Wheel.....	155
Scissor Lift Hoist.....	154
Vehicle Jack.....	154
Vehicles With a Spare Wheel.....	153
Changing the 12V Battery.....	135
Changing the Engine Air Filter.....	143
Changing the Air Filter Element.....	143
Changing the Wiper Blades.....	140
Windshield Wiper Blades.....	140
Checking the Wiper Blades.....	140
Child Safety.....	17
Child Safety Locks.....	24
Left-hand side.....	24
Right-hand side.....	24
Child Seat Positioning.....	20

Cigar Lighter.....	80
Cleaning the Alloy Wheels.....	148
Cleaning the Exterior.....	147
Body Paintwork Preservation.....	147
Cleaning the Chrome Trim.....	147
Cleaning the Headlamps.....	147
Cleaning the Rear Window.....	147
Cleaning the Interior.....	147
Instrument Cluster Screens, LCD Screens and Radio Screens.....	148
Rear Windows.....	148
Safety Belts.....	147
Climate Control.....	69
Principle of Operation.....	69
Cold Weather Precautions.....	113
Compact Disc Player.....	171
CD Text Display Options.....	174
Compact Disc Playback.....	171
Compact Disc Track Scanning.....	172
Ending Compact Disc Playback.....	174
Fast Forward and Reverse.....	172
MP3 and WMA Display Options.....	174
MP3 and WMA File Playback.....	172
Repeat Compact Disc Tracks.....	172
Shuffle and Random.....	172
Track Selection.....	172
Coolant Check	
See: Engine Coolant Check.....	134
Cruise Control.....	44
Principle of Operation.....	107
Cruise control	
See: Using Cruise Control.....	107

D

Data Recording.....	7
Daytime Running Lamps.....	49
Diesel Particulate Filter.....	87
Regeneration.....	87
Direction Indicators.....	50
DPF	
See: Diesel Particulate Filter.....	87
Driver Airbag.....	28
.....	28
Driver Knee Airbag.....	30
Driving Aids.....	108
Driving Hints.....	113

Index

Driving Through Water.....	113
.....	113
DRL	
See: Daytime Running Lamps.....	49
E	
Economical Driving.....	113
Accessories.....	113
Anticipation.....	113
Efficient Speed.....	113
Electrical Systems.....	113
Gear Shifting.....	113
Tire Pressures.....	113
Electromagnetic compatibility.....	208
End User License Agreement.....	209
SYNC® End User License Agreement (EULA).....	209
Engine Coolant Check.....	134
Adding Engine Coolant.....	134
Engine Immobilizer	
See: Passive Anti-Theft System.....	40
Engine Oil Check.....	132
Checking the Oil Level.....	132
Oil Consumption.....	133
Oil Filter.....	133
Topping Up.....	133
Engine Oil Dipstick - 1.0L EcoBoost™.....	132
Engine Oil Dipstick - 1.5L Duratec-16V Ti-VCT (81kW/110PS) - Sigma.....	132
Engine Oil Dipstick - 1.5L Duratorq-TDCi (67kW/91PS).....	132
.....	132
Event Data Recording	
See: Data Recording.....	7
Exterior Mirrors.....	53
Fold-Away Exterior Mirrors.....	53
Integrated Blind Spot Mirrors.....	53
Power Exterior Mirrors.....	53
F	
Fastening the Safety Belts.....	25
Fixed rear center lap belt.....	25
Using Safety Belts During Pregnancy.....	26
Floor Mats.....	114
Fog Lamps - Front	
See: Front Fog Lamps.....	50
Fog Lamps - Rear	
See: Rear Fog Lamps.....	51
Front Exterior Overview.....	10
Front Fog Lamps.....	50
Front Seat Armrest.....	79
Fuel and Refueling.....	89
Fuel Consumption Figures - 1.0L EcoBoost™.....	92
Fuel Consumption Figures - 1.5L Duratec-16V Ti-VCT (81kW/110PS) - Sigma, Vehicles With: 5-Speed Manual Transmission.....	93
Fuel Consumption Figures - 1.5L Duratec-16V Ti-VCT (81kW/110PS) - Sigma, Vehicles With: 6-Speed Automatic Transmission.....	94
Fuel Consumption Figures - 1.5L Duratorq-TDCi.....	95
Fuel Consumption.....	92
Calculating Fuel Economy.....	92
Filling the Tank.....	92
Fuel Quality - Diesel.....	90
Long-Term Storage.....	90
Fuel Quality - Gasoline.....	89
Long-Term Storage.....	90
Fuel Shutoff.....	115
Fuse Box Locations.....	117
Battery Fuse Box.....	117
Engine Compartment Fuse Box.....	117
Passenger Compartment Fuse Box.....	117
Fuses.....	117
Fuse Specification Chart.....	118
Battery Fuse Box.....	125
Engine Compartment Fuse Box.....	118
Passenger Compartment Fuse Box.....	122
G	
Gauges.....	55
Engine Coolant Temperature Gauge.....	55
Fuel Gauge.....	55
General Information on Radio Frequencies.....	32
Glasses Holder.....	82

Index

H	
Handbrake	
See: Parking Brake.....	101
Hazard Warning Flashers.....	115
Headlamp Leveling.....	51
Recommended headlamp leveling control positions.....	51
Head Restraints.....	75
.....	75
Adjusting the head restraints.....	75
Removing the head restraints.....	76
Heated Windows.....	74
Heated Rear Window (If Equipped).....	74
Heating	
See: Climate Control.....	69
Hill Start Assist.....	99
Activating Hill Start Assist.....	99
Deactivating Hill Start Assist.....	100
Hints on Controlling the Interior	
Climate.....	71
Cooling the Interior Quickly.....	72
General Hints.....	71
Heating the Interior Quickly.....	72
Recommended Settings for Cooling.....	73
Recommended Settings for Heating.....	72
Vehicle Stationary for Extended Periods during Extreme High Ambient Temperatures.....	73
Windshield and Side Window Defrosting or Defogging in Cold Weather.....	73
Hints on Driving With Anti-Lock Brakes.....	101
Hood Lock	
See: Opening and Closing the Hood.....	127
I	
Ignition Switch.....	83
Information Displays.....	61
General Information.....	61
Information Messages.....	63
Installing Child Seats.....	17
Attaching a Child Seat With a Support Leg.....	20
Attaching a Child Seat With Top Tethers.....	20
Booster Seats.....	18
Child Seats for Different Mass Groups.....	18
ISOFIX Anchor Points.....	19
Instrument Cluster.....	55
Instrument Panel Overview - Vehicles With: LHD.....	12
Instrument Panel Overview - Vehicles With: RHD.....	13
Interior Lamps.....	50
Courtesy lamp.....	50
Reading lamps.....	50
Interior Mirror.....	54
Auto-Dimming Mirror.....	54
Introduction.....	5
J	
Jump-Starting the Vehicle.....	115
To Connect the Booster Cables.....	116
To Start the Engine.....	116
K	
Keyless Entry.....	36
Disabled Keys.....	38
General Information.....	36
Locking and Unlocking the Doors with the Key Blade.....	38
Locking Your Vehicle.....	37
Passive Key.....	37
Unlocking Your Vehicle.....	37
Keyless Starting.....	83
Failure to Start.....	84
Starting Your Vehicle.....	84
Stopping the Engine When Your Vehicle is Moving.....	85
Stopping the Engine When Your Vehicle is Stationary.....	85
Switching the Ignition On (Accessory Mode).....	84
Keys and Remote Controls.....	32

Index

L

Lighting Control.....	48
Headlamp flasher.....	49
High and low beam.....	49
Home safe lighting.....	49
Lighting control positions.....	48
Parking lamps.....	48
Lighting.....	48
General Information.....	48
Load Carriers	
See: Roof Racks and Load Carriers.....	109
Load Carrying.....	109
General Information.....	109
Locking and Unlocking.....	35
Autolock.....	35
Locking and Unlocking the Doors from Inside.....	36
Locking and Unlocking the Doors with the Key.....	36
Power Door Locks.....	35
Remote Control.....	35
Locks.....	35
Luggage Anchor Points.....	109
Luggage Covers.....	109
Lug Nuts	
See: Changing a Road Wheel.....	153

M

Maintenance.....	127
General Information.....	127
Manual Seats.....	76
Adjusting the Height of the Driver's Seat.....	77
Adjusting the Lumbar Support.....	77
Moving the Seat Backward and Forward.....	76
Recline Adjustment.....	77
Manual Transmission.....	96
Selecting Reverse Gear.....	96
Message Center	
See: Information Displays.....	61
Mirrors	
See: Windows and Mirrors.....	52
Mobile Communications Equipment.....	8

O

Oil Check	
See: Engine Oil Check.....	132
Opening and Closing the Hood.....	127
Closing the Hood.....	128
Opening the Hood.....	127

P

Parking Aid.....	105
Rear Sensing System.....	106
Parking Aids.....	105
Principle of Operation.....	105
Parking Brake.....	101
All Vehicles.....	101
Vehicles With Automatic Transmission.....	101
Vehicles With Manual Transmission.....	101
Passenger Airbag.....	29
Switching the Passenger Airbag Off.....	29
Switching the Passenger Airbag On.....	30
Passive Anti-Theft System.....	40
Arming the Engine Immobilizer.....	40
Coded Keys.....	40
Disarming the Engine Immobilizer.....	40
Principle of Operation.....	40
PATS	
See: Passive Anti-Theft System.....	40
Power Door Locks	
See: Locking and Unlocking.....	35
Power Windows.....	52
Bounce-Back.....	52
One-Touch Down.....	52
One-Touch Up.....	52
Window Lock.....	52

R

Rear Exterior Overview.....	15
Rear Fog Lamps.....	51
Rear Seats.....	77
Folding the Seat Back.....	77
Reclining the Seat Back.....	77
Rear Window Wiper and Washers.....	46
Intermittent Wipe.....	46
Rear Window Washer.....	47
Reverse Gear Wipe.....	47

Index

Refueling.....	91	Starter Switch	
Fuel Filler Cap.....	91	See: Ignition Switch.....	83
Remote Control.....	32	Starting a Diesel Engine.....	86
Changing the Remote Control Battery.....	32	Cold or Hot Engine.....	86
Remote Control With a Folding Key		Failure to Start.....	87
Blade.....	32	Starting a Gasoline Engine.....	85
Remote Control Without a Folding Key		Cold or Hot Engine.....	86
Blade.....	33	Engine Idle Speed after Starting.....	86
Reprogramming the Unlocking		Failure to Start.....	86
Function.....	32	Flooded Engine.....	86
Removing a Headlamp.....	142	Starting and Stopping the Engine.....	83
Repairing Minor Paint Damage.....	148	General Information.....	83
Replacement Parts		Steering.....	108
Recommendation.....	8	Electric Power Steering.....	108
Collision Repairs.....	8	Steering Wheel Lock.....	85
Scheduled Maintenance and Mechanical		Vehicles with Keyless Starting.....	85
Repairs.....	8	Vehicles without Keyless Starting.....	85
Warranty on Replacement Parts.....	8	Steering Wheel.....	43
Replacing a Lost Key or Remote		Storage Compartments.....	82
Control.....	34	Supplementary Restraints System.....	28
Roadside Emergencies.....	115	Principle of Operation.....	28
Roof Racks and Load Carriers.....	109	Switching Off the Engine.....	88
Adjusting the Crossbar.....	110	Vehicles With a Turbocharger.....	88
Running-In		Symbols Glossary.....	5
See: Breaking-In.....	113	SYNC™ Applications and Services.....	191
Running Out of Fuel.....	90	In the Event of a Crash.....	192
Refilling with a Portable Fuel		Switching Emergency Assistance On and	
Container.....	91	Off.....	192
S		SYNC Applink.....	194
Safety Belt Height Adjustment.....	26	SYNC Emergency Assistance.....	191
Safety Belt Minder.....	26	SYNC™.....	177
Turning the Safety Belt Minder Off.....	27	General Information.....	177
Safety Belts.....	25	SYNC™ Troubleshooting.....	200
Safety Precautions.....	89	T	
Seats.....	75	Tailgate.....	38
Security.....	40	Opening the Tailgate.....	38
Side Airbags.....	30	Technical Specifications - 1.0L EcoBoost	
Side Curtain Airbags.....	30	(90kW/120PS).....	143
Sitting in the Correct Position.....	75	Capacities.....	143
Snow Chains		Specifications.....	144
See: Using Snow Chains.....	149	Technical Specifications - 1.5L	
Speed Control		Duratec-16V Ti-VCT (81kW/110PS) -	
See: Cruise Control.....	107	Sigma.....	144
Stability Control.....	104	Capacities.....	144
Principle of Operation.....	104	Specifications.....	145

Index

Technical Specifications - 1.5L	
Duratorq-TDCi (67kW/91PS).....	145
Capacities.....	145
Specifications.....	146
Technical Specifications	
See: Capacities and Specifications.....	159
Tire Care.....	149
Tire Pressure Monitoring System.....	150
Changing Tires With a Tire Pressure	
Monitoring System.....	151
How Temperature Affects the Tire	
Pressures.....	153
Tire Pressure Monitoring System Reset	
Procedure.....	152
Understanding the Tire Pressure Monitoring	
System.....	151
Tires	
See: Wheels and Tires.....	149
Towing a Trailer.....	111
Steep Gradients.....	111
Towing Points.....	111
Towing the Vehicle on Four Wheels.....	112
All Vehicles.....	112
Vehicles with Automatic	
Transmission.....	112
Towing.....	111
Traction Control.....	103
Principle of Operation.....	103
Transmission.....	96
See: Transmission.....	96
Trip Computer.....	62
Average Fuel Consumption.....	63
Average Speed.....	63
Distance Odometer.....	63
Distance to Empty.....	62
Instantaneous Fuel Consumption.....	63
Stationary Fuel Consumption.....	63
Temperature.....	62
Trip Odometer.....	62
U	
Under Hood Overview - 1.0L	
EcoBoost™.....	129
Under Hood Overview - 1.5L Duratec-16V	
Ti-VCT (81kW/110PS) - Sigma.....	130
Under Hood Overview - 1.5L	
Duratorq-TDCi (67kW/91PS).....	131
USB Port.....	176
Using Cruise Control.....	107
Switching Cruise Control Off.....	107
Switching Cruise Control On.....	107
Using Snow Chains.....	149
Vehicles with Stability Control.....	150
Using Stability Control.....	104
Using SYNC™ With Your Media	
Player.....	196
Accessing Your USB Song Library.....	199
Bluetooth Devices and System	
Settings.....	200
Connecting Your Media Player to the USB	
Port.....	196
Media Menu Features.....	198
Media Voice Commands.....	197
What's Playing?.....	197
Using SYNC™ With Your Phone.....	181
Accessing Features Through the Cell Phone	
Menu.....	185
Accessing Your Cell Phone Settings.....	187
Bluetooth Devices.....	189
Cell Phone Options During an Active	
Call.....	184
Cell Phone Voice Commands.....	182
Making a Call.....	184
Pairing a Cell Phone for the First Time.....	181
Pairing Subsequent Cell Phones.....	181
Receiving a Call.....	184
Text Messaging.....	186
Using Traction Control.....	103
Switching the System Off Using a	
Switch.....	103
Switching the System Off Using the	
Information Display Controls.....	103
System Indicator Lights and	
Messages.....	103
Using Voice Recognition.....	178
Helpful Hints.....	178
Initiating a Voice Session.....	179
System Interaction and Feedback.....	179
Using Winter Tires.....	149
V	
Vehicle Care.....	147

Index

Vehicle Identification Number.....	160
Vehicle Identification Plate.....	159
Vehicle Interior Overview.....	11
Ventilation	
See: Climate Control.....	69
Vents	
See: Air Vents.....	69
VIN	
See: Vehicle Identification Number.....	160
Voice Control.....	44

W

Warning Lamps and Indicators.....	56
Anti-Lock Braking System Warning Lamp.....	56
Anti-theft System Indicator.....	56
Automatic High Beam Indicator.....	56
Battery Warning Lamp.....	56
Brake System Warning Lamp.....	56
Coolant Temperature Warning Lamp.....	56
Cruise Control Indicator.....	57
Diesel Particulate Filter Warning Lamp.....	57
Direction Indicator.....	57
Doors Open Warning Lamp.....	57
Engine Oil Warning Lamp.....	57
Engine Warning Lamps.....	57
Front Airbag Warning Lamp.....	58
Front Fog Lamps Indicator.....	58
Frost Warning Lamp.....	58
Glow Plug Indicator.....	58
Headlamp and Parking Lamp Indicator.....	58
High Beam Indicator.....	58
Hill Start Assist Indicator.....	58
Low Fuel Level Indicator.....	58
Low Tire Pressure Warning Lamp.....	58
Oil Dilution Warning Lamp.....	58
Power Steering Warning Lamp.....	58
Rear Fog Lamps Indicator.....	58
Safety Belt Minder Warning Lamp.....	59
Shift Indicator.....	59
Stability Control Off Indicator.....	59
Stability Control Warning Lamp.....	59
Warning Triangle.....	115
Washer Fluid Check.....	135
Washers	
See: Cleaning the Exterior.....	147
See: Wipers and Washers.....	45
Wheel Nuts	
See: Changing a Road Wheel.....	153
Wheels and Tires.....	149
General Information.....	149
Technical Specifications.....	157
Windows and Mirrors.....	52
Windshield Washers.....	46
Windshield Wipers.....	45
Intermittent Wipe.....	45
Speed Dependent Wipers.....	45
Winter Tires	
See: Using Winter Tires.....	149
Wipers and Washers.....	45

