

INFOTAINMENT SYSTEM

Mahindra **XUV**₅₀₀

ISSUE DATE: OCTOBER 2011



MAHINDRA & MAHINDRA LTD.
GATEWAY BUILDING, APOLLO BUNDER, MUMBAI - 400 039

Safety Precautions	1-1
CD Handling	2-1
Level 1 - Audio Infotainment System*	3-1
Bezel and Button Functions	3-2
Features.....	3-3
LCD Display	3-3
Operations	3-3
Clock	3-4
Radio Operations	3-5
CD Operations	3-6
Aux - In Operation	3-10
Audio Settings	3-11
Level 2 - Audio Infotainment System*	4-1
Bezel and Button Functions	4-2
Features	4-3
Controls	4-3
Operations	4-6
Clock	4-9
Tuner	4-12
Playing a Media (CD / USB / iPod)	4-14
Playing an AUX	4-16
Bluetooth (BT) Functions	5-1

Phone Book	5-5
Steering Wheel Control (SWC)	6-1
Voice Recognition (VR)	7-1
Vehicle Information	8-1
Level 3 - Audio Infotainment System*	9-1
Bezel and Button Functions	9-2
Features	9-3
Controls	9-3
DVD/CD Handling	9-10
Operations	9-12
Tuner	9-16
Playing a Media (CD/DVD/USB/iPod)	9-18
Bluetooth (BT) Functions	9-19
Phone Book	9-22
Video	9-24
Voice Recognition (VR)	9-25
Vehicle Information	9-29
Alerts	9-30
Navigation Control	9-33
Index	10-1

*** if equipped**

Safety Precautions

Before using this device, take some time to read this manual.

Knowledge of operation procedures will help in obtaining the best performance of the new infotainment system. Figures from the display and panel presented in this manual are examples provided for best explaining how the commands are used. Thus, display figures presented may be different from those actually presented on the device display. Illustrations, technical information, specifications and descriptions of this manual were correct until the date of printing. We safeguard the right to make any required amendment according to the ongoing development and improvement.

To avoid risk of damage and / or fire, observe the following precautions:

- To avoid short circuits, never insert metallic objects (for instance coins or metallic tools) into the unit.
- If you notice that the unit is releasing smoke or a strange smell, consult an Authorised Mahindra Dealer.

- Pay attention not to let the unit fall down, nor beat the device strongly. Glass and other internal components of the unit may get damaged, making it non-operative.
- If the LCD (Liquid Crystal Display) is damaged or broken as a result of a crash, never touch the liquid crystal fluid inside it. The liquid crystal fluid may be harmful to your health. If the liquid gets in contact with the body or clothes, wash it promptly with water and soap and seek medical help.
- Do not place 8 cm (3 inches) compact disks into the CD opening. If you try to place a 8 cm CD with an adaptor in the device, it may separate from the CD and damage the unit.

Cleaning of the unit

If the front panel of this unit is dirty, clean it with a dry cloth or slightly damp cloth. If the front panel is very dirty, clean it with a cloth moistened with neutral soap and then repeat the prior operation.

WARNING

Do not use any cleaning spray on the unit, as that it can affect its mechanical parts. Cleaning the front panel with a rough cloth or using a volatile liquid, like solvent or alcohol, may scratch the surface or erase some characters.

CD opening cleaning

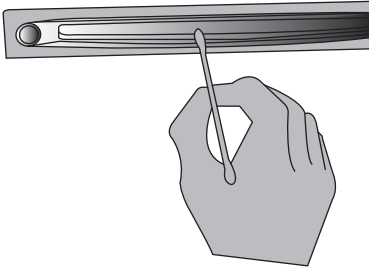

Since dust tends to accumulate in the CD opening, clean it periodically. Remember that compact disks (CD) may get scratched if placed in the CD opening which has dust accumulated in it.

Radio reception

Always memorize the desired stations using the radio memory keys. This will help in selecting the desired station faster.

AM Reception (Medium Waves)

Strong AM signals provide stable sound quality with low noise. At night, however, the atmospheric conditions may sometimes lead to interference from other stations.

FM Reception

FM zone offers best quality sound reception, however the signal intensity may be subjected to noise caused by:

- Limited reach of some transmitters
- Distortion caused by signals reflected in local buildings and other obstructions
- “Shadow zones” wherein the signal reception is obstructed or restricted

CD Handling

CD care and maintenance

WARNING

Your audio unit may get damaged if improper objects are inserted into the CD opening, like credit cards or coins.

Precautions regarding operation

- If the vehicle has been parked under the hot sun, let the unit cool down before activating it.
- Be careful not to let juice or soft drinks drip on the unit or on the disks.

Wetness condensation

On a rainy day or in humid conditions, moisture may condense on the laser reading lens and display unit. If this happens, the unit will not work properly. In this case, remove the disk and wait till the moisture has evaporated.

CD handling

- Do not touch the CD on the recorded surface.

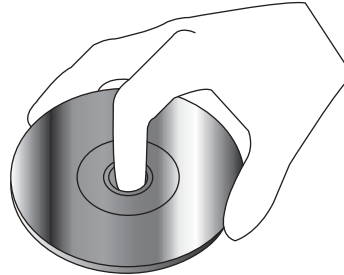

- Do not leave them exposed to direct sun light (on the seat or control panel, etc.) or under high temperature.
- Keep the CDs in their boxes or in any other source that protects them from being scratched.

- Do not place adhesives on the CD. Also, do not use a CD with an adhesive.
- CD-R and CD-RW are more susceptible to damage than a common musical CD (Compact Disk). Use a CD-R or CD-RW after reading the precautions on the CD label.

CD accessories

- Do not use disk accessories
- Do not stick labels nor use disks with sticky paints / residues. Such disks may stop turning when used, causing defects or damage.

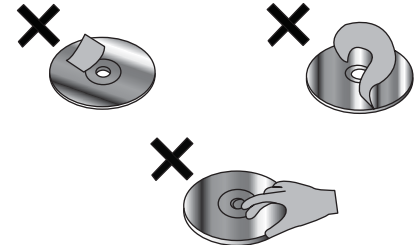

⚠ CAUTION

The CD, AUX, Bluetooth, iPod options can be selected only if devices are available. Tuner option will always be available.

CD cleaning

Clean CDs using a soft and dry cloth starting from the centre to the edge of the disk.

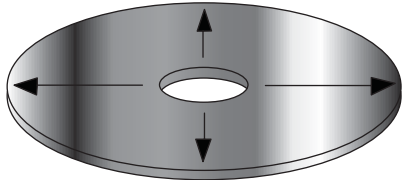

CD removal

When removing CDs from the unit, store them in a horizontal position.

CDs that cannot be used

- CDs which are not round shaped can not be used

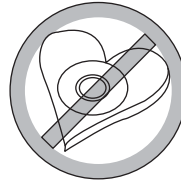
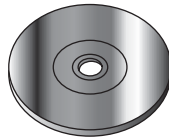

- CDs painted on the recording surface, or those which are dirty can not be used.
- Do not use CDs without the disk mark.



- It is not possible to reproduce a CD-R or CD-RW which has not been formatted.

Music disks encoded with copyright protection

This product has been designed to reproduce disks that comply with the Compact Disk (CD) standard. Recently, some labels have commercialised several encoded music disks with copyrights protection.

It might not be possible to reproduce from disks which do not comply with the CD standard.

Disk Labels



⚠ WARNING

Some CD-R / CD-RW (depending on the equipment used for recording or the disk condition) might not play in this unit.

Level 1 - Audio Infotainment System (if equipped)



Bezel and Button Functions

NO.	KEY NAME	FUNCTION / DESCRIPTION
1	POWER / SELECT	Power ON / OFF, Select
2	VOLUME KNOB	Volume up / down
3	1	Programmed memory 1
4	2	Programmed memory 2
5	3 / FLR-	Programmed memory 3 / Folder down
6	4 / FLR+	Programmed memory 4 / Folder up
7	5	Programmed memory 5
8	6	Programmed memory 6
9	CLK	Clock settings and toggling between 12 and 24 hrs
10	BAND	Band selection
11	SEEK DOWN ◀	Previous track / fast rewind
12	SEEK UP ▶	Next track / fast forward
13	EQ	Equalizer settings
14	FAV	Favorite tuner memory selection
15	RPT	Repeat
16	RDM	Random
17	SOURCE	Source selection
18	INFO	Track information
19	MUTE	Audio mute
20	EJECT ▲	CD eject

Features

- AM / FM tuner
- Manual / Auto seek frequency tune
- Six tuner frequency memory pre-sets
- 18 - FM and 12 - AM manual preset store
- CD supports CDDA, MP3 and WMA9 formats
- AUX audio input support
- Power output - 4 X 25 watts (10% THD)
- Clock display
- Audio adjustments - bass treble balance fade
- EQ settings - Classic, Pop, Jazz, rock

LCD Display

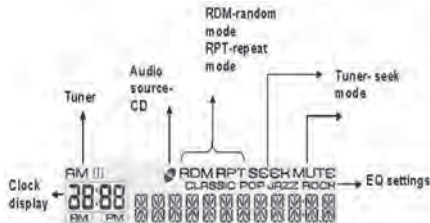

The display is used to exhibit infotainment system information such as tuner, menus, CD track / folder information (English) and play time and clock information etc. The display is segmented and 12 character rolling for ID3 tag.

Operations

General operations

When the key position is in accessory (1st state), the infotainment system will operate. The next key state will be ignition (run mode) where the infotainment system will be fully active. General button operations and their functions are described below.

Power / Select

- Press [Power / Select] button to turn the infotainment system ON and OFF
- If the ignition is ON, the infotainment system goes to the last used source. If the last source is not available anymore, it goes to the tuner source
- When the ACC / ignition is OFF infotainment system will not turn ON

- When the infotainment system is powered off using long press of [Power / Select] button (while acc / ignition is still ON) clock will be displayed along with a scrolling welcome message

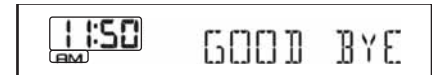

- Illumination for LCD is dependent on the intensity switch position

Volume knob

- Volume can be increased or decreased by turning the **volume knob** in clockwise or anti-clockwise direction
- Audio volume can be adjusted in Tuner, CD and AUX modes
- Volume can be adjusted from 0 to 45



- **Volume knob** can be used for EQ adjustments, clock settings and manual seeking of tuner stations. Refer relevant sections for details.

Source

Each time the [SOURCE] is pressed, the available sources can be selected in the following sequence: **Tuner** → **CD (available)** → **AUX (inserted)** → **Tuner**

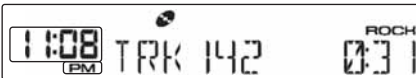
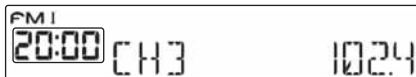

WARNING

The CD, AUX options can be selected only if devices are available. Tuner option will always be available.

Equalizer

- With the help of [EQ] button and **volume knob**, user adjustable settings (bass, treble, fade, balance) and pre-set music settings (classic, pop, jazz, rock) can be done.
- Short press the [EQ] button to adjust audio settings. At each short press the audio settings will change according to the sequence **Bass** → **Treble** → **Balance** → **Fade** → **Equalizer** → **Bass**. User can adjust the levels using the **volume knob**

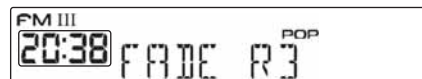
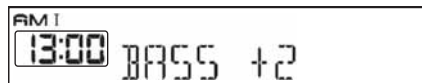

Mute

- Short pressing the [MUTE] button will mute the audio. "MUTE" icon will be flashed when muted or volume reduced to zero
- Infotainment system will hold the CD / AUX play during mute period and will display "PAUSED"
- Infotainment system will not pause CD / AUX play when volume is reduced to zero



Clock

Clock setting

- Long pressing the [CLK] button enables clock adjustment
- By default HRS will be flashed. Use volume knob for Hour adjustment
- Short press the [CLK] button to toggle to minute field and use volume knob for adjustment
- After adjustment, short press [Power / Select] long press of [CLK] or 5sec time out will save the adjusted time

NOTICE

Clock setting can be done only in 24 HRS format.

Clock format

infotainment system will support 12 / 24 hour modes and can be toggled by short press of [CLK].

Radio Operations

Frequency band select

- Press [BAND] button to access the selected frequency bands FM1, FM2, FM3 or AM1, AM2.
- The infotainment system will display tuner band and frequency to show that the infotainment system is in the tuner source.

Auto seek

- In tuner mode, auto seek can be executed for the next active radio station broadcast within the currently selected frequency band
- Short Press the [SEEK UP▶] button to execute an upward and short press on [SEEK DOWN◀] button for downward frequency auto seek
- During the auto frequency, LCD will display the frequency of each valid radio station

If no valid station is found then the seek function will stop at the frequency where the seek was initiated.



Manual frequency tuning

- While the radio is in FM or AM mode, the user can long press the [SEEK UP ▶] or [SEEK DOWN◀] button to enter / enable manual tuning
- Use the **volume knob** for frequency adjusts. For every step the frequency will be adjusted by one step

- During the manual frequency adjustment the infotainment system will display current frequency and can be adjusted using **volume knob**
- Short press on [Power / Select] button to tune to that frequency



Pre-set memories 1 to 6

- Pre-set functionality allows storing or selecting a given radio frequency within one of the reception ranges (FM1, FM2, FM3 and AM1, AM2)
- Pre-set storage is acknowledged by a beep sound and the display is updated with the new pre-set number

To select memories

Short press of a pre-set button [1]... [6], recalls the radio station frequency from memory. The tuner will change to this recalled frequency.

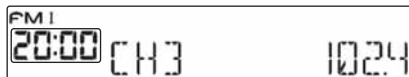

To store a station

Press and hold pre-set button [1]... [6], overwrites the frequency previously stored in that memory location with the current frequency. The pre-set storage is acknowledged by a beep sound.

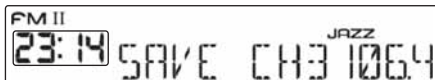

CD Operations

Inserting a CD

- User can insert a CD into the CD opening slot
- The CD-mechanism will detect the CD automatically inserted into it
- The display will then read “LOADING CD” and will initiate reading the CD. The infotainment system will display “READING CD” to indicate that the infotainment system is starting to read the disc.



- If any error occurs during CD insertion, or if the CD is damaged or incompatible, the display will read “CD DATA ERR”. Or if there is any mechanism error the display will be “CD MECH ERR”. The CD will be then ejected and the unit will change to tuner source.



When the infotainment system is OFF

If the infotainment system is OFF (key position is in ign / acc), as soon as the CD is inserted, audio system will start playing the CD.

Ejecting a CD

- Press the [▲]Eject key to eject the CD from the infotainment system. If the infotainment system is playing the CD, it will change to the tuner source. The display will then read “EJECTING CD”. If the CD is not removed from the infotainment system, it will be reloaded after 10 seconds automatically.



- The display will read “**NO CD**” if there is no CD in the infotainment system. The current audio program will not be affected.



MP3 / WMA Reproduction

Notes on the MP3 / WMA reproduction

MP3 / WMA files which can be reproduced (herein after referred to as audio files) and the media format have the following limitations. Audio file out of specification might not be normally reproduced or the names of files and folders may not be properly viewed.

Reproducible audio files

- MP3, WMA
- Add the proper extension to the audio file (**MP3:** “.MP3”; **WMA:** “.WMA”)

- Do not add extensions to other files which are not audio files. The files which do not have an audio file format will not be reproduced
- Files protected against copy may not be reproduced

Reproducible MP3 file

- MPEG 1, 2 and 2.5 Layer 3 File
- Throughput in bits: 32-320Kbps
- Sampling frequency: 32 / 44.1 / 48 KHz

Reproducible WMA file

- File compatible with Windows Media Audio 9 standard release
- Throughput in bits: 32-320 Kbps
- Sampling frequency: 32 / 44.1 / 48 KHz

Reproducible media

- CD-ROM, CD-R, CD-RW (CD-RW with quick format cannot be used)
- When recording media up to its maximum capacity at once, the recording software should be adjusted for “Disc at once”



Format of reproducible disks

- ISO 9660 Levels 1 / 2
- Joliet

WARNING

Formats different from those mentioned might not be successfully reproduced and their file names or folder names might not be properly viewed.

Track information

The infotainment system can display ID3 tag information (file, folder, title etc.) of the current track via short press [INFO] button.

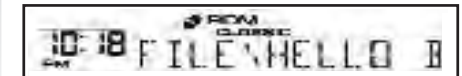



Maximum number of characters showed on the display

Only the first 24 characters of the filename, folder-name, title, artist, and album will be displayed.

The following information can be displayed in order (wrap round) via short press [INFO] button.

- Filename
- Folder name
- ID3 - title
- ID3 - artist
- ID3 - album

File and folder structure limit

- Maximum quantity of directory levels 8
- The quantity of files and folders is the result of the sum of all files and folders - 512.

Reproduction order of the audio file

Audio file is reproduced at the sequence defined by the recording software. It is possible to program the reproduction sequence recording the reproduction sequence numbers, for instance from "01" to "99" at the beginning of the file name.

For Instance

Reproduction order after track

Search forward the file during reproduction

Press [SEEK UP ►]

To reproduce the prior file, during reproduction

Press [SEEK DOWN ◀]

Search next folder during reproduction

Press key [4 / FLR+]

Search previous folder during reproduction

Press key [3 / FLR-]

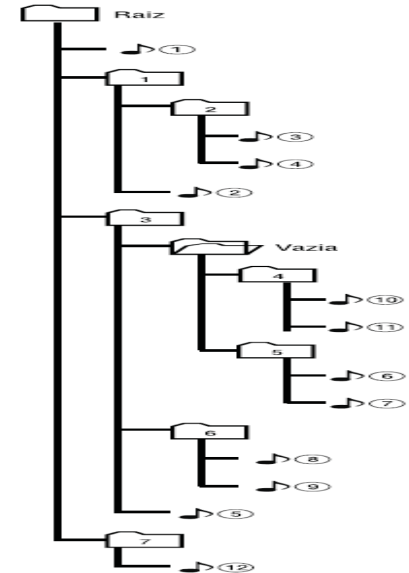

Skip folder

- Press the [3 / FLR-] key to open previous folder
- Press the [4 / FLR+] key to open next folder

Skip track

- Press the **[SEEK UP ►]** key to jump to the next track
- Press the **[SEEK DOWN ◀]** key to jump to the previous track

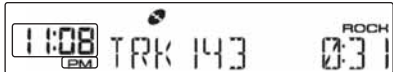
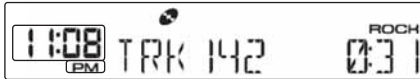

- If the current track is within the first 3 seconds of music, it will jump to the previous track. If the track exceeded the first 3 seconds, it will select the start of the current track
- If the first CD track is being played, it will jump to the last one

Fast forward play

The user can fast forward the current track being played by a continuous **[SEEK UP ►]** button press.

Fast backward play

The user can fast backward the current track being played by a continuous **[SEEK DOWN ◀]** button press.

When the fast forward button is pressed, the audio file shall play 2 times the normal speed. If continuously pressed for more than 5 seconds the play speed shall increase to 10 times the normal speed. As soon as fast forward is released, the CD is played at normal speed from the current position.

Random play mode

- Press the **[RDM]** key for the random function. It enables or disables the random selection of tracks. At the end of such track, another track will be chosen at random. When this function is ON, "RDM" icon will be displayed along with source.
- User can select one of the shuffle options with short press on the **[RDM]** button. The sequence of the random play mode is as follows **RANDOM OFF → RDM FOLDER → RDM DISC → RDM FOLDER.**

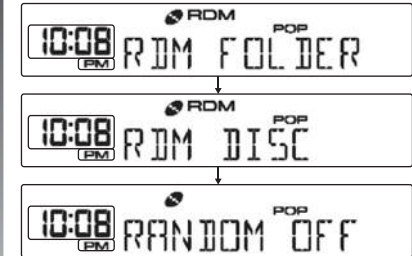

Repeat play mode

- Press the **[RPT]** key to enable or disable the repetition of the current track
- When this function in ON, "RPT" icon will be displayed, and the track will be played again in case of repeat track. The whole folder will be played in case of repeat folder
- User can select one of the repeat options with short press on the **[RPT]** button. The sequence of the repeat is as follows **RPT OFF → RPT FOLDER → RPT TRACK → REPEAT OFF**

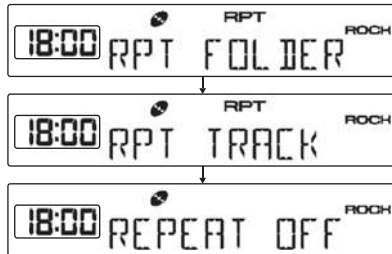

MP3 / WMA track information

- The default track info for the playing track is track number and playing time
- Press **[INFO]** button to see track related information
- They will be displayed as "FILE_", "FOLDER_", "TITLE_", "ARTIST_", "ALBUM_" following with the related info, unit will scroll display the info once and revert back to the playing track number and playing time. Music time will not be shown while the display is showing other information than track data. If the

playing track is a CDDA track, the INFO button press will be ignored. If current track is completed, unit will play next track and the track info will revert back to default track info.

Aux - In Operation

The infotainment system has a single unbalanced stereo input for connecting external devices. It is available in the front.

Connecting AUX input

- Connect AUX jack to the infotainment system, press **[SOURCE]** button to access AUX mode
- The infotainment system will display "**PLAYING AUX**" to indicate that infotainment system is in AUX mode, and if there is an external auxiliary audio input from the bezel AUX connector, the audio can be heard through the speakers of the audio system

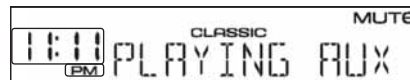

- If AUX jack is not connected, short press of **[SOURCE]** button cannot change to AUX mode and the unit will still remain in current source mode and display "**NO AUX**" for 2 seconds



- If the Aux jack is not connected properly, connect and disconnect toggling might occur

Disconnecting AUX input

During the AUX play, user can remove the AUX jack, and the infotainment system will revert to previous tuner mode and display "**NO AUX**" for 2 seconds.



Audio Settings

Volume control

- Rotate the **volume knob** to increase or decrease the volume
- The volume control is same across audio sources (Tuner, CD, AUX)
- When the volume level has been adjusted the infotainment system displays the volume level for 5 seconds
- When the volume level is adjusted to “0”, the audio will be inaudible, and unit will flash “**MUTE**” icon. If unit is in CD / MP3 mode, the playing wouldn't pause
- Unit will flash “**MUTE**” until the user changes the volume again. But during other operations, the associated information will be displayed

Standard volume adjustment

- When the unit is switched ON (Power ON or Ignition ON), the volume will be restored to its previous setting if the previous volume is from 15 to 35

- The volume will be set to 15 if the previous volume is less than 15. The volume will be set to 35 if the previous volume is more than 35.
- If there is no previous volume level stored, the volume level will be 15 (default).

Audio options

- Press [**EQ**] button to enter Audio setting
- At each short press of [**EQ**] button, audio setting will be changed in the sequence **Bass → Treble → Fade → EQ → Clock → Bass**
- Use volume knob to adjust to the value of each audio setting

Bass / treble tone control

The Bass / treble level can be adjusted from -7 to +7.

When the bass / treble tone level is adjusted, unit will display the adjusted level.

The user can select the equalizer audio setting via [**EQ**] button short press, at each short press of [**EQ**] the audio setting will change according to the sequence **Bass → Treble → Balance → Fade → Equalizer → Bass**. Use volume knob clockwise / anti-clockwise to increase or decrease the bass / treble tone by one level in range (-7...0...+7). Default bass / treble tone setting will be zero.

The same bass / treble level will be used between the tuner, CD, AUX audio sources.

Fade control

The fade setting will have 15 levels of adjustment from front 7 to rear 7. The fade defines the relative audio output of the front and rear channels. The user can select the equalizer audio setting via [**EQ**] button short press, at each short press of [**EQ**] the audio setting will change according to the sequence **Bass → Treble → Balance → Fade → Equalizer → Bass**.

Use volume knob clockwise / anti-clockwise to increase / decrease the fade setting by one level in range F7 to R7. When the fade setting level is adjusted infotainment system will display fade adjustment level ('F7'...'0'...'R7').

The default fade level will be 0 (centre).

When the fade is set to "0" front and rear channels will have equal output at the selected volume level

When the fade is set to front 7 the rear speakers will be inaudible and the front speakers output will be at the selected volume.

When the fade is set to rear 7 the front speakers will be inaudible and the rear speakers output will be at the selected volume.

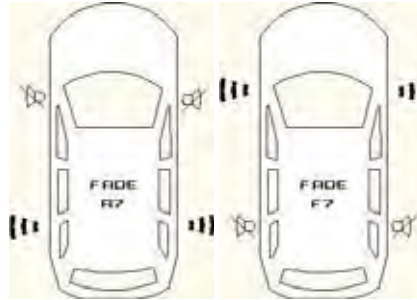

Balance control

The user can adjust the balance audio setting between left and right speakers. The balance defines the relative audio output of the left and right channels.

Balance plays the music volume levels at left and right speakers according to user settings.

When the balance level is adjusted the infotainment system will display balance adjustment level (the balance level range 'L7'...'0'...'R7'). User can select the equalizer audio setting via [EQ] button short press. At each short press of [EQ] the audio setting will change according to the sequence **Bass → Treble → Balance → Fade → Equalizer → Bass**.

Use **volume knob** clockwise / anti-clockwise to increase / decrease the balance control by one level in range L7 to R7

Default balance setting will be "0".

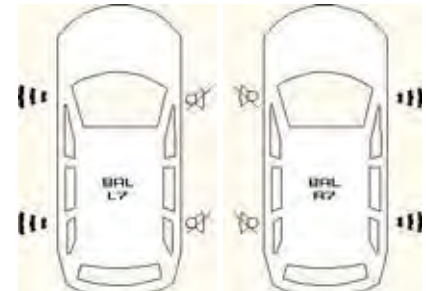

Equalizer setting

Adjusting the audio EQ setting will make the audio output sensitive.

The audio output will change in accordance with the displayed setting.

The default fade level will be "Normal".







The user can select the equalizer audio setting via [EQ] button short press, at each short press of [EQ] the audio setting will change according to the sequence **Bass → Treble → Balance → Fade → Equalizer → Bass**. User can select any of the equalizer setting by operating the **volume knob**. The volume knob will toggle between the settings **Classic → Pop → Jazz → Rock → Classic**.

Level 2 - Audio Infotainment System (if equipped)



Bezel and Button Functions

This Switch Bank contains 19 buttons and volume knob. The bank will be illuminated if the head lamps are turned on.

NO.	KEY NAME	FUNCTION / DESCRIPTION
1	POWER / SELECT	Power ON / OFF, Select
2	VOLUME KNOB	Volume up / down
3	1	Recall or save Preset #1 / Dial #1
4	2	Recall or save Preset #2 / Dial #2
5	3	Recall or save Preset #3 / Dial #3
6	4 \ 	Recall or save Preset #4 / Exit menu / Dial #4
7	5 / RDM	Recall or save Preset #5 / Random / Dial #5
8	6 / RPT	Recall or save Preset #6 / Repeat / Dial #6
9	CLK / *	Clock / Dial *
10	7 / BAND	Interchange tuner bands (AM 1 / 2, FM 1 / 2 / 3) / Dial number 7
11	8 / SEEK DOWN 	Tuner seek down / Previous track / Other menu associated activity / Dial number 8
12	9 / SEEK UP 	Tuner seek up / Next track / Other menu associated activity / Dial number 9
13	0 / EQ	Equalizer adjust / Dial number 0
14	#TA	Traffic Enable / Disable / Dial number #
15	Menu	Menu options
16	 List	Show list of tracks / folder / accept a phone call / enter Phone Book
17	SOURCE	Inter change media sources (Tuner / AUX-in / CD / USB / BTA / iPod / RAI
18	INFO 	Show cluster details / warnings / Reject a phone call
19	MUTE	Mute / Un-mute Audio Sources
20	EJECT 	CD eject

Features

- AM / FM tuner
 - Auto Seek with RDS
 - 18-FM and 12-AM manual preset store
- CD, USB, iPod
 - Supports CDDA, MP3 and WMA9 formats
 - Browsing
 - Random / Repeat
- AUX Audio Input
- Bluetooth (BT)
 - Hands Free
 - Phone Book Access
 - Music Streaming
- Audio adjustments
 - Bass, Treble, Balance, Fade
 - Normal, Classic, Pop, Jazz, Rock
 - Mahindra Modes
- Infra Red Remote Control (IRRC)
- Voice Recognition (VR)
- Steering Wheel Controls (SWC)
- Speaker - 4x25 Watts

Controls

Display

The display will show all information such as tuner, CD track / folder etc. and fuel consumption / tyre pressure etc. There shall be 4 tell tales for CD, BT, AUX and USB music. These will be highlighted if the source is connected / available.



Base screen will be HVAC ON every ignition cycle. User can change these to DIS / TPMS / Alerts as required.

The base screen display shall be divided into 2 major portions. The top portion is for the title of the screen, clock and audio. The bottom portion is for HVAC details.

Fuel Information: This will display all the fuel related information such as average fuel consumption, and distance to empty etc.

TPMS (Tyretronics): This will display Tyretronics related information such as tyre pressure, temperature, air leakage etc.

Message Centre: This will display vehicle Alerts such as door open, brake pad worn out, etc.

Refer relevant sections for details.

Switch Bank

This Switch Bank Contains 19 buttons and volume knob. The bank will be illuminated if the head lamps are turned ON.



Steering Wheel Control (SWC)







Refer to the “Steering Wheel Control” section for detailed operation

Remote Control



The Infrared based remote control shall have 21 buttons and provide all the features of fascia switches. However the activities relating to HFP access of Bluetooth and setup will be disabled.

Remote Control Button Functions are as explained below:

NO.	KEY NAME	FUNCTION / DESCRIPTION
1	POWER 	Turn ON / OFF of the infotainment system
2	SOURCE	Inter-change media sources
3	MUTE 	Mute / Un-mute audio sources
4	MOVE UP 	Move Up on the list / Menu options
5	MOVE DOWN 	Move Down on the list / Menu options
6	OK / SELECT	Select menu option
7	EXIT 	Exit out of the menu / List screen
8	VOLUME DOWN 	Decrease volume level
9	VOLUME UP 	Increase volume level
10	1	Recall or save preset memory 1
11	2	Recall or save preset memory 2
12	3	Recall or save preset memory 3
13	4	Recall or save preset memory 4
14	5 / RDM	Recall or save Preset memory 5 / Random / Dial #5
15	6 / RPT	Recall or save Preset memory 6 / Repeat / Dial #6
16	EQ	Equalizer adjust
17	BAND	Inter-change tuner bands (AM 1 / 2, FM 1 / 2 / 3) / Dial number 7
18	TA	Traffic Enable / Disable
19	Menu	Activate menu options
20	List	Enable CD / USB / iPod Browsing
21	INFO	Enable vehicle information display

Operations

General Operations

The following discrete modes are possible in the audio.

1. Sleep mode (infotainment system OFF)
2. ACC Active mode
3. NORMAL mode (infotainment system active)
4. DISPLAY OFF state

1. SLEEP Mode

The system will enter SLEEP mode from normal / accessory active mode, when the key is changed to OFF position. When the system is in Sleep mode, there shall be no illumination in display. No key operations in IR RC / SWC / Switch bank will be recognized except [EJECT] button.

2. ACC Active Mode

System enters into this mode when key is in ACCESSORY position & infotainment is turned on. All audio features are active for maximum of 1 hour, and the display is active without HVAC graphics. Driver Information's are disabled in this mode.

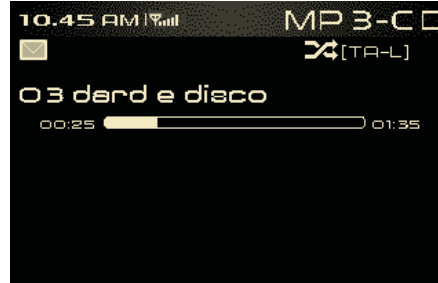

3. Normal Mode / Infotainment System Active

System enters into this mode, when key is in RUN position & infotainment is turned ON. The infotainment will be fully functional in this mode. The system can recall the last played track of CD or USB, when the system powered OFF and ON by user.

4. Display OFF Mode

If user press [POWER] button for more than 2 seconds, Infotainment will be powered OFF. All the audio functions will be deactivated in this mode.

Power / Select

- Power/Select button located in centre knob of the fascia switch. The infotainment shall be powered OFF by pressing this button for more than 2 seconds. Single press of this button shall turn ON the power again. When the user is in MENU/ Phonebook/Equalizer/ List screen, user can press [Power/Select] button to select the options to activate it or enter into the sub menu/folder.



Volume knob

Volume can be increased or decreased by turning the volume knob in clock wise and anti-clockwise direction.

Audio volume can be adjusted in Tuner, CD, AUX, iPod, Bluetooth modes.

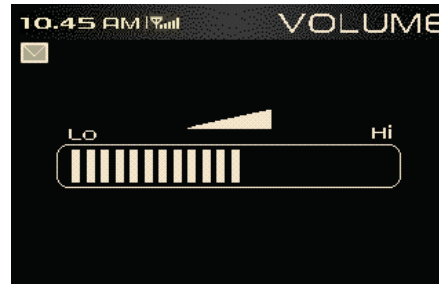

Volume knob is also used to change the options in MENU/ Phonebook/Equalizer/ List screen.

Refer relevant sections for details.

Source

User can view the available sources by pressing the [SOURCE] button, only the current source is highlighted. User can change the current source by pressing the [SOURCE] button or by rotating volume knob. The selected source can be activated after screen time out of 2 seconds/else user can press [POWER/SELECT] button for immediate action.





Equalizer Settings

The user can enter the audio setting via [EQ] button short press; User can rotate the volume knob and select the desired setting.

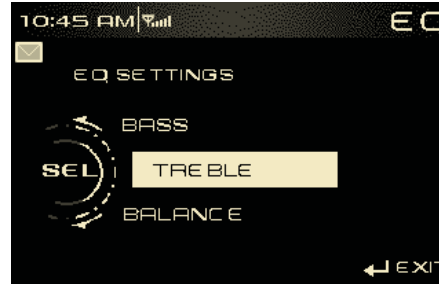

- Bass (for adjusting low frequency)
- Treble (for adjusting high frequency)
- Balance (for adjusting left and right volume levels)
- Fader (for adjusting front and rear volume levels)
- Mahindra modes
- Speed Volume
- Equalizer

Bass / Treble / Balance / Fader Control

The Bass / Treble / Balance / Fade level will be adjustable from -9 to +9. Default level setting for all these will be zero.

Use volume knob (Clockwise / Anti-clockwise) to increase / decrease the bass / treble / Balance / fade by one level in range (-9...0...+9).

When the Bass level is set to -9 the low frequency components in the music will be fully attenuated and if set to +9 the low frequency components will be fully amplified.

When the Treble level is set to -9 the high frequency components in the music will be fully attenuated and if set to +9 the high frequency components will be fully amplified.

The Balance setting is used to adjust the audio output between the left and right speakers.

When the Balance is set to "0" left and right speakers will have equal output at the selected volume level.

When the Balance is set to Left 9, the right speakers will be inaudible and the left speakers output will be at the selected volume.

When the Balance is set to Right 9, the left speakers will be inaudible and the right speakers output will be at the selected volume.

The Fader defines the relative audio output of the front and rear channels.

When the fade is set to "0" front and rear speakers will have equal output at the selected volume level.

When the Fade is set to Front 9 the rear speakers will be inaudible and the front speakers output will be at the selected volume.

When the Fade is set to Rear 9 the front speakers will be inaudible and the rear speakers output will be at the selected volume.

The same Bass / Treble / Balance / Fade level will be used by the tuner, CD, AUX audio sources.

Equalizer

The Infotainment system has following equalizer options Jazz, Pop, Rock, Classic, Voice and Normal. Whenever any of these options is selected, the corresponding music effects will be implemented into the current playing track.

Speed Volume

The infotainment system has the function Speed Volume Control. If this function is enabled in MENU options, the volume will be adjusted automatically according to the vehicle speed. In this case, the display doesn't show when the volume is changed.

Mahindra Modes

On selecting the Mahindra Modes, user can avail the 3 pre-defined equalizer settings.

- Front serene: When user selects this option, the audio will be available only in the front speakers
- Rear serene: When user selects this option, the audio will be available only in rear speakers

- Retro: When user selects this option, the audio will be available in all 4 speakers with predefined Bass and Treble settings

Clock

Clock setting

- Long press on **[CLK]** button enables clock adjustment
- By default Hrs. will be flashed. Use volume knob for Hour adjustment
- Short press on **[▶]** / **[POWER/SELECT]** button to toggle to minute field and use volume knob for adjustment
- After the adjustment Short Press on **[Power/Select]** or Short Press on **[CLK]** or 5sec timeout will save the adjusted time and exit

Clock format

Infotainment system will support 12 / 24 hour modes and can be toggled by short press on [CLK] button



Mute

Short press on [MUTE] button will mute the audio

- Radio will display "Audio Mute" when the current source is AM/FM, and Aux
- Radio will display "Audio Pause" when the current source is CD/USB/iPod or Bluetooth music is being played



- Infotainment system will not pause the current source when the volume is reduced to "0"



Info

A short press on the [INFO] button will Toggle between the information display of Driver Information's. Display change in the following sequence Fuel Info → TireTronics → Alerts → Fuel Info.

Refer relevant sections for detailed information.



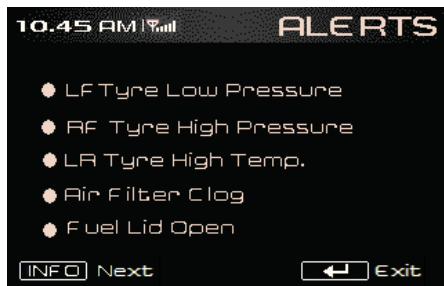

Menu

A short press on the menu button will enable the menu options. User can rotate the volume knob and select the desired sub-menu. The path of the menu will also be shown. When the last option is

selected with the help of Select button the associated function will be executed. User can exit the screen with help of exit button or it times out after 15 seconds (in this case the action will not take place).

The last selected setting will be highlighted during the next selection and by default Tuner will be highlighted.

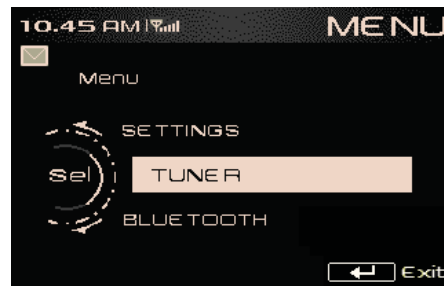

List (Browsing)

User can view the current media file structure using this list operation. User can browse the contents of the media without affecting the music playing. User can rotate the volume knob and select the desired location. The path of the current selection will also be shown / updated. When a track is selected it will play and if a folder is selected all the tracks within it will be shown. Only valid files / folders will be shown in this screen. The icons for Files / Folder / Active folder will be shown distinctively.

The current playing track will be shown with a tick mark in case of CD / USB. For iPod the entire iPod contents will be shown by default.

Tuner

The tuner mode shall play the audio from regional broadcasted station, provided it meets the AM / FM / RDS transmission specification.

System enters into the tuner mode, when no source is connected. Tuner shall play the audio from regional broadcasted station, AM/FM.

Radio reception: Always memorise the desired stations using the radio memory keys. This will help you in selecting the desired station faster.

AM Reception (Medium Waves): At most conditions, strong AM signals provide stable sound quality and with low signal noise. At night, however, the atmospheric conditions may sometimes lead to interference from other stations

FM Reception: FM zone offers best quality sound reception; however, the signal intensity may be subjected to noise caused by

- Limited reach of some transmitters

- Distortion caused by signals reflected in local buildings and other obstructions
- "Shadow zones" wherein the signal reception is obstructed or restricted



Band selection

If radio is already active, a short [BAND] button press will change the selected frequency band in order of FM1→FM2→FM3→AM1→AM2→FM1. For example, if radio is current in FM1 band, a short press of [BAND] button will make the radio change to FM2 band.

Long Press on [BAND] button has no action. Also if the current source is not radio any press on band will not have any action. The **STEREO []** alert will be displayed if the currently playing FM station has stereo output.

Auto Seek

In tuner mode, the user can execute an automatic seek for the next active radio station broadcast within the currently selected frequency band.

The user can execute a downward frequency auto seek by a short [◀] button press. The user can execute an upward frequency auto seek by a short [▶] button press.

In tuner mode, the user can execute an automatic seek for the next active radio station broadcast within the currently selected frequency band.

If user wants to stop the autoseek before reaching next active radio station, user can press [◀] or [▶] button.

Preset Memory

To Store a Station (1 to 6)

- Preset functionality allows storing or selecting a given radio frequency within one of the reception ranges (FM1, FM2, FM3 and AM1, AM2)
- Long press on preset button [1]... [6], will overwrite the previously stored frequency in that memory location with the current frequency
- When the display shows the following image a long press on button #1 stores the current frequency and gives a beep sound as indication of storage

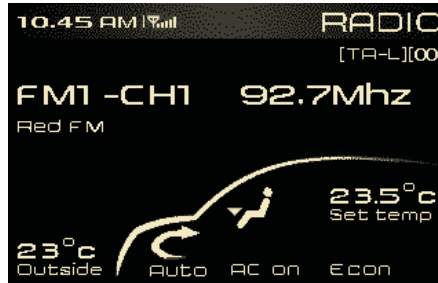

Similarly different radio channels can be stored in different pre-sets by pressing the appropriate buttons (eg 1, 2, 3, 4....etc).

Recalling a Station

Short press of a preset button [1]... [6], recalls the radio station frequency from memory. The tuner will change to this recalled frequency.

RDS (Radio Data System) (if equipped)

The Radio Data System (RDS) is used to extract additional radio station information with the FM signal.

RDS data provides the following information:

- Radio station name
- Program type
- Traffic announcement broadcasts

If an RDS signal is received then the station name will be automatically displayed.

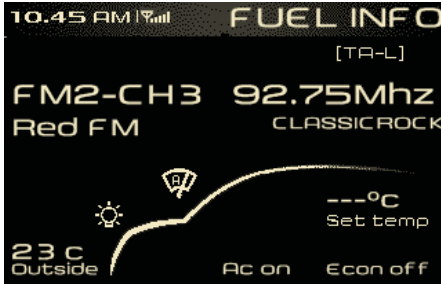

“RDS can be enabled / disabled through tuner settings MENU →TUNER → RDS ON / OFF”

Traffic News & Announcements (TA)

RDS radio stations have the ability to broadcast special traffic announcements (TA) and news during their normal radio broadcast. The radio will handle these as a special type of broadcast and interrupt the current audio source to play the announcement.

A short press on the TA button will enable/disable the Traffic program alerts. Similarly the news alerts can be activated through tuner menu selection.

NOTICE

TA feature may work only if Traffic announcement broadcast is available.

Playing a Media (CD / USB / iPod)

When ever a new CD / iPod / USB device is connected there shall be an appropriate message.

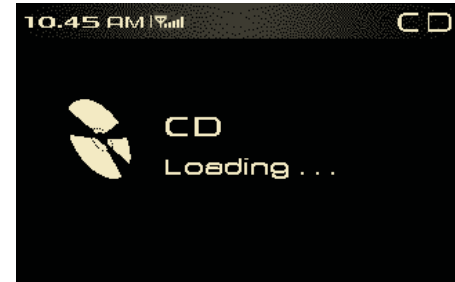

Playing Tracks

Whenever any CD / USB / iPod is plugged into the audio the very first track will be played by default. User can press [◀] / [▶] and select the desired location. The infotainment system can also display filename, folder name, ID3 (title, artist, album), genre of the current track. The default display content is track number and playing time.



Repeating Tracks / Folder

When user wants to repeat the current playing song or current folder, user can use the [RPT] button to change the options. The options change in the following sequence Repeat Track à Repeat Folder à Repeat off. By default Repeat off is activated.

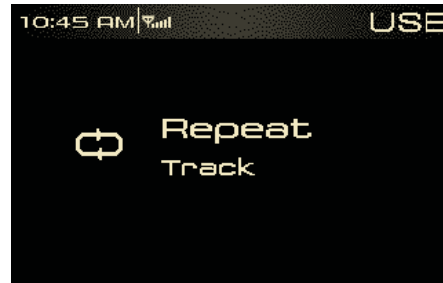

Repeat folder not supported for iPod. Display will show the  icon to indicate that repeat is activated.

Random

When user wants the folders/all the songs to be played in a random fashion a short press on the [RDM] button will enable the random options. The options change in the following sequence Random folder à Random All à Random off. By default random off is activated.



Random folder is not supported for iPod. Display will show the icon  to indicate that random is activated.

Ejecting a CD / USB / iPod

A short press on the eject button will eject the CD.

It is always preferred to remove the USB / iPod only when the radio is powered off. Upon CD/USB/iPod removal, system play the audio from previously played source.



Playing an AUX

AUX jack connection will make the radio change to AUX mode automatically. Whenever an Aux device is connected there shall be an "Auxiliary connected" message displayed in system.



The display will show a message "Playing AUX" to indicate that infotainment system is in AUX mode, and if there is an external auxiliary audio input from the bezel AUX connector, the audio can be output via the speakers of infotainment system.

During the AUX play, user cannot control the music played though the audio head unit. Operation like, seek track, fast forward / rewind etc., can be done only through the connected device. Whenever the Aux device is disconnected there shall be an "Auxiliary disconnected" message displayed in system.

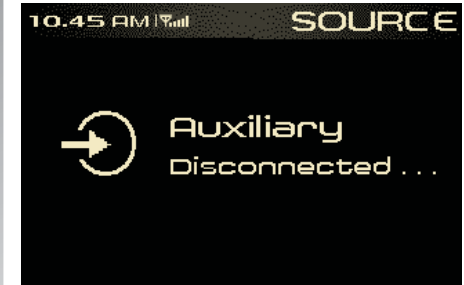

NOTICE

In order to connect additional Aux device, Rear Aux at the rear end of infotainment system can be used

Bluetooth (BT) Functions

The Bluetooth (BT) is a wireless protocol utilizing short-range communications technology facilitating data transmission over short distances from fixed and mobile devices. This product shall support BT 2.1, Class 2 making it possible for devices to communicate within a range of 10 Meters.

The user can enable or disable BT communication with the Infotainment system by selecting the BT on / off in the following path. To enable/disable BT traverse the path **Menu→Bluetooth→Bluetooth ON / OFF.**

Searching from Radio

Searching for mobile phones / devices will be initiated, once the user selects the option “**Find Phones**” from “**Add Device**” of Bluetooth Menu options. The audio unit will initiate the searching for active mobile phones / devices within its range for a maximum of 1 minute. During this time the graphics will show the below screen.

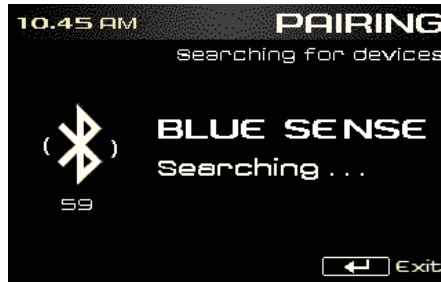

During the search, all buttons on fascia switch / Remote control / Steering Wheel control will be disabled expect for **[POWER] / [EXIT]** button..

On EXIT button press, the list of phones found will be shown or if no device found till the time, then the following screens will popup.

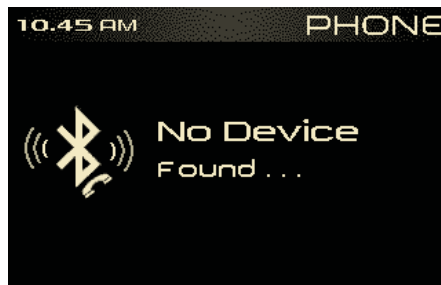

On completion of the search, the list of devices found will be displayed and user can scroll through the list using the volume knob and select the desired one.

Searching from Mobile Phones

Infotainment system will be in discoverable mode for 1 minute and during this period user can search for “**Mahindra Bluesense**” from his/her mobile phone. This mode can be enabled from the option “**Find Bluesense**” under “**Add Devices**” of Bluetooth Menu options.

The system will be in discoverable mode for 1 minute after the menu options is selected. User needs to search for audio devices from his/her mobile phone / BT device. During this time the display will show the following graphics .



Once the key code 1234 is entered in the phone to pair the infotainment Phone and audio device, they will get connected and the pop up screen will be as follows.

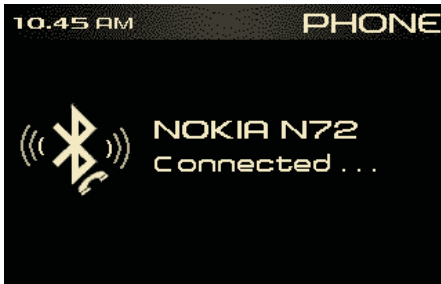

Pairing

Pairing activity will be initiated after the completion of search done through mobile phone / infotainment system. Pairing will be successful once the key code entered is matching.

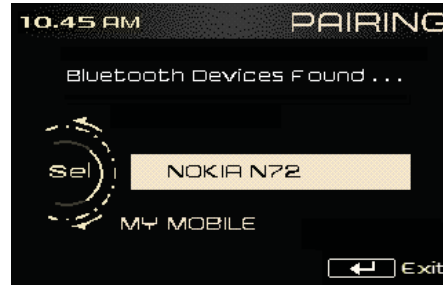

Pairing will fail if there is any BT communication failure. Then the pairing action will be aborted and infotainment system will revert to the previous audio source.

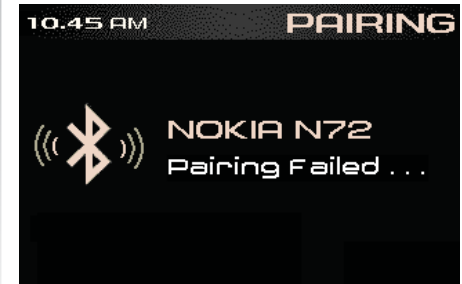

Reasons for the failure to detect / pair with a phone

- Infotainment system powered OFF
- Vehicle speed greater than 5 kmph
- User press [4/⏪] button.
- Ignition key position moved to OFF
- No phones found
- User stops searching in mobile phone or enters wrong Pin number etc
- BT not turned ON
- No slot available for a new Bluetooth device to be paired

The following screens will be displayed in the above cases.



Wrong Pin Entry

If user has initiated the search from mobile phone and if he/she has entered the wrong pin number, the mobile phone will inform the appropriate message. On wrong pin entry case pairing will be failed and there will be a popup screen. Infotainment system will revert to previous audio source.

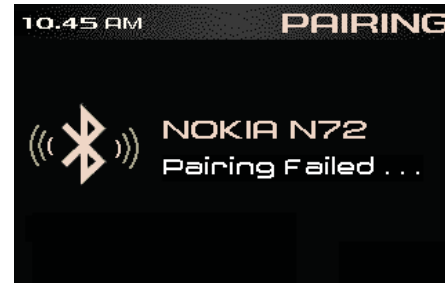

Unpairing / deleting

Device can be deleted from the “Delete Device” option from Bluetooth menu. On selecting the desired device to be deleted the Infotainment will popup following screen.

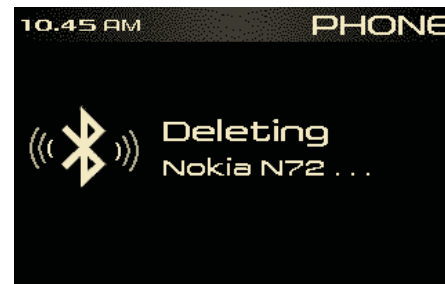

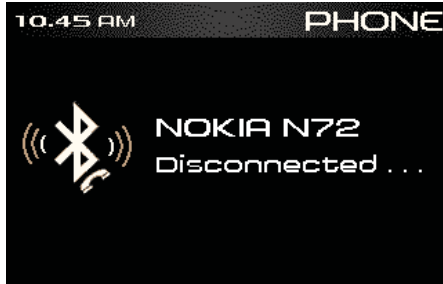

Selecting Phone / Audio connection

By default the last paired device will be connected for both for HFP and audio streaming. However user can also change the device connected to a particular mode using the BT menu options.

- By traversing through this path the connected Audio / Phone device can be changed. Menu→Bluetooth→Audio / Phone Device

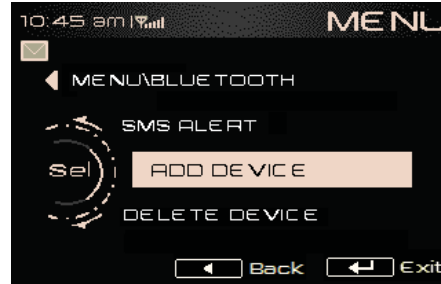

NOTICE

The device already connected will be highlighted with tick (✓) mark.

Disconnection

If user selects the already connected device then it will be disconnected.

Auto Reconnection

Auto reconnection will happen only with the preferred device. If there is no device available to connect, then infotainment shall not change its connection status unless user desire to do so. The device connection status will be indicated with the relevant symbol to user.

NOTICE

Preferred device will be phone already connected in Phone mode.

Bluetooth Music

User can select the music source with short press on the [SOURCE] button. When the connected BT phone is active the music can be played from it. When a BT phone is already connected to the infotainment, the last track that was

played in the BT phone will be initiated. If the BT phone supports AVCRP profile then the track play will be initiated by infotainment, else the play must be initiated by the user.

The following actions on the music tracks can be done from the infotainment provided the BT device supports AVCRP profile

- Next / Previous track selection
- Play / Pause track

Phone Book

User can check the Phone Book with the following entry condition.

- Infotainment in active mode
- Phone device connected and PBAP is supported
- Long press of [LIST / ] button .

If the contacts are not ready to be displayed then the following screen will popup.

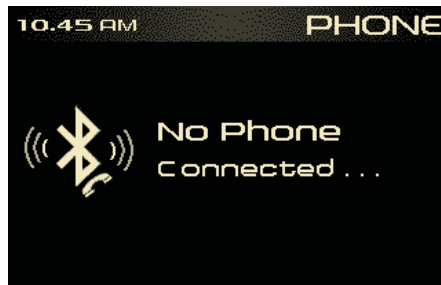

If there is no phone connected and if user long presses [LIST / ] button then there shall be a pop up message for 2 seconds.

NOTICE

- *The phonebook contacts copied to Infotainment system can only be used when the corresponding mobile phone is paired and connected.*
- *Infotainment system may take some time to download the contacts from the mobile phone. Download time varies based on type of mobile phone*

Operations

The first level screen will show the contents of Phone Book with the first contact highlighted as below.



User can scroll through the list or press [▶] to refine search, where user can rotate the volume knob to select the desired character. The alphabets A-Z and numbers 0-9 can be scrolled and any desired character user can press SELECT. There will be 3 characters allowed for searching. With help of [◀] button user can go back one step to refine the search.

If the user presses a SELECT button for character then the control will be transferred back to the contact list, user needs to press [▶] button, enter the next character. Only one selection of the character (s) in the contact list will be updated.



If there are multiple number type per contact then the next level screen will appear. There will be 5 entries per contact namely General, Home, Office, Mobile and other and all of them will be displayed.



On the top the contact name and number will be displayed. Based on the contact type highlighted the number will be updated. If there is no number stored for a particular type then the phone number zone will be empty. User can press the [POWER / SELECT] button of [LIST / ☎] button to make the call.

If there is only one contact number stored against the name then it will take user directly to screen where the number appears and user can make the call using a short press on [LIST / ☎] button.



Incoming Call

An incoming call will be intimated to user with help of the below screens (graphics) and the in-band ring tone as supported by the cell phone. If the in-band ring tone is not supported then a standard tone for incoming calls will be supported.

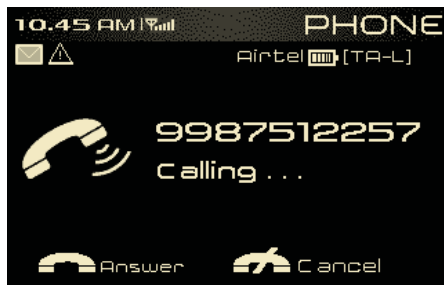

In case of any incoming call the tuner will be muted and other media like CD / USB / iPod / will be automatically paused. Upon the termination of the call the tuner will be un-muted and CD / USB / iPod will resume automatically.



NOTICE

If user rejects the call by pressing Reject button for more than 2 seconds, infotainment will auto answer "The person you are trying to reach is currently driving, please call back later"

Outgoing Call

User needs to traverse through the Bluetooth menu options to select the "Dial a Number". Once the option is selected user can use the key pads 0-9 to enter the digits.



On entering all the required digits user needs to press [LIST / ] button to make the call, else cancel the option with press on [INFO / ] button. At any time user can press 4/↓ button to abort the outgoing call operation. If no valid input is entered then the dialing screen will exit on 30 seconds time-out.

There will be "_" (underscore) mark for the user to understand that number can be entered and user can clear last entered digit with a long press of [◀ / 8] (only one digit will be deleted for a long press).

NOTICE



The cursor cannot be moved by user and will move automatically to next / previous position only. The maximum number of digits that user can enter will be 24. Any further digits entry by user will be ignored.

An outgoing call will be intimated to user with help of the below screens (graphics) and the caller tune as transmitted by the network, else a standard tone for outgoing call will be supported.



Message

User can enable / disable the "SMS Alert" via Menu options. SMS ON / OFF options will be available only if the MAP feature is supported by the phone. The current setting will be highlighted with a tick mark.

If SMS alert is ON then there shall be pop up message for 10 seconds. The pop up shall also have beep tones for indication. User can read / ignore with help of [ / ] button.

If SMS alert is OFF then there shall be no pop-up but instead the notification for an new SMS will be shown with an icon



The infotainment system will read out the SMS with TTS function and also display the contents in the screen. The readout will start after a delay of 2 seconds. If a SMS with more than 160 characters are received, then the system shall read that as two SMS. Only a maximum of 60 characters can be displayed on the screen, user cannot view the rest. However the TTS feature will read out the complete content.

If there are two or more new SMS only the last received can be read out. When SMS is read out, if another message is received, then it will not be indicated (no beep) and only the SMS count will be updated after exiting the reading screen.

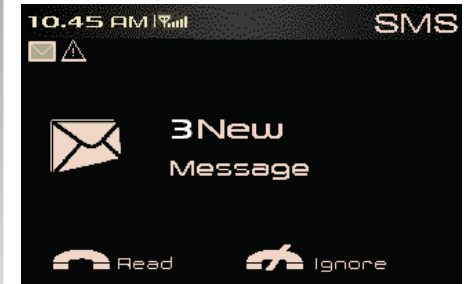
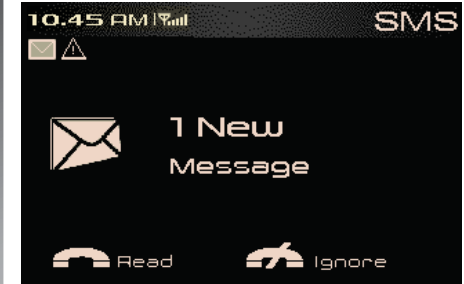

NOTICE

- *Some “special” characters within received SMS message cannot be interpreted by infotainment system.*
- *Bluetooth features like HFP, PBAP, A2DP, AVRCP and MAP are Phone dependent. Please refer your mobile phone owner’s manual for supported profile.*

Steering Wheel Control (SWC)

Audio control

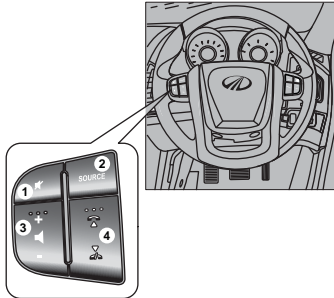

1. **Mute:** Press to mute the audio sound
2. **Source:** Press to change the source like radio and CD
3. **Volume control:** Press (+) to increase the volume. Press (-) to decrease the volume
4. **Phone call accept or reject / Seek**

When Bluetooth function is ON, Press to accept incoming call.

Press to reject incoming call.

When Radio is ON, pressing of or will function as auto seek.

When CD is ON, short pressing of or will change the track and long pressing of or will function as fast forward / reverse.

Cruise control

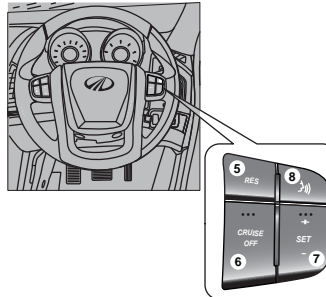

5. **RES:** Press to resume the cruising speed
6. **CRUISE OFF:** Press to suspend / cancel the cruising speed

7. **SET (+ / -):** Press (+) to increase the cruising speed. Press (-) to decrease the cruising speed

Voice Recognition

8. : Press to activate voice recognition function

Voice Recognition (VR)

When the PTT (Push To Talk ) button is long pressed, infotainment system will enter into the VR mode. Once the PTT button is long pressed the following screen will be displayed.



User needs to wait for the voice feedback “Please say a command” followed by a beep sound, to activate the voice command as listed in later sections. Voice recognition will have 3 retries including the initial session if there is a failure in recognition. Voice recognition can be initiated again by pressing PTT

button. During VR session volume up and down operation is possible and the action will take place in the background but there will not be pop up for displaying volume increase or decrease.



If the VR engine is not started then the following screen will be displayed



Supported Languages

1. U.S. English
2. U.K. English

NOTICE

By default U.S. English is enabled, user can change the language at Mahindra Authorized dealer end.

Voice Commands

CD/USB/iPOD

Press PTT  button for more than 2 sec, wait for a feedback with beep sound and say command ⇨ "CD" or "USB" or "iPod" (as user needs)

The following sub commands can be activated in CD/USB/iPod mode

1.Next Track

Press PTT  button for more than 2 sec, wait for a feedback with beep sound and say command ⇨ "NEXT"

2.Previous Track

Press PTT  button for more than 2 sec, wait for a feedback with beep sound and say command ⇨ "PREVIOUS"

3.Repeat Track

Press PTT  button for more than 2 sec, wait for a feedback with beep sound and say command ⇨ "REPEAT"

4.Shuffle/Random All

Press PTT  button for more than 2 sec, wait for a feedback with beep sound and say command ⇨ "SHUFFLE" or "RANDOM"

BLUETOOTH AUDIO

Press PTT  button for more than 2 sec and say a command ⇨ "BLUETOOTH AUDIO"

The following sub commands can be activated in Bluetooth audio mode

1.Next Track

Press PTT  button for more than 2 sec, wait for a feedback with beep sound and say command ⇨ "NEXT"

2.Previous Track

Press PTT  button for more than 2 sec, wait for a feedback with beep sound and say command ⇨ "PREVIOUS"

AUXILLARY IN

Press PTT  button for more than 2 sec and say a command ⇨ "AUXILLARY IN"

TUNER

Press PTT  button for more than 2 sec, wait for a feedback with beep sound and say command ⇨ "Radio"

The following sub commands can be activated in Tuner mode

1.Tuning to the desired frequency

Press PTT  button for more than 2 sec, wait for a feedback with beep sound and say command ⇨ "TUNE 98.3" (user can say any frequency in the AM/FM range)

2.Channel selection

Press PTT  button for more than 2 sec, wait for a feedback with beep sound and say command ⇨ "SELECT MEMORY ONE" (user can say any channel number between 1 to 6)

S.No	Currently Playing	Voice Command to activate
1	Tuner (FM/AM)	<CD>, <USB>, <iPod>, <BLUETOOTH AUDIO> <AUXILLARY IN>
2	Tuner	<FM> / <AM> <TUNE-- > (E.g., <TUNE 98.3> <SELECT MEMORY --> (E.g., <SELECT MEMORY ONE>
3	CD/USB/iPod	<NEXT>, <PREVIOUS>, <SHUFFLE> / <RANDOM>, <REPEAT>
4	Bluetooth Audio	<NEXT>, <PREVIOUS>,

NOTICE

- ***The user should understand that Voice recognition errors are inherent in the process. Neither Mahindra nor its Suppliers shall be liable for any damages arising out of errors in the Voice recognition process.***
- ***Voice recognition performance depends on the user's pronunciation and accent of the voice.***

Vehicle Information

Theft Deterrent lock

On every ignition cycle the audio unit will do an authentication with the EMS module to avoid theft and miss configuration.

VIN mismatch will lead to total shut down or move the audio unit to a locked state. Please contact an Authorised Mahindra Dealer to rectify this.

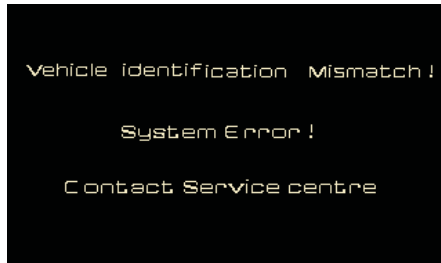

RPAS (Rear Parking Assist System)

The RPAS is designed to assist the user in parking or driving the vehicle in reverse gear. The display system will warn the user about the obstacles present near the vehicle rear side, so that the user can safely drive the vehicle.

When the RPAS is active, the audio source will not interrupted and RPAS tones will be played along with the existing audio if obstacles are found

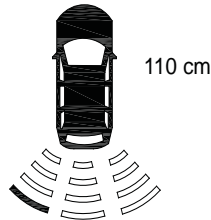
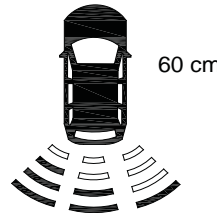
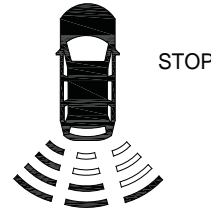



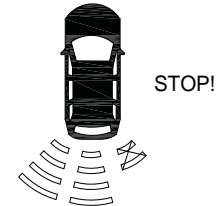
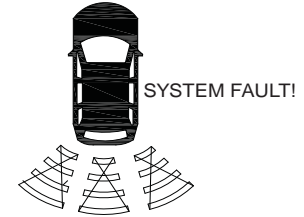

If display bars in any one of the sides / all sides are displayed with cross marks, contact an Authorised Mahindra Dealer.





Air Conditioning System Details

The display will show the different HVAC status as described below

Display Screen	Description
 <p>The screen displays '10.45 AM', signal strength, and 'AC-MODE'. It features a car icon with a defrost symbol (a person with a snowflake) and a circular arrow indicating recirculation. At the bottom, it shows 'AC on' and 'ECON'.</p>	<p>Defrost action and recirculation is taking place</p>
 <p>The screen displays '10.45 AM', signal strength, and 'AC-MODE'. It features a car icon with an arrow pointing to the upper air outlet and a person icon. At the bottom, it shows 'AC on' and 'ECON'.</p>	<p>Upper Air Outlet. Fresh air is blown towards the face of the driver</p>

Display Screen	Description
 <p>The screen displays '10.45 AM', signal strength, and 'AC-MODE'. Below the car icon, it shows 'Auto AC on Econ'.</p>	<p>Upper and Lower Air outlet: Air is blown towards the face and legs of the driver</p>
 <p>The screen displays '10.45 AM', signal strength, and 'AC-MODE'. Below the car icon, it shows 'AC on Econ'.</p>	<p>Defrost and Lower Air Outlet</p>

Display Screen	Description
	<p>User can adjust the desired cabin temperature</p>
	<p>This will indicate the status of the HVAC system</p>

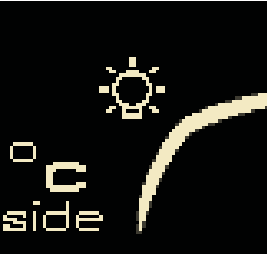
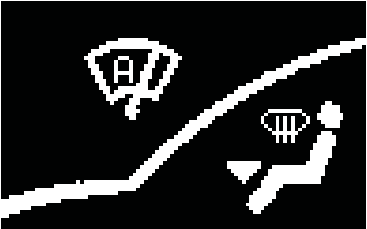
Display Screen	Description
	Auto High Beam ON
	Auto Wiper ON

Driver Information (DI)

The driver information can be activated by a short press on the [INFO / ] button. On entering the DI screen the following message will be displayed

- Distance to empty shows the maximum distance that the vehicle can travel with the available fuel
- Average Fuel consumption shows the overall mileage of the vehicle



TPMS / Tyretronics

User can enter the TPMS (Tyre pressure monitoring system) screen (Tyretronics) on short press of [INFO / ] button if TPMS is enabled.



This will display the features of the tyre like pressure and temperature for all the 4 wheels including the spare wheel. It also gives an alert if there is any air leakage. This feature is available only on select models.





OK - Will be the display for tyre pressure on all tyres unless low pressure / high pressure / air leakage is not present for that tyre.

NOTICE

The tyre with alert will be highlighted in grey color.



Tyretronics Screen	Description
	<p>This alert is an indication of extremely high temperature in the tyres</p>
	<p>This alert is an indication that the tyre pressure has dropped below the critical level</p>



Tyretronics Screen	Description
	<p>This alert is an indication that the tyres have been inflated beyond the maximum acceptable pressure</p>
	<p>This alert is an indication that there is a leakage of air in the tyres</p>

Alerts

The below alert icon will be displayed if there is a alert logged for display in the alerts screen

It will be deactivated if the Alert screen is visited by user (using **[INFO / A white warning icon consisting of a large exclamation mark centered within a white equilateral triangle. The entire icon is set against a solid black square background.**

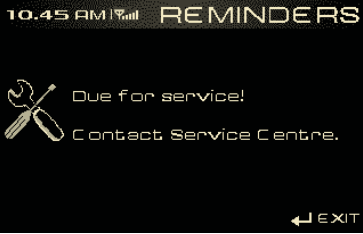
Display Alert	Description
 <p>The image shows a digital display with a black background. At the top left, it shows '10:45 AM' and a signal strength icon. To the right, the word 'ALERT' is displayed in large white letters, with 'Contact Service Centre' below it. In the center, there are two circular icons with exclamation marks, followed by the text 'Front brake pad worn out!' and 'BRAKE Drive with reduced speed.'. At the bottom right, there is a left-pointing arrow icon and the word 'Exit'.</p>	<p>This is an alert indicator when front brake pad is worn out. Contact your nearest Authorised Mahindra Dealer to replace the brake pad</p>
 <p>The image shows a digital display with a black background. At the top left, it shows '10.45 AM' and a signal strength icon. To the right, the word 'ALERT' is displayed in large white letters, with 'Contact Service Centre' below it. In the center, there are two circular icons with exclamation marks, followed by the text 'Low brake fluid level !' and 'BRAKE Drive with reduced speed.'. At the bottom right, there is a left-pointing arrow icon and the word 'EXIT'.</p>	<p>This alert is flashed when the brake fluid level is low in any of the four wheels. Contact your nearest Authorised Mahindra Dealer</p>

Display Alert	Description
	<p>This is an indication that the vehicle needs to be serviced. Regular servicing of the vehicle is necessary to ensure the peak performance of the vehicle.</p>
	<p>This alert is an indication that the air filter is clogged with dust particles. Clean the air filter or replace it at the nearest Authorised Mahindra Dealer</p>

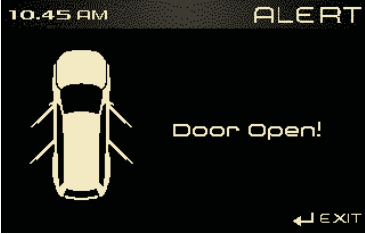
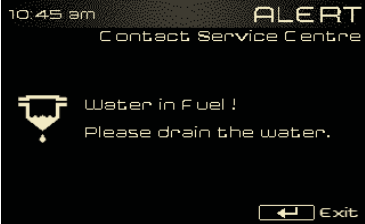
Display Alert	Description
	<p>This Alert is an indication that the door is not properly closed. This might compromise the safety of the passengers inside the vehicle. Ensure all the doors are properly closed.</p>
	<p>This alert is flashed when Water in fuel is detected; need to clean the fuel filter.</p>

Abbreviations

Acronym	Description
HFP	Hands Free Profile
CD	Compact Disc
RDS	Radio Data System
CDDA	Compact Disc Digital Audio
WMA	Windows Media Audio
HVAC	Heating Ventilation Air Conditioning
TPMS	Tire Pressure Monitoring System
EMS	Engine Management System
TA	Traffic Announcement
AVRCP	Audio/Video Remote Control Profile
PBAP	Phone Book Access Profile
A2DP	Advanced Audio Distribution Profile
MAP	Message Access Profile
TTS	Text To Speech
PTT	Push To Talk

NOTICE









- *Bluetooth® is a Bluetooth® SIG, Inc registered trade-mark.*
- *Nokia® is a Nokia Corporation registered trade-mark.*
- *The other trade-marks are proprietary of the respective Companies.*
- *All features described herein are subjected to availability depending on vehicle variants*

Level 3 - Audio Infotainment System (if equipped)



Bezel and Button Functions

This Switch Bank contains 19 buttons and volume knob. The bank will be illuminated if the head lamps are turned on.

NO.	KEY NAME	FUNCTION / DESCRIPTION
1	VOL/POWER/SEL	Power ON / OFF, Select
2	VOL/POWER/SEL (Rotary)	Volume Up / Down
3	MUTE	Mute / Un-mute Audio Sources
4	VIDEO	Video playback from source
5	EQ	Equalizer adjustments
6	 Now Playing	Change the screen to the current source play screen
7		Audio, video, list browse up / Previous page / Phonebook browse up
8		Audio, video, list browse down / Next page / Phonebook browse down
9	SEEK 	Tuner seek down / Previous track / Fast Rewind
10	SEEK 	Tuner seek up / Next track / Fast Forward
11	LIST	List browse screen
12	TA	Traffic enable / disable
13	MENU	Menu setting options
14	INFO	Infotainment will change the display to vehicle info screen
15	NAV	Navigation mode selector
16	 PHONE	Bluetooth phone selector / Accept a phone call / Display phone menu
17	HOME	Home screen selector
18	MUSIC 	Music mode selector / call rejection
19	RADIO	Tuner mode selector
20	EJECT 	Disc eject

Features

- Touch screen color display
- AM / FM tuner
 - Auto Seek with RDS
 - 18-FM and 12-AM manual/Auto preset store
- CD, CD VIDEO,DVD, USB, iPod
 - Supports CDDA, MP3, WMA9, Divx, MPEG4
 - Browsing
 - Random / Repeat
- AUX Audio Input
- Bluetooth (BT)
 - Hands Free
 - Phone Book Access
 - Music Streaming
- Audio adjustments
 - Bass, Treble, Balance, Fade
 - Normal, Classic, Pop, Jazz, Rock
 - Mahindra Modes
- Infra Red Remote Control
- Voice Recognition
- GPS Navigation
- Rear View Camera Support*

- Rear Seat Entertainment system*
- Steering Wheel Support
- Power Output - 4x25 Watts

* Features described herein are subjected to availability depending on vehicle variants. Please contact authorised personal for more information.

Controls

Display

The Infotainment system is capable of displaying Audio, Video, Navigation & vehicle information's such as Tuner (AM/FM) stations, Audio track/folder etc. and fuel consumption / tyre pressure, Reverse Parking/ Rear View information's and etc.

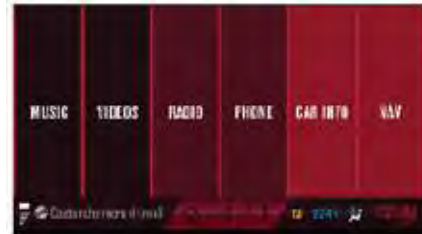

Base screen will be as shown in the above picture. User can select from the options.

MUSIC: User can select this option to access for playing audio files from different sources CD, DVD, USB, iPod, Bluetooth Music, Auxiliary inputs.

VIDEO: User can select this option to access for playing video files from available sources of CD, DVD, USB, iPod.

RADIO: User can select this option to access for playing from radio (AM/FM) stations.

PHONE: User can select this option to access Bluetooth phone operations.

CAR INFO: User can select this option to view vehicle related information's such as tyre pressure, Fuel consumption & etc.,

NAV: User can select this option to enter NAVIGATION mode.

Refer relevant sections for more details.

Switch Bank



Switch Bank Contains 19 buttons and volume knob. The switch bank will be illuminated if the head lamps are turned on. For button functions refer below table:

Switch NO	SB Button	Functionality
1	MUTE	<ul style="list-style-type: none"> • Mute the Current Audio and Pause the CD, USB/iPod music or Video play or un-mute the audio if it is muted already. • Will not mute the RPAS chime sound and Navigation audio • Mute from Phone mode
2	VIDEO	<ul style="list-style-type: none"> • When the infotainment is not in the Video mode, change it to Video mode if there is a valid Video source is available • When the infotainment is in Video play mode and not in the video play screen change the screen to video play screen (From list screen, NAV etc...)
3	EQ	<ul style="list-style-type: none"> • Change the current screen to Equalizer settings screen
4	Now Playing	<ul style="list-style-type: none"> • Change the Screen to the current source play screen, from any settings screen, navigation screen and etc.

Switch NO	SB Button	Functionality
5	▲	<ul style="list-style-type: none"> When the infotainment is in LIST screen (CD, USB, and iPod Browse) short press will move the browser up When the current selection is on top page short press will change to previous page and the selection will be in the last position When the infotainment is in LIST screen (CD, USB, and iPod Browse) Long press will move the browser to previous page When the infotainment is in phone contacts menu short press will change to previous page When the infotainment is in Phone contacts menu long press will change to the name with the previous character if any
6	LIST	<ul style="list-style-type: none"> Infotainment will change to browse screen when it is in CD, USB or iPod source When the infotainment is in Browse screen short press will change to play screen
7	TA	<ul style="list-style-type: none"> Toggle the current TA setting from ON and OFF. If the setting change from OFF to ON radio will initiate Traffic Program seek
8	MENU	<ul style="list-style-type: none"> Infotainment will change to setup screen When the infotainment is in Setup screen radio will change to the currently active screen
9	INFO	<ul style="list-style-type: none"> Infotainment will change the display to Alert screen
10	◀◀	<ul style="list-style-type: none"> When the Infotainment is in tuner mode, Short press will initiate tuner seek in down direction When the Infotainment is in CD or USB or iPod or BT Audio mode, Infotainment will change to previous track When the Infotainment is in CD or USB or iPod mode long press will Fast Rewind the current track

Switch NO	SB Button	Functionality
11	▼	<ul style="list-style-type: none"> • When the Infotainment is in LIST screen (CD, USB, and iPod Browse) short press will move the browser down • When the current selection is on bottom, short press will change to next page and the selection will be in the first position • When the Infotainment is in LIST screen (CD, USB, and iPod Browse) Long press will move the browser to next page • When the Infotainment is in phone contacts menu short press will change to next page • When the Infotainment is in Phone contacts menu long press will change to the name with the next character if any
12	▶▶	<ul style="list-style-type: none"> • When the Infotainment is in tuner mode, Short press will initiate tuner seek in up direction • When the Infotainment is in CD or USB or iPod or BT Audio mode, Infotainment will change to next track • When the Infotainment is in CD or USB or iPod mode long press will Fast Forward the current track
13	NAV	<ul style="list-style-type: none"> • If the Infotainment is in any screen (other than navigation) short press will take to Navigation screen
14	PHONE	<ul style="list-style-type: none"> • When there is an incoming call Infotainment will accept the incoming phone call • When there is an second incoming call Infotainment will accept the second incoming phone call and put the ongoing call into hold • When the Infotainment is not in the phone mode short or long press will change the Infotainment display to Phone menu
15	HOME	<ul style="list-style-type: none"> • Infotainment display will be changed to Home screen • Button press will be ignored when the Infotainment is in Home screen, Phone mode (Call active) and RPAS
16	MUSIC	<ul style="list-style-type: none"> • When the Infotainment is not in MUSIC mode, Infotainment will change to MUSIC mode if there is a valid Music source available

Switch NO	SB Button	Functionality
17	RADIO	<ul style="list-style-type: none">• When the Infotainment is not in the tuner mode, Infotainment will change to the tuner mode (previously played band and frequency)
18	EJECT	<ul style="list-style-type: none">• Eject the disc if exist in the mechanism
19	VOL/POWER/SEL	<ul style="list-style-type: none">• When the Infotainment is ON Long press will switch OFF the system• When the Infotainment is OFF, short press will switch ON the Infotainment system• When the Infotainment is in Browse or Phone contact screen, Short press will activate the current selection
20	VOL / POWER / SEL (Rotary)	<ul style="list-style-type: none">• Clockwise adjustment of rotary knob will increase the primary audio source volume• Counter Clockwise adjustment of rotary knob will decrease the primary audio source volume





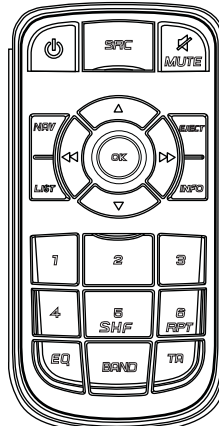

Steering Wheel Control

Refer to the “**Steering Wheel Control**” section page no 6-1 for detailed operation.

Remote Control



The Infrared based remote control shall have 21 buttons and provide all the features of fascia switches. However the activities relating to HFP access of Bluetooth and setup will be disabled.

KEY	KEY NAME	FUNCTION / DESCRIPTION
1	POWER 	Turn ON/OFF of the radio
2	SOURCE	Interchange Media Sources
3	MUTE 	Mute / Un-mute Audio Sources
4	MOVE UP 	Move Up on the List / Volume +
5	MOVE DOWN 	Move Down on the List / Volume -
6	OK / SELECT	Select Menu Option
7	EJECT	Eject the DISC
8	PREVIOUS 	Select Previous track
9	NEXT 	Select Next track
10	1	Recall or save Preset memory 1
11	2	Recall or save Preset memory 2
12	3	Recall or save Preset memory 3
13	4 	Recall or save Preset memory 4
14	5 / SHF	Recall or save Preset memory 5 / Shuffle
15	6 / RPT	Recall or save Preset memory 6 / Repeat
16	EQ	Equalizer Adjust
17	BAND	Interchange tuner bands (AM 1/2, FM 1/2/3)
18	TA	Traffic Enable / Disable
19	NAV	Active Navigation
20	LIST	Enable CD / USB / iPod Browsing
21	INFO	Enable Vehicle Information Display

Touch Panel Control

This system has a resistive type touch panel. User can select the desired option in the screen using his / her finger or stylus. Use of knife or any sharp item is not preferred. On selection the selected item color shall change as an acknowledgement.

DVD/CD Handling

DVD/CD Opening cleaning

As dust tends to accumulate at the CD opening, clean it up periodically. Remember that your compact disks (CD) may be scratched if inserted into the CD opening with accumulated dust.

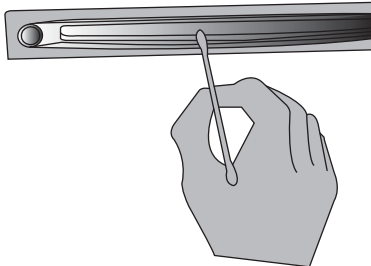

DVD/CD Care and maintenance

As dust tends to accumulate at the CD opening, clean it up periodically. Remember that your compact disks (CD) may be scratched if inserted into the CD opening with accumulated dust.

CAUTION

Your audio unit may be damaged if improper objects are inserted into it, like credit cards or coins, through the CD opening.

Precautions regarding operation

- If your car has been parked under the hot sun, let the unit cool down before activating it.
- Be careful not to let juice or soft drinks drip on the unit or on the disks.

Wetness Condensation

- In a rainy day or in a very humid region, humidity may be condensed inside the laser reading lenses and on the unit display. If it happens, the unit will not work properly. In this case, remove the disk and wait for about one hour until the humidity has evaporated.

DVD/CD Handling

- Do not touch the CD recorded surface.

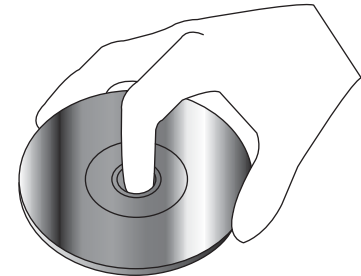

- Do not place them exposed to direct sun light (over the seat or control panel, etc.) or under high temperature.

- Keep the CDs on their boxes or in any other that protects them from being scratched.
- Do not place adhesives or others on the CD. Also, do not use a CD with an adhesive.
- Due to their manufacturing process, CD-R and CD-RW are more susceptible of being damaged than a common musical CD (Compact Disk). Use a CD-R or CD-RW after reading the precaution items in the CD labeling.

CD Accessories

- Do not use disk accessories.
- Do not stick labels or use disks with sticky paints / residues. Disks may stop rotating when used, causing defects or they may be damaged.

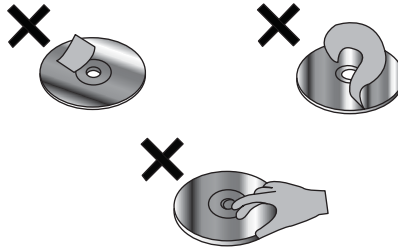

CAUTION

The CD, AUX, Bluetooth, iPod options can be selected only if devices are available. Tuner option will always be available.

CD Cleaning

- Clean CDs using a soft and dry cloth. Movements shall always be made from the center to the edge of the disk and in a soft way.

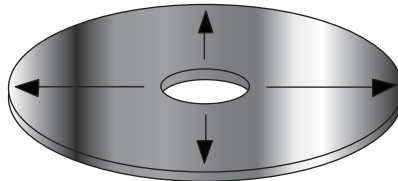

CDs Removal

- When removing the CDs from this unit, store them at the horizontal position.

DVD/CDs that cannot be used

- CDs which are not round shaped cannot be used.

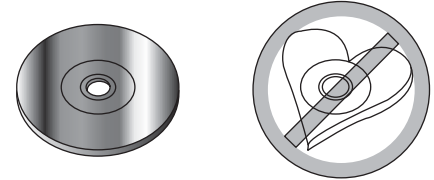

- DVD/CDs painted in the recording surface, or those which are dirty cannot be used.
- Do not use DVD/CDs without the disc mark.



- It is not possible to reproduce a DVD/CD-R or DVD/CD-RW which has not been formatted. (For the formatting process consult your DVD/CD-R / CD-RW software and the instructions manual of the DVD/CD-R / CD-RW recorder.
- DVD/CDs of 8 cm (80mm) size.

Music disks encoded with copyrights protection

This product has been designed to reproduce disks that comply with the Compact Disk (CD) standard. Recently, some labels have commercialized several encoded music disks with copyrights protection.

It should be noted that, among those disks there are some which do not comply with the CD standard, and it might not be possible to reproduce them in this audio unit.

Disk Labels

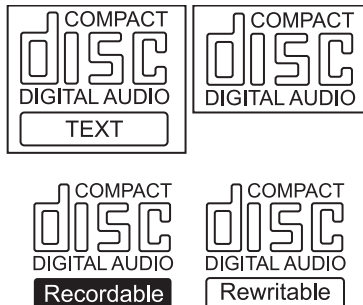

⚠ CAUTION

Some CD-Rs / CD-RWs (depending on the equipment used for recording or the disk condition) might not be played in this unit.

Operations

General Operations

The following discrete modes are possible in the audio

1. SLEEP Mode (Radio OFF)
2. ACC ACTIVE mode
3. NORMAL mode (Radio Active)

4. DISPLAY OFF state

1. SLEEP Mode (Radio OFF)

The system will enter SLEEP mode from normal/accessory active mode, when the key is changed to OFF position. When the system is in Sleep mode, there shall be no illumination in display. No key operations in IR RC/ SWC / Fascia switch will be recognized except [EJECT] button. CD Load & Switch illumination (when enabled) will work in SLEEP mode

2. ACC Active Mode

System enters into this mode when key is in ACCESSORY position and infotainment is turned on. All audio features are active for maximum of 1 hour, and the display is active. Driver Information's are disabled in this mode.

3. Normal Mode / Radio Active

System enters into this mode, when key is in RUN position & infotainment is turned on. The infotainment will be fully functional in this mode. The system can recall the last played track of CD or USB, when the system powered off and on by user.

4. Display OFF Mode

If user press [POWER] button for more than 2 seconds, Infotainment will be powered OFF. All the audio functions will be deactivated in this mode.

Power / Select

Power/Select button located in centre knob of the fascia switch. The infotainment shall be powered off by pressing this button for more than 2 seconds. Single press of this button shall turn ON the power again. When the user is in MENU/ Phonebook/Equalizer/ List screen, user can press [Power/Select] button to select the options to activate it or enter into the sub menu/folder.

Volume knob

Volume can be increased or decreased by turning the volume knob in clockwise and anti-clockwise direction. Audio volume can be adjusted in Tuner, CD, DVD, AUX, iPod and Bluetooth modes. Volume knob also used to change the options in MENU/ Phonebook/Equalizer/ List screen.



Refer relevant sections for details.

Home

Short Press will take the user to the HOME Screen. From there user can go to the desired Mode.

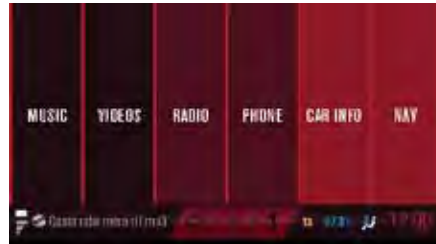

Settings

The user can enter into the setting screen via [MENU] button short press; User can press the desired setting.

- General Settings → VR Language selection, Display units, SMS alert ON/OFF & ID3 Tags.



- Display Settings → Display Brightness adjustments and Sleep display (The infotainment system will enter into Display OFF or CLOCK mode based on setting during power OFF)



- Clock Settings → Date and Time Adjustments

- Tuner Settings →RDS ON/OFF
- Bluetooth Settings →Managing all BT related functions
- Sound Settings →Bass, Treble, Balance and Fader

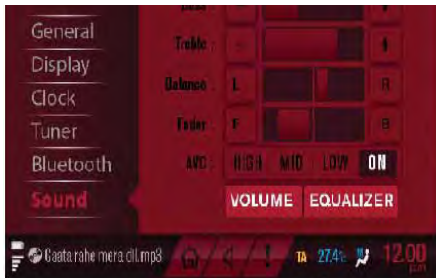

Users can Adjust Navigation volume as well as Mute the start up animation using Menu →sound →Volume screen as shown below.



Bass / Treble / Balance / Fader Control

The Bass / Treble /Balance / Fade level will be adjustable. Default level setting for all these will be zero

When the **Bass** level is set to minimum the low frequency components in the music will be fully attenuated and if set to maximum the low frequency components will be fully amplified.

When the **Treble** level is set to minimum the high frequency components in the music will be fully attenuated and if set to maximum the high frequency components will be fully amplified.

The **Balance** setting is used to adjust the audio output between the left and right speakers.

The **Fader** defines the relative audio output of the front and rear channels.

The same Bass/Treble/Balance/Fade level will be used by the tuner, CD, AUX audio sources.

Equalizer

User can enter into Music mode Selection screen via **[EQ]** button short press. The music modes available are Jazz, Pop, Rock, Classic, Voice, Normal and Mahindra Music Modes. Whenever any of these modes is selected, the corresponding music effects will be implemented into the current playing track

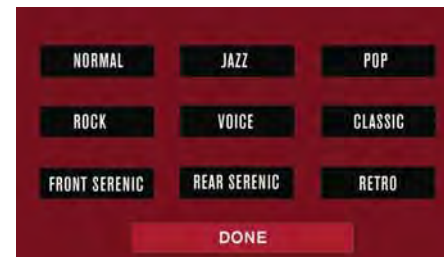

Speed Volume

The Infotainment system has the function Speed Volume Control; user can enable and adjust this option through "**Sound Settings**" screen (AVC). If this function is enabled, the volume will be adjusted automatically according to the car speed. In this case, the display doesn't show when the volume is changed.

Mahindra Music Modes

User can avail the 3 pre-defined equalizer settings

1. **Front Serenic:** When user selects this option, the audio will be available only in the front speakers
2. **Rear Serenic:** When user selects this option, the audio will be available only in rear speakers.
3. **Retro:** When user selects this option, the audio will be available in all 4 speakers with predefined Bass and Treble settings.

User can enter into this mode via **[EQ]** button short press.

Clock

Clock setting

- Clock setting is available under menu option.
- Synchronize to GPS time
 - If the box is enabled, Infotainment time will be synchronized with GPS time. and NO user setting is required

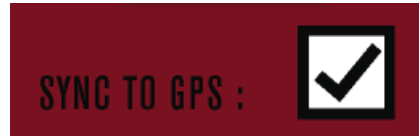

Mute

- SP on **[MUTE]** button in fascia switch or Steering wheel switch will mute the audio.
- Infotainment will display "Audio Mute" when the current source is Radio, Aux and BT Audio.
- Infotainment will display "Audio Pause" when the current source is CD/USB/iPod.
- Infotainment will not pause the current audio when the volume is reduced to zero.

Info

A short press on the **[INFO]** button in fascia switch will take you into the INFO screen.

- Fuel Info → Mileage and Distance To Empty information's

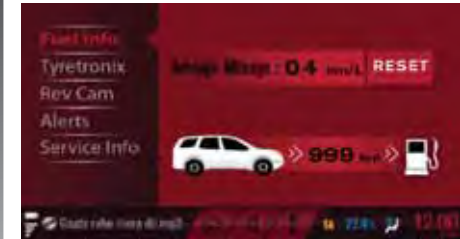

Average Mileage Value can be reset using the RESET button provided on the Touch screen

- Tyre Tronics → Tyre pressure and Leakage alerts

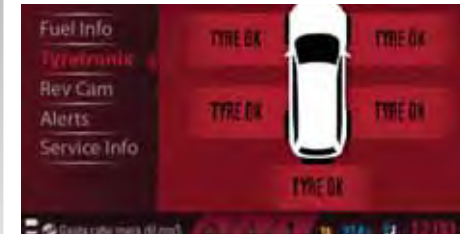

Alert will POP UP when there is low pressure / High pressure or Air leakage Alerts in any of the tires

- Rev Camera → Reverse camera

- Alerts → Any active alerts (Door open, Tire pressure, Vehicle related)
- Service Info → Service related alerts

List (Browsing)

User can view the current media file structure using this list operation (Short press on **[LIST]** button). User can browse the contents of the media without affecting the music playing. User can rotate the volume knob and select the desired location. The path of the current selection will also be shown/ updated. When a track is selected it will play and if a folder is selected all the tracks within it will be shown. Only valid files / folders will be shown in this screen. The icons for Files / Folder / Active folder will be shown distinctively.

The current playing track will be shown with a tick mark in case of CD/USB. For iPod the entire iPod contents will be shown by default.



User can navigate within folders/tracks using the touch screen buttons or use [] to reach root folder.



Tuner

User can enter into this mode via **[RADIO]** short press in fascia switch or in "HOME" screen touch select. The tuner mode shall play the audio from regional broadcasted station, provided it meets the AM / FM / RDS transmission specification.

Radio reception: Always memorize the desired stations using the radio memory keys. This will help you in selecting the desired station in a faster manner.

AM Reception (Medium Waves):

At most conditions, strong AM signals provide stable sound quality and with low signal noise. At night, however, the atmospheric conditions may sometimes lead to interference from other stations.

FM Reception:

FM zone offers best quality sound reception; however, the signal intensity may be subjected to noise caused by

- Limited reach of some transmitters
- Distortion caused by signals reflected in local buildings and other obstructions
- "Shadow zones" wherein the signal reception is obstructed or restricted

Band selection

If radio is already active, a short [BAND] button press will change the selected frequency band in order of FM1→FM2→Auto FM→AM1→Auto AM→FM1. For example, if radio is currently in FM1 band, a short press of [BAND] button will make the radio change to FM2 band. Long Press on [BAND] button has no action.

Auto Seek

In tuner mode, the user can execute an automatic seek for the next active radio station broadcast within the currently selected frequency band

- The user can execute a downward frequency auto seek by a short [◀◀] button press in fascia switch or long [◀] button press in touch selection.

- The user can execute an upward frequency auto seek by a short [▶▶] button press in fascia switch or long [▶] button press in touch selection.

Preset Memory

To Store a Station (1 to 6)

- Preset functionality allows storing or selecting a given radio frequency within one of the reception ranges (FM1, FM2, Auto FM and AM1, Auto AM).
- Press & hold preset button [1]... [6] in touch screen will overwrite the previously stored frequency in that memory location with the current frequency.
- When the display shows the following image a long press on button #1 stores the current frequency and gives a beep sound as indication of storage.

Recalling A Station

Short press of a preset button [1]... [6], in touch screen recalls the radio station frequency from memory; the tuner will change to this recalled frequency.

RDS (Radio Data System) (if equipped)

The Radio Data System (RDS) is used to extract additional radio station information contained with the FM signal.

RDS data provides the following information:

- Radio station name
- Program type
- Traffic announcement broadcasts

If an RDS signal is received then the station name will be automatically displayed.



User can enter into this settings screen via [MENU] button short press in fascia switch.

Traffic News & Announcements (TA)

RDS radio stations have the ability to broadcast special traffic announcements (TA) and news during their normal radio broadcast. The radio will handle these as a special type of broadcast and interrupt the current audio source to play the announcement.

A short press on the TA button will enable/disable the Traffic program alerts. Similarly the news alerts can be activated through tuner menu selection.

NOTICE

TA feature may work only if Traffic announcement broadcast is available.

Playing a Media (CD/DVD/USB/iPod)

When ever a new CD / iPod / USB device is connected there shall be an appropriate pop up message to user.



NOTICE

• Video will not be shown in infotainment display, if the vehicle is moving. But the audio for the video DVD will work. This is to avoid diversion of drivers attention. However the video will work for seat mounted displays (if equipped). During power ON, after the Mahindra logo display, a message will pop up saying "some of the features are not available while driving" for few seconds

• It is advisable not to use USB devices equipped with the "password" function. If the USB device is equipped with this function, always ensure that the function is disabled.

Playing Tracks

Whenever any CD/USB/iPod is plugged into the audio the very first track will be played by default. User can press the [◀◀] / [▶▶] buttons in fascia switch or press [◀] / [▶] in touch screen and

select the desired location. The radio can also display filename, folder name, ID3 (title, artist, album), genre of the current track. The default display content is Track number and playing time.



Repeating Tracks /Folder

When user wants to repeat the current playing song or folder, a short press on the [RPT] button in touch screen will enable the repeat option. The options change in the following sequence Repeat Track → Repeat Folder → Repeat off. By default Repeat off is activated.

Shuffle

When user wants, all the songs to be played in a random fashion a short press on the [SHF] button in touch screen will enable the random options. The options change in the following sequence Shuffle All → Shuffle off. By default random off is activated.

Ejecting a DVD/CD/USB/iPod

A short press on the eject button will eject the CD.

It is always preferred to remove the USB / iPod only when the radio is powered off. Upon CD/USB/iPod removal, system play the audio from previously played source.

Playing an AUX

AUX jack connection will make the radio change to AUX mode automatically. Whenever an Aux device is connected there shall be an "AUX DEVICE CONNECTED." message displayed in system.



if there is an external auxiliary audio input from the bezel AUX connector, the audio can be output via the speakers of the radio.

During the AUX play, user cannot control the music played though the audio head unit. Operation like, seek track, fast forward/ rewind etc., can be done only through the connected device.

Whenever the Aux device is disconnected there shall be an "AUX DEVICE DISCONNECTED" message displayed in system.

NOTICE

In order to connect additional Aux device, Rear Aux at the rear end of infotainment system can be used, provided it is facilitated only by authorized personal.

Bluetooth (BT) Functions

The Bluetooth (BT) is a wireless protocol utilizing short-range communications technology facilitating data transmission over short distances from fixed and mobile devices. This product shall support BT 2.1, Class 2 making it possible for devices to communicate within a range of 10 Meters.

The user can enable or disable BT communication with the Infotainment system by selecting the BT on / off in the following path. To enable/disable BT traverse the path **Menu (fascia switch) - Bluetooth (touch selection) - Bluetooth ON/OFF or PHONE (touch selection in home screen) - Bluetooth ON/OFF**



Searching from Infotainment

Searching for mobile phone / devices will be initiated, once the user selects the option "ADD" of Bluetooth settings screen. The infotainment system will initiate the searching for active mobile phones / devices within its range for a maximum of 1 minute. During this time the graphics will show the below screen.

During the search, all buttons on fascia switch / Remote control / Steering Wheel control will be disabled except for [POWER] button in fascia switch and [EXIT] button in touch screen.

On EXIT button press, the list of phones found will be shown or "No device connected" screen will popup.

On completion of the search, the list of devices found will be displayed and user can select the desired one

Searching from Mobile Phones

Infotainment system will be in discoverable mode for 1 minute and during period user can search for the "Mahindra Bluesense" from his/her mobile phone. This mode can be enabled from the option "Discover" of Bluetooth Menu options. The system will be in discoverable mode for 1 minute after the menu options is selected. User needs to search for audio devices from his/her mobile phone / BT device. During this time the display will show the following graphics.

Once the key code 1234 is entered in the phone to pair the Phone and infotainment system will get connected and the pop up screens will be as follows.

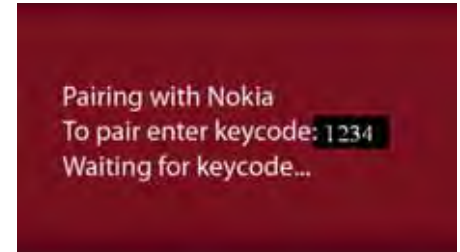

Pairing

Pairing activity will be initiated after the completion of search done through mobile phone / Radio. Pairing will be successful once the key code entered is matching.

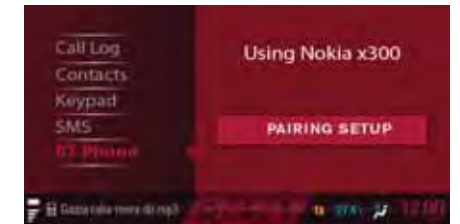

Pairing will fail if there is any BT communication failure. Then the pairing action will be aborted and infotainment system will revert to the previous audio source.

Reasons for the failure to detect/ pair with a phone

- System powered OFF
- Vehicle speed greater than 5 kmph
- User press **[CANCEL]** in touch selection
- Ignition key position moved to Off
- No phones found

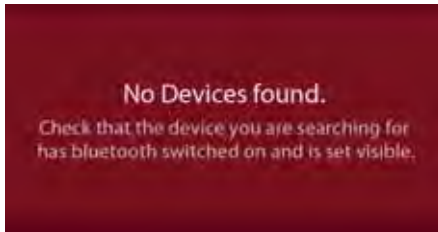

- User stops searching in mobile phone or enter wrong pin number etc.
- Bluetooth not turned ON.
- No slot available for a new Bluetooth device to be paired.

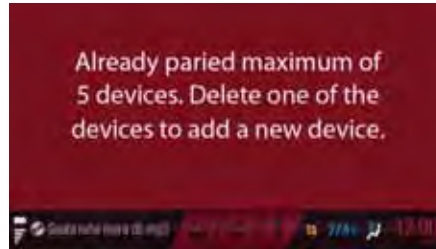

Wrong Pin Entry

If user has initiated the search from mobile phone and if he/she has entered the wrong pin number, the mobile phone will inform the appropriate message. On wrong pin entry case pairing will be failed and there will be a popup screen. Infotainment will revert to previous audio source.

Un pairing/deleting

User can delete the paired device by disabling the pairing check box in PHONE->BLUETOOTH->MANAGE Device. On selecting the desired device to be deleted the Infotainment will popup the delete screen.

Selecting For Phone / Audio Connection

By default the last paired device will be connected for both for HFP and audio streaming. However user can also change the device connected to a particular mode using "MANAGE" option in Bluetooth settings screen.



NOTICE

The device that has been already connected will be highlighted with tick (✓) mark.

Disconnection

If user selects the already connected device then it will be disconnected.

Auto Reconnection

Auto reconnection will happen only with the preferred device. If there is no device available to connect, then infotainment shall not change its connection status unless user desire to do so. The device connection status will be indicated with the relevant symbol to user.

NOTICE

Preferred device will be phone already connected in Phone.

Bluetooth Music

User can select the Bluetooth audio source via short press on [MUSIC] button in fascia switch or [MUSIC] option in home screen (touch selection). When the connected BT phone is active, then the music can be played from it if the Phone supports A2DP profile. When a BT phone has been already connected to the Infotainment, the last track that was played in the BT phone will be initiated. If the BT phone supports AVRCP profile then the track play will be initiated by Infotainment, else the play must be initiated by the user.

The following actions on the music tracks can be done from the infotainment provided the BT device supports AVRCP profile

- Next / Previous track selection
- Play / Pause track

Phone Book

User can check the phone book with the following entry condition.

- Infotainment in active mode
- Phone device connected and PBAP is supported
- Phone option selected from Menu or long press of [PHONE / ☎] button .

If the contacts are not ready to be displayed then "Phone Book Synchronizing " will be displayed.

NOTICE

- ***The phonebook contacts copied to Infotainment system can only be used when the corresponding mobile phone is paired and connected.***
- ***Infotainment system may take some time to download the contacts from the mobile phone. Download time varies based on type of mobile phone.***

Contacts

The first level screen will show the contents of phone book with the first contact highlighted as below.



Short press of Up/down button in touch selection or fascia switch will enable the user to browse through the Phone Book list. Long press of Up/down button in touch selection or fascia switch will enable Alphabetical Search (A to Z).

Incoming Call

An incoming call will be intimated to user with help of the below screens (graphics) and the in-band ring tone as supported by the mobile phone. If the in-band ring tone is not supported then a standard tone for incoming call will be supported.

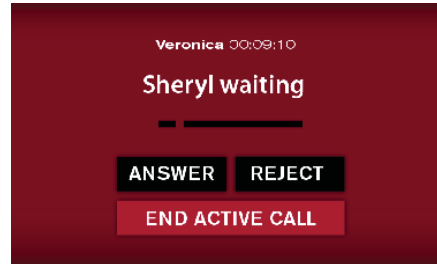

Incase of any incoming call the tuner will be muted and other media like CD/USB/iPod/ will be automatically paused. Upon the termination of the call the tuner will be un muted and CD/USB/iPod will resume automatically.

NOTICE

If user rejects the call by pressing Reject button for more than 2 seconds, infotainment will auto answer "The person you are trying to reach is currently driving, please call back later".

Outgoing Call

User needs to traverse through the Bluetooth menu options to select the key pad.

- Short press on **[PHONE]** button in touch screen and Press **"Keypad"** in touch selection.
- Select **"PHONE"** option in home screen and press **"Keypad"** in touch selection

Once the option is selected user can use the key pads 0~9 to enter the digits.



On entering the required digits user needs to press "Call" button in touch screen to make the call or press  button in touch screen to exit from the screen. If no valid input is entered then the dialing screen will exit on 30 seconds timeout.

An outgoing call will be intimated to user and the caller tune as transmitted by the network, else a standard tone for outgoing call will be supported.

Message

User can enable / disable the **"SMS Alert"** via Menu options. Short press on **[MENU]** button in fascia switch & select **"General"** settings.

If SMS alert is ON then there shall be pop up message for any new SMS, for 10 seconds. The Pop up shall also have beep tones for indication. User can read by touch selection on **"OPEN"** option.

If SMS alert is OFF then there shall be no pop up.



The infotainment system will read out the SMS with TTS function and also display the contents in the screen. The readout will start after a delay of 2 seconds. User can scroll & read the complete SMS.

If there are two or more new SMS only the last received can be read out. When SMS is read out, if another message is received, then it will not be indicated (no beep) only the SMS count will be updated after exiting the reading screen.

NOTICE

- *Some "special" characters within received SMS message cannot be interpreted by infotainment system.*
- *Bluetooth features like HFP, PBAP, A2DP, AVRCP and MAP are Phone dependent. Please refer your mobile phone owner's manual for supported profile .*

Video

Infotainment system supports video files. User can play video files from DISC or USB.



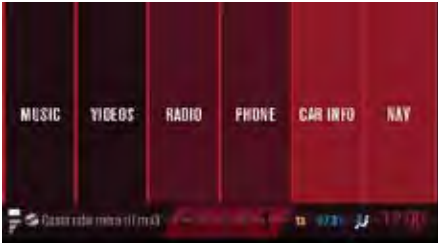



User can enter into video play screen from other screens via **[VIDEO]** button short press or touch select **"VIDEOS"** option from HOME screen.



Infotainment system avails following options in Video play mode, by double pressing on the touch screen (while video is playing)



- Play/Pause: User can play or pause the video using touch screen or Fascia panel.

- Next/Previous: User can play Next/previous video files by pressing  or  button in touch screen.
- Fast forward/Rewind: user can forward or rewind the video play by pressing  or  button in touch screen for more than 2 seconds. Or long press of [] / [] buttons in fascia switches.
- Aspect adjustment: User can adjust the aspect ratio (Width & Height of the display) by pressing "**ASPECT**" button in touch screen.
- Menu: This option will take you to the DVD menu options.
- Zoom: User can zoom in/out.
- Subtitle: To select sub subtitle of current playing video.
- Language: For changing Language.

Voice Recognition (VR)

When the Push to Talk (PTT) button is long pressed more than 2 seconds, infotainment system will enter into the VR mode. Once the PTT button is long pressed the following screen will be displayed.



User needs to wait for the voice feedback "Please say a command" followed by a beep sound, to activate the voice command as listed in Section 11.1. Voice recognition will have 3 retries including the initial session if there is a failure in recognition. Voice recognition can be initiated again by pressing PTT

button. During VR session volume up and down operation is possible and the action will take place in the background but there will not be popup for displaying volume increase or decrease



If the VR engine is not started then the following screen will be displayed.

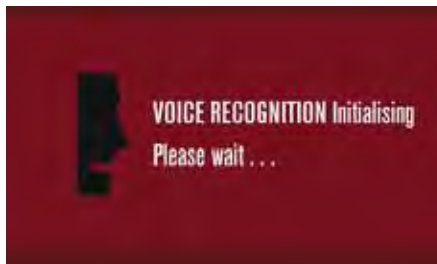

Supported Languages

1. U.S. English
2. U.K. English

NOTICE

By default U.S English is enabled, user can change the language at dealer end.

Voice Commands

CD/USB/iPOD

Press PTT  button for more than 2 sec, wait for a feedback with beep sound and say command ⇨ "CD" or "USB" or "iPod" (as user needs)

The following sub commands can be activated in CD/USB/iPod mode

1.Next Track

Press PTT  button for more than 2 sec, wait for a feedback with beep sound and say command ⇨ "NEXT"

2.Previous Track

Press PTT  button for more than 2 sec, wait for a feedback with beep sound and say command ⇨ "PREVIOUS"

3.Repeat Track

Press PTT  button for more than 2 sec, wait for a feedback with beep sound and say command ⇨ "REPEAT"

4.Shuffle/Random All

Press PTT  button for more than 2 sec, wait for a feedback with beep sound and say command ⇨ **"SHUFFLE" or "RANDOM"**

BLUETOOTH AUDIO

Press PTT  button for more than 2 sec and say a command ⇨ **"BLUETOOTH AUDIO"**

The following sub commands can be activated in Bluetooth audio mode

1.Next Track

Press PTT  button for more than 2 sec, wait for a feedback with beep sound and say command ⇨ **"NEXT"**

2.Previous Track

Press PTT  button for more than 2 sec, wait for a feedback with beep sound and say command ⇨ **"PRE-VOIUS"**

AUXILLARY IN

Press PTT  button for more than 2 sec and say a command ⇨ **"AUXILLARY IN"**

TUNER

Press PTT  button for more than 2 sec, wait for a feedback with beep sound and say command ⇨ **"Radio"**

The following sub commands can be activated in Tuner mode

1.Tuning to the desired frequency

Press PTT  button for more than 2 sec, wait for a feedback with beep sound and say command ⇨ **"TUNE 98.3"** (user can say any frequency in the AM/FM range)

2.Channel selection

Press PTT  button for more than 2 sec, wait for a feedback with beep sound and say command ⇨ **"SELECT MEMORY ONE"** (user can say any channel number between 1 to 6)

S.No	Currently Playing	Voice Command to activate
1	Tuner (FM/AM)	<CD>, <USB>, <iPod>, <BLUETOOTH AUDIO> <AUXILLARY IN>
2	Tuner	<FM> / <AM> <TUNE-- > (E.g., <TUNE 98.3> <SELECT MEMORY --> (E.g., <SELECT MEMORY ONE>
3	CD/USB/iPod	<NEXT>, <PREVIOUS>, <SHUFFLE> / <RANDOM>, <REPEAT>
4	Bluetooth Audio	<NEXT>, <PREVIOUS>,

NOTICE

- *The user should understand that Voice recognition errors are inherent in the process. Neither M&M nor its Suppliers shall be liable for any damages arising out of errors in the Voice recognition process.*
- *Voice recognition performance depends on the user's pronunciation and accent of the voice.*

Vehicle Information

Anti theft lock

On every ignition cycle the audio unit will do an authentication with the EMS module to avoid theft and miss-configuration

VIN mismatch will lead to total shutdown or move the audio unit to a locked state. Please contact your Mahindra dealer to rectify this.

RPAS (Rear Parking Assist System)

The RPAS is designed to assist the user in parking or driving the vehicle with reverse gear. The display system will warn the user about the obstacles present near the vehicle rear side, so that the user can safely drive the vehicle.

When the RPAS is active, the audio source will not interrupted and RPAS tones will be played along with the existing audio if the obstacles are found



Air Conditioning System Details

The display will show the different HVAC status as described below.

Driver Information

The driver information can be activated by a short press on the [INFO] button. On entering the DI screen the following message will be displayed.

- **Distance to empty**-shows the maximum distance that the vehicle can travel with the available fuel.
- **Average Fuel consumption**- shows the overall mileage of the vehicle.

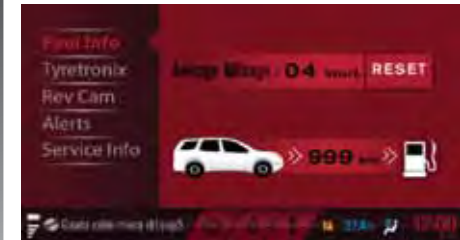

Tyretronics

User can enter the TPMS (Tyre pressure monitoring system) screen (Tyre Tronics) on short press of [INFO] button and if TPMS is enabled (vehicle configuration). This will display the features of the tyre like pressure and temperature for all the 4 wheels including the spare wheel. It also gives alert if there is any air leakage. This feature is available only in select models.





OK - Will be the display for tire pressure on all tires unless low pressure / high pressure / air leakage is not present for that tire.



Alerts

The below alert icon will be displayed if there is an alert logged for display in the alerts screen.















It will be deactivated if the alert screen is visited by user (using **[INFO]** button or on a new ignition cycle. Also it will not appear in the pop up / DI / Alerts screen.

Display Alert	Description
 The image shows a red alert screen with white text. At the top left, there are two circular icons: one with a 'P' and one with a 'B'. Below them, the text reads 'Front Brake pad worn out!' and 'Drive with reduced speed.' At the bottom center, there is a red button with the word 'EXIT' in white.	If the front wheel brake pad is worn out. Contact the nearest MAHINDRA service centre to replace the Brake pad.

Display Alert	Description
 <p>The image shows a red background with white text and icons. On the left, there are two circular icons: one with a red exclamation mark and one with a red 'P'. Below them is the word 'BRAKE'. To the right, the text reads 'Low brake fluid level!' and 'Drive with reduced speed.'. At the bottom right, there is a red button with the word 'EXIT' in white.</p>	<p>This alert is flashed when the brake fluid level is low in any of the four wheels. Contact the nearest MAHINDRA service centre.</p>
 <p>The image shows a red background with white text and an icon. On the left, there is an icon of a fuel filter with a drop of water falling from it. To the right, the text reads 'Water in Fuel!' and 'Please drain the water.'. At the bottom right, there is a red button with the word 'EXIT' in white.</p>	<p>This alert is flashed when Water in fuel is detected; need to clean the fuel filter.</p>

Display Alert	Description
	<p>This is an indication that the vehicle needs to be serviced. Regular servicing of the vehicle is necessary to ensure the peak performance of the vehicle.</p>
	<p>The alert is an indication that the door is not properly closed. This might compromise with the safety of the passengers inside the car. Ensure all the doors are properly closed.</p>

Navigation Control - Quick Start Guide

1		Brings up volume control*
2		Rotates map display towards horizon
3		Rotates map display towards 2D
4	4	Brings up route menu
5		Show direction of North*
6		Show the Quality of reception of GPS Signal
7		Charging/Status of Batteries*
8		Shows time, tapping the control, replaces time with GPS
9		Brings up main menu
10		Rotates the map Anti clockwise
11		Rotates the map clockwise
12		Display the map so that present position is in the center of the display
13		Start/Stops recording GPS position
14		Zoom in
15		Zoom out

On completion of the search, the list of devices found will be displayed and user can scroll through the list using the volume knob & select the desired one.

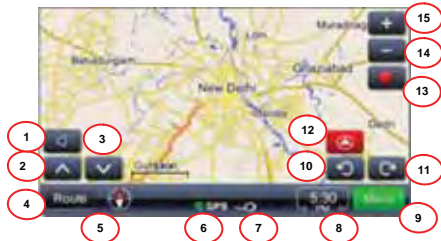

MAP SCREEN

* Features described herein are subjected to availability depending on vehicle variants.

NOTICE

User can mute/adjust the navigation volume via MENU' sound settings, refer section "Settings".

Glossary

Route - Trajectory calculated on the basis of given destination, via points, types of vehicles, type of roads etc. Start of the route is ALWAYS current GPS position. System can have only one route at a time.

Trip - Journey calculated using start location, via points and destination, types of vehicles and other settings. Arbitrary numbers of trips can be recorded and retrieved for later use and guidance.

Via point - Location on the route or trip between GPS position or start and destination.

POI - Point of Interest.

Click on the map - Displays street name and brings up context menu.



Context Menu Description

Navigate to - Calculates the route from instant GPS position to the selected point and starts guidance

Find nearest POI - Starts the search for POIs near selected point

Save location - Saves the selected point in favorites

Trip Planning

Add a destination - Sets the point as destination

Add a via point - Sets a point as via point

Set as start - Sets the point as the start point of the trip



Getting to the destination

The most common task in navigation software is guidance to the known address. In ViaGPS section “**Display**” it is done like this.



Brings up main menu

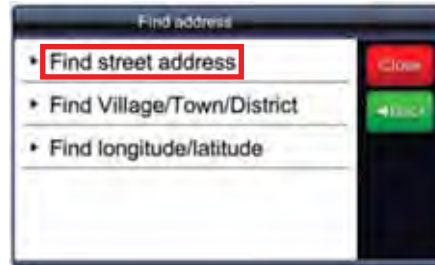
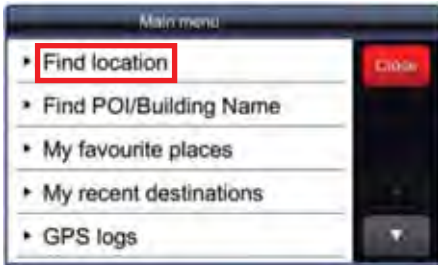

Starts the search based on given Input
Select the desired location from given search results by touching the appropriate entry from the list:

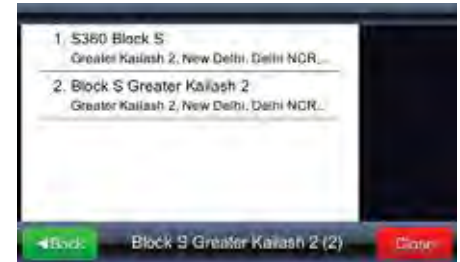

Selected result is shown on the map



If a desired location is chosen it can be used for the route calculation:

- ▶ **Navigate to** Sets location as destination, calculates the route and starts guidance.

Important!

Guidance to location assumes calculation from current GPS position to given destination. Current position is determined by GPS signal – GPS signal availability is denoted by.

Guidance

By choosing guidance item ("Navigate to") route is calculated and guidance is started. Guidance window is shown below:



Meanings and functions of icons in the guidance window:

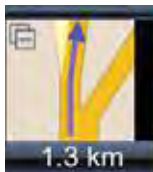

upper left corner

Displays next maneuver with real geometry of streets in enlarged view. This window can be closed by touching little triangle in the



Distance to go



Estimated time of arrival



Time to go



Street/road/square name after next maneuver

NOTICE

Display of last three fields is changed with the street/road/square name display next on route. In order to stop the change field needs to be touched. To resume the change field needs to be touched again.



Shows the map with current position in the middle of the screen



Shows the map with north position up



Shows the quality of GPS signal. Icon also functions as the switch for window changing (GPS signal summary window)

Important!

In case that the vehicle has missed the calculated route the new route is automatically recalculated.

Route overview	Shows the route on the map
Rotates summary	Review of the route data
Places along the route	Searches for POIs along the route
Drop next via point	Calculates the route by dropping next via point
Avoid next	Calculates the route by avoiding next 1,2, 5, 10 or 20 km on the existing route (in case of traffic jams or constructions)
Delete this route	Deletes the actual route
Via points list	List of via points. Allows optimization of the route using travelling salesman algorithm
Maneuvers list	Gives the list of all maneuvers on the route
Save this route	Saves the route

Route preview and editing

Important! - Guidance to location assumes calculation from current GPS position to given destination. Current position is determined by GPS signal - GPS signal availability is denoted by . In case of calculating the route from other, non GPS position we use word TRIP instead of ROUTE (Trip overview, Trip summary, Places along the trip, etc).

Changing route destination or adding via points

To change route destination or add via point:



Brings up main menu with possible actions list. Choose search method as

needed - after acquiring results choose appropriate route

Places along the route - Brings up menu with POI categories list





Brings up main menu with possible actions list.

Choose search method as needed - after acquiring results choose appropriate route



Brings up possible actions for a chosen result

Search along the route (objective is most commonly: finding gas stations, restaurants or accommodation) is performed as following:



Touching a selected result displays context menu. In this case "Add as via point" should be selected

Changing the order via points

If you need to recalculate route with existing parameters (via points and destination) but with changed via points order, please do the following:

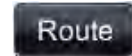

Brings up menu with the list of possible tasks

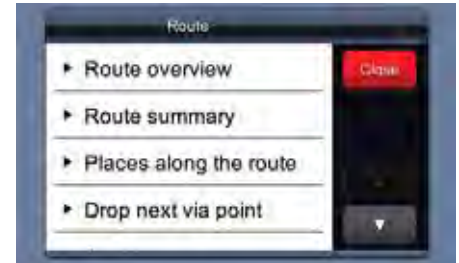

Deletes via point



Moves via point up



Moves via point down



Optimize stops order (via points order)

If you need to recalculate optimal route and wish to keep via points, it can be done as following. During this operation starting point becomes finishing point.

First, define all needed parameters - starting point and via points/destinations. It can be done by adding destinations in succession. In other words, chosen location is set as starting point, another location is added as destination and by adding third location as destination second location becomes via point. Route is calculated automatically:

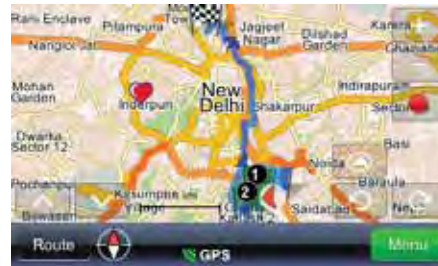

After all needed and chosen are set as route parameters, and route is calculated, route optimizing is done as following:



Brings up menu with the list of possible tasks



Choosing any point on route:



Brings up menu with possible tasks and route optimizing



Optimizing via points order recalculates new route and keeps all via points.

NOTICE

Start point becomes Finish point after the operation is done.

Main Menu

Find location

Refer section “Getting to the destination”

Find POI



The window showing results has sorting button 



By clicking "Near me" button, POI-s will be re-searched, this time based not only the name, but the distance to current position also.



If some category is selected, all POIs of that category that are near are selected and displayed as search result.



If "Find by name" is selected, new input dialog is shown where user can type name of the POI that will be looked for in the vicinity.

My favorite places

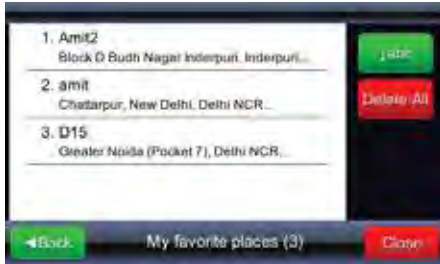

Initial sorting of results is "temporal", i.e. last recently added favorites are shown first. By clicking **Label** button, they will be sorted alphabetically, and the button will change to **Sort by dist** button, meaning user can choose to sort them by distance

If you want to delete all favorites at once, use **Delete All** button.

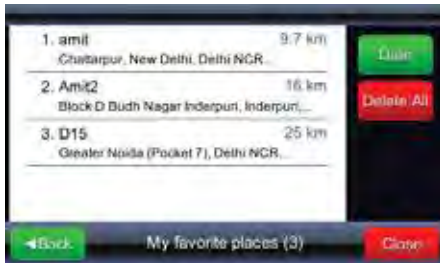

My recent destinations

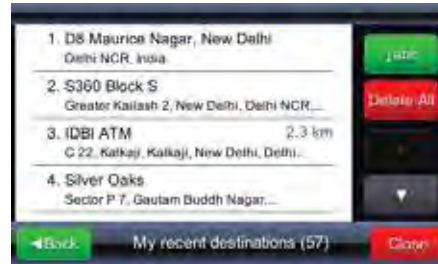

GPS Logs



Turns GPS logging ON or OFF

► GPS logs

Brings up the list of saved logs

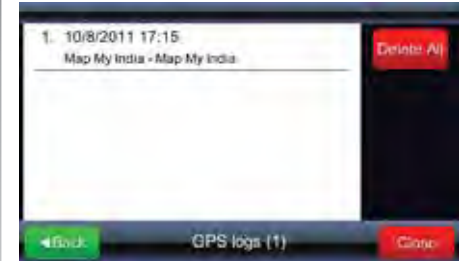

Brings up log display on the map:

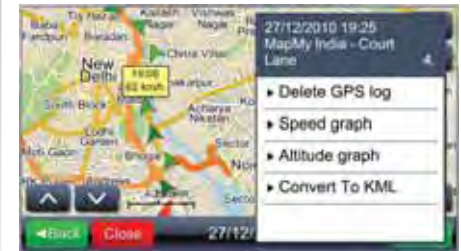



Brings up menu with possible actions

► Speed graph

Brings up speed graph

Speed graph can be show completely or by zooming into a segment of the log.



► **Altitude graph** Brings up altitude graph. GPS altitudes must be taken only as orientation because of large error (error can range up to 30 m and more).

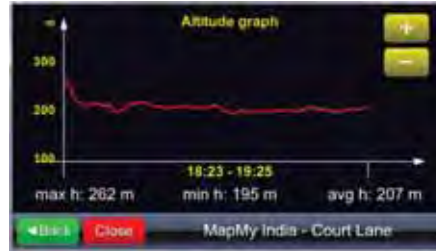

► Convert To KML

Creates file that can be used for showing trips on Google mapping tools.

Geo pix images



The choice of collection brings up the list of photos in the collection.



By selecting one photo (touching the photo) a full screen of the photo is enabled and Map icon shows the position of where the photo was taken on the map.



My saved routes

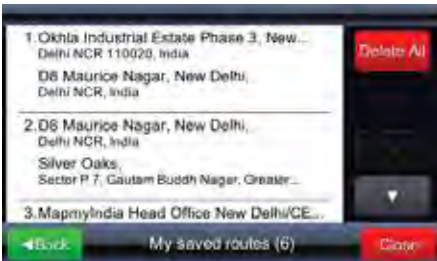

Tapping the field on the list...

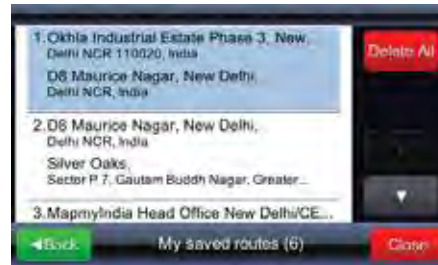

... displays start point, via points and destination on the map. Selecting "Load"...



... loads the route with all via points. Selecting "Drive this trip" calculates the route and starts navigation. "Drive this trip" replaces starting point with current GPS position.

Setting

Map:

Selecting "Map" brings up menu for adjusting map brightness and map area.

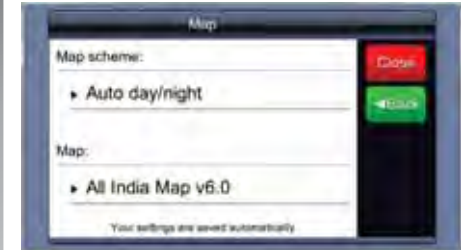

Brightness can be set to "Day", "Night" or "Automatic" mode.

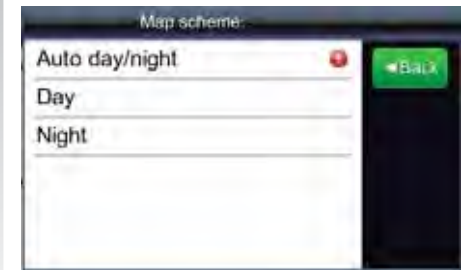

Automated mode talks into account dusk/dawn time on the given geographic position depending on season.

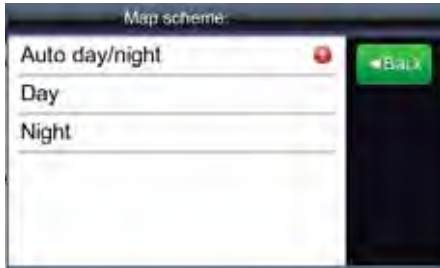

NIGHT DISPLAY APPEARANCE

"Map" option is used when distinct maps exist on the device, e.g. Croatia only or whole Europe. Selecting map defines which data are taken into account by system.

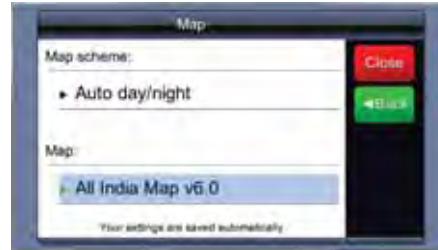

Map POI

► Map POIs

Brings up menu for POI category selection shown as icons on the map. Many categories can be selected from the menu.



The first item on the list will always be My favorite places, and then the list of POI categories follows. Just below Back button is button to quickly select/deselect all categories: on the figure above, it suggests that all categories will be selected. On the picture below, it suggests that all categories will be deselected





Volume



This menu can be brought up by touching  in main window or guidance window.

NOTICE

Volume settings may not be available in some variants

Language



Language settings automatically choose guidance voice language, so when using, for example, English, changing to Croatian automatically includes user interface and guidance voice changes.

About

▶ **About**

Brings up About menu, with version information and "Maps sources and copyrights" button that opens page with device id, storage card id (if any) and details about loaded maps (sources, copyrights, validity period etc.)

Abbreviations

Acronym	Description
HFP	Hands Free Profile
CD	Compact Disc
RDS	Radio Data System
CDDA	Compact Disc Digital Audio
WMA	Windows Media Audio
HVAC	Heat Ventilation Air Conditioning
TPMS	Tire Pressure Monitoring System
EMS	Engine Management System
TA	Traffic Announcement
AVRCP	Audio/Video Remote Control Profile
PBAP	Phone Book Access Profile
A2DP	Advanced Audio Distribution Profile
MAP	Message Access Profile
TTS	Text To Speech
PTT	Push To Talk

NOTICE

Bluetooth® is a Bluetooth® SIG, Inc registered trade-mark.

Nokia® is a Nokia Corporation registered trade-mark.

The other trade-marks are proprietary of the respective Companies.

All features described herein are subjected to availability depending on vehicle.

A

Abbreviations	8-13, 9-46
About	9-45
ACC Active Mode	4-6, 9-12
Air Conditioning System Details	8-2, 9-29
Alerts	8-9, 9-30
AM Reception (Medium Waves).....	1-2, 4-12, 9-16
Anti theft lock	9-29
Audio control	6-1
Audio options	3-11
Audio Settings	3-11
Auto Reconnection	5-4, 9-22
Auto Seek	3-5, 4-12, 9-17
Aux - In Operation	3-10
AUXILLARY IN	7-2, 9-27

B

Balance control	3-12
Band selection.....	4-12, 9-17
Bass / Treble / Balance / Fader Control	4-8, 9-14
Bass / treble tone control	3-11
Bezel and Button Functions	3-2, 4-2, 9-2
Bluetooth (BT) Functions	5-1, 9-19
BLUETOOTH AUDIO	7-2, 9-27
Bluetooth Music.....	5-4, 9-22

C

CD accessories	2-1, 9-11
CD care and maintenance	2-1
CD Cleaning	2-2, 9-11
CD Handling	2-1
CD opening cleaning	1-2
CD Operations	3-6
CD removal	2-2, 9-11
CD/USB/iPOD	7-2, 9-26
CDs that cannot be used	2-2
Changing route destination or adding via points	9-37
Changing the order via points	9-38
Channel selection	7-2, 9-27
Cleaning of the unit	1-1
Clock	4-4, 4-9, 9-15
Clock format	3-5, 4-10
Clock setting	3-4, 4-9, 9-15
Connecting AUX input	3-10
Context Menu Description	9-34
Controls	4-3, 9-3

D

Disconnecting AUX input	3-10
Disconnection	5-4, 9-21
Disk Labels	9-12
Display	4-3, 9-3
Display OFF Mode	4-6, 9-13
Driver Information (DI)	8-6, 9-29

INDEX

DVD/CD Care and maintenance	9-10	Glossary	9-34
DVD/CD Handling	9-10	GPS Logs	9-41
DVD/CD Opening cleaning	9-10	Guidance	9-36
DVD/CDs that cannot be used	9-11		
E		H	
Ejecting a CD / USB / iPod	4-16, 9-19	Home	9-13
Ejecting a CD	3-6		
Equalizer	3-4, 4-9	I	
Equalizer setting	3-13, 4-8, 9-14	Incoming Call	5-7, 9-23
		Info	4-10, 9-15
F		Inserting a CD	3-6
Fade control	3-11		
Fast backward play	3-9	I	
Fast forward play	3-9	Language	9-45
Features	3-3, 4-3, 9-3	LCD	1-1
File and folder structure limit	3-8	LCD Display	3-3
Find location	9-40	Level 1 - Audio Infotainment	
Find POI	9-40	System (if equipped)	3-1, 4-1, 9-1
FM Reception	1-2, 4-12, 9-16	List (Browsing)	4-11, 9-16
For Instance	3-8		
Format of reproducible disks	3-7	M	
Frequency band select	3-5	Mahindra Modes	4-9
		Mahindra Music Modes	9-15
G		Main Menu	9-40
General Operations	3-3, 4-6, 9-12	Manual frequency tuning	3-5
Geo pix images	9-42	Map POI	9-44
Getting to the destination	9-35	Map:	9-43
		Maximum number of characters showed on the display	3-8

Meanings and functions of icons in the guidance window	9-36
Menu	4-11
Message	5-8, 9-24
MP3 / WMA Reproduction	3-7
MP3 / WMA track information	3-10
Music disks encoded with copyrights protection	2-2, 9-12
Mute	3-4, 4-10, 9-11
My favorite places	9-41
My recent destinations	9-41
My saved routes	9-43

N

Navigation Control	9-33
Next Track	7-2, 9-27
Normal Mode / Infotainment System Active	4-6, 9-12
Notes on the MP3 / WMA reproduction	3-7

O

Operations	3-3, 5-5, 4-6, 9-10, 9-12
Optimize stops order (via points order)	9-39
Outgoing Call	5-7, 9-23

P

Pairing	5-2, 9-20
Phone Book	5-5, 9-22
Playing a Media (CD / USB / iPod)	5-14
Playing a Media (CD/DVD/USB/iPod)	9-18

Playing an AUX	4-16, 9-19
Playing Tracks	4-15, 9-18
Power / Select	3-3, 4-7, 9-13
Precautions regarding operation	2-1, 9-10
Pre-set memories 1 to 6	3-5
Preset Memory	4-13, 9-17
Previous Track	7-2, 9-26, 9-27

R

Radio Operations	3-5
Radio reception	1-2, 4-12, 9-16
Random	4-15, 9-19
Random play mode	3-9
RDS (Radio Data System) (if equipped)	4-13, 9-17
Reasons for the failure to detect / pair with a phone	5-3, 9-21
Recalling a Station	4-13
Remote Control	4-4, 9-8
Repeat play mode	3-9
Repeat Track	7-2, 9-26
Repeating Tracks / Folder	4-15, 9-18
Reproducible audio files	3-7
Reproducible media	3-7
Reproducible MP3 file	3-7
Reproducible WMA file	3-7
Reproduction order of the audio file	3-8
Route preview and editing	9-37
RPAS (Rear Parking Assist System)	8-1, 9-29

S

Safety Precautions	1-1
Searching from Mobile Phones	5-1, 9-20
Searching from Radio	5-1, 9-20
Selecting For Phone / Audio Connection	5-4, 9-21
Setting	9-13, 9-43
Shuffle/Random All.....	7-2, 9-27
Skip folder	3-8
Skip track.....	3-9
SLEEP Mode (Radio OFF)	9-12
SLEEP Mode.....	4-6
Source	3-4, 4-7
Speed Volume	4-9, 9-14
Standard volume adjustment.....	3-11
Steering Wheel Control (SWC)	4-4, 6-1, 9-8
Switch Bank	4-3, 9-4

T

Theft Deterrent lock.....	8-1
Tiretronics	9-29
To avoid risk of damage and / or fire, observe the following precautions	1-1
To select memories	3-6
To Store a Station (1 to 6)	4-13, 9-17
To store a station	3-6
Touch Panel Control	9-10
TPMS / Tyretronics	8-6
Track information	3-7

Traffic News & Announcements (TA)	4-14, 9-18
Trip Planning.....	9-34
Tuner	4-12, 9-16, 7-2, 9-27
Tuning to the desired frequency	7-2, 9-27

U

Un pairing/deleting	5-3, 9-21
User can avail the 3 pre-defined equalizer settings ...	9-15

V

Vehicle Information	8-1
Voice Commands	7-2, 9-26
Voice Recognition (VR)	6-1, 7-1, 9-25
Vehicle Information	9-29
Volume	9-45
Volume control	3-11
Volume knob	3-3, 4-7, 9-13

W

Wetness condensation	2-1, 9-10
When the infotainment system is OFF	3-6
Wrong Pin Entry.....	5-3, 9-21