



G-Class

Operator's Manual



4635844702

Order no. 6515 4196 13 Part no. 4635844702 Edition A 2016

G-Class Operator's Manual



Mercedes-Benz

Symbols

Registered trademarks:

- Bluetooth® is a registered trademark of Bluetooth SIG Inc.
- DTS is a registered trademark of DTS, Inc.
- Dolby and MLP are registered trademarks of DOLBY Laboratories.
- BabySmart™, ESP® and PRE-SAFE® are registered trademarks of Daimler AG.
- HomeLink® is a registered trademark of Prince.
- iPod® and iTunes® are registered trademarks of Apple Inc.
- Logic7® is a registered trademark of Harman International Industries.
- Microsoft® and Windows media® are registered trademarks of Microsoft Corporation.
- SIRIUS is a registered trademark of Sirius XM Radio Inc.
- HD Radio is a registered trademark of iBiquity Digital Corporation.
- Gracenote® is a registered trademark of Gracenote, Inc.
- ZAGATSurvey® and related brands are registered trademarks of ZagatSurvey, LLC.

In this Operator's Manual you will find the following symbols:

WARNING

Warning notes make you aware of dangers which could pose a threat to your health or life, or to the health and life of others.

Environmental note

Environmental notes provide you with information on environmentally aware actions or disposal.

 Notes on material damage alert you to dangers that could lead to damage to your vehicle.

 Practical tips or further information that could be helpful to you.

- ▶ This symbol indicates an instruction that must be followed.
- ▶ Several of these symbols in succession indicate an instruction with several steps.

 This symbol tells you where you can find more information about a topic.

 This symbol indicates a warning or an instruction that is continued on the next page.

 This font indicates a display in the multifunction display/COMAND display.

 This symbol tells you that you can find further information in the Digital Operator's Manual.

Parts of the software in the vehicle are protected by copyright © 2005 The FreeType Project <http://www.freetype.org>. All rights reserved.

Publication details

Internet

Further information about Mercedes-Benz vehicles and about Daimler AG can be found on the following websites:

<http://www.mbusa.com> (USA only)

<http://www.mercedes-benz.ca> (Canada only)

Editorial office

©Daimler AG: Not to be reprinted, translated or otherwise reproduced, in whole or in part, without written permission from Daimler AG.

Vehicle manufacturer

Daimler AG
Mercedesstraße 137
70327 Stuttgart
Germany

Welcome to the world of Mercedes-Benz

We urge you to read this Operator's Manual carefully and familiarize yourself with the vehicle before driving. For your own safety and a longer vehicle life, follow the instructions and warning notices in this manual. Ignoring them could result in damage to the vehicle or personal injury to you or others.

Vehicle damage caused by failure to follow instructions is not covered by the Mercedes-Benz Limited Warranty.

The equipment or product designation of your vehicle may vary depending on:

- model
- order
- country specification
- availability

Mercedes-Benz therefore reserves the right to introduce changes in the following areas:

- design
- equipment
- technical features

The equipment in your vehicle may therefore differ from that shown in the descriptions and illustrations.

The following are integral components of the vehicle:

- Operator's Manual
- Maintenance Booklet
- Equipment-dependent supplements

Keep printed copies of the documents in the vehicle at all times. If you sell the vehicle, always pass the documents on to the new owner.

The technical documentation team at Daimler AG wishes you safe and pleasant motor-ing.

Mercedes-Benz USA, LLC

Mercedes-Benz Canada, Inc.

A Daimler Company

Index 3

Introduction 19

At a glance 26

Safety 34

Opening and closing 60

Seats, steering wheel and mirrors 72

Lights and windshield wipers 84

Climate control 99

Driving and parking 111

On-board computer and displays 170

Stowage and features 214

Maintenance and care 235

Breakdown assistance 248

Wheels and tires 262

Technical data 288

1, 2, 3 ...

4ETS (Electronic Traction System)

Function/notes 57

12 V socket 223**115 V socket** 223**A****ABS (Anti-lock Braking System)**

Display message 185

Function/notes 55

Important safety notes 55

Warning lamp 206

Accident

Automatic measures after an accident 46

ADAPTIVE BRAKE 59**Adaptive brake lights** 56**Additives (engine oil)** 292**Adjustable damping** 118**Air bags**

Deployment 43

Display message 189

Front air bag (driver, front passenger) 42

Important safety notes 40

Introduction 40

PASSENGER AIR BAG OFF indicator lamp 35

Pelvis air bag 42

Side impact air bag 42

Window curtain air bag 43

Air vents

Important safety notes 109

Rear 110

Setting 109

Setting the center air vents 109

Setting the side air vents 109

Air-conditioning system

see Climate control

Alarm system

see ATA (Anti-Theft Alarm system)

All-wheel drive

Transfer case 162

AMG menu (on-board computer) 182**Anti-lock braking system**

see ABS (Anti-lock Braking System)

Anti-theft alarm system

see ATA (Anti-Theft Alarm system)

Approach/departure angle 140**Ashtray** 221**Assistance menu (on-board computer)** 178**ASSYST service interval display**

Service messages 240

ATA (Anti-Theft Alarm system)

Activating/deactivating 59

Function 59

Switching off the alarm 59

Authorized Mercedes-Benz Center

see Qualified specialist workshop

AUTO lights

Display message 191

see Lights

Automatic car wash 241**Automatic engine start (ECO start/stop function)** 116**Automatic engine switch-off (ECO start/stop function)** 115**Automatic headlamp mode** 85**Automatic transmission**

Automatic drive program 123

Display message 201

Drive position (ECO start/stop function) 121

Driving tips 121

Emergency running mode 127

Engaging drive position 121

Engaging neutral 120

Engaging reverse gear 120

Engaging the park position 119

Important safety notes 118

Kickdown 122

Manual shifting 124

Neutral (ECO start/stop function) 120

Overview 118

Problem (malfunction) 127

Program selector button 122

Pulling away 113

Selector lever 119

Shift ranges 123

Steering wheel paddle shifters 123

Trailer towing 122

Transmission position display	119
Automatic transmission emergency mode	127
Axle load, permissible (trailer towing)	298

B

BabySmart™	
Air bag deactivation system	50
Backup lamp	
Changing bulbs	96
BAS (Brake Assist System)	56
Battery	
Checking (SmartKey)	62
Important safety guidelines (SmartKey)	61
Replacing (SmartKey)	62
Battery (vehicle)	
Charging	252
Display message	193
Important safety notes	250
Jump starting	254
Overview	250
Blind Spot Assist	
Activating/deactivating	178
Activating/deactivating (on-board computer)	178
Display message	196
Notes/function	155
Brake fluid	
Display message	187
Notes	293
Warning lamp	205
Brake fluid level	240
Brake lamps	
Adaptive	56
Display message	190
Brakes	
ABS	55
BAS	56
Brake fluid (notes)	293
Display message	185
High-performance brake system	135
Important safety notes	133
Maintenance	134
Parking brake	131
Riding tips	133

Warning lamp	205
Breakdown	
see Flat tire	
see Towing away	
Brightness control (instrument cluster lighting)	27
Brush guard	231
Bulbs	
Backup lamp	96
Brake lamp	95
Rear fog lamp	96
Tail lamp	95
see Replacing bulbs	

C

California	
Important notice for retail customers and lessees	20
Calling up a malfunction	
see Display messages	
Care	
Car wash	241
Carpets	247
Chrome parts	244
Display	245
Gear or selector lever	246
Headlamps	244
Interior	245
Matte finish	243
Notes	241
Paint	243
Plastic trim	245
Power washer	242
Rear view camera	244
Roof lining	247
Seat belt	246
Seat covers	246
Sensors	244
Steering wheel	246
Tail pipes	244
Trailer coupling	245
Trim strips	246
Washing by hand	242
Wheels	242
Windows	243
Wiper blades	244
Wooden trim	246

- Cargo compartment cover**
 - Installing/removing 219
 - Notes/how to use 219
 - Opening and closing 219
 - Overview 219
- Cargo compartment enlargement**
 - Important safety notes 216
- Cargo tie down rings** 219
- CD player/CD changer (on-board computer)** 176
- Center console**
 - Overview 30
 - Upper section 30
- Central locking**
 - Automatic locking (on-board computer) 180
 - Locking/unlocking (SmartKey) 60
- Changing bulbs**
 - Reversing lamps 96
 - Side marker lamps 94
 - Turn signals (front) 94
- Changing gears** 121
- Checklist**
 - After driving off-road 139
 - Before driving off-road 138
- Child**
 - Restraint system 47
- Child seat**
 - BabySmart™ air bag deactivation system 50
 - Forward-facing restraint system 51
 - LATCH-type (ISOFIX) child seat anchors 48
 - On the front-passenger seat 51
 - Problem (malfunction) 53
 - Rearward-facing restraint system 51
 - Top Tether 49
- Child-proof locks**
 - Important safety notes 53
 - Rear doors 54
- Children**
 - Special seat belt retractor 47
- Chrome parts (cleaning instructions)** 244
- Cigarette lighter** 222
- Climate control**
 - Controlling automatically 105
 - Convenience opening/closing (air-recirculation mode) 108
 - Cooling with air dehumidification .. 103
 - Defrosting the windows 106
 - Defrosting the windshield 105
 - Dual-zone automatic climate control 100
 - Important safety notes 99
 - Indicator lamp 104
 - Maximum cooling 106
 - Notes on using dual-zone automatic climate control 101
 - Overview of systems 99
 - Problem with the rear window defroster 107
 - Problems with "cooling with air dehumidification" 104
 - Refrigerant 293
 - Refrigerant filling capacity 293
 - Setting the air distribution 105
 - Setting the air vents 109
 - Setting the airflow 105
 - Setting the temperature 105
 - Switching air-recirculation mode on/off 107
 - Switching on/off 102
 - Switching residual heat on/off 108
 - Switching the rear window defroster on/off 107
 - Switching the ZONE function on/off 105
 - Windshield defroster 106
- Cockpit**
 - Overview 26
 - see Instrument cluster
- COMAND**
 - see separate operating instructions
- Combination switch** 88
- Consumption statistics (on-board computer)** 173
- Convenience opening feature**
 - see Side windows
- Convenience opening/closing (air-recirculation mode)** 108
- Coolant (engine)**
 - Checking the level 238
 - Display message 192
 - Filling capacity 295

- Notes 294
 - Temperature (on-board computer) 182
 - Temperature gauge 171
 - Warning lamp 210
 - Cooling**
see Climate control
 - Copyright** 25
 - Cruise control**
Cruise control lever 141
 - Display message 198
 - Driving system 141
 - Function/notes 141
 - Resuming the stored speed 142
 - Selecting 142
 - Storing and maintaining current speed 142
 - Cup holder**
Center console 220
 - Important safety notes 220
 - Rear compartment 220
 - Customer Assistance Center (CAC)** 23
 - Customer Relations Department** 23
- D**
- Data**
see Technical data
 - Daytime running lamps**
Display message 191
 - Switching on/off (on-board computer) 179
 - Switching on/off (switch) 85
 - Declarations of conformity** 23
 - Delayed switch-off**
Exterior lighting (on-board computer) 179
 - Interior lighting 180
 - Differential locks**
Disengaging 166
 - Engaging 165
 - Front axle 166
 - General notes 164
 - Rear axle 166
 - Terrain 164
 - Transfer case 165
 - Digital speedometer** 174
 - Display (cleaning instructions)** 245
 - Display messages**
Calling up (on-board computer) 184
 - Driving systems 195
 - Engine 192
 - General notes 184
 - Hiding (on-board computer) 184
 - Lights 189
 - Safety systems 185
 - Service interval display 240
 - SmartKey 202
 - Tires 198
 - Vehicle 201
 - Distance display (on-board computer)** 178
 - Distance recorder**
see Trip odometer
 - Distance warning (warning lamp)** 212
 - DISTRONIC PLUS**
Activating 149
 - Activation conditions 149
 - Cruise control lever 149
 - Deactivating 153
 - Display message 197
 - Displays in the multifunction display 151
 - Driving tips 153
 - Function/notes 147
 - Important safety notes 147
 - Selecting 149
 - Setting the specified minimum distance 152
 - Warning lamp 212
 - Door control panel**
Overview 33
 - Doors**
Automatic locking (on-board computer) 180
 - Automatic locking (switch) 66
 - Central locking/unlocking (SmartKey) 60
 - Display message 201
 - Emergency locking 66
 - Emergency unlocking 66
 - Important safety notes 64
 - Opening (from inside) 64
 - Overview 64
 - Drinking and driving** 132

- Drive program**
 - Automatic 123
 - Display 119
 - SETUP (on-board computer) 182
 - Driving in mountainous terrain**
 - Approach/departure angle 140
 - Driving downhill 140
 - Gradient-climbing capability (maximum) 140
 - Driving lamps**
 - see Daytime running lamps
 - Driving off-road**
 - see Off-road driving
 - Driving on flooded roads** 135
 - Driving safety systems**
 - 4ETS (Electronic Traction System) 57
 - ABS (Anti-lock Braking System) 55
 - ADAPTIVE BRAKE 59
 - Adaptive brake lights 56
 - BAS (Brake Assist System) 56
 - Electronic brake force distribution 58
 - ESP® (Electronic Stability Program) 57
 - Important safety information 55
 - Overview 55
 - Driving systems**
 - Blind Spot Assist 154
 - Cruise control 141
 - Display message 195
 - DISTRONIC PLUS 147
 - HOLD function 157
 - PARKTRONIC 158
 - Rear view camera 161
 - SPEEDTRONIC 145
 - Variable SPEEDTRONIC 145
 - Driving tips**
 - Automatic transmission 121
 - Brakes 133
 - DISTRONIC PLUS 153
 - Downhill gradient 133
 - Driving in winter 136
 - Driving on flooded roads 135
 - Driving on sand 139
 - Driving over obstacles 139
 - General 132
 - Gravel roads 139
 - Hydroplaning 135
 - Icy road surfaces 136
 - Off-road driving 137
 - Off-road fording 135
 - Snow chains 264
 - Tire ruts 139
 - Towing a trailer 166
 - Traveling uphill 140
 - Wet road surface 134
 - DVD audio**
 - Operating (on-board computer) 176
 - DVD video**
 - Operating (on-board computer) 176
- E
- EASY-ENTRY feature**
 - Activating/deactivating 181
 - Function/notes 79
 - EASY-EXIT feature**
 - Function/notes 79
 - Switching on/off 181
 - EBD (electronic brake force distribution)**
 - Display message 186
 - Function/notes 58
 - ECO start/stop function**
 - Deactivating/activating 114
 - General information 114
 - Electrical fuses**
 - Fuse box in the cargo compartment 261
 - Electronic Stability Program**
 - see ESP® (Electronic Stability Program)
 - Electronic Traction System**
 - see 4ETS (Electronic Traction System)
 - Emergency**
 - Automatic measures after an accident 46
 - Emergency call**
 - see mbrace
 - Emergency locking**
 - Vehicle 66
 - Emergency release**
 - Vehicle 66
 - Emergency Tensioning Devices**
 - Activation 43

Engine

Check Engine warning lamp	210
Display message	192
ECO start/stop function	114
Engine number	289
Irregular running	117
Jump-starting	254
Starting problems	117
Starting the engine with the SmartKey	113
Switching off	131
Tow-starting (vehicle)	259

Engine electronics

Problem (malfunction)	117
-----------------------------	-----

Engine oil

Adding	237
Additives	292
Checking the oil level	236
Checking the oil level using the dipstick	236
Display message	193
Filling capacity	292
Notes about oil grades	292
Temperature (on-board com- puter)	182
Viscosity	292

Environmental protection

Note	19
------------	----

ESP® (Electronic Stability Program)

AMG menu (on-board computer) ...	182
Deactivating/activating	57
Display message	185
Function/notes	57
Important safety information	57
Trailer stabilization	58
Warning lamp	207

Exhaust check 133**Exhaust tail pipe (cleaning instructions)** 244**Exterior lighting**

see Lights

Exterior mirrors

Adjusting	80
Dipping (automatic)	81
Folding in when locking (on-board computer)	181

Folding in/out (automatically)	81
Folding in/out (electrically)	80
Out of position (troubleshooting)	81
Setting	81
Storing settings (memory func- tion)	82
Storing the parking position	81

F**Filler cap**

see Refueling

First-aid kit 248**Flat tire**

Preparing the vehicle	250
-----------------------------	-----

Folding the seat backrest (rear)**forwards/back** 217**Fuel**

Additives	291
Consumption information	291
Consumption statistics	173
Displaying the range	174
Fuel gauge	171
Grade (gasoline)	290
Important safety notes	290
Notes for AMG vehicles	291
Premium-grade unleaded gaso- line	290
Problem (malfunction)	130
Refueling	127
Tank content/reserve fuel	290

Fuel consumption

Notes	132
-------------	-----

Fuel filler flap

Emergency release	129
Opening/closing	128

Fuel level

Calling up the range (on-board computer)	174
---	-----

Fuel tank

Capacity	290
Problem (malfunction)	130

Fuel/water separator

Service	241
---------------	-----

Fuse allocation chart 259**Fuse box**

Battery case	260
Dashboard	259

Front-passenger footwell	260
Transmission tunnel	260
Fuse extractor	259
Fuses	
Allocation chart	259
Before changing	259
Dashboard fuse box	259
Fuse allocation chart	259
Fuse box in the front-passenger footwell	260
Fuse box in the transmission tun- nel	260
Important safety notes	259
In the battery case	260

G

Garage door opener	
Clearing the memory	234
General notes	231
Important safety notes	231
Opening/closing the garage door ..	234
Programming the remote control ...	231
Gasoline	290
Gear indicator (on-board com- puter)	182
Gear or selector lever (cleaning guidelines)	246
Genuine parts	19
Genuine wood trim and trim strips (cleaning instructions)	246
Glove box	215
Gradient-climbing capability (max- imum)	140
GTW (Gross Trailer Weight) (defini- tion)	279

H

Hazard warning lamps	89
Head restraints	
Adjusting	74
Adjusting (rear)	75
Installing/removing (rear)	75
Luxury	75
Resetting (front)	75
see NECK-PRO head restraints	
see NECK-PRO luxury head restraints	

Headlamps

Adding fluid to cleaning system	239
Cleaning	244
Cleaning system (function)	87
Cleaning system (notes)	295
Fogging up	89
Protective grille	95
see Automatic headlamp mode	

Heating

 see Climate control

High-beam headlamps

Display message	190
Switching on/off	88

Hill start assist

Function/notes	114
----------------------	-----

HOLD function

Function/notes	157
----------------------	-----

Hood

Closing	236
Display message	201
Important safety notes	235
Opening	236

Horn

Function/notes	26
----------------------	----

Hydroplaning

Function/notes	135
----------------------	-----

I

Immobilizer

Function/notes	59
----------------------	----

Instrument cluster

Overview	171
Warning and indicator lamps	202

Instrument cluster lighting

Function/notes	171
----------------------	-----

Interior lighting

Automatic control	90
Cargo compartment lamp	91
Delayed switch-off (on-board computer)	180
Manual control	90
Overview	89
Reading lamp	89
Rear interior lighting	92

J

Jack

Pump lever	283
Storage location	248
Using	282

Jump starting (engine)

Function/notes	254
----------------------	-----

K**Key positions**

SmartKey 112

L**Lap time (RACETIMER)** 182**LATCH-type (ISOFIX) child seat anchors** 48**License plate lamp (display message)** 190**Light sensor (display message)** 191**Lights**

Activating/deactivating the interior lighting delayed switch-off 180

Automatic headlamp mode 85

Hazard warning lamps 89

High beam flasher 88

High-beam headlamps 88

Light switch 84

Low-beam headlamps 84

Parking lamps 87

Rear fog lamp 86

Standing lamps 87

Switching the daytime running lamps on/off (on-board computer) 179

Switching the daytime running lamps on/off (switch) 85

Switching the exterior lighting delayed switch-off on/off (on-board computer) 179

Switching the surround lighting on/off (on-board computer) 179

Turn signals 88

see Interior lighting

see Replacing bulbs

LIM indicator lamp

Cruise control 142

DISTRONIC PLUS 149

Variable SPEEDTRONIC 145

Limit speed

Variable SPEEDTRONIC 145

Load anchorage 218**Loading guidelines** 214**Locking**

Emergency locking 66

From inside the vehicle (central locking button) 65
see Central locking**Locking (doors)**

Automatic 66

Locking centrally

see Central locking

Locking verification signal (on-board computer) 180**LOW RANGE off-road gear** 162**Low-beam headlamps**

Display message 189

Switching on/off 84

Luggage compartment enlargement

Overview 216

Lumbar support

Adjusting the 4-way lumbar support 76

Luxury head restraints 75**M****M+S tires** 264**Malfunction message**

see Display messages

Matte finish (cleaning instructions) 243**mbrace**

Call priority 228

Display message 187

Downloading destinations (COMAND) 228

Downloading routes 230

Emergency call 225

Geo fencing 230

Important safety notes 224

Locating a stolen vehicle 229

MB info call button 227

Remote vehicle locking 229

Roadside Assistance button 226

Self-test 225

Speed alert 230

System 225

Triggering the vehicle alarm 231

Vehicle remote malfunction diagnosis 229

Vehicle remote unlocking 228

Mechanical key	
Function/notes	61
General notes	61
Removing	61
Memory card (audio)	176
Memory function	82
Message memory (on-board computer)	184
Messages	
see Display messages	
Mirrors	
Sun visor	221
see Exterior mirrors	
see Rear-view mirror	
Mobile phone	
Menu (on-board computer)	177
Mounting wheels	
Mounting a new wheel	284
Raising the vehicle	282
Removing a wheel	283
Securing the vehicle against rolling away	282
MP3	
Operation	176
see separate operating instructions	
Multifunction display	
Function/notes	173
Permanent display	179
Multifunction steering wheel	
Back button	172
Operating the on-board computer ..	172
Overview	29

N

Navigation	
Menu (on-board computer)	174
see separate operating instructions	
NECK-PRO head restraints	
Operation	45
Resetting triggered	45
NECK-PRO luxury head restraints	
Important safety notes	45
Operation	45
Resetting when triggered	46
Notes on breaking-in a new vehicle	111

O

Occupant safety	
Automatic measures after an accident	46
BabySmart™ air bag deactivation system	50
Children in the vehicle	46
Important safety notes	35
Introduction to the restraint system	34, 47
PASSENGER AIR BAG indicator lamps	35
Pets in the vehicle	55
Restraint system warning lamp	35
Off-road	
Differential locks	164
Off-road ABS	56
Off-road driving	
Checklist	138
Driving on sand	139
Important safety notes	137
Traveling uphill	140
Off-road fording	135
Off-road system	
Permanent all-wheel drive	157
Oil	
see Engine oil	
On-board computer	
AMG menu	182
Assistance menu	178
Audio menu	176
Convenience submenu	181
Display messages	184
DISTRONIC PLUS	151
Factory settings submenu	181
Important safety notes	170
Instrument cluster submenu	179
Lighting submenu	179
Menu overview	173
Message memory	184
Navigation menu	174
Operation	172
RACETIMER	182
Service menu	178
Settings menu	178
Standard display	173
Telephone menu	177

- Trip menu 173
 Vehicle submenu 180
 Video DVD operation 176
- Operating safety**
 Declaration of conformity 23
 Important safety notes 22
- Operating system**
 see On-board computer
- Outside temperature display** 171
- Overhead control panel** 32
- Override feature**
 Rear side windows 54
- P**
- Paint code number** 288
- Paintwork (cleaning instructions)** ... 243
- Panic alarm** 34
- Parcel net** 216
- Parking**
 Engaging park position 119
 Important safety notes 130
 Position of exterior mirror, front-passenger side 81
 see PARKTRONIC
- Parking aid**
 see Exterior mirrors
 see PARKTRONIC
- Parking brake**
 Applying 131
 Display message 186
 Warning lamp 209
- Parking lamps**
 Switching on/off 87
- PARKTRONIC**
 Deactivating/activating 160
 Driving system 158
 Function/notes 158
 Important safety notes 158
 Problem (malfunction) 161
 Range of the sensors 158
 Trailer towing 160
 Warning display 159
- PASSENGER AIR BAG OFF**
 Indicator lamp 35
 Problems (malfunctions) 53
- Pedals** 133
- Permanent all-wheel drive**
 Off-road system 157
- Pets in the vehicle** 55
- Plastic trim (cleaning instructions)** 245
- Power supply (trailer)** 168
- Power washers** 242
- Program selector button** 122
- Programming**
 SmartKey 61
- Pulling away**
 Automatic transmission 113
- Q**
- QR code**
 Rescue card 24
- Qualified specialist workshop** 23
- R**
- RACETIMER**
 Deleting all laps 183
 Displaying and starting 182
 Displaying the intermediate time ... 182
 Resetting the current lap 183
 Starting a new lap 183
 Stopping 183
- RACETIMER (on-board computer)** 182
- Radio**
 Selecting a station 176
 see separate operating instructions
- Radio-wave reception/transmission in the vehicle**
 Declaration of conformity 23
- Reading lamp** 89
- Rear bench seat**
 Folding forward 218
- Rear compartment**
 Setting the air vents 110
- Rear door**
 Closing 68
 Display message 201
 Important safety notes 67
 Opening 67
 Opening/closing 67
- Rear fog lamp**
 Display message 190

- Switching on/off 86
 - Rear lamps**
 - see Lights
 - Rear seat bench**
 - Folding into an upright position 218
 - Rear view camera**
 - Function/notes 161
 - Rear view camera (cleaning instructions)** 244
 - Rear window defroster**
 - Problem (malfunction) 107
 - Switching on/off 107
 - Rear window wiper**
 - Switching on/off 97
 - Rear-view mirror**
 - Dipping (automatic) 81
 - Refrigerant (air-conditioning system)**
 - Important safety notes 293
 - Refueling**
 - Fuel gauge 171
 - Important safety notes 127
 - Refueling process 128
 - see Fuel
 - Remote control**
 - Programming (garage door opener) 231
 - Replacing bulbs**
 - Important safety notes 92
 - Overview of bulb types 93
 - Reporting safety defects** 23
 - Rescue card** 24
 - Reserve (fuel tank)**
 - see Fuel
 - Reserve fuel**
 - Display message 194
 - Warning lamp 210
 - see Fuel
 - Residual heat**
 - Switching on/off 108
 - Restraint system**
 - Display message 187
 - Introduction 34
 - Warning lamp 209
 - Warning lamp (function) 35
 - Reversing lamps (display message)** 191
 - Roadside Assistance (breakdown)** 21
 - Roof lining and carpets (cleaning guidelines)** 247
 - Route (navigation)**
 - see Route guidance (navigation)
 - Route guidance (navigation)** 174
- S**
- Safety**
 - Children in the vehicle 46
 - Safety system**
 - see Driving safety systems
 - Seat backrest**
 - Folding back 217
 - Seat belts**
 - Adjusting the height 38
 - center rear-compartment seat 38
 - Cleaning 246
 - Correct usage 37
 - Fastening 38
 - Important safety guidelines 36
 - Introduction 36
 - Releasing 39
 - Warning lamp 204
 - Warning lamp (function) 40
 - Seat heating**
 - Indicator lamp (malfunction) 77
 - Seat ventilation**
 - Indicator lamp (malfunction) 77
 - Seats**
 - Adjusting (electrically) 74
 - Adjusting the 4-way lumbar support 76
 - Adjusting the head restraint 74
 - Cleaning the cover 246
 - Correct driver's seat position 72
 - Important safety notes 72
 - Overview 72
 - Storing settings (memory function) 82
 - Switching seat heating on/off 76
 - Switching seat ventilation on/off 77
 - Sensors (cleaning instructions)** 244
 - Service interval display**
 - Displaying a service message (on-board computer) 240

- Service menu (on-board computer)** 178
- Service products**
 - Brake fluid 293
 - Coolant (engine) 294
 - Engine oil 292
 - Fuel 289
 - Important safety notes 289
 - Notes 289
 - Refrigerant (air-conditioning system) 293
 - Washer fluid 295
- Setting a speed limit**
see SPEEDTRONIC
- Setting the air distribution** 105
- Settings**
 - Calling up a stored setting 83
 - Factory (on-board computer) 181
 - On-board computer 178
- SETUP (on-board computer)** 182
- Shift ranges** 123
- Side impact air bag** 42
- Side marker lamp (display message)** 191
- Side marker lamps (changing bulbs)** 94
- Side windows**
 - Convenience closing feature 69
 - Convenience opening feature 68
 - Important safety information 68
 - Opening/closing 68
 - Overview 68
 - Troubleshooting 69
- Ski rack** 220
- Sliding sunroof**
 - Important safety notes 69
 - Opening/closing 70
 - Operating manually 70
 - Problem (malfunction) 71
- SmartKey**
 - Changing the battery 62
 - Changing the programming 61
 - Checking the battery 62
 - Convenience closing feature 69
 - Convenience opening feature 68
 - Display message 202
 - Door central locking/unlocking 60
 - Important safety notes 60
 - Loss 63
 - Malfunction 63
 - Mechanical key 61
 - Overview 60
 - Problem (malfunction) 63
 - Starting the engine 113
- Snow chains** 264
- Sockets**
 - Front-passenger footwell 223
 - Luggage compartment 223
 - Rear compartment 223
- SOS**
see mbrace
- Spare fuses** 259
- Spare wheel**
 - Mounting 281
 - Notes/data 286
 - Spare wheel bracket at the rear 249
 - Stainless-steel spare hub cap 249
- Special seat belt retractor** 47
- Specialist workshop** 23
- Speed, controlling**
see Cruise control
- Speedometer**
 - Digital 174
 - In the Instrument cluster 171
 - Segments 171
 - Selecting the unit of measurement 179
 - see Instrument cluster
- SPEEDTRONIC**
 - Display message 197
 - Selecting 145
 - Variable 145
- Standing lamps**
 - Display message 191
 - Switching on/off 87
- Starting the engine**
 - Important safety notes 113
- Steering (display message)** 202
- Steering wheel**
 - Adjusting (electrically) 78
 - Buttons (on-board computer) 172
 - Cleaning 246
 - Important safety notes 78
 - Paddle shifters 123

- Steering wheel heating 78
 - Storing settings (memory function) 82
 - Steering wheel heating**
 - Indicator lamp (malfunction) 79
 - Steering wheel paddle shifters** 123
 - Stopwatch (RACETIMER)** 182
 - Stowage areas** 215
 - Stowage compartment**
 - Door stowage compartment 216
 - Stowage compartments**
 - Armrest (under) 216
 - Cup holders 220
 - Glove box 215
 - Important safety information 215
 - Stowage pockets 216
 - Summer tires** 264
 - Sun visor** 221
 - Surround lighting (on-board computer)** 179
 - SUV**
 - (Sport Utility Vehicle) 22
 - Switching air-recirculation mode on/off** 107
 - Switching off the alarm (ATA)** 59
- T**
- Tachometer** 171
 - Tail lamps**
 - Display message 191
 - see Lights
 - Tank content**
 - Fuel gauge 171
 - Technical data**
 - Capacities 289
 - Tires 284
 - Tires/wheels 284
 - Trailer loads 298
 - Vehicle data 295
 - Wheels 284
 - TELEAID**
 - Call priority 228
 - Downloading destinations (COMAND) 228
 - Downloading routes 230
 - Emergency call 225
 - Geo fencing 230
 - Important safety notes 224
 - Locating a stolen vehicle 229
 - MB info call button 227
 - Remote vehicle locking 229
 - Roadside Assistance button 226
 - Self-test 225
 - Speed alert 230
 - System 225
 - Triggering the vehicle alarm 231
 - Vehicle remote malfunction diagnosis 229
 - Vehicle remote unlocking 228
 - Telephone**
 - Accepting a call 177
 - Display message 202
 - Menu (on-board computer) 177
 - Number from the phone book 177
 - Redialing 178
 - Rejecting/ending a call 177
 - Telephone compartment** 216
 - Temperature**
 - Coolant 171
 - Coolant (on-board computer) 182
 - Engine oil (on-board computer) 182
 - Outside temperature 171
 - Setting (climate control) 105
 - Theft deterrent systems**
 - ATA (Anti-Theft Alarm system) 59
 - Immobilizer 59
 - Tilt/sliding sunroof**
 - see Sliding sunroof
 - Time**
 - see separate operating instructions
 - Timing (RACETIMER)** 182
 - Tire pressure**
 - Calling up (on-board computer) 268
 - Checking manually 268
 - Display message 198
 - Maximum 268
 - Notes 266
 - Recommended 265
 - Table (single tires) 266
 - Tire pressure monitor**
 - Checking the tire pressure electronically 270
 - Function/notes 268
 - Restarting 270
 - Warning lamp 213

- Warning message 270
- Tires**
- Aspect ratio (definition) 280
 - Average weight of the vehicle occupants (definition) 279
 - Bar (definition) 279
 - Changing a wheel 281
 - Characteristics 279
 - Checking 262
 - Curb weight (definition) 280
 - Definition of terms 279
 - Direction of rotation 282
 - Display message 198
 - Distribution of the vehicle occupants (definition) 281
 - DOT (Department of Transportation) (definition) 279
 - DOT, Tire Identification Number (TIN) 278
 - GAWR (Gross Axle Weight Rating) (definition) 279
 - GTW (Gross Trailer Weight) (definition) 279
 - GVW (Gross Vehicle Weight) (definition) 279
 - GVWR (Gross Vehicle Weight Rating) (definition) 280
 - Important safety notes 262
 - Increased vehicle weight due to optional equipment (definition) 279
 - Kilopascal (kPa) (definition) 280
 - Labeling (overview) 275
 - Load bearing index (definition) 281
 - Load index 277
 - Load index (definition) 280
 - Maximum load on a tire (definition) 280
 - Maximum loaded vehicle weight (definition) 280
 - Maximum permissible tire pressure (definition) 280
 - Maximum tire load 278
 - Maximum tire load (definition) 280
 - Optional equipment weight (definition) 281
 - PSI (pounds per square inch) (definition) 280
 - Replacing 281
 - Service life 263
 - Sidewall (definition) 280
 - Speed rating (definition) 279
 - Storing 282
 - Structure and characteristics (definition) 279
 - Technical data 284
 - Temperature 275
 - TIN (Tire Identification Number) (definition) 281
 - Tire bead (definition) 280
 - Tire pressure (definition) 280
 - Tire pressures (recommended) 279
 - Tire size (data) 284
 - Tire size designation, load-bearing capacity, speed rating 276
 - Tire tread 263
 - Tire tread (definition) 280
 - Total load limit (definition) 281
 - Traction 275
 - Traction (definition) 281
 - Tread wear 274
 - TWR (permissible trailer drawbar noseweight) (definition) 281
 - Uniform Tire Quality Grading Standards 274
 - Uniform Tire Quality Grading Standards (definition) 279
 - Wear indicator (definition) 281
 - Wheel rim (definition) 279
 - see Flat tire
- Top Tether** 49
- Tow-starting**
- Emergency engine starting 259
 - Important safety notes 256
- Towing a trailer**
- Axle load, permissible 298
 - Driving tips 166
 - Lights display message 189
 - Mounting dimensions 297
 - Shift range 122
 - Trailer loads 298
 - Trailer tow hitch 297
- Towing away**
- Important safety guidelines 256
 - In the event of malfunctions 258
 - With both axles on the ground 257

Towing eye	
Front	257
Rear	257
Trailer	
7-pin connector	169
Power supply	168
Trailer coupling (cleaning instructions)	245
Trailer loads	
Technical data	298
Trailer tow hitch	
Ball position	298
Trailer towing	
ESP®	58
PARKTRONIC	160
Transfer case	
General notes	162
Shift range	162
Shifting	162
Shifting (general notes)	162
Shifting (important safety notes) ...	162
Shifting to neutral	163
Switching off the off-road gear ratio	163
Switching on the off-road gear ratio	163
Transmission	
see Automatic transmission	
Transmission positions	121
Transporting the vehicle	258
Traveling uphill	
Brow of hill	140
Trip computer (on-board computer)	173
Trip odometer	
Calling up	173
Resetting (on-board computer)	174
Turn signals	
Changing bulbs (front)	94
Display message	190
Switching on/off	88
TWR (Tongue Weight Rating) (definition)	281
Type identification plate	
see Vehicle identification plate	

U

Unlocking

Emergency unlocking	66
From inside the vehicle (central unlocking button)	65

V

Vanity mirror

Sun visor	221
-----------------	-----

Variable SPEEDTRONIC

Function/notes	145
----------------------	-----

Vehicle

Correct use	23
Data acquisition	24
Display message	201
Emergency locking	66
Emergency unlocking	66
Equipment	20
Individual settings	178
Limited Warranty	24
Loading	271
Locking (SmartKey)	60
Lowering	284
Maintenance	21
Parking for a long period	132
Pulling away	113
Raising	282
Reporting problems	23
Securing from rolling away	282
Tow-starting	256
Towing away	256
Transporting	258
Unlocking (SmartKey)	60
Vehicle data	295

Vehicle data**Vehicle data (off-road driving)**

Approach/departure angle	296
Fording depth	296
Maximum gradient climbing ability	297

Vehicle dimensions**Vehicle identification number**

 see VIN

Vehicle identification plate**Vehicle tool kit**

- Ventilation**
 Setting the airflow 105
- Video**
 Operating the DVD 176
- VIN** 288
- W**
- Warning and indicator lamps**
 ABS 206
 Brakes 205
 Check Engine 210
 Coolant 210
 Cruise control 142
 Distance warning 212
 DISTRONIC PLUS 212
 ESP® 207
 ESP® OFF 208
 Fuel tank 210
 LIM (DISTRONIC PLUS) 149
 LIM (variable SPEEDTRONIC) 145
 Overview 28, 202
 Parking brake 209
 PASSENGER AIR BAG OFF 35
 Reserve fuel 210
 Restraint system 209
 Seat belt 204
 Tire pressure monitor 213
- Warning triangle** 248
- Warranty** 20
- Washer fluid**
 Display message 202
- Wheel bolt tightening torque** 284
- Wheels**
 Changing a wheel 281
 Checking 262
 Cleaning 242
 Important safety notes 262
 Interchanging/changing 281
 Mounting a new wheel 284
 Mounting a wheel 282
 Overview 262
 Removing a wheel 283
 Storing 282
 Technical data 284
 Tightening torque 284
 Wheel size/tire size 284
- Window curtain air bag**
 Display message 188
 Operation 43
- Windows**
 see Side windows
- Windows (cleaning instructions)** 243
- Windshield**
 Defrosting 105
- Windshield heating** 106
- Windshield washer fluid**
 see Windshield washer system
- Windshield washer system**
 Adding washer fluid 239
 Notes 295
- Windshield wipers**
 Problem (malfunction) 98
 Rear window wiper 97
 Replacing the wiper blades 97
 Switching on/off 96
- Winter**
 Driving in winter 136
 Winter operation 264
- Winter driving**
 Snow chains 264
- Winter operation**
 Overview 264
- Winter tires**
 M+S tires 264
- Wiper blades**
 Cleaning 244
 Important safety notes 97
 Replacing 97

Protection of the environment

General notes

Environmental note

Daimler's declared policy is one of comprehensive environmental protection.

The objectives are for the natural resources that form the basis of our existence on this planet to be used sparingly and in a manner that takes the requirements of both nature and humanity into account.

You too can help to protect the environment by operating your vehicle in an environmentally responsible manner.

Fuel consumption and the rate of engine, transmission, brake and tire wear are affected by these factors:

- operating conditions of your vehicle
- your personal driving style

You can influence both factors. You should bear the following in mind:

Operating conditions:

- avoid short trips as these increase fuel consumption.
- always make sure that the tire pressures are correct.
- do not carry any unnecessary weight.
- remove roof racks once you no longer need them.
- a regularly serviced vehicle will contribute to environmental protection. You should therefore adhere to the service intervals.
- always have service work carried out at a qualified specialist workshop.

Personal driving style:

- do not depress the accelerator pedal when starting the engine.
- do not warm up the engine when the vehicle is stationary.
- drive carefully and maintain a safe distance from the vehicle in front.
- avoid frequent, sudden acceleration and braking.

- change gear in good time and use each gear only up to $\frac{2}{3}$ of its maximum engine speed.
- switch off the engine in stationary traffic.
- keep an eye on the vehicle's fuel consumption.

Environmental concerns and recommendations

Wherever the operating instructions require you to dispose of materials, first try to regenerate or re-use them. Observe the relevant environmental rules and regulations when disposing of materials. In this way you will help to protect the environment.

Genuine Mercedes-Benz parts

Environmental note

Daimler AG also supplies reconditioned major assemblies and parts which are of the same quality as new parts. They are covered by the same Limited Warranty entitlements as new parts.

! Air bags and Emergency Tensioning Devices, as well as control units and sensors for these restraint systems, may be installed in the following areas of your vehicle:

- doors
- door pillars
- door sills
- seats
- cockpit
- instrument cluster
- center console

Do not install accessories such as audio systems in these areas. Do not carry out repairs or welding. You could impair the operating efficiency of the restraint systems.

Have aftermarket accessories installed at a qualified specialist workshop.

You could jeopardize the operating safety of your vehicle if you use parts, tires and wheels as well as accessories relevant to safety which have not been approved by Mercedes. This could lead to malfunctions in safety-relevant

systems, e.g. the brake system. Use only genuine Mercedes-Benz parts or parts of equal quality. Only use tires, wheels and accessories that have been specifically approved for your vehicle.

Genuine Mercedes-Benz parts are subject to strict quality control. Every part has been specifically developed, manufactured or selected for and adapted to Mercedes-Benz vehicles. Only genuine Mercedes-Benz parts should therefore be used.

More than 300,000 different genuine Mercedes-Benz parts are available for Mercedes-Benz models.

All authorized Mercedes-Benz Centers maintain a supply of genuine Mercedes-Benz parts for necessary service and repair work. In addition, strategically located parts delivery centers provide quick and reliable parts service.

Always specify the vehicle identification number (VIN) when ordering genuine Mercedes-Benz parts (> page 288).

Operator's Manual

Vehicle equipment

This Operator's Manual describes all models and all standard and optional equipment of your vehicle available at the time of going to print. Country-specific differences are possible. Bear in mind that your vehicle may not feature all functions described here. This also applies to safety-relevant systems and functions. The equipment in your vehicle may therefore differ from that shown in the descriptions and illustrations.

The original purchase agreement lists all systems installed in your vehicle.

Should you have any questions concerning equipment and operation, please consult an authorized Mercedes-Benz Center.

The Operator's Manual and the Maintenance Booklet are important documents and should be kept in the vehicle.

Service and vehicle operation

Warranty

Your vehicle is covered under the terms of the warranties printed in the Service and Warranty Information booklet.

Your authorized Mercedes-Benz Center will replace and repair all factory-installed parts in accordance with the following warranty terms and conditions:

- New Vehicle Limited Warranty
- Emission Systems Warranty
- Emission Performance Warranty
- California, Connecticut, Maine, Massachusetts, New York, Pennsylvania, Rhode Island and Vermont Emission Control System Warranty
- State warranty enforcement laws (Lemon Laws)

Replacement parts and accessories are covered by the Mercedes-Benz Parts and Accessories warranties. These are available at any authorized Mercedes-Benz Center.

i If you lose the Service and Warranty Information booklet, contact an authorized Mercedes-Benz Center to arrange a replacement. It will be mailed to you.

Information for customers in California

In California, you have the right to exchange a vehicle or receive a refund of the purchase or leasing price if Mercedes-Benz USA, LLC and/or an authorized workshop or maintenance facility cannot, after several authorized repairs, rectify considerable damage to or malfunctions of the vehicle that are covered by the contractual warranty. During the period of 18 months from original delivery of the vehicle or the accumulation of 18,000 miles (approximately 29,000 km) on the odometer of the vehicle, whichever occurs first, a reasonable number of repair attempts is presumed for a retail buyer or lessee if one or more of the following occurs:

- (1) the serious defect or damage can result in deadly or serious injury to the vehicle occupants while driving AND this defect has already been repaired at least twice AND

Mercedes-Benz, LLC has been informed in writing of the necessity of a repair.

- (2) the defect or damage, though less serious than (1) above, has already been repaired at least four times AND Mercedes-Benz has been informed in writing of the necessity of a repair.
- (3) the vehicle cannot be used for longer than 30 calendar days because of repair work resulting from this or other serious defects or damage.

Please send your written notice to:

Mercedes-Benz USA, LLC
Customer Assistance Center
One Mercedes Drive
Montvale, NJ 07645-0350

Maintenance

The Service and Warranty Booklet describes all the necessary maintenance work which should be done at regular intervals.

Always have the Service and Warranty Booklet with you when you bring the vehicle to an authorized Mercedes-Benz Center. The service advisor will record every service for you in the Service and Warranty Booklet.

Roadside Assistance

The Mercedes-Benz Roadside Assistance Program offers technical help in the event of a breakdown. Calls to the toll-free Roadside Assistance Hotline are answered by our agents 24 hours a day, 365 days a year.

1-800-FOR-MERCEdes(1-800-367-6372)
(USA)

1-800-387-0100 (Canada)

For additional information, refer to the Mercedes-Benz Roadside Assistance Program brochure (USA) or the "Roadside Assistance" section in the Service and Warranty booklet (Canada). You will find both in your vehicle literature portfolio.

Change of address or change of ownership

In the event of a change of address, please send us the "Notification of Address Change" in the

Service and Guarantee booklet or simply call the Mercedes-Benz Customer Assistance Center (USA) at the hotline number 1-800-FOR-MERCEdes(1-800-367-6372) or Customer Service Center (Canada) at 1-800-387-0100. This will assist us in contacting you in a timely manner should the need arise.

If you sell your Mercedes, please leave the entire literature in the vehicle so that it is available to the next owner.

If you have purchased a used car, please send us the "Notification of Used Car Purchase" in the Service and Guarantee booklet or simply call the Mercedes-Benz Customer Assistance Center (USA) at the hotline number 1-800-FOR-MERCEdes(1-800-367-6372) or Customer Service (Canada) at 1-800-387-0100.

Vehicle operation outside the USA and Canada

If you plan to operate your vehicle in foreign countries, please be aware that:

- service facilities or replacement parts may not be readily available.
- unleaded fuel for vehicles with a catalytic converter may not be available. Leaded fuel may cause damage to the catalytic converter.
- the fuel may have a considerably lower octane rating. Unsuitable fuel can cause engine damage.

Some Mercedes-Benz models are available for delivery in Europe through our European Delivery Program. For details, consult an authorized Mercedes-Benz Center or write to one of the following addresses.

In the USA

Mercedes-Benz USA, LLC
European Delivery Department
One Mercedes Drive
Montvale, NJ 07645-0350

In Canada

Mercedes-Benz Canada, Inc.
European Delivery Department
98 Vanderhoof Avenue
Toronto, Ontario M4G 4C9

Sports Utility Vehicle

WARNING

Due to the high center of gravity, the vehicle may start to skid and roll over in the event of an abrupt steering maneuver and/or when the vehicle's speed is not adapted to the road conditions. There is a risk of an accident.

Always adapt your speed and driving style to the vehicle's driving characteristics and to the prevailing road and weather conditions.

Utility vehicles have a significantly higher roll-over rate than other types of vehicles.

Failure to operate this vehicle safely may result in an accident, rollover of the vehicle, and severe or fatal injury.

In a rollover crash, an unbelted person is significantly more likely to die than a person wearing a seat belt.

You and all vehicle occupants should always wear your seat belts.

Operating safety

Important safety notes

WARNING

If you do not have the prescribed service/maintenance work or any required repairs carried out, this can result in malfunctions or system failures. There is a risk of an accident.

Always have the prescribed service/maintenance work as well as any required repairs carried out at a qualified specialist workshop.

WARNING

Flammable material such as leaves, grass or twigs may ignite if they come into contact with hot parts of the exhaust system. There is a risk of fire.

When driving off road or on unpaved roads, check the vehicle's underside regularly. In particular, remove parts of plants or other flammable materials which have become trapped. In the case of damage, contact a qualified specialist workshop.

WARNING

Modifications to electronic components, their software as well as wiring can impair their function and/or the function of other networked components. In particular, systems relevant to safety could also be affected. As a result, these may no longer function as intended and/or jeopardize the operating safety of the vehicle. There is an increased risk of an accident and injury.

Never tamper with the wiring as well as electronic components or their software. You should have all work to electrical and electronic equipment carried out at a qualified specialist workshop.

If you make any changes to the vehicle electronics, the general operating permit is rendered invalid.

 There is a risk of damage to the vehicle if:

- the vehicle becomes stuck, e.g. on a high curb or an unpaved road
- you drive too fast over an obstacle, e.g. a curb or a hole in the road
- a heavy object strikes the undercarriage or parts of the chassis

In situations like this, the body, the undercarriage, chassis parts, wheels or tires could be damaged without the damage being visible. Components damaged in this way can unexpectedly fail or, in the case of an accident, no longer withstand the strain they are designed to.

If the underbody paneling is damaged, combustible materials such as leaves, grass or twigs can gather between the underbody and the underbody paneling. If these materials come in contact with hot parts of the exhaust system, they can catch fire.

In such situations, have the vehicle checked and repaired immediately at a qualified specialist workshop. If on continuing your journey you notice that driving safety is impaired, pull over and stop the vehicle immediately, paying attention to road and traffic conditions. In such cases, consult a qualified specialist workshop.

Declarations of conformity

Vehicle components which receive and/or transmit radio waves

USA: "The wireless devices of this vehicle comply with Part 15 of the FCC Rules. Operation is subject to the following two conditions: 1) These devices may not cause harmful interference, and 2) These devices must accept any interference received, including interference that may cause undesired operation. Changes or modifications not expressly approved by the party responsible for compliance could void the user's authority to operate the equipment."

Canada: "The wireless devices of this vehicle comply with Industry Canada license-exempt RSS standard(s). Operation is subject to the following two conditions: (1) These devices may not cause interference, and (2) These devices must accept any interference, including interference that may cause undesired operation of the device."

Qualified specialist workshop

An authorized Mercedes-Benz Center is a qualified specialist workshop. It has the necessary specialist knowledge, tools and qualifications to correctly carry out the work required on your vehicle. This is especially the case for work relevant to safety.

Observe the notes in the Maintenance Booklet. Always have the following work carried out at an authorized Mercedes-Benz Center:

- work relevant to safety
- service and maintenance work
- repair work
- alterations, installation work and modifications
- work on electronic components

Correct use

If you remove any warning stickers, you or others could fail to recognize certain dangers. Leave warning stickers in position.

Observe the following information when driving your vehicle:

- the safety notes in this manual
- the technical data section in this manual
- traffic rules and regulations
- laws and safety standards pertaining to motor vehicles

Problems with your vehicle

If you should experience a problem with your vehicle, particularly one that you believe may affect its safe operation, we urge you to contact an authorized Mercedes-Benz Center immediately to have the problem diagnosed and rectified. If the problem is not resolved to your satisfaction, please discuss the problem again with a Mercedes-Benz Center or contact us at one of the following addresses.

In the USA

Customer Assistance Center
Mercedes-Benz USA, LLC
One Mercedes Drive
Montvale, NJ 07645-0350

In Canada

Customer Relations Department
Mercedes-Benz Canada, Inc.
98 Vanderhoof Avenue
Toronto, Ontario M4G 4C9

Reporting safety defects

USA only:

The following text is reproduced as required of all manufacturers according to Title 49, Code of U.S. Federal Regulations, Part 575 pursuant to the National Traffic and Motor Vehicle Safety Act of 1966.

If you believe that your vehicle has a defect which could cause a crash or could cause injury or death, you should immediately inform the National Highway Traffic Safety Administration (NHTSA) in addition to notifying Mercedes-Benz USA, LLC.

If NHTSA receives similar complaints, it may open an investigation, and if it finds that a safety defect exists in a group of vehicles, it may order a recall and remedy campaign. However, NHTSA cannot become involved in individual problems

between you, your dealer, or Mercedes-Benz USA, LLC.

To contact NHTSA, you may call the Vehicle Safety Hotline toll-free at 1-888-327-4236 (TTY: 1-800-424-9153); go to <http://www.safercar.gov>; or write to: Administrator, NHTSA Headquarters, 1200 New Jersey Avenue, SE, West Building, Washington, DC 20590.

You can obtain additional information about vehicle safety from:

<http://www.safercar.gov>

Limited Warranty

! Follow the instructions in this manual about the proper operation of your vehicle as well as about possible vehicle damage. Damage to your vehicle that arises from culpable contraventions against these instructions is not covered either by the Mercedes-Benz Limited Warranty or by the New or Used-Vehicle Warranty.

QR codes for rescue cards

The QR codes are secured in the fuel filler flap and on the opposite side on the B-pillar. In the event of an accident, rescue services can use the QR codes to quickly find the appropriate rescue cards for your vehicle. The current rescue card contains the most important information about your vehicle in a compact form, e.g. the routing of the electric cables.

You can find more information under http://portal.aftersales.i.daimler.com/public/content/asportal/en/communication/informationen_fuer/QRCode.html.

Data stored in the vehicle

Data recording

A wide range of electronic components in your vehicle contain data memories.

These data memories temporarily or permanently store technical information about:

- Vehicle's operating state
- Incidents
- Malfunctions

In general, this technical information documents the state of a component, a module, a system or the surroundings.

These include, for example:

- operating conditions of system components, e.g. fluid levels
- the vehicle's status messages and those of its individual components, e.g. number of wheel revolutions/speed, deceleration in movement, lateral acceleration, accelerator pedal position
- malfunctions and defects in important system components, e.g. lights, brakes
- vehicle reactions and operating conditions in special driving situations, e.g. air bag deployment, intervention of stability control systems
- ambient conditions, e.g. outside temperature

This data is of an exclusively technical nature and can be used to:

- assist in recognizing and rectifying malfunctions and defects
- analyze vehicle functions, e.g. after an accident
- optimize vehicle function

The data cannot be used to trace the vehicle's movements.

When your vehicle is serviced, technical information can be read from the event data memory and malfunction data memory.

Services include, for example:

- repair services
- service processes
- warranties
- quality assurance

It is read by employees of the service network (including manufacturers) using special diagnostic devices. More detailed information is obtained from it, if required.

After a malfunction has been rectified, the information is deleted from the malfunction memory or is continually overwritten.

When operating the vehicle, situations are conceivable in which this technical data, in connection with other information (if necessary, under consultation with an authorized expert), could be traced to a person.

Examples include:

- accident reports
- damage to the vehicle
- witness statements

Further additional functions that have been contractually agreed upon with the customer allow certain vehicle data to be conveyed by the vehicle as well. The additional functions include, for example, vehicle location in case of an emergency.

COMAND/mbrace (Canada: TELEAID)

If the vehicle is equipped with COMAND or mbrace, additional data about the vehicle's operation, the use of the vehicle in certain situations, and the location of the vehicle may be compiled through COMAND or the mbrace system.

For additional information please refer to the COMAND User Manual and/or the mbrace Terms and Conditions.

Event data recorders

This vehicle is equipped with an event data recorder (EDR). The main purpose of an EDR is to record data that will assist in understanding how a vehicle's systems performed in certain crash or near crash-like situations, such as during air bag deployment or when hitting a road obstacle. The EDR is designed to record data related to vehicle dynamics and safety systems for a short period of time, typically 30 seconds or less.

The EDR in this vehicle is designed to record such data as:

- how various systems in your vehicle are operating
- whether or not the driver and passenger seat belts are fastened
- how far (if at all) the driver is depressing the accelerator and/or brake pedal and
- how fast the vehicle is traveling

This data can help provide a better understanding of the circumstances in which crashes and injuries occur. NOTE: EDR data is recorded by your vehicle only if a non-trivial crash situation occurs; no data is recorded by the EDR under normal driving conditions and no personal data (e.g., name, gender, age, and crash location) are

recorded. However, other parties, such as law enforcement, can combine the EDR data with the type of personal identification data routinely acquired during a crash investigation.

To read data recorded by an EDR, special equipment is required, and access to the vehicle or the EDR is needed. In addition to the vehicle manufacturer, other parties that have the special equipment, such as law enforcement, can read the information by accessing the vehicle or the EDR.

EDR data may be used in civil and criminal matters as a tool in accident reconstruction, accident claims, and vehicle safety. Since the Crash Data Retrieval CDR tool that is used to extract data from the EDR is commercially available, Mercedes-Benz USA, LLC ("MBUSA") expressly disclaims any and all liability arising from the extraction of this information by unauthorized Mercedes-Benz personnel.

MBUSA will not share EDR data with others without the consent of the vehicle owners or, if the vehicle is leased, without the consent of the lessee. Exceptions to this representation include responses to subpoenas by law enforcement; by federal, state or local government; in connection with or arising out of litigation involving MBUSA or its subsidiaries and affiliates; or, as required by law.

Warning: The EDR is a component of the Supplemental Restraint System ("SRS") Module. Tampering with, altering, modifying or removing the EDR component may result in a malfunction of the SRS Module and other systems.

State laws or regulations regarding EDRs that conflict with federal regulation are pre-empted. This means that in the event of such conflict, the federal regulation governs. As of February 2013, 13 states have enacted laws relating to EDRs.

Information on copyright

General information

Information on license for free and open-source software used in your vehicle and its electronic components is available on the following website:

<http://www.mercedes-benz.com/opensource>

Cockpit

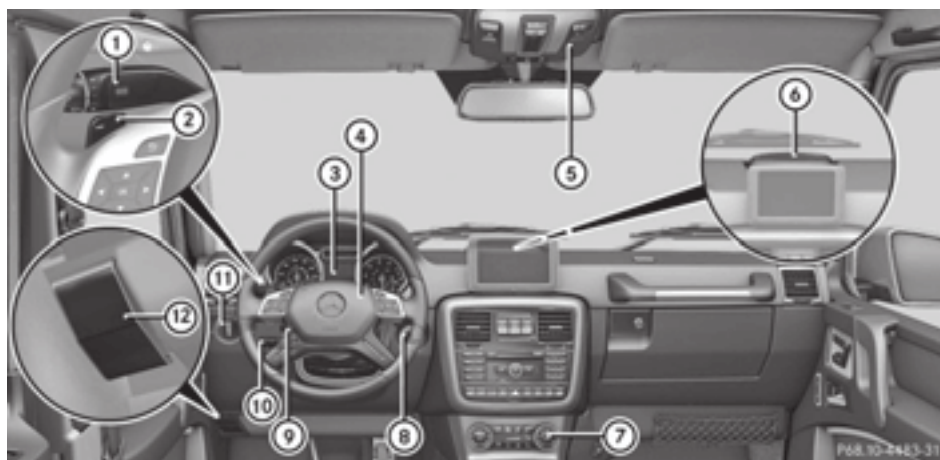

	Function	Page
①	Combination switch	88
②	Steering wheel paddle shifters	123
③	Instrument cluster	171
④	Horn	
⑤	Overhead control panel	32
⑥	PARKTRONIC warning display	158
⑦	Climate control systems	99
⑧	Ignition lock	112
⑨	Adjusts the steering wheel	78
⑩	Cruise control lever	141
⑪	Light switch	84
⑫	Opens the hood	236

Instrument cluster

Displays and controls



	Function	Page
①	Speedometer with segments	171
②	Multifunction display	173
③	Tachometer	171
④	Coolant temperature display	171
⑤	Fuel gauge	
⑥	Instrument cluster lighting control	171

Warning and indicator lamps

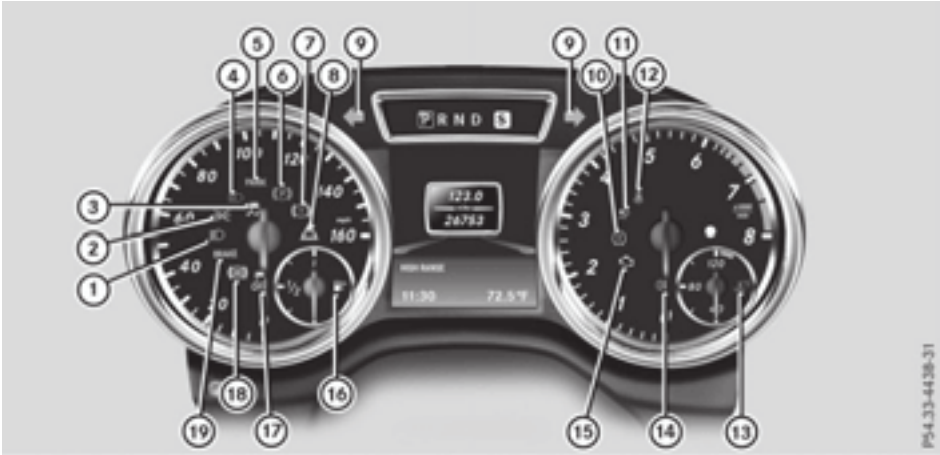

PS4.33-4438-31

	Function	Page
①	Low-beam headlamps	84
②	Parking lamps, license plate and instrument cluster lighting	84
③	ESP®	207
④	High-beam headlamps	88
⑤	Electric parking brake (yellow) USA only Canada only	131
⑥	Electric parking brake (red)	131
⑦	Brakes (yellow)	205
⑧	Distance warning	212
⑨	Turn signals	88

	Function	Page
⑩	Tire pressure monitor	213
⑪	Restraint system	34
⑫	Seat belt	204
⑬	Coolant	210
⑭	Rear fog lamp	86
⑮	Check Engine	210
⑯	Reserve fuel	210
⑰	ESP® OFF	207
⑱	ABS	206
⑲	Brakes (red) (USA only) (Canada only)	205

Multifunction steering wheel







	Function	Page
①	Multifunction display	
②	COMAND display	
③	Switches on the Voice Control System; see the separate operating instructions	
④	Rejects or ends a call Exits phone book/redial memory Makes or accepts a call Switches to the redial memory Adjusts the volume Mute	



	Function	Page
⑤	 Selects a menu Selects a submenu or scrolls through lists Confirms selections and hides messages	
⑥	Back Switches off the Voice Control System; see the separate operating instructions	

Center console

Center console, upper section





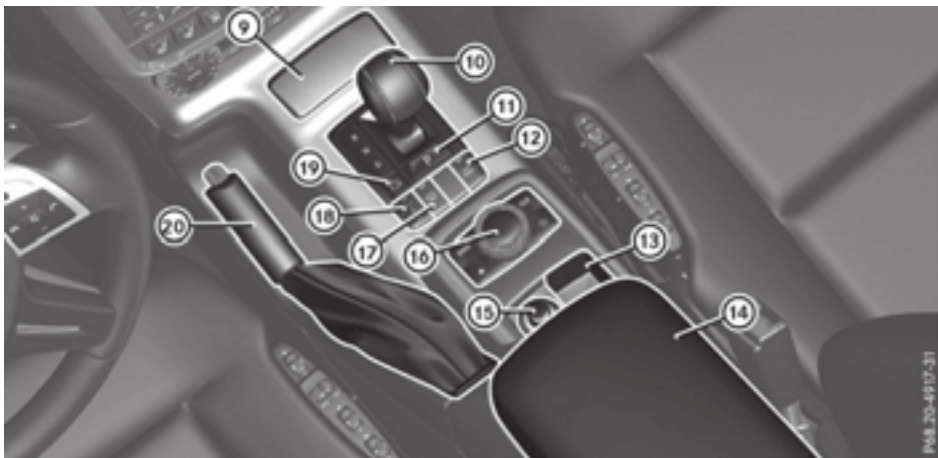

	Function	Page
①	COMAND (see separate operating instructions)	
②	 Seat heating	76
③	 Seat ventilation	77
④	 PARKTRONIC	158
⑤	 ECO start/stop function	114

	Function	Page
⑥	 Hazard warning lamps	89
⑦	 PASSENGER AIR BAG OFF indicator lamp	35
⑧	 ESP®	57

Center console, lower section







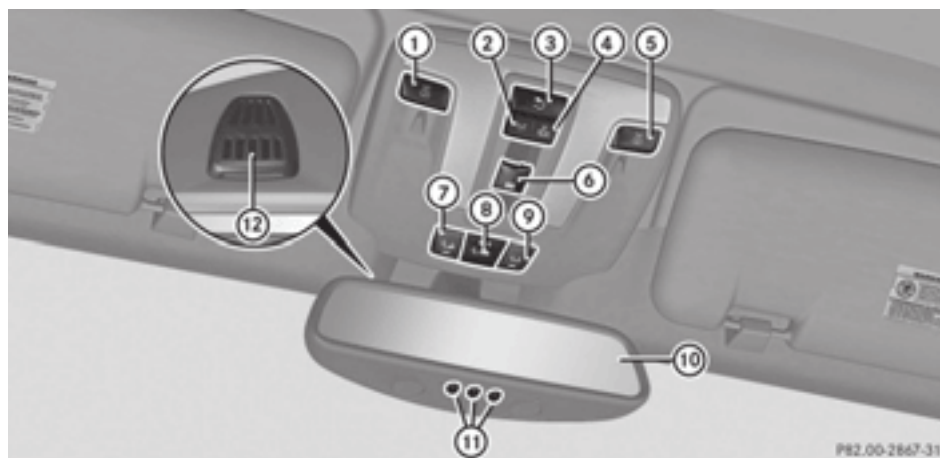



	Function	Page
⑨	Storage compartment/ashtray	221
⑩	Automatic transmission selector lever	119
⑪	Selects park position	119
⑫	 Selects/deselects LOW RANGE off-road gear	162
⑬	Storage compartment	
⑭	Opens/closes the storage compartment	215
⑮	Cigarette lighter	222
⑯	Audio controller (see the separate operating instructions) COMAND controller	
⑰	Switches the windshield heating on/off	106
⑱	Adjustable damping	118
⑲	 Selects the drive program  Selects the drive program (AMG vehicles)	122
⑳	Parking brake	131

Overhead control panel











P82.00-2867-31

	Function	Page		Function	Page
①	 Switches the left-hand reading lamp on/off	89	⑦	 Roadside Assistance call button (mbrace system)	226
②	 Switches the front interior lighting on	90	⑧	 SOS button (mbrace system)	225
③	 Switches the rear interior lighting on/off	90	⑨	 MB Info call button (mbrace system)	227
④	 Switches the front interior lighting/automatic interior lighting control off	90	⑩	Rear-view mirror	80
⑤	 Switches the right-hand reading lamp on/off	89	⑪	Buttons for the garage door opener	234
⑥	 Opens/closes the sliding sunroof	70	⑫	Microphone for mbrace (emergency call system), telephone and the Voice Control System	

Door control panel



	Function	Page		Function	Page
①	 Activates/deactivates the override feature for the side windows in the rear compartment	54	④	 Stores settings for the seat, exterior mirrors and steering wheel (memory function)	82
②	 Opens/closes the side windows	68	⑤	Adjusts the seats	74
③	    Adjusts and folds the exterior mirrors in/out electrically	80	⑥	  Unlocks/locks the vehicle	65
			⑦	Opens the door	64

Useful information

- i** This Operator's Manual describes all models and all standard and optional equipment of your vehicle available at the time of publication of the Operator's Manual. Country-specific differences are possible. Please note that your vehicle may not be equipped with all features described. This also applies to safety-related systems and functions.
- i** Read the information on qualified specialist workshops: (▷ page 23).

Panic alarm



- ▶ **To activate:** press **PANIC** button ① for at least one second.
An alarm sounds and the indicator lamp flashes.
 - ▶ **To deactivate:** press **PANIC** button ① again.
- or
- ▶ Insert the SmartKey into the ignition lock.

- i** USA only:
This device complies with part 15 of the FCC Rules. Operation is subject to the following two conditions:
 1. This device may not cause interference, and
 2. this device must accept any interference received, including interference that may cause undesired operation of the device.
 Any unauthorized modification to this device could void the user's authority to operate the equipment.
The Product label with FCC ID and IC certification number can be found in the battery case of the SmartKey.

- i** Canada only:
This device complies with the RSS-210 Rules of Industry Canada. Operation is subject to the following two conditions:
 1. This device may not cause interference, and
 2. this device must accept any interference received, including interference that may cause undesired operation.
 Any unauthorized modification to this device could void the user's authority to operate the equipment.
The Product label with FCC ID and IC certification number can be found in the battery case of the SmartKey.

Occupant safety

Introduction to the restraint system

The restraint system can reduce the risk of vehicle occupants coming into contact with parts of the vehicle's interior in the event of an accident. The restraint system can also reduce the forces to which vehicle occupants are subjected during an accident.

The restraint system comprises:

- Seat belt system
- Air bags
- Child restraint system
- Child seat securing systems

The components of the restraint system work in conjunction with each other. They can only deploy their protective function if, at all times, all vehicle occupants:

- have fastened their seat belts correctly (▷ page 37)
- have adjusted their seat and head restraint properly (▷ page 72).

As the driver, you also have to make sure that the steering wheel is adjusted correctly. Observe the information relating to the correct driver's seat position (▷ page 72).

You also have to make sure that an air bag can inflate properly if deployed (▷ page 40).

An air bag supplements a correctly worn seat belt. As an additional safety device, the air bag increases the level of protection for vehicle occupants in the event of an accident. For example, if, in the event of an accident, the protection offered by the seat belt is sufficient, the air bags

are not deployed. When an accident occurs, only the air bags that increase protection in that particular accident situation are deployed. However, seat belts and air bags generally do not protect against objects penetrating the vehicle from the outside.

Information on restraint system operation can be found under "Triggering of the Emergency Tensioning Devices and air bags" (▷ page 43). For more information about children traveling with you in the vehicle and on child restraint systems, see "Children in the vehicle" (▷ page 46).

Important safety notes

WARNING

Modifications to the restraint system may cause it to no longer work as intended. The restraint system may then not perform its intended protective function and may fail in an accident or trigger unexpectedly, for example. This poses an increased risk of injury or even fatal injury.

Never modify parts of the restraint system. Never tamper with the wiring, the electronic components or their software.

If it is necessary to modify an air bag system to accommodate a person with disabilities, contact an authorized Mercedes-Benz Center for details. USA only: for further information contact our Customer Assistance Center at 1-800-FOR-MERCEDES (1-800-367-6372).

Restraint system warning lamp

The functions of the restraint system are checked after the ignition is switched on and at regular intervals while the engine is running. Therefore, malfunctions can be detected in good time.

The  restraint system warning lamp in the instrument cluster lights up when the ignition is switched on. It goes out no later than a few seconds after the vehicle is started. The components of the restraint system are in operational readiness.

A malfunction has occurred if the  restraint system warning lamp:

- does not light up after the ignition is switched on
- does not go out after a few seconds with the engine running
- lights up again while the engine is running

WARNING

If restraint system is malfunctioning, restraint system components may be triggered unintentionally or might not be triggered at all in the event of an accident with a high rate of vehicle deceleration. This can affect the Emergency Tensioning Device or air bag, for example. This poses an increased risk of injury or even fatal injury.

Have the restraint system checked and repaired in a qualified specialist workshop as soon as possible.

PASSENGER AIR BAG OFF indicator lamp



PASSENGER AIR BAG OFF indicator lamp  is part of the BabySmart™ air bag deactivation system.

A permanently lit PASSENGER AIR BAG OFF indicator lamp informs you that the front-passenger front air bag is deactivated.

Depending on the person in the front-passenger seat, the front-passenger front air bag must either be deactivated or enabled; see the following points. You must make sure of this both before and during a journey.

- **Children in a child restraint system:** whether the front-passenger front air bag is deactivated or enabled depends on the instal-

led child restraint system, and the age and size of the child. Therefore, always observe the information on "Children in the vehicle" (> page 46). There you will also find instructions on rearward and forward-facing child restraint systems on the front-passenger seat.

- **All other persons:** the PASSENGER AIR BAG OFF indicator lamp must be off. Be sure to observe the notes on "Seat belts" (> page 36) and "Air bags" (> page 40). There you can also find information on the correct seat position.

Observe the information on the BabySmart™ air bag deactivation system in the front-passenger seat (> page 50).

Seat belts

Introduction

Seat belts are the most effective means of restricting the movement of vehicle occupants in the event of an accident or the vehicle rolling over. This reduces the risk of vehicle occupants coming into contact with parts of the vehicle interior or being ejected from the vehicle. Furthermore, the seat belt helps to keep the vehicle occupant in the best position in relation to the air bag.

The seat belt system comprises:

- Seat belts
- Emergency Tensioning Devices for the front seat belts and the outer seat belts in the rear
- Belt force limiters

If the seat belt is pulled out at the belt sash guide quickly or with a jerky movement, the belt retractor locks. The belt strap cannot be extracted any further.

The Emergency Tensioning Device tightens the seat belt in an accident, pulling the belt close against the body. However it does not pull the vehicle occupant back in the direction of the backrest.

The Emergency Tensioning Device does not correct an incorrect seat position or the routing of an incorrectly fastened seat belt.

When triggered, a belt force limiter helps to reduce the force exerted by the seat belt on the vehicle occupant.

The belt force limiters for the front seats are synchronized with the front air bags, which

absorb part of the deceleration force. This can reduce the force exerted on the vehicle occupants during an accident.

- ❗ If the front-passenger seat is unoccupied, do not insert the belt tongue into the buckle of the front-passenger seat. This may otherwise lead to the triggering of the Emergency Tensioning Device in the event of an accident, which will then need to be replaced.

Important safety notes

The use of seat belts and child restraint systems is required by law in:

- all 50 states
- the U.S. territories
- the District of Columbia
- all Canadian provinces

Even where this is not required by law, all vehicle occupants should correctly fasten their seat belts before starting the journey.

WARNING

If the seat belt is incorrectly fastened, it cannot protect as intended. Furthermore, an incorrectly fastened seat belt can cause additional injury, for example, in an accident, during braking or when abruptly changing direction. This poses an increased risk of injury or even fatal injury.

Make sure that all vehicle occupants are seated properly with a correctly fastened seat belt.

WARNING

The seat belt does not offer the intended level of protection if you have not moved the backrest to an almost vertical position. When braking or in the event of an accident, you could slide underneath the seat belt and sustain abdomen or neck injuries, for example. This poses an increased risk of injury or even fatal injury.

Adjust the seat properly before beginning your journey. Always ensure that the backrest is in an almost vertical position and that the shoulder section of your seat belt is routed across the center of your shoulder.

⚠ WARNING

Persons under 5 ft (1.50 m) in height cannot fasten the seat belt correctly without an additional suitable restraint system. If the seat belt is incorrectly fastened, it cannot protect as intended. Furthermore, an incorrectly fastened seat belt can cause additional injury, for example, in an accident, during braking or an abrupt change of direction. This poses an increased risk of injury or even fatal injury.

For this reason, always secure persons under 5 ft (1.50 m) in height in suitable restraint systems.

If a child younger than twelve years old and under 5 ft (1.50 m) in height is traveling in the vehicle:

- always secure the child in a child restraint system suitable for this Mercedes-Benz vehicle. The child restraint system must be appropriate to the age, weight and size of the child
- always observe the instructions and safety notes in the "Children in the vehicle" section of this Operator's Manual (▷ page 46) in addition to the child restraint system manufacturer's installation instructions

⚠ WARNING

The seat belts may not perform their intended protective function if:

- they are damaged, modified, extremely dirty, bleach or dyed
- the seat belt buckle is damaged or extremely dirty
- the Emergency Tensioning Devices, belt anchorages or inertia reels have been modified

Seat belts may sustain non-visible damage in an accident, e.g. due to glass splinters. Modified or damaged seat belts may tear or fail, e.g. in an accident. Modified Emergency Tensioning Devices could accidentally trigger or fail to deploy when necessary. This poses an increased risk of injury or even fatal injury.

Never modify the seat belts, Emergency Tensioning Devices, belt anchorages or inertia reels. Make sure that the seat belts are

undamaged, not worn out and clean. Following an accident, have the seat belts checked immediately at a qualified specialist workshop.

Only use seat belts that have been approved for your vehicle by Mercedes-Benz.

Proper use of the seat belts

Observe the safety notes on the seat belt (▷ page 36).

All vehicle occupants must be wearing the seat belt correctly before beginning the journey. Also make sure that all vehicle occupants are always wearing the seat belt correctly while the vehicle is in motion.

When fastening the seat belt, always make sure that:

- the seat belt tongue is only inserted to the belt buckle belonging to that seat.
- the seat belt is tight across your body. Avoid wearing bulky clothing, e.g. a winter coat.
- the seat belt is not twisted. Only then can the forces which occur be distributed over the area of the belt.
- the shoulder section of the belt is always routed across the center of your shoulder. The shoulder section of the belt must not come into contact with your neck or be routed under your arm. Where possible, adjust the seat belt to the appropriate height.
- the lap belt passes tightly and as low down as possible across your lap. The lap belt must always be routed across your hip joints and not across your abdomen. This applies particularly to pregnant women. If necessary, push the lap belt down to your hip joint and pull it tight using the shoulder section of the belt.
- the seat belt is not routed across sharp, pointed or fragile objects. If you have such items located on or in your clothing, e.g. pens, keys or eyeglasses, store these in a suitable place.
- only one person is using a seat belt at a time. Infants and children must never travel sitting on the lap of a vehicle occupant. In the event

of an accident, they could be crushed between the vehicle occupant and seat belt.

- objects are never secured with a seat belt if the seat belt is also being used by one of the vehicle's occupants.

Seat belts are only intended to secure and restrain vehicle occupants. Always observe the "Loading guidelines" for securing objects, luggage or loads (▷ page 214).

Fastening and adjusting the seat belts

Observe the safety notes on the seat belt (▷ page 36) and the notes on correct use of seat belts (▷ page 37).

If the center rear seat belt is being used, also observe the information about the seat belt for the center rear seat (▷ page 38).



Basic illustration

- ▶ Adjust the seat (▷ page 72).
The seat backrest must be in an almost vertical position.
- ▶ Pull the seat belt smoothly out of belt sash guide ③ and engage belt tongue ② into belt buckle ①.
- ▶ If necessary, pull upwards on the shoulder section of the seat belt to tighten the belt across your body.

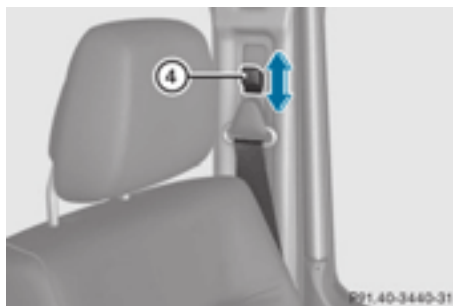

The shoulder section of the seat belt must always be routed across the center of the shoulder. Adjust the belt sash guide if necessary.

- ▶ **To raise:** slide the belt sash guide upwards.
The belt sash guide engages in various positions.
- ▶ **To lower:** pull release button ④ and slide the belt sash guide downwards.
- ▶ Let go of release button ④ in the desired position and make sure that the belt sash guide engages.

All seat belts except the driver's seat belt are equipped with a special seat belt retractor to securely fasten child restraint systems in the vehicle. Further information can be found under "Special seat belt retractor" (▷ page 47).

Seat belt for the center rear seat

WARNING

When the three-point seat belt for the center rear seat is not in use, it may be thrown around while driving, e.g. when braking or in an accident. There is a risk of injury.

When the three-point seat belt for the center rear seat is not in use, always secure both belt buckle tongues in the retainer.



- ① Bracket for seat belt tongues
- ② Belt buckle for fixed belt tongue
- ③ Release button for fixed belt tongue
- ④ Fixed belt tongue
- ⑤ Belt buckle for movable belt tongue
- ⑥ Release button for movable belt tongue
- ⑦ Movable belt tongue



- ▶ Pull both seat belt tongues ④ and ⑦ from bracket ①.



- ▶ Pull the seat belt smoothly from the belt outlet and engage fixed belt tongue ④ in belt buckle ②.



- ▶ **To fasten the seat belt:** pull the seat belt smoothly from the belt outlet and engage movable belt tongue ⑦ in belt buckle ⑤.
- ▶ If necessary, pull upwards on the shoulder section of the seat belt to tighten the belt across your body.

Releasing seat belts

- ❗ Make sure that the seat belt is fully rolled up. Otherwise, the seat belt or belt tongue will be trapped in the door or in the seat mechanism. This could damage the door, the door trim panel and the seat belt. Damaged seat belts

can no longer fulfill their protective function and must be replaced. Visit a qualified specialist workshop.





Basic illustration

- ▶ Press release button ①, hold belt tongue ② firmly and guide it back towards belt sash guide ③.

Belt warning for the driver and front passenger

The  seat belt warning lamp in the instrument cluster is a reminder that all vehicle occupants must wear their seat belts. It may light up continuously or flash. In addition, there may be a warning tone.

Regardless of whether the driver's seat belt has already been fastened, the  seat belt warning lamp lights up for six seconds each time the engine is started. If, after six seconds, the driver or front-passenger seat belt has not been fastened and the doors are closed, the  seat belt warning lamp lights up. As soon as the driver's and front-passenger seat belts are fastened or a front door is opened again, the  seat belt warning lamp goes out.

If the driver's seat belt is not fastened after the engine is started, an additional warning tone will sound. This warning tone stops after six seconds or when the driver's seat belt is fastened.

If the vehicle's speed exceeds 15 mph (25 km/h) once and the driver's and front-passenger seat belts are not fastened, a warning tone sounds. A warning tone also sounds with increasing intensity for 60 seconds or until the

driver or front passenger have fastened their seat belts.

If the driver or front passenger unfasten their seat belts during the journey, the seat belt warning is activated again.

- ① For more information on the  seat belt warning lamp, see "Warning and indicator lamps in the instrument cluster, seat belts" (> page 204).

Air bags

Introduction

The installation point of an air bag can be recognized by the AIR BAG symbol.

An air bag complements the correctly fastened seat belt. It is no substitute for the seat belt. The air bag provides additional protection in applicable accident situations.

Not all air bags are deployed in an accident. The different air bag systems function independently from one another (> page 43).

However, no system available today can completely eliminate injuries and fatalities.

It is also not possible to rule out a risk of injury caused by an air bag due to the high speed at which the air bag must be deployed.

Important safety notes

WARNING

If you do not sit in the correct seat position, the air bag cannot protect as intended and could even cause additional injury when deployed. This poses an increased risk of injury or even fatal injury.

To avoid hazardous situations, always make sure that all of the vehicle's occupants:

- have fastened their seat belts correctly, including pregnant women
- are sitting correctly and maintain the greatest possible distance to the air bags
- follow the following instructions

Always make sure that there are no objects between the air bag and the vehicle's occupants.

- Adjust the seats properly before beginning your journey. Always make sure that the seat is in an almost upright position. The center of the head restraint must support the head at about eye level.
- Move the driver's and front-passenger seats as far back as possible. The driver's seat position must allow the vehicle to be driven safely.
- Only hold the steering wheel on the outside. This allows the air bag to be fully deployed.
- Always lean against the backrest while driving. Do not lean forwards or lean against the door or side window. You may otherwise be in the deployment area of the air bags.
- Always keep your feet in the footwell in front of the seat. Do not put your feet on the dashboard, for example. Your feet may otherwise be in the deployment area of the air bag.
- For this reason, always secure persons less than 5 ft (1.50 m) tall in suitable restraint systems. Up to this height, the seat belt cannot be worn correctly.

If a child is traveling in your vehicle, also observe the following notes:

- Always secure children under twelve years of age and less than 5 ft (1.50 m) tall in suitable child restraint systems.
- Child restraint systems should be installed on the rear seats.
- Only secure a child in a rearward-facing child restraint system on the front-passenger seat when the front-passenger front air bag is deactivated. If the PASSENGER AIR BAG OFF indicator lamp is permanently lit, the front-passenger front air bag is deactivated (▷ page 35).
- Always observe the instructions and safety notes on "Children in the vehicle" (▷ page 46) and on the "Child restraint system on the front-passenger seat" (▷ page 51) in addition to the child restraint system manufacturer's installation instructions.

Objects in the vehicle interior may prevent an air bag from functioning correctly. Before starting your journey and to avoid risks resulting from the speed of the air bag as it deploys, make sure that:

- there are no people, animals or objects between the vehicle occupants and an air bag.
- there are no objects between the seat, door and B-pillar.
- no hard objects, e.g. coat hangers, hang on the grab handles or coat hooks.
- no accessories, such as cup holders, are attached to the vehicle within the deployment area of an air bag, e.g. to doors, side windows, rear side trim or side walls.
- no heavy, sharp-edged or fragile objects are in the pockets of your clothing. Store such objects in a suitable place.

 **WARNING**

If you modify the air bag cover or affix objects such as stickers to it, the air bag can no longer function correctly. There is an increased risk of injury.

Never modify an air bag cover or affix objects to it.

 **WARNING**

Sensors to control the air bags are located in the doors. Modifications or work not performed correctly to the doors or door paneling, as well as damaged doors, can lead to the function of the sensors being impaired. The air bags might therefore not function properly anymore. Consequently, the air bags cannot protect vehicle occupants as they are designed to do. There is an increased risk of injury.

Never modify the doors or parts of the doors. Always have work on the doors or door paneling carried out at a qualified specialist workshop.

Front air bags

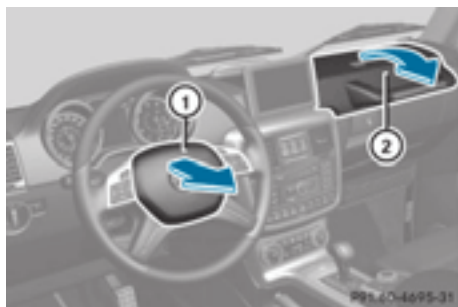

Driver's air bag ① deploys in front of the steering wheel. Front-passenger front air bag ② deploys in front of and above the glove box. When deployed, the front air bags offer additional head and thorax protection for the occupants in the front seats.

A permanently lit PASSENGER AIR BAG OFF indicator lamp informs you that the front-passenger front air bag is deactivated (▷ page 35).

The front-passenger front air bag will only deploy if:

- an occupant is detected on the front-passenger seat
- the PASSENGER AIR BAG OFF indicator lamp is not lit (▷ page 50)
- the restraint system control unit predicts a high accident severity

Side impact air bags

WARNING

Unsuitable seat covers could restrict or even prevent the deployment of the air bags integrated into the seats. Consequently, the air bags cannot protect vehicle occupants as they are designed to do. In addition, the functions of BabySmart™ may be impaired. This poses an increased risk of injury or even fatal injury.

You should only use seat covers that have been approved for the respective seat by Mercedes-Benz.



Side impact air bags ① deploy next to the outer bolster of the seat backrest.

When deployed, the side impact air bag offers additional thorax protection. However, it does not protect the:

- head
- neck
- arms

In the event of a side impact, the side impact air bag is deployed on the side on which the impact occurs.

Pelvis air bags

WARNING

Unsuitable seat covers could restrict or even prevent the deployment of the air bags integrated into the seats. Consequently, the air bags cannot protect vehicle occupants as they are designed to do. In addition, the functions of BabySmart™ may be impaired. This poses an increased risk of injury or even fatal injury.

You should only use seat covers that have been approved for the respective seat by Mercedes-Benz.



Pelvis air bags ① deploy below next to the outer seat cushions.

When activated, the pelvis air bag enhances the level of protection of the vehicle occupants on the side of the vehicle on which the impact occurs.

The pelvis air bag is deployed on the side of the impact.

Window curtain air bags



Window curtain air bags ① are integrated into the side of the roof frame and deployed in the area from the A-pillar to the C-pillar.

When deployed, the window curtain air bag enhances the level of protection for the head. However, it does not protect the chest or arms.

In the event of a side impact, the window curtain air bag is deployed on the side on which the impact occurs.

If the system determines that they can offer additional protection to that provided by the seat belt, a window curtain air bag may be deployed in other accident situations (▷ page 43).

Deployment of Emergency Tensioning Devices and air bags

Important safety notes

WARNING

The air bag parts are hot after an air bag has been deployed. There is a risk of injury.

Do not touch the air bag parts. Have a deployed air bag replaced at a qualified specialist workshop as soon as possible.

WARNING

A deployed air bag no longer offers any protection and cannot provide the intended protection in an accident. There is an increased risk of injury.

Have the vehicle towed to a qualified specialist workshop in order to have a deployed air bag replaced.

It is important for your safety and that of your passenger to have deployed air bags replaced and to have any malfunctioning air bags repaired. This will help to make sure the air bags continue to perform their protective function for the vehicle occupants in the event of a crash.

WARNING

Pyrotechnic Emergency Tensioning Devices that have been deployed are no longer operational and are unable to perform their intended protective function. This poses an increased risk of injury or even fatal injury.

Therefore, have pyrotechnic Emergency Tensioning Devices which have been triggered immediately replaced at a qualified specialist workshop.

If Emergency Tensioning Devices are triggered or air bags are deployed, you will hear a bang, and a small amount of powder may also be released. The  restraint system warning lamp lights up.

Only in rare cases will the bang affect your hearing. The powder that is released generally does not constitute a health hazard, but it may cause short-term breathing difficulties in people with asthma or other respiratory problems. To avoid this, you may wish to get out of the vehicle or open the windows as soon as it is safe to do so. Air bags and pyrotechnic Emergency Tensioning Devices (ETDs) contain perchlorate material, which may require special handling and regard for the environment. National guidelines must be observed during disposal. In California, see www.dtsc.ca.gov/HazardousWaste/Perchlorate/index.cfm.

Method of operation

During the first stage of a collision, the restraint system control unit evaluates important physical data relating to vehicle deceleration or acceleration, such as:

- duration
- direction
- intensity

Based on the evaluation of this data, the restraint system control unit triggers the Emergency Tensioning Devices during a frontal or rear collision.

An Emergency Tensioning Device can only be triggered, if:

- the ignition is switched on
- the components of the restraint system are operational; see "Restraint system warning lamp" (> page 35)
- the belt tongue is engaged in the buckle on the respective front-passenger seat

The Emergency Tensioning Devices in the rear compartment are triggered independently of the lock status of the seat belts.

If the restraint system control unit detects a more severe accident, further components of the restraint system are activated independently of each other in certain frontal collision situations:

- Driver's air bag
- Front-passenger front air bag

The front-passenger front air bag is activated or deactivated depending on the person on the front-passenger seat. The front-passenger front air bag can only deploy in an accident if the PASSENGER AIR BAG OFF indicator lamp is off. Observe the information on the PASSENGER AIR BAG OFF indicator lamp (> page 35).

Your vehicle has a two-stage driver's air bag. During the first deployment stage the driver's air bag fills with sufficient propellant gas to reduce the risk of injuries. The front air bag is fully deployed with the maximum amount of propellant gas if a second deployment threshold is reached within a few milliseconds.

The activation threshold of the Emergency Tensioning Devices and the air bag are determined by evaluating the rate of vehicle deceleration or acceleration which occurs at various points in the vehicle. This process is pre-emptive in nature. Deployment should take place in good time at the start of the collision.

The rate of vehicle deceleration or acceleration and the direction of the force are essentially determined by:

- the distribution of forces during the collision
- the collision angle
- the deformation characteristics of the vehicle
- the characteristics of the object with which the vehicle has collided

Factors which can only be seen and measured after a collision has occurred do not play a decisive role in the deployment of an air bag. Nor do they provide an indication of air bag deployment.

The vehicle can be deformed considerably, without an air bag being deployed. This is the case if only parts which are relatively easily deformed are affected and the rate of deceleration is not high. Conversely, air bags may be deployed even though the vehicle suffers only minor deformation. This is the case if, for example, very rigid vehicle parts such as longitudinal body members are hit, and sufficient deceleration occurs as a result.

If the restraint system control unit detects a side impact or if the vehicle rolls over, the applicable components of the restraint system are activated independently of each other depending on the apparent type of accident.

- Side impact air bag and pelvis air bag on the side of impact, independently of the Emergency Tensioning Device and the use of the seat belt

The side impact air bag on the front-passenger side deploys under the following conditions:

- BabySmart™ detects that the front-passenger seat is occupied or
- the belt tongue is engaged in the belt buckle of the front-passenger seat
- Window curtain air bag on the side of impact, independently of the use of the seat belt and independently of whether the front-passenger seat is occupied
- Emergency Tensioning Devices, if the system determines that deployment can offer additional protection in this situation
- Window curtain air bags on the driver's and front-passenger side in certain situations when the vehicle rolls over, if the system determines that deployment can offer additional protection to that provided by the seat belt

i Not all air bags are deployed in an accident. The different air bag systems work independently of each other.

How the air bag system works is determined by the severity of the accident detected, especially the vehicle deceleration or acceleration and the apparent type of accident:

- frontal collision
- side impact
- rollover

NECK-PRO head restraints/NECK-PRO luxury head restraints

Important safety notes

⚠ WARNING

The function of the head restraint may be impaired if you:

- attach objects such as coat hangers to the head restraints, for example
- use head restraint covers

If you do so, the head restraints cannot fulfill their intended protective function in the event of an accident. In addition, objects attached to the head restraints could endanger other vehicle occupants. There is an increased risk of injury.

Do not attach any objects to the head restraints and do not use head restraint covers.

Method of operation

NECK-PRO head restraints/NECK-PRO luxury head restraints offer additional protection against head and neck injuries. In the event of a rear collision of a certain severity, the NECK-PRO head restraints/NECK-PRO luxury head restraints on the driver's and front-passenger seats are moved forwards and upwards. This provides better head support.

If the NECK-PRO head restraints/NECK-PRO luxury head restraints have been triggered in an accident, reset the NECK-PRO head restraints/NECK-PRO luxury head restraints on the driver's seat and the front-passenger seat (▷ page 45). Otherwise, the additional protection will not be available in the event of another

rear-end collision. You can see that a NECK-PRO head restraint/NECK-PRO luxury head restraint has been triggered if it is tilted forward and can no longer be adjusted.

Mercedes-Benz recommends that you have the functionality of the NECK-PRO head restraints/NECK-PRO luxury head restraints checked at a qualified specialist workshop after a rear-end collision.

Resetting a triggered NECK-PRO head restraint/NECK-PRO luxury head restraint

NECK-PRO head restraints



Do not insert your finger between the cushion of the head restraint and the cover. Pay particular attention while resetting the NECK-PRO head restraints.

- ▶ Tilt the top of the NECK-PRO head restraint cushion forwards in the direction of arrow ①.
- ▶ Push the NECK-PRO head restraint cushion down as far as it will go in the direction of arrow ②.
- ▶ With your hand flat, firmly push the NECK-PRO head restraint cushion backwards in the direction of arrow ③ until it engages.
- ▶ Repeat this procedure for the second NECK-PRO head restraint.

i Resetting the NECK-PRO head restraints requires a lot of strength. If you have difficulty resetting the NECK-PRO head restraints, have this work carried out at a qualified specialist workshop.

NECK-PRO luxury head restraints

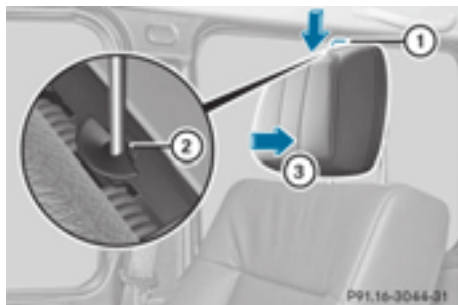

Do not insert your finger between the cushion of the head restraint and the cover. Pay particular attention while resetting the NECK-PRO luxury head restraints.

- ▶ Remove resetting tool ① from the vehicle document wallet.
- ▶ Slide resetting tool ① into guide ② between the NECK-PRO luxury head restraint and the rear cover of the head restraint.
- ▶ Push resetting tool ① downwards until you hear the head restraint deployment mechanism engage.
- ▶ Pull out resetting tool ①.
- ▶ With your hand flat, firmly push the NECK-PRO luxury head restraint cushion backwards in the direction of arrow ③ until it engages.
- ▶ Repeat this procedure for the second NECK-PRO luxury head restraint.
- ▶ Put resetting tool ① back into the vehicle document wallet.

i If you have difficulty resetting the NECK-PRO luxury head restraints, have this work carried out at a qualified specialist workshop.

Automatic measures after an accident

Immediately after an accident, the following measures are implemented, depending on the type and severity of the impact:

- the hazard warning lamps are activated
- the emergency lighting is activated
- the vehicle doors are unlocked
- the front side windows are lowered
- the electrically adjustable steering wheel is raised

- the engine is switched off and the fuel supply is cut off
- vehicles with mbrace: automatic emergency call

Children in the vehicle

Important safety notes

Accident statistics show that children secured in the rear seats are safer than children secured in the front seats. For this reason, Mercedes-Benz strongly advises that you install a child restraint system on a rear seat. Children are generally better protected there.

If a child younger than twelve years and under 5 ft (1.50 m) in height is traveling in the vehicle:

- always secure this child in a restraint system approved for Mercedes-Benz vehicles. The child restraint system must be appropriate to the age, weight and size of the child.
- be sure to observe the instructions and safety notes in this section in addition to the child restraint system manufacturer's installation instructions.

⚠ WARNING

If you leave children unsupervised in the vehicle, they could set it in motion by, for example:

- release the parking brake.
- shift the automatic transmission out of the parking position **P**.
- start the engine.

In addition, they may operate vehicle equipment and become trapped. There is a risk of an accident and injury.

When leaving the vehicle, always take the SmartKey with you and lock the vehicle. Never leave children unsupervised in the vehicle.

⚠ WARNING

If persons, particularly children are subjected to prolonged exposure to extreme heat or cold, there is a risk of injury, possibly even fatal. Never leave children unattended in the vehicle.

⚠ WARNING

If the child restraint system is subjected to direct sunlight, parts may get very hot. Children may burn themselves on these parts, particularly on the metal parts of the child restraint system. There is a risk of injury.

If you leave the vehicle, taking the child with you, always ensure that the child restraint system is not exposed to direct sunlight. Protect it with a blanket, for example. If the child restraint system has been exposed to direct sunlight, let it cool down before securing the child in it. Never leave children unattended in the vehicle.

Always make sure that all vehicle occupants are positioned properly in their seats and have correctly fastened their seat belts. Take particular care with children.

Please take note of the safety notes on seat belts (▷ page 36) and the notes on their correct use (▷ page 37).

A booster seat may be necessary to achieve proper seat belt positioning for children over 41 lbs (18 kg) until they reach a height where a lap/shoulder belt fits properly without a booster seat.

Special seat belt retractor**⚠ WARNING**

If the seat belt is released while driving, the child restraint system will no longer be secured properly. The special seat belt retractor is disabled and the inertia reel draws in a portion of the seat belt. The seat belt cannot be immediately refastened. There is an increased risk of injury, possibly even fatal.

Stop the vehicle immediately, paying attention to road and traffic conditions. Reactivate the special seat belt retractor and secure the child restraint system properly.

All seat belts in the vehicle, except the driver's seat belt, are equipped with a special seat belt retractor. When activated, the special seat belt retractor ensures that the seat belt cannot slacken once the child seat is secured.

Installing a child restraint system:

- ▶ Make sure you observe the child restraint system manufacturer's installation instructions.
- ▶ Pull the seat belt smoothly out of the belt sash guide.
- ▶ Engage seat belt tongue in belt buckle.

Activating the special seat belt retractor:

- ▶ Pull the seat belt out fully and let the inertia reel retract it again. While the seat belt is retracting, you should hear a ratcheting sound. The special seat belt retractor is enabled.
- ▶ Push the child restraint system down so that the seat belt is tight and does not loosen.

Removing the child restraint system and deactivating the special seat belt retractor:

- ▶ Make sure you observe the child restraint system manufacturer's installation instructions.
- ▶ Press the release button of the seat belt buckle and route the seat belt tongue back towards the belt sash guide. The special seat belt retractor is deactivated.

Child restraint system

The use of seat belts and infant and child restraint systems is required by law in:

- all 50 states
- the U.S. territories
- the District of Columbia
- all Canadian provinces

You can obtain further information about the correct child restraint system from any authorized Mercedes-Benz Center.

⚠ WARNING

If the child restraint system is installed incorrectly on a suitable seat, it cannot protect as intended. The child cannot then be restrained in the event of an accident, heavy braking or sudden changes of direction. There is an increased risk of injury, possibly even fatal.

Make sure that you observe the child restraint system manufacturer's installation instructions and the notes on use. Please ensure, that the base of the child restraint system is

always resting completely on the seat cushion. Never place objects, e.g. cushions, under or behind the child restraint system. Only use child restraint systems with the original cover designed for them. Only replace damaged covers with genuine covers.

WARNING

If the child restraint system is installed incorrectly or is not secured, it can come loose in the event of an accident, heavy braking or a sudden change in direction. The child restraint system could be thrown about, striking vehicle occupants. There is an increased risk of injury, possibly even fatal.

Always install child restraint systems properly, even if they are not being used. Make sure that you observe the child restraint system manufacturer's installation instructions.

You will find further information on stowing objects, luggage and loads securely under "Loading guidelines" (▷ page 214).

WARNING

Child restraint systems or their securing systems which have been damaged or subjected to a load in an accident can no longer protect as intended. The child cannot then be restrained in the event of an accident, heavy braking or sudden changes of direction. There is an increased risk of injury, possibly even fatal.

Replace child restraint systems which have been damaged or subjected to a load in an accident as soon as possible. Have the securing systems on the child restraint system checked at a qualified specialist workshop, before you install a child restraint system again.

Securing systems for child restraint systems include:

- the seat belt system
- the LATCH-type (ISOFIX) securing rings
- Top Tether anchorage points

 If it is absolutely necessary to carry a child on the front-passenger seat, be sure to

observe the instructions on "Child restraint systems on the front-passenger seat" (▷ page 51). This includes information on deactivating the front-passenger air bag.

All child restraint systems must meet the following standards:

- U.S. Federal Motor Vehicle Safety Standards 213 and 225
- Canadian Motor Vehicle Safety Standards 213 and 210.2

A statement by the child restraint manufacturer of compliance with these standards can be found on the instruction label on the child restraint system. You will also find the statement in the instruction manual provided with the child restraint system.

Observe the warning labels in the vehicle interior and on the child restraint system.

LATCH-type (ISOFIX) child seat securing system

WARNING

LATCH-type (ISOFIX) child restraint systems do not offer sufficient protective effect for children whose weight is greater than 48 lbs (22 kg) who are secured using the safety belt integrated in the child restraint system. In the event of an accident, a child might not be restrained correctly. This poses an increased risk of injury or even fatal injury.

If the child weighs more than 48 lbs (22 kg), only use LATCH-type (ISOFIX) child restraint systems with which the child is also secured with the vehicle seat belt. Also secure the child restraint system with the Top Tether belt, if available.

Always comply with the manufacturer's installation and operating instructions for the child restraint system used.

Before every trip, make sure that the LATCH-type (ISOFIX) child restraint system is engaged correctly in both LATCH-type (ISOFIX) securing rings

 When installing the child restraint system, make sure that the seat belt for the middle seat does not get trapped. The seat belt could otherwise be damaged.



① LATCH-type (ISOFIX) securing rings

- ▶ Install the LATCH-type (ISOFIX) child restraint system on both LATCH-type (ISOFIX) securing rings ①.

ISOFIX is a standardized securing system for specially designed child restraint systems on the rear seats. LATCH-type (ISOFIX) securing rings ① for two LATCH-type (ISOFIX) child restraint systems are installed on the left and right rear seats.

Non-LATCH-type (ISOFIX) child seats may also be used and can be installed using the vehicle's seat belt system. Install the child seat according to the manufacturer's instructions.

Top Tether

Introduction

Top Tether provides an additional connection between the child restraint system secured with a LATCH-type (ISOFIX) child seat mount and the vehicle. This helps reduce the risk of injury even further. If the child restraint system is equipped with a Top Tether belt, this should always be used.

Important safety notes

WARNING

If the rear seats or the rear seat backrests are not locked, they could fold forwards in the event of an accident, heavy braking or sudden changes of direction. As a result, child restraint systems cannot perform their intended protective function. Rear seats and rear seat backrests that are not locked can also cause additional injuries, e.g. in the event of

an accident. This poses an increased risk of injury or even fatal injury.

Always lock the rear seats and rear seat backrests after installing a Top Tether belt. Observe the lock verification indicator. Adjust the rear seat backrests so that they are in an upright position.

Top Tether anchorages

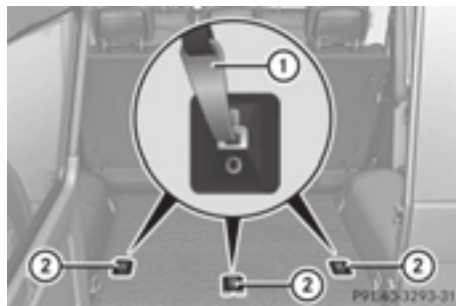

Top Tether anchorages ② are on the cargo compartment floor.

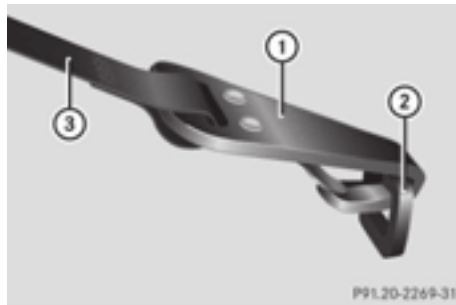

- ▶ Remove cargo compartment cover (> page 219).
- ▶ Move the head restraint upwards.
- ▶ Install the LATCH-type (ISOFIX) child restraint system with Top Tether. Always comply with the child restraint system manufacturer's installation instructions when doing so.
- ▶ Route Top Tether belt ③ under the head restraint between the two head restraint bars.
- ▶ Hook Top Tether hook ① of Top Tether belt ③ into Top Tether anchorage ②. Make sure that Top Tether belt ⑥ is not twisted.

- ▶ Tension Top Tether belt ③. Always comply with the child restraint system manufacturer's installation instructions when doing so.
- ▶ Move head restraint back down again slightly if necessary (▷ page 75). Make sure that you do not interfere with the correct routing of Top Tether belt ③.

BabySmart™ air bag deactivation system

The BabySmart™ air bag deactivation system's sensor system in the front-passenger seat detects whether a special Mercedes-Benz child restraint system with a transponder for the BabySmart™ air bag deactivation system has been installed. In this case, the PASSENGER AIR BAG OFF indicator lamp lights up and remains lit. The front-passenger front air bag is deactivated.

When the SmartKey is removed from the ignition lock or is in position **0**, the PASSENGER AIR BAG OFF indicator lamp is not lit.

- ❗ If the front-passenger front air bag is deactivated by the BabySmart™ air bag deactivation system, the following remain enabled on the front-passenger side:
 - the side impact air bag
 - the pelvis air bag
 - the window curtain air bag
 - the Emergency Tensioning Device

WARNING

If you secure a child in a child restraint system on the front-passenger seat and the PASSENGER AIR BAG OFF indicator lamp is off, the front-passenger front air bag can deploy in the event of an accident. The child could be struck by the air bag. This poses an increased risk of injury or even fatal injury.

Make sure that the front-passenger front air bag has been disabled. The PASSENGER AIR BAG OFF indicator lamp must be lit.

WARNING

If the PASSENGER AIR BAG OFF indicator lamp is lit, the front-passenger front air bag is deactivated. It will not be deployed in the event of an accident and cannot perform its

intended protective function. A person in the front-passenger seat could then, for example, come into contact with the vehicle's interior, especially if the person is sitting too close to the dashboard. This poses an increased risk of injury or even fatal injury.

In this case the front-passenger seat may not be used. You may only transport a child on the front-passenger seat if they are seated in a suitable rearward or forward-facing child restraint system. Always observe the child restraint system manufacturer's installation instructions.

WARNING

If you secure a child in a forward-facing child restraint system on the front-passenger seat and you position the front-passenger seat too close to the dashboard, in the event of an accident, the child could:

- come into contact with the vehicle's interior if the PASSENGER AIR BAG OFF indicator lamp is lit, for example
- be struck by the air bag if the PASSENGER AIR BAG OFF indicator lamp is off

This poses an increased risk of injury or even fatal injury.

Move the front-passenger seat as far back as possible. Always make sure that the shoulder belt strap is correctly routed from the vehicle belt sash guide to the shoulder belt guide on the child restraint system. The shoulder belt strap must be routed forwards and downwards from the belt sash guide. If necessary, adjust the belt sash guide and the front-passenger seat accordingly. Always observe the information about suitable positioning of the child restraint system in this Operator's Manual as well as the child restraint system manufacturer's installation instructions.



PASSENGER AIR BAG OFF indicator lamp ① shows you whether the front-passenger front air bag is deactivated.

- ▶ Turn the SmartKey to position **1** or **2** in the ignition lock.
The system carries out self-diagnostics.

The PASSENGER AIR BAG OFF indicator lamp must light up for approximately six seconds.

If, after the system self-test, the PASSENGER AIR BAG OFF indicator lamp:

- **is lit:** the front-passenger front air bag is deactivated. It will then not be deployed in the event of an accident.
- **is not lit,** the sensor system did not detect a child restraint system with transponder for the BabySmart™ air bag deactivation system. If, in the event of an accident, all deployment criteria are met, the front-passenger front air bag is deployed.

⚠ WARNING

Electronic devices on the front-passenger seat can affect the function of the BabySmart™ air bag deactivation system, for example:

- Laptop
- Mobile phone
- Transponder cards such as ski passes or access passes

The front-passenger air bag could deploy accidentally or not function as intended during an accident. This poses an increased risk of injury or even fatal injury.

Do not place any of the devices mentioned above or similar devices on the front-passenger seat. Be aware of the status of the

front-passenger front air bag both before and during the journey.

Child restraint system on the front-passenger seat

General notes

Accident statistics show that children secured in the rear seats are safer than children secured in the front-passenger seat. For this reason, Mercedes-Benz strongly advises that you install the child restraint system on a rear seat.

If it is absolutely necessary to install a child restraint system on the front-passenger seat, always observe the information on the "BabySmart™ air bag deactivation system" (> page 50).

You can thus avoid the risks that could arise as a result of:

- a child restraint system that is not detected by the BabySmart™ air bag deactivation system sensor system
- the unintentional deactivation of the front-passenger front air bag
- the unsuitable positioning of the child restraint system, e.g. too close to the dashboard

Rearward-facing child restraint system

If it is absolutely necessary to install a rearward-facing child restraint system on the front-passenger seat, always make sure that the front-passenger front air bag is deactivated. Only if the PASSENGER AIR BAG OFF indicator lamp is permanently lit (> page 35) is the front-passenger front air bag deactivated.

Always observe the child restraint system manufacturer's installation and operating instructions.

Forward-facing child restraint system



If it is absolutely necessary to install a forward-facing child restraint system on the front-passenger seat, always move the front-passenger seat as far back as possible. The entire base of the child restraint system must always rest on the seat cushion of the front-passenger seat. The backrest of the child restraint system must lie as flat as possible

against the backrest of the front-passenger seat. The child restraint system must not touch the roof or be subjected to a load by the head restraint. Adjust the angle of the seat backrest and the head restraint position accordingly.

Always make sure that the shoulder belt strap is correctly routed from the vehicle belt sash guide to the shoulder belt guide on the child restraint system. The shoulder belt strap must be routed forwards and downwards from the vehicle belt sash guide. If necessary, adjust the belt sash guide and the front-passenger seat accordingly.

Always observe the child restraint system manufacturer's installation and operating instructions.

Problems with the BabySmart™ air bag deactivation system

Problem	Possible causes/consequences and ► Solutions
<p>The PASSENGER AIR BAG OFF indicator lamp on the center console is lit.</p>	<p>A special Mercedes-Benz child restraint system with a transponder for the BabySmart™ air bag deactivation system has been installed on the front-passenger seat. The front-passenger air bag has therefore been deactivated as desired.</p> <p> WARNING</p> <p>There is no child restraint system installed on the front-passenger seat. The BabySmart™ air bag deactivation system is malfunctioning, for example due to electronic devices on the front-passenger seat. There is a risk of injury.</p> <p>► Remove electronic equipment from the front-passenger seat, for example:</p> <ul style="list-style-type: none"> • Laptop • Mobile phone • Card with a transponder, such as a ski pass or access pass <p>If the PASSENGER AIR BAG OFF indicator lamp remains lit, the front-passenger seat may not be used.</p> <p>► Visit a qualified specialist workshop.</p>
<p>The  restraint system warning lamp lights up and/or the PASSENGER AIR BAG OFF indicator lamp does not light up briefly when you switch the ignition on.</p>	<p> WARNING</p> <p>The BabySmart™ air bag deactivation system is malfunctioning. Do not install a child restraint system on the front-passenger seat. It is recommended that you install the child restraint system on a suitable rear seat.</p> <p>► Visit a qualified specialist workshop.</p> <p>► Please also refer to the notes about the restraint system warning lamp (▷ page 209).</p>

Child-proof locks

Important safety notes

WARNING

When children ride on the vehicle's rear seats, activate the override switch. Otherwise, the children could be injured, e.g. by trapping themselves in the rear side window.

⚠ WARNING

When leaving the vehicle, always remove the SmartKey from the ignition lock. Always take the SmartKey with you and lock the vehicle. Do not leave children unattended in the vehicle, even if they are secured in a child restraint system, or with access to an unlocked vehicle. A child's unsupervised access to a vehicle could result in an accident and/or serious personal injury. The children could:

- injure themselves on parts of the vehicle
- be seriously or fatally injured through excessive exposure to extreme heat or cold
- injure themselves or cause an accident with vehicle equipment that can be operated even if the SmartKey is removed from the ignition lock or removed from the vehicle, such as seat adjustment, steering wheel adjustment, or the memory function

If children open a door, they could injure other persons or get out of the vehicle and injure themselves or be injured by following traffic. Do not expose the child restraint system to direct sunlight. The child restraint system's metal parts, for example, could become very hot, and the child could be burned on these parts.

Child-proof locks for the rear doors**⚠ WARNING**

Children could open a rear door from inside the vehicle. This could result in serious injuries or an accident. Therefore, when children ride in the rear always secure the rear doors with the child-proof locks.

You secure each door individually with the child-proof locks on the rear doors. A door secured with a child-proof lock cannot be opened from inside the vehicle. When the vehicle is unlocked, the door can be opened from the outside.



- ▶ **To activate:** press the child-proof lock lever down in the direction of arrow ②.
- ▶ Make sure that the child-proof locks are working properly.
- ▶ **To deactivate:** press the child-proof lock lever up in the direction of arrow ①.

Override feature for the rear side windows**⚠ WARNING**

When children ride on the vehicle's rear seats, activate the override switch. Otherwise, the children could be injured, e.g. by trapping themselves in the rear side window.

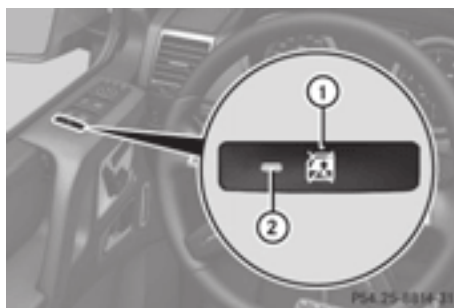

- ▶ **To activate/deactivate:** press button ①. If indicator lamp ② is lit, operation of the rear side windows is disabled. Operation is only possible using the switches in the driver's door. If indicator lamp ② is off, operation is possible using the switches in the rear compartment.

Pets in the vehicle

WARNING

If you leave animals unattended or unsecured in the vehicle, they could press buttons or switches, for example.

As a result, they could:

- activate vehicle equipment and become trapped, for example
- activate or deactivate systems, thereby endangering other road users

Unsecured animals could also be flung around the vehicle in the event of an accident or sudden steering or braking, thereby injuring vehicle occupants. There is a risk of an accident and injury.

Never leave animals unattended in the vehicle. Always secure animals properly during the journey, e.g. use a suitable animal transport box.

Driving safety systems

Overview of driving safety systems

In this section, you will find information about the following driving safety systems:

- **ABS (Anti-lock Braking System)** (▷ page 55)
- **BAS (Brake Assist System)** (▷ page 56)
- Adaptive brake lights (▷ page 56)
- **ESP® (Electronic Stability Program)** (▷ page 57)
- **EBD (Electronic Brake force Distribution)** (▷ page 58)
- **ADAPTIVE BRAKE** (▷ page 59)
- Trailer stabilization

Important safety notes

WARNING

The ABS, the BAS, and the ESP® switch off when the differential locks are switched on. When the ABS, the BAS, and the ESP® are switched off

- wheels may lock during hard braking
- steering capabilities are reduced
- braking distance is increased
- vehicle stability in standard driving maneuvers is increased

Make sure the differential locks are switched on at all times except when driving off-road for example. Switch on the differential locks immediately when returning from off-road driving.

If you fail to adapt your driving style or if you are inattentive, the driving safety systems can neither reduce the risk of an accident nor override the laws of physics. Driving safety systems are merely aids designed to assist driving. You are responsible for the distance to the vehicle in front, for vehicle speed and for braking in good time. Always adapt your driving style to suit the prevailing road and weather conditions and maintain a safe distance from the vehicle in front. Drive carefully.

- i** Please note that the driving safety systems described only work as effectively as possible if there is adequate contact between the tires and the road surface. Pay particular attention to the information regarding tires, recommended minimum tire tread depths etc. in the "Wheels and tires" section (▷ page 262).

In wintry driving conditions, always use winter tires (M+S tires) and if necessary, snow chains. Only in this way will the driving safety systems described in this section work as effectively as possible.

ABS (Anti-lock Braking System)

Important safety notes

- i** Observe the "Important safety notes" section (▷ page 55).

 **WARNING**

If the ABS malfunctions, other driving systems such as the BAS or the ESP® are also switched off. Observe indicator and warning lamps that may come on as well as messages in the multifunction display that may appear.

If the ABS malfunctions, the wheels may lock during hard braking, reducing the steering capability and extending the braking distance.

 **WARNING**

If ABS is faulty, the wheels could lock when braking. The steerability and braking characteristics may be severely impaired. Additionally, further driving safety systems are deactivated. There is an increased danger of skidding and accidents.

Drive on carefully. Have ABS checked immediately at a qualified specialist workshop.

ABS regulates brake pressure in such a way that the wheels do not lock when you brake. This allows you to continue steering the vehicle when braking.

Provided that the differential locks are not active, ABS works from a speed of approximately 5 mph (8 km/h) upwards, regardless of road-surface conditions. ABS works on slippery surfaces, even if you only brake gently.

The yellow  ABS warning lamp in the instrument cluster lights up when the ignition is switched on. It goes out when the engine is running.

Braking

If ABS intervenes when braking, you will feel a pulsing in the brake pedal.

- ▶ **If ABS intervenes:** continue to depress the brake pedal vigorously until the braking situation is over.
- ▶ **To make a full brake application:** depress the brake pedal with full force.

The pulsating brake pedal can be an indication of hazardous road conditions, and functions as a reminder to take extra care while driving.

Off-road ABS

An ESP® system specifically suited to off-road terrain is activated automatically once the off-road program is activated.

At speeds below 37 mph (60 km/h), the front wheels lock cyclically during braking. The digging-in effect achieved in the process reduces the stopping distance on off-road terrain. This limits steering capability.

BAS (Brake Assist System)

-  Observe the "Important safety notes" section (▷ page 55).

 **WARNING**

If BAS is malfunctioning, the braking distance in an emergency braking situation is increased. There is a risk of an accident.

In an emergency braking situation, depress the brake pedal with full force. ABS prevents the wheels from locking.

BAS operates in emergency braking situations. If you depress the brake pedal quickly, BAS automatically boosts the braking force, thus shortening the stopping distance.

- ▶ Keep the brake pedal firmly depressed until the emergency braking situation is over. ABS prevents the wheels from locking.

The brakes will function as usual once you release the brake pedal. BAS is deactivated.

Adaptive brake lights

If you brake sharply from a speed of more than 30 mph (50 km/h) or if braking is assisted by BAS, the brake lamps flash rapidly. In this way, traffic traveling behind you is warned in an even more noticeable manner.

If you brake sharply from a speed of more than 45 mph (70 km/h) to a standstill, the hazard warning lamps are activated automatically. If the brakes are applied again, the brake lamps light up continuously. The hazard warning lamps are deactivated automatically if you drive faster than 6 mph (10 km/h). You can also switch off the hazard warning lamps using the hazard warning button (▷ page 89).

ESP® (Electronic Stability Program)

Important safety notes

- ⓘ Observe the "Important safety notes" section (▷ page 55).

WARNING

If ESP® is malfunctioning, ESP® is unable to stabilize the vehicle. Additionally, further driving safety systems are deactivated. This increases the risk of skidding and an accident.

Drive on carefully. Have ESP® checked at a qualified specialist workshop.



- ❗ Only operate the vehicle for a maximum of ten seconds on a brake test dynamometer. Switch off the ignition.

Application of the brakes by ESP® may otherwise destroy the brake system.

- ❗ A function or performance test should only be carried out on a two-axle dynamometer. Before you operate the vehicle on such a dynamometer, please consult a qualified workshop. You could otherwise damage the drive train or the brake system.

ESP® monitors the driving stability and the traction. Traction is the power transmission between the tires and the road surface.

ESP® is deactivated if the  warning lamp in the instrument cluster lights up continuously when the engine is running.

If the  warning lamp and the  warning lamp are lit continuously, ESP® is not available due to a malfunction.

Observe the information on warning lamps (▷ page 207) and display messages which may be displayed in the instrument cluster (▷ page 185).

If ESP® detects that the vehicle is deviating from the direction desired by the driver, one or more wheels are braked to stabilize the vehicle. If necessary, the engine output is also modified to keep the vehicle on the desired course within physical limits. ESP® assists the driver when pulling away on wet or slippery roads. ESP® can also stabilize the vehicle during braking.

If ESP® intervenes, the  warning lamp flashes in the instrument cluster.

If ESP® intervenes:

- ▶ Do not deactivate ESP® under any circumstances.
 - ▶ Only depress the accelerator pedal as far as necessary when pulling away.
 - ▶ Adapt your driving style to suit the prevailing road and weather conditions.
- ⓘ Only use wheels with the recommended tire sizes. Only then will ESP® function properly.
 - ⓘ If differential locks are switched on, ABS, BAS and ESP® switch off automatically.

4ETS (Electronic Traction System)

Traction control remains active, even if you deactivate ESP®.

- ▶ If appropriate for the driving conditions, engage the **LOW RANGE** off-road gear (▷ page 162).

Traction control is part of ESP®.

Traction control brakes the drive wheels individually if they spin. This enables you to pull away and accelerate on slippery surfaces, for example if the road surface is slippery on one side. In addition, more drive torque is transferred to the wheel or wheels with traction.

Traction control remains active, even if you deactivate ESP®.

Traction control is no longer active above a speed of approximately 37 mph (60 km/h).

Traction control brakes the drive wheels individually if they spin. This enables you to pull away and accelerate on slippery surfaces, for example if the road surface is slippery on one side. In addition, more drive torque is transferred to the wheel or wheels with traction.

Deactivating/activating ESP®



WARNING

If you deactivate ESP®, ESP® no longer stabilizes the vehicle. There is an increased risk of skidding and an accident.

Only deactivate ESP® in the situations described in the following.

- ❗ Avoid spinning the driven wheels for an extended period with ESP® deactivated. You could otherwise damage the drivetrain.



- ▶ **To deactivate:** press button ① until the  warning lamp lights up in the instrument cluster.
- ▶ **To activate:** press button ① until the  warning lamp goes out in the instrument cluster.

ESP® is activated automatically when the engine is started.

i Vehicles with the ECO start/stop function: the ECO start/stop function automatically switches the engine off when the vehicle comes to a stop. The engine starts automatically when the driver wants to pull away again. ESP® remains in its previously selected status. For example, if ESP® was deactivated before the engine was switched off, ESP® remains deactivated when the engine is switched on again.

It may be best to deactivate ESP® in the following situations:

- when using snow chains
- in deep snow
- on sand or gravel

If you deactivate ESP®:

- ESP® no longer improves driving stability.
- the engine's torque is no longer limited and the drive wheels can spin. The spinning of the wheels results in a cutting action, which provides better grip.
- traction control is still activated.
- ESP® still provides support when you brake.
- and are driving at above 37 mph (60 km/h) (on AMG vehicles above 62 mph (100 km/h)), ESP® still intervenes when one wheel reaches its grip limit even though it is deactivated.

i If ESP® is deactivated and one or more wheels start to spin, the  warning lamp in

the instrument cluster flashes. In such situations, ESP® will not stabilize the vehicle.

i If ESP® is deactivated, it is reactivated automatically if you are driving at above 37 mph (60 km/h) (on AMG vehicles above 62 mph (100 km/h)) or you exceed a certain lateral acceleration.

Trailer stabilization

 **WARNING**

If road and weather conditions are poor, trailer stabilization will not be able to prevent the vehicle/trailer combination from swerving. Trailers with a high center of gravity can tip over before ESP® can detect this. There is a risk of an accident.

Always adapt your driving style to the prevailing road and weather conditions.

Trailer stabilization does not work if ESP® is deactivated because of a malfunction.

If your vehicle with trailer (vehicle/trailer combination) begins to lurch, you can only stabilize the vehicle/trailer combination by depressing the brake firmly.

In this situation, ESP® assists you and can detect if the vehicle/trailer combination begins to lurch. ESP® slows the vehicle down by braking and limiting the engine output until the vehicle/trailer combination has stabilized.

Trailer stabilization is active above speeds of about 37 mph (60 km/h).

EBD (electronic brake force distribution)

i Observe the "Important safety notes" section (▷ page 55).

 **WARNING**

If EBD is malfunctioning, the rear wheels can lock, e.g. under full braking. This increases the risk of skidding and an accident.

You should therefore adapt your driving style to the different handling characteristics. Have the brake system checked at a qualified specialist workshop.

Observe information regarding indicator and warning lamps (▷ page 206) as well as display messages (▷ page 186).

EBD monitors and controls the brake pressure on the rear wheels to improve driving stability while braking.

ADAPTIVE BRAKE

ADAPTIVE BRAKE provides increased braking safety. In addition to the braking function, ADAPTIVE BRAKE also has the HOLD function (▷ page 157) and hill start assist (▷ page 114).

Theft deterrent locking system

Immobilizer

► **To activate:** remove the SmartKey from the ignition lock.

► **To deactivate:** switch on the ignition.

The immobilizer prevents your vehicle from being started without the correct SmartKey.

When leaving the vehicle, always take the SmartKey with you and lock the vehicle. The engine can be started by anyone with a valid SmartKey that is left inside the vehicle.

i The immobilizer is always deactivated when you start the engine.

In the event that the engine cannot be started when the starter battery is fully charged, the immobilizer may be faulty. Contact an authorized Mercedes-Benz Center or call 1-800-FOR-MERCEdes (in the USA) or 1-800-387-0100 (in Canada).

ATA (anti-theft alarm system)



► **To arm:** lock the vehicle with the SmartKey. Indicator lamp **i** flashes. The alarm system is armed after approximately 15 seconds.

► **To disarm:** unlock the vehicle with the SmartKey.

i If you then do not open a side door or the rear door, the alarm system switches back on again after approximately 40 seconds.

► **To stop the alarm:** insert the SmartKey into the ignition lock.

The alarm is switched off.

or

► Press the  or  button on the SmartKey.

The alarm is switched off.

A visual and audible alarm is triggered if the alarm system is armed and you open:

- a door
- a door using the mechanical key
- the rear door
- the hood

The alarm is also triggered if:

- the position of the vehicle is changed.
- a window is smashed.

The alarm is not switched off, even if you close the open door that triggered it, for example.

i If the alarm stays on for more than 30 seconds, the mbrace emergency call system (USA only) or Tele Aid system (Canada only) initiates a call to the Customer Assistance Center automatically. The mbrace emergency call system initiates the call if:

- you have subscribed to the Tele Aid service.
- the Tele Aid service has been activated properly.
- the required mobile phone, power supply and GPS are available.

Useful information

- i** This Operator's Manual describes all models and all standard and optional equipment of your vehicle available at the time of publication of the Operator's Manual. Country-specific differences are possible. Please note that your vehicle may not be equipped with all features described. This also applies to safety-related systems and functions.
- i** Read the information on qualified specialist workshops: (▷ page 23).

SmartKey

Important safety notes

⚠ WARNING

If children are left unsupervised in the vehicle, they could:

- open the doors, thus endangering other people or road users.
- get out and disrupt traffic.
- operate the vehicle's equipment.

Additionally, children could set the vehicle in motion if, for example, they:

- release the parking brake.
- shift the automatic transmission out of park position P or shift manual transmission into neutral.
- start the engine.

There is a risk of an accident and injury.

When leaving the vehicle, always take the SmartKey with you and lock the vehicle. Never leave children or animals unattended in the vehicle. Always keep the SmartKey out of reach of children.

⚠ WARNING

If persons, particularly children are subjected to prolonged exposure to extreme heat or cold, there is a risk of injury, possibly even fatal. Never leave children unattended in the vehicle.

⚠ WARNING

If you attach heavy or large objects to the SmartKey, the SmartKey could be unintentionally turned in the ignition lock. This could cause the engine to be switched off. There is a risk of an accident.

Do not attach any heavy or large objects to the SmartKey. Remove any bulky key rings before inserting the SmartKey into the ignition lock.

SmartKey functions

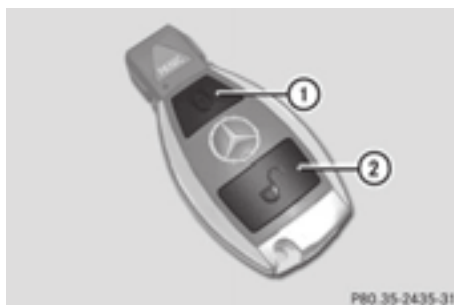

- ① To lock the vehicle
- ② Unlocks the vehicle

► **To unlock centrally:** press the button.

If you do not open the vehicle within approximately 40 seconds of unlocking:

- the vehicle is locked again.
- anti-theft protection is reactivated.

► **To lock centrally:** press the button.

The SmartKey centrally locks/unlocks:

- the doors
- the rear door
- the fuel filler flap

i The turn signals flash once when unlocking and three times when locking.

You can also set an audible signal to confirm that the vehicle has been locked. The audible signal can be activated and deactivated using the on-board computer (▷ page 180).

When it is dark, the surround lighting also comes on if it is activated in the on-board computer (▷ page 179).

Changing the settings of the locking system



You can change the setting of the locking system in such a way that only the driver's door and the fuel filler flap are unlocked. This is useful if you frequently travel on your own.

i If the setting of the locking system is changed within the signal range of the vehicle, pressing the or button locks or unlocks the vehicle.

► **To change the setting:** press and hold down the and buttons simultaneously for approximately six seconds until battery check lamp flashes twice.

The SmartKey now functions as follows:

► **To unlock the driver's door and fuel filler flap:** press the button once.

► **To unlock centrally:** press the button twice.

► **To lock centrally:** press the button.

Restoring the factory settings



► Press the and buttons simultaneously for approximately six seconds until battery check lamp flashes twice.

Mechanical key

General notes

If the vehicle can no longer be unlocked with the SmartKey, use the mechanical key.

If you use the mechanical key to unlock and open the driver's door or the rear door, the anti-theft alarm system will be triggered (► page 59).

► **To end the alarm:** insert the SmartKey into the ignition lock.

Removing the mechanical key

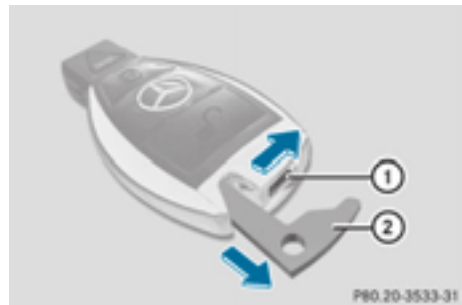

① Release catch

② Mechanical key

► Push release catch in the direction of the arrow and at the same time remove mechanical key from the SmartKey.

SmartKey battery

Important safety notes

WARNING

Batteries contain toxic and corrosive substances. If batteries are swallowed, it can result in severe health problems. There is a risk of fatal injury.



Keep batteries out of the reach of children. If a battery is swallowed, seek medical attention immediately.



The SmartKey batteries contain perchlorate material, which may require special handling and regard for the environment. Check your national disposal guidelines. In California, see www.dtsc.ca.gov/HazardousWaste/Perchlorate/index.cfm.

Mercedes-Benz recommends that you have the batteries replaced at a qualified specialist workshop.

Checking the battery



- ▶ Press the  or  button. The battery is working properly if battery check lamp ① lights up briefly. If battery check lamp ① does not light up during the test, the battery is discharged.
- ▶ Change the battery (▷ page 62).

- i** You can obtain a battery at any qualified specialist workshop.
- i** Have the batteries replaced at a qualified specialist workshop.
- i** If the SmartKey battery is checked within the signal reception range of the vehicle, pressing the  or  button:
 - locks or
 - unlocks the vehicle

Replacing the battery

You require a CR 2025 3 V cell battery.

- ▶ Take the mechanical key out of the SmartKey (▷ page 61).



- ① Battery compartment cover
- ② Mechanical key
- ▶ Press mechanical key ② into the opening in the SmartKey in the direction of the arrow until battery tray cover ① opens. Do not hold the cover closed while doing so.
- ▶ Remove battery tray cover ①.

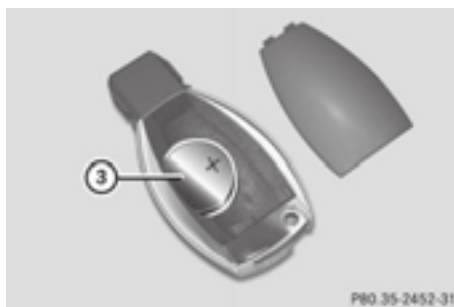

- ③ Battery
- ▶ Repeatedly tap the SmartKey against your palm until battery ③ falls out.
- ▶ Insert the new battery with the positive terminal facing upwards. Use a lint-free cloth to do so.
- ▶ Make sure that the surface of the battery is free from lint, grease and all other forms of contamination.
- ▶ Insert the front tabs of battery tray cover ① and then press to close it.
- ▶ Insert the mechanical key into the SmartKey.
- ▶ Check the function of all SmartKey buttons on the vehicle.

Problems with the SmartKey

Problem	Possible causes/consequences and ► Solutions
<p>You cannot lock or unlock the vehicle using the SmartKey.</p>	<p>The SmartKey battery is discharged or nearly discharged.</p> <ul style="list-style-type: none"> ► Point the tip of the SmartKey at the driver's door handle from a distance of approximately 1.5 ft (50 cm) and try to unlock or lock the vehicle again. <p>If this does not work:</p> <ul style="list-style-type: none"> ► Check the SmartKey battery (▷ page 62) and replace it if necessary (▷ page 62). ► Unlock (▷ page 66) or lock (▷ page 66) the vehicle using the mechanical key. <p>The SmartKey is faulty.</p> <ul style="list-style-type: none"> ► Lock or unlock the vehicle using the mechanical key (▷ page 66). ► Have the SmartKey checked at a qualified specialist workshop.
<p>You have lost a Smart-Key.</p>	<ul style="list-style-type: none"> ► Have the SmartKey deactivated at a qualified specialist workshop. ► Report the loss immediately to the vehicle insurers. ► If necessary, have the locks changed as well.
<p>You have lost the mechanical key.</p>	<ul style="list-style-type: none"> ► Report the loss immediately to the vehicle insurers. ► If necessary, have the locks changed as well.
<p>The engine cannot be started using the Smart-Key.</p>	<p>The SmartKey has been in position 0 (▷ page 112) for a considerable time.</p> <ul style="list-style-type: none"> ► Remove the SmartKey and reinsert it into the ignition lock. ► Start the engine. <p>The on-board voltage is too low.</p> <ul style="list-style-type: none"> ► Switch off non-essential consumers, e.g. seat heating or interior lighting, and try to turn the SmartKey again. <p>If this does not work:</p> <ul style="list-style-type: none"> ► Check the battery and charge it if necessary (▷ page 252). <p>or</p> <ul style="list-style-type: none"> ► Jump-start the vehicle (▷ page 254). <p>or</p> <ul style="list-style-type: none"> ► Consult a qualified specialist workshop.

Doors

Important safety notes

⚠ WARNING

When leaving the vehicle, always remove the SmartKey from the ignition lock. Always take the SmartKey with you and lock the vehicle. Do not leave children unsupervised in the vehicle, even if they are secured in a child restraint system, and do not give them access to an unlocked vehicle. A child's unsupervised access to a vehicle could result in an accident and/or serious personal injury. They could:

- injure themselves on vehicle parts
- be seriously or fatally injured by extreme heat or cold
- injure themselves or have an accident with vehicle equipment that may still be in operation even after the SmartKey has been removed from the ignition, such as the seat adjustment, steering wheel adjustment or memory function.

If children open a door, they could cause severe or even fatal injury to other persons; if they get out of the vehicle, they could injure themselves when doing so or be seriously or even fatally injured by any passing traffic.

Do not expose the child restraint system to direct sunlight. The child restraint system's metal parts, for example, could become very hot, and a child could be burned on these parts.

⚠ WARNING

Do not carry heavy or hard objects in the passenger compartment or cargo compartment unless they are firmly secured in place. Unsecured or improperly positioned cargo increases a child's risk of injury in the event of

- strong braking maneuvers
- sudden changes of direction
- an accident

⚠ WARNING

If children are left unsupervised in the vehicle, they could:

- open the doors, thus endangering other people or road users.
- get out and disrupt traffic.
- operate the vehicle's equipment.

Additionally, children could set the vehicle in motion if, for example, they:

- release the parking brake.
- shift the automatic transmission out of park position P or shift manual transmission into neutral.
- start the engine.

There is a risk of an accident and injury.

When leaving the vehicle, always take the SmartKey with you and lock the vehicle. Never leave children or animals unattended in the vehicle. Always keep the SmartKey out of reach of children.

Unlocking and opening doors from the inside

If the vehicle has previously been locked with the SmartKey, opening a door from the inside will trigger the anti-theft alarm system. Switch off the alarm (▷ page 59).

Only open the door when the traffic situation permits.



P72.00-3981-31

- ▶ **Front doors:** pull door handle ②.
If the door is locked, locking knob ① pops up.
The door is unlocked and can be opened.
- ▶ **Rear compartment doors:** pull handle ① up.
The door is unlocked.
- ▶ Pull door handle ②.

Centrally locking and unlocking the vehicle from the inside

WARNING

If children are left unsupervised in the vehicle, they could:

- open the doors, thus endangering other people or road users.
- get out and disrupt traffic.
- operate the vehicle's equipment.

Additionally, children could set the vehicle in motion if, for example, they:

- release the parking brake.
- shift the automatic transmission out of park position P or shift manual transmission into neutral.
- start the engine.

There is a risk of an accident and injury.

When leaving the vehicle, always take the SmartKey with you and lock the vehicle. Never leave children or animals unattended in the vehicle. Always keep the SmartKey out of reach of children.

You can centrally lock or unlock the vehicle from the inside.

The central locking button does not lock or unlock the fuel filler flap.



- ▶ **To unlock:** press button ①.
- ▶ **To lock:** press button ②.

If all the doors are closed, the vehicle locks.

You can open a front door from inside the vehicle even if it has been locked. Only open the door when the traffic situation permits.

If the vehicle has been locked with the central locking button:

- and the SmartKey is restored to the factory settings, the entire vehicle is unlocked if a front door is opened from inside the vehicle.
- and the SmartKey is set to an individual setting, only the front door that is opened from inside the vehicle is unlocked.

If the vehicle has been locked centrally with the SmartKey, it does not unlock if you use the central locking button.

- i** You cannot unlock the vehicle centrally from the inside if the vehicle has been locked from the outside using the SmartKey.
- i** It is only possible to lock the vehicle centrally if all doors are closed.

Automatic locking feature



- ① To deactivate
- ② To activate

- ▶ **To deactivate:** press and hold button ① for about five seconds until a tone sounds.
- ▶ **To activate:** press and hold button ② for about five seconds until a tone sounds.

i If you press one of the two buttons and do not hear a tone, the relevant setting has already been selected.

The vehicle is locked automatically when the ignition is switched on and the vehicle's wheels are moving at a speed in excess of 9 mph (15 km/h).

You could therefore be locked out if:

- the vehicle is being pushed.
- the vehicle is being towed.
- the vehicle is being tested on a dynamometer.

You can also switch the automatic locking function on and off using the on-board computer (▷ page 180).

Unlocking the driver's door (mechanical key)

If the vehicle can no longer be centrally unlocked with the SmartKey, use the mechanical key.

If you use the mechanical key to unlock and open the driver's door, the anti-theft alarm system will be triggered (▷ page 59).

Take the mechanical key out of the SmartKey (▷ page 61).



- ▶ Insert the mechanical key into the lock of the driver's door as far as it will go.
- ▶ Turn the mechanical key counter-clockwise to position 1. The door is unlocked.
- ▶ Turn the mechanical key back and remove it.
- ▶ Insert the mechanical key into the SmartKey.

Locking the vehicle

If the vehicle can no longer be centrally locked with the SmartKey, use the mechanical key.

- ▶ Close the front-passenger door, the rear doors and the tailgate.
- ▶ Press the locking button (▷ page 65).
- ▶ Make sure that the locking knobs on the doors are still visible. Press down the locking knobs by hand, if necessary.
- ▶ Close the driver's door from the outside.



- ▶ Take the mechanical key out of the SmartKey (▷ page 61).
- ▶ Insert the mechanical key into the lock of the driver's door as far as it will go.
- ▶ Turn the mechanical key clockwise as far as it will go to position 1.
- ▶ Turn the mechanical key back and remove it.

- ▶ Make sure that the doors and the tailgate are locked.
 - ▶ Insert the mechanical key into the SmartKey.
- i** If you lock the vehicle as described above, the fuel filler flap is not locked. The anti-theft alarm system is not armed.

Rear door

Important safety notes

WARNING

When leaving the vehicle, always remove the SmartKey from the ignition lock. Always take the SmartKey with you and lock the vehicle. Do not leave children unsupervised in the vehicle, even if they are secured in a child restraint system, and do not give them access to an unlocked vehicle. A child's unsupervised access to a vehicle could result in an accident and/or serious personal injury. They could:

- injure themselves on vehicle parts
- be seriously or fatally injured by extreme heat or cold
- injure themselves or have an accident with vehicle equipment that may still be in operation even after the SmartKey has been removed from the ignition, such as the seat adjustment, steering wheel adjustment or memory function.

If children open a door, they could cause severe or even fatal injury to other persons; if they get out of the vehicle, they could injure themselves when doing so or be seriously or even fatally injured by any passing traffic.

Do not expose the child restraint system to direct sunlight. The child restraint system's metal parts, for example, could become very hot, and a child could be burned on these parts.

WARNING

Do not carry heavy or hard objects in the passenger compartment or cargo compartment unless they are firmly secured in place.

Unsecured or improperly positioned cargo increases a child's risk of injury in the event of

- strong braking maneuvers
- sudden changes of direction
- an accident

WARNING

Combustion engines emit poisonous exhaust gases such as carbon monoxide. If the rear door is open when the engine is running, particularly if the vehicle is moving, exhaust fumes could enter the passenger compartment. There is a risk of poisoning.

Turn off the engine before opening the rear door. Never drive with the rear door open.

! The tailgate swings out to the side when opened. Therefore, make sure that there is sufficient clearance.

i Do not leave the SmartKey in the cargo compartment. Otherwise, you could lock yourself out.

Opening

You can only open the rear door after unlocking it first.

- ▶ Press the  button on the SmartKey.

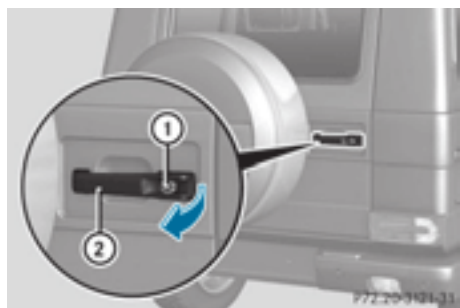

- ▶ Press release button ① and pull door handle ②.
- ▶ Open the rear door.

Closing

- ▶ Push the rear door closed from outside the vehicle.
- ▶ If necessary, lock the vehicle with the  button on the SmartKey.

Side windows

Important safety notes

WARNING

While closing the side windows, body parts in the closing area could become trapped. There is a risk of injury.

When closing make sure that no parts of the body are in the closing area. If somebody becomes trapped, release the switch or press the switch to open the side window again.

WARNING

While opening the side windows, body parts could become trapped between the side window and the door frame as the side window moves. There is a risk of injury.

Make sure that nobody touches the side window during the opening procedure. If somebody becomes trapped, release the switch or pull the switch to close the side window again.

Opening and closing the side windows

The switches for all side windows are located on the driver's door. There is also a switch on each door for the corresponding side window.

The switches on the driver's door take precedence.

The side windows cannot be operated from the rear when the override feature for the side windows is activated (> page 54).

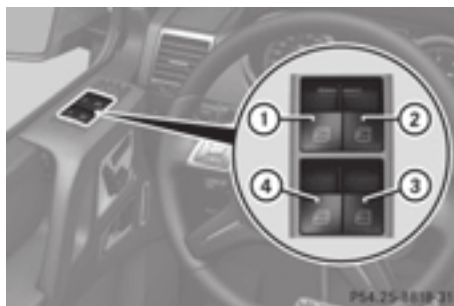

- ① Front left
- ② Front right
- ③ Rear right
- ④ Rear left

- ▶ Turn the SmartKey to position **1** or **2** in the ignition.
- ▶ **To open:** press the corresponding switch.
- ▶ **To close:** pull the corresponding switch.
- ▶ **To open automatically:** press the corresponding switch briefly beyond the point of resistance.
The side window opens completely.
- ▶ **To interrupt automatic operation:** press or pull the corresponding switch again.



- i** You can continue to operate the side windows after you switch off the engine or remove the SmartKey. This function is available for up to five minutes or until the driver's or front-passenger door is opened.
- i** The side windows cannot be operated from the rear when the override feature for the side windows is activated (> page 54).

Convenience opening

- i** The convenience opening feature can only be operated using the SmartKey. The SmartKey must be close to the driver's door handle.

You can ventilate the vehicle before you start driving. To do this, the SmartKey is used to carry out the following functions simultaneously:

- unlock the vehicle
- open the side windows
- open the sliding sunroof
- switch on the seat ventilation for the driver's seat and front-passenger seat

- ▶ Point the tip of the SmartKey at the driver's door handle.
- ▶ Press and hold the  button until the side windows and the sliding sunroof are in the desired position.
- ▶ **To interrupt convenience opening:** release the  button.

Convenience closing feature

Important safety notes

WARNING



When the convenience closing feature is operating, parts of the body could become trapped in the closing area of the side window and the sliding sunroof. There is a risk of injury.

Observe the complete closing procedure when the convenience closing feature is operating. Make sure that no body parts are in close proximity during the closing procedure.

Operation

- i** The "convenience closing feature" can only be operated using the key. The SmartKey must be close to the driver's door handle.

When you lock the vehicle, you can simultaneously:

- close the side windows
- close the sliding sunroof
- ▶ Point the tip of the SmartKey at the driver's door handle.
- ▶ Press and hold the  button until the side windows and the sliding sunroof are fully closed.
- ▶ Make sure that all the side windows and the sliding sunroof are closed.
- ▶ **To interrupt convenience closing:** release the  button.

Problems with the side windows

WARNING

Closing the side windows with increased force or without the anti-entrapment feature could lead to serious or even fatal injury. Make sure

that nobody can become trapped when closing the side windows.

Problem: a side window cannot be closed because objects are trapped between the side window and the door frame.

- ▶ Remove the objects.
- ▶ Close the side window.

Problem: a side window cannot be closed and you cannot see the cause.

If a side window is obstructed during closing and reopens again slightly:

- ▶ Immediately after the window blocks, pull the corresponding switch again until the side window has closed.

If a side window is obstructed again during closing and reopens again slightly:

- ▶ Immediately after the window blocks, pull the corresponding switch again until the side window has closed.

- i** If a side window no longer opens or closes due to a malfunction, contact a qualified specialist workshop.

Sliding sunroof

Important safety notes

- !** Only open the sliding sunroof if it is free of snow and ice. Otherwise, malfunctions may occur.
Do not allow anything to protrude from the sliding sunroof. Otherwise, the seals could be damaged.
- !** If the sliding sunroof still cannot be opened or closed as a result of a malfunction, contact a qualified specialist workshop.
- !** The weather can change abruptly. It could start to rain or snow. Make sure that the sliding sunroof is closed when you leave the vehicle. The vehicle electronics can be damaged if water enters the vehicle interior.



- i** Resonance noises can occur in addition to the usual airflow noises when the sliding sunroof is open. They are caused by minor pressure fluctuations in the vehicle interior. Change the position of the sliding sunroof or open a side window slightly to reduce or eliminate these noises.

Opening and closing the sliding sunroof



Overhead control panel

- ① To raise
- ② To open
- ③ To close/lower

- ▶ Turn the SmartKey to position 1 or 2 (▷ page 112) in the ignition.
- ▶ Press or pull the  switch in the corresponding direction.
- ▶ **To open automatically:** press the  switch briefly beyond the point of resistance in the direction of arrow ②. The sliding sunroof opens completely.
- ▶ **To interrupt automatic operation:** press or pull the  switch again.
- ⓘ When opening and raising the roof, automatic operation is only available if the sliding sunroof is in the closed position.

Operating the sliding sunroof manually

The actuator is located in the cargo compartment, on the left-hand side behind the rear wall trim.

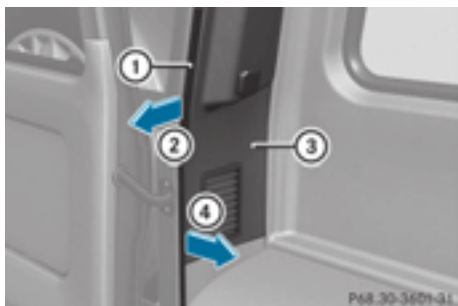

- ▶ Open the rear door.
- ▶ Pull off edge protection ① from the door pillar in the direction of arrow ②.
- ▶ Pull away rear panel trim ③ as far as necessary in the direction of arrow ④ until the electrical connections can be accessed.
- ▶ Disconnect the electrical connections.
- ▶ Remove rear panel trim ③ completely.



- ▶ Take lug wrench ⑤ out of the vehicle tool kit (▷ page 248).
- ▶ Place lug wrench ⑤ onto the hexagonal nut of the actuator.
- ▶ **To open:** turn lug wrench ⑤ counter-clockwise.
- ▶ **To close:** turn lug wrench ⑤ clockwise.

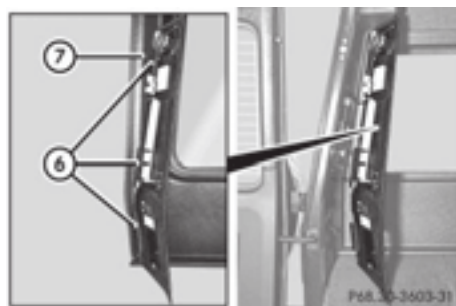
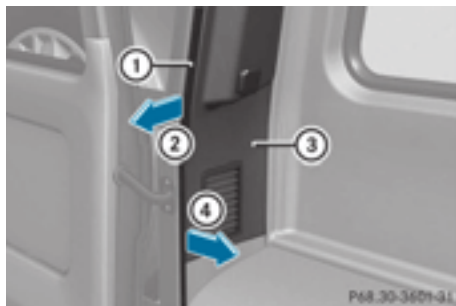

- ▶ Reconnect the electrical connections.
- ▶ Re-install rear panel trim ③.
When doing so, hook lugs ⑥ of rear panel trim ③ into vehicle side wall ⑦.
- ▶ Re-install edge protection ①.
- ▶ Close the rear door.

Problems with the sliding sunroof

WARNING

You could be severely or even fatally injured when closing the sliding sunroof with increased closing force or if the anti-entrapment feature is deactivated. Make sure that nobody can become trapped when closing the sliding sunroof.

- ❗ If the sliding sunroof still cannot be opened or closed as a result of a malfunction, contact a qualified specialist workshop.

Problem: the sunroof cannot be closed and you cannot see the cause.

If the sliding sunroof is obstructed during closing and reopens again slightly:

- ▶ Immediately after the sliding sunroof blocks, pull the  switch in the overhead control panel down to the point of resistance and hold it until the sliding sunroof is closed.

If the sliding sunroof is obstructed again during closing and reopens again slightly:

- ▶ Immediately after the sliding sunroof blocks, pull the  switch in the overhead control panel down to the point of resistance and hold it until the sliding sunroof is closed.

Useful information

- i** This Operator's Manual describes all models and all standard and optional equipment of your vehicle available at the time of publication of the Operator's Manual. Country-specific differences are possible. Please note that your vehicle may not be equipped with all features described. This also applies to safety-related systems and functions.
- i** Read the information on qualified specialist workshops: (▷ page 23).

Correct driver's seat position



- ① Steering wheel
- ② Seat belts
- ③ Backrest

- ▶ Observe the safety guidelines on seat adjustment (▷ page 72).
- ▶ Make sure that seat ③ is adjusted properly. Electrical seat adjustment (▷ page 74)

When adjusting the seat, make sure that:

- you are as far away from the driver's air bag as possible
- you are sitting in a normal upright position
- you can fasten the seat belt properly
- you have moved the backrest to an almost vertical position

- you have set the seat cushion angle so that your thighs are gently supported
- you can depress the pedals properly
- ▶ Check whether the head restraint is adjusted properly (▷ page 74).
When doing so, make sure that you have adjusted the head restraint so that the back of your head is supported at eye level by the center of the head restraint.
- ▶ Observe the safety guidelines on steering wheel adjustment (▷ page 72).
- ▶ Make sure that steering wheel ① is adjusted properly.
Adjusting the steering wheel electrically (▷ page 78).

When adjusting the steering wheel, make sure that:

- you can hold the steering wheel with your arms slightly bent
- you can move your legs freely
- you can see all the displays in the instrument cluster clearly
- ▶ Observe the safety guidelines for seat belts (▷ page 36).
- ▶ Check whether you have fastened seat belt ② properly (▷ page 38).

The seat belt should:

- fit snugly across your body
- be routed across the middle of your shoulder
- be routed in your pelvic area across the hip joints
- ▶ Before starting off, adjust the rear-view mirror and the exterior mirrors in such a way that you have a good view of road and traffic conditions (▷ page 80).
- ▶ **Vehicles with a memory function:** save the seat, steering wheel and exterior mirror settings with the memory function (▷ page 82).

Seats

Important safety notes

WARNING

Children could become trapped if they adjust the seats, particularly when unattended. There is a risk of injury.

When leaving the vehicle, always take the SmartKey with you and lock the vehicle. Never leave children unsupervised in the vehicle.

The seats can still be adjusted when there is no SmartKey in the ignition lock.

WARNING

When you adjust a seat, you or other vehicle occupants could become trapped, e.g. on the seat guide rail. There is a risk of injury.

Make sure when adjusting a seat that no one has any body parts in the sweep of the seat.

Observe the safety notes on "Air bags" (▷ page 40) and "Children in the vehicle" (▷ page 46).

WARNING

You could lose control of your vehicle if you do the following while driving:

- adjust the driver's seat, head restraint, steering wheel or mirrors
- fasten the seat belt

There is a risk of an accident.

Adjust the driver's seat, head restraint, steering wheel and mirror and fasten your seat belt before starting the engine.

WARNING

If the head restraints are not installed or not adjusted correctly, they cannot provide protection as intended. There is an increased risk of injury in the head and neck area, e.g. in the event of an accident or when braking.

Always drive with the head restraints installed. Before driving off, make sure for every vehicle occupant that the center of the head restraint supports the back of the head at about eye level.

Make sure that you do not rotate the head restraints of the front and rear seats when adjusting the head restraints. Otherwise, you cannot adjust the height and angle of the head restraints correctly.

Adjust the head restraint so that it is as close as possible to your head.

WARNING

According to accident statistics, children are safer when properly restrained on the rear seats than on the front-passenger seat. Thus, we strongly recommend that children be placed in the rear seat whenever possible. Regardless of seating position, children 12 years old and under must be seated and properly secured in an appropriately sized child restraint system or booster seat recommended for the size and weight of the child. For additional information, see the "Children in the vehicle" section.

A child's risk of serious or fatal injuries is significantly increased if the child restraints are not properly secured in the vehicle and/or the child is not properly secured in the child restraint.

 To avoid damage to the seats and the seat heating, observe the following information:

- keep liquids from spilling on the seats. If liquid is spilled on the seats, dry them as soon as possible.
- if the seat covers are damp or wet, do not switch on the seat heating. The seat heating should also not be used to dry the seats.
- clean the seat covers as recommended; see the "Interior care" section.
- do not transport heavy loads on the seats. Do not place sharp objects on the seat cushions, e.g. knives, nails or tools. The seats should only be occupied by passengers, if possible.
- when the seat heating is in operation, do not cover the seats with insulating materials, e.g. blankets, coats, bags, seat covers, child seats or booster seats.

 Make sure that there are no objects in the footwell under or behind the seats when moving the seats back. There is a risk that the seats and/or the objects could be damaged.

 When the rear bench seat is folded forwards, the front seats cannot be moved to their rearmost position. You could otherwise damage the seats and the rear bench seat.

 Make sure that the sun visor is folded up before adjusting the backrest and head restraint height. The head restraint and sun

visor could otherwise collide when the head restraint is fully extended.

- i** If the front door is open, the seats can be adjusted for up to 30 minutes after the ignition has been switched off.
- i** The rear-compartment head restraints can be removed (▷ page 75).
For more information, contact a qualified specialist workshop.
- i** You can find further information about enlarging the cargo compartment (folding the rear bench seat forwards) on (▷ page 218).

Adjusting the seats electrically

- !** Make sure that the cup holder on the center console is folded down before you move the front-passenger seat forwards.



- ① Head restraint height
- ② Seat cushion angle
- ③ Seat height
- ④ Seat fore-and-aft adjustment
- ⑤ Backrest angle

- i** You can store the seat settings using the memory function (▷ page 82).

Adjusting the head restraints

Important safety notes

WARNING

If head restraints are not installed and adjusted correctly, they cannot provide protection as intended. There is an increased risk of injury in the head and neck area, e.g. in the event of an accident or when braking.

Always drive with the head restraints installed. Before driving off, make sure for every vehicle occupant that the center of the head restraint supports the back of the head at about eye level.

Observe the following when adjusting the head restraints:

- ▶ Do not rotate the head restraints of the front and rear seats.
Otherwise, you cannot adjust the height and angle of the head restraints correctly.
- ▶ Adjust the head restraint so that it is as close as possible to your head.

Adjusting the front seat head restraint height

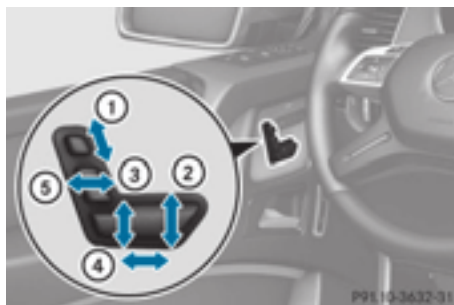

- ① Head restraint height
- ② Seat cushion angle
- ③ Seat height
- ④ Seat fore-and-aft adjustment
- ⑤ Backrest angle

- ▶ Slide head restraint adjustment button ① up or down in the direction of the arrow.

Adjusting the luxury head restraints



- ▶ **To adjust the side bolsters of the head restraint:** push or pull right and/or left-hand side bolster ① into the desired position.
- ▶ **To adjust the angle of the head restraint:** push or pull the head restraint in the direction of arrow ②.

Resetting the front seat head restraints

It is necessary to reset the front seat head restraints after the voltage supply has been interrupted, e.g. if the battery has been completely discharged or disconnected.

- ▶ Make sure that the cup holder on the center console is folded down (▷ page 220).
- ▶ Move the seat as far forward as possible and the head restraint in as far as possible.

Rear seat head restraints

Important safety notes

WARNING

If head restraints are not installed and adjusted correctly, they cannot provide protection as intended. There is an increased risk of injury in the head and neck area, e.g. in the event of an accident or when braking.

Always drive with the head restraints installed. Before driving off, make sure for every vehicle occupant that the center of the head restraint supports the back of the head at about eye level.

Observe the following when adjusting the head restraints:

- ▶ Do not rotate the head restraints of the front and rear seats. Otherwise, you cannot adjust the height and angle of the head restraints correctly.
- ▶ Adjust the head restraint so that it is as close as possible to your head.

Adjusting the rear seat head restraint height

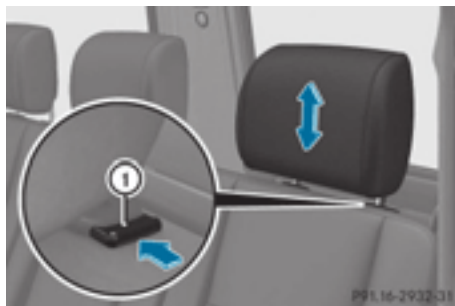

- ▶ Once the head restraint is fully lowered, press release catch ①.
- ▶ **To raise:** pull the head restraint up to the desired position.
- ▶ **To lower:** press release catch ① and push the head restraint down until it is in the desired position.

Installing/removing the rear seat head restraints

- ▶ **To remove:** pull the head restraint up to the stop.
 - ▶ Press release catch ① and pull the head restraint out of the guides.
 - ▶ **To re-install:** place the head restraint in the guides of the backrest.
- i** The notches on the guide rod must be on the left-hand side when viewed in the direction of travel.
- ▶ Push the head restraint down until you hear it engage in position.

Adjusting the multicontour seat

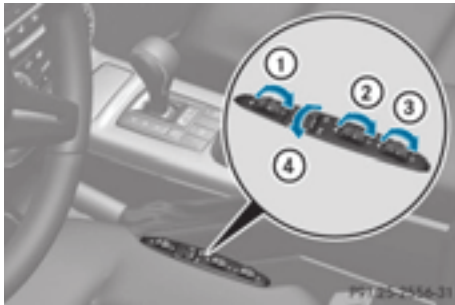

- ① To adjust the thigh cushion
- ② To adjust the backrest contour in the lumbar region
- ③ To adjust the backrest contour in the upper back region
- ④ To adjust the side bolsters of the seat backrest

You can adjust the contour of the front seats individually so as to provide optimum support for your back and sides.

- ▶ Make sure that the SmartKey is in position 1 or 2 (▶ page 112) in the ignition lock.

Adjusting the 4-way lumbar support

You can adjust the contour of the front seat backrests individually to provide optimum support for your back.

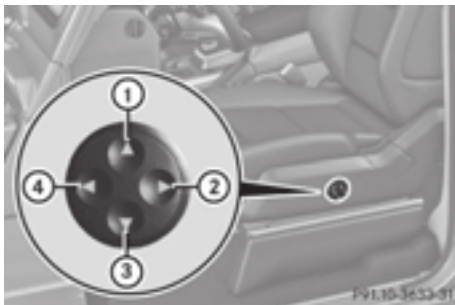

- ① To raise the backrest contour
- ② To soften the backrest contour
- ③ To lower the backrest contour
- ④ To harden the backrest contour

Switching the seat heating on/off

General notes

WARNING

Repeatedly switching on the seat heating can cause the seat cushion and backrest pads to become very hot. The health of persons with limited temperature sensitivity or a limited ability to react to excessively high temperatures may be affected or they may even suffer burn-like injuries. There is a risk of injury.

Therefore, do not switch the seat heating on repeatedly.

The red indicator lamps in the button indicate the heating level you have selected.

- ▶ Make sure that the SmartKey is in position 2 in the ignition lock.

- i** If the battery voltage is too low, the seat heating may switch off.

One or more of the indicator lamps in the seat heating button are flashing.

Switching the front-seat heating on/off



- ▶ **To switch on:** press button ① repeatedly until the desired heating level is set.
- ▶ **To switch off:** press button ① repeatedly until all the indicator lamps go out.

- i** The system automatically switches from level 3 to level 2 after approximately eight minutes.

The system automatically switches down from level 2 to level 1 after approximately ten minutes.

The system automatically switches off approximately 35 minutes after it is set to level 1.

Switching the rear-seat heating on/off



- ▶ **To switch on:** press button ① repeatedly until the desired heating level is set.
- ▶ **To switch off:** press button ① repeatedly until all the indicator lamps go out.
- ❗ The system automatically switches from level 3 to level 2 after approximately eight minutes.
The system automatically switches down from level 2 to level 1 after approximately ten minutes.
The system automatically switches off approximately 35 minutes after it is set to level 1.

Problems with the seat heating

If the on-board voltage is too low, the seat heating is switched off automatically.

- ▶ Switch off electrical consumers that you do not need, such as the rear window defroster or interior lighting.
If the on-board voltage is only interrupted briefly, the seat heating will switch back on automatically. If the seat heating is not switched on automatically:
- ▶ Switch on the seat heating manually (▷ page 76)

Switching the seat ventilation on/off

Switching on/off



Seat ventilation is only available for the front seats.

The three blue indicator lamps in the buttons indicate the ventilation level you have selected.

- ▶ Make sure that the SmartKey is in position 2 (▷ page 112) in the ignition lock.
- ▶ **To switch on:** press button ① repeatedly until the desired ventilation level is set.
- ❗ If you open the side windows and the sliding sunroof using the SmartKey (▷ page 68), the driver's seat ventilation automatically switches to the highest level.
- ▶ **To switch off:** press button ① repeatedly until all the indicator lamps go out.
- ❗ If the battery voltage is too low, the seat ventilation may switch off.

Problems with the seat ventilation

If one or all of the indicator lamps in the seat ventilation button are flashing, the seat ventilation has switched off automatically. The vehicle's electrical system voltage is too low because too many electrical consumers are switched on.

- ▶ Switch off electrical consumers that you do not need, such as the rear window defroster or interior lighting.
Once the battery is sufficiently charged, the seat ventilation will switch back on automatically.

Steering wheel

Important safety notes

WARNING

You could lose control of your vehicle if you do the following while driving:

- adjust the driver's seat, head restraint, steering wheel or mirrors
- fasten the seat belt

There is a risk of an accident.

Adjust the driver's seat, head restraint, steering wheel and mirror and fasten your seat belt before starting the engine.

WARNING

Children could injure themselves if they adjust the steering wheel. There is a risk of injury.

When leaving the vehicle, always take the SmartKey with you and lock the vehicle. Never leave children unsupervised in the vehicle.

The electrically adjustable steering wheel can still be adjusted when there is no SmartKey in the ignition lock.

Adjusting the steering wheel

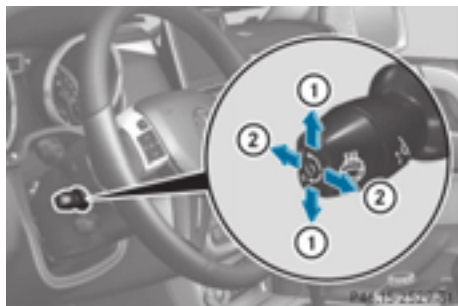

- ① To adjust the steering wheel height
- ② To adjust the steering wheel position (fore-and-aft adjustment)

- i** If the driver's door is open, the steering wheel can be adjusted for up to 30 minutes after the ignition has been switched off.

i Further related subjects:

- EASY-ENTRY/EXIT feature (▷ page 79)
- Storing settings (▷ page 82)

Steering wheel heating

Activating/deactivating

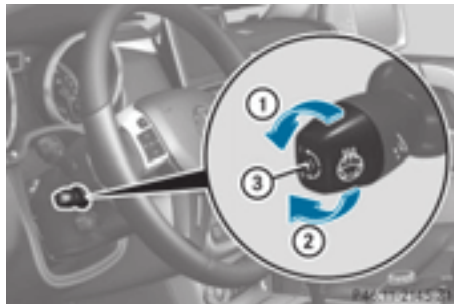

- ① To switch on the steering-wheel heating
- ② To switch off the steering-wheel heating
- ③ Indicator lamp

The steering-wheel heating heats the leather areas of the steering wheel.

- ▶ **To activate:** make sure that the SmartKey is in position **1** or **2** in the ignition lock.
- ▶ Turn the catch in the direction of arrow ①. Indicator lamp ③ lights up.
- ▶ **To deactivate:** make sure that the SmartKey is in position **1** or **2** in the ignition lock.
- ▶ Turn the catch in the direction of arrow ②. Indicator lamp ③ goes out.

- i** The steering wheel heating does not switch off automatically.

- i** The steering wheel heating may switch off temporarily if:

- the temperature in the vehicle interior is above 86 °F (30 °C)
- the temperature of the steering wheel is above 95 °F (35 °C)

Indicator lamp ③ remains on.

- i** The steering wheel heating is deactivated if you remove the SmartKey from the ignition lock.

Problems with the steering wheel heating

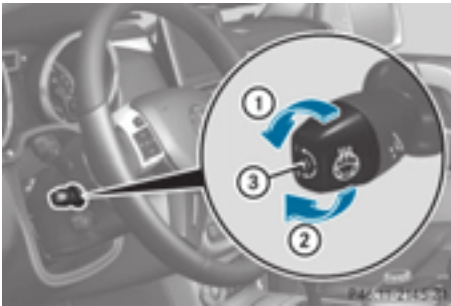

- ① To switch on the steering-wheel heating
- ② To switch off the steering-wheel heating
- ③ Indicator lamp

If steering wheel heating indicator lamp ③ is flashing, the steering wheel heating has switched off automatically. The vehicle's electrical system voltage is too low because too many electrical consumers are switched on.

- ▶ Switch off electrical consumers that you do not need, such as the rear window defroster or interior lighting. Once the battery is sufficiently charged, the steering wheel heating will switch back on automatically.

Steering wheel EASY-ENTRY/EXIT feature

Important safety notes

WARNING

When the EASY-ENTRY/EXIT feature adjusts the steering wheel and the driver's seat, you and other vehicle occupants – particularly children – could become trapped. There is a risk of injury.

While the EASY-ENTRY/EXIT feature is making adjustments, make sure that no one has any body parts in the sweep of the seat and the steering wheel.

If somebody becomes trapped:

- press one of the memory function position buttons, or
- press one of the memory function memory buttons, or
- move the switch for steering wheel adjustment in the opposite direction to that in which the steering wheel is moving

The adjustment process is stopped.

WARNING

If you drive off while the EASY-ENTRY/EXIT feature is making adjustments, you could lose control of the vehicle. There is a risk of an accident.

Always wait until the adjustment process is complete before driving off.

- ❗ Do not activate the EASY-ENTRY/EXIT feature, if the seat backrest is reclined too far backwards. This can damage the front or rear seats. You must first move the backrest to a vertical position.

The EASY-ENTRY/EXIT feature makes getting in and out of your vehicle easier.

You can activate and deactivate the EASY-ENTRY/EXIT feature in the on-board computer (▶ page 181).

Position of the steering wheel when the EASY-ENTRY/EXIT feature is active

The steering wheel moves upwards and towards the dashboard if:

- you remove the SmartKey from the ignition lock or
 - you open the driver's door with the SmartKey in position **0** or **1** in the ignition lock
- i** The steering wheel only moves upwards and towards the dashboard if it has not already reached the upper steering limiter.

Position of the steering wheel for driving

The steering wheel is moved to the last selected position when:

- the driver's door is closed
- you insert the SmartKey into the ignition lock

The last position of the steering column is stored when you switch off the ignition or when you store the setting with the memory function (▷ page 82).

Mirrors

Rear-view mirror

- ▶ Adjust the rear-view mirror by hand so you have a good overview of the traffic conditions behind you.

Exterior mirrors

Adjusting the exterior mirrors

WARNING

The exterior mirror on the front-passenger side reduces the size of the image. Visible objects are actually closer than they appear. This means that you could misjudge the distance from road users traveling behind, e.g. when changing lane. There is a risk of an accident.

For this reason, always make sure of the actual distance from the road users traveling behind by glancing over your shoulder.

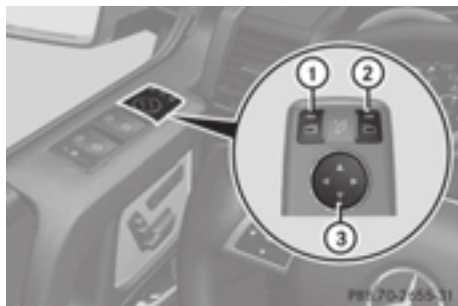

- ▶ Make sure that the SmartKey is in position **1** or **2** in the ignition lock (▷ page 112).
- ▶ Press button **1** to select the left-hand exterior mirror

or

- ▶ Press button **2** to select the right-hand exterior mirror.
- ▶ Press button **3** up, down, or to the left or right until you have adjusted the exterior mirror to the correct position. You should have a good overview of traffic conditions.

i The convex exterior mirrors provide a larger field of vision.

i The exterior mirrors are heated automatically if the rear window defroster is switched on and the outside temperature is low.

Folding the exterior mirrors in/out electrically



- ▶ Make sure that the SmartKey is in position **1** or **2** in the ignition lock (▷ page 112).

- ▶ Briefly press **1**. Both exterior mirrors fold in or out.

i Make sure that the exterior mirrors are always folded out fully while driving. They could otherwise vibrate.

i If you are driving faster than 9 mph (15 km/h), you can no longer fold in the exterior mirrors.

Setting the exterior mirrors



If the battery has been disconnected or completely discharged, the exterior mirrors must be reset. The exterior mirrors will otherwise not fold in when you select the "Fold in mirrors when locking" function in the on-board computer (▷ page 181).

- ▶ Make sure that the SmartKey is in position 1 in the ignition lock (▷ page 112).
- ▶ Briefly press ①.

Folding the exterior mirrors in/out automatically

If the "Fold in mirrors when locking" function is activated in the on-board computer (▷ page 181):

- the exterior mirrors fold in automatically as soon as you lock the vehicle from the outside.
- the exterior mirrors fold out again automatically as soon as you unlock the vehicle and then open the driver's or front-passenger door.

Exterior mirror pushed out of position

- ▶ Press button ① repeatedly until you hear the mirror engage in position.

The mirror housing is engaged again and you can adjust the exterior mirrors as usual (▷ page 80).

Automatic anti-glare mirrors

The rear-view mirror and the exterior mirror on the driver's side automatically go into anti-glare mode if:

- the ignition is switched on and
- incident light from headlamps strikes the sensor in the rear-view mirror

i The mirrors do not go into anti-glare mode if reverse gear is engaged or if the interior lighting is switched on.

Parking position for the exterior mirror on the front-passenger side

Setting/storing the parking position

Using reverse gear

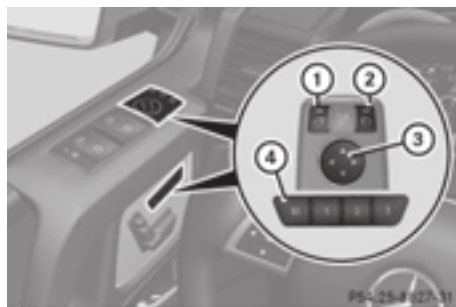

- ① Left-hand exterior mirror
- ② Right-hand exterior mirror
- ③ Adjustment button
- ④ Memory button

You can position the front-passenger side exterior mirror in such a way that you can see the rear wheel on that side as soon as you engage reverse gear. You can store this position.

- ▶ Make sure that the vehicle is stationary and that the SmartKey is in position 2 in the ignition lock (▷ page 112).
- ▶ Press button ② for the exterior mirror on the front-passenger side.
- ▶ Engage reverse gear.
The exterior mirror on the front-passenger side moves to the preset parking position.
- ▶ Use adjustment button ③ to adjust the exterior mirror to a position that allows you to see the rear wheel and the curb.
The parking position is stored.

- i** If you shift the transmission to another position, the exterior mirror on the front-passenger side returns to the driving position.

Using the memory button

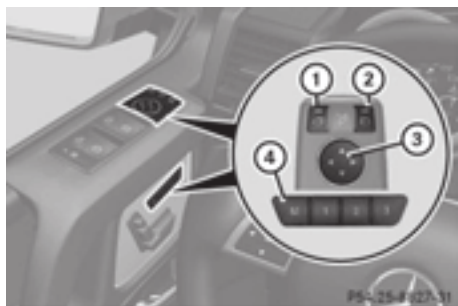

- ① Left-hand exterior mirror
- ② Right-hand exterior mirror
- ③ Adjustment button
- ④ Memory button

You can position the front-passenger side exterior mirror in such a way that you can see the rear wheel on that side as soon as you engage reverse gear. This setting can be stored using memory button **M** ④.

- ▶ Make sure that the SmartKey is in position **2** (▷ page 112) in the ignition lock.
- ▶ With the exterior mirror on the front-passenger side activated, use adjustment button ③ to adjust the exterior mirror. In the exterior mirror, the rear wheel and the curb should be visible.
- ▶ Press memory button **M** ④ and one of the arrows on adjustment button ③ within three seconds.
The parking position is stored if the exterior mirror does not move.
- ▶ If the mirror moves out of position, repeat the steps.

Calling up a stored parking position setting

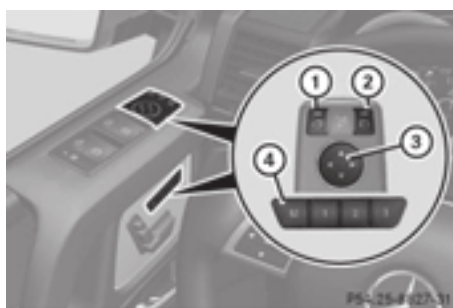

- ① Left-hand exterior mirror
- ② Right-hand exterior mirror
- ③ Adjustment button
- ④ Memory button

- ▶ Turn the SmartKey to position **2** (▷ page 112) in the ignition lock.
- ▶ Adjust the exterior mirror on the front-passenger side using button ②.
- ▶ Engage reverse gear.
The exterior mirror on the front-passenger side moves to the stored parking position.

The exterior mirror on the front-passenger side moves back to its original position:

- as soon as you exceed a speed of 9 mph (15 km/h)
- if you press button ① for the exterior mirror on the driver's side

Memory functions

Storing settings

WARNING

If you use the memory function on the driver's side while driving, you could lose control of the vehicle as a result of the adjustments being made. There is a risk of an accident.

Only use the memory function on the driver's side when the vehicle is stationary.

WARNING

When the memory function adjusts the seat or steering wheel, you and other vehicle occu-

pants – particularly children – could become trapped. There is a risk of injury.

While the memory function is making adjustments, make sure that no one has any body parts in the sweep of the seat or steering wheel. If somebody becomes trapped, immediately release the memory function position button. The adjustment process is stopped.

WARNING

Children could become trapped if they activate the memory function, particularly when unattended. There is a risk of injury.

When leaving the vehicle, always take the SmartKey with you and lock the vehicle. Never leave children unsupervised in the vehicle.

With the memory function, you can store up to three different settings, e.g. for three different people.

The following settings are stored as a single memory preset:

- position of the seat, backrest and head restraint
- driver's side: steering wheel position
- driver's side: position of the exterior mirrors on the driver's and front-passenger sides



- ▶ Make sure that the SmartKey is in position **2** (▷ page 112) or that the respective door is open.
- ▶ Adjust the seat (▷ page 74) and head restraint (▷ page 74).
- ▶ On the driver's side, adjust the steering wheel (▷ page 78) and the exterior mirrors (▷ page 80).

- ▶ Press the **M** memory button.
- ▶ Press one of memory buttons **1**, **2** or **3** within three seconds.
The settings are stored in the selected storage position.

Calling up a stored setting

- ❗ If you want to move the seat from the fully reclined position to a stored seat position, first raise the backrest using the seat switch. The seat could otherwise be damaged.
- ▶ Press and hold the relevant memory button **1**, **2** or **3**, until the seat, head restraints, steering wheel and mirrors are in the stored position.
- i The setting procedure is interrupted as soon as you release the memory button.

Useful information

- i** This Operator's Manual describes all models and all standard and optional equipment of your vehicle available at the time of publication of the Operator's Manual. Country-specific differences are possible. Please note that your vehicle may not be equipped with all features described. This also applies to safety-related systems and functions.
- i** Read the information on qualified specialist workshops: (▷ page 23).



Exterior lighting

Important safety notes





For reasons of safety, Mercedes-Benz recommends that you drive with the lights switched on even during the daytime. In some countries, operation of the headlamps varies due to legal requirements and self-imposed obligations.

Light switch

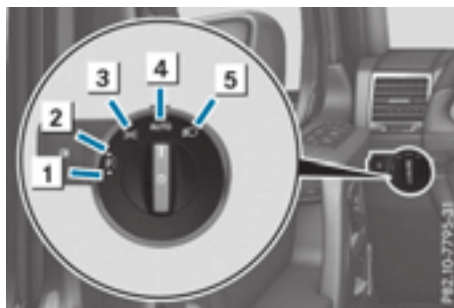
Operation

- !** Switch off the parking lamps and low-beam headlamps when you leave the vehicle. This prevents the battery from discharging.
- !** If the battery has been excessively discharged, the parking lamps or standing lamps are automatically switched off to enable the next engine start. Always park your vehicle safely and sufficiently lit according to legal standards. Avoid the continuous use of the  parking lamps for several hours. If possible, switch on the  right or the  left standing lamp.



- 1**  Left-hand standing lamps
- 2**  Right-hand standing lamps
- 3**  Parking lamps, side marker lamps, license plate and instrument cluster lighting
- 4** **AUTO** Automatic headlamp mode/daytime running lamps
- 5**  Low-beam/high-beam headlamps

If you hear a warning tone when you leave the vehicle, the lights may still be switched on.

► Turn the light switch to **AUTO**.



The turn signals, high-beam headlamps and the high-beam flasher are operated using the combination switch (▷ page 88).

The exterior lighting (except the parking/standing lamps) switches off automatically if you:

- remove the SmartKey from the ignition lock
- open the driver's door with the SmartKey in position **0** in the ignition lock.

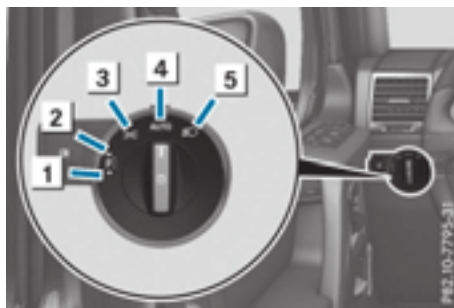
Low-beam headlamps





- 1**  Left-hand standing lamps
- 2**  Right-hand standing lamps
- 3**  Parking lamps, side marker lamps, license plate and instrument cluster lighting

4 **AUTO** Automatic headlamp mode/daytime running lamps

5  Low-beam/high-beam headlamps





► **To switch on the low-beam headlamps:** turn the SmartKey in the ignition lock to position **2** or start the engine.

► Turn the light switch to .
The  indicator lamp in the instrument cluster lights up.

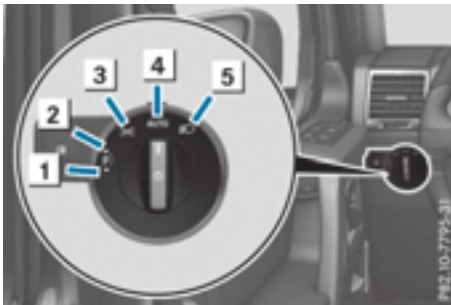
Daytime running lamps

Daytime running lamps in Canada



- 1  Left-hand standing lamps
- 2  Right-hand standing lamps
- 3  Parking lamps, side marker lamps, license plate and instrument cluster lighting
- 4 **AUTO** Automatic headlamp mode/daytime running lamps
- 5  Low-beam/high-beam headlamps

The daytime running lamps function is required by law in Canada. It cannot therefore be deactivated.

► Turn the light switch to **AUTO**.
With the engine running: depending on the ambient light, the daytime running lamps or the low-beam headlamps are switched on.
When the low-beam headlamps are switched on, the  indicator lamp in the instrument cluster lights up.

When the engine is running and the vehicle is stationary: if you move the selector lever from a drive position to **P**, the daytime running lamps/low-beam headlamps go out after three minutes.





When the engine is running, the vehicle is stationary and in bright ambient light: if you turn the

light switch to , the daytime running lamps and parking lamps switch on.

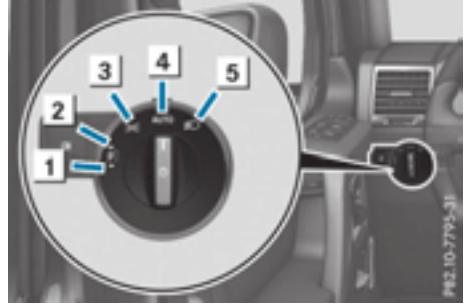
If the engine is running and you turn the light switch to , the manual settings take precedence over the daytime running lamps.

Daytime running lamps in the USA





- 1  Left-hand standing lamps
- 2  Right-hand standing lamps
- 3  Parking lamps, side marker lamps, license plate and instrument cluster lighting
- 4 **AUTO** Automatic headlamp mode/daytime running lamps
- 5  Low-beam/high-beam headlamps

In the USA, the daytime running lamps are deactivated upon delivery from the factory.

► **To activate the daytime running lamps:** activate the daytime running lamps function in the on-board computer (► page 179).

► Turn the light switch to **AUTO**.
With the engine running: depending on the ambient light, the daytime running lamps or the low-beam headlamps are switched on.

When the low-beam headlamps are switched on, the  indicator lamp in the instrument cluster lights up.

If the engine is running and you turn the light switch to  or , the manual settings take precedence over the daytime running lamps.

Automatic headlamp mode

WARNING

When the light switch is set to **AUTO**, the low-beam headlamps may not be switched on automatically if there is fog, snow or other causes of poor visibility due to the weather

conditions such as spray. There is a risk of an accident.

In such situations, turn the light switch to



The automatic headlamp feature is only an aid. The driver is responsible for the vehicle's lighting at all times.

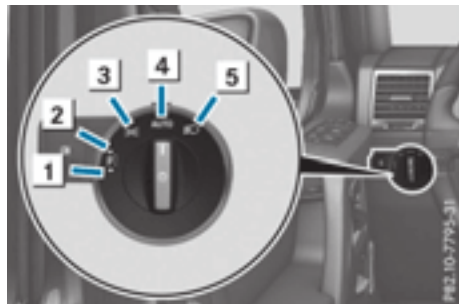

- 1 Left-hand standing lamps
- 2 Right-hand standing lamps
- 3 Parking lamps, side marker lamps, license plate and instrument cluster lighting
- 4 Automatic headlamp mode/daytime running lamps
- 5 Low-beam/high-beam headlamps

► **To switch on automatic headlamp mode:**

turn the light switch to . SmartKey in position 1 in the ignition lock: the parking lamps are switched on or off automatically depending on the brightness of the ambient light

With the engine running: if you have activated the daytime running lamps function in the on-board computer, the daytime running lamps or the low-beam headlamps are switched on or off automatically depending on the brightness of the ambient light.

When the low-beam headlamps are switched on, the indicator lamp in the instrument cluster lights up.

Rear fog lamp

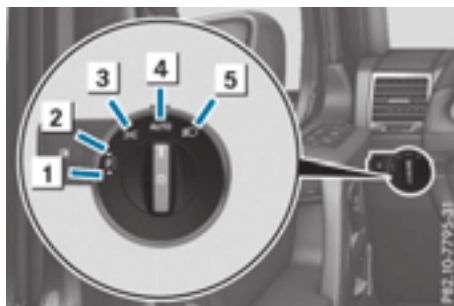

- 1 Left-hand standing lamps
- 2 Right-hand standing lamps
- 3 Parking lamps, side marker lamps, license plate and instrument cluster lighting
- 4 Automatic headlamp mode/daytime running lamps
- 5 Low-beam/high-beam headlamps
- 6 Rear fog lamp

► **To switch on the rear fog lamp:** turn the SmartKey in the ignition lock to position 2 or start the engine.

► Turn the light switch to or .

► Press the button. The yellow indicator lamp in the instrument cluster lights up.

► **To switch off the rear fog lamp:** press the button. The yellow indicator lamp in the instrument cluster goes out.

Parking lamps

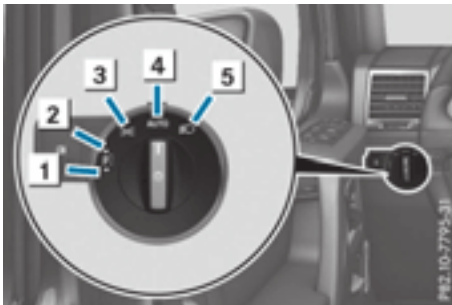

- 1 Left-hand standing lamps
- 2 Right-hand standing lamps
- 3 Parking lamps, side marker lamps, license plate and instrument cluster lighting
- 4 **AUTO** Automatic headlamp mode/daytime running lamps
- 5 Low-beam/high-beam headlamps
- 6 Rear fog lamp

► **To switch on:** turn the light switch to .

Standing lamps

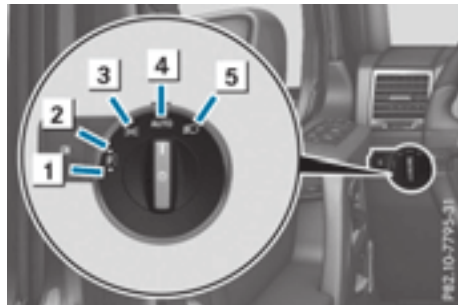

- 1 Left-hand standing lamps
- 2 Right-hand standing lamps
- 3 Parking lamps, side marker lamps, license plate and instrument cluster lighting
- 4 **AUTO** Automatic headlamp mode/daytime running lamps
- 5 Low-beam/high-beam headlamps
- 6 Rear fog lamp

Switching on the standing lamps ensures the corresponding side of the vehicle is illuminated.

► **To switch on the standing lamps:** the SmartKey should not be in the ignition lock or it should be in position 0 (▷ page 112).

► Turn the light switch to (left-hand side of the vehicle) or (right-hand side of the vehicle).

Headlamp cleaning system

The headlamps are cleaned automatically if the "Wipe with washer fluid" function is operated ten times while the lights are on and the engine is running (▷ page 96). When you switch off

the ignition, the automatic headlamp cleaning system is reset and counting is resumed from 0.

Combination switch

Turn signal

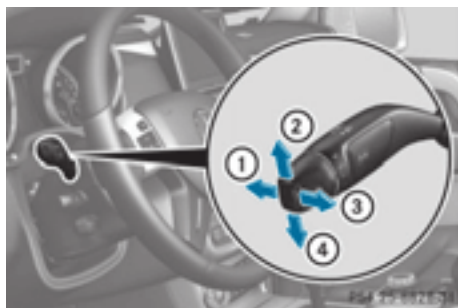

- ① High-beam headlamps
- ② Turn signal, right
- ③ High-beam flasher
- ④ Turn signal, left

- ▶ **To indicate briefly:** press the combination switch briefly to the pressure point in the direction of arrow ② or ④. The corresponding turn signal flashes three times.
- ▶ **To indicate:** press the combination switch beyond the pressure point in the direction of arrow ② or ④.

High-beam headlamps

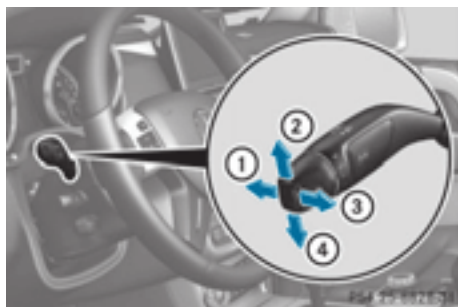

- ① High-beam headlamps
- ② Turn signal, right
- ③ High-beam flasher
- ④ Turn signal, left

- ▶ **To switch on the high-beam headlamps:** turn the SmartKey in the ignition lock to position 2 or start the engine.
- ▶ Turn the light switch to  or **AUTO**.
- ▶ Press the combination switch beyond the pressure point in the direction of arrow ①. In the **AUTO** position, the high-beam headlamps are only switched on when it is dark and the engine is running.

The blue  indicator lamp in the instrument cluster lights up when the high-beam headlamps are switched on.

- ▶ **To switch off the high-beam headlamps:** move the combination switch back to its normal position. The blue  indicator lamp in the instrument cluster goes out.

High-beam flasher

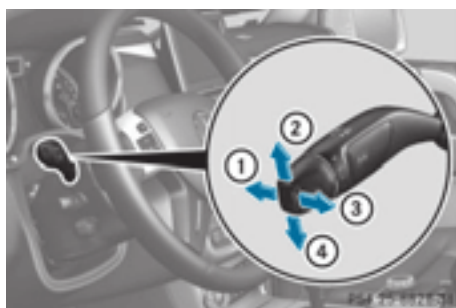

- ① High-beam headlamps
- ② Turn signal, right
- ③ High-beam flasher
- ④ Turn signal, left

- ▶ **To switch on:** turn the SmartKey in the ignition lock to position 1 or 2, or start the engine.
- ▶ Pull the combination switch briefly in the direction of arrow ③.

Hazard warning lamps



- ▶ **To switch on the hazard warning lamps:** press button ①. All turn signals flash. If you now switch on a turn signal using the combination switch, only the turn signal lamp on the corresponding side of the vehicle will flash.
- ▶ **To switch off the hazard warning lamps:** press button ①.

The hazard warning lamps automatically switch on if:

- an air bag is deployed or
- the Emergency Tensioning Devices are triggered, or
- the vehicle decelerates rapidly from a speed of above 45 mph (70 km/h) and comes to a standstill

The hazard warning lamps switch on automatically if an air bag or the Emergency Tensioning Devices are triggered and the SmartKey is in position 1 in the ignition lock.

The hazard warning lamps switch off automatically if the vehicle reaches a speed of above 6 mph (10 km/h) again after a full brake application.

- ❗ The hazard warning lamps still operate if the ignition is switched off.

Headlamps and indicator lamps fogged up on the inside

The headlamps and the indicator lamps in the exterior mirrors may fog up on the inside if there is high atmospheric humidity.

- ▶ Drive with the headlamps switched on. The level of moisture diminishes, depending on the length of the journey and the weather conditions (humidity and temperature).

If the level of moisture does not diminish:

- ▶ Have the headlamps checked at a qualified specialist workshop.

Interior lighting

Overview of interior lighting



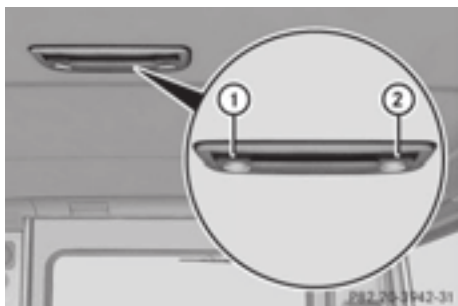

Front overhead control panel

- ① Switches the left-hand front reading lamp on/off
- ② Switches the front interior lighting on
- ③ Switches the cargo compartment lamp/rear compartment lighting on/off
- ④ Switches the front interior lighting/automatic interior lighting control off
- ⑤ Switches the right-hand reading lamp on/off
- ⑥ Switches the automatic interior lighting control on



Rear-compartment overhead control panel

- ①  Switches the right-hand reading lamp on/off
- ②  Switches the left-hand reading lamp on/off

Interior lighting control

General notes



The interior lighting functions are automatically deactivated after some time except for when the SmartKey is in position **2** in the ignition lock. This prevents your vehicle's battery from discharging.



The brightness of the ambient lighting may be set using the control on the instrument cluster (> page 171).

Automatic interior lighting control



Front overhead control panel

- ①  Switches the left-hand front reading lamp on/off
- ②  Switches the front interior lighting on
- ③  Switches the cargo compartment lamp/rear compartment lighting on/off

- ④  Switches the front interior lighting/automatic interior lighting control off
- ⑤  Switches the right-hand front reading lamp on/off
- ⑥ Switches the automatic interior lighting control on

► **To switch on:** move switch ⑥ to the center position.

The interior lighting switches on automatically when it is dark if you:

- unlock the vehicle
- open a door
- remove the SmartKey from the ignition lock

► **To switch off:** press the  symbol on switch ⑥.

The interior lighting remains switched off even when it is dark if you:

- unlock the vehicle
- open a door.
- remove the SmartKey from the ignition lock.

The interior light is activated for a short while when the SmartKey is removed from the ignition lock. You can activate this delayed switch-off using the on-board computer (> page 180).

When a front door is opened, the front interior lighting comes on. When a rear door is opened, the rear interior lighting comes on. In addition, the courtesy lights come on.

i If a door remains open and the SmartKey is not in the ignition lock, the interior lighting switches off after a short while.

Manual interior lighting control

Front interior lighting

! If the interior lighting has been switched on manually, it will not be switched off automatically.

This can cause the starter battery to discharge.

Make sure that the interior lighting does not remain switched on too long after the engine has been switched off.



Front overhead control panel

- ① Switches the left-hand front reading lamp on/off
- ② Switches the front interior lighting on
- ③ Switches the cargo compartment lamp/rear compartment lighting on/off
- ④ Switches the front interior lighting/automatic interior lighting control off
- ⑤ Switches the right-hand front reading lamp on/off
- ⑥ Switches the automatic interior lighting control on

► **To switch on:** press the symbol on switch ⑥.

► **To switch off:** set switch ⑥ to the center position.

Reading lamps



Front overhead control panel

- ① Switches the left-hand front reading lamp on/off
- ② Switches the front interior lighting on
- ③ Switches the cargo compartment lamp/rear compartment lighting on/off
- ④ Switches the front interior lighting/automatic interior lighting control off

- ⑤ Switches the right-hand front reading lamp on/off
- ⑥ Switches the automatic interior lighting control on

► **To switch on/off:** press the button.

Cargo compartment lamp

WARNING

Combustion engines emit poisonous exhaust gases such as carbon monoxide. If the rear door is open when the engine is running, particularly if the vehicle is moving, exhaust fumes could enter the passenger compartment. There is a risk of poisoning.

Turn off the engine before opening the rear door. Never drive with the rear door open.

! Switch off the cargo compartment lamp if you wish to leave the rear door open for a longer period. The battery may otherwise discharge.

! Do not close the rear door while lock ① is engaged at the bottom. Otherwise, you could damage lock ①.



Front overhead control panel

- ① Switches the left-hand front reading lamp on/off
- ② Switches the front interior lighting on
- ③ Switches the cargo compartment lamp/rear compartment lighting on/off
- ④ Switches the front interior lighting/automatic interior lighting control off
- ⑤ Switches the right-hand front reading lamp on/off
- ⑥ Switches the automatic interior lighting control on

► **To switch on/off:** press the  button.

i If you open the rear door, the cargo compartment lamp comes on. You will then be unable to switch it off using the  button.

Switch off the cargo compartment lamp if you wish to leave the rear door open for a longer period. This prevents the battery from discharging.



► Open the rear door.

► **To switch off with the rear door open:** press lock **1** down in the direction of the arrow until it engages.





The cargo compartment lamp is switched off.

► **To switch on with the rear door open:** press lock cylinder **2** on the door handle. The cargo compartment lamp resumes its normal function.

Rear compartment lighting





Front overhead control panel

- 1**  Switches the left-hand front reading lamp on/off
- 2**  Switches the front interior lighting on
- 3**  Switches the cargo compartment lamp/rear compartment lighting on/off
- 4**  Switches the front interior lighting/automatic interior lighting control off

5  Switches the right-hand reading lamp on/off

6  Switches the automatic interior lighting control on

► **To switch on/off:** press the  button.

i The rear compartment lighting switches on when you open a rear door. You will then be unable to switch it off using the  button.

If you leave the rear doors open for a long time, switch the rear compartment lighting off. This prevents the battery from discharging.

Replacing bulbs

Important safety notes

DANGER

Xenon bulbs carry a high voltage. You can get an electric shock if you remove the cover of the Xenon bulb and touch the electrical contacts. There is a risk of fatal injury.

Never touch the parts or the electrical contacts of the Xenon bulb. Always have work on the Xenon bulbs carried out at a qualified specialist workshop.

WARNING

Bulbs, lamps and connectors can get very hot when operating. If you change a bulb, you could burn yourself on these components. There is a risk of injury.

Allow these components to cool down before changing a bulb.

Do not use a bulb that has been dropped or if its glass tube has been scratched.

The bulb may explode if:

- you touch it
- it is hot
- you drop it
- you scratch it

Only operate bulbs in enclosed lamps designed for that purpose. Only install spare bulbs of the same type and the specified voltage.

Marks on the glass tube reduce the service life of the bulbs. Do not touch the glass tube with your bare hands. If necessary, clean the glass

tube when cold with alcohol or spirit and rub it off with a lint-free cloth.

Protect bulbs from moisture during operation. Do not allow bulbs to come into contact with liquids.

Xenon bulbs

Bulbs and lamps are an important aspect of vehicle safety. You must therefore make sure that these function correctly at all times. Have the headlamp setting checked regularly.

LED modules

You can replace neither Xenon bulbs nor LED bulbs. Have LED modules replaced at a qualified specialist workshop.

Bulbs and lamps are an important aspect of vehicle safety. You must therefore make sure that these function correctly at all times. Have the headlamp setting checked regularly.

Before changing bulbs

Have the following bulbs replaced at a qualified specialist workshop:

- Additional turn signals in the exterior mirrors
- High-mounted brake lamp
- High-beam/low-beam headlamps (Xenon bulbs)
- Daytime running lamps
- Parking lamps/standing lamps
- License plate lamp

i Individual segments of the license plate lamp LEDs may fail without a display message appearing in the multifunction display. Regularly check the license plate lamp. If necessary, visit a qualified specialist workshop.

You can replace the following bulbs:

- Turn signal lamp (front)
- Brake/tail lamp
- Turn signal lamp (rear)
- Tail lamps/standing lamps
- Backup Light
- Rear fog lamp
- Side marker lamps

Other bulbs

There are bulbs other than the Xenon bulbs that you cannot replace yourself. Only replace the bulbs listed (▷ page 93). Have the bulbs that you cannot replace yourself replaced at a qualified specialist workshop.

If you require assistance replacing bulbs, consult a qualified specialist workshop.

Do not touch the glass tube of new bulbs with your bare hands. Even minor contamination can burn into the glass surface and reduce the service life of the bulbs. Always use a lint-free cloth or only touch the base of the bulb when installing.

Only use bulbs of the correct type.

If the new bulb still does not light up, consult a qualified specialist workshop.

Bulbs and lamps are an important aspect of vehicle safety. You must therefore make sure that these function correctly at all times. Have the headlamp setting checked regularly.

Overview: changing bulbs/bulb types

Front bulbs

You can replace the following bulbs. The bulb type can be found in the legend.



- ① Turn signal lamp: 1156 NA
- ② Side marker lamp: T 4 W

Rear bulbs

You can replace the following bulbs. The bulb type can be found in the legend.

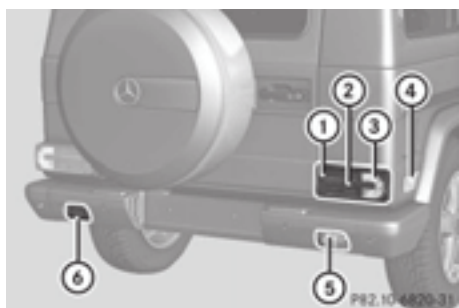

- ① Tail lamp/standing lamp: W 5 W
- ② Brake lamp/tail lamp: P 21/5 W
- ③ Turn signal lamp: PY 21 W
- ④ Side marker lamp: T 4 W
- ⑤ Backup lamp: P 21 W
- ⑥ Rear fog lamp: P 21 W

Changing the front bulbs

Turn signal

❗ Make sure that the protective grille does not hit any painted surfaces.

You could otherwise damage the paintwork.

❗ Do not fasten the screws too tightly. You could otherwise damage the lens.

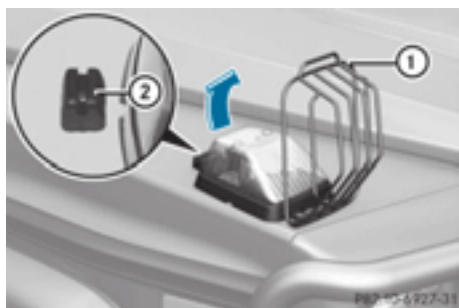

Turn signal lamp with protection grille (AMG vehicles)

- ▶ Switch off the lights.
- ▶ **AMG vehicles:** pull protection grille ① in the direction of the arrow out of mounting ②.
- ▶ Fold up protection grille ①.



Example: turn signal lamp

- ▶ Switch off the lights.
- ▶ Unscrew screws ③.
- ▶ Remove lens ④.

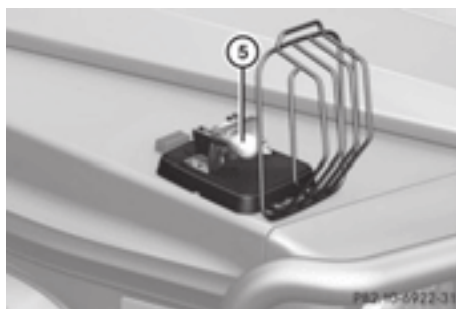

Example: turn signal lamp

- ▶ Turn bulb ⑤ counter-clockwise, applying slight pressure, and remove it from the bulb holder.
- ▶ Insert the new bulb into the bulb holder and, applying slight pressure, turn it clockwise until it engages.
- ▶ Install lens ④.
- ▶ Replace and tighten screws ③.
- ▶ **AMG vehicles:** fold down protection grille ① and allow it to engage in mounting ②.

Side marker lamps

❗ Do not fasten the screws too tightly. You could otherwise damage the lens.

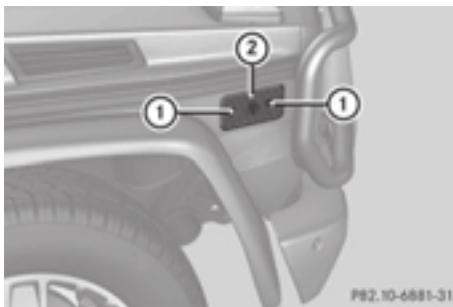

Front side marker lamp (example)

The bulbs of the front and rear side marker lamps are changed in the same way.

- ▶ Switch off the lights.
- ▶ Unscrew screws ①.
- ▶ Remove housing ②.

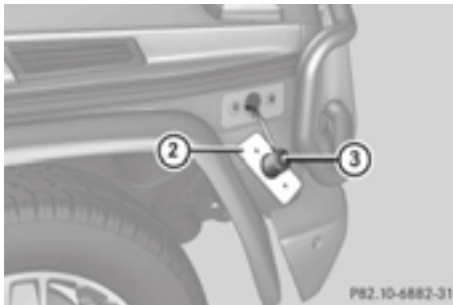

- ▶ Remove dust cover ③.
- ▶ Push the catch to the side and pull the bulb holder with the bulb out of housing ②.

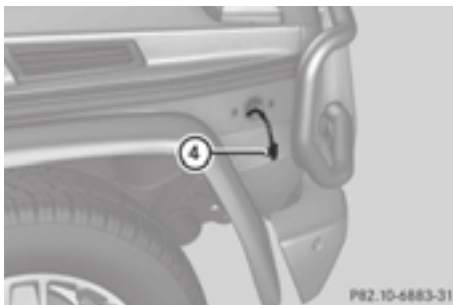

- ▶ Lightly press bulb ④, turn it counter-clockwise and pull it out.
- ▶ Insert the new bulb and, applying slight pressure, turn it clockwise until it engages.
- ▶ Insert the bulb holder into housing ②.

- ▶ Attach dust cover ③.
- ▶ Insert housing ②.
- ▶ Replace and tighten screws ①.

Changing the rear bulbs

Protection grille (AMG vehicles)

! Make sure that the protective grille does not hit any painted surfaces.

You could otherwise damage the paintwork.

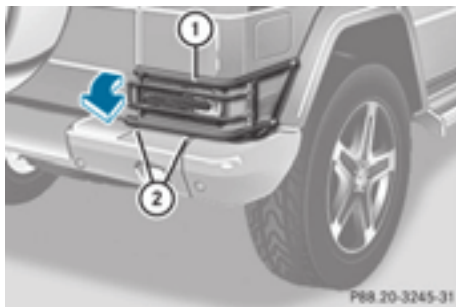

Protection grille (AMG vehicles)

You must remove the protective grille before you can change the bulbs in the tail lamps.

- ▶ Unscrew screws ②.
- ▶ Swing protection grille ① to the right.
- ▶ After changing the bulbs, swing protection grille ① to the left.
- ▶ Tighten screws ②.

Tail lamps

! When installing the lens, make sure that the seal is positioned correctly.

! Do not fasten the screws too tightly. You could otherwise damage the lens.

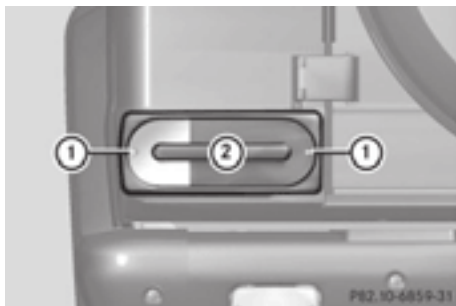

- ▶ Switch off the lights.
- ▶ Unscrew screws ①.
- ▶ Remove lens ②.



- ③ Turn signal
- ④ Brake/tail lamp
- ⑤ Tail lamps/standing lamps

- ▶ Turn the corresponding bulb counter-clockwise, applying slight pressure, and remove it from the bulb holder.
- ▶ Insert the new bulb into the bulb holder and, applying slight pressure, turn it clockwise until it engages.
- ▶ Install lens ②.
- ▶ Replace and tighten screws ①.
- ▶ **AMG vehicles:** secure the protection grille (> page 95).

Backup lamp/rear fog lamp

- ❗ Do not fasten the screws too tightly. You could otherwise damage the lens.

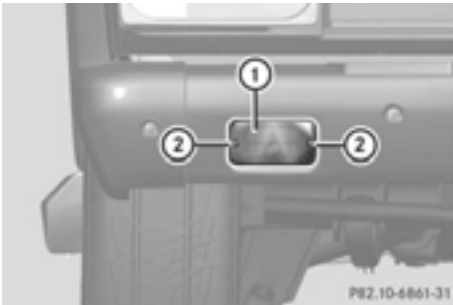

Example: rear fog lamp

- ▶ Switch off the lights.
- ▶ Unscrew screws ②.
- ▶ Remove lens ①.



- ▶ Turn bulb ③ counter-clockwise, applying slight pressure, and remove it from the bulb holder.
- ▶ Insert the new bulb into the bulb holder and, applying slight pressure, turn it clockwise until it engages.
- ▶ Install lens ①.
- ▶ Replace and tighten screws ②.

Windshield wipers

Switching the windshield wipers on/off

- ❗ Do not operate the windshield wipers when the windshield is dry, as this could damage the wiper blades. Moreover, dust that has collected on the windshield/rear window can scratch the glass if wiping takes place when the windshield/rear window is dry.

If it is necessary to switch on the windshield wipers in dry weather conditions, always use washer fluid when operating the windshield wipers.

- ❗ If the windshield wipers leave smears on the windshield/rear window after the vehicle has been washed in an automatic car wash, this may be due to wax or other residue. Clean the windshield/rear window with washer fluid after an automatic car wash.

- ❗ Intermittent wiping with rain sensor: due to optical influences and the windshield becoming dirty in dry weather conditions, the windshield wipers may be activated inadvertently. This could then damage the windshield wiper blades or scratch the windshield.

For this reason, you should always switch off the windshield wipers in dry weather.

If the wiper blades are worn, the windshield will no longer be wiped properly. This could prevent you from observing the traffic conditions, thereby causing an accident.

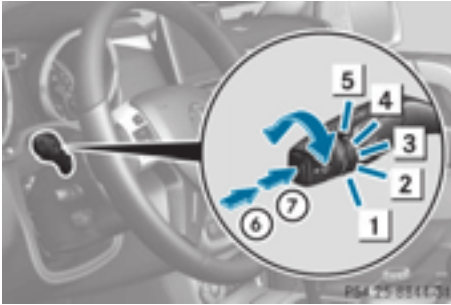

Combination switch

- 1 Windshield wipers off
- 2 Intermittent wipe, low (rain sensor set to low sensitivity)
- 3 Intermittent wipe, high (rain sensor set to high sensitivity)
- 4 Continuous wipe, slow
- 5 Continuous wipe, fast
- 6 Single wipe
- 7 To wipe with washer fluid

- ▶ Switch on the ignition.
- ▶ Turn the combination switch to the corresponding position.

Intermittent wiping is interrupted if you stop the vehicle and open a front door. This protects people getting into and out of the vehicle from being sprayed with water.

Intermittent wiping continues when all doors are closed and:

- you shift the automatic transmission to drive position **D** or reverse gear **R**
or
- you change the wipe setting on the combination switch.

In the or position, the appropriate wiping frequency is set automatically according to the intensity of the rain. In the position, the rain sensor is more sensitive than in the position, causing the windshield wipers to wipe more frequently.

Switching the rear window wiper on/off

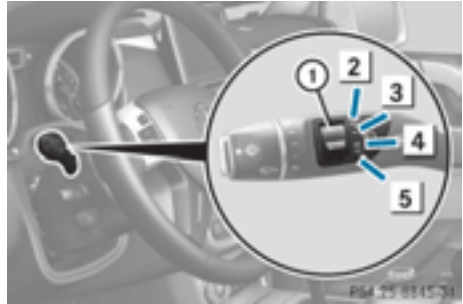

Combination switch

- 1 Switch
- 2 Wipes with washer fluid
- 3 Switches on intermittent wiping
- 4 Switches off intermittent wiping
- 5 Wipes with washer fluid

- ▶ Turn the SmartKey to position **1** or **2** in the ignition lock.
- ▶ Turn switch 1 on the combination switch to the corresponding position. When the rear window wiper is switched on, the icon appears in the instrument cluster.

- ❗ The rear window wiper comes on automatically if you shift the selector lever to **R** while the windshield wiper are on.

Replacing the wiper blades

Important safety notes

WARNING

If the windshield wipers begin to move while you are changing the wiper blades, you could be trapped by the wiper arm. There is a risk of injury.

Always switch off the windshield wipers and ignition before changing the wiper blades.

- ❗ To avoid damaging the wiper blades, make sure that you touch only the wiper arm of the wiper.
- ❗ Never open the hood if a windshield wiper arm has been folded away from the windshield.

Never fold a windshield wiper arm without a wiper blade back onto the windshield/rear window.

Hold the windshield wiper arm firmly when you change the wiper blade. If you release the windshield wiper arm without a wiper blade and it falls onto the windshield, the windshield may be damaged by the force of the impact.

Mercedes-Benz recommends that you have the wiper blades changed at a qualified specialist workshop.

Removing the wiper blades

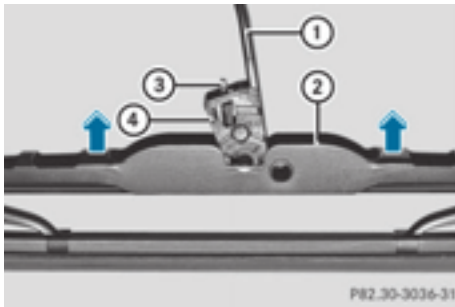

- ① Windshield wiper arm
- ② Wiper blade
- ③ Locking spring
- ④ Hinge piece

- ▶ Remove the SmartKey from the ignition lock.
- ▶ Fold wiper arm ① away from the windshield until it engages.
- ▶ Position wiper blade ② horizontally.
- ▶ Press locking spring ③.
- ▶ Slide wiper blade ② with hinge piece ④ from wiper arm ①.

Installing the wiper blade

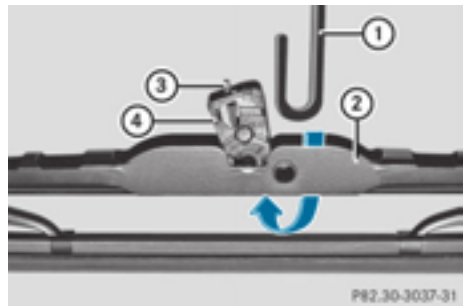

- ① Windshield wiper arm
- ② Wiper blade
- ③ Locking spring
- ④ Hinge piece

- ▶ Slide wiper arm ① into new wiper blade ② with hinge piece ④.
- ▶ Engage locking spring ③ into the end of the wiper arm.
- ▶ Make sure that wiper blade ② is seated correctly.
- ▶ Fold wiper arm ① back onto the windshield.

Problems with the windshield wipers

The windshield wipers are obstructed

Leaves or snow, for example, may be obstructing the windshield wiper movement. The wiper motor has been deactivated.

- ▶ For safety reasons, you should remove the SmartKey from the ignition lock.
- ▶ Remove the cause of the obstruction.
- ▶ Switch the windshield wipers back on.

The windshield wipers are inoperative

The windshield wiper drive is malfunctioning.

- ▶ Select another wiper speed on the combination switch.
- ▶ Have the windshield wipers checked at a qualified specialist workshop.

Useful information

- i** This Operator's Manual describes all models and all standard and optional equipment of your vehicle available at the time of publication of the Operator's Manual. Country-specific differences are possible. Please note that your vehicle may not be equipped with all features described. This also applies to safety-related systems and functions.
- i** Read the information on qualified specialist workshops: (▷ page 23).

Overview of climate control systems

Important safety notes

Observe the settings recommended on the following pages. The windows could otherwise fog up. This could prevent you from observing the traffic conditions, thereby causing an accident.

Climate control regulates the temperature and the humidity in the vehicle interior and filters undesirable substances from the air.

Dual-zone automatic climate control is only operational when the engine is running. Optimum operation is only achieved if you drive with the side windows and sliding sunroof closed.

The climatic comfort deteriorates whilst the sliding sunroof is open. The automatic climate control cannot maintain the set temperature with the sliding sunroof open. You have to adjust the climate control manually.

- i** The residual heat function can only be activated or deactivated with the ignition switched off (▷ page 108).
- i** Ventilate the vehicle for a brief period during warm weather, e.g. using the convenience opening feature (▷ page 68). This will speed up the cooling process and the desired vehicle interior temperature will be reached more quickly.
- i** The integrated filter can filter out most particles of dust, and completely filters out pollen. A clogged filter reduces the amount of air supplied to the vehicle interior. For this reason, you should always observe the interval for replacing the filter, which is specified in the Maintenance Booklet. As it depends on environmental conditions, e.g. heavy air pol-

lution, the interval may be shorter than stated in the Maintenance Booklet.

Control panel for dual-zone automatic climate control

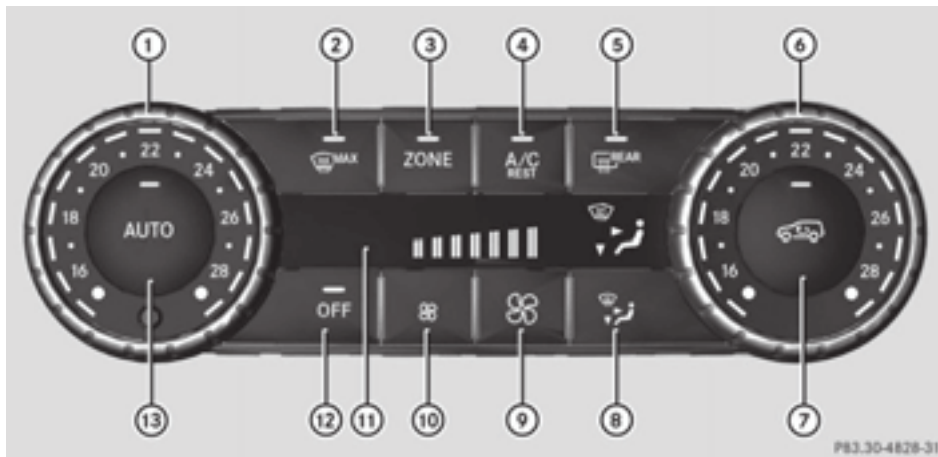

Canada only

- ① Sets the temperature, left (▷ page 105)
- ② Defrosts the windshield (▷ page 105)
- ③ Switches the ZONE function on/off (▷ page 105)
- ④ Switches cooling with air dehumidification on/off (▷ page 103)
- ⑤ Switches the rear window defroster on/off (▷ page 107)
- ⑥ Sets the temperature, right (▷ page 105)
- ⑦ Activates/deactivates air-recirculation mode (▷ page 107)
- ⑧ Sets the air distribution (▷ page 105)
- ⑨ Increases the airflow (▷ page 105)
- ⑩ Reduces the airflow (▷ page 105)
- ⑪ Display
- ⑫ Switches climate control on/off (▷ page 102)
- ⑬ Sets climate control to automatic (▷ page 105)

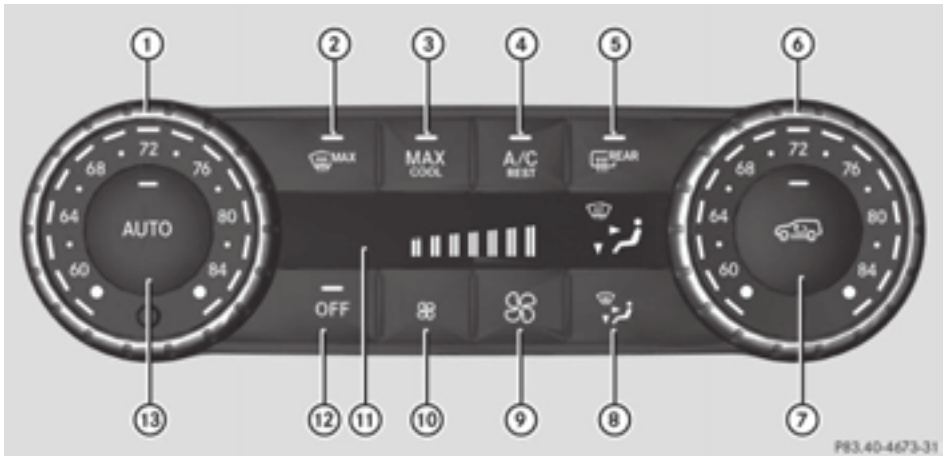

USA only

- ① Sets the temperature, left (▷ page 105)
- ② Defrosts the windshield (▷ page 105)
- ③ Switches maximum cooling on/off (▷ page 106)
- ④ Switches cooling with air dehumidification on/off (▷ page 103)
- ⑤ Switches the rear window defroster on/off (▷ page 107)
- ⑥ Sets the temperature, right (▷ page 105)
- ⑦ Activates/deactivates air-recirculation mode (▷ page 107)
- ⑧ Sets the air distribution (▷ page 105)
- ⑨ Increases the airflow (▷ page 105)
- ⑩ Reduces the airflow (▷ page 105)
- ⑪ Display
- ⑫ Switches climate control on/off (▷ page 102)
- ⑬ Sets climate control to automatic (▷ page 105)

Optimum use of dual-zone climate control

The following contains notes and recommendations on optimum use of dual-zone climate control.

- Activate climate control using the **AUTO** and **A/C REST** buttons. The indicator lamps in the **AUTO** and **A/C REST** buttons light up.
- Set the temperature to 72 °F (22 °C).
- Only use the defrosting function briefly until the windshield is clear again.
- Only use air-recirculation mode briefly, e.g. if there are unpleasant outside odors or when in a tunnel. The windows could otherwise fog up,

since no fresh air is drawn into the vehicle in air-recirculation mode.

- Use the ZONE function to adopt the temperature settings on the driver's side for the front-passenger side as well. The indicator lamp in the **ZONE** button goes out.

Operating the climate control systems

Switching climate control on/off

Points to observe before use

WARNING

When the climate control system is deactivated, the outside air supply and circulation are also deactivated. Only choose this setting for a short time. Otherwise the windows could fog up, impairing visibility and endangering you and others.

Switching climate control on/off

- ▶ Turn the SmartKey to position **2** in the ignition lock (> page 112).
- ▶ **To switch on:** press the **AUTO** button.
The indicator lamp in the **AUTO** button lights up. Airflow and air distribution are set to automatic mode.

or

- ▶ Press the **OFF** button.
The indicator lamp in the **OFF** button goes out. The previously selected settings are restored.
- ▶ **To switch off:** press the **OFF** button.
The indicator lamp in the **OFF** button lights up.

Activating/deactivating cooling with air dehumidification

General notes

If you deactivate the "Cooling with air-dehumidification" function, the air inside the vehicle will not be cooled. The air inside the vehicle will also not be dehumidified. The windows can fog up more quickly. Therefore, only deactivate the "Cooling with air-dehumidification" function briefly.

The "Cooling with air dehumidification" function is only available when the engine is running.

The air inside the vehicle is cooled and dehumidified according to the temperature selected.

Condensation may drip from the underside of the vehicle when it is in cooling mode. This is normal and not a sign that there is a malfunction.

Switching cooling with air dehumidification on/off

! If the cooling with air dehumidification does not switch on, it is possible that the climate control system has lost coolant.

Have the cooling with air dehumidification checked at a qualified specialist workshop.

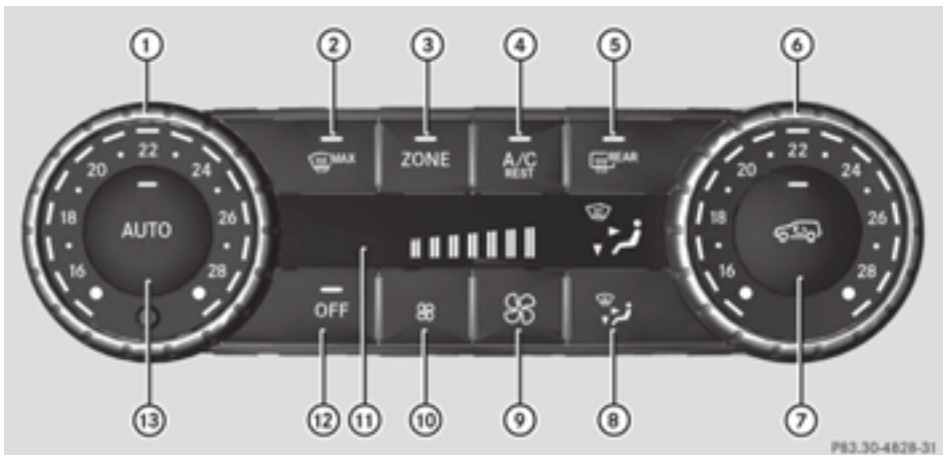

Canada only

- ① Sets the temperature, left (▷ page 105)
- ② Defrosts the windshield (▷ page 105)
- ③ Switches the ZONE function on/off (▷ page 105)
- ④ Switches cooling with air dehumidification on/off (▷ page 103)
- ⑤ Switches the rear window defroster on/off (▷ page 107)
- ⑥ Sets the temperature, right (▷ page 105)
- ⑦ Activates/deactivates air-recirculation mode (▷ page 107)
- ⑧ Sets the air distribution (▷ page 105)
- ⑨ Increases the airflow (▷ page 105)
- ⑩ Reduces the airflow (▷ page 105)
- ⑪ Display
- ⑫ Switches climate control on/off (▷ page 102)
- ⑬ Sets climate control to automatic (▷ page 105)

- **To activate:** press the  button.

The indicator lamp in the  button lights up.

- **To deactivate:** press the  button.

The indicator lamp in the  button goes out. The "Cooling with air dehumidification" function has a delayed switch-off feature.

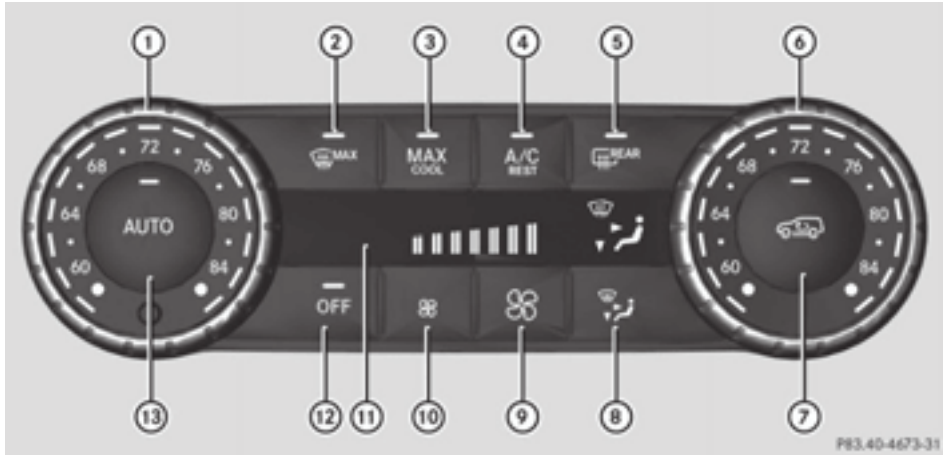

USA only

- ① Sets the temperature, left (▷ page 105)
- ② Defrosts the windshield (▷ page 105)
- ③ Switches maximum cooling on/off (▷ page 106)
- ④ Switches cooling with air dehumidification on/off (▷ page 103)
- ⑤ Switches the rear window defroster on/off (▷ page 107)
- ⑥ Sets the temperature, right (▷ page 105)
- ⑦ Activates/deactivates air-recirculation mode (▷ page 107)
- ⑧ Sets the air distribution (▷ page 105)
- ⑨ Increases the airflow (▷ page 105)
- ⑩ Reduces the airflow (▷ page 105)
- ⑪ Display
- ⑫ Switches climate control on/off (▷ page 102)
- ⑬ Sets climate control to automatic (▷ page 105)

- **To activate:** press the  button.

The indicator lamp in the  button lights up.

- **To deactivate:** press the  button.

The indicator lamp in the  button goes out. The "Cooling with air dehumidification" function has a delayed switch-off feature.

Problems with the "Cooling with air dehumidification" function

When you press the  button, the indicator lamp in the button flashes three times or remains off. You can no longer switch on the "Cooling with air dehumidification" function.







- Visit a qualified specialist workshop.

Setting climate control to automatic



WARNING



If you switch off the cooling function, the vehicle will not be cooled when weather conditions are warm. The windows can fog up more quickly. Window fogging may impair visibility and endanger you and others.

In automatic mode, the set temperature is maintained at a constant level. The system automatically regulates the temperature of the dispersed air, the airflow and the air distribution. Automatic mode will achieve optimal operation if cooling with air dehumidification is also activated. If desired, cooling with air dehumidification can be deactivated.

- ▶ Turn the SmartKey to position **2** (▷ page 112) in the ignition lock.
 - ▶ Set the desired temperature.
 - ▶ **To switch on:** press the  button. The indicator lamp in the  button lights up. Automatic air distribution and airflow are activated.
 - ▶ **To deactivate:** press the  button.
- or
- ▶ Press the  or  button. The indicator lamp in the  button goes out.







Setting the temperature

You can set the temperature separately for the driver's and front-passenger sides with controls  or  (▷ page 100).



- ▶ Turn the SmartKey to position **2** in the ignition lock (▷ page 112).
- ▶ Set control  or  (▷ page 100) to the desired temperature. Only change the temperature setting in small increments. Start at 72 °F (22 °C).

Setting the air distribution







- ▶ Turn the SmartKey to position **2** (▷ page 112) in the ignition lock.
- ▶ Press the  button repeatedly until the desired symbol appears in the display.

-  Directs the airflow through the center vents
-  Directs the airflow through the footwell air vents
-  Directs the airflow through the center and footwell vents
-  Directs air through the defroster vents
-  **Canada only:** directs the airflow through the defroster and center vents
-  Directs air through the defroster and footwell vents
-  **Canada only:** directs the airflow through the defroster, center and side air vents and the footwell

Setting the airflow

- ▶ Turn the SmartKey to position **2** in the ignition lock (▷ page 112).
 - ▶ **To increase:** press the  button.
 - ▶ **To reduce:** press the  button.
-  The airflow from the rear-compartment vents and the center vents is the same.

Switching the ZONE function on/off



- ▶ **To switch on:** press the  button. The indicator lamp in the  button lights up.
-  The temperature setting for the driver's side is not adopted for the front-passenger side and the rear compartment. The temperature for the front-passenger side and the rear compartment must be set separately.
- ▶ **To switch off:** press button . The indicator lamp in the  button goes out.
-  The temperature setting for the driver's side is adopted for the front-passenger side and the rear compartment.

Defrosting the windshield

You can use this function to defrost the windshield or to defrost the inside of the windshield and the side windows.



-  You should only select the defrosting function until the windshield is clear again.

▶ Turn the SmartKey to position **2** (▷ page 112) in the ignition lock.



▶ **To activate:** press the  button. The indicator lamp in the  button lights up.

The climate control system switches to the following functions:



- cooling with air dehumidification (only with engine running)
- high airflow (depending on the outside temperature)
- high temperature (depending on the outside temperature)
- air distribution to the windshield and front side windows
- air-recirculation mode off

▶ **To deactivate:** press the  button. The indicator lamp in the  button goes out. The previously selected settings are restored. The cooling with air dehumidification function remains on. Air-recirculation mode remains deactivated.

or

▶ Press the  button. The indicator lamp in the  button goes out. Airflow and air distribution are set to automatic mode.

or

▶ Turn controls  or  clockwise or counter-clockwise (▷ page 100).

or

▶ Press the  or  button.

Activating/deactivating MAX COOL maximum cooling

The MAX COOL function is only available in vehicles for the USA.



MAX COOL is only operational when the engine is running.

▶ **To activate:** press the  button. The indicator lamp in the button lights up.

▶ **To activate:** press off-road button  again. The indicator lamp goes out. The previously selected settings are restored.

When you activate MAX COOL, climate control switches to the following functions:

- maximum cooling
- maximum airflow
- air-recirculation mode on

Defrosting the windows

Windows fogged up on the inside

▶ Activate the  cooling with air dehumidification function.



▶ Activate automatic mode .

▶ If the windows continue to fog up, activate the defrosting function (▷ page 105).

 You should only select this setting until the windshield is clear again.

Windows fogged up on the outside

▶ Switch on the windshield wipers (▷ page 96).

▶ Press the  button repeatedly until the  or  symbol appears in the display.

 You should only select this setting until the windshield is clear again.

Switching the windshield defroster on/off

WARNING



Any accumulation of snow and ice should be removed from the windshield before driving. Otherwise, your vision may be impaired, which could endanger you or others.



- ▶ Turn the SmartKey to position **2** in the ignition lock (▷ page 112).
 - ▶ **To switch on:** press button ②.
Indicator lamp ① lights up.
 - ▶ **To switch off:** press button ②.
Indicator lamp ① goes out.
- i** At outside temperatures above 50 °F (10 °C) the windshield heating cannot be activated. Indicator lamp ① lights up briefly when you attempt to activate it and then goes out again.
- i** The windshield defroster has a high current draw. You should therefore switch it off as soon as the windshield is clear. Otherwise, the windshield heating switches itself off automatically after 10 minutes.
- i** When the windshield heating is switched on for the fourth time in a row, it switches itself off automatically after 5 minutes.
- i** Indicator lamp ① flashes if too many electrical consumers are switched on at the same time when the battery voltage is low. After approximately 30 seconds the windshield heating switches off automatically.

Switching the rear window defroster on/off

Switching on/off

- ▶ Turn the SmartKey to position **2** in the ignition lock (▷ page 112).
 - ▶ Press the  button.
The indicator lamp in the  button lights up or goes out.
- i** The rear window defroster has a high current draw. You should therefore switch it off as soon as the rear window is clear, as it only

switches off automatically after several minutes.

- i** If the battery voltage is too low, the rear window defroster may switch off.



Problems with the rear window defroster



If the indicator lamp in the  rear window defroster button flashes, the on-board voltage is too low. The rear window defroster has deactivated prematurely or cannot be activated.

- ▶ Switch off any consumers that are not required, e.g. reading lamps or interior lighting.
When the battery is sufficiently charged, the rear window defroster is activated again automatically.

Activating/deactivating air-recirculation mode

If you switch on air-recirculation mode, the windows can fog up more quickly, in particular at low temperatures. Only use air-recirculation mode briefly to prevent the windows from fogging up.

- ▶ Turn the SmartKey to position **2** in the ignition lock (▷ page 112).
 - ▶ **To activate:** press the  button.
The indicator lamp in the  button lights up.
- i** Air-recirculation mode is automatically activated at high levels of pollution or at high outside temperatures. When air-recirculation mode is activated automatically, the indicator lamp in the  button is not lit.
- Outside air is added after approximately 30 minutes.

► **To deactivate:** press the  button. The indicator lamp in the  button goes out.

- ❗ Air-recirculation mode switches off automatically:
 - after approximately five minutes at outside temperatures below approximately 41 °F
 - after approximately five minutes if cooling with air dehumidification is deactivated
 - after approximately 30 minutes at outside temperatures above approximately 41 °F (5 °C)

Convenience opening or closing using the air-recirculation button



WARNING

When the convenience closing feature is operating, parts of the body could become trapped in the closing area of the side window and the sliding sunroof. There is a risk of injury.

Observe the complete closing procedure when the convenience closing feature is operating. Make sure that no body parts are in close proximity during the closing procedure.

WARNING

During convenience opening parts of the body could be drawn in or become trapped between the side window and window frame. There is a risk of injury.

Make sure that nobody touches the side window during the opening procedure. If someone becomes trapped, immediately press the  switch in the door to stop the movement of the side windows. To continue closing the side window, pull on the  switch.







► **Convenience closing feature:** press and hold the  rocker switch up or down until the side windows and the sliding sunroof start to close automatically.

The indicator lamp above the  rocker switch lights up. Air-recirculation mode is activated.

If you manually open the side windows or the sliding sunroof after closing with the convenience

closing feature, they will remain in this position when opened.



If parts of the body are in the closing area during convenience closing, proceed as follows:



- Press the  button to stop the side windows. The side window stops.
- To then open the side windows, press the  button again.
- Press the  switch to stop the sliding sunroof. The sliding sunroof stops.
- To then open the sliding sunroof, pull back on the  switch.
- **Convenience opening feature:** press and hold the  rocker switch up or down until the side windows and the sliding sunroof start to open automatically. The indicator lamp above the  rocker switch goes out. Air-recirculation mode is deactivated.

Activating/deactivating the residual heat function

The "residual heat" function is only available in Canada.

It is possible to make use of the residual heat of the engine to continue heating the stationary vehicle for up to 30 minutes after the engine has been switched off. The heating time depends on the coolant temperature and on the interior temperature that has been set.

- ❗ The blower will run at a low speed regardless of the airflow setting.
- ❗ If you activate the residual heat function at high temperatures, only the ventilation will be activated.
- Turn the SmartKey to position 0 (► page 112) in the ignition lock or remove it.
- **To activate:** press the  button. The indicator lamp in the  button lights up.

► **To deactivate:** press the  button. The indicator lamp in the  button goes out.

- i** Residual heat is deactivated automatically:
- after approximately 30 minutes
 - when the ignition is switched on
 - if the battery voltage drops
 - if the coolant temperature is too low

Setting the air vents

Important safety notes

WARNING

Very hot or very cold air can flow from the air vents. This could result in burns or frostbite in the immediate vicinity of the air vents. There is a risk of injury.

Make sure that all vehicle occupants always maintain a sufficient distance to the air outlets. If necessary, redirect the airflow to another area of the vehicle interior.

General notes

In order to ensure the direct flow of fresh air through the air vents into the vehicle interior, please observe the following notes:

- keep the air intake grill on the hood free of blockages, such as ice, snow or leaves.
 - never cover the air vents or air intake grilles in the vehicle interior.
- i** For virtually draft-free ventilation, adjust the sliders of the air vents to the center position.
- i** If the automatic climate control constantly differs from the set temperature or if undesired drafts are noticeable, proceed as follows:
- Open the side air vents
 - Open the center air vents
 - Open the rear air vents
 - Set the temperature to 72 °F (22 °C). The automatic climate control adjusts to the set temperature.

Setting the center air vents



Center air vents

- ① Center air vent, left
- ② Center air vent, right
- ③ Center vent thumbwheel, right
- ④ Center vent thumbwheel, left

► **To open/close:** turn thumbwheels ③ and ④ to the right or left.

Setting the side air vents

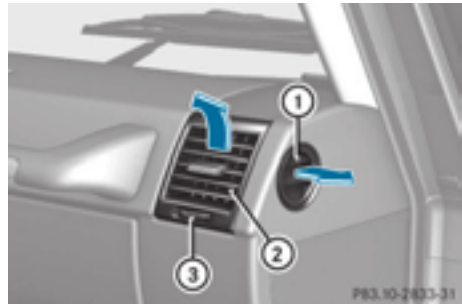

Side air vents

- ① Side air vent
- ② Swiveling side air vent
- ③ Control for side air vent

► **To open/close:** turn thumbwheel ③ to the left or right.

Setting the rear-compartment air vents

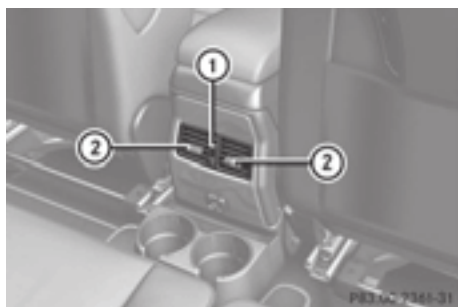

- ▶ **To open/close:** turn thumbwheel ① up or down.
- ▶ **To set the air direction:** move slider ② for the corresponding rear-compartment air vent to the left, right, up or down.

Useful information

- i** This Operator's Manual describes all models and all standard and optional equipment of your vehicle available at the time of publication of the Operator's Manual. Country-specific differences are possible. Please note that your vehicle may not be equipped with all features described. This also applies to safety-related systems and functions.
- i** Read the information on qualified specialist workshops: (▷ page 23).

Notes on breaking-in a new vehicle

Important safety notes

New and replaced brake pads and discs only reach their optimum braking effect after several hundred kilometers of driving. Compensate for this by applying greater force to the brake pedal.

The first 1000 miles (1500 km)

The more you look after the engine when it is new, the more satisfied you will be with its performance in the future.

- You should therefore drive at varying vehicle and engine speeds for the first 1,000 miles (1,500 km).
- Avoid heavy loads, e.g. driving at full throttle, during this period.
- Change gear in good time, before the tachometer needle is $\frac{2}{3}$ of the way to the red area of the tachometer.
- Do not manually shift to a lower gear to brake the vehicle.
- Try to avoid depressing the accelerator pedal beyond the point of resistance (kickdown).
- Only select shift ranges **3**, **2** or **1** when driving slowly, e.g. in mountainous terrain.

After 1,000 miles (1,500 km), you can increase the engine speed gradually and bring the vehicle to full speed.

Additional breaking-in notes for AMG vehicles:

- Do not drive faster than 85 mph (140 km/h) for the first 1,000 miles (1,500 km).
- Only allow the engine to reach a maximum engine speed of 4,500 rpm briefly.

- Change gear in good time.
- Avoid driving off-road before the differential oil change at 2,000 miles (3,000 km).
- Ideally, for the first 1,000 miles (1,500 km), drive in program **C**.
- i** You should also observe these breaking-in notes if the engine or parts of the drive train on your vehicle have been replaced.
- i** Always observe the respective speed limits.

AMG vehicles with self-locking rear axle differential

Change the oil after a breaking-in period of 2,000 miles (3,000 km) to improve protection of the differential. This oil change prolongs the service life of the differential. Have the oil change carried out at a qualified specialist workshop. Mercedes-Benz recommends that you use an authorized Mercedes-Benz Center for this purpose.

Driving

Important safety notes

WARNING

Objects in the driver's footwell can restrict the pedal travel or obstruct a depressed pedal. The operating and road safety of the vehicle is jeopardized. There is a risk of an accident.

Make sure that all objects in the vehicle are stowed correctly, and that they cannot enter the driver's footwell. Install the floormats securely and as specified in order to ensure sufficient clearance for the pedals. Do not use loose floormats and do not place floormats on top of one another.

WARNING

Unsuitable footwear can hinder correct usage of the pedals, e.g.:

- shoes with thick soles
- shoes with high heels
- slippers

There is a risk of an accident.

Wear suitable footwear to ensure correct usage of the pedals.

WARNING

If you switch off the ignition while driving, safety-relevant functions are only available with limitations, or not at all. This could affect, for example, the power steering and the brake boosting effect. You will require considerably more effort to steer and brake. There is a risk of an accident.

Do not switch off the ignition while driving.

WARNING

If the parking brake has not been fully released when driving, the parking brake can:

- overheat and cause a fire
- lose its hold function.

There is a risk of fire and an accident. Release the parking brake fully before driving off.

! Warm up the engine quickly. Do not use the engine's full performance until it has reached operating temperature.

Only shift the automatic transmission to the desired drive position when the vehicle is stationary.

Where possible, avoid spinning the drive wheels when pulling away on slippery roads. You could otherwise damage the drive train.

! Avoid high engine speeds when the engine is cold. The engine's service life could otherwise be significantly shortened. Do not use the engine's full performance until it has reached operating temperature.

! **AMG vehicles:** at low engine oil temperatures below 68 °F (+20 °C), the maximum engine speed is restricted in order to protect the engine. To protect the engine and maintain smooth engine operation, avoid driving at full throttle when the engine is cold.

SmartKey positions



- 0** To remove the SmartKey
- 1** Power supply for some consumers, such as the windshield wipers
- 2** Ignition (power supply for all consumers) and drive position
- 3** To start the engine

As soon as the ignition is switched on, all the indicator lamps in the instrument cluster light up. If an indicator lamp does not go out after starting the engine or lights up while driving, see (▷ page 205).

If the SmartKey is in position **0** in the ignition lock for an extended period of time, it can no longer be turned in the ignition lock. The steering is then locked. To unlock, remove the SmartKey and reinsert it into the ignition lock.

The steering is locked when you remove the SmartKey from the ignition lock.

- ▶ Remove the SmartKey when the engine is switched off. The starter battery could otherwise be discharged.

If you cannot turn the SmartKey in the ignition lock, the starter battery may not be charged sufficiently.

- ▶ Check the starter battery and charge it if necessary (▷ page 252).

or

- ▶ Jump-start the vehicle (▷ page 254).

- i** You can only remove the SmartKey if:
 - the SmartKey is in position **0** in the ignition lock.
 - the automatic transmission selector lever is in **P**.

Starting the engine

Important safety notes

WARNING

Combustion engines emit poisonous exhaust gases such as carbon monoxide. Inhaling these exhaust gases leads to poisoning. There is a risk of fatal injury. Therefore never leave the engine running in enclosed spaces without sufficient ventilation.



WARNING

Flammable materials introduced through environmental influence or by animals can ignite if in contact with the exhaust system or parts of the engine that heat up. There is a risk of fire.

Carry out regular checks to make sure that there are no flammable foreign materials in the engine compartment or in the exhaust system.

-  Do not depress the accelerator when starting the engine.

Starting procedure

- ▶ Shift the automatic transmission to position **P**.
The transmission position display in the multifunction display shows **P**.
-  For further information about the automatic transmission, see (▷ page 118).
-  If you depress the brake when starting the engine, pedal travel is unusually long and there is less pedal resistance.
- ▶ Make sure that the parking brake is applied.
- ▶ Turn the SmartKey to position **3** (▷ page 112) in the ignition lock and release it as soon as the engine is running.
-  You can also use the touch-start function. To do this, turn the SmartKey to position **3** (▷ page 112) and release it immediately. The engine then starts automatically.







Pulling away

Automatic transmission

WARNING

If the engine speed is above the idling speed and you engage transmission position **D** or **R**, the vehicle could pull away suddenly. There is a risk of an accident.

When engaging transmission position **D** or **R**, always firmly depress the brake pedal and do not simultaneously accelerate.

-  Only shift the automatic transmission to reverse gear **R** or park position **P** when the vehicle is stationary. Otherwise, the automatic transmission could be damaged.
-  Do not depress the accelerator pedal while depressing the brake pedal. This impairs engine performance and results in premature wear on the brake system and drivetrain.
-  If a warning tone sounds and the **Release Park. Brake** message appears in the multifunction display, the parking brake is still applied. Release the parking brake.
- ▶ Depress the brake pedal and keep it depressed.
- ▶ Shift the automatic transmission to position **D** or **R**.
-  Before driving off, wait until the gear change is fully completed.
- ▶ Release the parking brake (▷ page 131).
- ▶ Release the brake pedal.
- ▶ Carefully depress the accelerator pedal.
-  It is only possible to shift the automatic transmission from position **P** to a different position if you depress the brake pedal. Only then is the selector lever lock released.
-  The vehicle locks centrally once you have pulled away. The locking knobs in the doors drop down.
You can open the doors from the inside at any time.
You can also deactivate the automatic locking feature (▷ page 180).
-  Upshifts take place at higher engine speeds after a cold start. This helps the catalytic con-

verter to reach its operating temperature more quickly.

Hill start assist

WARNING

After a short time, hill start assist will no longer brake your vehicle and it could roll away. There is a risk of an accident and injury.

Therefore, quickly move your foot from the brake pedal to the accelerator pedal. Never leave the vehicle when it is held by hill start assist.

Hill start assist helps you when pulling away forwards or in reverse on an uphill gradient. It holds the vehicle for a short time after you have removed your foot from the brake pedal. This gives you enough time to move your foot from the brake pedal to the accelerator pedal and to depress it before the vehicle begins to roll.

- ▶ Take your foot off the brake pedal.
-  Once you have taken your foot off the brake pedal, the vehicle is held for around one second.
- ▶ Pull away.

Hill start assist will not function if:

- you are pulling away on a level road or on a downhill gradient.
- the transmission is in position **N**.
- the parking brake is applied.
- ESP® is malfunctioning.

ECO start/stop function

Important safety notes

WARNING

If the engine is switched off automatically and you exit the vehicle, the engine is restarted automatically. The vehicle may begin moving. There is a risk of accident and injury.

If you wish to exit the vehicle, always turn off the ignition and secure the vehicle against rolling away.

General notes

The ECO start/stop function switches the engine off automatically when the vehicle stops moving.

The engine starts automatically when the driver wants to pull away again. The ECO start/stop function thereby helps you to reduce the fuel consumption and emissions of your vehicle.

The ECO start/stop function is activated each time the engine is switched on.

The ECO start/stop function is only available in drive program **C/E**.

The system is operational if all conditions for automatic engine switch-off have been fulfilled (▷ page 115) and the  symbol is shown in green in the multifunction display.

In addition, the **Stop/Start active** message is shown in the AMG menu in the multifunction display.

If not all conditions for automatic engine switch-off are fulfilled (▷ page 115), the  ECO symbol is shown in yellow in the multifunction display.

In addition, the **Stop/Start inactive** message is shown in the AMG menu in the multifunction display.

If the ECO start/stop function has been manually deactivated (▷ page 114) or a malfunction has caused the system to be deactivated, the  ECO symbol is not displayed.

The **Stop/Start active** or **Stop/Start inactive** message in the AMG menu in the multifunction display goes out.

Deactivating/activating the ECO start/stop function



ECO button

► **To deactivate:** in drive program **C/E** press button ①.

or

► Switch to drive program **S** or **M** (► page 122). Indicator lamp ② on button ① and the  ECO symbol in the multifunction display go out.

The **Stop/Start active** or **Stop/Start inactive** message in the AMG menu in the multifunction display goes out.

► **To activate:** press button ①. Indicator lamp ② lights up. If drive program **S** or **M** is active, the automatic transmission switches to drive program **C/E**.

If all conditions for automatic engine switch-off (► page 115) are fulfilled, the  ECO symbol is shown in green in the multifunction display. In addition, the **Stop/Start active** message is shown in the AMG menu in the multifunction display.

If not all conditions for automatic engine switch-off (► page 115) are fulfilled, the  ECO symbol is not shown. If this is the case, the ECO start/stop function is not available. In addition, the **Stop/Start inactive** display message is shown in the AMG menu in the multifunction display.

- ❗ If indicator lamp ② is off, the ECO start/stop function has been deactivated manually or as the result of a malfunction. The engine will then not be switched off automatically when the vehicle stops.

Automatic engine switch-off

If the vehicle is braked to a standstill in **D** or **N**, the ECO start/stop function switches off the engine automatically.

The ECO start/stop function is operational and the  ECO symbol is shown in green in the multifunction display, if:

- the indicator lamp in the  ECO button is lit green.
- no off-road program has been selected.
- the vehicle is stationary.
- the outside temperature is within the comfort range.
- the engine is at normal operating temperature.
- the set temperature for the vehicle interior has been reached.

- the battery is sufficiently charged.
- the system detects that the windshield is not fogged up when the air-conditioning system is switched on.
- the hood is closed.
- the driver's door is closed and the driver's seat belt is fastened.

If the conditions for automatic engine switch-off are not all fulfilled, the  ECO symbol is shown in yellow.

In addition, the **Stop/Start inactive** message is shown in the AMG menu in the multifunction display.

- ❗ If you shift the transmission from **R** to **D**, the ECO start/stop function is available again once the  ECO symbol reappears in green in the multifunction display.
- ❗ The engine can be automatically switched off an unlimited number of times.
- ❗ You can still activate the HOLD function when the vehicle is stationary, even if the engine has been switched off automatically. It is then not necessary to continue applying the brakes during the automatic stop phase. When you depress the accelerator pedal, the engine starts automatically and the braking effect of the HOLD function is deactivated. Depress the accelerator pedal carefully, as the engine must be started first.
- ❗ During automatic engine switch-off, the climate control system only operates at a reduced capacity. If you require full climate control capacity, the ECO start/stop function can be deactivated by pressing the ECO button (► page 114).

Automatic engine start

The engine starts automatically if:

- In general:
 - you switch off the ECO start/stop function by pressing the ECO button
 - you release the brakes when in transmission position **D** or **N** and when the HOLD function is not active.
 - By the driver:
 - you release the brakes when in transmission position **D** or **N**
 - you depress the accelerator pedal
 - you engage reverse gear **R**
 - you move the transmission out of position **P**
 - you switch to drive program **S** or **M**
 - you unfasten your seat belt or open the driver's door
 - By the system:
 - the vehicle starts to roll
 - the brake system requires this
 - the temperature in the vehicle interior deviates from the set range
 - the system detects moisture on the windshield when the air-conditioning system is switched on
 - the battery's condition of charge is too low
- i** Shifting the transmission to position **P** does not start the engine.

Problems with the engine	
Problem	Possible causes/consequences and ► Solutions
The engine does not start. The starter motor can be heard.	<ul style="list-style-type: none"> • There is a malfunction in the engine electronics. • There is a malfunction in the fuel supply. <ul style="list-style-type: none"> ► Turn the SmartKey back to position 0 in the ignition lock before attempting to start the engine again. ► Try to start the engine again (▷ page 113). Avoid excessively long and frequent attempts to start the engine, as this (▷ page 112) will drain the battery. <p>If the engine does not start after several attempts:</p> <ul style="list-style-type: none"> ► Consult a qualified specialist workshop.
The engine does not start. The starter motor can be heard. The yellow reserve fuel warning lamp is lit and the needle of the fuel gage display shows 0 .	<p>The fuel tank is empty.</p> <ul style="list-style-type: none"> ► Refuel the vehicle.
The engine does not start. You cannot hear the starter motor.	<p>The on-board voltage is too low because the battery is too weak or discharged.</p> <ul style="list-style-type: none"> ► Jump-start the vehicle (▷ page 254). <p>If the engine does not start despite attempts to jump-start it:</p> <ul style="list-style-type: none"> ► Consult a qualified specialist workshop. <p>The starter motor was exposed to a thermal load that was too high.</p> <ul style="list-style-type: none"> ► Allow the starter motor to cool down for approximately two minutes. ► Try to start the engine again. <p>If the engine still does not start:</p> <ul style="list-style-type: none"> ► Consult a qualified specialist workshop.
The engine is not running smoothly and is misfiring.	<p>There is a malfunction in the engine electronics or in a mechanical component of the engine management system.</p> <ul style="list-style-type: none"> ► Only depress the accelerator pedal slightly. Otherwise, non-combusted fuel may get into the catalytic converter and damage it. ► Have the cause rectified immediately at a qualified specialist workshop.

Problem	Possible causes/consequences and ► Solutions
The coolant temperature gage shows a value above 248 °F (120 °C). A display message may also appear in the multi-function display and a warning tone may sound.	<p>The coolant level is too low. The coolant is too hot and the engine is no longer being cooled sufficiently.</p> <ul style="list-style-type: none"> ► Stop as soon as possible and allow the engine and the coolant to cool down. ► Check the coolant level (► page 238). Observe the warning notes as you do so and add coolant if necessary.
	<p>If the coolant level is correct, the radiator fan may be faulty. The coolant is too hot and the engine is no longer being cooled sufficiently.</p> <ul style="list-style-type: none"> ► At coolant temperatures below 248 °F (120 °C), drive to the nearest qualified specialist workshop. ► Avoid heavy loads on the engine as you do so, e.g. driving in mountainous terrain and stop-and-go traffic.

Adjustable damping

General notes

With the adjustable damping you can choose between two different suspension settings.

Suspension settings

COMF	Comfortable suspension setting
Sport	Sports suspension setting

Selecting the suspension setting



Program selector button in the center console

- i** If you select the sports suspension setting, the vehicle will dampen more roughly.
- Press **SPORT** on program selector button ①. The indicator lamp lights up. **SPORT** is shown in the multifunction display. The sports suspension setting is selected.

- i** If you select the comfortable suspension setting, the vehicle will dampen more smoothly.

- Press **COMF** on program selector button ①. The indicator lamp lights up. **COMF** is shown in the multifunction display. The comfortable suspension setting is selected.

Automatic transmission

Important safety notes

⚠ WARNING

If the engine speed is above the idling speed and you engage transmission position **D** or **R**, the vehicle could pull away suddenly. There is a risk of an accident.

When engaging transmission position **D** or **R**, always firmly depress the brake pedal and do not simultaneously accelerate.

⚠ WARNING

The automatic transmission switches to neutral position **N** when you switch off the engine. The vehicle may roll away. There is a risk of an accident.

After switching off the engine, always switch to parking position **P**. Prevent the parked vehicle from rolling away by applying the parking brake.

i Bear in mind that the power transmission between the engine and the transmission is interrupted when the engine is switched off. For this reason, shift the automatic transmission to **P** when the engine is switched off and the vehicle is at a standstill. Apply the parking brake to prevent the vehicle from rolling away.

Selector lever

Overview of transmission positions

! If the engine speed is too high or if the vehicle is rolling, do not shift the transmission directly from **D** to **R**, from **R** to **D** or directly to **P**.

Do not open the driver's door while the vehicle is in motion. At low speeds in transmission position **D** or **R**, park position **P** is otherwise engaged automatically.

The transmission could be damaged.

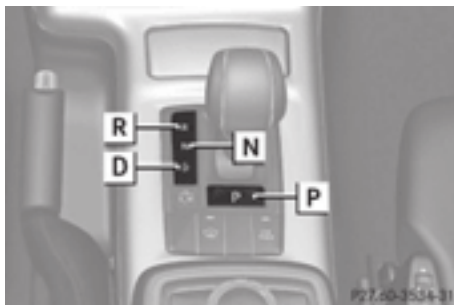

Selector lever

- P** Park position
- R** Reverse gear
- N** Neutral
- D** Drive

When you select a transmission position, the selector lever subsequently returns to its original position.

The current transmission position **P**, **R**, **N** or **D** appears in the transmission position display in the multifunction display.

Transmission position and drive program display

! If the transmission position display in the multifunction display is not working, you

should pull away carefully to check whether the desired transmission position is engaged. Select transmission position **D**. Do not restrict the shift range.



- ① Transmission position
- ② Drive program

Current transmission position ① and current drive program ② appear in the multifunction display.

The current position of the selector lever is shown by the indicators next to the selector lever.

The indicators light up when the SmartKey is inserted into the ignition lock. The indicators go out when the SmartKey is removed from the ignition lock.

When the selector lever is in position **D**, you can influence the gearshifts made by the automatic transmission by:

- restricting the shift range
- changing gear yourself

Engaging park position P

- ▶ When the vehicle is stationary, depress the brake pedal and keep it depressed.
- ▶ Press the **P** button in the center console.

i If you depress the brake pedal and push the selector lever forwards or back to the first point of resistance, park position **P** is disengaged. The transmission shifts to neutral **N**.

Park position **P** is automatically engaged:

- if you remove the SmartKey from the ignition lock
- if you open the driver's door while traveling at low speed in transmission position **D** or **R**
- if DISTRONIC PLUS (▷ page 147) brakes your vehicle until it is stationary and at least one of the following conditions is fulfilled:
 - the engine is switched off.
 - the driver's door is open and the seat belt is not fastened.
 - there is a system malfunction.
 - the power supply is insufficient.

Engaging reverse gear **R**

! Only shift the automatic transmission to **R** when the vehicle is stationary.

- ▶ When the vehicle is stationary, depress the brake pedal and keep it depressed.
- ▶ Push the selector lever forwards past the first point of resistance. Transmission position **R** is engaged.

i When reverse gear is engaged and the ECO start/stop function is switched on, the engine starts up automatically (▷ page 114).

Shifting to neutral **N**

WARNING

If children are left unsupervised in the vehicle, they could:

- open the doors, thus endangering other people or road users.
- get out and disrupt traffic.
- operate the vehicle's equipment.

Additionally, children could set the vehicle in motion if, for example, they:

- release the parking brake.
- shifting the automatic transmission out of park position **P**
- Start the engine.

There is a risk of an accident and injury.

When leaving the vehicle, always take the SmartKey with you and lock the vehicle. Never leave children or animals unattended in the

vehicle. Always keep the SmartKey out of reach of children.

If the vehicle is stationary:

- ▶ Depress the brake pedal.
- ▶ Depending on the current transmission position, press the selector lever forwards or backwards to the first point of resistance. The automatic transmission shifts into **N**.

If the engine has been switched off, the automatic transmission automatically shifts to **N**.

i If the vehicle is braked to a standstill when in neutral **N** and the brake pedal continues to be depressed, the ECO start/stop function switches the engine off automatically (▷ page 114).

Remaining in neutral **N**

WARNING

If children are left unsupervised in the vehicle, they could:

- open the doors, thus endangering other people or road users.
- get out and disrupt traffic.
- operate the vehicle's equipment.

Additionally, children could set the vehicle in motion if, for example, they:

- release the parking brake.
- shifting the automatic transmission out of park position **P**
- Start the engine.

There is a risk of an accident and injury.

When leaving the vehicle, always take the SmartKey with you and lock the vehicle. Never leave children or animals unattended in the vehicle. Always keep the SmartKey out of reach of children.

- ▶ Make sure that the ignition is switched on.
- ▶ When the vehicle is stationary, depress the brake pedal and keep it depressed.
- ▶ Shift to neutral **N**.
- ▶ Release the brake pedal.

- ▶ If the parking brake is applied, release it.
- ▶ Switch off the ignition and leave the SmartKey in the ignition lock.

Shifting to transmission position D

- ▶ When the vehicle is stationary, depress the brake pedal and keep it depressed.
 - ▶ Push the selector lever back past the first point of resistance.
Transmission position **D** is engaged.
- i** If the vehicle is braked to a standstill when in transmission position **D** (▷ page 114) and the brake pedal continues to be depressed, the ECO start/stop function switches the engine off automatically.

Transmission positions

P

Park position

Do not shift the transmission into position **P** (▷ page 119) unless the vehicle is stationary. The parking lock should not be used as a brake when parking. In addition to engaging the parking lock, you must always apply the parking brake to secure the vehicle.

- i** The SmartKey can only be removed if the transmission is in position **P**. When there is no SmartKey in the ignition lock, the selector lever is locked in position **P**.

R

Reverse gear

Only shift the transmission to **R** when the vehicle is stationary.

N

Neutral

No power is transmitted from the engine to the drive wheels.

Releasing the brakes will allow you to move the vehicle freely, e.g. to push it or tow it.

Do not shift the transmission to **N** while driving. Otherwise, the automatic transmission could be damaged.

If ESP[®] is deactivated or faulty: only shift the transmission to position **N** if the vehicle is in danger of skidding, e.g. on icy roads.

If you want to engage the transfer case, shift briefly into **N** (▷ page 162).

! Rolling in neutral **N** can damage the drive train.

D

Drive

The automatic transmission changes gear automatically. All forward gears are available.

Changing gear

The automatic transmission shifts to the individual gears automatically when it is in transmission position **D**. This automatic gearshifting behavior is determined by:

- a shift range restriction, if selected
- the position of the transfer case (**HIGH RANGE** or **LOW RANGE**)
- the position of the accelerator pedal
- the road speed

Driving tips

Accelerator pedal position

Your style of driving influences how the automatic transmission shifts gear:

- little throttle: early upshifts
- more throttle: late upshifts

Kickdown

Use kickdown for maximum acceleration.

- ▶ Depress the accelerator pedal beyond the pressure point.
The automatic transmission shifts to a lower gear depending on the engine speed.
- ▶ Ease off the accelerator pedal once the desired speed is reached.
The automatic transmission shifts back up.

Kickdown is not available in the permanent manual drive program on AMG vehicles.

Rocking the vehicle free

Shifting the transmission repeatedly between gears **D** and **R** may help to free the vehicle if it has become stuck in slush or snow. The vehicle's engine management system limits the speed to a maximum of 5 mph (9 km/h) when shifting back and forth. To shift back and forth between transmission positions **D** and **R**, move the selector lever forwards and backwards past the point of resistance.

Towing a trailer

- ▶ Drive in the middle of the engine speed range on uphill gradients.
- ▶ **Vehicles except AMG vehicles:** shift down to shift range **3** or **2** depending on the uphill or downhill gradient (> page 123), even if cruise control or SPEEDTRONIC is activated.
AMG vehicles: shift down to gear **3** or **2** depending on the uphill or downhill gradient (> page 123), even if cruise control, DISTRONIC PLUS or SPEEDTRONIC is activated.
- ▶ Shift the transfer case into low-range driving position **LOW RANGE** on extreme uphill gradients or steep downhill gradients (> page 162).

Program selector button

General notes

The program selector button allows you to choose between drive programs with different driving characteristics.

- ▶ In AMG vehicles, drive program **E** is called drive program **C**.

- ▶ The automatic transmission switches to automatic drive program **E** (drive program **C** in AMG vehicles) each time the engine is started.

- ▶ Only change from automatic drive program **C** or **S** to manual drive program **M** when the vehicle is stationary.

Drive program except for AMG vehicles

E Economy	Comfortable, economical driving
S Sport	Sporty driving style
M Manual	Manual gear shifting

Drive programs on AMG vehicles

C Controlled Efficiency	Comfortable, economical driving
S Sport	Sporty driving style
M Manual	Manual gear shifting

- ▶ For further information on the automatic drive program, see (> page 123).

Selecting the drive program



Program selector button (except for AMG vehicles)



Program selector button (AMG vehicles)

- ▶ Press program selector button ① repeatedly until the letter for the desired gearshift program appears in the multifunction display.

Steering wheel paddle shifters



In the automatic drive program, you can restrict or derestrict the shift range by using steering wheel paddle shifters ① and ② (▷ page 123).

In the manual drive program you can change gears manually using steering wheel paddle shifters ① and ② (▷ page 124).

- ⓘ You can only change gear with the steering wheel paddle shifters when the transmission is in position **D**.

Automatic drive program

Drive program **E** (drive program **C** on AMG vehicles) is characterized by the following:

- comfort-oriented engine and transmission settings
- optimal fuel consumption resulting from the automatic transmission shifting up sooner
- the vehicle pulling away more gently in forward and reverse gears, unless the accelerator pedal is depressed fully
- increased sensitivity. This improves driving stability on slippery road surfaces, for example
- the automatic transmission shifting up sooner. This results in the vehicle being driven at lower engine speeds and the wheels being less likely to spin

Drive program **S** is characterized by the following:

- sporty engine and transmission settings
- the vehicle pulling away in first gear
- the automatic transmission shifting up later
- the fuel consumption possibly being higher as a result of the later automatic transmission shift points

Shift ranges

Introduction

When the automatic transmission is in position **D**, it is possible to restrict or derestrict the shift range.

The shift range selected is shown in the multifunction display. The automatic transmission shifts only as far as the selected gear.

Setting the shift range is not possible on AMG vehicles.

Driving situations

3	You can use the engine's braking effect
2	The braking effect of the engine can be utilized on downhill gradients or when driving: <ul style="list-style-type: none"> • on steep mountain roads • in mountainous terrain • in arduous conditions
1	The braking effect of the engine can be utilized on extremely steep downhill gradients and long downhill stretches.

Restricting the shift range

- ▶ Pull the left-hand steering wheel paddle shifter (▷ page 123). The automatic transmission shifts down one gear and restricts the shift range to the relevant gear.

i If the engine exceeds the maximum engine speed when shifting down, the automatic transmission protects against engine damage by not shifting down.

i If the maximum engine speed for the shift range is reached and you continue to accelerate, the automatic transmission shifts up in order to prevent the engine from overrevving, even if the shift range is restricted.

Derestricting the shift range

- ▶ Pull the right-hand steering wheel paddle shifter (▷ page 123). The automatic transmission shifts up one gear and restricts the shift range to the relevant gear.

Clearing the shift range restriction

- ▶ Pull and hold the right-hand steering wheel paddle shifter (▷ page 123) until **D** is shown again in the multifunction display. The automatic transmission shifts from the current shift range directly to **D**.

Selecting the ideal shift range

- ▶ Pull the left-hand steering wheel paddle shifter (▷ page 123) and hold it in position. The automatic transmission shifts to the gear which allows optimum acceleration and deceleration. To do this, the automatic transmission shifts down one or more gears.

i The automatic transmission cannot shift down beyond second gear. To shift to first gear, you have to pull the left steering wheel paddle shifter.

Manual gear shifting

Temporary setting



- ▶ **To activate:** shift the DIRECT SELECT lever to position **D**.
- ▶ Pull steering wheel paddle shifter ① or ②.

Temporary setting will be active for a certain amount of time. Under certain conditions the minimum amount of time is extended, e.g. in the case of lateral acceleration, during an overrun phase or when driving on steep terrain.

- ▶ **To deactivate:** pull steering wheel paddle shifter ② and hold it in place.

or

- ▶ Use the DIRECT SELECT lever to switch the transmission position.

or

- ▶ Use the DYNAMIC SELECT switch to change the drive program.

Shifting gears

! The automatic transmission does not shift up automatically even when the engine limiting speed for the current gear is reached.

When the engine limiting speed is reached, the fuel supply is cut to prevent the engine from overrevving. Always make sure that the engine speed does not reach the red area of the tachometer. There is otherwise a risk of engine damage.



- ▶ **To shift up:** pull steering wheel paddle shifter ②.

The automatic transmission shifts up to the next gear.

- ▶ **To shift down:** pull steering wheel paddle shifter ①.

The automatic transmission shifts down to the next gear.

Automatic down shifting occurs when coasting.

If the engine exceeds the maximum engine speed when shifting down, the automatic transmission protects against engine damage by not shifting down.

Shift recommendation



The gearshift recommendations assist you in adopting an economical driving style. The recommended gear is shown in the multifunction display.

- ▶ If relevant gearshift recommendation ① appears in the multifunction display on the instrument cluster, pull the corresponding steering wheel paddle shifter (▷ page 123). The automatic transmission shifts to recommended gear ②.
- ▶ If relevant gearshift recommendation ① appears in the multifunction display in the instrument cluster, pull the corresponding steering wheel paddle shifter (see the Digital Operator's Manual). The automatic transmission shifts to recommended gear ②.

Manual drive program

General information

In manual drive program **M**, you can permanently change gear yourself by using the steering wheel paddle shifters. The transmission must be in position **D**. The gear currently selected and engaged is shown in the multifunction display.

Manual drive program **M** differs from drive programs **E** and **S** with regard to spontaneity, responsiveness and smoothness of gear changes.

Switching on the manual drive program

- ▶ Shift the transmission to position **D**.
- ▶ Press the program selector button repeatedly until **M** appears in the multifunction display.

Upshifting

- ! In manual drive program **M**, the automatic transmission does not shift up automatically even when the engine limiting speed for the current gear is reached. When the engine limiting speed is reached, the fuel supply is cut to prevent the engine from overrevving. Always make sure that the engine speed does not reach the red area of the tachometer. There is otherwise a risk of engine damage.



- ▶ If corresponding gearshift recommendation ① appears in the multifunction display on the instrument cluster, pull on the right-hand steering wheel paddle shifter (▷ page 123). The automatic transmission shifts to recommended gear ②.

Downshifting

- ▶ Pull the left-hand steering wheel paddle shifter (▷ page 123). The automatic transmission shifts down to the next gear.
- i** If you slow down or stop without shifting down, the automatic transmission automatically shifts down.

Selecting the optimal gear for maximum acceleration

- ▶ Pull the left-hand steering wheel paddle shifter until the transmission selects the optimum gear according to the speed.

Switching off the manual drive program

- ▶ Press the program selector button repeatedly until **C** or **S** appears in the multifunction display.

Problems with the automatic transmission

Problem	Possible causes/consequences and ► Solutions
The acceleration ability is deteriorating. The transmission no longer changes gear.	The transmission is in emergency mode. It is only possible to shift into second gear and reverse gear. <ul style="list-style-type: none"> ► Stop the vehicle. ► Shift the transmission to position P. ► Turn the SmartKey to position 0 in the ignition lock. ► Wait at least ten seconds before restarting the engine. ► Shift the transmission to position D or R. If D is selected, the transmission shifts into second gear; if R is selected, the transmission shifts into reverse gear. ► Have the transmission checked at a qualified specialist workshop immediately.
You hear a warning tone.	You have: <ul style="list-style-type: none"> • switched off the engine • opened the driver's door • not shifted the selector lever to position P ► Shift the selector lever to position P .

Refueling

Important safety notes

 **WARNING**

Fuel is highly flammable. If you handle fuel incorrectly, there is a risk of fire and explosion.

You must avoid fire, open flames, creating sparks and smoking. Switch off the engine and, if applicable, the auxiliary heating before refueling.

 **WARNING**

Fuel is poisonous and hazardous to health. There is a risk of injury.

You must make sure that fuel does not come into contact with your skin, eyes or clothing and that it is not swallowed. Do not inhale fuel vapors. Keep fuel away from children.

If you or others come into contact with fuel, observe the following:

- Wash away fuel from skin immediately using soap and water.
- If fuel comes into contact with your eyes, immediately rinse them thoroughly with clean water. Seek medical assistance without delay.
- If fuel is swallowed, seek medical assistance without delay. Do not induce vomiting.
- Immediately change out of clothing which has come into contact with fuel.

 Do not use diesel to refuel vehicles with a gasoline engine. Even small amounts of the wrong fuel result in damage to the fuel system and engine.

 Do not switch on the ignition if you accidentally refuel with the wrong fuel. Otherwise, the fuel will enter the fuel lines. Notify a qualified specialist workshop and have the fuel tank and fuel lines drained completely.

- ❗ Overfilling the fuel tank could damage the fuel system.
- ❗ Take care not to spill any fuel on painted surfaces. You could otherwise damage the paintwork.
- ❗ Use a filter when refueling from a fuel can. Otherwise, the fuel lines and/or injection system could be blocked by particles from the fuel can.

If you overfill the fuel tank, pressure may build up in the fuel tank. This could cause fuel to spray out when the fuel pump nozzle is removed. There is a risk of injury. The fuel tank is full when the fuel pump nozzle first switches off. End the refueling process.

For further information on fuel and fuel quality (▷ page 289).

Refueling

Vehicles with a fuel filler flap

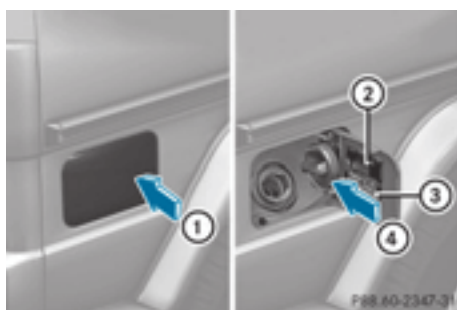

Example: G 550 fuel filler cap

- ① To open the fuel filler flap
- ② Tire pressure table
- ③ Fuel type
- ④ To insert the fuel filler cap

When you open or close the vehicle with the SmartKey, the fuel filler flap is automatically unlocked or locked.

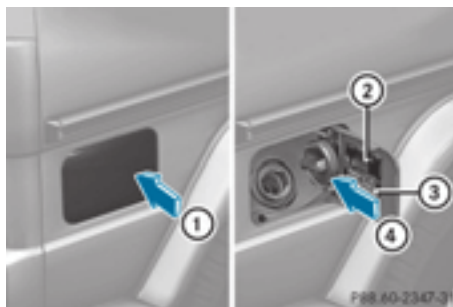

The position of the fuel filler cap is displayed  in the instrument cluster. The arrow next to the filling pump indicates the side of the vehicle. The fuel filler flap is located to the rear on the right.

Opening the fuel filler cap



- ① To open the fuel filler flap
- ② Tire pressure table
- ③ Fuel type
- ④ To insert the fuel filler cap

► Switch the engine off.

i When the engine is running and the fuel filler flap is open, the yellow reserve fuel warning lamp and the  (USA only) or  (Canada only) Check Engine warning lamp may light up.

Further information about warning and indicator lamps in the instrument cluster can be found in the Digital Operator's Manual.

- Remove the SmartKey from the ignition lock.
- Turn the fuel filler cap counterclockwise and remove it.
- Insert the fuel filler cap into the holder bracket on the inside of filler flap ④.

Refueling

► Completely insert the filler neck of the fuel pump nozzle into the tank and refuel.

i Do not add any more fuel after the pump stops filling for the first time. Otherwise, fuel may leak out.

Closing

- Replace the fuel filler cap and turn it clockwise. The fuel filler cap audibly engages.
- Close the fuel filler flap.

i Close the fuel filler flap before locking the vehicle. A locking pin otherwise prevents the fuel filler flap from closing after the vehicle has been locked.

Fuel filler flap emergency release



The emergency release is located in the cargo compartment, on the right-hand side when viewed in the direction of travel, behind the rear panel trim.

i The vehicle body in the emergency release area has sharp edges. There is a risk of injury. Avoid contact with the edges on the inside of the vehicle body.

- ▶ Open the rear door.
- ▶ Remove edge protection ①.
- ▶ Remove rear panel trim ②.



- ▶ Pull emergency release ③ in the direction of the arrow.
The fuel filler flap is unlocked.
- ▶ Open the fuel filler flap.

Problems with the fuel and fuel tank

Problem	Possible causes/consequences and ► Solutions
Fuel is leaking from the vehicle.	<p>The fuel line or the fuel tank is defective.</p> <p> WARNING</p> <p>Risk of explosion or fire.</p> <ul style="list-style-type: none"> ► Turn the SmartKey to position 0 (► page 112) immediately and remove it. ► Do not restart the engine under any circumstances. ► Consult a qualified specialist workshop.
The fuel filler flap cannot be opened.	<p>The fuel filler flap is not unlocked.</p> <p>or</p> <p>The SmartKey batteries are discharged.</p> <ul style="list-style-type: none"> ► Unlock the vehicle (► page 60). <p>or</p> <ul style="list-style-type: none"> ► Unlock the vehicle using the mechanical key (► page 61). ► Open the rear door. ► Manually unlock the fuel filler flap using the emergency release (► page 129). <p>The fuel filler flap is unlocked, but the opening mechanism is jammed.</p> <ul style="list-style-type: none"> ► Manually unlock the fuel filler flap using the emergency release (► page 129). ► Consult a qualified specialist workshop.

Parking

Important safety notes

 **WARNING**

If you leave children unsupervised in the vehicle, they could set it in motion by, for example:

- release the parking brake.
- shift the automatic transmission out of the parking position **P**.
- start the engine.

In addition, they may operate vehicle equipment and become trapped. There is a risk of an accident and injury.

When leaving the vehicle, always take the SmartKey with you and lock the vehicle. Never leave children unsupervised in the vehicle.

 **WARNING**

Flammable material such as leaves, grass or twigs may ignite if they come into contact with hot parts of the exhaust system or exhaust gas flow. There is a risk of fire.

Park the vehicle so that no flammable materials come into contact with parts of the vehicle which are hot. Take particular care not to park on dry grassland or harvested grain fields.

 **WARNING**

If you switch off the ignition while driving, safety-relevant functions are only available with limitations, or not at all. This could affect, for example, the power steering and the brake boosting effect. You will require considerably more effort to steer and brake. There is a risk of an accident.

Do not switch off the ignition while driving.

Switching off the engine

Important safety notes

WARNING

If you switch off the ignition while driving, safety-relevant functions are only available with limitations, or not at all. This could affect, for example, the power steering and the brake boosting effect. You will require considerably more effort to steer and brake. There is a risk of an accident.

Do not switch off the ignition while driving.

WARNING

The automatic transmission switches to neutral position **N** when you switch off the engine. The vehicle may roll away. There is a risk of an accident.

After switching off the engine, always switch to parking position **P**. Prevent the parked vehicle from rolling away by applying the parking brake.

Vehicles with automatic transmission

- ▶ Shift the transmission to position **P**.
- ▶ Turn the SmartKey to position **0** in the ignition lock and remove it (▶ page 112). The immobilizer is activated.
- ▶ Apply the parking brake firmly.
- ▶ Turn the steering wheel until the steering wheel lock engages.

i If you switch off the engine using the SmartKey and then remove the SmartKey from the ignition lock or open one of the front doors, the automatic transmission automatically shifts to park position **P**.

i The SmartKey can only be removed if the automatic transmission is in position **P**.

Parking brake

WARNING

If you must brake the vehicle with the parking brake, the braking distance is considerably longer and the wheels could lock. There is an increased danger of skidding and accidents.

Only use the parking brake to brake the vehicle when the service brake is faulty. Do not apply the parking brake too firmly. If the wheels lock, release the parking brake until the wheels begin turning again.

WARNING

If you leave children unsupervised in the vehicle, they could set it in motion by, for example:

- release the parking brake.
- shift the automatic transmission out of the parking position **P**.
- start the engine.

In addition, they may operate vehicle equipment and become trapped. There is a risk of an accident and injury.

When leaving the vehicle, always take the SmartKey with you and lock the vehicle. Never leave children unsupervised in the vehicle.



i When you apply parking brake **2** to brake the vehicle, the brake lamps do not light up.

- ▶ **To apply:** pull parking brake **2** up firmly. Parking brake **2** is applied.

When the ignition is switched on or the engine is running, the **[PARK]** (USA only) or **[P]** (Canada only) indicator lamp is lit in the instrument cluster.

- ▶ **To release:** depress the brake pedal and keep it depressed.
The selector lever lock is released.
- ▶ Pull parking brake ② up firmly.
- ▶ Press release button ① on parking brake ② and move parking brake ② down to the stop. When the ignition is switched on or the engine is running, the **PARK** (USA only) or **(P)** (Canada only) indicator lamp goes out in the instrument cluster.

- ❗ If you pull away with parking brake ② applied, a warning tone sounds.

Parking the vehicle for a long period

If you leave the vehicle parked for longer than four weeks, the battery may be damaged by exhaustive discharge.

- ▶ Connect a trickle charger.
- ❗ You can obtain information about trickle chargers from a qualified specialist workshop.

If you leave the vehicle parked for longer than six weeks, the vehicle may suffer damage as a result of lack of use.

- ▶ Visit a qualified specialist workshop and seek advice.

Driving tips

General driving tips

Important safety notes

WARNING

Always remember that you must concentrate primarily on driving the vehicle. The driver's concentration must always be directed primarily at road traffic. For your own safety and that of others, we recommend that you stop the vehicle at a safe place and in accordance with the traffic conditions before making or accepting a phone call.

Comply with all legal requirements if you use the telephone while driving. Use the hands-free system and only use the telephone when road, weather and traffic conditions permit. In

some jurisdictions, it is forbidden for drivers to use mobile phones while driving.

Only operate COMAND (Cockpit Management and Data System) in compliance with all legal requirements and when the road, weather and traffic conditions permit. You may otherwise not be able to observe the traffic conditions, endangering yourself and others.

Remember that your vehicle covers a distance of 44 ft (approximately 14 m) a second when it is traveling at only 30 mph (approximately 50 km/h).

WARNING

If you switch off the ignition while driving, safety-relevant functions are only available with limitations, or not at all. This could affect, for example, the power steering and the brake boosting effect. You will require considerably more effort to steer and brake. There is a risk of an accident.

Do not switch off the ignition while driving.

Drive sensibly – save fuel

Observe the following tips to save fuel:

- ▶ The tires should always be inflated to the recommended tire pressure.
- ▶ Remove unnecessary loads.
- ▶ Remove roof carriers when they are not needed.
- ▶ Warm up the engine at low engine speeds.
- ▶ Avoid frequent acceleration or braking.
- ▶ Have all maintenance work performed at the service intervals specified in the Maintenance Booklet or indicated by the service interval indicator.

Fuel consumption also increases when driving in cold weather, in stop-start traffic and in hilly terrain.

Drinking and driving

WARNING

Drinking and driving and/or taking drugs and driving are very dangerous combinations. Even a small amount of alcohol or drugs can

affect your reflexes, perceptions and judgment.

The possibility of a serious or even fatal accident are greatly increased when you drink or take drugs and drive.

Do not drink or take drugs and drive or allow anyone to drive who has been drinking or taking drugs.

Pedals

WARNING

Objects in the driver's footwell can restrict the pedal travel or obstruct a depressed pedal. The operating and road safety of the vehicle is jeopardized. There is a risk of an accident.

Make sure that all objects in the vehicle are stowed correctly, and that they cannot enter the driver's footwell. Install the floormats securely and as specified in order to ensure sufficient clearance for the pedals. Do not use loose floormats and do not place floormats on top of one another.

Emission control

WARNING

Inhalation of exhaust gas is hazardous to your health. All exhaust gas contains carbon monoxide (CO), and inhaling it can cause unconsciousness and possible death.

Do not run the engine in confined areas (such as a garage) which are not properly ventilated. If you think that exhaust gas fumes are entering the vehicle while driving, have the cause determined and corrected immediately. If you must drive under these conditions, drive only with at least one window fully open at all times.

Certain engine systems are designed to keep the level of poisonous components in exhaust fumes within legal limits.

These systems only work at peak efficiency if they are serviced exactly in accordance with the manufacturer's specifications. For this reason, all work on the engine should only be carried out

by qualified and authorized Mercedes-Benz technicians.

The engine settings must not be changed under any circumstances. Furthermore, all specific service work must be carried out at regular intervals and in accordance with the Mercedes-Benz service requirements. Details can be found in the Maintenance Booklet.

Braking

Important safety notes

WARNING

If you activate the LOW off-road gear while driving on a slippery road surface, the wheels may lose traction:

- if you remove your foot from the accelerator pedal when driving
- if off road ABS intervenes when braking

If the wheels lose traction, the vehicle can no longer be steered. There is an increased danger of skidding and accidents.

Never activate the LOW off-road gear while driving on a slippery road surface.

Downhill gradients

 On long and steep gradients, you must reduce the load on the brakes by shifting early to a lower gear. This allows you to take advantage of the engine braking effect and helps avoid overheating and excessive wear of the brakes.

When you take advantage of the engine braking effect, a drive wheel may not turn for some time, e.g. on a slippery road surface. This could cause damage to the drive train. This type of damage is not covered by the Mercedes-Benz warranty.

Heavy and light loads

WARNING

If you rest your foot on the brake pedal while driving, the braking system can overheat. This increases the stopping distance and can even cause the braking system to fail. There is a risk of an accident.

Never use the brake pedal as a footrest. Never depress the brake pedal and the accelerator pedal at the same time.

- ! Depressing the brake pedal constantly results in excessive and premature wear to the brake pads.

If the brakes have been subjected to a heavy load, do not stop the vehicle immediately, but drive on for a short while. This allows the airflow to cool the brakes more quickly.

Wet roads

If driving in heavy rain for a prolonged period of time without braking, there may be a delayed reaction from the brakes when braking for the first time. This may also occur after the vehicle has been washed.

You have to depress the brake pedal more firmly. Maintain a greater distance from the vehicle in front.

After driving on a wet road or having the vehicle washed, brake firmly while paying attention to the traffic conditions. This will warm up the brake discs, thereby drying them more quickly and protecting them against corrosion.

Limited braking performance on salt-treated roads

If you drive on salted roads, a layer of salt residue may form on the brake discs and brake pads. This can result in a significantly longer braking distance.

- Brake occasionally to remove any possible salt residue. Make sure that you do not endanger other road users when doing so.
- Carefully depress the brake pedal at the beginning and end of a journey.
- Maintain a greater distance to the vehicle ahead.

Servicing the brakes

- ! If the brake warning lamp lights up in the instrument cluster and you hear a warning tone even though the parking brake has been released, the brake fluid level may be too low. Observe additional warning messages in the multifunction display.

The brake fluid level may be too low due to brake pad wear or leaking brake lines.

Have the brake system checked immediately. This work should be carried out at a qualified specialist workshop.

- ! A function or performance test should only be carried out on a 2-axle dynamometer. If you are planning to have the vehicle tested on such a dynamometer, contact an authorized Mercedes-Benz Center to obtain further information first. Otherwise, you could damage the drive train or the brake system.

- ! As the ESP® system operates automatically, the engine and the ignition must be switched off (the SmartKey must be in position **0** or **1** in the ignition lock) if the parking brake is tested on a brake dynamometer (for a maximum of ten seconds).

Braking applications triggered automatically by ESP® may otherwise seriously damage the brake system.

Mercedes-Benz recommends that you only have brake pads/linings installed on your vehicle which have been approved for Mercedes-Benz vehicles or which correspond to an equivalent quality standard. Brake pads/linings which have not been approved for Mercedes-Benz vehicles or which are not of an equivalent quality could affect your vehicle's operating safety.

Mercedes-Benz recommends that you only use brake fluid that has been specially approved for your vehicle by Mercedes-Benz, or which corresponds to an equivalent quality standard. Brake fluid which has not been approved for Mercedes-Benz vehicles or which is not of an equivalent quality could affect your vehicle's operating safety.

All checks and maintenance work on the brake system must be carried out at a qualified specialist workshop.

Have brake pads installed and brake fluid replaced at a qualified specialist workshop.

If your brake system is subject only to moderate loads, you should test the functionality of your brakes at regular intervals by pressing firmly on the brake pedal at high speeds. This improves the grip of the brake pads.

You can find a description of Brake Assist (BAS) on (> page 56).

High-performance brake system for AMG vehicles

The high-performance brake system is only installed on the G 63 AMG and the G 65 AMG. The high-performance brake system is designed for heavy loads. This may lead to noise when braking. This will depend on:

- Speed
- Braking force
- Environmental conditions, such as temperature and humidity

The wear of individual components of the brake system, such as the brake pads/linings or brake discs, depends on the individual driving style and operating conditions.

For this reason, it is impossible to state a mileage that will be valid under all circumstances. An aggressive driving style will lead to high wear. You can obtain further information about this from your authorized Mercedes-Benz Center.

New and replaced brake pads and discs only reach their optimum braking effect after several hundred kilometers of driving. Compensate for this by applying greater force to the brake pedal. Keep this in mind, and adapt your driving and braking accordingly during this break-in period. Excessive heavy braking results in correspondingly high brake wear. Observe the brake system warning lamp in the instrument cluster and note any brake status messages in the multifunction display. For high-performance driving in particular, it is important to maintain and have the brake system checked regularly.

Parking brake

WARNING

If you must brake the vehicle with the parking brake, the braking distance is considerably longer and the wheels could lock. There is an increased danger of skidding and accidents.

Only use the parking brake to brake the vehicle when the service brake is faulty. Do not apply the parking brake too firmly. If the wheels lock, release the parking brake until the wheels begin turning again.

If you brake the vehicle with the parking brake, the brake lamps will not light up.

If you drive on wet roads or dirt-covered surfaces, road salt and/or dirt could get into the parking brake.

In order to prevent corrosion and a reduction in the braking power of the parking brake, observe the following:

- pull the parking brake upwards with the release button depressed from time to time before beginning the journey (▷ page 131).
- drive for approximately 110 yds (100 m) at a maximum speed of 12 mph (20 km/h)

Driving on wet roads

Hydroplaning

If water has accumulated to a certain depth on the road surface, there is a danger of hydroplaning occurring, even if:

- you drive at low speeds.
- the tires have adequate tread depth.

For this reason, in the event of heavy rain or in conditions in which hydroplaning may occur, you must drive in the following manner:

- lower your speed.
- avoid ruts.
- brake carefully.

Driving on flooded roads

! Do not drive through flooded areas. Check the depth of any water before driving through it. Drive slowly through standing water. Otherwise, water may enter the vehicle interior or the engine compartment. This can damage the electronic components in the engine or the automatic transmission. Water can also be drawn in by the engine's air suction nozzles and this can cause engine damage.

If you have to drive on stretches of road on which water has collected, please bear in mind that:

- the maximum permissible still water depth depends on the vehicle equipment
- you should drive no faster than at a walking pace

Off-road fording

! Under no circumstances should you accelerate before entering the water. The bow

wave could cause water to enter and damage the engine and other assemblies.

! Do not open any of the vehicle's doors while fording. Otherwise, water could get into the vehicle interior and damage the vehicle's electronics and interior equipment.

i You may only drive through fresh water.

- Observe the safety notes (▷ page 137) and the general notes (▷ page 137) on off-road driving.
- Establish how deep the water is and the characteristics of the body of water before fording.
- Switch off the air-conditioning system.
- Shift the transfer case to **LOW RANGE** (▷ page 162).
- Engage the differential locks, if necessary (▷ page 165).
- Restrict the shift range to **1** or **2** (▷ page 123).
- Avoid high engine speeds.
- Enter and exit the water at a flat place and at a steady walking pace.
- Drive slowly and at an even speed through the water.
- Do not stop and do not switch off the engine.
- Water offers a high degree of resistance, and the ground is slippery and in some cases unstable. Therefore, it is difficult and dangerous to pull away in the water.
- Ensure that a bow wave does not form as you drive.
- Clean any mud from the tire tread after fording.
- Apply the brakes to dry them after fording.

Always observe the fording depth values (▷ page 296).

Winter driving

General notes

DANGER

If the exhaust pipe is blocked or adequate ventilation is not possible, poisonous gases such as carbon monoxide (CO) may enter the vehicle. This is the case, e.g. if the vehicle

becomes trapped in snow. There is a risk of fatal injury.

If you leave the engine or the auxiliary heating running, make sure the exhaust pipe and area around the vehicle are clear of snow. To ensure an adequate supply of fresh air, open a window on the side of the vehicle that is not facing into the wind.

WARNING

If you have installed unsuitable snow chains to the front wheels, they may drag against the vehicle body or chassis components. This could cause damage to the vehicle or the tires. There is a risk of an accident.

Only equip the front wheels with suitable snow chains that guarantee sufficient distance to the vehicle body and to the suspension components in every driving situation. Always follow the manufacturer's installation instructions when installing the snow chains.

Have your vehicle winter-proofed at a qualified specialist workshop at the onset of winter. Observe the notes in the "Winter operation" section (▷ page 264).

Driving with summer tires

Observe the notes in the "Winter operation" section (▷ page 264).

Slippery road surfaces

WARNING

If you shift down on a slippery road surface in an attempt to increase the engine's braking effect, the drive wheels could lose their grip. There is an increased danger of skidding and accidents.

Do not shift down for additional engine braking on a slippery road surface.

⚠ WARNING

If you activate the LOW off-road gear while driving on a slippery road surface, the wheels may lose traction:

- if you remove your foot from the accelerator pedal when driving
- if off road ABS intervenes when braking

If the wheels lose traction, the vehicle can no longer be steered. There is an increased danger of skidding and accidents.

Never activate the LOW off-road gear while driving on a slippery road surface.

Drive particularly carefully on slippery road surfaces. Avoid sudden acceleration, steering and braking maneuvers. Do not use cruise control. If the vehicle threatens to skid or cannot be stopped when moving at low speed:

- ▶ Shift the transmission to position **N**.
- ▶ Try to bring the vehicle under control using corrective steering.

The outside temperature indicator is not designed to serve as an ice-warning device and is therefore unsuitable for that purpose. Changes in the outside temperature are displayed after a short delay.

Indicated temperatures just above the freezing point do not guarantee that the road surface is free of ice. The road may still be icy, especially in wooded areas or on bridges. You should pay special attention to road conditions when temperatures are around the freezing point.

For more information on driving with snow chains, see (▷ page 264).

Off-road driving**Important safety notes****⚠ WARNING**

Do not load items on the basic carrier bars. It may cause instability during some maneuvers which could result in an accident.

Drive slowly in unknown terrain. This will make it easier to recognize unexpected obstacles and avoid damage to the vehicle.

To help avoid the vehicle rolling over, never turn it around on steep inclines. If the vehicle cannot complete the attempted climb, back it down in reverse gear.

Do not drive along the side of a slope. The vehicle might otherwise rollover. If in doing so the vehicle begins to show a tendency to roll, immediately steer into a line of gravity (straight up or downhill).

Never let the vehicle roll backwards in idle. You may lose control of the vehicle if you use only the service brake. For information on driving downhill, see "Driving downhill".

When driving off-road, sand, mud and water, possibly mixed with oil, for example, could get into the brakes. This could result in a reduced braking effect or in total brake failure and also in increased wear and tear. The braking characteristics change depending on the material ingressing the brakes. Clean the brakes after driving off-road. If you detect a reduced braking effect or grinding noises, have the brake system checked in a qualified specialist workshop as soon as possible. Adapt your driving style to the different braking characteristics.

Driving off-road increases the likelihood of damage to the vehicle, which, in turn, can lead to failure of the mechanical assembly or systems. Adapt your driving style to suit the terrain conditions. Drive carefully. Have damage to the vehicle rectified immediately at a qualified specialist workshop.

General notes**Ⓢ Environmental note**

Protection of the environment is of primary importance. Treat nature with respect. Observe all prohibiting signs.

Read this section carefully before driving your vehicle off-road. Practice by driving over more gentle off-road terrain first.

Familiarize yourself with the characteristics of your vehicle and the gear shift operation before driving through difficult terrain.

The following driving systems are specially adapted to off-road driving:

- 4ETS (▷ page 57)
- Transfer case (▷ page 162)
- Differential locks (▷ page 162)

Observe the following notes:

- stop your vehicle and, if necessary, shift the transfer case to **LOW RANGE** (▷ page 162) before driving off-road.
- in transfer case position **LOW RANGE** the ECO start/stop function is not available (▷ page 114).
- engage the differential locks, if necessary (▷ page 165).

i ABS, 4ETS, ESP® and BAS are deactivated while the differential locks are engaged. This allows the front wheels to lock briefly, so that these can dig into a loose surface. However, please note that locked wheels skid and can no longer steer.

- Check that items of luggage and loads are stowed safely and are well secured (▷ page 219).
- To avoid damaging the vehicle, make sure there is always sufficient ground clearance.
- Always keep the engine running and in gear when driving on a downhill gradient.
- Always keep the engine running and in gear when driving on a slope.
- Drive slowly and evenly, if necessary at a walking pace.
- Ensure that the wheels are in contact with the ground at all times.
- Drive with extreme care on unfamiliar off-road routes where visibility is poor. For safety reasons, get out of the vehicle first and survey the off-road route.
- Check the depth of water before fording rivers and streams.
- When fording, do not stop and do not switch off the engine.
- Look out for obstacles, such as rocks, holes, tree stumps and furrows.
- Always keep the doors, rear door, side windows and the sliding sunroof closed while the vehicle is in motion.
- Switch off cruise control.
- Do not stray from marked routes or paths.

- Adapt your speed to the terrain. The rougher, steeper or more ruts on the terrain, the slower your speed should be.
- Drive slowly and at an even speed through the water. Ensure that a bow wave does not form as you drive.
- On sand, drive quickly to overcome the rolling resistance. Otherwise the vehicle's wheels could become stuck in loose ground.
- Do not jump with the vehicle as this will interrupt the vehicle's propulsion.
- Avoid high engine speeds. Drive at appropriate engine speeds (maximum 3,000 rpm).
- Do not shift the automatic transmission to transmission position **N**.
- Always check the vehicle for damage after off-road driving.

i Information about retrofitting special all-terrain tires is available from any qualified specialist workshop.

i Do not use the HOLD function when driving off-road, on steep uphill or downhill gradients or on slippery or loose surfaces. The HOLD function cannot hold the vehicle on such surfaces.

Checklist before driving off-road

- !** If the engine oil warning lamp lights up while the vehicle is in motion, stop the vehicle in a safe place as soon as possible. Check the engine oil level. The engine oil warning lamp warning must not be ignored. Continuing the journey while the symbol is displayed could lead to engine damage.
- ▶ **Oil level:** check the engine oil level and add oil if necessary. Only then does the engine receive enough oil when the vehicle is on a steep incline.
- ▶ **Tire-changing tool kit:** check that the jack is working and make sure you have the lug wrench, a robust tow cable and a folding spade in the vehicle.
- ▶ **Wheels and tires:** check the tire tread depth and tire pressure.
- ▶ Check for damage and remove any foreign objects, e.g. small stones, from the wheels/tires.
- ▶ Replace any missing valve caps.

- ▶ Replace dented or damaged wheels.
- ▶ Carry a sound spare wheel.

Checklist after driving off-road

Driving over rough terrain places greater demands on your vehicle than driving on normal roads. After driving off-road, check the vehicle. This allows you to detect damage promptly and reduce the risk of an accident to yourself and other road users.

- ▶ Shift the transfer case to **HIGH RANGE** (▷ page 162).
- ▶ Disengage the differential locks (▷ page 166).
- ▶ Clean the headlamps and rear lights and check for damage.
- ▶ Clean the front and rear license plates.
- ▶ Clean the wheels and tires with a water jet and remove any foreign objects.
- ▶ Clean the wheels, tires, wheel housings and the vehicle underside with a water jet; check for any foreign objects and damage.
- ▶ Check whether twigs or other parts of plants have become trapped. These increase the risk of fire and can damage fuel pipes, brake hoses or the rubber bellows of the axle joints and propeller shafts.
- ▶ After the trip, examine without fail the entire undercarriage, wheels, tires, brakes, body-work structure, steering, chassis and exhaust system for damage.
- ▶ After driving for extended periods across sand, mud, gravel, water or in similarly dirty conditions, have the brake discs, wheels, brake pads/linings and axle joints checked and cleaned.
- ▶ If you notice strong vibrations after off-road driving, check for foreign objects in the wheels and drive train and, if necessary, remove them.
Foreign objects can disturb the balance and cause vibrations.
- ▶ Test the brakes.

Driving on sand

Observe the following rules when driving on sand:

- Shift the transfer case to **LOW RANGE** (▷ page 162).
- Avoid high engine speeds.
- Limit the shift range of the automatic transmission according to the off-road conditions.
- Drive quickly to overcome the rolling resistance. Otherwise the vehicle's wheels could become stuck in loose ground.
- Drive in the tracks of other vehicles if possible. When doing so, make sure that:
 - the tire ruts are not too deep.
 - the sand is sufficiently firm.
 - your vehicle has sufficient ground clearance

Tire ruts and gravel roads

- ! Check that the ruts are not too deep and that your vehicle has sufficient clearance. Otherwise, your vehicle could be damaged or bottom out and get stuck.

Observe the following rules when driving along ruts in off-road terrain or on roads with loose gravel:

- Shift the transfer case to **LOW RANGE** (▷ page 162).
- Avoid high engine speeds.
- Observe the safety notes (▷ page 137) and the general notes (▷ page 137) on off-road driving.
- Restrict the shift range of the automatic transmission to **1** (▷ page 123).
- Drive slowly.
- Where ruts are too deep, drive with the wheels of one side on the center grassy area, if possible.

Driving over obstacles

- ! Obstacles could damage the floor of the vehicle or components of the chassis. Ask passengers for guidance when driving over large obstacles. The passenger should always keep a safe distance from the vehicle when doing so in order to avoid injury as a result of unexpected vehicle movements. After driving off-road or over obstacles, check the vehicle

for possible damage, especially to the underbody and the components of the chassis.

! Drive with particular care when driving over an obstacle while driving up or down a steep slope.

The vehicle could otherwise tilt and slide sideways or tip over.

Observe the following rules when driving over tree stumps, large stones and other obstacles:

- Observe the safety notes (▷ page 137) and the general notes (▷ page 137) on off-road driving.
- Shift the transfer case to **LOW RANGE** (▷ page 162).
- Avoid high engine speeds.
- Restrict the shift range to **1** (▷ page 123).
- Make sure that you have enough ground clearance before driving across an obstacle.
- Drive very slowly.
- Try to drive straight over the center of obstacles: front wheel first, then rear wheel.

Traveling uphill

Approach/departure angle

WARNING

If you drive on a steep incline at an angle or turn when driving on an incline, the vehicle could slip sideways, tip and rollover. There is a risk of an accident.

Always drive on a steep incline in the line of fall (straight up or down) and do not turn the vehicle.

Always observe the approach/departure angle values (▷ page 296).

- Observe the safety notes (▷ page 137) and the general notes (▷ page 137) on off-road driving.
- Do not drive at an angle on slopes, inclines or gradients, but instead follow the direct line of fall. Note that the climbing ability of your vehicle depends on the terrain conditions.
- Before driving on extreme uphill and downhill gradients, shift the transfer case to **LOW RANGE** (▷ page 162).
- Engage the differential locks, if necessary (▷ page 165).

- Drive slowly.
- Accelerate gently and make sure that the wheels are gripping.
- Avoid high engine speeds, except when driving on sandy and muddy routes with high driving resistance.
- Avoid high engine speeds – drive at an appropriate engine speed (maximum 3,000 rpm).
- When driving down an incline, make use of the engine's braking effect. Observe the engine speed; do not overrev the engine.

i Further information on the maximum engine speed: (▷ page 171).

- Select a shift range appropriate to the gradient.
- Before tackling steep downhill gradients, select shift range **1** (▷ page 123).
- Always check the brakes after driving off-road.

i Hill start assist will aid you when pulling away on a hill.

For more information, see "Hill start assist" (▷ page 114).

Maximum gradient-climbing capability

Always observe the maximum gradient climbing ability values (▷ page 297).

Hilltops

When driving on an uphill gradient, reduce pressure slightly on the accelerator immediately before reaching the top of the hill (do not shift the transmission to position **N**). Use the vehicle's own impetus to drive over the top of the hill.

This style of driving prevents:

- the vehicle from lifting off the ground on the brow of a hill
- loss of traction
- the vehicle from traveling too quickly down the other side

Driving downhill

- Before tackling steep downhill gradients, select shift range **1** (▷ page 123).

This way you use the engine's braking effect to reduce the speed. If this is not sufficient, brake gently. When doing so, make sure that

the vehicle is facing in the direction of the line of fall.

- Observe the notes on driving in mountainous terrain (▷ page 140).
- Drive slowly.
- Do not drive at an angle down steep inclines. Steer into the line of fall and drive with the front wheels aligned straight. Otherwise, the vehicle could slip sideways, tip and roll over.
- Check that the brakes are working normally after a long downhill stretch.

i The special off-road ABS setting (▷ page 56) enables repeated, brief, precise locking of the front wheels, which leads to the wheels digging into the loose ground. Note that when the front wheels are fully braked, they slide easily over the surface of the ground, making it difficult to steer.

Driving systems

Cruise control

Important safety notes

WARNING

The brake pedal moves when cruise control brakes the vehicle. A foot in the area under the brake pedal could become trapped. The movement of the pedal, and therefore the vehicle's ability to brake, may be restricted by objects in the area under the brake. There is a risk of an accident and injury.

Do not place your foot under the brake pedal. Keep the area under the brake pedal free from obstructions.

If you fail to adapt your driving style, cruise control can neither reduce the risk of accident nor override the laws of physics. Cruise control cannot take account of road, weather and traffic conditions. Cruise control is only an aid. You are responsible for the distance to the vehicle in front, for vehicle speed and for braking in good time. Adjust your driving style to the traffic conditions. Only engage cruise control when the current road, weather and traffic conditions permit it to be done safely. Drive carefully and maintain a suitable distance to the vehicle in front.

Do not use cruise control:

- in traffic conditions that do not allow you to drive at a constant speed, e.g. heavy traffic, on winding roads or off-road
- on slippery road surfaces. Braking or accelerating could cause the drive wheels to lose traction and the vehicle could then skid
- when there is poor visibility, e.g. due to fog, heavy rain or snow

General notes

Cruise control maintains a constant road speed for you. On long and steep downhill gradients, especially if the vehicle is laden, you must select shift range **1**, **2** or **3** in good time. By doing so, you will make use of the braking effect of the engine. This relieves the load on the brake system and prevents the brakes from overheating and wearing too quickly.

Use cruise control only if road and traffic conditions make it appropriate to maintain a steady speed for a prolonged period. You can store any road speed above 20 mph (30 km/h).

i Cruise control should not be activated when driving off-road.

Cruise control lever

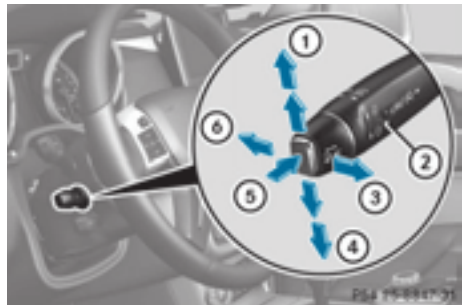

- ① To activate or increase speed
- ② LIM indicator lamp
- ③ To activate at the current speed/last stored speed
- ④ To activate or reduce speed
- ⑤ To switch between cruise control and variable SPEEDTRONIC
- ⑥ To deactivate cruise control

You can operate cruise control and variable SPEEDTRONIC with the cruise control lever.

When you activate cruise control, the stored speed is shown in the multifunction display for five seconds.

The LIM indicator lamp on the cruise control lever indicates which system you have selected:

- **LIM indicator lamp off:** cruise control is selected.
- **LIM indicator lamp on:** variable SPEEDTRONIC is selected.

Activation conditions

To activate cruise control, all of the following activation conditions must be fulfilled:

- the parking brake must be released.
- you are driving faster than 20 mph (30 km/h).
- ESP® must be active, but not intervening.
- the transmission must be in position **D**.

Selecting cruise control

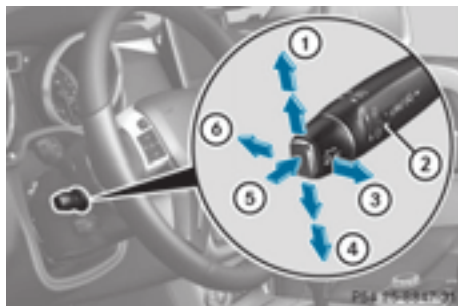

- ① To activate or increase speed
 - ② LIM indicator lamp
 - ③ To activate at the current speed/last stored speed
 - ④ To activate or reduce speed
 - ⑤ To switch between cruise control and variable SPEEDTRONIC
 - ⑥ To deactivate cruise control
- ▶ Check whether LIM indicator lamp ② is off. If it is off, cruise control is already selected. If it is not, press the cruise control lever in the direction of arrow ⑤. LIM indicator lamp ② in the cruise control lever goes out. Cruise control is selected.

Storing, maintaining and calling up a speed

Storing and maintaining the current speed

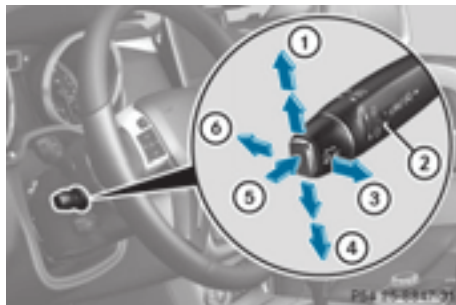

- ① To activate or increase speed
- ② LIM indicator lamp
- ③ To activate at the current speed/last stored speed
- ④ To activate or reduce speed
- ⑤ To switch between cruise control and variable SPEEDTRONIC
- ⑥ To deactivate cruise control

You can store the current speed if you are driving faster than 20 mph (30 km/h).

- ▶ Accelerate the vehicle to the desired speed.
- ▶ Briefly press the cruise control lever up ① or down ④.
- ▶ Remove your foot from the accelerator pedal. Cruise control is activated. The vehicle automatically maintains the stored speed.

- i** Cruise control may be unable to maintain the stored speed on uphill and downhill gradients. The stored speed is resumed when the gradient levels out. Cruise control maintains the stored speed on downhill gradients by automatically applying the brakes.

Calling up the stored speed

WARNING

If you call up the stored speed and it is lower than the current speed, the vehicle decelerates. If you do not know the stored speed, the vehicle could decelerate unexpectedly. There is a risk of an accident.

Pay attention to the road and traffic conditions before calling up the stored speed. If you

do not know the stored speed, store the desired speed again.

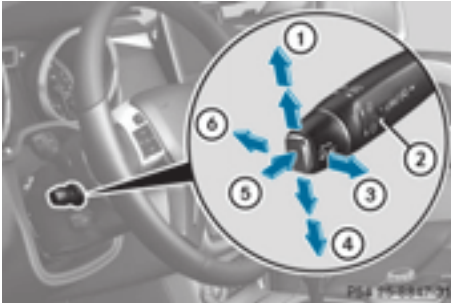

- ① To activate or increase speed
- ② LIM indicator lamp
- ③ To activate at the current speed/last stored speed
- ④ To activate or reduce speed
- ⑤ To switch between cruise control and variable SPEEDTRONIC
- ⑥ To deactivate cruise control

- ▶ Briefly pull the cruise control lever towards you ③.
- ▶ Remove your foot from the accelerator pedal. Cruise control is activated and adjusts the vehicle's speed to the last speed stored.

i If no speed is stored, cruise control stores the current speed and maintains it.

Setting a speed

Adjusting

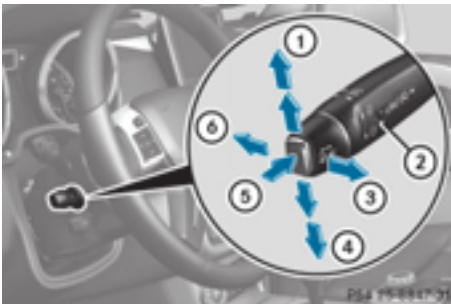

- ① To activate or increase speed
- ② LIM indicator lamp
- ③ To activate at the current speed/last stored speed

- ④ To activate or reduce speed
- ⑤ To switch between cruise control and variable SPEEDTRONIC
- ⑥ To deactivate cruise control

Keep in mind that it may take a brief moment until the vehicle accelerates or decelerates to the set speed.

- ▶ **To increase the speed:** press the cruise control lever up ①.
- ▶ **To decrease the speed:** press the cruise control lever down ④.
- ▶ Keep the cruise control lever pressed until the desired speed is reached.
- ▶ Release the cruise control lever. The new speed is stored.

Making adjustments in 1 mph increments (1 km/h increments in Canada)

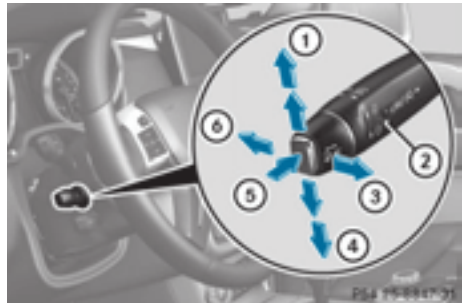

- ① To activate or increase speed
- ② LIM indicator lamp
- ③ To activate at the current speed/last stored speed
- ④ To activate or reduce speed
- ⑤ To switch between cruise control and variable SPEEDTRONIC
- ⑥ To deactivate cruise control

- ▶ Briefly press the cruise control lever up ① for a higher speed or down ④ for a lower speed. The last speed stored is increased or reduced.

or

- ▶ Keep the cruise control lever pressed until the desired speed is reached. Press the cruise control lever up ① for a higher speed or down ④ for a lower speed.

Making adjustments in 5 mph increments (10 km/h increments):

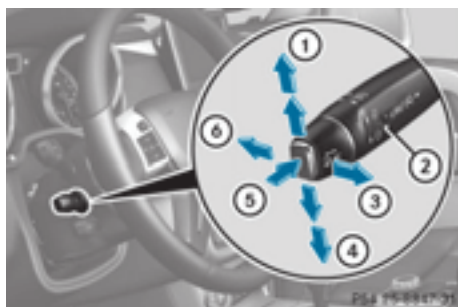

- ① To activate or increase speed
- ② LIM indicator lamp
- ③ To activate at the current speed/last stored speed
- ④ To activate or reduce speed
- ⑤ To switch between cruise control and variable SPEEDTRONIC
- ⑥ To deactivate cruise control

- ▶ Briefly press the cruise control lever up ① or down ④ to beyond the pressure point. The last speed stored is increased or reduced.
- or
- ▶ Keep the cruise control lever pressed until the desired speed is reached. Press the cruise control lever up ① for a higher speed or down ④ for a lower speed.

i Cruise control is not deactivated if you depress the accelerator pedal. For example, if you accelerate briefly to overtake, cruise control adjusts the vehicle's speed to the last speed stored after you have finished overtaking.

Deactivating cruise control

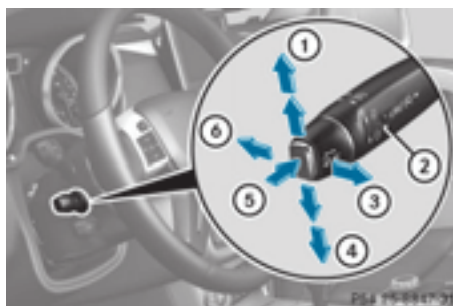

- ① To activate or increase speed
- ② LIM indicator lamp
- ③ To activate at the current speed/last stored speed
- ④ To activate or reduce speed
- ⑤ To switch between cruise control and variable SPEEDTRONIC
- ⑥ To deactivate cruise control

There are several ways to deactivate cruise control:

- ▶ Briefly press the cruise control lever forwards ⑥.
- or
- ▶ Brake.
- or
- ▶ Briefly press the cruise control lever in the direction of arrow ⑤. Variable SPEEDTRONIC is selected. LIM indicator lamp ② in the cruise control lever lights up.

Cruise control is automatically deactivated if:

- you apply the parking brake
- you are driving at less than 20 mph (30 km/h)
- ESP® intervenes or you deactivate ESP®
- you shift the transmission to position **N** while driving

i The last speed stored is cleared when you switch off the engine.

SPEEDTRONIC

Important safety notes

WARNING

If you rest your foot on the brake pedal while driving, the braking system can overheat. This increases the stopping distance and can even cause the braking system to fail. There is a risk of an accident.

Never use the brake pedal as a footrest. Never depress the brake pedal and the accelerator pedal at the same time.

- !** Depressing the brake pedal constantly results in excessive and premature wear to the brake pads.

If you fail to adapt your driving style, SPEEDTRONIC can neither reduce the risk of accident nor override the laws of physics. SPEEDTRONIC cannot take account of road, weather and traffic conditions. SPEEDTRONIC is only an aid. You are responsible for the distance to the vehicle in front, for vehicle speed, for braking in good time and for staying in lane. Only engage SPEEDTRONIC when the current road, weather and traffic conditions permit it to be done safely. Drive carefully and maintain a suitable distance to the vehicle in front.

General notes

SPEEDTRONIC brakes automatically so that you do not exceed the set speed. On long and steep downhill gradients, especially if the vehicle is laden or towing a trailer, you must select shift range **1**, **2** or **3** in good time. By doing so, you will make use of the braking effect of the engine, which relieves the load on the brake system and prevents the brakes from overheating and wearing too quickly. If you need additional braking, depress the brake pedal repeatedly rather than continuously.

- i** The speed indicated in the speedometer may differ slightly from the limit speed stored.

Cruise control lever

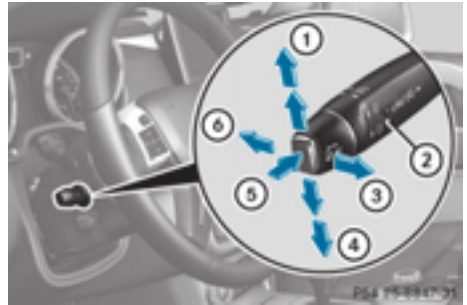

- ① To store the current speed or a higher speed
- ② LIM indicator lamp
- ③ To call up the last speed stored
- ④ To store the current speed or a lower speed
- ⑤ To switch between cruise control and variable SPEEDTRONIC
- ⑥ To deactivate variable SPEEDTRONIC

You can operate cruise control and variable SPEEDTRONIC with the cruise control lever.

The LIM indicator lamp on the cruise control lever indicates which system you have selected:

- **LIM indicator lamp off:** cruise control is selected.
- **LIM indicator lamp on:** variable SPEEDTRONIC is selected.

You can use the cruise control lever to limit the speed to any speed above 30 km/h while the engine is running.

Selecting variable SPEEDTRONIC

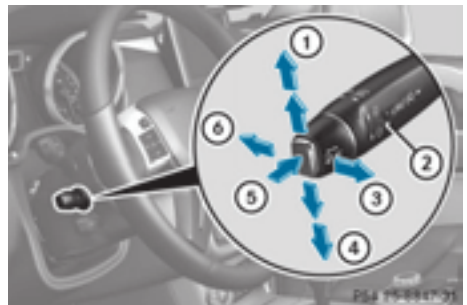

- ① To activate or increase speed
- ② LIM indicator lamp
- ③ To activate at the current speed/last stored speed
- ④ To activate or reduce speed

- ⑤ To switch between cruise control and variable SPEEDTRONIC
- ⑥ To deactivate cruise control

If you fail to adapt your driving style, SPEEDTRONIC can neither reduce the risk of accident nor override the laws of physics. SPEEDTRONIC cannot take account of road, weather and traffic conditions. SPEEDTRONIC is only an aid. You are responsible for the distance to the vehicle in front, for vehicle speed, for braking in good time and for staying in lane. Only engage SPEEDTRONIC when the current road, weather and traffic conditions permit it to be done safely. Drive carefully and maintain a suitable distance to the vehicle in front.

- ▶ Check whether LIM indicator lamp ② is on. If it is on, variable SPEEDTRONIC is already selected.

If it is not, press the cruise control lever in the direction of arrow ⑤.

LIM indicator lamp ② in the cruise control lever lights up. Variable SPEEDTRONIC is selected.

Storing the current speed

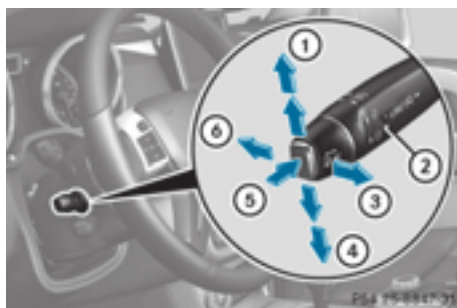

- ① To activate or increase speed
- ② LIM indicator lamp
- ③ To activate at the current speed/last stored speed
- ④ To activate or reduce speed
- ⑤ To switch between cruise control and variable SPEEDTRONIC
- ⑥ To deactivate cruise control

You can use the cruise control lever to limit the speed to any speed above 18 mph while the engine is running.

- ▶ Briefly press the cruise control lever up ① or down ④.

The current speed is stored and shown in the multifunction display.

Calling up the last speed stored

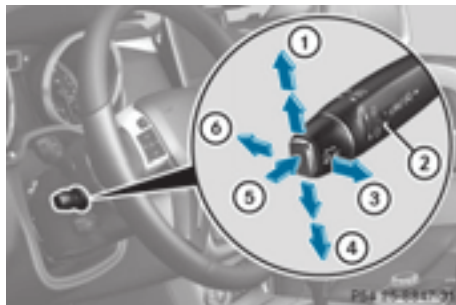

- ① To activate or increase speed
- ② LIM indicator lamp
- ③ To activate at the current speed/last stored speed
- ④ To activate or reduce speed
- ⑤ To switch between cruise control and variable SPEEDTRONIC
- ⑥ To deactivate cruise control

If you fail to adapt your driving style, SPEEDTRONIC can neither reduce the risk of accident nor override the laws of physics. SPEEDTRONIC cannot take account of road, weather and traffic conditions. SPEEDTRONIC is only an aid. You are responsible for the distance to the vehicle in front, for vehicle speed, for braking in good time and for staying in your lane. Only activate SPEEDTRONIC when the prevailing road, weather and traffic conditions permit. Drive carefully and maintain a suitable distance to the vehicle in front.

- ▶ Briefly pull the cruise control lever towards you ③.

i If you call up the stored speed and your current speed is higher, you will hear a warning tone. You will see the **Limit Exceeded** message in the multifunction display.

i If no speed is stored, variable SPEEDTRONIC stores the current speed and maintains it.

Deactivating variable SPEEDTRONIC

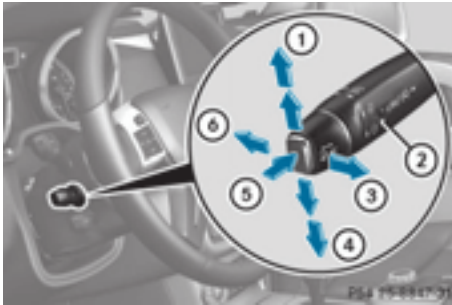

There are several ways to deactivate variable SPEEDTRONIC:

▶ Briefly press the cruise control lever forwards **⑥**.

or

▶ Briefly press the cruise control lever in the direction of arrow **⑤**.
LIM indicator lamp **②** in the cruise control lever goes out. Variable SPEEDTRONIC is deactivated.

Cruise control is selected.

It is not possible to deactivate variable SPEEDTRONIC by braking.

If you depress the accelerator pedal beyond the pressure point (kickdown), variable SPEEDTRONIC is automatically deactivated. but only if your current speed does not differ by more than 12 mph from the stored speed. You will hear a warning tone if this is the case.

DISTRONIC PLUS

Important safety notes

WARNING

DISTRONIC PLUS does not react to:

- people or animals
- stationary obstacles on the road, e.g. stopped or parked vehicles
- oncoming and crossing traffic

As a result, DISTRONIC PLUS may neither give warnings nor intervene in such situations.

There is a risk of an accident.

Always pay careful attention to the traffic situation and be ready to brake.

WARNING

DISTRONIC PLUS cannot always clearly identify other road users and complex traffic situations.

In such cases, DISTRONIC PLUS may:

- give an unnecessary warning and then brake the vehicle
- neither give a warning nor intervene
- accelerate or brake unexpectedly

There is a risk of an accident.

Continue to drive carefully and be ready to brake, in particular when warned to do so by DISTRONIC PLUS.

WARNING

DISTRONIC PLUS brakes your vehicle with up to 40% of the maximum braking force. If this braking force is insufficient, DISTRONIC PLUS warns you visually and audibly. There is a risk of an accident.

In such cases, apply the brakes yourself and try to take evasive action.

WARNING

If you call up the stored speed and it differs from the current speed, the vehicle accelerates or decelerates. If you do not know the stored speed, the vehicle could accelerate or brake unexpectedly. There is a risk of an accident.

Pay attention to the road and traffic conditions before calling up the stored speed. If you do not know the stored speed, store the desired speed again.

If you fail to adapt your driving style, DISTRONIC PLUS can neither reduce the risk of accident nor override the laws of physics. DISTRONIC PLUS cannot take account of road, weather and traffic conditions. DISTRONIC PLUS is only an aid. You are responsible for the distance to the vehicle in front, for vehicle speed, for braking in good time and for staying in your lane. Only engage DISTRONIC PLUS when the current road, weather and traffic conditions permit it to be done safely, and adapt your driving style accord-

ingly. Drive carefully and maintain a suitable distance to the vehicle in front.

When DISTRONIC PLUS detects a risk of collision with the vehicle in front but is unable to sufficiently decelerate the vehicle in order to maintain the set distance from the vehicle in front, you will be warned visually and acoustically. DISTRONIC PLUS cannot prevent a collision without your intervention. An intermittent warning tone will then sound and the distance warning lamp will light up in the instrument cluster. Brake immediately in order to increase the distance from the vehicle in front, or take evasive action, provided it is safe to do so.

DISTRONIC PLUS may not detect narrow vehicles driving in front, e.g. motorcycles, or vehicles driving on a different line. Therefore, always pay attention to traffic conditions even when DISTRONIC PLUS is activated. Otherwise, you may fail to recognize dangers in time, cause an accident and injure yourself and others.

In particular, the detection of obstacles can be impaired if:

- the sensor is dirty or covered
- there is snow or heavy rain
- there is interference by other radar sources
- there is the possibility of strong radar reflections, for example, in parking garages.

If DISTRONIC PLUS is activated, the vehicle brakes automatically in certain situations. This can happen unexpectedly, especially when towing or in a car wash. There is a risk of an accident. In these or similar situations, deactivate DISTRONIC PLUS.

If you want DISTRONIC PLUS to assist you, the following activation conditions must be fulfilled (> page 149) and the radar sensor system must be operational.

General notes

DISTRONIC PLUS regulates the speed and automatically helps you maintain the distance to the vehicle detected in front. DISTRONIC PLUS brakes automatically so that the set speed is not exceeded.

On long and steep downhill gradients, especially if the vehicle is laden or towing a trailer, you must select shift range **1**, **2** or **3** in good time. By doing so, you will make use of the braking effect of the engine. This relieves the load on the brake system and prevents the brakes from overheating and wearing too quickly.

If DISTRONIC PLUS detects a slower-moving vehicle in front, your vehicle is braked in order to maintain the preset distance to the vehicle in front.

If there is no vehicle in front, DISTRONIC PLUS operates in the same way as cruise control in the speed range between 20 mph (Canada: 30 km/h) and 120 mph (Canada: 200 km/h). If a vehicle is driving in front of you, it operates in the speed range between 0 mph (0 km/h) and 120 mph (Canada: 200 km/h).

Do not use DISTRONIC PLUS while driving on roads with steep gradients.

As DISTRONIC PLUS transmits radar waves, it can resemble the radar detectors of the responsible authorities. You can refer to the relevant chapter in the Operator's Manual if questions are asked about this.

i USA only:

This device has been approved by the FCC as a "Vehicular Radar System". The radar sensor is intended for use in an automotive radar system only. Removing, tampering with, or altering the device will void any warranties, and is not permitted by the FCC. Do not tamper with, alter, or use in any non-approved way.

Any unauthorized modification to this device could void the user's authority to operate the equipment.

i Canada only: This device complies with RSS-210 of Industry Canada. Operation is subject to the following two conditions:

1. This device may not cause harmful interference, and
2. This device must accept any interference received, including interference that may cause undesired operation of the device.

Removal, tampering, or altering of the device will void any warranties, and is not permitted. Do not tamper with, alter, or use in any non-approved way.

Any unauthorized modification to this device could void the user's authority to operate the equipment.

Cruise control lever

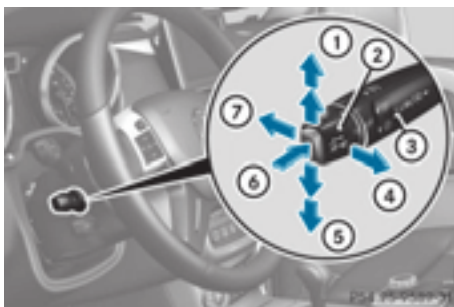

- ① To activate or increase speed
- ② To set the specified minimum distance
- ③ LIM indicator lamp
- ④ To activate at the current speed/last stored speed
- ⑤ To activate or reduce speed
- ⑥ To switch between DISTRONIC PLUS and variable SPEEDTRONIC
- ⑦ To deactivate DISTRONIC PLUS

With the cruise control lever, you can operate DISTRONIC PLUS and variable SPEEDTRONIC.

- ▶ **To switch between variable SPEEDTRONIC and DISTRONIC PLUS:** press the cruise control lever in the direction of arrow ⑥.

LIM indicator lamp ③ on the cruise control lever indicates which function you have selected:

- **LIM indicator lamp ③ off:** DISTRONIC PLUS is selected.
- **LIM indicator lamp ③ on:** variable SPEEDTRONIC is selected.

Activating DISTRONIC PLUS

Activation conditions

In order to activate DISTRONIC PLUS, the following conditions must be fulfilled:

- the engine must be started. It may take up to two minutes after pulling away before DISTRONIC PLUS is operational.
- the parking brake must be released.
- the differential lock must be disengaged.
- ESP® must be active, but not intervening.
- the transmission must be in position **D**.

- the driver's door must be closed when you shift from **P** to **D** or your seat belt must be fastened.
- the front-passenger door and rear doors must be closed.
- the vehicle must not skid.
- the DISTRONIC PLUS function must be selected (▷ page 149).
- the transfer case must be in the **HIGH RANGE** transmission position.
- the vehicle must not be on an uphill or downhill gradient of more than 22-25%.
- the radar sensor must be free from dirt (▷ page 244).

Activating while driving

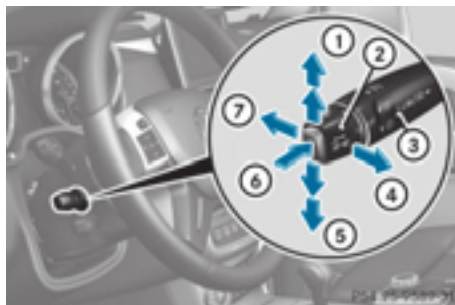

When driving at speeds below 20 mph (30 km/h), you can activate DISTRONIC PLUS if the vehicle in front has been detected and is shown in the multifunction display. If the vehicle in front is no longer detected and displayed, DISTRONIC PLUS switches off and a tone sounds.

- ▶ Briefly pull the cruise control lever towards you ④, or press it up ① or down ⑤. DISTRONIC PLUS is selected.
- ▶ Press the cruise control lever up ① or down ⑤ repeatedly until the desired speed is set.
- ▶ Remove your foot from the accelerator pedal. Your vehicle adapts its speed to that of the vehicle in front, but only up to the desired stored speed.

- ❗ If you do not fully release the accelerator pedal, the **DISTRONIC PLUS Passive** message appears in the multifunction display. The set distance to a slower-moving vehicle in front will then not be maintained. You will be driving at the speed you determine by the position of the accelerator pedal.

Switching on while stationary

This function may be useful if you want to keep up with the traffic flow, e.g. at the end of a tail-back.

You can only activate DISTRONIC PLUS if:

- the vehicle in front and
 - your vehicle are stationary
- Briefly pull the cruise control lever towards you ④, or press it up ① or down ⑤. DISTRONIC PLUS is selected.
- i** DISTRONIC PLUS can only be activated when the vehicle is stationary and at speeds below 20 mph (30 km/h) if a vehicle in front has been detected. Therefore, the DISTRONIC PLUS distance display in the instrument cluster should be activated (> page 178).
- Keep the cruise control lever pressed up ① or down ⑤ until the desired speed is set.
- i** You can use the cruise control lever to set the stored speed and the control on the cruise control lever to set the specified minimum distance (> page 152).

Activating at the current speed/last stored speed

WARNING

If you call up the stored speed and it differs from the current speed, the vehicle accelerates or decelerates. If you do not know the stored speed, the vehicle could accelerate or brake unexpectedly. There is a risk of an accident.

Pay attention to the road and traffic conditions before calling up the stored speed. If you do not know the stored speed, store the desired speed again.

- Briefly pull the cruise control lever towards you ④.
- Remove your foot from the accelerator pedal. DISTRONIC PLUS is activated. The first time it is activated, the current speed is stored. Otherwise, it sets the vehicle cruise speed to the previously stored value.

Driving with DISTRONIC PLUS

Pulling away and driving

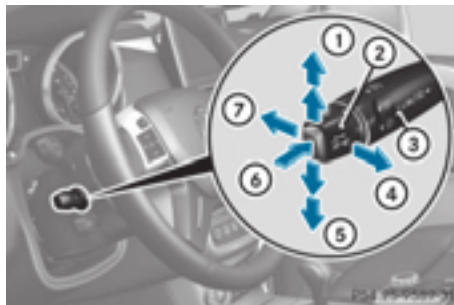

- **If the vehicle in front pulls away:** remove your foot from the brake pedal.
- Briefly pull the cruise control lever towards you ④, or press it up ① or down ⑤.
- or
- Accelerate briefly.
Your vehicle pulls away and adapts its speed to that of the vehicle in front.

If there is no vehicle in front, DISTRONIC PLUS operates in the same way as cruise control.

If DISTRONIC PLUS detects that the vehicle in front has slowed down, it brakes your vehicle. In this way, the distance you have selected is maintained.

If DISTRONIC PLUS detects that the vehicle in front is driving faster, it accelerates your vehicle, but only up to the speed you have stored.

If you depress the brake, DISTRONIC PLUS is deactivated unless your vehicle is stationary.

Changing lanes

If you change to the passing lane, DISTRONIC PLUS supports you when:

- you are driving faster than 40 mph (60 km/h)
- DISTRONIC PLUS is maintaining the distance to a vehicle in front
- you switch on the appropriate turn signal
- DISTRONIC PLUS does not detect a danger of collision

If these conditions are fulfilled, your vehicle is accelerated. Acceleration will be interrupted if changing lanes takes too long or if the distance between your vehicle and the vehicle in front becomes too small.

- i** When changing lanes, DISTRONIC PLUS monitors the left lane on left-hand drive vehicles and the right lane on right-hand drive vehicles.

Stopping

WARNING

When leaving the vehicle, even if it is braked only by DISTRONIC PLUS, it could roll away if:

- there is a malfunction in the system or in the voltage supply.
- DISTRONIC PLUS has been deactivated with the cruise control lever, e.g. by a vehicle occupant or from outside the vehicle.
- the electrical system in the engine compartment, the battery or the fuses have been tampered with.
- the battery is disconnected.
- the accelerator pedal has been depressed, e.g. by a vehicle occupant.

There is a risk of an accident.

If you wish to exit the vehicle, always turn off DISTRONIC PLUS and secure the vehicle against rolling away.

If DISTRONIC PLUS detects that the vehicle in front is stopping, it brakes your vehicle until it is stationary.

Once your vehicle is stationary, it remains stationary and you do not need to depress the brake.

- i** Depending on the specified minimum distance, your vehicle will come to a standstill at a sufficient distance behind the vehicle in front. The specified minimum distance is set using the control on the cruise control lever.

On steep uphill or downhill inclines or if there is a malfunction, the transmission may also automatically be shifted into position **P**.

Displays in the instrument cluster

Displays in the speedometer



Example: DISTRONIC PLUS displays in the speedometer

When DISTRONIC PLUS is activated, one or two segments ② in the set speed range light up. If DISTRONIC PLUS detects a vehicle in front, segments ② between speed of the vehicle in front ① and stored speed ③ light up.

- i** For design reasons, the speed displayed in the speedometer may differ slightly from the speed set for DISTRONIC PLUS.

Display when DISTRONIC PLUS is deactivated



Distance display when DISTRONIC PLUS is deactivated

- ① Vehicle in front, if detected
- ② Distance indicator, current distance to the vehicle in front
- ③ Specified minimum distance to the vehicle in front; adjustable
- ④ Own vehicle

You can select the distance display in the Assistance menu (> page 178) of the on-board computer.

- ▶ Select the **Distance Display** function using the on-board computer.

Display when DISTRONIC PLUS is activated



Distance display with DISTRONIC PLUS activated in the multifunction display

- ① Vehicle in front, if detected
- ② Specified minimum distance to the vehicle in front; adjustable
- ③ DISTRONIC PLUS activated
- ④ Own vehicle

In the Assistance menu (> page 178) of the on-board computer, you can select the distance display.

- ▶ Select the **Distance Display** function using the on-board computer (> page 178).

You will see the stored speed for about five seconds when you activate DISTRONIC PLUS.

Setting a speed



- ① To store the current speed or a higher speed
- ② To store the current speed or a lower speed

- ▶ Press the cruise control lever up ① for a higher speed or down ② for a lower speed.
- ▶ Keep the cruise control lever pressed until the desired speed is reached.
- ▶ Release the cruise control lever. The new speed is stored. DISTRONIC PLUS is activated and adjusts the vehicle's speed to the new speed stored.
- ▶ **To adjust the set speed in 1 mph increments (1 km/h increments):** briefly press the cruise control lever up ① or down ② to the pressure point. Every time the cruise control lever is pressed up ① or down ② the last speed stored is increased or reduced.
- ▶ **To adjust the set speed in 5 mph increments (10 km/h increments):** briefly press the cruise control lever up ① or down ② to the pressure point. Every time the cruise control lever is pressed up ① or down ②, the last speed stored is increased or reduced.

i DISTRONIC PLUS is not deactivated if you depress the accelerator pedal. If you accelerate to overtake, DISTRONIC PLUS adjusts the vehicle's speed to the last speed stored after you have finished overtaking.

Setting a specified minimum distance



You can set the specified minimum distance for DISTRONIC PLUS by varying the time span between one and two seconds. With this function, you can set the minimum distance that DISTRONIC PLUS keeps to the vehicle in front, dependent on vehicle speed. You can see this distance in the multifunction display (> page 178).

- ▶ **To increase:** turn control ③ in direction ②. DISTRONIC PLUS then maintains a greater distance between your vehicle and the vehicle in front.
 - ▶ **To decrease:** turn control ③ in direction ①. DISTRONIC PLUS then maintains a shorter distance between your vehicle and the vehicle in front.
- i** Make sure that you maintain the minimum distance to the vehicle in front as required by law. Adjust the distance to the vehicle in front if necessary.

Deactivating DISTRONIC PLUS

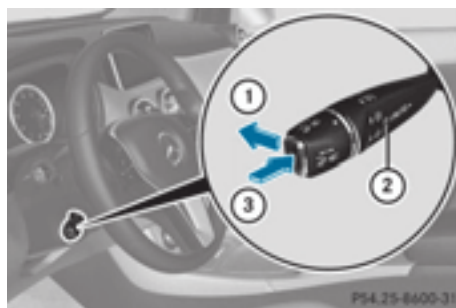

There are several ways to deactivate DISTRONIC PLUS:

- ▶ Briefly press the cruise control lever forwards ①.
- or
- ▶ Brake, unless the vehicle is stationary
- or
- ▶ Briefly press the cruise control lever in the direction of arrow ③. Variable SPEEDTRONIC is selected. LIM indicator lamp ② in the cruise control lever lights up.

When you deactivate DISTRONIC PLUS, you will see the **DISTRONIC PLUS Off** message in the multifunction display for approximately five seconds.

- i** The last speed stored remains stored until you switch off the engine.

DISTRONIC PLUS is automatically deactivated if:

- you engage the parking brake
- you are driving slower than 15 mph (25 km/h) and there is no vehicle in front, or if the vehicle in front is no longer detected
- ESP® intervenes or you deactivate ESP®
- the transmission is in the **P**, **R** or **N** position
- you pull the cruise control lever towards you in order to pull away and the front-passenger door or one of the rear doors is open
- the vehicle has skidded

If DISTRONIC PLUS is deactivated, you will hear a warning tone. You will see the **DISTRONIC PLUS Off** message in the multifunction display for approximately five seconds.

In the Assistance menu (> page 178) of the on-board computer, you can select the distance display.

Tips for driving with DISTRONIC PLUS

General notes

The following contains descriptions of certain road and traffic conditions in which you must be particularly attentive. In such situations, brake if necessary. DISTRONIC PLUS is then deactivated.

Cornering, going into and coming out of a bend

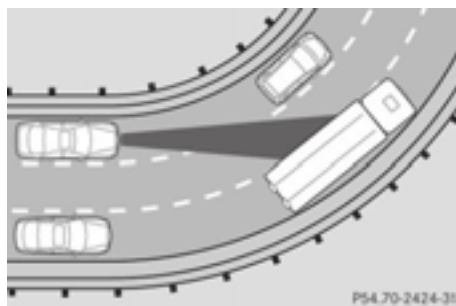

The ability of DISTRONIC PLUS to detect vehicles when cornering is limited. Your vehicle may brake unexpectedly or late.

Vehicles traveling on a different line

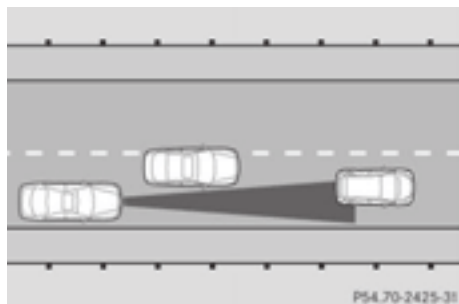

DISTRONIC PLUS may not detect vehicles traveling on a different line. The distance to the vehicle in front will be too short.

Other vehicles changing lanes

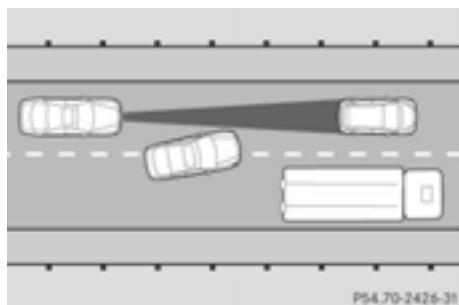

DISTRONIC PLUS has not detected the vehicle cutting in yet. The distance to this vehicle will be too short.

Narrow vehicles

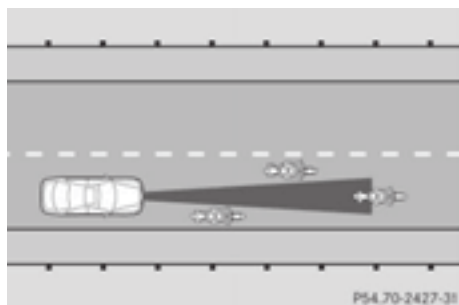

DISTRONIC PLUS has not yet detected the vehicle in front on the edge of the road, because of its narrow width. The distance to the vehicle in front will be too short.

Obstructions and stationary vehicles

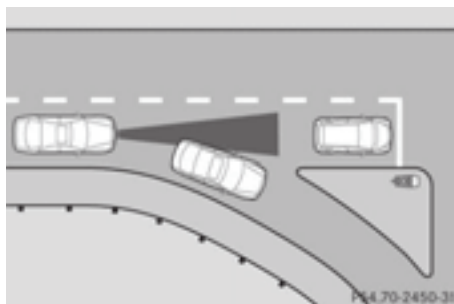

DISTRONIC PLUS does not brake for obstacles or stationary vehicles. If, for example, the detected vehicle turns a corner and reveals an obstacle or stationary vehicle, DISTRONIC PLUS will not brake for these.

Crossing vehicles

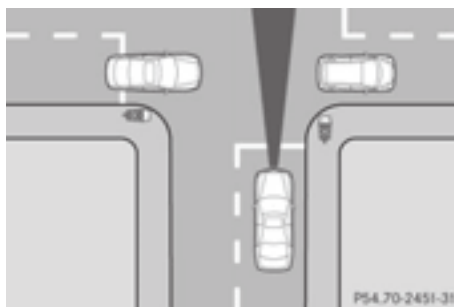

DISTRONIC PLUS may detect vehicles that are crossing your lane by mistake. Activating DISTRONIC PLUS at traffic lights with crossing traffic, for example, could cause your vehicle to pull away unintentionally.

Blind Spot Assist

Important safety notes

WARNING

Blind Spot Assist does not react to:

- vehicles overtaken too closely on the side, placing them in the blind spot area
- vehicles which approach with a large speed differential and overtake your vehicle

As a result, Blind Spot Assist may not give warnings in such situations. There is a risk of an accident.

Always observe the traffic conditions carefully, and maintain a safe lateral distance.

Blind Spot Assist is only an aid. It may fail to detect some vehicles and is no substitute for attentive driving.

In particular, the detection of obstacles can be impaired if:

- there is dirt on the sensors or anything else covering the sensors
- visibility is poor, e.g. due to fog, heavy rain or snow
- there is a narrow vehicle traveling in front, e.g. a motorcycle or bicycle
- the road has very wide lanes
- the road has narrow lanes
- you are not driving in the middle of the lane
- there are barriers or other road boundaries

i USA only:

This device has been approved by the FCC as a "Vehicular Radar System". The radar sensor is intended for use in an automotive radar system only. Removing, tampering with, or altering the device will void any warranties, and is not permitted by the FCC. Do not tamper with, alter, or use in any non-approved way.

Any unauthorized modification to this device could void the user's authority to operate the equipment.

General notes

Blind Spot Assist uses a radar sensor system to monitor both the left and right sides of your vehicle. It supports you from a speed of approximately 20 mph (30 km/h). A warning display in the exterior mirrors draws your attention to vehicles detected in the monitored area. If you then switch on the corresponding turn signal to change lanes, you will also receive a visual and audible collision warning. For this purpose, Blind Spot Assist uses sensors in the rear bumper.

Monitoring range of the sensors

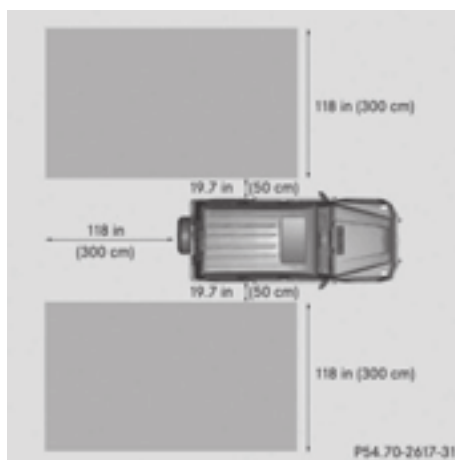

Blind Spot Assist monitors the area up to 10 ft (3 m) behind your vehicle and directly next to your vehicle, as shown in the diagram.

If the lanes are narrow, vehicles driving in the lane beyond the lane next to your vehicle may be indicated, especially if the vehicles are not driving in the middle of their lane. This may be the case if the vehicles are driving on the inner side of their lane.

Due to the nature of the system:

- warnings may be issued in error when driving close to crash barriers or similar solid lane borders.
- the warning is canceled when driving for an extended period next to long vehicles, such as trucks.

The two sensors for Blind Spot Assist are integrated into the sides of the rear bumper. Make sure that the bumper is free of dirt, ice or slush in the vicinity of the sensors. The radar sensors must not be covered, for example by rear bicycle racks or overhanging loads. Following a severe impact or in the event of damage to the bumpers, have the function of the radar sensors checked at a qualified specialist workshop. Blind Spot Assist may otherwise not work properly.

Indicator and warning display

WARNING

Blind Spot Assist does not react to:



- vehicles overtaken too closely on the side, placing them in the blind spot area
- vehicles being overtaken at a speed difference of more than 7.5 mph (12 km/h)
- vehicles which approach with a large speed differential and overtake your vehicle

As a result, Blind Spot Assist may not give warnings in such situations. There is a risk of an accident.

Always observe the traffic conditions carefully, and maintain a safe lateral distance.



Yellow indicator lamp/red warning lamp

When Blind Spot Assist is activated, indicator lamp  in the exterior mirrors lights up yellow at speeds of up to 20 mph (30 km/h). At speeds above 20 mph (30 km/h), the indicator lamp goes out and Blind Spot Assist is operational. If a vehicle is detected within the monitoring range of Blind Spot Assist at speeds above 20 mph (30 km/h), warning lamp  on the corresponding side lights up red. This warning occurs when a vehicle enters the blind spot monitoring range from behind or from the side. When you overtake a vehicle, the warning only occurs as long as the difference in speed is less than 7 mph (12 km/h).



The yellow indicator lamp goes out if reverse gear is engaged. In this event, Blind Spot Assist is no longer active.

The brightness of the indicator/warning lamps is adjusted automatically according to the ambient light.

Collision warning



Red warning lamp

If a vehicle is detected in the monitoring range of Blind Spot Assist and you switch on the corresponding turn signal, a double warning tone sounds. Red warning lamp  flashes. If the turn signal remains on, vehicles detected are indicated by the flashing of red warning lamp . There are no further warning tones.

Switching on Blind Spot Assist



Yellow indicator lamp/red warning lamp

- ▶ Make sure that Blind Spot Assist is activated in the on-board computer (▷ page 178).
- ▶ Turn the SmartKey to position **2** in the ignition lock (▷ page 112). Warning lamps  in the exterior mirrors light up red for approximately 1.5 seconds and then turn yellow.

HOLD function

General notes

The HOLD function can assist the driver in the following situations:

- when pulling away, especially on steep slopes
- when maneuvering on steep slopes
- when waiting in traffic

The vehicle is kept stationary without the driver having to depress the brake pedal.

The braking effect is canceled and the HOLD function deactivated when you depress the accelerator pedal to pull away.

- i** Do not use the HOLD function when driving off-road, on steep uphill or downhill gradients or on slippery or loose surfaces. The HOLD function cannot hold the vehicle on such surfaces.

Activation conditions

You can activate the HOLD function if:

- the vehicle is stationary
- the engine is running or if it has been automatically switched off by the ECO start/stop function
- the engine is running
- the driver's door is closed or your seat belt is fastened
- the transmission is in position **D**, **R** or **N**
- DISTRONIC PLUS is deactivated

Activating the HOLD function

The vehicle's brakes are applied when the HOLD function is activated. For this reason, deactivate the HOLD function while in the car wash or while towing.

- ▶ Make sure that the activation conditions are met.
- ▶ Depress the brake pedal.
- ▶ Quickly depress the brake pedal further until **HOLD** appears in the multifunction display. The HOLD function is activated. You can release the brake pedal.

- i** If depressing the brake pedal the first time does not activate the HOLD function, wait briefly and then try again.

Deactivating the HOLD function

WARNING

When leaving the vehicle, it can still roll away despite being braked by the HOLD function if:

- there is a malfunction in the system or in the voltage supply.
 - the HOLD function has been deactivated by pressing the accelerator pedal or the brake pedal, e.g. by a vehicle occupant.
 - the electrical system in the engine compartment, the battery or the fuses have been tampered with.
 - the battery is disconnected
- There is a risk of an accident.

If you wish to exit the vehicle, always turn off the HOLD function and secure the vehicle against rolling away.

The HOLD function is deactivated automatically if:

- you accelerate and the transmission is in position **D** or **R**.
- you shift the transmission to position **P**.
- you depress the brake pedal again with a certain amount of pressure until **HOLD** disappears from the multifunction display.
- you activate DISTRONIC PLUS.

On steep uphill or downhill gradients or if there is a malfunction, the transmission may also be automatically shifted into position **P**.

Permanent all-wheel drive

- !** Never tow the vehicle with one axle raised. This may damage the transfer case. Damage of this sort is not covered by the Mercedes-Benz Limited Warranty. All wheels must remain either on the ground or be fully raised. Observe the instructions for towing the vehicle with all wheels in full contact with the ground.

- !** When testing the parking brake, operate the vehicle only briefly (for a maximum of ten seconds) on a brake test dynamometer. When doing this, turn the SmartKey to position **0** or **1** in the ignition. Failure to do this can cause damage to the drive train or the brake system.

! A function or performance test should only be carried out on a two-axle dynamometer. Before you operate the vehicle on such a dynamometer, please consult a qualified workshop. You could otherwise damage the drive train or the brake system.

The all-wheel drive system ensures that all four wheels are permanently driven. The all-wheel drive system improves vehicle traction together with ESP® and 4ETS if a drive wheel spins due to insufficient grip.

If a drive wheel spins due to insufficient grip:

- Only depress the accelerator pedal as far as necessary when pulling away.
- Take your foot off the accelerator, slowly, while the vehicle is in motion.

The permanent all-wheel drive system can neither reduce the risk of accident nor override the laws of physics if you fail to adapt your driving style or if you are inattentive. The all-wheel drive system cannot take into account road, weather or traffic conditions. The all-wheel drive system is only an aid. You are responsible for maintaining a safe distance to the vehicle in front, for vehicle speed, for braking in good time and for staying in lane.

In wintry driving conditions, always use winter tires (M+S tires) and if necessary, snow chains (> page 264). Only in this way can the maximum effect of all-wheel drive be achieved.

For information on driving off-road, see (> page 137).

PARKTRONIC

Important safety notes

! When parking, pay particular attention to objects above or below the sensors, such as flower pots or trailer drawbars. PARKTRONIC does not detect such objects when they are in the immediate vicinity of the vehicle. You could damage the vehicle or the objects.

The sensors may not detect snow and other objects that absorb ultrasonic waves.

Ultrasonic sources such as an automatic car wash, the compressed-air brakes on a truck or a pneumatic drill could cause PARKTRONIC to malfunction.

PARKTRONIC may not function correctly on uneven terrain.

PARKTRONIC is an electronic parking aid with ultrasonic sensors. It indicates visually and audibly the distance between your vehicle and an object.

PARKTRONIC is only an aid. It is not a replacement for your attention to your immediate surroundings. You are always responsible for safe maneuvering, parking and exiting a parking space. Ensure that the areas in front, behind and to the side of the vehicle are safe before maneuvering, parking or pulling away. There must not be any persons, animals or objects in the area in which you are maneuvering.

PARKTRONIC does not take into account any persons or objects located below or above the detection range. As a result, PARKTRONIC cannot warn you about objects in this area.

PARKTRONIC is activated automatically when you:

- switch on the ignition
- shift the transmission to position **D**, **R** or **N**
- release the parking brake

PARKTRONIC is deactivated at speeds above 11 mph (18 km/h). It is reactivated at lower speeds.

PARKTRONIC monitors the area around your vehicle using six sensors in the front bumper and four sensors in the rear bumper.

Range of the sensors

General notes



- ① Example: sensors in the front bumper, right-hand side



Side view

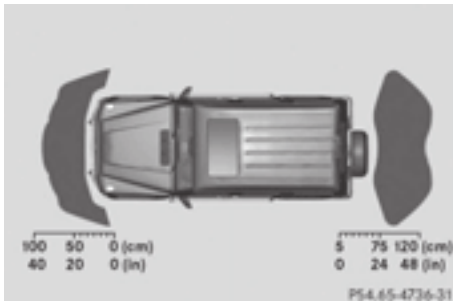

Top view

The sensors must be free from dirt, ice or slush. Otherwise, they may not function correctly. Clean the sensors regularly, taking care not to scratch or damage them (▷ page 244).

Front sensors

Center	Approx. 40 in (approx. 100 cm) from the brush guard)
Corners	Approx. 24 in (approx. 60 cm)

Rear sensors

Center	Approx. 36 in (90 cm) from the spare wheel
Corners	Approx. 32 in (approx. 80 cm)

Minimum distance

Center	Approx. 8 in (approx. 20 cm)
Corners	Approx. 8 in (approx. 20 cm)

If there is an obstacle within this range, the relevant warning displays light up and a warning tone sounds. If the distance falls below the minimum, the distance may no longer be shown.

Warning displays



Warning display for the front area

- ① Segments on the left-hand side of the vehicle
- ② Segments on the right-hand side of the vehicle
- ③ Segments showing operational readiness

The warning displays show the distance between the sensors and the obstacle. The warning display for the front area is located on the dashboard above the center air vents. The warning display for the rear area is located on the headliner in the rear compartment.

The warning display for each side of the vehicle is divided into five yellow and two red segments. PARKTRONIC is operational if yellow segments showing operational readiness ③ light up.

The selected transmission position and the direction in which the vehicle is rolling determine which warning display is active when the engine is running.

Transmission position	Warning display
D	Front area activated
R, N or the vehicle is rolling backwards	Rear and front areas activated
P	No areas activated

One or more segments light up as the vehicle approaches an obstacle, depending on the vehicle's distance from the obstacle.

From the:

- sixth segment onwards, you will hear an intermittent warning tone for approximately two seconds.
- seventh segment onwards, you will hear a warning tone for approximately two seconds.

This indicates that you have now reached the minimum distance.

Deactivating/activating PARKTRONIC



- ① Indicator lamp
- ② To deactivate/activate PARKTRONIC

If indicator lamp ① lights up, PARKTRONIC is deactivated.

- i** PARKTRONIC is automatically activated when you turn the SmartKey to position **2** in the ignition lock.

Towing a trailer

PARKTRONIC is deactivated for the rear area when you establish an electrical connection between your vehicle and a trailer.

Problems with PARKTRONIC

Problem	Possible causes/consequences and ► Solutions
Only the red segments in the PARKTRONIC warning displays are lit. You also hear a warning tone for approximately two seconds. PARKTRONIC is deactivated after a few seconds, and the indicator lamp in the PARKTRONIC button lights up.	PARKTRONIC has malfunctioned and has switched off. ► If problems persist, have PARKTRONIC checked at a qualified specialist workshop.
Only the red segments in the PARKTRONIC warning displays are lit. PARKTRONIC is deactivated after a few seconds.	The PARKTRONIC sensors are dirty or there is interference. ► Clean the PARKTRONIC sensors (▷ page 244). ► Switch the ignition back on. The problem may be caused by an external source of radio or ultrasound waves. ► See if PARKTRONIC functions in a different location.

Rear view camera

Important safety notes

The rear view camera is only an aid. It is not a replacement for your attention to your immediate surroundings. You are always responsible for safe maneuvering and parking. When maneuvering or parking, make sure that there are no persons, animals or objects in the area in which you are maneuvering.

Under the following circumstances, the rear view camera will not function, or will function in a limited manner:

- the rear door is open
- in heavy rain, snow or fog
- at night or in very dark places
- if the camera is exposed to very bright light
- if the area is lit by fluorescent light or LED lighting (the display may flicker)
- if there is a sudden change in temperature, e.g. when driving into a heated garage in winter
- if the camera lens is dirty or obstructed
- if the rear of your vehicle is damaged. In this event, have the camera position and setting checked at a qualified specialist workshop

Mercedes-Benz recommends that you use an authorized Mercedes-Benz Center for this purpose

Activating/deactivating the rear view camera

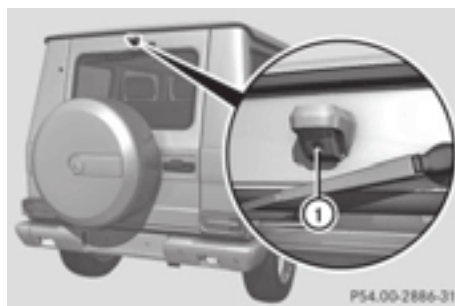

① Rear view camera



- ▶ **To activate:** make sure that the SmartKey is in position **2** in the ignition lock.
- ▶ Make sure that the "rear view camera" function is selected in COMAND (see the separate operating instructions for COMAND).
- ▶ Engage reverse gear.
The area behind the vehicle is shown in the COMAND display.

To deactivate: the rear view camera is deactivated if you:

- shift the transmission to position **P**
- drive forward ten meters
- shift the transmission from **R** to another position after 15 seconds
- drive forwards at a speed of over 5 mph (10 km/h)

Off-road driving systems

Transfer case

General notes

The vehicle has permanent all-wheel drive. Power is always transmitted to both axles. For further information on driving off-road, see (> page 137).

Shift ranges

WARNING

If you do not wait for the transfer case gear change process to complete, the transfer case could remain in the neutral position. The power transmission to the driven wheels is then interrupted. There is a danger of the vehicle rolling away unintentionally. There is a risk of an accident.

Wait until the transfer case shift process is completed.

Do not switch off the engine while changing gear and do not shift the automatic transmission to another gear.

HIGH RANGE	Position for all normal on-road driving conditions
LOW RANGE	Low-range position for driving off-road. Also for use on steep uphill or downhill gradients, especially when towing a trailer. The vehicle travels around half the speed of on-road driving range HIGH RANGE . The tractive power is correspondingly higher.

Shifting the transfer case

Important safety notes

WARNING

When the transfer case is in the neutral position, power transmission to the driven wheels is interrupted. As a result, the vehicle could roll away. There is a risk of an accident.

Secure the vehicle with the parking brake, and on uphill or downhill gradients, also secure it with a device such as a wheel chock.

Always wait for the gear change process from **HIGH RANGE** to **LOW RANGE** and from **LOW RANGE** to **HIGH RANGE** to complete. Do not switch off the engine while changing gear and do not shift the automatic transmission to another gear.

General notes

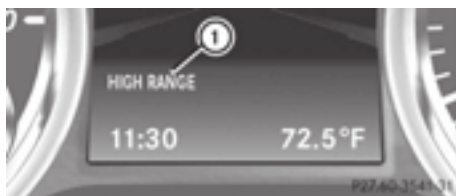

- ① Current shift range



- ① Indicator lamp
- ② LOW RANGE button

Switching on the off-road gear ratio

! Only carry out the gear selection if:

- the engine is running.
- the vehicle is rolling.
- the automatic transmission is in selector lever position **N**.
- you are driving no faster than 25 mph (40 km/h).

You could otherwise damage the transfer case.



- ▶ Make sure the ECO start/stop function is switched off (> page 114).
- ▶ Press LOW RANGE button ②. When the shift procedure is complete, the **LOW RANGE** transfer case position appears in the multifunction display. Indicator lamp ① lights up.
- ▶ Shift the transmission to position **D**.

Switching off the off-road gear ratio

⚠ WARNING

When the transfer case is in the neutral position, power transmission to the driven wheels

is interrupted. As a result, the vehicle could roll away. There is a risk of an accident.

Secure the vehicle with the parking brake, and on uphill or downhill gradients, also secure it with a device such as a wheel chock.

! Only carry out the gear selection if:

- the engine is running.
- the vehicle is rolling.
- the automatic transmission is in selector lever position **N**.
- you are driving no faster than 43 mph (70 km/h).

You could otherwise damage the transfer case.

▶ Press button ②.

When the shift procedure is complete, the **HIGH RANGE** transfer case position appears in the multifunction display.

Indicator lamp ① goes out.

If the gear change is not completed, the following messages could appear in the display:

• TC Shift Conditions Not Fulfilled

You have not met one or more shift conditions.

• TC NEUTRAL On

The transfer case has canceled the gear change process and is in **N**. Transfer case position **N** appears in the multifunction display.

• TC Shift Canceled

The transfer case has canceled the gear change process.

▶ Carry out the gear change process again.

Make sure to meet all conditions for changing gears.

• TC Malfunction Visit Workshop

There is a malfunction in the transfer case.

▶ Do not shift the transfer case.

▶ Have the vehicle checked as soon as possible at a qualified specialist workshop.

Shifting to neutral

⚠ WARNING

When the transfer case is in the neutral position, power transmission to the driven wheels

is interrupted. As a result, the vehicle could roll away. There is a risk of an accident.

Secure the vehicle with the parking brake, and on uphill or downhill gradients, also secure it with a device such as a wheel chock.

- ▶ Turn the SmartKey to position **2** in the ignition lock (▷ page 112).
- ▶ Apply the parking brake.
- ▶ Depress the brake pedal.
- ▶ Move the selector lever to position **N** (▷ page 119).
- ▶ Press and hold LOW RANGE button ② for approximately ten seconds.
When the shift procedure is complete, the **TC In Neutral** message appears in the multifunction display for five seconds.

If the gear change is not completed, the following messages could appear in the display (▷ page 195).

- ❗ If the transfer case is in **neutral**, the key is in the ignition lock and you open the driver's door, the **TC In Neutral** message appears in the multifunction display. If you then release the parking brake, a warning tone will sound.

Differential locks

General notes

WARNING

When the differential locks are engaged, ABS, 4ETS, ESP® and BAS are deactivated. As a result, the wheels could lock when braking and the braking distance is increased. There is a risk of an accident.

Disengage the differential locks immediately on firm surfaces with good grip.

- ❗ In order to avoid damage to the transfer case, you must operate the vehicle on a dynamometer (1-axle dynamometer) only if:
 - the axle not driven on is jacked up
or
 - the corresponding propeller shaft is disconnected and the transfer case differential lock is engaged.

Otherwise, the transfer case can be damaged.

Differential locks improve the traction of the vehicle.

Your vehicle is equipped with a differential lock each for:

- the transfer case: this controls the balance between the front and rear axles.
- the rear axle: this controls the balance between the wheels on the rear axle.
- the front axle: this controls the balance between the wheels on the front axle.

Information on differential gear system and differential lock

When the vehicle drives around a curve, the wheels on the outside of the curve must cover a greater distance. Therefore, the wheels turn more rapidly than on the inside. The differential, a gear system in the drive train, allows for differing rotational speeds and facilitates cornering.

The disadvantage of a differential is that the wheels that have the least grip, get the most drive. An example: a wheel of a driven axle is on a snow-covered surface and therefore does not have any traction. The differential sends most of the drive force to this wheel because the force takes the route of the lowest resistance. The opposite wheel on this axle, however, which stands on firm ground and could therefore allow propulsion, receives no driving power. 4ETS compensates for this disadvantage. 4ETS provides good steerability by automatically braking the spinning wheel. 4ETS provides the wheel on the firm surface with more drive force, which in turn provides propulsion.

ESP® and 4ETS are traction systems that are ideal for road driving and suitable for light off-road driving. The **LOW RANGE** off-road gear also improves off-road capability.

More challenging off-road conditions require additional measures such as locking one or more differential. Your vehicle is equipped with three differential locks:

- a central differential lock for the transfer case
- a differential lock for the front axle and
- a differential lock for the rear axle

Each differential lock can be engaged with the corresponding switch on the center console. If the differential in the transfer case is locked, the front and rear wheels rotate at the same speed. If the differential for the rear axle is locked, both

rear wheels rotate at the same speed, regardless of their respective torque. Note, engaging the differential lock greatly impairs the vehicle's steerability.

Note, it is imperative to use the differential function when driving on firm road surfaces. Under no circumstances should the differential be locked when driving on firm road surfaces. Otherwise, the vehicle may not be steerable and you could lose control of the vehicle. Therefore, only engage the differential lock when driving off-road. You should only engage the differential lock if activating 4ETS and ESP® driving systems and **LOW RANGE** off-road gear prove to be insufficient.

Engaging the differential locks

Important safety notes

WARNING

When differential locks are engaged on a firm, high-grip surface, the vehicle's steerability is greatly impaired. In particular, engaging the differential locks when cornering could lead to you losing control of the vehicle. There is a risk of an accident.

Disengage the differential locks immediately on firm surfaces with good grip.

WARNING

When the differential locks are engaged, ABS, 4ETS, ESP® and BAS are deactivated. As a result, the wheels could lock when braking and the braking distance is increased. There is a risk of an accident.

Disengage the differential locks immediately on firm surfaces with good grip.

- !** Only engage the differential locks when:
- you are driving at walking pace.
 - the driven wheels are not spinning.
 - you are not driving on a firm road surface.

General notes

The switches are located on the center console.

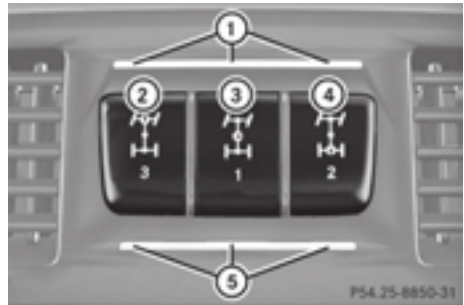

- ① Function indicator lamps (red)
- ② Differential lock for the front axle
- ③ Differential lock for the transfer case
- ④ Differential lock for the rear axle
- ⑤ Activation indicator lamps (yellow)

Engage the differential locks:



- off-road
- to deactivate ABS, 4ETS, ESP® and BAS while off-road
- when fording

For further information on driving off-road, see (> page 137).

- i** You can engage the differential locks in the following order: ③, ④, ②.

Differential lock for the transfer case

- ▶ **To engage:** switch the transfer case to the **LOW RANGE** off-road driving position (> page 162).
- ▶ Press switch ③. If the transfer case is in the **LOW RANGE** off-road position, the yellow activation indicator lamp under switch ③ lights up. The  warning lamp in the instrument cluster lights up. If the differential is locked, the red function indicator lamp above switch ③ lights up. In the multifunction display you see the **ABS not available differential locked** message.

The   warning lamps light up in the instrument cluster.

The differential lock for the transfer case is engaged.

4ETS, ESP®, BAS and ABS are deactivated.

The vehicle's ability to steer is severely restricted. Drive carefully and accelerate gently for optimum traction.

- i** You can now engage the differential lock for rear axle ④ and the differential lock for front axle ② as required.

Differential lock for the rear axle



- ▶ **To engage:** press switch ④.
Yellow activation indicator lamp ⑤ lights up first, followed by red function indicator lamp ① of switch ④.
The differential lock for the rear axle is engaged.

Differential lock for the front axle

- ▶ **To engage:** press switch ②.
First, the yellow activation indicator lamp lights up, followed by the red function indicator lamp.
The differential lock for the front axle is engaged.

Disengaging the differential locks

You can disengage the differential locks in the following order: ②, ④, ③.

- ▶ **To simultaneously disengage all differential locks:** press switch ③.
Yellow activation indicator lamps ⑤ and red function indicator lamps ① go out.
After approximately three seconds of normal driving, ABS, 4ETS, ESP® and BAS are activated.
The **ABS not available differential locked** message disappears in the multifunction display and the ,  and  warning lamps in the instrument cluster go out.
- ▶ Shift the transfer case to the **HIGH RANGE** on-road position (▷ page 162).
- i** If red function indicator lamps ① do not go out when disengaging the differential locks, stop the vehicle safely as soon as possible, in accordance with the traffic conditions. Then, continue driving and the load change can release the differential lock.

Towing a trailer

Notes on towing a trailer

Important safety notes

WARNING

If you rest your foot on the brake pedal while driving, the braking system can overheat. This increases the stopping distance and can even cause the braking system to fail. There is a risk of an accident.

Never use the brake pedal as a footrest. Never depress the brake pedal and the accelerator pedal at the same time.

WARNING

When the vehicle/trailer combination begins to lurch, you could lose control of it. The vehicle/trailer combination could even rollover. There is a risk of an accident.

On no account should you attempt to straighten up the vehicle/trailer combination by increasing the speed. Reduce vehicle speed and do not countersteer. Apply the brake as necessary.

WARNING

If you install a ball coupling other than the one delivered with the vehicle, the trailer tow hitch and the rear axle may be overloaded. This applies especially if the ball coupling in question is longer or angled differently. This could seriously impair the driving characteristics and the trailer can come loose. There is a risk of an accident.

Only install the ball coupling delivered with the vehicle or a ball coupling that is designed to meet your trailer towing requirements. Do not modify the ball coupling or the trailer tow hitch.

WARNING

If the ball coupling is not installed correctly or not secured with the bolt provided and the corresponding spring cotter, the trailer may come loose. There is a risk of an accident.

Always install and secure the ball coupling as described. Before every journey, ensure that the ball coupling is secured with the bolt and the corresponding spring cotter.

Please observe the manufacturer's operating instructions for the trailer coupling if a detachable trailer coupling is used.

Exceeding the maximum permissible nose-weight may cause damage to the following:

- your vehicle
- the trailer
- the ball coupling
- trailer tow hitch

The vehicle/trailer combination could become unstable.

If the noseweight used is lower than the minimum permissible noseweight, the vehicle/trailer combination could also become unstable.

To avoid hazardous situations:

- make sure to check the noseweight before each journey
- use a drawbar noseweight as close as possible to the maximum noseweight
- do not exceed the maximum permissible noseweight
- do not use a noseweight lower than the minimum permissible trailer drawbar noseweight

When backing up the vehicle towards the trailer, make sure there is nobody between the trailer and the vehicle.

The applicable permissible values, which must not be exceeded, can be found:

- in your vehicle documents
- on the type plate of the trailer tow hitch and trailer
- on the vehicle identification plate

Couple and uncouple the trailer carefully. If you do not couple the trailer to the towing vehicle correctly, the trailer could become detached.

Make sure that the following values are not exceeded:

- the permissible trailer drawbar noseweight
- the permissible trailer load
- the permissible rear axle load of the towing vehicle
- the maximum permissible gross vehicle weight of both the towing vehicle and the trailer

When towing a trailer, your vehicle's handling characteristics will be different in comparison with when driving without a trailer.

The vehicle/trailer combination:

- is heavier
- is restricted in its acceleration and gradient-climbing capability
- has an increased braking distance
- is affected more by strong crosswinds
- demands more sensitive steering
- has a larger turning radius

This could impair the handling characteristics. Adapt your driving style accordingly. Maintain a safe distance. Drive carefully.

When towing a trailer, always adjust your speed to the current road and weather conditions. Do not exceed the maximum permissible speed for your vehicle/trailer combination.

You will find the values approved by the manufacturer on the vehicle identification plates and those for the towing vehicle in the "Technical data" section (▷ page 297).

General notes

- Do not exceed the legally prescribed maximum speed for vehicle/trailer combinations in the relevant country.
This lowers the risk of an accident.
- Only install an approved trailer coupling on your vehicle.
Further information on availability and on installation is available from any authorized Mercedes-Benz Center.
- The bumpers of your vehicle are not suitable for installing detachable trailer couplings.
- Do not install hired trailer couplings or other detachable trailer couplings on the bumpers of your vehicle.
- If you do not need the ball coupling, remove the ball coupling from the ball coupling recess. This reduces the risk of damage to the ball coupling.

- **i** Check the tire pressures when towing a trailer. You will find the values in the tire pressure table in the fuel filler flap of the vehicle (▷ page 266).

You will find installation dimensions and loads under "Technical data" (▷ page 297).

The maximum noseweight of the trailer drawbar on the ball coupling for up to 3 people is 562 lbs (255 kg). The maximum permissible trailer drawbar noseweight for more than 3 persons and the maximum load in the trunk can be found in the trailer drawbar noseweight table (▷ page 298). However, the actual noseweight must not exceed the value given on the trailer tow hitch or trailer identification plates. The lowest weight applies.

Please note that when towing a trailer, PARKTRONIC (▷ page 158) and Blind Spot Assist (▷ page 154) are only available with limitations, or not at all.

- i** On vehicles without level control, the height of the ball coupling will alter according to the load placed on the vehicle. If necessary, use a trailer with a height-adjustable drawbar.

Driving tips

- ▶ On long and steep downhill gradients, select shift range **1, 2 or 3** (▷ page 123) in good time.

- i** This also applies if you have activated cruise control or SPEEDTRONIC.

- ▶ If necessary, shift the transfer case to **LOW RANGE** (▷ page 162).

This will use the braking effect of the engine, so that less braking will be required to maintain the speed. This relieves the load on the brake system and prevents the brakes from overheating and wearing too quickly. If you need additional braking, depress the brake pedal repeatedly rather than continuously.

The maximum permissible speed for vehicle/trailer combinations depends on the type of trailer. Before beginning the journey, check the trailer's documents to see what the maximum permissible speed is. Observe the legally prescribed maximum speed in the relevant country.

For certain Mercedes-Benz vehicles, the maximum permissible rear axle load is increased when towing a trailer. Refer to the "Technical data" section to find out whether this applies to your vehicle. If you utilize any of the added maximum rear axle load when towing a trailer, the vehicle/trailer combination may not exceed a maximum speed of 60 mph (100 km/h) for reasons concerning the operating permit. This also applies in countries in which the permissible maximum speed for vehicle/trailer combinations is above 60 mph (100 km/h).

When towing a trailer, your vehicle's handling characteristics will be different in comparison to when driving without a trailer and it will consume more fuel.

On long and steep downhill gradients, you must select shift range **1, 2 or 3** in good time.

- i** This also applies if you have activated cruise control or DISTRONIC PLUS.

This will use the braking effect of the engine, so that less braking will be required to maintain the speed. This relieves the load on the brake system and prevents the brakes from overheating and wearing too quickly. If you need additional braking, depress the brake pedal repeatedly rather than continuously.

Driving tips

If the trailer swings from side to side:

- ▶ Do not accelerate.
- ▶ Do not counter-steer.
- ▶ Brake if necessary.
 - Maintain a greater distance from the vehicle in front than when driving without a trailer.
 - Avoid braking abruptly. If possible, brake gently at first to allow the trailer to run on. Then, increase the braking force rapidly.
 - The values given for gradient-climbing capabilities from a standstill refer to sea level. When driving in mountainous areas, note that the power output of the engine and, consequently, the vehicle's gradient-climbing capability, decreases with increasing altitude.

Trailer power supply

- i** You can connect accessories with a maximum power consumption of 180 W to the permanent power supply.

You must not charge a trailer battery using the power supply.

The trailer socket of your vehicle is equipped at the factory with a permanent power supply.

The permanent power supply is supplied via trailer socket pin 9.

A qualified specialist workshop can provide more information about installing the trailer electrics.

Trailer with 7-pin connector

General notes

You can make a connection to the 13-pin socket on the ball coupling using an adapter or, if necessary, an adapter cable. Both can be obtained in a qualified specialist workshop.

Installing the adapter

- ❗ Make sure that there is enough slack in the cable for cornering so that the cable cannot become detached.

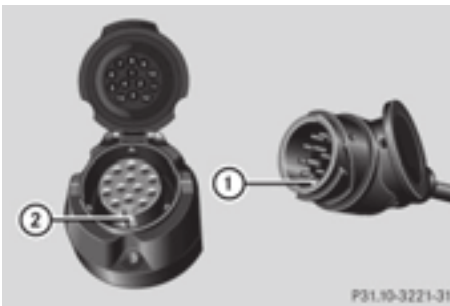

- ▶ Open the socket cover.
 - ▶ Insert the connector with lug ① into groove ② on the socket and turn it clockwise to the stop.
 - ▶ Make the cover engage.
 - ▶ If you are using an adapter cable, secure the cable to the trailer with cable ties.
- i** When the socket is connected, the backing up aid is deactivated.

Useful information

- i** This Operator's Manual describes all models and all standard and optional equipment of your vehicle available at the time of publication of the Operator's Manual. Country-specific differences are possible. Please note that your vehicle may not be equipped with all features described. This also applies to safety-related systems and functions.
- i** Read the information on qualified specialist workshops: (▷ page 23).

Important safety notes

WARNING

If you operate information systems and communication equipment integrated in the vehicle while driving, you will be distracted from traffic conditions. You could also lose control of the vehicle. There is a risk of an accident.

Only operate the equipment when the traffic situation permits. If you are not sure that this is possible, park the vehicle paying attention to traffic conditions and operate the equipment when the vehicle is stationary.

WARNING

If the instrument cluster has failed or malfunctioned, you may not recognize function restrictions in systems relevant to safety. The operating safety of your vehicle may be impaired. There is a risk of an accident.

Drive on carefully. Have the vehicle checked at a qualified specialist workshop immediately.

The on-board computer only shows messages or warnings from certain systems in the multifunction display. You should therefore make sure your vehicle is operating safely at all times. Otherwise, a vehicle that is not operating safely may cause an accident.

You must observe the legal requirements for the country in which you are currently driving when operating the on-board computer.

For an illustration of the instrument cluster, see (▷ page 171).



Displays and operation

Instrument cluster

Instrument cluster lighting

The brightness control knob is located on the bottom left of the instrument cluster (▷ page 171).

- ▶ Turn the brightness control knob clockwise or counter-clockwise.

If the light switch is set to **AUTO**,  or , the brightness is dependent upon the brightness of the ambient light.

- i** The light sensor in the instrument cluster automatically controls the brightness of the multifunction display.

In daylight, the displays in the instrument cluster are not illuminated.

Displaying the coolant temperature

WARNING

Opening the hood when the engine is overheated or when there is a fire in the engine compartment could expose you to hot gases or other service products. There is a risk of injury.

Let an overheated engine cool down before opening the hood. If there is a fire in the engine compartment, keep the hood closed and contact the fire department.

- !** A display message is shown if the coolant temperature is too high.

If the coolant temperature is over 248 °F (120 °C), do not continue driving. The engine will otherwise be damaged.

The coolant temperature gage is in the instrument cluster on the right-hand side (▷ page 171).

Under normal operating conditions and with the specified coolant level, the coolant temperature may rise to 248 °F (120 °C).

Tachometer

- !** Do not drive in the overrevving range, as this could damage the engine.

The red band in the tachometer indicates the engine's overrevving range.

The fuel supply is interrupted to protect the engine when the red band is reached.

Outside temperature display

You should pay special attention to road conditions when temperatures are around freezing point.

Bear in mind that the outside temperature display indicates the temperature measured and does not record the road temperature.

The outside temperature display is in the multifunction display (▷ page 173).

Changes in the outside temperature are displayed after a short delay.

Speedometer with segments

The segments in the speedometer indicate which speed range is available.

- Cruise control activated (▷ page 141):
The segments light up from the stored speed to the maximum speed.
- Variable SPEEDTRONIC activated (▷ page 145):
The segments light up from the start of the scale to the selected limit speed.
- DISTRONIC PLUS activated (▷ page 149):
One or two segments in the set speed range light up.
- DISTRONIC PLUS detects a vehicle in front:
The segments between the speed of the vehicle in front and the stored speed light up.

Operating the on-board computer

Overview



- ① Multifunction display
- ② Switches on the Voice Control System (see the separate operating instructions)
- ③ Right control panel
- ④ Left control panel
- ⑤ Back button

► **To activate the on-board computer:** turn the SmartKey to position **1** in the ignition lock (► page 112).

You can control the multifunction display and the settings in the on-board computer using the buttons on the multifunction steering wheel.

Left control panel

 • Calls up the menu and menu bar



Press briefly:



- Scrolls in lists
- Selects a submenu or function
- In the **Audio** menu: selects a stored station, an audio track or a video scene
- In the **Tel** (telephone) menu: switches to the phone book and selects a name or telephone number



Press and hold:



- In the **Audio** menu: selects the previous/next station or selects an audio track or a video scene using rapid scrolling
- In the **Tel** (telephone) menu: starts rapid scrolling if the phone book is open



- Confirms a selection/display message
- In the **Tel** (telephone) menu: switches to the telephone book and starts dialing the selected number
- In the **Audio** menu: stops the station search function at the desired station

Right control panel



- Rejects or ends a call
- Exits phone book/redial memory



- Makes or accepts a call
- Switches to the redial memory



- Adjusts the volume



- Mute

Back button



Press briefly:

- Back
- Switches off the Voice Control System (see the separate operating instructions)
- Hides display messages/calls up the last **Trip** menu function used
- Exits the telephone book/redial memory



Press and hold:

- Calls up the standard display in the **Trip** menu

Multifunction display

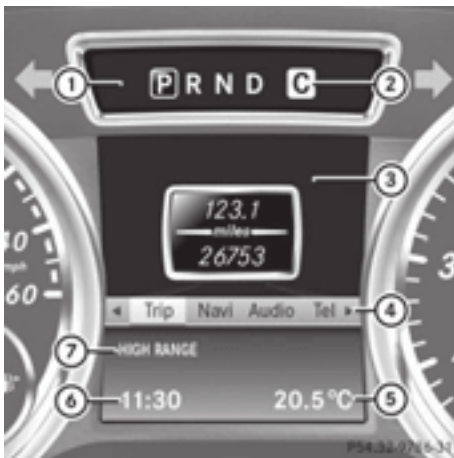

- ① Transmission position (▷ page 121)
- ② Drive program (▷ page 122)
- ③ Text field
- ④ Menu bar
- ⑤ Outside temperature or speed (▷ page 179)
- ⑥ Time
- ⑦ Transfer case position (▷ page 162)

► **To show menu bar ④:** press the ◀ or ▶ button on the steering wheel.

Menu bar ④ disappears after a few seconds. Text field ③ shows the selected menu or sub-menu as well as display messages.

For further information on displaying the transmission position, see (▷ page 119).

i You can set the time using COMAND (see the separate operating instructions).

The following messages may appear in the multifunction display:

- ↑ Shift recommendation (▷ page 124)
- Cruise control (▷ page 141)
- LIM SPEEDTRONIC (▷ page 145)
- ECO start/stop function (▷ page 114)
- LOW RANGE LOW RANGE off-road gear (▷ page 162)
- HOLD HOLD function (▷ page 157)

Menus and submenus

Menu overview

Press the ◀ or ▶ button on the steering wheel to call up the menu bar and select a menu. Operating the on-board computer (▷ page 172). Depending on the equipment installed in the vehicle, you can call up the following menus:

- Trip menu (▷ page 173)
- Navi menu (navigation instructions) (▷ page 174)
- Audio menu (▷ page 176)
- Tel menu (telephone) (▷ page 177)
- DriveAssist menu (assistance) (▷ page 178)
- Serv menu (▷ page 178)
- Sett menu (settings) (▷ page 178)
- AMG menu in AMG vehicles (▷ page 182)

Trip menu

Standard display







► Press and hold the button on the steering wheel until the Trip menu with trip odometer ① and odometer ② is shown.

Trip computer "From start" or "From reset"



Example: trip computer "From Start"

- ① Distance
- ② Time

- ③ Average speed
- ④ Average fuel consumption
- ▶ Press the  or  button on the steering wheel to select the **Trip** menu.
- ▶ Press  or  to select **From Start** or **From Reset**.

The values in the **From Start** submenu are calculated from the start of a journey whilst the values in the **From Reset** submenu are calculated from the last time the submenu was reset (> page 174).





The **From Start** trip computer is automatically reset when:

- the ignition has been switched off for more than four hours.
- 999 hours have been exceeded.
- 9,999 miles have been exceeded.

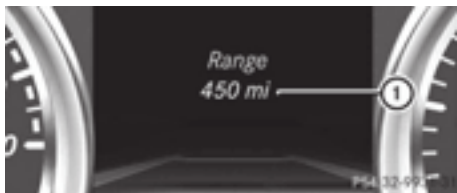
The **From Reset** trip computer is automatically reset if the value exceeds 9999 hours or 99,999 miles.

Range







- ① Approximate range
- ▶ Press the  or  button on the steering wheel to select the **Trip** menu.
- ▶ Press  or  to select the approximate range.

The approximate range that can be covered depends on the fuel level and your current driving style. If there is only a small amount of fuel left in the fuel tank, the display shows a vehicle being refueled  instead of the range.

Digital speedometer







- ① Digital speedometer
- ▶ Press the  or  button on the steering wheel to select the **Trip** menu.
- ▶ Press the  or  button to select the digital speedometer.

Resetting values



Example: resetting the trip computer "From Start"

- ▶ Press the  or  button on the steering wheel to select the **Trip** menu.
- ▶ Press the  or  button to select the function that you wish to reset.
- ▶ Press the **OK** button.
- ▶ Press the  button to select **Yes** and press the **OK** button to confirm.

You can reset the values of the following functions:



- Trip odometer
- "From Start" trip computer
- "From Reset" trip computer

Navigation system menu

Displaying navigation instructions

In the **Navi** menu, the multifunction display shows navigation instructions.

For further information, see the separate operating instructions.

- ▶ Switch on COMAND (see the separate operating instructions).
- ▶ Press the  or  button on the steering wheel to select the **Navi** menu.

Route guidance not active

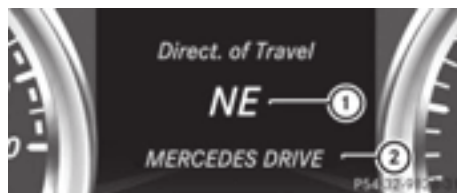

- ① Direction of travel
- ② Current road

Route guidance active

No change of direction announced



- ① Distance to destination
- ② Distance to the next change of direction
- ③ Current road
- ④ "Follow the road's course" symbol

Change of direction announced without a lane recommendation



- ① Road into which the change of direction leads
- ② Distance to change of direction and visual distance display
- ③ Change-of-direction symbol

When a change of direction is announced, you will see symbol ③ for the change of direction and distance graphic ②. The distance indicator

shortens towards the top of the display as you approach the point of the announced change of direction.

Change of direction announced with a lane recommendation

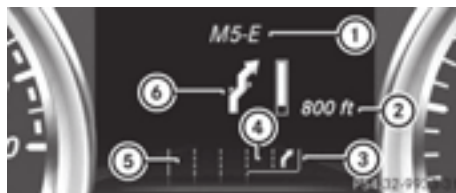

- ① Road into which the change of direction leads
- ② Distance to change of direction and visual distance display
- ③ Lane recommendation
- ④ New lane during a change of direction
- ⑤ Uninterrupted lane
- ⑥ Change-of-direction symbol

On multilane roads, the system can display lane recommendation ③ for the next change of direction. During the change of direction, additional lanes may be displayed.

Lane recommendations are only displayed if the relevant data is available on the digital map.

Other status indicators of the navigation system

-  : you have reached the destination or an intermediate destination.
- **New Route...** or **Calculating Route**: calculating a new route
- **Off Map** or **Off Mapped Road**: the vehicle position is outside the area of the digital map (off-map position)
- **No Route**: no route could be calculated to the selected destination

Audio menu

Selecting a radio station



- ① Waveband
- ② Station frequency with memory position
- ❗ Station ② is displayed with the station frequency or station name. The memory position is only displayed along with station ② if this has been stored.

- ▶ Switch on COMAND and select Radio (see the separate operating instructions).
- ▶ Press the ◀ or ▶ button on the steering wheel to select the **Audio** menu.
- ▶ **To select a stored station:** briefly press the ▲ or ▼ button.
- ▶ **To select a station from the station list:** press and briefly hold the ▲ or ▼ button.

If no station list is received:

- ▶ **To select a station using the station search:** press and briefly hold the ▲ or ▼ button.
- ❗ For information on switching wavebands and storing stations, (see the separate operating instructions).

- ❗ SIRIUS XM satellite radio functions like a normal radio.

For more information on satellite radio operation, see the separate operating instructions.

Operating audio devices or media



Example: CD/DVD changer display

- ① Current CD in the CD/DVD changer
- ② Current title

Audio data from various audio devices or media can be played, depending on the equipment installed in the vehicle.

- ▶ Switch on COMAND and select the audio device or medium (see the separate operating instructions).
- ▶ Press the ◀ or ▶ button on the steering wheel to select the **Audio** menu.
- ▶ **To select the next/previous track:** briefly press the ▲ or ▼ button.
- ▶ **To select a track from the track list (rapid scrolling):** press and hold the ▲ or ▼ button until desired track ② has been reached.

If you press and hold ▲ or ▼, the rapid scrolling speed is increased. Not all audio drives or data carriers support this function.

If track information is stored on the audio device or medium, the multifunction display will show the number and title of the track.





Video DVD operation



Example: CD/DVD changer display

- ① Current DVD in the CD/DVD changer
- ② Current scene

- ▶ Switch on COMAND and select video DVD (see the separate operating instructions).
- ▶ Press the ◀ or ▶ button on the steering wheel to select the **Audio** menu.

- ▶ **To select the next/previous scene:** briefly press the  or  button.
- ▶ **To select a scene from the scene list (rapid scrolling):** press and hold the  or  button until desired scene ② has been reached.

Telephone menu



Introduction

WARNING

If you operate information systems and communication equipment integrated in the vehicle while driving, you will be distracted from traffic conditions. You could also lose control of the vehicle. There is a risk of an accident.

Only operate the equipment when the traffic situation permits. If you are not sure that this is possible, park the vehicle paying attention to traffic conditions and operate the equipment when the vehicle is stationary.

When telephoning, you must observe the legal requirements for the country in which you are currently driving.

- ▶ Switch on the mobile phone (see the separate operating instructions).
- ▶ Switch on COMAND (see the separate operating instructions).
- ▶ Establish a Bluetooth® connection to COMAND, see the separate operating instructions.
- ▶ Press the  or  button on the steering wheel to select the **Te1** menu.

You will see one of the following display messages in the multifunction display:

- **Phone READY** or the name of the network provider: the mobile phone has found a network and is ready to receive.
- **Phone No Service:** there is no network available or the mobile phone is searching for a network.

Accepting a call

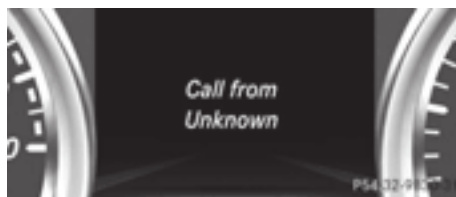

Example: incoming call

If someone calls you when you are in the **Te1** menu, a display message appears in the multifunction display.

- ▶ Press the  button on the steering wheel to accept an incoming call.







You can accept a call even if you are not in the **Te1** menu.

Rejecting or ending a call



- ▶ Press the  button on the steering wheel.

You can end or reject a call even if you are not in the **Te1** menu.



Dialing a number from the phone book

- ▶ Press the  or  button on the steering wheel to select the **Te1** menu.
- ▶ Press the ,  or  button to switch to the phone book.
- ▶ Press the  or  button to select the desired name.



or

- ▶ **To begin rapid scrolling:** press and hold the  or  button for longer than one second.

Rapid scrolling stops when you release the button or reach the end of the list.

- ▶ **If only one telephone number is stored for a name:** press the  or  button to start dialing.

or

- ▶ **If there is more than one number for a particular name:** press the  or  button to display the numbers.

- ▶ Press the  or  button to select the number you want to dial.







- ▶ Press the  or  button to start dialing.

or



- ▶ **To exit the telephone book:** press the  or  button.

Redialing

The on-board computer saves the last names or numbers dialed in the redial memory.

- ▶ Press the  or  button on the steering wheel to select the **Tel** menu.
- ▶ Press the  button to switch to the redial memory.
- ▶ Press the  or  button to select the desired name or number.
- ▶ Press the  or  button to start dialing.

or

- ▶ **To exit the redial memory:** press the  or  button.

Assistance menu



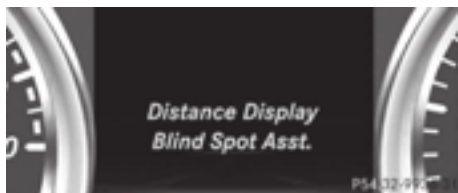

Introduction









In the **DriveAssist** menu, you have the following options:

- Showing the distance display (▷ page 178)
- Activating/deactivating Blind Spot Assist (▷ page 178)

Showing the distance display

- ▶ Press  or  on the steering wheel to select the **DriveAssist** menu.
- ▶ Press the  or  button to select **Distance Display**.
- ▶ Press the  button.
The DISTRONIC PLUS distance display appears in the multifunction display (▷ page 151).

Activating/deactivating Blind Spot Assist

- ▶ Press  or  on the steering wheel to select the **DriveAssist** menu.
- ▶ Press the  or  button to select **Blind Spot Asst.**
- ▶ Press the  button.
The current selection is displayed.
- ▶ **To activate/deactivate:** press the  button again.

For further information about Blind Spot Assist, see (▷ page 154).

Service menu



Example: service menu

In the **Service** menu, you have the following options:

- Calling up display messages (▷ page 184)
- Checking the tire pressure electronically (▷ page 270)
- Calling up the service due date (▷ page 240)
- Engine oil, check oil level (▷ page 236)

Settings menu

Introduction

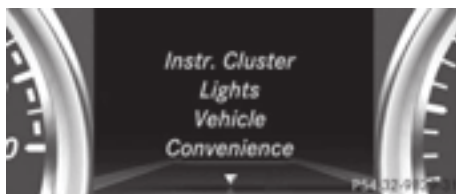

Example: settings menu

In the **Sett.** menu, you have the following options:

- Changing the instrument cluster settings (▷ page 179)
- Changing the light settings (▷ page 179)
- Changing the vehicle settings (▷ page 180)
- Changing the convenience settings (▷ page 181)
- Restoring the factory settings (▷ page 181)

Instrument cluster

Selecting the unit of measurement for distance

The **Display Unit Speed-/Odometer:** function allows you to choose whether certain displays appear in kilometers or miles in the multifunction display.

You can determine whether the multifunction display shows some messages in miles or kilometers.

- ▶ Press the or button on the steering wheel to select the **Sett.** menu.
- ▶ Press the or button to select the **Inst. Cluster** submenu.
- ▶ Press to confirm.
- ▶ Press the or button to select the **Display Unit Speed-/Odometer:** function.
You will see the selected setting: **km** or **miles**.
- ▶ Press the button to save the setting.

The selected unit of measurement for distance applies to:

- **Vehicles with instrument cluster in kilometers:** digital speedometer in the **Trip** menu
- the odometer and the trip odometer
- the trip computer
- the current consumption and the range
- the navigation instructions in the **Navi** menu
- cruise control
- SPEEDTRONIC
- DISTRONIC PLUS
- the service interval display

Selecting the permanent display function

You can determine whether the multifunction display permanently shows your speed or the outside temperature.

- ▶ Press the or button on the steering wheel to select the **Sett.** menu.
- ▶ Press the or button to select the **Inst. Cluster** submenu.
- ▶ Press to confirm.
- ▶ Press the or button to select the **Permanent Display:** function.
You will see the selected setting: **Outside Temperature** or **Speedometer [mph]**.
- ▶ Press the button to save the setting.

Speed is displayed in mph.

Lights

Setting the daytime running lamps

- This function is not available in Canada.
- ▶ Press the or button on the steering wheel to select the **Sett.** menu.
- ▶ Press the or button to select the **Lights** submenu.
- ▶ Press to confirm.
- ▶ Press or to select the **Daytime Running Lights** function.
If the **Daytime Running Lights** have been switched on, the cone of light and the symbol in the multifunction display are shown in red.
- ▶ Press the button to save the setting.

Further information on daytime running lamps (▷ page 85).

Surround lighting and exterior lighting delayed switch-off

- ▶ Press the or button on the steering wheel to select the **Sett.** menu.
- ▶ Press the or button to select the **Light** submenu.
- ▶ Press to confirm.
- ▶ Press or to select the **Surround Lighting** function.
When the **Surround Lighting** function is activated, the cone of light in the multifunction display is shown in red.
- ▶ Press the button to save the setting.

Deactivating delayed switch-off of the exterior lighting temporarily:

- ▶ Before leaving the vehicle, turn the SmartKey to position **0** (▷ page 112) in the ignition lock.
- ▶ Turn the SmartKey to position **2** in the ignition lock (▷ page 112).
The exterior lighting delayed switch-off is deactivated.

Delayed switch-off of the exterior lighting is reactivated the next time you start the engine.

If you have activated the **Surround Lighting** function and the light switch is set to **AUTO**, the following functions are activated when it is dark:

- **surround lighting:** the exterior lighting remains lit for 40 seconds after unlocking with the SmartKey. If you start the engine, the surround lighting is switched off and automatic headlamp mode is activated (▷ page 85).
- **exterior lighting delayed switch-off:** the exterior lighting remains lit for 60 seconds after the engine is switched off. If you close all the doors and the trunk lid, the exterior lighting goes off after 15 seconds.

i Depending on your vehicle's equipment, when the surround lighting and delayed switch-off exterior lighting are on, the following light up:

- Parking lamps
- Low-beam headlamps
- Daytime running lamps
- Side marker lamps
- Surround lighting in the exterior mirrors

Activating/deactivating the interior lighting delayed switch-off

If you activate the **Interior Lighting Delay** function, the interior lighting remains on for 20 seconds after you remove the SmartKey from the ignition lock.

- ▶ Press the **◀** or **▶** button on the steering wheel to select the **Sett.** menu.
- ▶ Press the **▼** or **▲** button to select the **Lights** submenu.
- ▶ Press **OK** to confirm.

- ▶ Press **▼** or **▲** to select the **Interior Lighting Delay** function.

When the **Interior Lighting Delay** function is activated, the vehicle interior is displayed in red in the multifunction display.

- ▶ Press the **OK** button to save the setting.

Vehicle

Activating/deactivating the automatic door locking mechanism

If you activate the **Automatic Door Lock** function, the vehicle is centrally locked above a speed of approximately 9 mph (15 km/h).

- ▶ Press the **◀** or **▶** button on the steering wheel to select the **Sett.** menu.
- ▶ Press the **▼** or **▲** button to select the **Vehicle** submenu.
- ▶ Press **OK** to confirm.
- ▶ Press the **▼** or **▲** button to select the **Automatic Door Lock** function.
When the **Automatic Door Lock** function is activated, the vehicle doors are displayed in red in the multifunction display.
- ▶ Press the **OK** button to save the setting.

For further information on the automatic locking feature, see (▷ page 66).

Activating/deactivating the acoustic locking verification signal

If you switch on the **Acoustic Lock** function, an acoustic signal sounds when you lock the vehicle.

- ▶ Press the **◀** or **▶** button on the steering wheel to select the **Sett.** menu.
- ▶ Press **▼** or **▲** to select the **Vehicle** submenu.
- ▶ Press **OK** to confirm.
- ▶ Press the **▼** or **▲** button to select the **Acoustic Lock** function.
If the **Acoustic Lock** function is activated, the **🔒** symbol in the multifunction display lights up red.
- ▶ Press the **OK** button to save the setting.

Convenience

Activating/deactivating the EASY-ENTRY/EXIT feature

WARNING









When the EASY-ENTRY/EXIT feature adjusts the steering wheel, you and other vehicle occupants – particularly children – could become trapped. There is a risk of injury.

While the EASY-ENTRY/EXIT feature is making adjustments, make sure that no one has any body parts in the sweep of the steering wheel.

If somebody becomes trapped:

- press one of the memory function position buttons, or
- move the switch for steering wheel adjustment in the opposite direction to that in which the steering wheel is moving.





The adjustment process is stopped.



- ▶ Press the  or  button on the steering wheel to select the **Sett.** menu.
- ▶ Press the  or  button to select the **Convenience** submenu.
- ▶ Press  to confirm.
- ▶ Press the  or  button to select the **Easy Entry/Exit** function.
If the **Easy Entry/Exit** function is activated, the vehicle steering wheel appears in red in the multifunction display.
- ▶ Press the  button to save the setting.

Further information on the EASY-ENTRY/EXIT feature (▷ page 79).

Switching the fold-in mirrors when locking feature on/off

When you activate the **Auto. Mirror Folding** function, the exterior mirrors are folded in when the vehicle is locked. If you unlock the vehicle and then open a door, the exterior mirrors fold out again.

- ▶ Press the  or  button on the steering wheel to select the **Sett.** menu.
- ▶ Press the  or  button to select the **Convenience** submenu.
- ▶ Press  to confirm.

- ▶ Press  or  to select the **Auto. Mirror Folding** function.

If the **Auto. Mirror Folding** function is activated, the vehicle's exterior mirror is displayed in red in the multifunction display.

- ▶ Press the  button to save the setting.











- ① To fold the exterior mirrors in or out

If you have switched the **Auto. Mirror Folding** on and you fold the exterior mirrors in using button ①, they will not fold out automatically (▷ page 80).

You can then only fold out the exterior mirrors using button ①.

Restoring the factory settings

- ▶ Press the  or  button on the steering wheel to select the **Sett.** menu.
- ▶ Press the  or  button to select the **Factory Setting** submenu.
- ▶ Press  to confirm.
The **Reset All Settings?** message appears.
- ▶ Press the  or  button to select **No** or **Yes**.
- ▶ Press  to confirm the selection.
If you select **Yes**, the multifunction display shows a confirmation message.

For safety reasons, the **Daytime Running Lights** function in the **Lights** submenu is only reset if the vehicle is stationary.

AMG menu in AMG vehicles

AMG displays

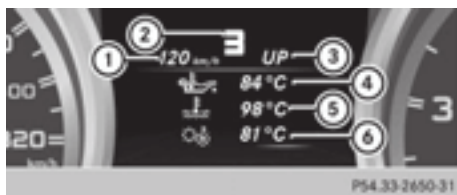

- ① Digital speedometer
- ② Gear indicator
- ③ Upshift indicator
- ④ Engine oil temperature
- ⑤ Coolant temperature
- ⑥ Transmission fluid temperature

► Press the ◀ or ▶ button on the steering wheel to select the **AMG** menu.

Upshift indicator **UP** ③ indicates that the engine has reached the over revving range when in the manual drive program. Upshift indicator **UP** ③ fades out other messages until you have shifted up.

If the engine oil temperature is below 176 °F (80 °C), the oil temperature is shown in blue. Avoid driving at full engine output during this time.

SETUP

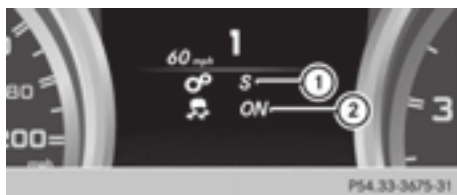

- ① Drive program (C/S/M)
- ② ESP® mode (ON/OFF)

SETUP shows the drive program and the ESP® (Electronic Stability Program) mode.

- Press the ◀ or ▶ button on the steering wheel to select the **AMG** menu.
- Press the ▲ button repeatedly until SETUP is displayed.

RACETIMER

Displaying and starting RACETIMER

The RACETIMER is only intended for use on a closed race circuit. Do not use the function on public roads.



- ① Lap
- ② RACETIMER

You can start the RACETIMER when the engine is running or if the key is in position **2** (▷ page 112) in the ignition lock.

- Press the ◀ or ▶ button on the steering wheel to select the **AMG** menu.
- Press the ▲ button repeatedly until the RACETIMER is shown.
- **To start:** press the **OK** button to start the RACETIMER.

Displaying the intermediate time



- Press the ◀ or ▶ button to select **Interm. Time**.
- Press **OK** to confirm. The intermediate time is displayed for five seconds.

Starting a new lap

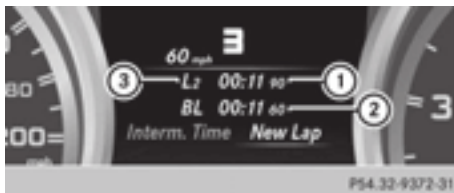

- ① RACETIMER
 - ② Fastest lap time (best lap)
 - ③ Lap
- ▶ Press to confirm **New Lap**.

i It is possible to store a maximum of sixteen laps. The 16th lap can only be completed with **Finish Lap**.

Stopping the RACETIMER

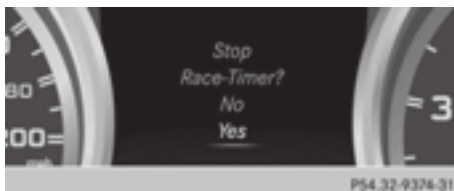

- ▶ Press the button on the steering wheel.
- ▶ Confirm **Yes** with .

The RACETIMER is interrupted if you stop the vehicle and turn the SmartKey to position **1** (▶ page 112) in the ignition lock. If you turn the SmartKey to position **2** or **3** (▶ page 112) and then press to confirm **Start**, timing is continued.

Resetting the current lap

- ▶ Stop the RACETIMER (▶ page 183).
- ▶ Press the or button to select **Reset Lap**.
- ▶ Press to reset the lap time to "0".

Deleting all laps

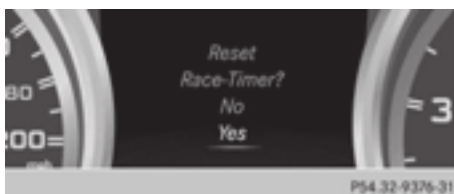

If you switch off the engine, the RACETIMER is reset to "0" after 30 seconds. All laps are deleted.

You cannot delete individual stored laps. If you have stopped 16 laps, the current lap does not have to be reset.

- ▶ Reset the current lap (▶ page 183).
- ▶ Press to confirm **Reset**. **Reset Race Timer?** appears in the multi-function display.
- ▶ Press the button to select **Yes** and press the button to confirm. All laps are deleted.

Overall statistics

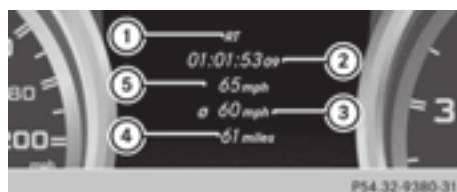

- ① RACETIMER overall evaluation
- ② Total time driven
- ③ Average speed
- ④ Distance covered
- ⑤ Maximum speed

This function is shown if you have stored at least one lap and stopped the RACETIMER.

- ▶ Press or on the steering wheel to select the **AMG** menu.
- ▶ Press the button repeatedly until the overall evaluation is shown.

Lap statistics

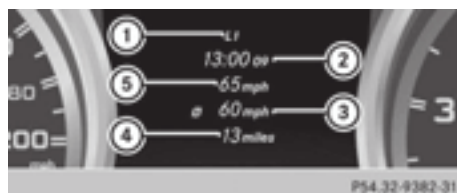

- ① Lap
- ② Lap time
- ③ Average lap speed
- ④ Lap length
- ⑤ Top speed during lap

This function is only available if you have stored at least two laps and have stopped the RACE-TIMER.

- ▶ Press or on the steering wheel to select the **AMG** menu.
- ▶ Press the button repeatedly until the lap evaluation is shown.
Each lap is shown in a separate submenu. The fastest lap is indicated by flashing symbol ①.
- ▶ Press the or button to select a different lap evaluation.

Display messages

Introduction

General notes

Display messages appear in the multifunction display.

Display messages with graphic displays may be shown in simplified form in the Operator's Manual and may differ from the messages shown in the multifunction display.

Please respond in accordance with the display messages and follow the additional notes in this Operator's Manual.

Certain display messages are accompanied by an audible warning tone or a continuous tone.

When you stop and park the vehicle, please observe the notes on:

- HOLD function (▷ page 157)
- Parking (▷ page 130)

Hiding display messages

- ▶ Press the or button on the steering wheel to hide the display message.
The display message is cleared.

Display messages with a high priority are shown in red.

You cannot hide display messages of the highest priority. The multifunction display shows these messages continuously until the causes for the messages have been remedied.

Message memory menu

The on-board computer saves certain display messages. You can call up the display messages in the **message memory**.

- ▶ Press the or button on the steering wheel to select the **Serv.** menu.
If there are display messages, the multifunction display shows **2 Messages**, for example.
- ▶ Press the or button to select the entry, e.g. **2 Messages**.
- ▶ Press to confirm.
- ▶ Press the or button to scroll through the display messages.

When the ignition is switched off, all display messages are deleted, apart from some high-priority display messages. Once the causes of the high-priority display messages have been rectified, the corresponding display messages are also deleted.

Safety systems

Display messages





ABS, ESP Defective
Visit Workshop

Possible causes/consequences and ► Solutions

ABS (Anti-lock Braking System), ESP® (Electronic Stability Program), BAS (Brake Assist), the HOLD function, hill start assist and ESP® trailer stabilization are temporarily unavailable.

BAS and the adaptive brake lights may also have failed.

In addition, the  and  warning lamps light up in the instrument cluster.

Possible causes are:

- self-diagnosis is not yet complete.
- the on-board voltage may be insufficient.

 **WARNING**

The brake system continues to function normally, but without the functions listed above. The wheels could therefore lock if you brake hard, for example.

The steerability and braking characteristics may be severely affected. The braking distance in an emergency braking situation can increase.

If ESP® is not operational, ESP® is unable to stabilize the vehicle.

There is an increased risk of skidding and an accident.

► Carefully drive a suitable distance, making slight steering movements at a speed above 12 mph (20 km/h).

If the display message disappears, the functions mentioned above are available again.

If the display message continues to be displayed:



- Drive on carefully.
- Visit a qualified specialist workshop.



Currently Unavailable
See Operator's
Manual

ABS, ESP®, BAS, the HOLD function, hill start assist and ESP® trailer stabilization are unavailable due to a malfunction.

BAS and the adaptive brake lights may also have failed.

In addition, the  and  warning lamps light up in the instrument cluster.

 **WARNING**







The brake system continues to function normally, but without the functions listed above. The wheels could therefore lock if you brake hard, for example.





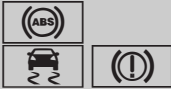





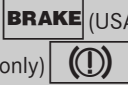

The steerability and braking characteristics may be severely affected. The braking distance in an emergency braking situation can increase.







If ESP® is not operational, ESP® is unable to stabilize the vehicle.



There is an increased risk of skidding and an accident.

- Drive on carefully.
- Visit a qualified specialist workshop immediately.

Display messages	Possible causes/consequences and ► Solutions
 <p>ESP Defective Visit Workshop</p>	<p>ESP®, BAS, the HOLD function, hill start assist and ESP® trailer stabilization are unavailable due to a malfunction.</p> <p>BAS and the adaptive brake lights may also have failed.</p> <p>The  warning lamp also lights up in the instrument cluster.</p> <p>The self-diagnosis function might not be complete, for example.</p> <p>⚠ WARNING</p> <p>The brake system continues to function normally, but without the functions listed above.</p> <p>The braking distance in an emergency braking situation can thus increase.</p> <p>If ESP® is not operational, ESP® is unable to stabilize the vehicle. There is an increased risk of skidding and an accident.</p> <p>► Carefully drive a suitable distance, making slight steering movements at a speed above 12 mph (20 km/h).</p> <p>If the display message disappears, the functions mentioned above are available again.</p> <p>If the display message continues to be displayed:</p> <p>► Drive on carefully.</p> <p>► Visit a qualified specialist workshop.</p>
 <p>ABS, ESP, EBD Defective Visit Workshop</p>	<p>EBD (electronic brake force distribution), ABS, ESP®, BAS, the HOLD function, hill start assist and ESP® trailer stabilization are unavailable due to a malfunction.</p> <p>BAS and the adaptive brake lights may also have failed.</p> <p>In addition, the ,  and  warning lamps light up in the instrument cluster and a warning tone sounds.</p> <p>⚠ WARNING</p> <p>The brake system continues to function normally, but without the functions listed above. The front and rear wheels could therefore lock if you brake hard, for example.</p> <p>The steerability and braking characteristics may be severely affected. The braking distance in an emergency braking situation can increase.</p> <p>If ESP® is not operational, ESP® is unable to stabilize the vehicle. There is an increased risk of skidding and an accident.</p> <p>► Drive on carefully.</p> <p>► Visit a qualified specialist workshop immediately.</p>
<p>PARK (USA only)  (Canada only)</p> <p>Release Park. Brake</p>	<p>You are driving with the parking brake applied. A warning tone also sounds.</p> <p>► Release the parking brake.</p>



Display messages	Possible causes/consequences and ► Solutions
 <p>BRAKE (USA only)  (Canada only)</p> <p>Check Brake Fluid Level</p>	<p>There is not enough brake fluid in the brake fluid reservoir. In addition, the BRAKE (USA only)/  (Canada only) warning lamp lights up in the instrument cluster and a warning tone sounds.</p> <p> WARNING</p> <p>The braking effect may be impaired. There is a risk of an accident.</p> <ul style="list-style-type: none"> ► Pull over and stop the vehicle safely as soon as possible, paying attention to road and traffic conditions. Do not continue driving under any circumstances. ► Secure the vehicle against rolling away (► page 130). ► Consult a qualified specialist workshop. ► Do not add brake fluid. This does not correct the malfunction.
 <p>Check Brake Pad Wear</p>	<p>The brake pads/linings have reached their wear limit.</p> <ul style="list-style-type: none"> ► Visit a qualified specialist workshop.
 <p>mbrace Inoperative</p>	<p>USA only: one or more main functions of the mbrace system are malfunctioning.</p> <p>Canada only: one or more main functions of the TELE AID system are malfunctioning.</p> <ul style="list-style-type: none"> ► USA only: have the mbrace system checked at a qualified specialist workshop. ► Canada only: have the Tele AID system checked at a qualified specialist workshop.
 <p>SRS Malfunction Service Required</p>	<p>The restraint system is faulty. The  warning lamp also lights up in the instrument cluster.</p> <p> WARNING</p> <p>The air bags or Emergency Tensioning Devices may either be triggered unintentionally or, in the event of an accident, may not be triggered. There is an increased risk of injury.</p> <ul style="list-style-type: none"> ► Visit a qualified specialist workshop. <p>For further information about the restraint system, see (► page 34).</p>
 <p>Front Left Malfunction Service Required or Front Right Malfunction Service Required</p>	<p>The restraint system has malfunctioned at the front on the left or right. The  warning lamp also lights up in the instrument cluster.</p> <p> WARNING</p> <p>The air bags or Emergency Tensioning Devices may either be triggered unintentionally or, in the event of an accident, may not be triggered. There is an increased risk of injury.</p> <ul style="list-style-type: none"> ► Visit a qualified specialist workshop.









Display messages	Possible causes/consequences and ► Solutions
 <p>Rear Left Malfunction Service Required or Rear Right Malfunction Service Required</p>	<p>The rear left-hand or right-hand restraint system has malfunctioned. The  warning lamp also lights up in the instrument cluster.</p> <p>⚠ WARNING</p> <p>The air bags or Emergency Tensioning Devices may either be triggered unintentionally or, in the event of an accident, may not be triggered. There is an increased risk of injury.</p> <p>► Visit a qualified specialist workshop.</p>
 <p>Rear Center Malfunction Service Required</p>	<p>The rear center restraint system has malfunctioned. The  warning lamp also lights up in the instrument cluster.</p> <p>⚠ WARNING</p> <p>The air bags or Emergency Tensioning Devices may either be triggered unintentionally or, in the event of an accident, may not be triggered. There is an increased risk of injury.</p> <p>► Visit a qualified specialist workshop.</p>
 <p>Left Side Curtain Airbag Malfunction Service Required or Right Side Curtain Airbag Malfunction Service Required</p>	<p>There is a malfunction in the left-hand or right-hand window curtain air bag. The  warning lamp also lights up in the instrument cluster.</p> <p>⚠ WARNING</p> <p>The left or right window curtain air bag may either be triggered unintentionally or, in the event of an accident, may not be triggered. There is an increased risk of injury.</p> <p>► Visit a qualified specialist workshop.</p>









Display messages	Possible causes/consequences and ► Solutions
Front Passenger Air-bag Disabled See Operator's Manual	<p>A BabySmart™ compatible child restraint system is installed on the front-passenger seat.</p> <p>The  indicator lamp also lights up.</p> <p>The front-passenger air bag is therefore disabled.</p> <p>Further information on BabySmart™ (► page 50).</p>
Front Passenger Air-bag Enabled See Operator's Manual	<p>The  indicator lamp does not remain lit if a special BabySmart™-compatible child restraint system has been installed on the front-passenger seat.</p> <p>The BabySmart™ system is malfunctioning.</p> <p>⚠ WARNING</p> <p>The front-passenger front air bag can be triggered unintentionally in the event of an accident.</p> <p>There is a risk of an accident.</p> <ul style="list-style-type: none"> ► Make sure there is nothing between the seat cushion and the child seat. ► Check for correct installation of the child restraint system. ► If the  indicator lamps do not light up, have the BabySmart™ system checked as soon as possible at a qualified specialist workshop. <p>Do not transport a child on the front-passenger seat until the air bag deactivation system has been repaired.</p>

Lights

- i** Display messages about LEDs:
This display message will only appear if all LEDs have failed.

Display messages	Possible causes/consequences and ► Solutions
 Check Left Low Beam or Check Right Low Beam	<p>The left or right-hand low-beam headlamp is defective.</p> <ul style="list-style-type: none"> ► Visit a qualified specialist workshop.
 Check Trailer Left Tail Lamp or Check Trailer Right Tail Lamp	<p>The left or right-hand trailer tail lamp is faulty.</p> <ul style="list-style-type: none"> ► Check whether you are permitted to replace the bulb yourself. or ► Visit a qualified specialist workshop.
 Check Trailer Left Turn Signal or Check Trailer Right Turn Signal	<p>The left or right-hand trailer turn signal lamp is defective.</p> <ul style="list-style-type: none"> ► Check whether you are permitted to replace the bulb yourself. or ► Visit a qualified specialist workshop.

Display messages	Possible causes/consequences and ► Solutions
 Check Trailer Brake Lamp	The trailer brake lamp is defective. ► Check whether you are permitted to replace the bulb yourself. or ► Visit a qualified specialist workshop.
 Check Rear Left Turn Signal or Check Rear Right Turn Signal	The rear left-hand or rear right-hand turn signal is defective. ► Check whether you are permitted to replace the bulb yourself (▷ page 93). or ► Visit a qualified specialist workshop.
 Check Front Left Turn Signal or Check Front Right Turn Signal	The front left-hand or front right-hand turn signal is defective. ► Check whether you are permitted to replace the bulb yourself (▷ page 93). or ► Visit a qualified specialist workshop.
 Check Left Mirror Turn Signal or Check Right Mirror Turn Signal	The turn signal in the left-hand or right-hand exterior mirror is defective. ► Visit a qualified specialist workshop.
 Check Center Brake Lamp	The high-mounted brake lamp is faulty. ► Visit a qualified specialist workshop.
 Check Left Brake Lamp or Check Right Brake Lamp	The left or right-hand brake lamp is defective. ► Replace the bulb (▷ page 92).
 Check Left High Beam or Check Right High Beam	The left or right-hand high beam is defective. ► Visit a qualified specialist workshop.
 License Plate Lamp	There is a short circuit in the LED lamps. The LEDs have been switched off. ► Visit a qualified specialist workshop.
 Rear Fog Lamp	The rear fog lamp is defective. ► Check whether you are permitted to replace the bulb yourself (▷ page 93). or ► Visit a qualified specialist workshop.

Display messages	Possible causes/consequences and ► Solutions
 <p>Front Left Parking Lamp or Front Right Parking Lamp</p>	<p>The front left or front right parking or standing lamp is defective.</p> <ul style="list-style-type: none"> ► Check whether you are permitted to replace the bulb yourself (▷ page 93). or ► Visit a qualified specialist workshop.
 <p>Backup Light</p>	<p>The backup lamp is defective.</p> <ul style="list-style-type: none"> ► Replace the bulb (▷ page 92).
 <p>Check Front Left Sidemarkers Lamp or Check Front Right Sidemarkers Lamp</p>	<p>The left or right front side marker lamp is defective.</p> <ul style="list-style-type: none"> ► Check whether you are permitted to replace the bulb yourself (▷ page 93). or ► Visit a qualified specialist workshop.
 <p>Check Left Tail Lamp or Check Right Tail Lamp</p>	<p>The left or right-hand tail lamp is defective.</p> <ul style="list-style-type: none"> ► Check whether you are permitted to replace the bulb yourself (▷ page 93). or ► Visit a qualified specialist workshop.
 <p>Check Left Daytime Running Light or Check Right Daytime Running Light</p>	<p>The left or right-hand daytime running lamp is defective.</p> <ul style="list-style-type: none"> ► Visit a qualified specialist workshop.
 <p>Malfunction See Operator's Manual</p>	<p>The exterior lighting is defective.</p> <ul style="list-style-type: none"> ► Visit a qualified specialist workshop.
 <p>Auto Lamp Function Inoperative</p>	<p>The light sensor is defective.</p> <ul style="list-style-type: none"> ► Visit a qualified specialist workshop.
 <p>Switch Off Lights</p>	<p>The lights are still switched on when you leave the vehicle. A warning tone also sounds.</p> <ul style="list-style-type: none"> ► Turn the light switch to AUTO.

Engine

Display messages

Possible causes/consequences and ► Solutions



Check Coolant Level. See Operator's Manual

The coolant level is too low.

- Add coolant, observing the warning notes before doing so (► page 238).
- Have the coolant system checked at a qualified specialist workshop if the coolant needs topping up more often than usual.



The fan motor is faulty.

- At coolant temperatures below 248 °F (120 °C), drive to the nearest qualified specialist workshop.
- Avoid heavy loads on the engine as you do so, e.g. driving in mountainous terrain and stop-start traffic.



Coolant Too Hot
Stop Vehicle Switch
Engine Off

The coolant is too hot.

A warning tone also sounds.



WARNING



Do not drive when your engine is overheated. This can cause some fluids which may have leaked into the engine compartment to catch fire.







Steam from the overheated engine can also cause serious burns which can occur just by opening the hood.

There is a risk of injury.



- Pull over and stop the vehicle safely and switch off the engine, paying attention to road and traffic conditions.
- Secure the vehicle against rolling away (► page 130).
- Leave the vehicle and keep a safe distance from the vehicle until the engine has cooled down.
- Make sure that the air supply to the engine radiator is not blocked, e.g. by snow, slush or ice.
- Do not start the engine again until the display message goes out and the coolant temperature is below 248 °F (120 °C). Otherwise, the engine could be damaged.
- Pay attention to the coolant temperature display.
- If the temperature increases again, visit a qualified specialist workshop immediately.

Under normal operating conditions and with the specified coolant level, the coolant temperature may rise to 248 °F (120 °C).

Display messages	Possible causes/consequences and ► Solutions
	<p>The poly-V-belt may have torn.</p> <ul style="list-style-type: none"> ► Pull over and stop the vehicle safely and switch off the engine, paying attention to road and traffic conditions. ► Check the poly-V-belt. <p>If the poly-V-belt is torn:</p> <ul style="list-style-type: none"> ! Do not continue driving. The engine could otherwise overheat. ► Consult a qualified specialist workshop. <p>If the poly-V-belt is not damaged:</p> <ul style="list-style-type: none"> ► Wait until the display message disappears before restarting the engine. Otherwise, the engine could be damaged. ► Pay attention to the coolant temperature display. ► Visit a qualified specialist workshop.
	<p>The battery is not being charged. A warning tone also sounds. Possible causes are:</p> <ul style="list-style-type: none"> • a defective alternator • a torn poly-V-belt • a malfunction in the electronics <ul style="list-style-type: none"> ► Pull over and stop the vehicle safely and switch off the engine, paying attention to road and traffic conditions. ► Open the hood. ► Check whether the poly-V-belt is torn. <p>If the poly-V-belt is torn:</p> <ul style="list-style-type: none"> ! Do not continue driving. The engine could otherwise overheat. ► Consult a qualified specialist workshop. <p>If the poly-V-belt is not damaged:</p> <ul style="list-style-type: none"> ► Visit a qualified specialist workshop.
 <p>Check Engine Oil At Next Refueling</p>	<p>The engine oil level has dropped to the minimum level. A warning tone also sounds.</p> <ul style="list-style-type: none"> ► Check the oil level when next refueling, at the latest (► page 236). ► If necessary, add engine oil (► page 237). ► Have the engine checked at a qualified specialist workshop if engine oil needs to be added more often than usual. <p>! Avoid long journeys with too little engine oil. The engine will otherwise be damaged.</p> <p>Information on approved engine oils can be obtained from any qualified specialist workshop or on the Internet at http://www.mbusa.com (USA only).</p>

Display messages	Possible causes/consequences and ► Solutions
 <p>Engine Oil Level Low Stop Vehicle Switch Engine Off</p>	<p>The engine oil level is too low. There is a risk of engine damage.</p> <ul style="list-style-type: none"> ► Pull over and stop the vehicle safely and switch off the engine, paying attention to road and traffic conditions. ► Add engine oil (► page 237) and check the oil level (► page 236).
 <p>Check Engine Oil Level (Add 1 quart)</p>	<p>AMG vehicles: the engine oil level is too low.</p> <ul style="list-style-type: none"> ► Check the oil level when next refueling, at the latest (► page 236). ► If necessary, add engine oil (► page 237). ► Have the engine checked at a qualified specialist workshop if engine oil needs to be added more often than usual. <p>! Avoid long journeys with too little engine oil. The engine will otherwise be damaged.</p> <p>Information on approved engine oils can be obtained from any qualified specialist workshop or on the Internet at http://www.mbusa.com (USA only).</p>
 <p>Engine Oil Level Cannot Be Measured</p>	<p>The measuring system is malfunctioning.</p> <ul style="list-style-type: none"> ► Visit a qualified specialist workshop.
 <p>Fuel Level Low</p>	<p>The fuel level has dropped into the reserve range.</p> <ul style="list-style-type: none"> ► Refuel at the nearest gas station.
	<p>There is only a very small amount of fuel in the fuel tank.</p> <ul style="list-style-type: none"> ► Refuel at the nearest gas station without fail.
 <p>Gas Cap Loose</p>	<p>The fuel system pressure is too low. The fuel filler cap is not closed correctly or the fuel system is leaking.</p> <ul style="list-style-type: none"> ► Check that the fuel filler cap is correctly closed. <p>If the fuel filler cap is not correctly closed:</p> <ul style="list-style-type: none"> ► Close the fuel filler cap. <p>If the fuel filler cap is correctly closed:</p> <ul style="list-style-type: none"> ► Visit a qualified specialist workshop.

Driving systems	
Display messages	Possible causes/consequences and ► Solutions
TC shift conditions not fulfilled Apply the brake/ parking brake	<p>The parking brake has not been applied and the brake pedal has not been depressed. The transfer case has canceled the gear change process and is in Neutral. There is no connection between the engine and the drive wheels.</p> <ul style="list-style-type: none"> ► Pull over and stop the vehicle safely as soon as possible, paying attention to road and traffic conditions. ► Depress the brake pedal and apply the parking brake. ► Shift the automatic transmission to neutral position N. ► Make sure all conditions for changing gears are met (▷ page 162). ► Repeat the gearshift process.
TC malfunction Consult workshop about applying the parking brake	<p>There is a malfunction in the transfer case.</p> <ul style="list-style-type: none"> ► Do not shift the transfer case. ► When parking, secure the vehicle against rolling away (▷ page 130). ► Have the vehicle checked at a qualified specialist workshop.
TC shift canceled Reactivate	<p>The transfer case has not performed the gear change process.</p> <ul style="list-style-type: none"> ► Repeat the gearshift process. ► Make sure all conditions for changing gears are met (▷ page 162).
TC shift conditions not fulfilled Max. speed 25 mph	<p>You have exceeded the maximum speed for the gearshift process.</p> <ul style="list-style-type: none"> ► Drive more slowly. ► Repeat the gearshift process.
TC shift conditions not fulfilled Select NEUTRAL gear	<p>You have not met one or more shift conditions.</p> <ul style="list-style-type: none"> ► Shift the automatic transmission to neutral position N. ► Repeat the gearshift process.
TC shift conditions not fulfilled Max. speed 40 mph	<p>You have exceeded the maximum speed for the gearshift process.</p> <ul style="list-style-type: none"> ► Drive more slowly. ► Repeat the gearshift process.
LOW RANGE ON	<p>The transfer case is in the LOW RANGE off-road position.</p>
HIGH RANGE ON	<p>The transfer case is in the HIGH RANGE on-road position.</p>
Differential lock only available in LOW RANGE	<p>The LOW RANGE button has been pressed. The transfer case is in the LOW RANGE off-road driving position and a differential lock is engaged.</p> <ul style="list-style-type: none"> ► Disengage the differential locks (▷ page 164). ► Repeat the gearshift process.



Display messages	Possible causes/consequences and ► Solutions
TC NEUTRAL ON	<p>The transfer case is in the Neutral neutral position.</p> <p>A warning tone will also sound when the driver's door is opened and the brake pedal is not depressed.</p> <ul style="list-style-type: none"> ► Close the driver's door. ► Secure the vehicle against rolling away (▷ page 130). ► Shift the transfer case according to driving conditions (▷ page 162).
Preselected differential lock ESP unavailable	<p>A differential lock has been engaged. The differential gear has not yet locked the respective differential. The activation indicator lamp (yellow) (▷ page 164) of the switch lights up.</p> <p>ESP is unavailable.</p> <p>ABS is still available.</p>
Differential lock active ABS and ESP unavailable	<p>A differential lock was engaged and the differential gear has locked the respective differential. The activation indicator lamp (yellow) and function indicator lamp (red) (▷ page 164) on the switch light up.</p> <p>ABS and ESP are unavailable.</p>
Blind Spot Assist currently unavailable See Operator's Manual	<p>Blind Spot Assist is temporarily inoperative. Possible causes are:</p> <ul style="list-style-type: none"> • you have established the electrical connection between the trailer and your vehicle. • the sensors are dirty. • function is impaired due to heavy rain or snow. • the radar sensor system is outside the operating temperature range. • the radar sensor system is temporarily inoperative, e.g. due to electromagnetic radiation emitted by nearby TV or radio stations or other sources of electromagnetic radiation. <p>The yellow  indicator lamps also light up in the exterior mirrors.</p> <p>► When towing a trailer, confirm the display message with .</p> <p>If you are driving without a trailer and the display message does not disappear:</p> <ul style="list-style-type: none"> ► Pull over and stop the vehicle safely as soon as possible, paying attention to road and traffic conditions. ► Apply the parking brake. ► Clean the sensors (▷ page 244). ► Restart the engine. <p>If the system detects that the sensors are fully operational, the display message disappears.</p> <p>Blind Spot Assist is operational again.</p>
Blind Spot Assist or Inoperative	<p>Blind Spot Assist is defective.</p> <p>The yellow  indicator lamps also light up in the exterior mirrors.</p> <p>► Visit a qualified specialist workshop.</p>





Display messages	Possible causes/consequences and ► Solutions
DISTRONIC PLUS Off	DISTRONIC PLUS has been deactivated (▷ page 147). If it was deactivated automatically, a warning tone also sounds.
DISTRONIC PLUS Now Available	DISTRONIC PLUS is operational again after having been temporarily unavailable. You can now reactivate DISTRONIC PLUS (▷ page 147).
DISTRONIC PLUS Currently Unavailable. See Operator's Manual	<p>DISTRONIC is deactivated and temporarily inoperative. Possible causes are:</p> <ul style="list-style-type: none"> • the DISTRONIC PLUS cover in the radiator trim is dirty • function is impaired due to heavy rain or snow. • the sensors in the bumpers are dirty. • the radar sensor system is temporarily inoperative, e.g. due to electromagnetic radiation emitted by nearby TV or radio stations or other sources of electromagnetic radiation. • the system is outside the operating temperature range. • the transfer case is in the LOW RANGE transmission position. • the vehicle is on an uphill or a downhill slope of more than 22-25% • the on-board voltage is too low. <p>A warning tone also sounds.</p> <p>If the display message does not disappear:</p> <ul style="list-style-type: none"> ► Pull over and stop the vehicle safely as soon as possible, paying attention to road and traffic conditions. ► Apply the parking brake. ► Clean the DISTRONIC PLUS cover in the radiator trim and the bumper (▷ page 244). ► Restart the engine. <p>If the system detects that the sensors are fully operational, the display message disappears.</p> <p>DISTRONIC PLUS is operational again.</p>
DISTRONIC PLUS Inoperative	<p>DISTRONIC PLUS is defective.</p> <p>BAS (Brake Assist) may also have failed.</p> <p>A warning tone also sounds.</p> <ul style="list-style-type: none"> ► Visit a qualified specialist workshop.
DISTRONIC PLUS Passive	<p>You have depressed the accelerator pedal. DISTRONIC PLUS is no longer controlling the speed of the vehicle.</p> <ul style="list-style-type: none"> ► Remove your foot from the accelerator pedal.
DISTRONIC PLUS - - - mph	<p>An activation condition for DISTRONIC PLUS is not fulfilled.</p> <ul style="list-style-type: none"> ► Check the activation conditions for DISTRONIC PLUS (▷ page 147).
DISTRONIC PLUS and SPEEDTRONIC Inoperative	<p>DISTRONIC PLUS and SPEEDTRONIC are faulty. A warning tone also sounds.</p> <ul style="list-style-type: none"> ► Visit a qualified specialist workshop.



Display messages	Possible causes/consequences and ► Solutions
Cruise control and SPEEDTRONIC Inoperative	Cruise control and SPEEDTRONIC are malfunctioning. ► Visit a qualified specialist workshop.
Limit - - - mph	While depressing the accelerator pedal beyond the pressure point (kickdown), SPEEDTRONIC cannot be activated.
Cruise Control - - - mph	A condition for activating cruise control has not been fulfilled. You have tried to store a speed below 20 mph (30 km/h), for example. ► If conditions permit, drive faster than 20 mph (30 km/h) and store the speed. ► Check the activation conditions for cruise control (▷ page 141).



Tires

Display messages	Possible causes/consequences and ► Solutions
Tire pressure will be displayed after driving a few minutes	The tire pressure monitor is measuring the tire pressure. ► Drive on. The tire pressures appear in the multifunction display after you have been driving for a few minutes.
Tire Press. Monitor Inoperative	The tire pressure monitor is faulty. ► Visit a qualified specialist workshop.
Tire Pressure Monitor Inoperative No Wheel Sensors	The wheels mounted do not have a suitable tire pressure sensor. The tire pressure monitor is deactivated. ► Mount wheels with suitable tire pressure sensors. The tire pressure monitor is activated automatically after driving for a few minutes.



Display messages	Possible causes/consequences and ► Solutions
<p>Check Tires</p>	<p>The tire pressure in one or more tires has dropped significantly. The wheel position is displayed in the multifunction display. A warning tone also sounds.</p> <p> WARNING</p> <p>With tire pressures which are too low, there is a risk of the following hazards:</p> <ul style="list-style-type: none"> • they may burst, especially as the load and vehicle speed increase. • they may wear excessively and/or unevenly, which may greatly impair tire traction. • the driving characteristics, as well as steering and braking, may be greatly impaired. <p>There is a risk of an accident.</p> <ul style="list-style-type: none"> ► Stop the vehicle without making any sudden steering or braking maneuvers. Pay attention to the traffic conditions as you do so. ► Secure the vehicle against rolling away (▷ page 130). ► If there is a flat tire, inspect the tires (▷ page 250). ► Check the tire pressure (▷ page 268). ► If necessary, correct the tire pressure.
<p>Warning Tire Malfunction</p>	<p>The tire pressure in one or more tires has dropped suddenly. The wheel position is shown in the multifunction display. A warning tone also sounds.</p> <p> WARNING</p> <p>If you drive with a flat tire, there is a risk of the following hazards:</p> <ul style="list-style-type: none"> • a flat tire affects the ability to steer or brake the vehicle. • you could lose control of the vehicle. • continued driving with a flat tire will cause excessive heat build-up and possibly a fire. <p>There is a risk of an accident.</p> <ul style="list-style-type: none"> ► Stop the vehicle without making any sudden steering or braking maneuvers. Pay attention to the traffic conditions as you do so. ► Secure the vehicle against rolling away (▷ page 130). ► If there is a flat tire, inspect the tires (▷ page 250).
<p>Correct Tire Pressure</p>	<p>The tire pressure is too low in at least one of the tires, or the tire pressure difference between the wheels is too great.</p> <ul style="list-style-type: none"> ► Check the tire pressures at the next opportunity (▷ page 268). ► If necessary, correct the tire pressure. ► Restart the tire pressure monitor (▷ page 270).
<p>TirePress. Sensor(s) Missing</p>	<p>There is no signal from the tire pressure sensor of one or several wheels. The pressure of the affected tire is not displayed in the multifunction display.</p> <ul style="list-style-type: none"> ► Have the faulty tire pressure sensor replaced at a qualified specialist workshop.

Display messages	Possible causes/consequences and ► Solutions
<p>Tire Pressure Monitor Currently Unavailable</p>	<p>Due to a source of radio interference, no signals can be received from the wheel sensors. The tire pressure monitor is temporarily malfunctioning.</p> <p>► Drive on. The tire pressure monitor restarts automatically as soon as the problem has been solved.</p>
<p> Tire Pressure Warning, Tire Malfunction</p>	<p>The tire pressure in one or more tires has dropped suddenly. The wheel position is shown in the multifunction display. A warning tone also sounds.</p> <p> WARNING</p> <p>If you drive with a flat tire, there is a risk of the following hazards:</p> <ul style="list-style-type: none"> • a flat tire affects the ability to steer or brake the vehicle. • you could lose control of the vehicle. • continued driving with a flat tire will cause excessive heat build-up and possibly a fire. <p>There is a risk of an accident.</p> <p>► Stop the vehicle without making any sudden steering or braking maneuvers. Pay attention to the traffic conditions as you do so.</p> <p>► Secure the vehicle against rolling away (▷ page 130).</p> <p>► If there is a flat tire, inspect the tires (▷ page 250).</p>
<p> Check Tire Pressure</p>	<p>The tire pressure in one or more tires has dropped significantly. The wheel position is shown in the multifunction display. A warning tone also sounds.</p> <p> WARNING</p> <p>With tire pressures which are too low, there is a risk of the following hazards:</p> <ul style="list-style-type: none"> • they may burst, especially as the load and vehicle speed increase. • they may wear excessively and/or unevenly, which may greatly impair tire traction. • the driving characteristics, as well as steering and braking, may be greatly impaired. <p>There is a risk of an accident.</p> <p>► Stop the vehicle without making any sudden steering or braking maneuvers. Pay attention to the traffic conditions as you do so.</p> <p>► Secure the vehicle against rolling away (▷ page 130).</p> <p>► If there is a flat tire, inspect the tires (▷ page 250).</p> <p>► Check the tire pressure (▷ page 268).</p> <p>► If necessary, correct the tire pressure.</p>
<p> Correct Tire Pressure</p>	<p>The tire pressure is too low in at least one of the tires, or the tire pressure difference between the wheels is too great.</p> <p>► Check the tire pressures at the next opportunity (▷ page 268).</p> <p>► If necessary, correct the tire pressure.</p>

Vehicle	
Display messages	Possible causes/consequences and ► Solutions
Shift to P or N to Start Engine	<p>You have attempted to start the engine with the transmission in position R or D.</p> <p>► Shift the transmission to position P or N.</p>
Auxiliary Battery Malfunction	<p>The auxiliary battery for the automatic transmission is no longer being charged.</p> <p>► Visit a qualified specialist workshop at the next opportunity.</p> <p>► Until then, set the automatic transmission to position P before you switch off the engine.</p> <p>► Before leaving the vehicle, apply the parking brake.</p>
Apply Brake to Shift from P	<p>You have attempted to move the transmission selector lever to position D, R or N without depressing the brake pedal.</p> <p>► Depress the brake pedal.</p>
	<p>The rear door is open.</p> <p>⚠ WARNING</p> <p>When the engine is running, exhaust gases can enter the vehicle interior if the tailgate is open.</p> <p>There is a risk of poisoning.</p> <p>► Close the rear door.</p>
	<p>The hood is open.</p> <p>⚠ WARNING</p> <p>The open hood may block your view when the vehicle is in motion. There is a risk of an accident.</p> <p>► Pull over and stop the vehicle safely as soon as possible, paying attention to road and traffic conditions.</p> <p>► Secure the vehicle against rolling away (► page 130).</p> <p>► Close the hood.</p>
	<p>At least one door is open.</p> <p>A warning tone also sounds.</p> <p>► Close all the doors.</p>

Display messages	Possible causes/consequences and ► Solutions
 <p>Power Steering Malfunction. See Operator's Manual</p>	<p>The power steering is malfunctioning. A warning tone also sounds.</p> <p> WARNING</p> <p>You will need to use more force to steer. There is a risk of an accident.</p> <ul style="list-style-type: none"> ► Check whether you are able to apply the extra force required. ► If you are able to steer safely: carefully drive on to a qualified specialist workshop. ► If you are unable to steer safely: do not drive on. Contact the nearest qualified specialist workshop.
<p>Telephone No Service</p>	<p>Your vehicle is outside the network provider's transmitter/receiver range.</p> <ul style="list-style-type: none"> ► Wait until the mobile phone operational readiness symbol appears in the multifunction display.
 <p>Check Washer Fluid</p>	<p>The washer fluid level in the washer fluid reservoir has dropped below the minimum.</p> <ul style="list-style-type: none"> ► Add washer fluid (► page 239).

SmartKey

Display messages	Possible causes/consequences and ► Solutions
 <p>Key Does Not Belong to Vehicle</p>	<p>You have put the wrong SmartKey in the ignition lock.</p> <ul style="list-style-type: none"> ► Use the correct SmartKey.
 <p>Take Your Key from Ignition</p>	<p>The SmartKey is in the ignition lock.</p> <ul style="list-style-type: none"> ► Remove the SmartKey.
 <p>Obtain a New Key</p>	<p>The SmartKey needs to be replaced.</p> <ul style="list-style-type: none"> ► Visit a qualified specialist workshop.

Warning and indicator lamps in the instrument cluster

Overview of warning and indicator lamps



Low-beam headlamps (► page 84)



Turn signal (► page 88)



High-beam headlamps (► page 88)



Rear fog lamp (► page 86)



Seat belts (► page 204)











Brakes (► page 205)







(USA)
(Canada)

Brakes (yellow) (► page 205)







	ABS (▷ page 206)
	ESP® (▷ page 207)
	ESP® OFF (▷ page 207)
	Restraint system (▷ page 209)
	Check Engine (▷ page 210)
	Reserve fuel (▷ page 210)
	Coolant (▷ page 210)
	Distance warning signal (▷ page 212)
	Tire pressure monitor (▷ page 213)





Safety









Seat belts





Problem	Possible causes/consequences and ► Solutions
 After starting the engine, the red seat belt warning lamp lights up for six seconds.	The seat belt warning lamp reminds the driver and front passenger to fasten their seat belts. ► Fasten your seat belt (▷ page 38).
 After starting the engine, the red seat belt warning lamp lights up. In addition, a warning tone sounds for up to six seconds.	The driver's seat belt is not fastened. ► Fasten your seat belt (▷ page 38). The warning tone ceases.
 The red seat belt warning lamp lights up after the engine starts, as soon as the driver's or the front-passenger door is closed.	The driver or front passenger has not fastened their seat belt. ► Fasten your seat belt (▷ page 38). The warning lamp goes out. There are objects on the front-passenger seat. ► Remove the objects from the front-passenger seat and stow them in a secure place. The warning lamp goes out.
 The red seat belt warning lamp flashes and an intermittent audible warning sounds.	The driver or front passenger has not fastened their seat belt. The vehicle is being driven faster than 15 mph (25 km/h) or has briefly been driven faster than 15 mph (25 km/h). ► Fasten your seat belt (▷ page 38). The warning lamp goes out and the intermittent warning tone ceases. There are objects on the front-passenger seat. The vehicle is being driven faster than 15 mph (25 km/h) or has briefly been driven faster than 15 mph (25 km/h). ► Remove the objects from the front-passenger seat and stow them in a secure place. The warning lamp goes out and the intermittent warning tone ceases.





Safety systems





Problem	Possible causes/consequences and ► Solutions
<p> (USA only)  (Canada only) USA only: the red brake system warning lamp is lit while the engine is running. A warning tone also sounds. Canada only: the yellow brake system warning lamp is lit while the engine is running. A warning tone also sounds.</p>	<p> WARNING</p> <p>The brake boosting effect is malfunctioning and the braking characteristics may be affected. There is a risk of an accident.</p> <ul style="list-style-type: none"> ► Pull over and stop the vehicle safely as soon as possible, paying attention to road and traffic conditions. Do not continue driving under any circumstances. ► Secure the vehicle against rolling away (▷ page 130). ► Consult a qualified specialist workshop. ► Observe the additional display messages in the multifunction display.
<p> (USA only)  (Canada only) USA only: the red brake system warning lamp is lit while the engine is running. A warning tone also sounds. Canada only: the yellow brake system warning lamp is lit while the engine is running. A warning tone also sounds.</p>	<p>There is not enough brake fluid in the brake fluid reservoir.</p> <p> WARNING</p> <p>The braking effect may be impaired. There is a risk of an accident.</p> <ul style="list-style-type: none"> ► Pull over and stop the vehicle safely as soon as possible, paying attention to road and traffic conditions. Do not continue driving under any circumstances. ► Secure the vehicle against rolling away (▷ page 130). ► Do not add brake fluid. Adding more will not correct the malfunction. ► Consult a qualified specialist workshop. ► Observe the additional display messages in the multifunction display.



Problem	Possible causes/consequences and ► Solutions
 <p>The yellow ABS warning lamp is lit while the engine is running.</p>	<p>ABS (Anti-lock Braking System) is deactivated due to a malfunction. Other driving systems and driving safety systems may also be malfunctioning.</p> <p> WARNING</p> <p>The brake system continues to function normally, but without the functions listed above. The wheels could therefore lock if you brake hard, for example.</p> <p>The steerability and braking characteristics may be severely affected. The braking distance in an emergency braking situation can increase. If ESP® is not operational, ESP® is unable to stabilize the vehicle. There is an increased risk of skidding and an accident.</p> <ul style="list-style-type: none"> ► Observe the additional display messages in the multifunction display. ► Drive on carefully. ► Visit a qualified specialist workshop. <p>If the ABS control unit is faulty, there is also a possibility that other systems, such as the navigation system or the automatic transmission, will not be available.</p>
 <p>The yellow ABS warning lamp is lit while the engine is running.</p>	<p>ABS is temporarily unavailable. BAS, ESP®, EBD (electronic brake force distribution), the HOLD function, hill start assist, ESP® trailer stabilization and the adaptive brake lights, for example, have also been deactivated.</p> <p>Possible causes are:</p> <ul style="list-style-type: none"> • self-diagnosis is not yet complete. • the on-board voltage may be insufficient. <p> WARNING</p> <p>The brake system continues to function normally, but without the functions listed above. The wheels could therefore lock if you brake hard, for example.</p> <p>The steerability and braking characteristics may be severely affected. The braking distance in an emergency braking situation can increase. If ESP® is not operational, ESP® is unable to stabilize the vehicle. There is a risk of an accident.</p> <ul style="list-style-type: none"> ► Carefully drive a suitable distance, making slight steering movements at a speed above 12 mph (20 km/h). The functions mentioned above are available again when the warning lamp goes out. <p>If the warning lamp is still on:</p> <ul style="list-style-type: none"> ► Observe the additional display messages in the multifunction display. ► Drive on carefully. ► Visit a qualified specialist workshop.

Problem	Possible causes/consequences and ► Solutions
 <p>The yellow ABS warning lamp is lit while the engine is running. A warning tone also sounds.</p>	<p>EBD is malfunctioning. Therefore, ABS, BAS, ESP[®], the HOLD function, hill start assist, adaptive brake lights and ESP[®] trailer stabilization, for example, are also unavailable.</p> <p> WARNING</p> <p>The brake system continues to function normally, but without the functions listed above. The wheels could therefore lock if you brake hard, for example.</p> <p>The steerability and braking characteristics may be severely affected. The braking distance in an emergency braking situation can increase. If ESP[®] is not operational, ESP[®] is unable to stabilize the vehicle. There is an increased risk of skidding and an accident.</p> <ul style="list-style-type: none"> ► Observe the additional display messages in the multifunction display. ► Drive on carefully. ► Visit a qualified specialist workshop.
 <p>The yellow ABS warning lamp is lit while the engine is running.</p>	<p>You have engaged the differential locks. ABS is deactivated.</p> <ul style="list-style-type: none"> ► Disengage the differential locks. Subsequently ABS is reactivated.
<p> (USA only)</p> <p> (Canada only)</p> <p> </p> <p>The yellow brake warning lamp, the yellow ESP[®] warning lamp and the yellow ABS warning lamp are lit while the engine is running.</p>	<p>ABS and ESP[®] are malfunctioning. BAS, EBD, the HOLD function, hill start assist, the adaptive brake lights and ESP[®] trailer stabilization, for example, are therefore unavailable.</p> <p> WARNING</p> <p>The brake system continues to function normally, but without the functions listed above. The front and rear wheels could therefore lock if you brake hard, for example.</p> <p>The steerability and braking characteristics may be severely affected. The braking distance in an emergency braking situation can increase. If ESP[®] is not operational, ESP[®] is unable to stabilize the vehicle. There is an increased risk of skidding and an accident.</p> <ul style="list-style-type: none"> ► Observe the additional display messages in the multifunction display. ► Drive on carefully. ► Visit a qualified specialist workshop.

Problem	Possible causes/consequences and ► Solutions
 <p>The yellow ESP[®] warning lamp flashes while the vehicle is in motion.</p>	<p>ESP[®] or traction control has intervened because there is a risk of skidding or at least one wheel has started to spin. Cruise control or DISTRONIC PLUS is deactivated.</p> <ul style="list-style-type: none"> ► When pulling away, only depress the accelerator pedal as far as necessary. ► Ease off the accelerator pedal while the vehicle is in motion. ► Adapt your driving style to suit the road and weather conditions. ► Do not deactivate ESP[®]. <p>For exceptions, see: (► page 57).</p>
 <p>The yellow ESP[®] OFF warning lamp is lit while the engine is running.</p>	<p>ESP[®] is deactivated.</p> <p> WARNING</p> <p>If ESP[®] is switched off, ESP[®] is unable to stabilize the vehicle. There is an increased risk of skidding and an accident.</p> <ul style="list-style-type: none"> ► Reactivate ESP[®]. <p>For exceptions, see: (► page 57).</p> <ul style="list-style-type: none"> ► Adapt your driving style to suit the road and weather conditions. <p>If ESP[®] cannot be activated:</p> <ul style="list-style-type: none"> ► Have ESP[®] checked at a qualified specialist workshop.
 <p>The yellow ESP[®] and ESP[®] OFF warning lamps are lit while the engine is running.</p>	<p>ESP[®], BAS, the HOLD function, hill start assist, the adaptive brake lights and ESP[®] trailer stabilization are unavailable due to a malfunction.</p> <p> WARNING</p> <p>The brake system continues to function normally, but without the functions listed above. The braking distance in an emergency braking situation can thus increase.</p> <p>If ESP[®] is not operational, ESP[®] is unable to stabilize the vehicle. There is an increased risk of skidding and an accident.</p> <ul style="list-style-type: none"> ► Observe the additional display messages in the multifunction display. ► Drive on carefully. ► Visit a qualified specialist workshop.



Problem	Possible causes/consequences and ► Solutions
 <p>The yellow ESP® and ESP® OFF warning lamps are lit while the engine is running.</p>	<p>ESP®, BAS, the HOLD function, hill start assist and ESP® trailer stabilization are temporarily unavailable. BAS and the adaptive brake lights may also have failed. Self-diagnosis is not yet complete.</p> <p> WARNING</p> <p>The brake system continues to function normally, but without the functions listed above. The braking distance in an emergency braking situation can thus increase. If ESP® is not operational, ESP® is unable to stabilize the vehicle. There is an increased risk of skidding and an accident.</p> <p>► Carefully drive a suitable distance, making slight steering movements at a speed above 12 mph (20 km/h). The functions mentioned above are available again when the warning lamp goes out.</p> <p>If the warning lamp is still on:</p> <p>► Observe the additional display messages in the multifunction display. ► Drive on carefully. ► Visit a qualified specialist workshop.</p>
 <p>The yellow ESP® OFF warning lamp is lit while the engine is running.</p>	<p>The differential lock is engaged. ABS, ESP®, 4ETS and BAS have been deactivated.</p> <p>► Disengage the differential lock. ESP®, 4ETS and BAS are subsequently reactivated.</p> <p>► Observe the additional display messages in the multifunction display.</p>
<p>(Canada only) (USA only)</p> <p>The red parking brake warning lamp comes on while the vehicle is moving. A warning tone also sounds.</p>	<p>You are driving with the parking brake applied.</p> <p>► Release the parking brake. The warning lamp goes out and the warning tone ceases.</p>
 <p>The red restraint system warning lamp is lit while the engine is running.</p>	<p>The restraint system is faulty.</p> <p> WARNING</p> <p>The air bags or Emergency Tensioning Devices may either be triggered unintentionally or, in the event of an accident, may not be triggered. There is an increased risk of injury.</p> <p>► Drive on carefully. ► Have the restraint system checked at a qualified specialist workshop immediately.</p> <p>For further information about the restraint system, see (► page 34).</p>





Engine	
Problem	Possible causes/consequences and ► Solutions
 <p>The yellow Check Engine warning lamp lights up while the engine is running.</p>	<p>There may be a malfunction, for example:</p> <ul style="list-style-type: none"> • in the engine management • in the fuel injection system • in the exhaust system • in the ignition system • in the fuel system <p>The emission limit values may be exceeded and the engine may be in emergency mode.</p> <p>► Have the vehicle checked as soon as possible at a qualified specialist workshop.</p> <p>i In some states, you must immediately visit a qualified specialist workshop as soon as the yellow Check Engine warning lamp lights up. This is due to the legal requirements in effect in these states. If in doubt, check whether such legal regulations apply in the state in which you are currently driving.</p>
 <p>The yellow reserve fuel warning lamp lights up while the engine is running.</p>	<p>The fuel level has dropped into the reserve range.</p> <p>► Refuel at the nearest gas station.</p>
 <p>The yellow reserve fuel warning lamp flashes while the vehicle is in motion.</p> <p>In addition, the  Check Engine warning lamp may light up.</p>	<p>The fuel system pressure is too low. The fuel filler cap is not closed correctly or the fuel system is leaking.</p> <p>► Check that the fuel filler cap is correctly closed.</p> <p>► If the fuel filler cap is not correctly closed: close the fuel filler cap.</p> <p>► If the fuel filler cap is closed: visit a qualified specialist workshop.</p>
 <p>The red coolant warning lamp lights up while the engine is running and the coolant temperature gage is at the start of the scale.</p>	<p>The temperature sensor for the coolant temperature gage is defective. The coolant temperature is no longer being monitored. There is a risk of engine damage if the coolant temperature is too high.</p> <p>► Pull over and stop the vehicle safely and switch off the engine, paying attention to road and traffic conditions. Do not continue driving under any circumstances.</p> <p>► Apply the parking brake.</p> <p>► Consult a qualified specialist workshop.</p>

Problem	Possible causes/consequences and ► Solutions
 <p>The red coolant warning lamp comes on while the engine is running.</p>	<p>The coolant level is too low.</p> <p>! Avoid making long journeys with too little coolant in the engine cooling system. The engine will otherwise be damaged.</p> <p>If the coolant level is correct, the airflow to the engine radiator may be blocked or the electric engine radiator fan may be malfunctioning.</p> <p>The coolant is too hot and the engine is no longer being cooled sufficiently.</p> <ul style="list-style-type: none"> ► Observe the additional display messages in the multifunction display. ► Pull over and stop the vehicle safely and switch off the engine, paying attention to road and traffic conditions. ► Apply the parking brake. ► Leave the vehicle and keep a safe distance from the vehicle until the engine has cooled down. ► Check the coolant level and add coolant, observing the warning notes (► page 238). ► If you need to add coolant more often than usual, have the engine coolant system checked. ► Make sure that the air supply to the engine radiator is not blocked, e.g. by snow, slush or ice. ► Do not start the engine again until the coolant temperature is below 248 °F (120 °C). Otherwise, the engine could be damaged. ► Drive to the nearest qualified specialist workshop. ► Avoid subjecting the engine to heavy loads, e.g. driving in mountainous terrain, and stop-start driving.
 <p>The red coolant warning lamp comes on while the engine is running. A warning tone also sounds.</p>	<p>The coolant temperature has exceeded 248 °F (120 °C). The airflow to the engine radiator may be blocked or the coolant level may be too low.</p> <p>▲ WARNING</p> <p>The engine is not being cooled sufficiently and may be damaged. Do not drive when your engine is overheated. This can cause some fluids which may have leaked into the engine compartment to catch fire.</p> <p>Steam from the overheated engine can also cause serious burns which can occur just by opening the hood.</p> <p>There is a risk of injury.</p> <ul style="list-style-type: none"> ► Observe the additional display messages in the multifunction display. ► Pull over and stop the vehicle safely and switch off the engine, paying attention to road and traffic conditions. ► Secure the vehicle against rolling away (► page 130). ► Leave the vehicle and keep a safe distance from the vehicle until the engine has cooled down. ► Check the coolant level and add coolant, observing the warning notes (► page 238).

Problem	Possible causes/consequences and ► Solutions
	<ul style="list-style-type: none"> ► If you need to add coolant more often than usual, have the engine coolant system checked. ► Make sure that the air supply to the engine radiator is not blocked, e.g. by snow, slush or ice. ► At coolant temperatures below 248 °F (120 °C), drive to the nearest qualified specialist workshop. ► Avoid subjecting the engine to heavy loads, e.g. driving in mountainous terrain, and stop-start driving.

Driving systems

Problem	Possible causes/consequences and ► Solutions
 <p>The red distance warning lamp lights up while the vehicle is in motion.</p>	<p>The distance to the vehicle in front is too small for the speed selected.</p> <ul style="list-style-type: none"> ► Increase the distance.
 <p>The red distance warning lamp lights up while the vehicle is in motion. A warning tone also sounds.</p>	<p>You are approaching a vehicle or a stationary obstacle in your line of travel at too high a speed.</p> <ul style="list-style-type: none"> ► Be prepared to brake immediately. ► Pay careful attention to the traffic situation. You may have to brake or take evasive action. <p>Further information on DISTRONIC PLUS (▷ page 147).</p>

Tires	
Problem	Possible causes/consequences and ► Solutions
 USA only: The yellow tire pressure monitor warning lamp (pressure loss/malfunction) is lit. Canada only: The yellow tire pressure monitor warning lamp (pressure loss) is lit.	<p>The tire pressure monitor has detected a loss of pressure in at least one of the tires.</p> <p> WARNING</p> <p>Tire pressures that are too low pose the following hazards:</p> <ul style="list-style-type: none"> • they may burst, especially as the load and vehicle speed increase. • they may wear excessively and/or unevenly, which may greatly impair tire traction. • the driving characteristics, as well as steering and braking, may be greatly impaired. <p>There is a risk of an accident.</p> <ul style="list-style-type: none"> ► Stop the vehicle without making any sudden steering or braking maneuvers. Pay attention to the traffic conditions as you do so. ► Secure the vehicle against rolling away (► page 130). ► Observe the additional display messages in the multifunction display. ► If there is a flat tire, inspect the tires (► page 250). ► Check the tire pressure (► page 268). ► If necessary, correct the tire pressure.
 USA only: The yellow tire pressure monitor warning lamp (pressure loss/malfunction) flashes for approximately one minute and then remains lit.	<p>The tire pressure monitor is faulty.</p> <p> WARNING</p> <p>The system is possibly unable to recognize or register low tire pressure.</p> <p>There is a risk of an accident.</p> <ul style="list-style-type: none"> ► Observe the additional display messages in the multifunction display. ► Visit a qualified specialist workshop.

Useful information

- i** This Operator's Manual describes all models and all standard and optional equipment of your vehicle available at the time of publication of the Operator's Manual. Country-specific differences are possible. Please note that your vehicle may not be equipped with all features described. This also applies to safety-related systems and functions.
- i** Read the information on qualified specialist workshops: (▷ page 23).

Loading guidelines

⚠ WARNING

If objects, luggage or loads are not secured or not secured sufficiently, they could slip, tip over or be flung around and thereby hit vehicle occupants. There is a risk of injury, particularly in the event of sudden braking or a sudden change in direction.

Always store objects so that they cannot be flung around. Secure objects, luggage or loads against slipping or tipping before the journey.

⚠ WARNING

If you distribute the load unevenly in the vehicle, the handling as well as the steering and braking characteristics are severely affected. There is a risk of an accident.

Distribute the load evenly in the vehicle. Secure the load to prevent it from slipping.

⚠ WARNING

The exhaust tail pipe and tail pipe trim can become very hot. If you come into contact with these parts of the vehicle, you could burn yourself. There is a risk of injury.

Always be particularly careful around the exhaust tail pipe and the tail pipe trim. Allow these components to cool down before touching them.

⚠ WARNING

Combustion engines emit poisonous exhaust gases such as carbon monoxide. If the rear door is open when the engine is running, particularly if the vehicle is moving, exhaust fumes could enter the passenger compartment. There is a risk of poisoning.

Turn off the engine before opening the rear door. Never drive with the rear door open.



Driving, braking and steering characteristics change depending on:

- type of load
- weight
- the center of gravity of the load

You should therefore load your vehicle as shown in the illustrations.

The gross vehicle weight (GVW) is the vehicle weight including fuel, vehicle tool kit, spare wheel, accessories installed, vehicle occupants and luggage/load.

Do not exceed the load limit or permitted gross vehicle weight rating (GVWR) for your vehicle. The gross load limit and the GVWR are specified on the vehicle identification plate on the B-pillar of the driver's door (▷ page 288).

Furthermore, the load must be distributed in such a way that the weight on each axle never exceeds the gross axle weight rating (GAWR) for the front and rear axles. The specifications for GVWR and GAWR are on the vehicle identification plate on the B-pillar of the driver's door (▷ page 288).

Further information can be found in the "Loading the vehicle" section (▷ page 271).

Observe the following notes when transporting a load:

- Position heavy loads as far forwards as possible and as low down in the cargo compartment as possible.
- ❗ Transport loads when possible in the cargo compartment. You should only use the cargo compartment enlargement if the load does not fit in the cargo compartment.
- Always place the load against the backrests of the front seats or rear seats.
- Use the cargo tie-down rings and the parcel nets to transport loads and luggage.
- Use cargo tie-down rings and fastening materials appropriate for the weight and size of the load.



If the rear bench seat is not occupied:

- ▶ Insert the belt tongue on the outer seat belts into the buckle of opposite seat belt (1).
- ▶ Secure the load with sufficiently strong and wear-resistant tie downs.
- ▶ Pad sharp edges for protection.

Stowage areas

Stowage spaces

Important safety notes

⚠ WARNING

If objects in the passenger compartment are stowed incorrectly, they can slide or be thrown around and hit vehicle occupants. There is a risk of injury, particularly in the event of sudden braking or a sudden change in direction.

- Always stow objects so that they cannot be thrown around in such situations.
- Always make sure that objects do not protrude from stowage spaces, parcel nets or stowage nets.
- Close the lockable stowage spaces while driving.
- Stow and secure objects that are heavy, hard, pointy, sharp-edged, fragile or too large in the cargo compartment.

Observe the loading guidelines (▷ page 214).

Stowage compartments in the front

Glove box



- ▶ **To open:** pull handle (1) and open glove box flap (2).
- ▶ **To close:** fold glove box flap (2) upwards until it engages.

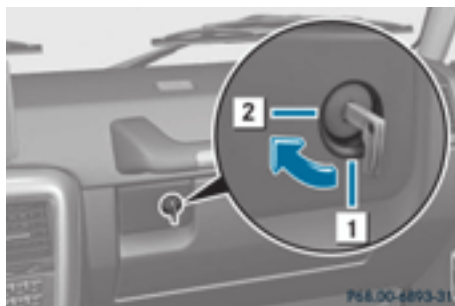

- 1 Glove box unlocked
- 2 Glove box locked

- ▶ **To lock:** insert the mechanical key into the lock (▷ page 61) and turn it 90° clockwise to position **2**.
- ▶ **To unlock:** insert the mechanical key into the lock (▷ page 61) and turn it 90° counter-clockwise to position **1**.

i The glove box can only be locked and unlocked using the mechanical key.

Door stowage compartment

There is an additional compartment located on the driver's door paneling, which can be used to store a mini tablet PC, for example.

Stowage compartment/telephone compartment under the armrest/in the center console

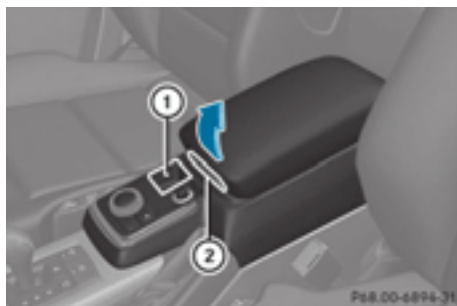

- ① Small stowage compartment
- ② Release button for the armrest

Stowage compartment/telephone compartment under the armrest

- ▶ **To open:** press release button **2**.
- ▶ Fold up armrest.
- i** In the stowage compartment, there is a stowage tray.
- ▶ **To close:** fold the armrest down. The armrest engages audibly.

Stowage space in the rear

Storage pockets

⚠ WARNING

Storage bags are intended for storing light-weight items only.

Heavy objects, objects with sharp edges or fragile objects may not be transported in the

storage bag. In an accident, during hard braking, or sudden maneuvers, they could be thrown around inside the vehicle and cause injury to vehicle occupants.

Storage bags cannot protect transported goods in the event of an accident.

The stowage pockets are located on the rear side of the front seats.

Stowage nets

The stowage net is in the front-passenger footwell.

Observe the loading guidelines (▷ page 214) and the safety notes regarding stowage spaces (▷ page 215).

Cargo compartment enlargement

Important safety notes

⚠ WARNING

If the rear bench seat/rear seat and seat backrest are not engaged they could fold forwards, e.g. when braking suddenly or in the event of an accident.

- The vehicle occupant would thereby be pushed into the seat belt by the rear bench seat/rear seat or by the seat backrest. The seat belt can no longer offer the intended level of protection and could even cause injuries.
- Objects or loads in the trunk/cargo compartment cannot be restrained by the seat backrest.

There is an increased risk of injury.

Before every trip, make sure that the seat backrests and the rear bench seat/rear seat are engaged.

⚠ WARNING

Combustion engines emit poisonous exhaust gases such as carbon monoxide. If the rear door is open when the engine is running, particularly if the vehicle is moving, exhaust

fumes could enter the passenger compartment. There is a risk of poisoning.

Turn off the engine before opening the rear door. Never drive with the rear door open.

- ❗ Ensure that you remove all containers from the cup holder in the rear before folding the seat backrest and the seat cushion of the rear bench seat forwards.

Observe the loading guidelines (▷ page 214).

The rear bench seat is split symmetrically.

The left-hand and right-hand rear bench seats can be folded forward to increase the capacity of the rear compartment. The following changes are possible:

- fold the seat backrests forward
- fold the rear bench seat back fully

Folding the seat backrest forward

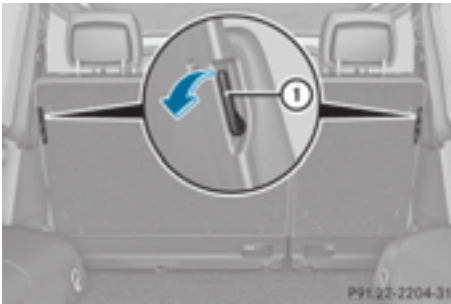

To fold forward the seat backrests, proceed as follows:

- ▶ Open the rear doors.
This allows you better access to release lever ①.
- ▶ Remove the center head restraint (▷ page 75).
- ▶ Pull catch ① in the direction of the arrow.
The corresponding rear seat backrest is not engaged.
- ▶ Fold the backrest forwards.
The rear seat backrest engages audibly.

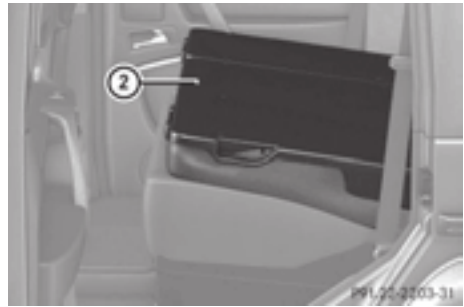

- ② Backrest folded forward

Folding the seat backrest back

- ❗ Make sure that the seat belt does not become trapped when folding the rear seat backrest back. Otherwise, it could be damaged.

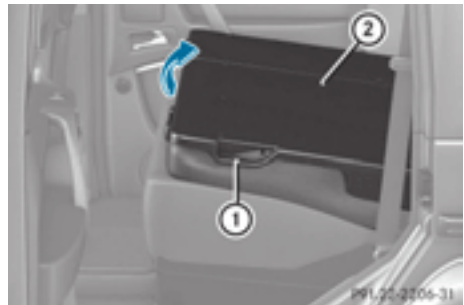

- ▶ Pull release lever ①.
The corresponding seat backrest is released.
- ▶ Fold backrest ② backwards in the direction of the arrow.
The seat catch engages audibly.
- ▶ Install the head restraint (▷ page 75).

Rear bench seat

Folding the rear bench seat forward

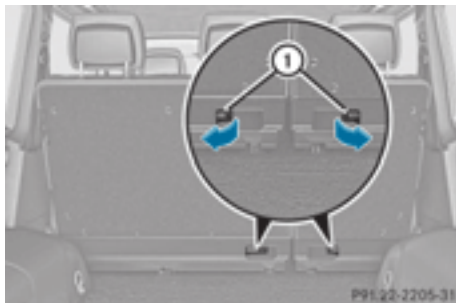

- ▶ Fold rear seat backrest (▷ page 217) forwards.
- ▶ Pull catch ① in the direction of the arrow. The corresponding rear bench seat is released.
- ▶ Fold rear bench seat ② forwards.



② Rear bench seat folded forward

Folding the rear bench seat into an upright position

WARNING

If the rear bench seat/rear seat and seat backrest are not engaged they could fold forwards, e.g. when braking suddenly or in the event of an accident.

- The vehicle occupant would thereby be pushed into the seat belt by the rear bench seat/rear seat or by the seat backrest. The seat belt can no longer offer the intended

level of protection and could even cause injuries.

- Objects or loads in the trunk/cargo compartment cannot be restrained by the seat backrest.

There is an increased risk of injury.

Before every trip, make sure that the seat backrests and the rear bench seat/rear seat are engaged.

- ▶ Fold the rear bench seat back. The seat catch engages audibly.
- ▶ Fold the backrest backwards (▷ page 217).
- ▶ Install the head restraints (▷ page 75).

Securing cargo

Important safety notes

Distribute the load on the cargo tie-down rings evenly.

Do not tamper with or repair cargo tie-down points, cargo tie-down rings or tie downs. Have maintenance work as well as modifications, installations and conversions carried out at a qualified specialist workshop (▷ page 23).

Observe the following notes on securing loads:

- Secure the load using the cargo tie-down rings.
- Do not use elastic straps or nets to secure a load, as these are only intended as an anti-slip protection for light loads.
- Do not route tie-downs across sharp edges or corners.
- Pad sharp edges for protection.
- Only use tie downs that have been checked in accordance with applicable standards, e.g. lashing nets or lashing straps.
- Fill the spaces between the load and the cargo compartment walls and the wheel housing in a form-locking way. Only use dimensionally stable transportation aids for this, such as chocks, wooden fixings or padding.

Cargo tie-down rings in the cargo compartment

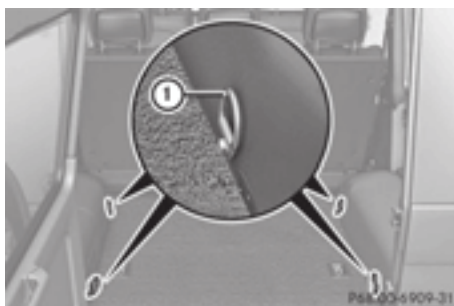

There are four cargo tie-down rings (1) in the cargo compartment mounted at the sides.

Cargo compartment cover

Important safety notes

WARNING

On its own, the cargo compartment cover cannot secure or restrain heavy objects, items of luggage and heavy loads. You could be hit by an unsecured load during sudden changes in direction, braking or in the event of an accident. There is an increased risk of injury or even fatal injury.

Always store objects so that they cannot be flung around. Secure objects, luggage or loads against slipping or tipping over, e.g. by using tie downs, even if you are using the cargo compartment cover.

- !** When loading the vehicle, make sure that you do not stack the load in the cargo compartment higher than the lower edge of the side windows. Do not place heavy objects on top of the cargo compartment cover.

The cargo compartment cover is located behind the rear bench seat backrest.

Opening and closing the cargo compartment cover



- ▶ **To open:** pull cargo compartment cover (1) back and clip it into the retainers on the left and right of the rear door.
- ▶ **To close:** unclip cargo compartment cover (1) and guide it forwards until it is completely rolled up.

Installing/removing the cargo compartment cover



- ▶ **To remove:** make sure that cargo compartment cover (2) is rolled up.
- ▶ Slide catches (1) on the left-hand and right-hand sides of cargo compartment cover (2) towards the center of the vehicle.
- ▶ Swing cargo compartment cover (2) up and out.
- ▶ **To install:** slide catches (1) towards the center of the vehicle.
- ▶ Insert cargo compartment cover (2) into the recesses in the side trim.

P68.50-2570-31

- ▶ Push down the right-hand and left-hand sides of cargo compartment cover ② until it engages.
- ▶ Slide catches ① in the direction of the side trim.

Roof carrier

WARNING

When you load the roof, the center of gravity of the vehicle rises and the driving characteristics change. If you exceed the maximum roof load, the driving characteristics, as well as steering and braking, will be greatly impaired. There is a risk of an accident.

Never exceed the maximum roof load and adjust your driving style.

The roof is not suited for transporting loads. Do not use the roof rails or other accessories which are mounted on the roof.

Features

Cup holder

Important safety notes

WARNING

If you transport objects in the vehicle interior and these are not adequately secured, they could slip or be flung around and thereby strike vehicle occupants. In addition, cup holders, open stowage spaces and mobile phone brackets may not always be able to hold the objects placed in them in the event of an accident. There is a risk of injury, particularly in the event of sharp braking or sudden changes of direction.

- Always stow objects in such a way that they cannot be tossed about in these or similar situations.
- Always make sure that objects do not protrude out of the stowage spaces, luggage nets or stowage nets.

- Ensure that closable stowage spaces are shut before beginning your journey.
- Always stow and secure heavy, hard, pointed, sharp-edged, fragile or large objects in the cargo compartment.

 Only use the cup holders for containers of the right size and which have lids. The drinks could otherwise spill.

Observe the loading guidelines (▷ page 214).

Cup holder on the center console



- ▶ Fold cup holder ① all the way up.

Cup holders in the rear compartment

 Ensure that you remove all containers from the cup holder in the rear before folding the seat backrest and the seat cushion of the rear bench seat forwards.



- ① Cup holder

Sun visors

Overview

⚠ WARNING

If the mirror cover of the vanity mirror is folded up when the vehicle is in motion, you could be blinded by incident light. There is a risk of an accident.

Always keep the mirror cover folded down while driving.

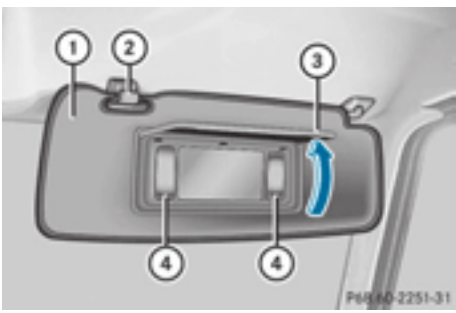

- ① Sun visor
- ② Bracket
- ③ Mirror cover
- ④ Mirror light

Vanity mirror in the sun visor

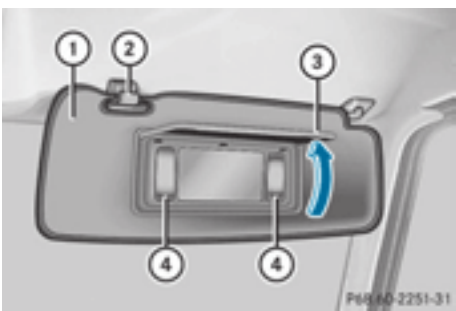

- ① Sun visor
- ② Bracket
- ③ Mirror cover
- ④ Mirror light

Mirror lights ④ will only function if sun visor ① is clipped into bracket ②.

- ▶ Fold down sun visor ①.
- ▶ Fold up mirror cover ③.
- ▶ Mirror lights ④ are switched on automatically.

Glare from the side

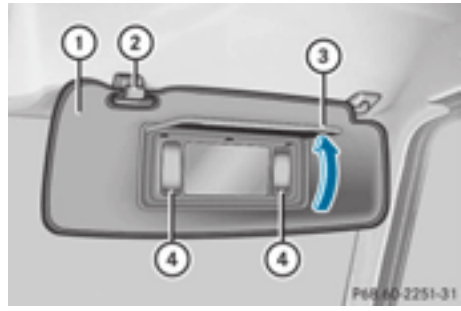

- ① Sun visor
- ② Bracket
- ③ Mirror cover
- ④ Mirror light

- ▶ Fold down sun visor ①.
- ▶ Pull sun visor ① from bracket ②.
- ▶ Swing sun visor ① to the side.

Storage compartment/ashtray

Storage compartment/ashtray in the center console

⚠ WARNING

If you engage transmission position **D** when removing the ashtray insert, the vehicle can roll away. There is a risk of an accident.

Always switch off the engine first and safeguard the vehicle against rolling away by applying the parking brake.

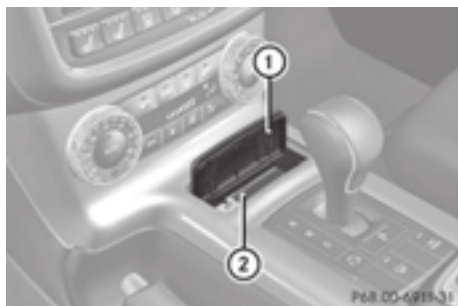

① Cover

② Insert

i On new vehicles, insert ② is stored in the glove box. Install the insert before using the ashtray.

- ▶ **To open:** press cover ① and then release it. The ashtray opens.
- ▶ **To remove the insert:** make sure that the engine is switched off and that the parking brake has been applied to secure the vehicle against rolling away.
- ▶ Move the selector lever to **N**.
- ▶ Press down cover ①. Insert ② is released.
- ▶ Pull insert ② upwards and remove it.
- ▶ **To install the insert:** install insert ② from above.
- ▶ Push insert ② down. Insert ② audibly engages.
- ▶ **To close:** close cover ① fully.

i The ashtray is lit up if the low-beam headlights are on.

Ashtray in the rear compartment



- ▶ **To open:** fold cover ② out in the direction of the arrow.
- ▶ **To remove the insert:** press retaining lug ① and pull insert ③ upwards and out.
- ▶ **To install the insert:** install insert ③ from above.
- ▶ **To close:** close cover ② fully.

Cigarette lighter

⚠ WARNING

You can burn yourself if you touch the hot heating element or the socket of the cigarette lighter.

In addition, flammable materials can ignite if:

- the hot cigarette lighter falls
- a child holds the hot cigarette lighter to objects, for example

There is a risk of fire and injury.

Always hold the cigarette lighter by the knob. Always make sure that the cigarette lighter is out of reach of children. Never leave children unsupervised in the vehicle.

! The 12 V socket in the cigarette lighter can be used for accessories (up to a maximum of 180 W), as long as they have the standard socket type for cigarette lighters.

Note that the socket in the cigarette lighter can be damaged when connecting accessories, for example by:

- frequent insertion and removal
- sockets that do not fit correctly

A damaged socket can cause the cigarette lighter to stop working.



- ▶ Press in cigarette lighter ①.
Cigarette lighter ① will pop out automatically when the heating element is red-hot.

12 V sockets

General notes

- ! If you are simultaneously using all three sockets in the vehicle, make sure that you do not exceed the maximum current draw of 45 A. Otherwise, you will overload the fuses.

The sockets can be used for accessories with a maximum current draw of 180 W (15 A) each, e.g. bulbs or chargers for mobile phones.

If you use the sockets for long periods when the engine is switched off, the battery may discharge.

- ▶ Turn the SmartKey to position **2** in the ignition lock.

Socket in the front-passenger footwell



- ▶ Lift up the cover of the socket.
- i The cigarette lighter socket can be also used (> page 222). This is the case even if the SmartKey has been removed from the ignition lock.

Socket in the rear compartment



The socket is located on the center console in the rear compartment.

- ▶ Lift up the cover of the socket.

Socket in the cargo compartment



The socket is located in the cargo compartment on the left-hand side, when viewed in the direction of travel, next to the rear door.

- ▶ Lift up the cover of the socket.

115 V socket

⚠ WARNING

The 115 V AC power socket operates on high voltage. Use the 115 V AC power socket in the vehicle with the same caution and care that you would take with power sockets at home. Keep fluids away from the 115 V AC power socket. Do not use liquids or sharp tools to clean the power socket. Keep the cover of the 115 V AC power socket closed when not in use. Otherwise, you could suffer an electric shock and be seriously or even fatally injured.

⚠ WARNING

Any device that you connect must have a suitable plug and meet U.S. standards. Never pull at a cable to disconnect a plug from a 115 V AC power socket. Never use a damaged connection cable. The 115 V AC power socket must never be connected to another 115 V AC power source. Do not use a converter with an earthed plug for the 115 V AC power socket. This could cause serious injury to you and/or other people.

⚠ WARNING

If the 115 V AC power socket is damaged or pulled out of the trim, do not use or touch the 115 V AC power socket. The use of a 115 V AC power socket that has been damaged or pulled out of the trim could cause serious injury to you or others.



115 V power socket ① provides an AC voltage of 115 V so that small electronic devices can be connected. These devices, such as games consoles, chargers and laptops, should not consume more than a maximum of 150 W altogether.

Requirements for operation of these devices:

- the 12 V sockets in the rear compartment and the cargo compartment are operational (▷ page 223).
- the plug of the electronic device is plugged into 115 V power socket ①.
- the on-board power supply is within a permissible voltage range.
- the electronic device's maximum power output does not exceed 150 W.

- ▶ Open flap ③.
- ▶ Switch on the ignition.
- ▶ Insert the plug of the electronic device into 115 V power socket ①. Indicator lamp ② lights up. If indicator lamp ② does not light up, please read the section on malfunctions.
- ▶ **To turn off:** disconnect the plug from 115 V power socket ①. Ensure that you do not pull on the cord.
- ▶ Close flap ③.

Possible causes of malfunctions:

- the on-board power supply is not within a permissible voltage range.
- the temperature of the DC/AC converter is temporarily too high.
- some small electronic devices have a constant nominal power of less than 150 W, but a very high switch-on current. In that case, there is a possibility that these devices will not function properly as 115 V socket ① is not able to provide a high enough current.
- ▶ If indicator lamp ② still does not light up, contact a qualified specialist workshop.

mbrace**Important safety notes**

- ⚠ You must have a license agreement to activate the mbrace service. Ensure that your system is activated and ready for use, and press the  MB Info call button to register. If one of these steps is not carried out, it may not be possible to activate the system. If you have questions about the activation, contact one of the following telephone hot-lines:

- **USA:** Response Center at 1-888-990-9007
- **Canada:** Customer Service at 1-888-923-8367

USA only: shortly after successfully registering with the mbrace service a user ID and password will be sent to you by post. You can use this password to log onto the mbrace area under "Owners Online" at <http://www.mbusa.com>.

The mbrace system is available if:

- it has been activated and is operational. Activation requires an available mobile phone network, a valid SIM card and a subscription to a security service.
- the battery is sufficiently charged.
- the corresponding mobile phone network is available for transmitting data to the Customer Center.

i Determining the location of the vehicle on a map is only possible if there is sufficient GPS reception and the vehicle position can be forwarded to the Customer Center.

The mbrace system

To adjust the volume during an mbrace call, proceed as follows:

▶ Press the  or  button on the multifunction steering wheel.

or

▶ Use the COMAND volume control.

The mbrace system provides three different services:





- Automatic and manual emergency call
- Roadside Assistance call
- MB Info call

USA only: you can find more information and a description of all available features under "Owners Online" at <http://www.mbUSA.com>.

System self-test

WARNING

A malfunction in the system has been detected if one of the following conditions occurs:

- the indicator lamp in the SOS button does not light up during the system self-diagnosis.
- the indicator lamp in the  Roadside Assistance button does not light up during the system self-diagnosis.
- the indicator lamp in the  information button does not light up during the system self-diagnosis.
- the indicator lamp in the SOS button,  Roadside Assistance button or  infor-

mation button continues to be lit red after the system self-diagnosis.

- the **Tele Aid inoperative** or **Tele Aid not activated** message appears on the multifunction display after the system self-diagnosis.

If a malfunction is indicated as outlined above, the system may not operate as expected. In the event of an emergency, assistance must be summoned by other means.

Have the system checked at the nearest authorized Mercedes-Benz Center or contact the following service hotlines:

- **USA:** Response Center at 1-888-990-9007
- **Canada:** Customer Service at 1-888-923-8367

After you have switched on the ignition, the system carries out a self-diagnosis.

Emergency call

Important safety notes

WARNING

If the indicator lamp in the SOS button is flashing continuously and there was no voice connection to the Response Center established, then the mbrace system could not initiate an emergency call (e.g. the relevant cellular phone network is not available).

The message **Call Failed** appears in the multifunction display for approximately 10 seconds.

Should this occur, assistance must be summoned by other means.

- i** You must have a license agreement to activate the mbrace service. Ensure that your system is activated and ready for use, and press the  MB Info call button to register. If one of these steps is not carried out, it may not be possible to activate the system.

If you have questions about the activation, contact one of the following telephone hot-lines:

- **USA:** Response Center at 1-888-990-9007
- **Canada:** Customer Service at 1-888-923-8367

An emergency call is dialed automatically if an air bag or Emergency Tensioning Device is triggered.

- ❗ An automatically dialed emergency call cannot be canceled.

An emergency call can also be initiated manually.

As soon as the emergency call has been initiated, the indicator lamp in the SOS button flashes. The **Connecting Call** message appears on the multifunction display. COMAND is muted.

Once the connection has been made, the **Call Connected** message appears in the multifunction display.

All important information on the emergency is provided, for example:

- current location of the vehicle (as determined by the GPS system)
- vehicle model
- vehicle color
- vehicle identification number

A short time after the emergency call is initiated, a voice connection is automatically established between the Response Center and the vehicle occupants. If the vehicle occupants are able to respond, the Response Center will attempt to obtain more detailed information on the emergency.

- ❗ If there is no response from the vehicle occupants, an ambulance is immediately sent to the vehicle.

Making an emergency call

⚠ WARNING

If you feel at any way in jeopardy when in the vehicle (e.g. smoke or fire in the vehicle, vehicle in a dangerous road location), please do not wait for voice contact after you have pressed the SOS button. Carefully leave the vehicle and move to a safe location. The

Response Center will automatically contact local emergency officials with the vehicle's approximate location if they receive an automatic SOS signal and cannot make voice contact with the vehicle occupants.



- ▶ **To initiate an emergency call manually:** press cover ① briefly to open.
- ▶ Press SOS button ② briefly. The indicator lamp in SOS button ② flashes until the emergency call is concluded.
- ▶ Wait for the voice connection with the Response Center.
- ▶ After the emergency call, close cover ①.

Roadside Assistance button



- ▶ Open the stowage compartment under the armrest (▷ page 216).
- ▶ Press Roadside Assistance button ① for more than two seconds. A call to a Mercedes-Benz Roadside Assistance Representative is initiated. Indicator lamp ② in Roadside Assistance button ① flashes while the call is active. The **Connecting Call** message appears in the multifunction display and COMAND is muted.

If a connection can be made, the **Call Connected** message appears in the multifunction display.

If a mobile phone network is available and there is sufficient GPS reception, the mbrace system transmits data to the Response Center, for example:

- current location of the vehicle
- vehicle identification number
- vehicle model
- vehicle color

i The COMAND display shows that an mbrace call is active. You can change to the navigation menu by pressing the NAVI button on COMAND during the call. Voice output is not available.

A voice connection is established between the Mercedes-Benz Roadside Assistance Representative and the vehicle occupants.

The Mercedes-Benz Roadside Assistance Representative either sends a qualified Mercedes-Benz technician or makes arrangements for your vehicle to be transported to the nearest authorized Mercedes-Benz Center. You may be charged for services such as repair work and/or towing. Further details are available in your mbrace manual.

► Describe the type of assistance needed.

i If the indicator lamp in Roadside Assistance button ① is flashing continuously and no voice connection with the Response center has been established, then the mbrace system has not been able to initiate a Roadside Assistance call (e.g. the relevant mobile phone network is not available). The **Call Failed** message appears in the multifunction display.

► **To end a call:** press the  button on the multifunction steering wheel.

or

► Press the corresponding COMAND button to end a phone call.

i Sign and drive services¹: you are not charged for services such as jump-starting, providing a few gallons of fuel for a fuel tank that has been run dry or changing a faulty tire with the vehicle's own spare wheel.

MB Info call button



► Open the stowage compartment under the armrest (► page 216).

► Press Roadside Assistance button ① for more than two seconds.

A call to a Mercedes-Benz Roadside Assistance Representative is initiated. Indicator lamp ② in Roadside Assistance button ① flashes while the call is active. The **Connecting Call** message appears in the multifunction display and COMAND is muted.

If a connection can be made, the **Call Connected** message appears in the multifunction display.

If a mobile phone network is available and there is sufficient GPS reception, the mbrace system transmits data to the Response Center, for example:

- current location of the vehicle
- vehicle identification number
- vehicle model
- vehicle color

i The COMAND display shows that an mbrace call is active. You can change to the navigation menu by pressing the NAVI button on COMAND during the call. Voice output is not available.

A voice connection between the Response Center and the vehicle occupants is established. You can obtain information on how to operate your vehicle's systems, on the location of the nearest authorized Mercedes-Benz Center, and on further products and services offered by Mercedes-Benz USA.

¹ USA only.

You can find further information on the mbrace system at <http://www.mbusa.com>² Log in under "Owners Online".

i If the indicator lamp in MB Info call button ① is flashing continuously and no voice connection with the Response center has been established, then the mbrace system has not been able to initiate an MB Info call (e.g. the relevant mobile phone network is not available). The **Call Failed** message appears in the multifunction display.

► **To end a call:** press the  button on the multifunction steering wheel.

or

► Press the corresponding COMAND button to end a phone call.

Call priority

When service calls are active, e.g. Roadside Assistance or MB Info calls, an emergency call can still be initiated. In this case, an emergency call will take priority and override all other active calls.

The indicator lamp of the respective button flashes until the call is ended. An emergency call can only be terminated by the Response Center. All other calls can be ended by pressing the  button on the multifunction steering wheel or the corresponding COMAND button for ending a telephone call.

i When an mbrace call is initiated, COMAND is muted. The mobile phone is no longer connected to COMAND.

However, if you want to use your mobile phone, do so only when the vehicle is stationary and in a safe location.

Downloading destinations in COMAND

Destination Download gives you access to a database with over ten million points of interest (POIs) which can be downloaded onto the navigation system of your vehicle. If you know the destination, you can download the address or obtain the location of points of interest (POIs) or important destinations in the surrounding area.

You are prompted to confirm route guidance to the address entered.

i For information on the components and operating principles of COMAND, (see the separate operating instructions).

► Select **Yes** using the  or  buttons on COMAND.

► Confirm using the  button on COMAND.

The system calculates the route and subsequently starts the route guidance with the address entered.

i If you select **No**, the address can be stored in the address book.

i The Destination Download function is available if the corresponding mobile phone network is available and data transfer is possible.

Search & Send

"Search & Send" is a destination entry service. For more information on "Search & Send", see the separate operating instructions.

Vehicle remote opening

If you have unintentionally locked your vehicle (e.g. the SmartKey is inside the vehicle) and a replacement key is not available:

► Contact the following service hotlines:

- **USA:** Response Center at 1-888-990-9007

- **Canada:** Customer Service at 1-888-923-8367

You will be asked for your password.

► Return to your vehicle at the time arranged with the Response Center.

► Press the release button on the door handle of the rear door for at least 20 seconds until the indicator lamp in the SOS button (▷ page 225) flashes.

The **Connecting Call** message appears on the multifunction display.

Alternatively, the vehicle can be opened via the Internet in the "Owner's Online" section using your identification number and password³.

² USA only.

³ USA only.

i Vehicle remote opening is only possible if the corresponding mobile phone network is accessible.

The SOS button flashes and the **Connecting Call** message appears in the multifunction display to confirm that the command for vehicle remote unlocking has been received.

If the lock cylinder on the rear door is pressed for longer than 20 seconds before receiving authorization for remote unlocking from the Response center, you must wait 15 minutes before you can press the lock cylinder on the rear door again.

Vehicle remote closing

The remote closing feature can be used when you have forgotten to lock the vehicle and you are no longer nearby. The vehicle can then be locked by the Mercedes-Benz Customer Assistance Center.

The vehicle can be remotely locked within four days of the ignition being turned off.

- ▶ Contact the following service hotlines:
 - **USA:** Mercedes-Benz Customer Assistance Center at 1-800-FOR-MERCEdes (1-800-367-6372) or 1-888-990-9007
 - **Canada:** Customer Service at 1-888-923-8367

You will be asked for your PIN.

The next time you are inside the vehicle and you switch on the ignition, the **Tele Aid Doors Locked Remotely** message appears in the multifunction display.

USA only: alternatively, the vehicle can be locked via:

- the Internet, under the "Owners Online" section
- the telephone application (e.g. iPhone®, Blackberry)

To do this, you will need your identification number and password.

i The vehicle remote closing feature is available when the relevant mobile phone network is available and data connection is possible.

Stolen vehicle recovery service

If your vehicle has been stolen:

- ▶ Contact the police.
 - The police will issue an incident report. This report has a number.
- ▶ Forward this number to the Response Center together with your PIN.
 - The Response Center will then attempt to covertly contact the mbrace system. The Response Center contacts you and the local law enforcement authority if the vehicle is located. However, only the law enforcement agency is informed of the location of the vehicle.

i If the anti-theft alarm system is active for longer than 30 seconds, mbrace is automatically connected with the Customer Assistance center.

Vehicle Health Check

With the vehicle remote malfunction diagnosis (Vehicle Health Check), the Customer Assistance center can provide improved support for problems with your vehicle. During an existing call, vehicle data is transferred to the Customer Assistance center. The customer service representative can use the received data to decide what kind of assistance is required. You are then, for example, guided to the nearest Mercedes-Benz Service center or a recovery vehicle is called.

If vehicle data needs to be transferred during an MB Info call or a Roadside Assistance call, this is initiated by the Customer Assistance center.

You will see the **Roadside Assistance Connected** message in the COMAND display. If the vehicle remote malfunction diagnosis is able to be started, the **Request for vehicle diagnosis received. Start vehicle diagnosis?** message appears in the display.

- ▶ Press **Yes** to confirm the message.
- ▶ If the **Vehicle Diagnosis: Please start ignition** message appears: turn the Smart-Key to position **2** in the ignition lock.
- ▶ If the **Please follow the instructions received by phone and move your vehicle into a safe position** message appears: follow the instructions of the customer service representative. The message in the display disappears.

If you select **Cancel**, the vehicle remote malfunction diagnosis is canceled completely.

The vehicle operating state check begins. Meanwhile, the **Vehicle diagnosis activated** message appears.

When the check is finished, the **Sending vehicle diagnosis data... (Voice connection may be interrupted during data transfer)** message appears. The vehicle data can now be sent to the Customer Assistance center.

- ▶ Press **OK** to confirm the message. The voice connection with the Customer Assistance center is terminated. The **Vehicle Diagnosis: Transferring data...** message appears. The vehicle data is sent to the Customer Assistance center.

Depending on what the customer service representative agreed with you, the voice connection is re-established after the transfer is complete. If necessary, you will be contacted at a later time by another means, e.g. by e-mail or phone.

Further functions of the vehicle remote malfunction diagnosis include, for example:

- transfer of service data to the Customer Assistance center. If a service is overdue, the COMAND display shows a message about various special offers at your workshop.
- monthly status information e-mail on oil level, air pressure, maintenance, brakes, etc. If applicable, you will receive information on special offers in the e-mail.

USA only: this information can also be called up under "Owners Online" at <http://www.mbusa.com>.

Information on the data stored in the vehicle (▶ page 24).

Information on Roadside Assistance (▶ page 21).

Downloading routes

Downloading routes allows you to transfer and save predefined routes in the navigation system. To do this, an SD memory card must be inserted into the COMAND system. If no SD memory card is inserted, you must insert the card into the card slot on the COMAND system before saving.

A route can be prepared and sent either by a customer service representative or via the mbrace portal on the Internet. Each route can include up to 20 way points. When a route has been received by the navigation system, the **'Route name' has been saved to memory card. Do you want to start route guidance?** message appears on the COMAND display. The route is saved to the SD memory card.

- ▶ **To start route guidance:** select **Yes**.

An overview of the route is shown in the display.

- ❗ If you select **No**, the saved route can be called up later in the navigation menu.

- ▶ Select **Start**. Route guidance is started.

- ❗ Downloaded and saved data can be called up again in COMAND. Further information can be found in the "COMAND", "Online and Internet services" and "Download destination/route" sections.

Speed alert

You can define the upper speed limit, which must not be exceeded by the vehicle. If this selected speed is exceeded by the vehicle, a message will be sent to the Customer Assistance center. The Customer Assistance center then forwards this information to you. You can select the way in which you receive this information beforehand. Possible options include text message, e-mail or an automated call.

The data which is sent to the Customer Assistance center contains the following information:

- the location where the speed limit was exceeded
- the time at which the speed limit was exceeded
- the selected speed limit which was exceeded

Geo fencing

Geo fencing allows you to select areas which the vehicle should not enter or leave. You will be informed if the vehicle crosses the boundaries of the selected areas. You can select the way in which you receive this information beforehand. Possible options include text message, e-mail or an automated call.

The area can be determined as either a circle or a polygon with a maximum of ten corners. You

can specify up to ten areas simultaneously. Different settings are possible for each area.

USA only: these settings can be called up under "Owners Online" at <http://www.mbusa.com>.

Alternatively, you can trigger an MB Info call and inform the customer service representative that you wish to activate geo fencing.

Currently inactive areas can be activated by text message.

Triggering the vehicle alarm

With this function, you can trigger the vehicle's panic alarm via text message. An alarm sounds and the exterior lighting flashes. Depending on the setting, the panic alarm lasts five or ten seconds. Afterwards, the alarm switches off.

Brush guard (USA only)

If the brush guard has to be removed, contact a qualified specialist workshop.

Garage door opener

General notes

You can use the HomeLink® garage door opener integrated into the rear-view mirror to operate up to three different gate/garage door opener systems.

i Certain garage door drives are incompatible with the integrated garage door opener. If you have difficulty programing the integrated garage door opener, contact an authorized Mercedes-Benz Center. You can also contact the following service hotlines:

- **USA:** Mercedes-Benz Customer Assistance Center at 1-800-FOR-MERCEdes
- **Canada:** Customer Service at 1-800-387-0100

i USA only:

This device complies with Part 15 of the FCC Rules. Operation is subject to the following two conditions:

1. This device may not cause harmful interference, and
2. this device must accept any interference received, including interference that may cause undesired operation.

Any unauthorized modification to this device could void the user's authority to operate the equipment.

i Canada only:

This device complies with RSS-210 of Industry Canada. Operation is subject to the following two conditions:

1. This device may not cause harmful interference, and
2. this device must accept any interference received, including interference that may cause undesired operation.

Any unauthorized modification to this device could void the user's authority to operate the equipment.

Important safety notes

WARNING

When you operate or program the garage door with the integrated garage door opener, persons in the range of movement of the garage door can become trapped or struck by the garage door. There is a risk of injury.

When using the integrated garage door opener, always make sure that nobody is within the range of movement of the garage door.

WARNING

Combustion engines emit poisonous exhaust gases such as carbon monoxide. Inhaling these exhaust gases leads to poisoning. There is a risk of fatal injury. Therefore never leave the engine running in enclosed spaces without sufficient ventilation.

When programming a garage door opener, park the vehicle outside the garage. Do not run the engine while programming.

Programming the remote control

Programming

Pay attention to the "Important safety notes" (▷ page 231).



Integrated remote control in the rear-view mirror

- ① Indicator lamp
- ② ③ ④ Transmitter buttons
- ⑤ Garage door remote control
- ⑥ Transmitter button on the garage door remote control

Garage door remote control ⑤ is not part of the garage door opener.

i To achieve the best result, insert new batteries in garage door remote control ⑤ of your garage door drive before programming.

- ▶ Delete the memory of the integrated remote control (▶ page 234) before programming it for the first time.
- ▶ Turn the SmartKey to position **2** in the ignition lock (▶ page 112).
- ▶ Press and hold transmitter button ②, ③ or ④.

After a short time, indicator lamp ① will start flashing. It flashes approximately once per second.

i Indicator lamp ① flashes immediately the first time that the transmitter button is programmed. If this transmitter button has already been programmed, indicator lamp ① will only start flashing at a rate of once a second after 20 seconds have elapsed.

- ▶ Continue to hold the transmitter button.
- ▶ Point transmitter button ⑥ of garage door remote control ⑤ towards the transmitter buttons on the rear-view mirror at a distance of 2 to 12 inches (5 to 30 cm).

i The distance between garage door remote control ⑤ and the integrated garage door opener depends on the system of the garage door drive. Several attempts might be necessary. You should test every position for at least 20 seconds before trying another position.

- ▶ Keep transmitter button ⑥ on garage door remote control ⑤ pressed until indicator lamp ① starts to flash rapidly. The programming has been successful if indicator lamp ① flashes rapidly.
- ▶ Release transmitter buttons ②, ③ or ④ on the integrated remote control and transmitter button ⑥ on the garage door remote control.

If indicator lamp ① goes out after approximately 20 seconds and has not flashed rapidly:

- ▶ Release transmitter buttons ②, ③ or ④ on the integrated remote control and transmitter button ⑥ on the garage door remote control.
- ▶ Repeat the procedure for the other transmitter buttons. When doing so, vary the distance between the garage door's remote control and the transmitter buttons in the rear-view mirror.

i If the garage door system works with a rolling code, you must synchronize the remote control integrated in the rear-view mirror with the garage door system receiver after programming.

You will find further information in the garage door opening system's operating instructions, e.g. the sections on "Synchronizing the transmitter" or "Registering a new transmitter". You can also call the hotline mentioned above.

Synchronizing the rolling code



Integrated remote control in the rear-view mirror

- ① Indicator lamp
- ② ③ ④ Transmitter buttons
- ⑤ Garage door remote control
- ⑥ Transmitter button on the garage door remote control

Your vehicle must be within reach of the garage door or gate opener drive. Make sure that nei-

ther your vehicle nor any persons/objects are present within the sweep of the door or gate. Observe the safety notes when performing the rolling code synchronization (▷ page 231).

- ▶ Turn the SmartKey to position **2** in the ignition lock (▷ page 112).
- ▶ Press the programming button of the door or gate drive (see the door or gate drive operating instructions, e.g. under "Programming additional remote controls").

i You now have 30 seconds to initiate the next step.

- ▶ Press previously programmed button **②**, **③** or **④** on the integrated garage door opener until the door closes.
The rolling code synchronization is then complete.

Notes on programming the remote control

Canadian radio frequency laws require a "break" (or interruption) of the transmission signals after broadcasting for a few seconds. Therefore, these signals may not last long enough for the integrated remote control to recognize the signal during programming. Comparable with Canadian law, American garage door openers also have a built-in "interruption".

If you live in Canada or have difficulties programming the garage door opener (regardless of where you live) when using the programming steps, proceed as follows:



Integrated remote control in the rear-view mirror

- ① Indicator lamp
- ② ③ ④ Transmitter buttons
- ⑤ Garage door remote control
- ⑥ Transmitter button on the garage door remote control

- ▶ Keep the transmitter button **②**, **③** or **④** depressed until the integrated remote control has been set up successfully.
- ▶ Simultaneously press transmitter button **⑥** on the garage door remote control and hold for 2 seconds. Then let go for 2 seconds, press again and hold for 2 seconds.
- ▶ Repeat this sequence on transmitter button **⑥** of the garage door remote control until the frequency signal has been saved.
- ▶ If the setup procedure is successful, indicator lamp **①** flashes once slowly and goes out after a few seconds.
- ▶ Continue with the other programming steps (see above).

Problems when programming



Integrated remote control in the rear-view mirror

- ① Indicator lamp
- ② ③ ④ Transmitter buttons
- ⑤ Garage door remote control
- ⑥ Transmitter button on the garage door remote control

If you have problems when programming the integrated remote control, please note the following:

- Check the transmitter frequency of garage door remote control **⑤** (which can usually be found on the back of the remote control).
The integrated remote control is compatible with devices that have units which operate in the frequency range of 280 to 390 MHz.
- replace the batteries in garage door remote control **⑤**. This increases the probability of garage door remote control **⑤** sending a strong and precise signal to the integrated remote control on the rear-view mirror.
- When programming, hold garage door remote control **⑤** at varying distances and angles

from the transmitter button which you are programming. Try various angles at a distance between 2 and 12 inches (5 to 30 cm) or at the same angle but at varying distances.

- If there is another garage door remote control for the same device, perform the programming steps again using that garage door opener. Before performing these steps, make sure that new batteries have been installed in the garage door remote control.
- Align the antenna cable of the garage door opener unit. This can improve signal transmission.

Opening/closing the garage door



- ① Indicator lamp
- ② ③ ④ Transmitter buttons
- ⑤ Garage door remote control
- ⑥ Transmitter button on the garage door remote control

Once programmed, the integrated remote control will assume the function of the garage door system's remote control. Please also read the operating instructions for the garage door system.

- ▶ Turn the SmartKey to position **2** (▷ page 112) in the ignition lock.
- ▶ Press transmitter button ②, ③ or ④ on the integrated remote control in the rear-view mirror that is programmed to operate the garage door.
 - Garage door system with fixed code: indicator lamp ① lights up continuously.
 - Garage door system with rolling code: indicator lamp ① flashes briefly and then lights up for approximately two seconds. This is repeated for up to 20 seconds.

i The transmitter will transmit a signal for as long as the transmitter button is being

pressed. The transmission will be halted after a maximum of 20 seconds and indicator lamp ① will flash. Press the transmitter button again, if necessary.

Clearing the remote control memory



- ① Indicator lamp
- ② ③ ④ Transmitter buttons
- ⑤ Garage door remote control
- ⑥ Transmitter button on the garage door remote control

- ▶ Turn the SmartKey to position **2** (▷ page 112) in the ignition lock.
- ▶ Press and hold transmitter buttons ② and ④ for approximately 20 seconds until indicator lamp ① flashes rapidly. The memory is cleared.

i Make sure that you clear the remote control memory before selling the vehicle.

Useful information

- i** This Operator's Manual describes all models and all standard and optional equipment of your vehicle available at the time of publication of the Operator's Manual. Country-specific differences are possible. Please note that your vehicle may not be equipped with all features described. This also applies to safety-related systems and functions.
- i** Read the information on qualified specialist workshops: (▷ page 23).

Engine compartment

Hood

Important safety notes

WARNING

If the hood is unlatched, it may open up when the vehicle is in motion and block your view. There is a risk of an accident.

Never unlatch the hood while driving. Before every trip, ensure that the hood is locked.

WARNING

Certain components in the engine compartment may be very hot, e.g. the drive system and radiator. Working in the engine compartment poses a risk of injury.

If possible, let the drive system cool down and only touch the components described in the following.

WARNING

Opening the hood when the engine is overheated or when there is a fire in the engine compartment could expose you to hot gases or other service products. There is a risk of injury.

Let an overheated engine cool down before opening the hood. If there is a fire in the engine compartment, keep the hood closed and contact the fire department.

WARNING

The ignition system and the fuel injection system work under high voltage. If you touch components which are under voltage, you could get an electric shock. There is a risk of injury.

Never touch components of the ignition system or fuel injection system when the ignition is switched on.

WARNING

The engine compartment contains moving components. Certain components, such as the radiator fan, may continue to run or start again suddenly when the ignition is off. There is a risk of injury.

If you need to do any work inside the engine compartment:

- switch off the ignition
- never reach into the area where there is a risk of danger from moving components, such as the fan rotation area
- remove jewelry and watches
- keep items of clothing and hair, for example, away from moving parts

WARNING

When the hood is open and the windshield wipers are set in motion, you can be injured by the wiper linkage. There is a risk of injury.

Always switch off the windshield wipers and the ignition before opening the hood.

- !** Make sure that the windshield wipers are not folded away from the windshield. You could otherwise damage the windshield wipers or the hood.

Do not touch the following when the ignition is switched on:

- ignition coils
- spark plug connectors
- test socket

Opening the hood



The release lever on the hood is in the footwell on the left-hand side of the vehicle when viewed in the direction of travel.

- ▶ Make sure that the windshield wipers are switched off.
- ▶ Pull release lever ① on the hood. The hood is released.



- ▶ Lift the hood slightly.
- ▶ Push the handle of hood catch ② in the direction of the arrow and lift the hood.

Closing the hood

WARNING

If the hood is unlatched, it may open up when the vehicle is in motion and block your view. There is a risk of an accident.

Never unlatch the hood while driving. Before every trip, ensure that the hood is locked.

- ▶ Lower the hood and let it fall from a height of approximately 8 inches (20 cm).
- ▶ Check that the hood has engaged properly. If the hood can be raised slightly, it is not properly engaged. Open it again and close it with a little more force.

Engine oil

General notes

Depending on your driving style, the vehicle consumes up to 0.9 US qt (0.8 liters) of oil per 600 miles (1000 km). The oil consumption may be higher than this when the vehicle is new or if you frequently drive at high engine speeds.

Checking the oil level using the oil dipstick

WARNING

Certain components in the engine compartment, such as the engine, radiator and parts of the exhaust system, can become very hot. Working in the engine compartment poses a risk of injury.

Where possible, let the engine cool down and touch only the components described in the following.

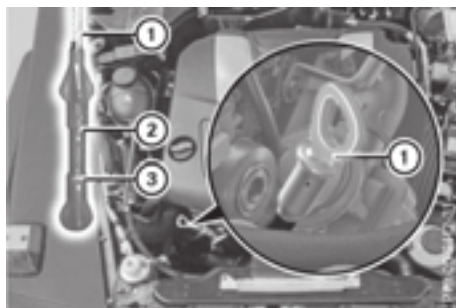

Example: oil dipstick

On the G 63 AMG, the oil level can be checked using the oil dipstick.

When checking the oil level:

- park the vehicle on a level surface.
- the engine should be switched off for approximately five minutes if the engine is at normal operating temperature.
- the engine should be switched off for at least 30 minutes if the engine is not at operating temperature, e.g. if you only start the engine briefly.
- ▶ Pull oil dipstick ① out of the dipstick guide tube.
- ▶ Wipe off oil dipstick ①.
- ▶ Slowly slide oil dipstick ① into the guide tube to the stop, and take it out again. If the level is between MIN mark ③ and MAX mark ②, the oil level is correct.
- ▶ Add oil if necessary.



On all other models, the on-board computer must be used to check the engine oil level.

Checking the oil level using the on-board computer

! Do not add too much oil. adding too much engine oil can result in damage to the engine or to the catalytic converter. Have excess engine oil siphoned off.

G 550: the oil level can only be checked using the on-board computer.

When checking the oil level:

- park the vehicle on a level surface.
- the engine should be switched off for approximately five minutes if the engine is at normal operating temperature.
- ▶ Make sure that the SmartKey is in position 2 in the ignition lock.
- ▶ Press the  or  button on the steering wheel to select the following message:

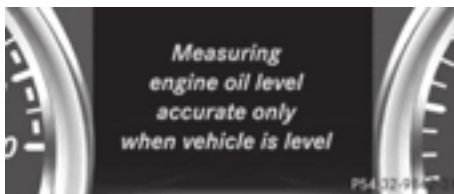

The measurement takes a few seconds. You will see one of the following messages in the multi-function display:

- **Engine Oil Level OK**
- **Add 1.0 qt (Canada: 1.0 liter) to reach maximum oil level**
- **Add 1.5 qts (Canada: 1.5 liters) to reach maximum oil level**
- **Add 2.0 qts. (Canada: 2.0 liters) to reach maximum oil level**
- ▶ Add oil if necessary.

If the engine is at normal operating temperature and the **Engine oil Reduce oil level** display appears, too much oil has been added.

- ▶ Have excess oil siphoned off.

If the **Switch ignition on to check engine oil level** message appears:



- ▶ Turn the SmartKey to position 2 in the ignition lock (▷ page 112).

If the **Observe waiting time** message appears:

- ▶ **If the engine is at normal operating temperature:** repeat the measurement after approximately five minutes.
- ▶ **If the engine is not at normal operating temperature:** e.g. if the engine was only started briefly, repeat the measurement after approximately 30 minutes.

If the **Engine oil level Not when engine on** message appears:

- ▶ Switch off the engine.
- ▶ **If the engine is at normal operating temperature:** wait about five minutes before carrying out the measurement.
- ▶ **If the engine is not at normal operating temperature:** e.g. if the engine was only started briefly, wait approximately 30 minutes before carrying out the measurement.

- ▶ **i** If you wish to cancel the measurement, press the  or  button on the multi-function steering wheel.

Adding engine oil

WARNING

Certain components in the engine compartment, such as the engine, radiator and parts of the exhaust system, can become very hot.

Working in the engine compartment poses a risk of injury.

Where possible, let the engine cool down and touch only the components described in the following.

WARNING

If engine oil comes into contact with hot components in the engine compartment, it may ignite. There is a risk of fire and injury.

Make sure that engine oil is not spilled next to the filler neck. Let the engine cool down and thoroughly clean the engine oil off the components before starting the engine.

Environmental note

When adding oil, take care not to spill any. If oil enters the soil or waterways, it is harmful to the environment.

- !** Only use engine oils and oil filters that have been approved for vehicles with a service system. You can obtain a list of the engine oils and oil filters tested and approved in accordance with the Mercedes-Benz Specifications for Service Products at any Mercedes-Benz Service center.

Damage to the engine or exhaust system is caused by the following:

- using engine oils and oil filters that have not been specifically approved for the service system
 - replacing engine oil and oil filters after the interval for replacement specified by the service system has been exceeded
 - using engine oil additives.
- !** Do not add too much oil. If the oil level is above the "max" mark on the dipstick, too much oil has been added. This can lead to damage to the engine or the catalytic converter. Have excess oil siphoned off.



Example: engine oil cap

- ▶ Turn cap ① counter-clockwise and remove it.
- ▶ Add the amount of oil required.

Observe the specifications in the on-board computer when doing so or fill carefully to the maximum mark on the oil dipstick.

Further information on engine oil (▶ page 292).

- i** The difference between the minimum mark and the maximum mark on the oil dipstick is approximately 2.1 US qt (2 l).
- ▶ Replace cap ① on the filler neck and tighten clockwise.
Ensure that the cap locks into place securely.

Additional service products

Checking coolant level

WARNING

Certain components in the engine compartment, such as the engine, radiator and parts of the exhaust system, can become very hot. Working in the engine compartment poses a risk of injury.

Where possible, let the engine cool down and touch only the components described in the following.

WARNING

The cooling system is pressurized, particularly when the motor is warm. If you open the cap, you could be scalded if hot coolant sprays out. There is a risk of injury.

Let the engine cool down before you open the cap. Wear gloves and eye protection. Slowly open the cap to relieve pressure.

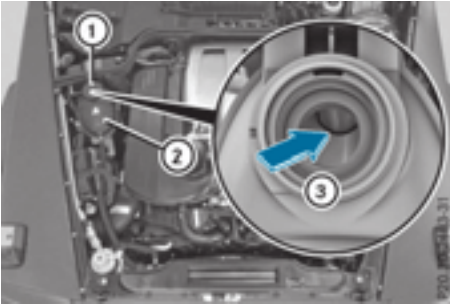

- ▶ Park the vehicle on a level surface.
Only check the coolant level when the vehicle is on a level surface and the engine has cooled down.
- ▶ Turn the SmartKey to position **2** (▷ page 112) in the ignition lock.
- ▶ Check the coolant temperature display in the instrument cluster.
The coolant temperature must be below 158 °F (70 °C).
- ▶ Slowly turn cap **1** half a turn counter-clockwise and allow excess pressure to escape.
- ▶ Turn cap **1** further counter-clockwise and remove it.
If the coolant is at the level of marker bar **3** in the filler neck when cold, there is enough coolant in coolant expansion tank **2**.
If the coolant level is approximately 0.6 in (1.5 cm) above marker bar **3** in the filler neck when warm, there is enough coolant in coolant expansion tank **2**.
- ▶ If necessary, add coolant that has been tested and approved by Mercedes-Benz.
- ▶ Replace cap **1** and turn it clockwise as far as it will go.

For further information on coolant, see (▷ page 294).

Adding washer fluid to the windshield washer system/headlamp cleaning system

⚠ WARNING

Certain components in the engine compartment, such as the engine, radiator and parts of the exhaust system, can become very hot. Working in the engine compartment poses a risk of injury.

Where possible, let the engine cool down and touch only the components described in the following.

⚠ WARNING

Windshield washer concentrate could ignite if it comes into contact with hot engine components or the exhaust system. There is a risk of fire and injury.

Make sure that no windshield washer concentrate is spilled next to the filler neck.

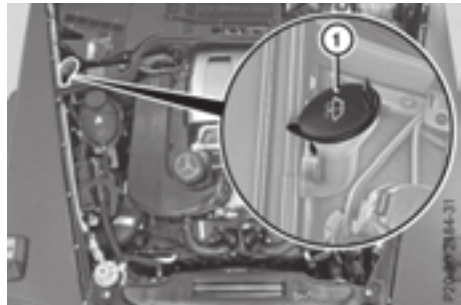

Example: washer fluid reservoir

- ▶ **To open:** pull cap **1** upwards by the tab.
- ▶ Add the premixed washer fluid.
- ▶ **To close:** press cap **1** onto the filler neck until it engages.

On vehicles with the headlamp cleaning system, the recommended minimum washer fluid level is 0.92 US gal (3.5 liters). On vehicles without the headlamp cleaning system, the recommended minimum washer fluid level is 0.26 US gal (1 liter). If the washer fluid level drops below the recommended minimum fluid level of 0.26 US gal (1 liter), a message appears in the multifunction display prompting you to add washer fluid (▷ page 202).

Further information on windshield washer fluid/antifreeze (> page 295).

Brake fluid level

! If you notice that the brake fluid level in the brake fluid reservoir has fallen to the MIN mark or less, check the brake system immediately for leaks. Also check the thickness of the brake linings. Visit a qualified specialist workshop immediately.

Do not add brake fluid. This does not correct the error.

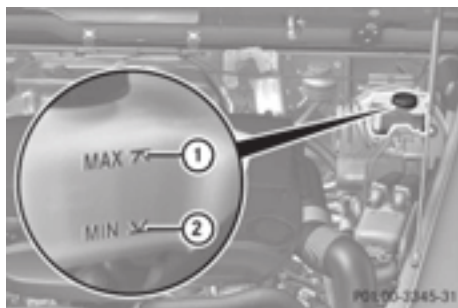

Only check the brake fluid level when the vehicle is on a level surface.

If the brake fluid level is between MIN mark ① and MAX mark ② on the brake fluid reservoir, it is correct.

Maintenance

Service interval display

Service messages

Information on the type of service and service intervals (see the separate Maintenance Booklet).

You can obtain further information from an authorized Mercedes-Benz Center or at <http://www.mbusa.com> (USA only).

The ASSYST service interval display informs you of the next service due date.

If a service due date has been exceeded, you also hear a warning tone.

The multifunction display shows a service message for several seconds, e.g.:

Service A in 99999 Miles
Service A Due Now

Service A Exceeded By 99999 Miles

Maintaining the time-dependent service schedule:

► Before disconnecting the battery, note down the service due date displayed.

or

► After reconnecting the battery, subtract the battery disconnection periods from the service date shown on the display.

i The service interval display should not be confused with the  engine oil level display.

The symbol and the letter indicate which type of service is due:

 Minor service **A**

 Major service **B**

The ASSYST service interval display does not take into account any periods of time during which the battery is disconnected.



Hiding a service message

► To hide the service message, press the  back button on the multifunction steering wheel (> page 29)(> page 172).



Displaying service messages

Use the buttons on the multifunction steering wheel.

► Switch on the ignition.

► Press  or  to select the **standard display** menu on the steering wheel (> page 173).

► Press  or  to select the service interval display.

The  or  service symbol and the service due date are displayed.

Points to remember

The specified maintenance interval takes only the normal operation of the vehicle into account. Under arduous operating conditions or increased load on the vehicle, maintenance work must be carried out more frequently, for example:

- regular city driving with frequent intermediate stops
- if the vehicle is primarily used to travel short distances

- use in mountainous terrain or on poor road surfaces
- if the engine is often left idling for long periods

Under these or similar conditions, have, for example, the air filter, engine oil and oil filter replaced or changed more frequently. Under arduous operating conditions, the tires must be checked more often. Further information can be obtained at a qualified specialist workshop, e.g. an authorized Mercedes-Benz Center.

Fuel/water separator

🔗 Environmental note

Dispose of service products in an environmentally responsible manner.

- ❗ If you continue driving without having the fuel/water separator serviced, this could cause damage to the engine. Any resulting damage is not covered by the warranty.

If the fuel/water separator needs servicing, the following message appears in the multifunction display:



You will also hear a brief warning tone.

- ▶ Visit a qualified specialist workshop as soon as possible.

Care

General notes

⚠️ WARNING

Many cleaning products can be hazardous. Some are poisonous, others are flammable. Always follow the instructions on the particular container. Always open your vehicle's doors or windows when cleaning the inside.

Never use fluids or solvents that are not designed for cleaning your vehicle.

Always lock away cleaning products and keep them out of reach of children.

- ❗ For cleaning your vehicle, do not use any of the following:

- dry, rough or hard cloths
- abrasive cleaning agents
- solvents
- cleaning agents containing solvents

Do not scrub.

Do not touch the surfaces or protective films with hard objects, e.g. a ring or ice scraper. You could otherwise scratch or damage the surfaces and protective film.

- ❗ Do not park the vehicle for an extended period straight after cleaning it, particularly after having cleaned the wheels with wheel cleaner. Wheel cleaners could cause increased corrosion of the brake discs and brake pads/linings. For this reason, you should drive for a few minutes after cleaning. Braking heats the brake discs and the brake pads/linings, thus drying them. The vehicle can then be parked.

🔗 Environmental note

Dispose of empty packaging and cleaning cloths in an environmentally responsible manner.

Regular care of your vehicle is a condition for retaining the quality in the long term.

Use care products and cleaning agents recommended and approved by Mercedes-Benz.

Exterior care

Automatic car wash

⚠️ WARNING

Braking efficiency is reduced after washing the vehicle. There is a risk of an accident.

After the vehicle has been washed, brake carefully while paying attention to the traffic conditions until full braking power is restored.

- ❗ Never clean your vehicle in a Touchless Automatic Car Wash as these use special

cleaning agents. These cleaning agents can damage the paintwork or plastic parts.

! Make sure that the automatic car wash is suitable for the size of the vehicle. Fold in the exterior mirrors before the vehicle is washed. The exterior mirrors could otherwise be damaged.

! Make sure that the automatic transmission is in position **N** when washing your vehicle in a tow-through car wash. The vehicle could be damaged if the transmission is in another position.

! Make sure that:

- the side windows and sliding sunroof are closed completely.
- the blower for the ventilation/heating is switched off (airflow control is turned to position **0**/the **AUTO** and **A/C REST** buttons are switched off).
- the windshield wiper switch is at position **0**.

The vehicle could otherwise be damaged.

You can wash the vehicle in an automatic car wash from the very start.

If the vehicle is very dirty, pre-wash it before cleaning it in an automatic car wash.

After using an automatic car wash, wipe off wax from the windshield and the wiper blades. This will prevent smears and reduce wiping noises caused by residue on the windshield.

Washing by hand

In some countries, washing by hand is only allowed at specially equipped washing bays. Observe the legal requirements in all countries concerned.

When using the vehicle in winter, remove all traces of road salt deposits carefully and as soon as possible.

When washing the vehicle underbody, also clean the inside of the wheels.

- ▶ Do not use hot water and do not wash the vehicle in direct sunlight.
- ▶ Use a soft sponge to clean.
- ▶ Use a mild cleaning agent, such as a car shampoo approved by Mercedes-Benz.
- ▶ Thoroughly hose down the vehicle with a gentle jet of water.
- ▶ Do not point the water jet directly towards the air inlets.

- ▶ Use plenty of water and rinse out the sponge frequently.
- ▶ Rinse the vehicle with clean water and dry thoroughly with a chamois.
- ▶ Do not let the cleaning agent dry on the paintwork.

Power washers

WARNING

The water jet from a circular jet nozzle (dirt blasters) can cause invisible exterior damage to the tires or chassis components. Components damaged in this way may fail unexpectedly. There is a risk of an accident.

Do not use power washers with circular jet nozzles to clean the vehicle. Have damaged tires or chassis components replaced immediately.

! Always maintain a distance of at least 11.8 in (30 cm) between the vehicle and the power washer nozzle. Information about the correct distance is available from the equipment manufacturer.

Move the power washer nozzle around when cleaning your vehicle.

Do not aim directly at any of the following:

- tires
- door gaps, roof gaps, joints, etc.
- electrical components
- battery
- connectors
- lights
- seals
- trim
- ventilation slots

Damaged seals or electrical components can lead to leaks or failures.

Cleaning the wheels

! Do not use acidic wheel cleaning products to remove brake dust. This could damage wheel bolts and brake components.

! Do not park the vehicle for an extended period straight after cleaning it, particularly after having cleaned the wheels with wheel cleaner. Wheel cleaners could cause

increased corrosion of the brake discs and brake pads/linings. For this reason, you should drive for a few minutes after cleaning. Braking heats the brake discs and the brake pads/linings, thus drying them. The vehicle can then be parked.

Cleaning the paintwork

! Do not affix:

- stickers
- films
- magnetic plates or similar items

to painted surfaces. You could otherwise damage the paintwork.

Scratches, corrosive deposits, areas affected by corrosion and damage caused by inadequate care cannot always be completely repaired. In such cases, visit a qualified specialist workshop.

- ▶ Remove dirt immediately, where possible, while avoiding rubbing too hard.
- ▶ Soak insect remains with insect remover and rinse off the treated areas afterwards.
- ▶ Soak bird droppings with water and rinse off the treated areas afterwards.
- ▶ Remove coolant, brake fluid, tree resin, oils, fuels and greases by rubbing gently with a cloth soaked in petroleum ether or lighter fluid.
- ▶ Use tar remover to remove tar stains.
- ▶ Use silicone remover to remove wax.

If water no longer forms "beads" on the paint surface, use the paint care products recommended and approved by Mercedes-Benz. This is the case approximately every three to five months, depending on the climate conditions and the care product used.

If dirt has penetrated the paint surface or if the paint has become dull, the paint cleaner recommended and approved by Mercedes-Benz should be used.

Do not use these care products in the sun or on the hood while the hood is hot.

- ▶ Use a suitable touch-up stick, e.g. MB Touch-Up Stick, to correct smaller areas of paint damage quickly and provisionally.

Matte finish care

! Never polish the vehicle or the light alloy wheels. Polishing causes the finish to shine.

! Never use paint cleaner, buffing or polishing products, or gloss preserver, e.g. wax. These products are only suitable for high-gloss surfaces. Their use on vehicles with matte finish leads to considerable surface damage (shiny, spotted areas).

Always have paintwork repairs carried out at a qualified specialist workshop.

! Do not use wash programs with a hot wax treatment under any circumstances.

If your vehicle has a clear matte finish, observe the following instructions in order to avoid damage to the paintwork due to incorrect care.

These notes also apply to light alloy wheels with a clear matte finish.

i The vehicle should preferably be washed by hand using a soft sponge, car shampoo and plenty of water.

i Use only insect remover and car shampoo from the range of recommended and approved Mercedes-Benz care products.

Cleaning the windows

WARNING

You could become trapped by the windshield wipers if they start moving while cleaning the windshield or wiper blades. There is a risk of injury.

Always switch off the windshield wipers and the ignition before cleaning the windshield or wiper blades.

! Do not use dry cloths, abrasive products, solvents or cleaning agents containing solvents to clean the inside of the windows. Do not touch the insides of the windows with hard objects, e.g. an ice scraper or ring. There is otherwise a risk of damaging the windows.

! Clean the water drainage channels of the windshield and the rear window at regular intervals. Deposits such as leaves, petals and pollen may under certain circumstances prevent water from draining away. This can lead

to corrosion damage and damage to electronic components.

- ▶ Clean the inside and outside of the windows with a damp cloth and a cleaning product that is recommended and approved by Mercedes-Benz.

Cleaning wiper blades

WARNING

You could become trapped by the windshield wipers if they start moving while cleaning the windshield or wiper blades. There is a risk of injury.

Always switch off the windshield wipers and the ignition before cleaning the windshield or wiper blades.

- ❗ Do not pull the wiper blade. Otherwise, the wiper blade could be damaged.

- ❗ Do not clean wiper blades too often and do not rub them too hard. Otherwise, the graphite coating could be damaged. This could cause wiper noise.

- ❗ Hold the wiper arm securely when folding back. The windshield could be damaged if the wiper arm smacks against it suddenly.

- ▶ Fold the windshield wiper arms away from the windshield.
- ▶ Carefully clean the wiper blades with a damp cloth.
- ▶ Fold the windshield wiper arms back again before switching on the ignition.

Cleaning the headlamps

- ▶ Clean the headlamp lenses with a damp sponge and a mild cleaning agent, e.g. Mercedes-Benz car shampoo or cleaning cloths.

Cleaning the sensors

- ❗ If you clean the sensors with a power washer, make sure that you keep a distance of at least 11.8 in (30 cm) between the vehicle and the power washer nozzle. Information about the correct distance is available from the equipment manufacturer.

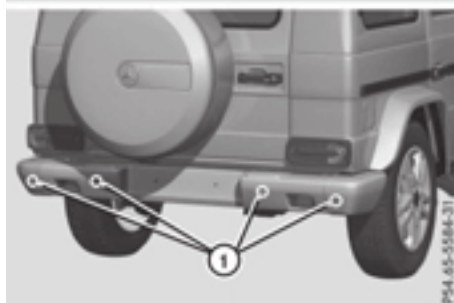
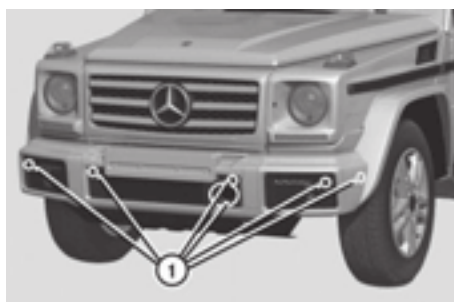

- ▶ Clean sensors ① of the driving systems with water, car shampoo and a soft cloth.

Cleaning the rear view camera

- ❗ Do not clean the camera lens and the area around the rear view camera with a power washer.

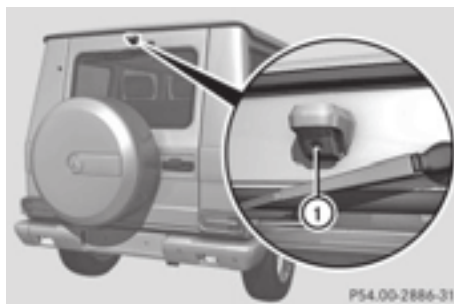

- ▶ Use clear water and a soft cloth to clean camera lens ①.

Cleaning chrome parts

- ❗ Do not clean the exhaust pipe with acid-based cleaning agents such as sanitary cleansers or wheel cleaners.

Impurities combined with the effects of road grit and corrosive environmental factors may cause flash rust to form on the surface. You can restore the original shine of the chrome parts by cleaning them regularly, especially in winter and after washing.

- ▶ Clean the chrome parts with a chrome care product tested and approved by Mercedes-Benz.

Cleaning the trailer coupling

🔗 Environmental note

Dispose of rags soaked in oil and grease in an environmentally responsible manner.

- ❗ Do not clean the ball coupling with a power washer. Do not use solvents.
- ❗ Please note the care instructions in the trailer coupling manufacturer's operating instructions.

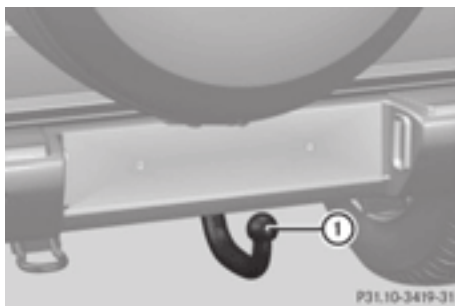

Ball coupling ① must be cleaned if it becomes dirty or corroded.

- ▶ After cleaning, lightly oil or grease ball coupling ①.
 - ▶ Check that the vehicle's trailer tow hitch is working properly.
- i** You can also have the maintenance work on the ball coupling and the trailer tow hitch carried out by a qualified specialist workshop.

Interior care

Cleaning the display

- ❗ For cleaning, do not use any of the following:
 - alcohol-based thinner or gasoline
 - abrasive cleaning agents
 - commercially-available household cleaning agents
 These may damage the display surface. Do not put pressure on the display surface when cleaning. This could lead to irreparable damage to the display.
- ▶ Before cleaning the display, make sure that it is switched off and has cooled down.
- ▶ Clean the display surface using a commercially available microfiber cloth and TFT/LCD display cleaner.
- ▶ Dry the display surface using a dry microfiber cloth.

Cleaning the plastic trim

⚠ WARNING

Care products and cleaning agents containing solvents cause surfaces in the cockpit to become porous. As a result, plastic parts may come loose in the event of air bag deployment. There is a risk of injury.

Do not use any care products and cleaning agents to clean the cockpit.

- ❗ Do not affix the following to plastic surfaces:
 - stickers
 - films
 - scented oil bottles or similar items
 You can otherwise damage the plastic.
- ❗ Do not allow cosmetics, insect repellent or sunscreen to come into contact with the plastic trim. This maintains the high-quality look of the surfaces.
- ▶ Wipe the plastic trim with a damp, lint-free cloth, e.g. a microfiber cloth.
- ▶ **Heavy soiling:** use care and cleaning products recommended and approved by Mercedes-Benz. The surface may change color temporarily. Wait until the surface is dry again.

Cleaning the steering wheel and gear or selector lever

- ▶ Thoroughly wipe with a damp cloth or use leather care agents that have been recommended and approved by Mercedes-Benz.

Cleaning genuine wood and trim strips

❗ Do not use solvent-based cleaning agents such as tar remover, wheel cleaners, polishes or waxes. There is otherwise a risk of damaging the surface.

❗ Do not use chrome polish for trim strips. The trim strips have a chrome look but are mostly made of anodized aluminum and can lose their shine if chrome polish is used. Use a damp, lint-free cloth instead when cleaning the trim strips.

If the chrome-plated trim strips are very dirty, you can use a chrome polish. If you are unsure as to whether the trim strips are chrome-plated or not, consult an authorized Mercedes-Benz Center.

- ▶ Wipe the wooden trim and trim strips with a damp, lint-free cloth, e.g. a microfiber cloth.
- ▶ **Heavy soiling:** use car care and cleaning products recommended and approved by Mercedes-Benz.

Cleaning the seat covers

General notes

❗ Do not use microfiber cloths to clean genuine leather, artificial leather or DINAMICA covers. If used often, these can damage the cover.

- ⓘ Note that regular care is essential to ensure that the appearance and comfort of the covers is retained over time.

Genuine leather seat covers

❗ To retain the natural appearance of the leather, observe the following cleaning instructions:

- Clean genuine leather covers carefully with a damp cloth and then wipe the covers down with a dry cloth.
- Make sure that the leather does not become soaked. It may otherwise become rough and cracked.
- Only use leather care agents that have been tested and approved by Mercedes-Benz. You can obtain these from a qualified specialist workshop.

Leather is a natural product.

It exhibits natural surface characteristics, for example:

- differences in the texture
- marks caused by growth and injury
- slight nuances of color

These are characteristics of leather and not material defects.

Seat covers of other materials

❗ Observe the following when cleaning:

- clean artificial leather covers with a cloth moistened with a solution containing 1% detergent (e.g. dish washing liquid).
- clean cloth covers with a microfiber cloth moistened with a solution containing 1% detergent (e.g. dish washing liquid). Rub carefully and always wipe entire seat sections to avoid leaving visible lines. Leave the seat to dry afterwards. Cleaning results depend on the type of dirt and how long it has been there.
- clean DINAMICA covers with a damp cloth. Make sure that you wipe entire seat sections to avoid leaving visible lines.

Cleaning the seat belts

WARNING

Seat belts can become severely weakened if bleached or dyed. This could cause the seat belts to tear or fail, for instance, in the event of an accident. This poses an increased risk of injury or fatal injury.

Never bleach or dye the seat belts.

! Do not clean the seat belts using chemical cleaning agents. Do not dry the seat belts by heating at temperatures above 176 °F (80 °C) or in direct sunlight.

- ▶ Use clean, lukewarm water and soap solution.

Cleaning the headliner and carpets

- ▶ **Headliner:** if it is very dirty, use a soft brush or dry shampoo.
- ▶ **Carpets:** use the carpet and textile cleaning agents recommended and approved by Mercedes-Benz.

Useful information

- i** This Operator's Manual describes all models and all standard and optional equipment of your vehicle available at the time of publication of the Operator's Manual. Country-specific differences are possible. Please note that your vehicle may not be equipped with all features described. This also applies to safety-related systems and functions.
- i** Read the information on qualified specialist workshops: (▷ page 23).

Where will I find...?

Warning triangle

Setting up the warning triangle

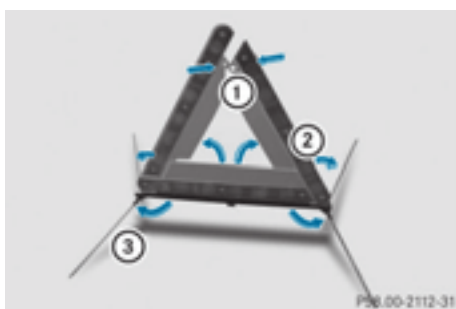

- ① Press-stud
- ② Reflectors
- ③ Feet

- ▶ Fold feet ③ down and out to the side.
- ▶ Pull side reflectors ② up to form a triangle and lock them at the top using press-stud ①.

First-aid kit

- i** Check the expiration date on the first-aid kit at least once a year. Replace the contents if necessary, and replace missing items.

Vehicle tool kit

General notes

- i** When they leave the factory, vehicles are not equipped with the tools needed to change a wheel, such as a jack or lug wrench. Some tools for changing a wheel are specific to the vehicle. To obtain tools approved for your vehicle, contact a qualified specialist workshop.

The vehicle tool kit contains:

- vehicle tool kit bag with:
 - fuse extractor
 - an Allen key, e.g. to operate the sliding roof manually in an emergency
 - a pump lever for the vehicle jack
 - a screwdriver
 - Lug wrench
- jack

Vehicle tool kit

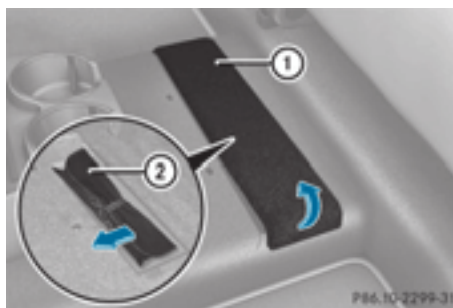

The vehicle tool kit is under the cover in the footwell in front of the rear bench seat.

- ▶ Fold cover ① to the side.
- ▶ Pull vehicle tool kit ② out by the tab.

Jack

- i** Make sure that, while installing the vehicle jack, there are no cables on the holder, in order to avoid them becoming trapped.

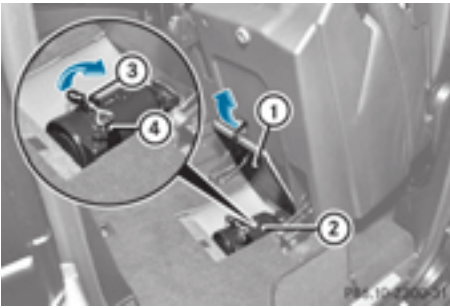

Jack ② is located under the rear bench seat on the right-hand side when viewed in the direction of travel.

- ▶ Fold rear bench seat (> page 218) forwards.
- ▶ Open cover ①.
- ▶ Pull bar ③ upwards and detach from tab ④.
- ▶ Remove jack ②.

Exterior spare wheel bracket

General notes

WARNING

The wheel or tire size as well as the tire type of the spare wheel or emergency spare wheel and the wheel to be replaced may differ. Mounting an emergency spare wheel may severely impair the driving characteristics. There is a risk of an accident.

To avoid hazardous situations:

- adapt your driving style accordingly and drive carefully.
- never mount more than one spare wheel or emergency spare wheel that differs in size.
- only use a spare wheel or emergency spare wheel of a different size briefly.
- do not switch ESP® off.
- have a spare wheel or emergency spare wheel of a different size replaced at the nearest qualified specialist workshop. Observe that the wheel and tire dimensions as well as the tire type must be correct.

- i** When changing a wheel, you should also observe the safety notes in the "Flat tire" section (> page 250).

The spare wheel is on the outer side of the rear door.

Stainless-steel spare hub cap

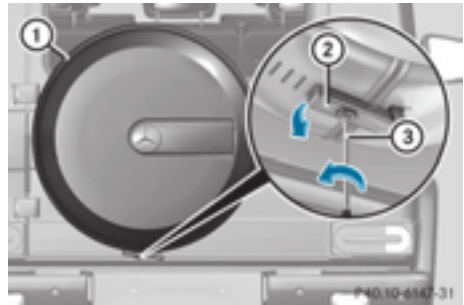

- ▶ Take the screwdriver out of the vehicle tool kit (> page 248).
- ▶ Open the lock on cover ring ① with screwdriver ③ or a similar tool.
- ▶ Fold tab ② down.



- ▶ Pull cover ring ① apart and remove it.
- ▶ Pull off trim panel ④.



- ▶ **i** When re-installing trim panel ④, make sure that retainer ⑤ engages in recess ⑥.

Removing the spare wheel

The spare wheel is heavy. Take particular note of this when removing the spare wheel.

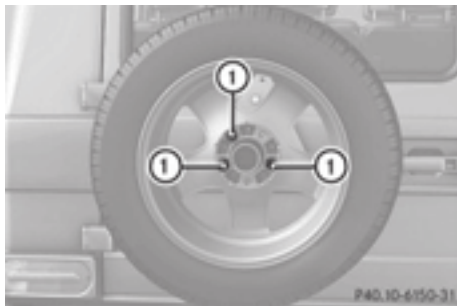

- ▶ Remove wheel nuts ①.
- ▶ Remove the spare wheel.

Mounting the wheel

After changing a wheel:

- ▶ Repair or replace the damaged wheel as soon as possible and secure the spare wheel in place again.
- ▶ Secure the damaged wheel on the spare wheel bracket with wheel nuts ①. When doing so, make sure that the wheel cannot come loose.
- ▶ When re-installing trim panel ④, make sure that retainer ⑤ engages in recess ⑥ (> page 249).
- ▶ Make sure that tab ② is below when re-installing cover ring ① (> page 249).
- ▶ For safety reasons, regularly check to ensure that the wheel is securely fastened.

Flat tire

Preparing the vehicle

- ▶ Stop the vehicle on solid, non-slippery and level ground, as far away as possible from traffic.
- ▶ Switch on the hazard warning lamps (> page 89).
- ▶ Apply the parking brake.

- ▶ Bring the front wheels into the straight-ahead position.
- ▶ Move the selector lever to position **P**.
- ▶ Switch off the engine.
- ▶ Remove the SmartKey from the ignition lock. The steering wheel lock stays active for as long as the SmartKey is removed.
- ▶ All occupants must get out of the vehicle. Make sure that they are not endangered as they do so.
- ▶ Make sure that no one is near the danger area while a wheel is being changed. Anyone who is not directly assisting in the wheel change should, for example, stand behind the barrier.
- ▶ Get out of the vehicle. Pay attention to traffic conditions when doing so.
- ▶ Close the driver's door.

Battery (vehicle)

Important safety notes

Special tools and expert knowledge are required when working on the battery, e.g. removal and installation. You should therefore have all work involving the battery carried out at a qualified specialist workshop.

WARNING

Work carried out incorrectly on the battery can lead, for example, to a short circuit and thus damage the vehicle electronics. This can lead to function restrictions applying to safety-relevant systems, e.g. the lighting system, the ABS (anti-lock braking system) or the ESP® (Electronic Stability Program). The operating safety of your vehicle may be restricted. You could lose control of the vehicle, for example:

- when braking
- in the event of abrupt steering maneuvers and/or when the vehicle's speed is not adapted to the road conditions

There is a risk of an accident.

In the event of a short circuit or a similar incident, contact a qualified specialist workshop immediately. Do not drive any further. You

should have all work involving the battery carried out at a qualified specialist workshop.

If ABS malfunctions, the wheels can lock during braking. This limits the steerability of the vehicle when braking and may increase the braking distance.

If ESP® malfunctions, the vehicle will not be stabilized if it starts to skid or a wheel starts to spin.

i For further information about ABS and ESP®, see (▷ page 55) and (▷ page 57).

WARNING

During the charging process, a battery produces hydrogen gas. If a short circuit occurs or sparks are created, the hydrogen gas can ignite. There is a risk of an explosion.

- Make sure that the positive terminal of a connected battery does not come into contact with vehicle parts.
- Never place metal objects or tools on a battery.
- It is important that you observe the described order of the battery terminals when connecting and disconnecting a battery.
- When jump-starting, make sure that the battery poles with identical polarity are connected.
- It is particularly important to observe the described order when connecting and disconnecting the jumper cables.
- Never connect or disconnect the battery terminals while the engine is running.

WARNING

Electrostatic build-up can lead to the creation of sparks, which could ignite the highly explosive gases of a battery. There is a risk of an explosion.

Before handling the battery, touch the vehicle body to remove any existing electrostatic build-up.

The highly flammable gas mixture forms when charging the battery as well as when jump-starting.

Always make sure that neither you nor the battery is electrostatically charged. A build-up of electrostatic charge can be caused, for example:

- by wearing clothing made from synthetic fibers
- due to friction between clothing and seats
- if you push or pull the battery across the carpet or other synthetic materials
- if you wipe the battery with a cloth

WARNING

Battery acid is caustic. There is a risk of injury. Avoid contact with skin, eyes or clothing. Do not inhale any battery gases. Do not lean over the battery. Keep children away from batteries. Wash away battery acid immediately with plenty of clean water and seek medical attention.

! Have the battery checked regularly at a qualified specialist workshop. Observe the service intervals in the Maintenance Booklet or contact a qualified specialist workshop for more information.

! You should have all work involving the battery carried out at a qualified specialist workshop. In the exceptional case that it is necessary for you to disconnect the battery yourself, make sure that:

- you switch off the engine and remove the SmartKey. Check that all the indicator lamps in the instrument cluster are off. Otherwise, electronic components, such as the alternator, may be damaged.
- you first remove the negative terminal clamp and then the positive terminal clamp. Never swap the terminal clamps. Otherwise, the vehicle's electronic system may be damaged.
- on vehicles with automatic transmission, the transmission is locked in position **P** after disconnecting the battery. The vehicle is secured against rolling away. You can then no longer move the vehicle.

The battery and the cover of the positive terminal clamp must be installed securely during operation.

Environmental note



Batteries contain dangerous substances. It is against the law to dispose of them with the household rubbish. They must be collected separately and recycled to protect the environment.



Dispose of batteries in an environmentally friendly manner. Take discharged batteries to a qualified specialist workshop or a special collection point for used batteries.

In order for the battery to achieve the maximum possible service life, it must always be sufficiently charged.

Comply with safety precautions and take protective measures when handling batteries.



Risk of explosion.



Fire, open flames and smoking are prohibited when handling the battery. Avoid creating sparks.



Battery acid is caustic. Avoid contact with skin, eyes or clothing.



Wear eye protection.



Keep children away.



Observe this Operator's Manual.

The vehicle battery, like other batteries, can discharge over time if you do not use the vehicle. In this case, have the battery disconnected at a qualified specialist workshop. You can also charge the battery with a charger recommended

by Mercedes-Benz. Contact a qualified specialist workshop for further information.

For safety reasons, Mercedes-Benz recommends that you only use batteries which have been tested and approved for your vehicle by Mercedes-Benz. These batteries provide increased impact protection to prevent vehicle occupants from suffering acid burns should the battery be damaged in the event of an accident. Have the battery condition of charge checked more frequently if you use the vehicle mainly for short trips or if you leave it standing idle for a lengthy period. Consult a qualified specialist workshop if you wish to leave your vehicle parked for a long period of time.

i Remove the SmartKey if you park the vehicle and do not require any electrical consumers. The vehicle will then use very little energy, thus conserving battery power.

i If the power supply has been interrupted, e.g. due to a discharged battery, you will have to:

- set the clock. Information on setting the clock can be found in the separate operating instructions.
- On vehicles with COMAND and a navigation system, the clock is set automatically.
- reset the head restraints on the front seats (> page 75)
- reset the function for folding the exterior mirrors in/out automatically, by folding the mirrors out once (> page 81).

Charging the battery

⚠ WARNING

During charging and jump-starting, explosive gases can escape from the battery. There is a risk of an explosion.

Particularly avoid fire, open flames, creating sparks and smoking. Ensure there is sufficient ventilation while charging and jump-starting. Do not lean over a battery.

⚠ WARNING



Battery acid is caustic. There is a risk of injury. Avoid contact with skin, eyes or clothing. Do not inhale any battery gases. Do not lean over

the battery. Keep children away from batteries. Wash away battery acid immediately with plenty of clean water and seek medical attention.

 **WARNING**

A discharged battery can freeze at temperatures below freezing point. When jump-starting the vehicle or charging the battery, gases can escape from the battery. There is a risk of an explosion.

Allow the frozen battery to thaw out before charging it or jump-starting.

-  Only charge the battery using the jump-starting connection point.
-  Only use battery chargers with a maximum charging voltage of 14.8 V.
-  Only charge the installed battery with a battery charger which has been tested and approved by Mercedes-Benz. These battery chargers allow the battery to be charged while still installed in the vehicle.

If, at low temperatures, the indicator lamps/warning lamps in the instrument cluster do not light up, it is highly likely that the discharged battery has frozen. In this case you may neither jump-start the vehicle nor charge the battery. The service life of a thawed-out battery may be shorter. The starting characteristics can be impaired, particularly at low temperatures. Have the thawed-out battery checked at a qualified specialist workshop.

A battery charger unit specially adapted for Mercedes-Benz vehicles and tested and approved by Mercedes-Benz is available as an accessory. Contact an authorized Mercedes-Benz Center for information and availability. Charge the battery in accordance with the operating instructions for the battery charger.

The jump-starting connection point is in the engine compartment (▷ page 254).

- ▶ Read the operating instructions for the battery charger.
- ▶ Open the hood (▷ page 236).
- ▶ Connect the battery charger to the positive terminal and ground point in the same order as when connecting the donor battery in the jump-starting procedure (▷ page 254).

Jump-starting

For the jump-starting procedure, use only the jump-starting connection point, consisting of a positive terminal and a ground point, in the engine compartment.

WARNING

Battery acid is caustic. There is a risk of injury.

Avoid contact with skin, eyes or clothing. Do not inhale any battery gases. Do not lean over the battery. Keep children away from batteries. Wash away battery acid immediately with plenty of clean water and seek medical attention.

WARNING

During charging and jump-starting, explosive gases can escape from the battery. There is a risk of an explosion.

Particularly avoid fire, open flames, creating sparks and smoking. Ensure there is sufficient ventilation while charging and jump-starting. Do not lean over a battery.

WARNING

During the charging process, a battery produces hydrogen gas. If a short circuit occurs or sparks are created, the hydrogen gas can ignite. There is a risk of an explosion.

- Make sure that the positive terminal of a connected battery does not come into contact with vehicle parts.
- Never place metal objects or tools on a battery.
- It is important that you observe the described order of the battery terminals when connecting and disconnecting a battery.
- When jump-starting, make sure that the battery poles with identical polarity are connected.
- It is particularly important to observe the described order when connecting and disconnecting the jumper cables.
- Never connect or disconnect the battery terminals while the engine is running.

WARNING

A discharged battery can freeze at temperatures below freezing point. When jump-starting the vehicle or charging the battery, gases can escape from the battery. There is a risk of an explosion.

Allow the frozen battery to thaw out before charging it or jump-starting.

! **Vehicles with a gasoline engine:** avoid repeated and lengthy starting attempts. Otherwise, the catalytic converter could be damaged by non-combusted fuel.

If, at low temperatures, the indicator lamps/warning lamps in the instrument cluster do not light up, it is highly likely that the discharged battery has frozen. In this case you may neither jump-start the vehicle nor charge the battery.

Once the battery has thawed out, its service life may be dramatically reduced.

The starting characteristics can be impaired, particularly at low temperatures.

Have the thawed-out battery checked at a qualified specialist workshop.

Do not start the vehicle using a rapid charging device. If your vehicle's battery is discharged, the engine can be jump-started from another vehicle or from a second battery using jumper cables. Observe the following points:

- The battery is not accessible in all vehicles. If the other vehicle's battery is not accessible, jump-start the vehicle using a second battery or a jump-starting device.
- **Vehicles with a gasoline engine:** only jump-start the vehicle when the engine and exhaust system are cold.
- Do not start the engine if the battery is frozen. Let the battery thaw first.
- Jump-starting may only be performed from batteries with a nominal voltage of 12 V.
- Only use jumper cables which have a sufficient cross-section and insulated terminal clamps.
- If the battery is fully discharged, leave the battery that is being used to jump-start connected for a few minutes before attempting to start. This charges the battery slightly.
- Make sure that the two vehicles do not touch.

Make sure that:

- the jumper cables are not damaged.
 - when the jumper cables are connected to the battery, uninsulated sections of the terminal clamp do not come into contact with other metal sections.
 - the jumper cables cannot come into contact with parts such as the pulley or the fan. These parts move when the engine is started and while it is running.
- ▶ Apply the parking brake.
- ▶ Move the selector lever to position **P**.
- ▶ Switch off all electrical consumers (e.g. radio, blower, etc.).
- ▶ Open the hood (▷ page 236).

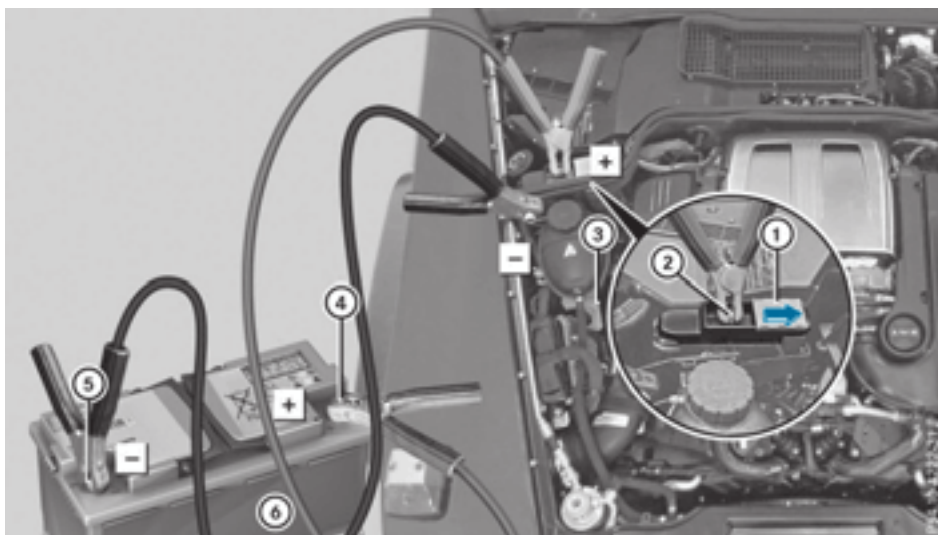

Position number ⑥ identifies the charged battery of the other vehicle or an equivalent jump-starting device.

The jump-starting connection point consists of poles ② and ③.

- ▶ Lift up cover ① of positive terminal ② in the direction of the arrow.
- ▶ Connect positive terminal ② on your vehicle to positive terminal ④ of donor battery ⑥ using the jumper cable, beginning with your own battery.
- ▶ Start the engine of the donor vehicle and run it at idling speed.
- ▶ Connect negative terminal ⑤ of donor battery ⑥ to ground point ③ of your vehicle using the jumper cable, connecting the jumper cable to donor battery ⑥ first.
- ▶ Start the engine.
- ▶ First, remove the jumper cables from ground point ③ and negative terminal ⑤, then from positive clamp ② and positive terminal ④. Each time beginning with your vehicle's battery.
- ▶ Have the battery checked at a qualified specialist workshop.

i Jump-starting is not considered to be a normal operating condition.

i Jumper cables and further information regarding jump-starting can be obtained at any qualified specialist workshop.

Towing and tow-starting

Important safety notes

WARNING

Functions relevant to safety are restricted or no longer available if:

- the engine is not running.
- the brake system or the power steering is malfunctioning.
- there is a malfunction in the voltage supply or the vehicle's electrical system.

If your vehicle is being towed, much more force may be necessary to steer or brake. There is a risk of an accident.

In such cases, use a tow bar. Before towing, make sure that the steering moves freely.

WARNING

When towing or tow-starting another vehicle and its weight is greater than the permissible gross weight of your vehicle, the:

- the towing eye could detach itself
- the vehicle/trailer combination could roll-over.

There is a risk of an accident.

When towing or tow-starting another vehicle, its weight should not be greater than the permissible gross weight of your vehicle.

! If DISTRONIC PLUS or the HOLD function is activated, the vehicle brakes automatically in certain situations. To prevent damage to the vehicle, deactivate DISTRONIC PLUS and the HOLD function in the following or other similar situations:

- when towing the vehicle
- in the car wash

! The vehicle can be towed a maximum of 30 miles (50km). The towing speed of 30 mph (50 km/h) must not be exceeded.

If the vehicle has to be towed more than 30 miles (50km), the entire vehicle must be raised and transported.

! Only secure the tow cable or tow bar to the towing eyes. You could otherwise damage the vehicle.

! Do not tow with sling-type equipment. This could damage the vehicle.

! Do not use the towing eyes for recovery purposes as this could damage the vehicle. If in doubt, recover the vehicle with a crane.

! When towing, pull away slowly and smoothly. If the tractive power is too high, the vehicles could be damaged.

! Your vehicles is equipped with an automatic transmission. Therefore, you must not have the vehicle tow-started. The transmission may otherwise be damaged.

i Details on the permissible gross vehicle weight of your vehicle can be found on the vehicle identification plate (▷ page 288).

It is better to have the vehicle transported than to have it towed away.

If the transfer case can be shifted into neutral **N**, you can tow the vehicle.

If the transfer case cannot be shifted into neutral **N**, you can tow the vehicle with one axle raised. Please bear the following in mind:

- remove the propeller shaft between the transfer case and the rolling axle.
- turn the SmartKey to position **1** in the ignition lock (▷ page 112).

The battery must be connected and charged. Otherwise, you:

- cannot turn the SmartKey to position **2** in the ignition lock (▷ page 112).
- cannot shift the automatic transmission to position **N**.

i Disarm the automatic locking feature before the vehicle is towed (▷ page 66). You could otherwise be locked out when pushing or towing the vehicle.

Towing eyes

Towing eyes, front



① Towing eyes, front

Towing eye, rear

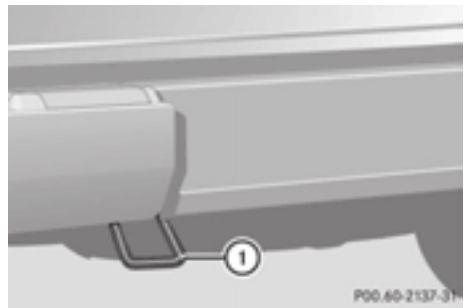

Rear towing eye ① is located under the bumper, on the left-hand side when viewed in the direction of travel.

Towing a vehicle with both axles on the ground

It is important that you observe the safety instructions when towing away your vehicle (▷ page 256).

▶ Switch on the hazard warning lamps (▷ page 89).

i In order to signal a change of direction when towing the vehicle with the hazard warning lamps switched on, use the combination switch as usual. In this case, only the indicator lamps for the direction of travel flash. After resetting the combination switch, the hazard warning lamp starts flashing again.

▶ Turn the SmartKey to position **2** in the ignition lock (▷ page 112).

▶ When the vehicle is stationary, depress the brake pedal and keep it depressed.

▶ Shift the transfer case to neutral position **N** (▷ page 163).

▶ Shift the automatic transmission to position **N**.

▶ Release the brake pedal.

▶ Release the parking brake (▷ page 131).

i The transmission can only change gear if the battery has sufficient charge.

If you cannot move the selector lever to **N**, the propeller shafts to the driven axles must be removed.

Transporting the vehicle

4MATIC vehicles/vehicles with automatic transmission

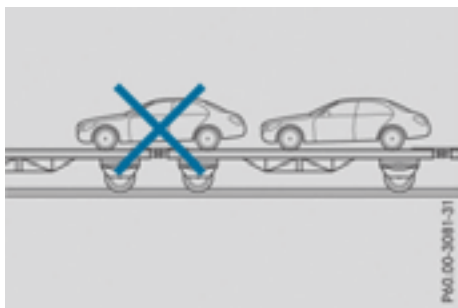

- ❗ When the vehicle is loaded for transport, the front and rear axles must be stationary and on the same transportation vehicle. Positioning over the connection point of the transport vehicle is not permitted. The drive train may otherwise be damaged.

All vehicles

- ❗ You may only secure the vehicle by the wheels, not by parts of the vehicle such as axle or steering components. Otherwise, the vehicle could be damaged.

Use the towing eyes to pull the vehicle if it needs to be transported on a trailer or transporter (▷ page 257).

- ▶ Apply the parking brake.
- ▶ Turn the SmartKey to position **2** in the ignition lock (▷ page 112).
- ▶ Shift the selector lever to **N**.
- ▶ Shift the transfer case to **neutral** (▷ page 163).
- ▶ Secure the towing cable to the towing eyes (▷ page 257).
- ▶ Make sure that the vehicle cannot roll away.
- ▶ Release the parking brake.
- ▶ Load the vehicle onto the transporter.

As soon as the vehicle has been loaded:

- ▶ Apply the parking brake.
- ▶ Shift the automatic transmission to position **P**.

- ▶ Turn the SmartKey to position **0** in the ignition lock (▷ page 112) and remove it.
- ▶ Secure the vehicle.

Recovering a vehicle that has become stuck

- ❗ When recovering a vehicle that has become stuck, pull it as smoothly and evenly as possible. Excessive tractive power could damage the vehicles.

If the drive wheels have become stuck in loose or muddy ground, pull the vehicle out with extreme caution, especially so if the vehicle is loaded.

Never attempt to recover a stuck vehicle with a trailer attached.

Pull out the vehicle backwards, if possible using the tracks it made when it became stuck.

Towing in the event of malfunctions

General notes

- ❗ If you are removing the propeller shaft, use M10 nuts as spacers on the M8 bolts and secure them with M8 nuts.

New self-locking nuts must be used when the propeller shafts are refitted.

- ▶ Observe the safety notes as you do so (▷ page 256).

- ℹ Consult an authorized Mercedes-Benz Center.

Engine damage, gear damage or electrical malfunctions

- ▶ Move the selector lever to position **N** (▷ page 119).
- ▶ Shift the transfer case to **neutral** (▷ page 163).

In the event of damage to the transfer case

Have the propeller shafts between the axles and the transfer case removed.

In the event of damage to the front axle

Have the propeller shaft between the rear axle and the transfer case removed.

Have the vehicle towed with the front axle raised.

In the event of damage to the rear axle

Have the propeller shaft between the front axle and the transfer case removed.

Have the vehicle towed with the rear axle raised and with wheel rollers under the front axle.

Tow-starting (emergency engine starting)

! Vehicles with automatic transmission must not be tow-started. You could otherwise damage the automatic transmission.

You can find information on "Jump-starting" under (▷ page 254).

Fuses

Important safety notes

WARNING

If you manipulate or bridge a faulty fuse or if you replace it with a fuse with a higher amperage, the electric cables could be overloaded. This could result in a fire. There is a risk of an accident and injury.

Always replace faulty fuses with the specified new fuses having the correct amperage.

! Only use fuses that have been approved for Mercedes-Benz vehicles and which have the correct fuse rating for the system concerned. Otherwise, components or systems could be damaged.

The fuses in your vehicle serve to close down faulty circuits. If a fuse blows, all the components on the circuit and their functions stop operating.

Blown fuses must be replaced with fuses of the same rating, which you can recognize by the color and value. The fuse ratings are listed in the fuse allocation chart.

i If a fuse has blown, contact a breakdown service or an authorized Mercedes-Benz Center.

If a newly inserted fuse also blows, have the cause traced and rectified at a qualified specialist workshop, e.g. an authorized Mercedes-Benz Center.

Before changing a fuse

- ▶ Park the vehicle and apply the parking brake.
- ▶ Switch off all electrical consumers.
- ▶ Remove the SmartKey from the ignition lock. All indicator lamps in the instrument cluster must be off.

The fuses are located in various fuse boxes:

- Main fuse box on the driver's side of the dashboard
- Fuse box in the front-passenger footwell
- Fuse box in the transmission tunnel
- Fuse box in the battery case
- Fuse box in the cargo compartment

The fuse allocation chart and the spare fuses are in the main fuse box on the dashboard (▷ page 259).

You will find the fuse removal device in the vehicle tool kit (▷ page 248).

Dashboard fuse box

! Do not use a pointed object such as a screwdriver to open the cover in the dashboard. You could damage the dashboard or the cover.

! Make sure that no moisture can enter the fuse box when the cover is open.

! When closing the cover, make sure that it is lying correctly on the fuse box. Moisture seeping in or dirt could otherwise impair the operation of the fuses.



- ▶ Open the front-passenger door.
- ▶ **To open:** pull cover ① outwards in the direction of the arrow and remove it.
- ▶ **To close:** clip in cover ① on the front of the dashboard.
- ▶ Fold cover ① inwards until it engages.

Fuse box in the front-passenger footwell

- ⚠ Make sure that no moisture can enter the fuse box when the cover is open.
- ⚠ When closing the cover, make sure that it is lying correctly on the fuse box. Moisture seeping in or dirt could otherwise impair the operation of the fuses.

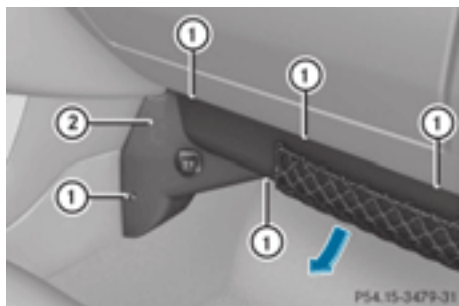

- ▶ Unscrew screws ①.
- ▶ Lift up cover ② in the direction of the arrow.

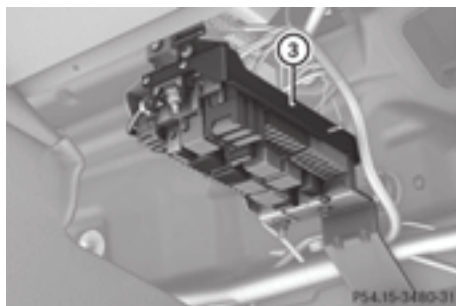

- ③ Fuse box

Fuse box in the transmission tunnel

- ⚠ Make sure that no moisture can enter the fuse box when the cover is open.
- ⚠ When closing the cover, make sure that it is lying correctly on the fuse box. Moisture seeping in or dirt could otherwise impair the operation of the fuses.

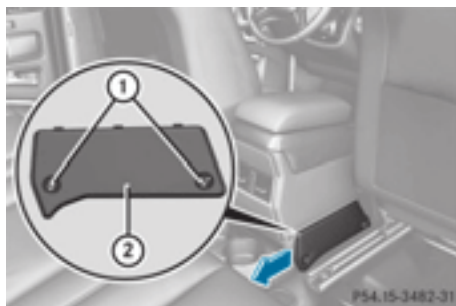

- ▶ Fold down the cup holder on the center console (> page 220).
- ▶ Adjust the front-passenger seat to its foremost position (> page 74).
- ▶ **To open:** remove screws ①.
- ▶ Remove cover ② in the direction of the arrow.
- ▶ **To close:** clip in cover ②.
- ▶ Install cover ② with screws ①.

Fuse box in the battery case

The fuses in the battery case do not usually need to be replaced. If a fuse change is necessary, consult a qualified specialist workshop.

Fuse box in the cargo compartment

- ❗ Make sure that no moisture can enter the fuse box when the cover is open.
- ❗ When closing the cover, make sure that it is lying correctly on the fuse box. Moisture seeping in or dirt could otherwise impair the operation of the fuses.



- ▶ Open the rear door.
- ▶ **To open:** pull cover ① in the direction of the arrow and remove it.

Useful information

- i** This Operator's Manual describes all models and all standard and optional equipment of your vehicle available at the time of publication of the Operator's Manual. Country-specific differences are possible. Please note that your vehicle may not be equipped with all features described. This also applies to safety-related systems and functions.
- i** Read the information on qualified specialist workshops: (▷ page 23).

Important safety notes

WARNING

If wheels and tires of the wrong size are used, the wheel brakes or suspension components may be damaged. There is a risk of an accident.

Always replace wheels and tires with those that fulfill the specifications of the original part.

When replacing wheels, make sure to use the correct:

- designation
- model

When replacing tires, make sure to use the correct:

- designation
- manufacturer
- model

Warning

A flat tire severely impairs the driving, steering and braking characteristics of the vehicle. There is a risk of an accident.

do not drive with a flat tire. Immediately replace the flat tire with your spare wheel, or consult a qualified specialist workshop.

Contact an authorized Mercedes-Benz Center if you require information on tested and recommended wheels and tires for summer and winter driving. Advice on purchasing and caring for tires is also available there.

Accessories that are not approved for your vehicle by Mercedes-Benz or are not being used correctly can impair the operating safety.

Before purchasing and using non-approved accessories, visit a qualified specialist workshop and ask about:

- suitability
- legal stipulations
- factory recommendations

Information on the dimensions and types of wheels and tires for your vehicle can be found in the "Wheel/tire combinations" section (▷ page 284).

Information on air pressure for the tires on your vehicle can be found:

- on the tire pressure label on the fuel filler flap
- in the "Tire pressure" section

i Further information on wheels and tires can be obtained at any qualified specialist workshop.

Operation

Notes on driving

If the vehicle is heavily loaded, check the tire pressures and correct them if necessary.

When parking your vehicle, make sure that the tires do not get deformed by the curb or other obstacles. If it is necessary to drive over curbs, speed humps or similar elevations, try to do so slowly and at an obtuse angle. Otherwise, the tires, particularly the sidewalls, may be damaged.

Regular checking of wheels and tires

WARNING

Damaged tires can cause tire inflation pressure loss. As a result, you could lose control of your vehicle. There is a risk of accident.

Check the tires regularly for signs of damage and replace any damaged tires immediately.

- Regularly check the wheels and tires of your vehicle for damage at least once a month, as well as after driving off-road or on rough roads. Damage includes bulges and deformation on tires, cuts, punctures, cracks or

severe corrosion on wheels, for example. Damaged wheels can cause a loss of tire pressure.

- Regularly check the tire tread depth and the condition of the tread across the whole width of the tire (▷ page 263). In order to inspect the inner side of the tire surface, turn the steering wheel to full lock.
- All wheels must have a valve cap to protect the valve against dirt and moisture. Do not install anything onto the valve other than the standard valve cap or a valve cap approved by Mercedes-Benz for your vehicle. Do not install anything onto the valve, such as tire pressure monitoring systems.
- You should regularly check the pressure of all your tires including the spare wheel, particularly prior to long trips. Adjust the tire pressure as necessary (▷ page 270).

The service life of tires depends, among other things, on the following factors:

- Driving style
- Tire pressure
- Distance covered

Tire tread

WARNING

Insufficient tire tread will reduce tire traction. The tire is no longer able to dissipate water. This means that on wet road surfaces, the risk of hydroplaning increases, in particular where speed is not adapted to suit the driving conditions. There is a risk of accident.

If the tire pressure is too high or too low, tires may exhibit different levels of wear at different locations on the tire tread. Thus, you should regularly check the tread depth and the condition of the tread across the entire width of all tires.

Minimum tire tread depth for:

- Summer tires: $\frac{1}{8}$ in (3 mm)
- M+S tires: $\frac{1}{6}$ in (4 mm)

For safety reasons, replace the tires before the legally prescribed limit for the minimum tire tread depth is reached.

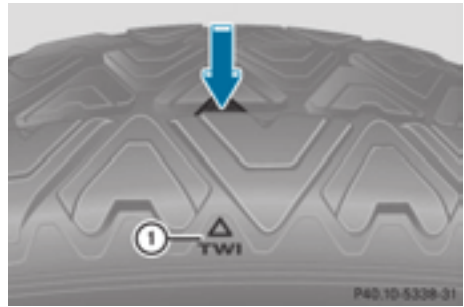

Marking ① shows the tread wear indicator (TWI). The arrow indicates the placement of the tire tread.

Do not drive with tires which have too little tread depth. Tire traction on wet road surfaces decreases significantly when the tread depth is less than $\frac{1}{8}$ in (3 mm).

Treadwear indicators (TWI) are required by law. Six indicators are positioned over the tire tread. They are visible once the tread depth is approximately $\frac{1}{16}$ in (1.6 mm). If this is the case, the tire is so worn that it must be replaced.

The recommended tread depth for summer tires is at least $\frac{1}{8}$ in (3 mm). The recommended tread depth for winter tires is at least $\frac{1}{6}$ in (4 mm).

Selecting, mounting and replacing tires

- Only mount tires and wheels of the same type and make.
- Only mount approved tires of the correct size onto the wheels.
- Tires are supplied with a protective layer from the factory. Break in new tires at moderate speeds for the first 60 miles (100 km). They only reach their full performance after this distance.
- Do not drive with tires which have too little tread depth, as this significantly reduces the traction on wet roads (hydroplaning).
- Replace the tires after six years at the latest, regardless of wear. This also applies to the spare wheel.

Winter operation

General notes

Have your vehicle winterproofed at a qualified specialist workshop at the onset of winter. Observe the notes in the "Changing a wheel" section (▷ page 281).

Driving with summer tires

At temperatures below 45 °F (+7 °C), summer tires lose elasticity and therefore traction and braking power. Change the tires on your vehicle to M+S tires. Using summer tires at very cold temperatures could cause cracks to form, thereby damaging the tires permanently. Mercedes-Benz cannot accept responsibility for this type of damage.

M+S tires

WARNING

M+S tires with a tire tread depth of less than $\frac{1}{8}$ in (4 mm) are not suitable for use in winter and do not provide sufficient traction. There is a risk of an accident.

M+S tires with a tread depth of less than $\frac{1}{8}$ in (4 mm) must be replaced immediately.

WARNING

Wheel and tire dimensions as well as the type of tire can vary between the spare wheel and the wheel to be replaced. When the spare wheel is mounted, driving characteristics may be severely affected. There is a risk of an accident.

In order to reduce risks:

- you should therefore adapt your driving style and drive carefully.
- never mount more than one spare wheel that differs from the wheel to be replaced.
- only use a spare wheel that differs from the wheel to be replaced for a short time.
- do not deactivate ESP®.
- have a spare wheel that differs from the wheel that has been changed replaced at

the nearest qualified specialist workshop. You must observe the correct wheel and tire dimensions as well as the wheel type.

Do not exceed a maximum speed of 50 mph (80 km/h) if a spare wheel of a different size is installed.

At temperatures below 45 °F (+7 °C), use all-season tires or winter tires. Both types of tire are identified by the M+S marking.

Not all tires with the M+S marking provide the driving characteristics of winter tires. In addition to the M+S marking, winter tires also have the  snowflake symbol on the tire wall. Tires with this marking fulfill the requirements of the Rubber Manufacturers Association (RMA) and the Rubber Association of Canada (RAC) regarding snow traction, and were specially developed for driving on snow. Only these tires will allow driving safety systems such as ABS and ESP® to function optimally in winter, since these tires have been designed specifically for driving on snow.

Use M+S tires of the same make and tread on all wheels to maintain safe handling characteristics.

Always observe the maximum permissible speed specified for the M+S tires you have mounted.

When you have mounted the M+S tires:

- ▶ Check the tire pressures (▷ page 265).
- ▶ Restart the tire pressure monitor (▷ page 270).

 You can obtain information about winter tires that have been approved by Mercedes-Benz especially for your vehicle at any Mercedes-Benz Service center.

 For further information about tires, see (▷ page 286).

Snow chains

WARNING

If you drive too fast with snow chains mounted, they may snap. As a result, you could injure others and damage the vehicle. There is a risk of an accident.

Observe the maximum permissible speed for operation with snow chains.

! Information about the use of snow chain compatible AMG winter tires is applicable for AMG tires. Use of snow chains is only permissible with these tires.

! On some tire sizes there is not enough space for snow chains. To avoid damage to the vehicle or tires, observe the "Wheel and tire combinations" section under "Tires and wheels".

! Check the snow chains for damage before mounting them. Damaged or worn snow chains may snap and damage the following components:

- wheel
- wheel housing
- wheel suspension

For this reason, you must use only snow chains that are free of defects. Observe the manufacturer's mounting instructions.

For safety reasons, Mercedes-Benz recommends that you only use snow chains that have been specially approved for your vehicle by Mercedes-Benz, or are of a corresponding standard of quality.

- Only use snow chains when driving on roads completely covered by snow. Remove the snow chains as soon as possible when you come to a road that is not snow-covered.
- Local regulations may restrict the use of snow chains. Observe the appropriate regulations if you wish to mount snow chains.
- Do not exceed the maximum permissible speed of 30 mph (50 km/h).

If you intend to mount snow chains, please bear the following points in mind:

- Snow chains cannot be mounted on all wheel/tire combinations (> page 284).
- Mount snow chains only in pairs and only on the rear wheels. Observe the manufacturer's mounting instructions.

i You may wish to deactivate ESP® when pulling away with snow chains installed (> page 57). You can thereby allow the wheels to spin in a controlled manner, achieving an increased driving force (cutting action).

For more information, contact a qualified specialist workshop.

Tire pressure

Tire pressure specifications

Important safety notes

WARNING

Underinflated or overinflated tires pose the following risks:

- the tires may burst, especially as the load and vehicle speed increase.
- the tires may wear excessively and/or unevenly, which may greatly impair tire traction.
- the driving characteristics, as well as steering and braking, may be greatly impaired.

There is a risk of an accident.

Follow recommended tire inflation pressures and check the pressure of all the tires including the spare wheel:

- monthly, at least
- if the load changes
- before beginning a long journey
- under different operating conditions, e.g. off-road driving

If necessary, correct the tire pressure.

i The specifications on the sample Tire and Loading Information placard and tire pressure tables are examples. Tire pressure specifications are vehicle-specific and may deviate from the data shown here. The tire pressure specifications that are valid for your vehicle can be found on the Tire and Loading Information placard and tire pressure table on the vehicle.

General notes

The recommended tire pressures for the tires mounted at the factory can be found on the labels described here.

Operation with a trailer: the applicable value for the rear tires is the maximum tire pressure value stated in the table inside the fuel filler flap. Further information on tire pressures can be obtained at a qualified specialist workshop.

Tire and Loading Information placard

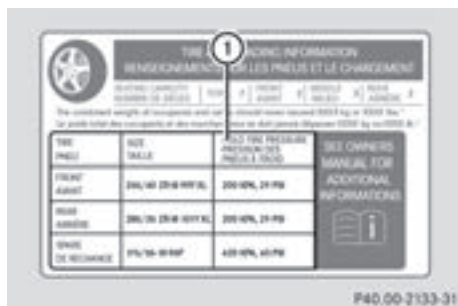

① Recommended tire pressures

The Tire and Loading Information placard is on the B-pillar on the driver's side (▷ page 271). The Tire and Loading Information placard contains the recommended tire pressures for cold tires. The recommended tire pressures are valid for the maximum permissible load and up to the maximum permissible vehicle speed.

Tire pressure table



Example: tire pressure table for all tires permitted for this vehicle by the factory

The tire pressure table is on the inside of the fuel filler flap.

The tire pressure table contains the recommended pressures for cold tires for various operating conditions, i.e. differing load and speed conditions.

If a tire size precedes a tire pressure, the tire pressure information following is only valid for that tire size. The load conditions "partially laden" and "fully laden" are defined in the table for different numbers of occupants and amounts of luggage. The actual number of seats may differ.

Some tire pressure tables only show the rim diameter instead of the complete tire size, e.g. **R16**. Rim diameter is part of the tire size and can be found on the tire sidewall (▷ page 276).

If the tire pressures have been set to the lower values for lighter loads and/or lower road speeds, the pressures should be reset to the higher values:

- if you want to drive with an increased load and/or
- if you want to drive at higher road speeds

① The tire pressures for increased loads and/or higher road speeds, shown in the tire pressure table, may have a negative effect on driving comfort.

If the tire pressure is not set correctly, this can lead to an excessive build-up of heat and a sudden loss of pressure.

For more information, contact a qualified specialist workshop.

Important notes on tire pressure

⚠ WARNING

If the tire pressure drops repeatedly, the wheel, valve or tire may be damaged. Tire pressure that is too low may result in a tire blow-out. There is a risk of an accident.

- Check the tire for foreign objects.
- Check whether the wheel is losing air or the valve is leaking.

If you are unable to rectify the damage, contact a qualified specialist workshop.

⚠ WARNING

If you fit unsuitable accessories onto tire valves, the tire valves may be overloaded and malfunction, which can cause tire pressure loss. Due to their design, retrofitted tire pressure monitors keep the tire valve open. This can also result in tire pressure loss. There is a risk of an accident.

Only screw the standard valve cap or other valve caps approved by Mercedes-Benz for your vehicle onto the tire valve.

Use a suitable pressure gauge to check the tire pressure. The outer appearance of a tire does not permit any reliable conclusion about the tire pressure. On vehicles equipped with the electronic tire pressure monitoring system, the tire pressure can be checked using the on-board computer.

The tire temperature and pressure increase when the vehicle is in motion. This is dependent on the driving speed and the load.

Therefore, you should only correct tire pressures when the tires are cold.

The tires are cold:

- if the vehicle has been parked without direct sunlight on the tires for at least three hours and
- if the vehicle has been driven for less than 1 mile (1.6 km).

The tire temperature changes depending on the outside temperature, the vehicle speed and the tire load. If the tire temperature changes by 18 °F (10 °C), the tire pressure changes by approximately 10 kPa (0.1 bar/1.5 psi). Take this into account when checking the pressure of warm tires. Only correct the tire pressure if it is too low for the current operating conditions. If you check the tire pressure when the tires are warm, the resulting value will be higher than if the tires were cold. This is normal. Do not reduce the tire pressure to the value specified for cold tires. The tire pressure would otherwise be too low.

Observe the recommended tire pressures for cold tires:

- on the Tire and Loading Information placard on the B-pillar on the driver's side
- in the tire pressure table on the inside of the fuel filler flap

Observe the following for the tire pressure on the spare wheel:

- the tire and loading information table on the B-pillar on the driver's side.
- the tire pressure sticker on the inside of the fuel filler flap.

Underinflated or overinflated tires

Underinflation

WARNING

Tires with pressure that is too low can overheat and burst as a consequence. In addition, they also suffer from excessive and/or irregular wear, which can severely impair the braking properties and the driving characteristics. There is a risk of an accident.

Avoid tire pressures that are too low in all the tires, including the spare wheel.

Underinflated tires may:

- overheat, leading to tire defects
- have an adverse effect on handling characteristics
- wear quickly and unevenly
- have an adverse effect on fuel consumption

Overinflation

WARNING

Tires with excessively high pressure can burst because they are damaged more easily by road debris, potholes etc. In addition, they also suffer from irregular wear, which can severely impair the braking properties and the driving characteristics. There is a risk of an accident.

Avoid tire pressures that are too high in all the tires, including the spare wheel.

Overinflated tires may:

- increase the braking distance
- have an adverse effect on handling characteristics
- wear quickly and unevenly
- have an adverse effect on ride comfort
- be more susceptible to damage

Maximum tire pressures

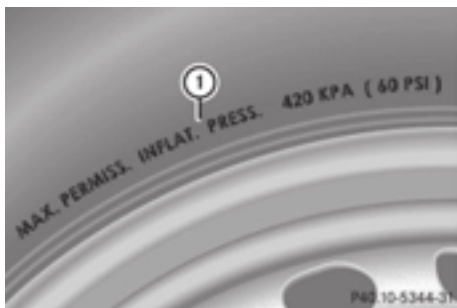

- ① Example: maximum permissible tire pressure

Never exceed the maximum permissible tire inflation pressure. Always observe the recommended tire pressure for your vehicle when adjusting the tire pressure (▷ page 279).

- ❗ The actual values for tires are vehicle-specific and may deviate from the values in the illustration.

Checking the tire pressures

Important safety notes

Observe the notes on tire pressure (▷ page 265).

Information on air pressure for the tires on your vehicle can be found:

- on the tire pressure label on the fuel filler flap (▷ page 266)
- in the "Tire pressure data" section (▷ page 265)

Checking tire pressures manually

To determine and set the correct tire pressure, proceed as follows:

- ▶ Remove the valve cap of the tire that is to be checked.
- ▶ Press the tire pressure gauge securely onto the valve.
- ▶ Read the tire pressure and compare it to the recommended value on the Tire and Loading Information placard on fuel filler flap of your vehicle (▷ page 266).
- ▶ **The tire pressure is too low:** increase the tire pressure to the recommended value.

- ▶ **The tire pressure is too high:** press down the metal pin in the valve using the tip of a pen, for example.
Air is released from the tire.
- ▶ Check the tire pressure again with the tire pressure gauge.
- ▶ Screw the valve cap onto the valve.
- ▶ Repeat these steps for the other tires.

Tire pressure monitor

Important safety notes

⚠ WARNING

Each tire, including the spare (if provided), should be checked at least once a month when cold and inflated to the pressure recommended by the vehicle manufacturer on the Tire and Loading Information placard on the driver's door B-pillar or the tire pressure label on the inside of the fuel filler flap. If your vehicle has tires of a different size than the size indicated on the Tire and Loading Information placard or the tire pressure label, you should determine the proper tire pressure for those tires.

As an added safety feature, your vehicle has been equipped with a tire pressure monitoring system (TPMS) that illuminates a low tire pressure telltale when one or more of your tires are significantly underinflated. Accordingly, when the low tire pressure telltale illuminates, you should stop and check your tires as soon as possible, and inflate them to the proper pressure. Driving on a significantly underinflated tire causes the tire to overheat and can lead to tire failure. Underinflation also reduces fuel efficiency and tire tread life, and may affect the vehicle's handling and stopping ability.

Please note that the TPMS is not a substitute for proper tire maintenance, and it is the driver's responsibility to maintain correct tire pressure, even if underinflation has not reached the level to trigger illumination of the TPMS low tire pressure telltale.

USA only:

Your vehicle has also been equipped with a TPMS malfunction indicator to indicate if the system is not operating properly. The TPMS malfunction indicator is combined with the low tire pressure telltale. When the system detects a malfunction, the warning lamp will flash for approximately a minute and then remain continuously illuminated. This sequence will be repeated every time the vehicle is started as long as the malfunction exists.

When the malfunction indicator is illuminated, the system may not be able to detect or signal low tire pressure as intended. TPMS malfunctions may occur for a variety of reasons, including the mounting of incompatible replacement or alternate tires or wheels on the vehicle that prevent the TPMS from functioning properly. Always check the TPMS malfunction telltale after replacing one or more tires or wheels on your vehicle to ensure that the replacement or alternate tires and wheels allow the TPMS to continue to function properly.

It is the driver's responsibility to set the tire pressure to the recommended cold tire pressure suitable for the operating situation (▷ page 265). Note that the correct tire pressure for the current operating situation must first be taught-in to the tire pressure monitor. If there is a substantial loss of pressure, the warning threshold for the warning message is aligned to the reference values taught-in. Restart the tire pressure monitor after adjusting to the cold tire pressure (▷ page 270). The current pressures are saved as new reference values. As a result, a warning message will appear if the tire pressure drops significantly.

The tire pressure monitor does not warn you of an incorrectly set tire pressure. Observe the notes on the recommended tire pressure (▷ page 265).

The tire pressure monitor is not able to warn you of a sudden loss of pressure, e.g. if the tire is penetrated by a foreign object. In the event of a sudden loss of pressure, bring the vehicle to a halt by braking carefully. Avoid sudden steering movements.

In order to check the tire pressure, the vehicle's wheels are installed with sensors that monitor

the tire pressure in all four tires. The tire pressure monitor warns you if the pressure drops in one or more of the tires. The tire pressure monitor only functions if the correct sensors are installed on all wheels.

The tire pressure monitor has a yellow warning lamp in the instrument cluster for indicating pressure loss/malfunctions (USA) or pressure loss (Canada). Whether the warning lamp flashes or lights up indicates whether a tire pressure is too low or the tire pressure monitor is malfunctioning:

- if the warning lamp is lit continuously, the tire pressure on one or more tires is significantly too low. The tire pressure monitor is not malfunctioning.
- USA only: if the warning lamp flashes for around a minute and then remains lit constantly, the tire pressure monitor is malfunctioning.

Information on tire pressures is displayed in the multifunction display. After a few minutes of driving, the current tire pressure of each tire is shown in the multifunction display.

USA only: the tire pressure warning lamp will inform you of a malfunction in the tire pressure monitor by flashing for approximately one minute and then remaining lit. It may take more than ten minutes before the data menu is displayed. When the malfunction has been rectified, the tire pressure warning lamp goes out after a few minutes of driving.

The tire pressure values indicated by the on-board computer may differ from those measured at a gas station with a pressure gauge. The tire pressures shown by the on-board computer refer to those measured at sea level. At high altitudes, the tire pressure values indicated by a pressure gauge are higher than those shown by the on-board computer. In this case, do not reduce the tire pressures.

The operation of the tire pressure monitor can be affected by interference from radio transmitting equipment (e.g. radio headphones, two-way radios) that may be being operated in or near the vehicle.

i USA only:

This device complies with part 15 of the FCC Rules. Operation is subject to the following two conditions:

1. This device may not cause harmful interference, and

2. This device must accept any interference received, including interference that may cause undesired operation of the device.

Any unauthorized modification to this device could void the user's authority to operate the equipment.





i Canada only:

This device complies with RSS-210 of Industry Canada. Operation is subject to the following two conditions:

1. This device may not cause harmful interference, and
2. this device must accept any interference received, including interference that may cause undesired operation of the device.

Any unauthorized modification to this device could void the user's authority to operate the equipment.

Checking the tire pressure electronically

- ▶ Make sure that the SmartKey is in position **2** in the ignition lock (▷ page 112).
- ▶ Press the  or  button on the steering wheel to select the **Serv.** menu.
- ▶ Press the  or  button to select **Tire Pressure**.
- ▶ Press the  button.
The current tire pressure of each tire is shown in the multifunction display.

If the vehicle has been parked for over 20 minutes, the **Tire pressure will be displayed after driving a few minutes** message appears.

After a teach-in process, the tire pressure monitor automatically detects new wheels or new sensors. As long as a clear allocation of the tire pressure value to the individual wheels is not possible, the **Tire Pressure Monitor Active** display message is shown instead of the tire pressure display. The tire pressures are already being monitored.

- i** If a spare wheel is mounted, the system may continue to show the tire pressure of the wheel that has been removed for a few minutes. Observe that the displayed value is not the same as the current tire pressure of the emergency spare wheel.

Tire pressure monitor warning messages

If the tire pressure monitor detects a significant pressure loss on one or more tires, a warning message is shown in the multifunction display. A warning tone also sounds and the tire pressure warning lamp lights up in the instrument cluster. Each tire that is affected by a significant loss of pressure is highlighted in the pressure display.

- ▶ If the **Correct Tire Pressure** message appears in the multifunction display, check the tire pressure on all four wheels and correct it if necessary.
- ▶ If the **Check Tires** message appears in the multifunction display, the tire pressure in one or more tires has dropped significantly and the tires must be checked.
- ▶ If the **Tire Press. Warning Caution Tire Malfunction** message appears in the multifunction display, the tire pressure in one or more tires has dropped suddenly and the tires must be checked.

- i** If the wheel positions on the vehicle are rotated, the tire pressures may be displayed for the wrong positions for a short time. This is rectified after a few minutes of driving, and the tire pressures are displayed for the correct positions.

Restarting the tire pressure monitor

When you restart the tire pressure monitor, all existing warning messages are deleted and the warning lamps go out. The monitor uses the currently set tire pressures as the reference values for monitoring. In most cases, the tire pressure monitor will automatically detect the new reference values after you have changed the tire pressure. However, you can also define reference values manually as described here.

- ▶ Set the tire pressure to the value recommended for the corresponding driving situation on the Tire and Loading Information placard on the driver's side B-pillar (▷ page 265).
Additional tire pressure values for different loads can also be found on the tire pressure table on the inside of the fuel filler flap (▷ page 265).
- ▶ Make sure that the tire pressure is correct on all four wheels.

- ▶ Make sure that the SmartKey is in position 2 in the ignition lock (▷ page 112).
- ▶ Press the ◀ or ▶ button on the steering wheel to select the **Serv.** menu.
- ▶ Press the ▲ or ▼ button to select **Tire Pressure**.
- ▶ Press the **OK** button.
The multifunction display shows the current tire pressure for the individual tires or the **Tire pressure will be displayed after driving a few minutes** message.
- ▶ Press the ▼ button.
The **Use Current Pressures as New Reference Values** message appears in the multifunction display.

If you wish to confirm the restart:

- ▶ Press the **OK** button.
The **Tire Press. Monitor Restarted** message appears in the multifunction display.
After driving for a few minutes, the system checks whether the current tire pressures are within the specified range. The new tire pressures are then accepted as reference values and monitored.

If you wish to cancel the restart:

- ▶ Press the **↔** button.
The tire pressure values stored at the last restart will continue to be monitored.

Loading the vehicle

Instruction labels for tires and loads

⚠ WARNING

Overloaded tires can overheat, causing a blowout. Overloaded tires can also impair the steering and driving characteristics and lead to brake failure. There is a risk of accident.

Observe the load rating of the tires. The load rating must be at least half of the GAWR of your vehicle. Never overload the tires by exceeding the maximum load.



① B-pillar, driver's side

Two instruction labels on your vehicle show the maximum possible load.

- (1) The Tire and Loading Information placard is on the B-pillar on the driver's side. The Tire and Loading Information placard shows the maximum permissible number of occupants and the maximum permissible vehicle load. It also contains details of the tire sizes and corresponding pressures for tires mounted at the factory.

- (2) The vehicle identification plate is on the B-pillar on the driver's side. The vehicle identification plate informs you of the gross vehicle weight rating. It is made up of the vehicle weight, all vehicle occupants, the fuel and the cargo. You can also find information about the maximum gross axle weight rating on the front and rear axle.

The maximum gross axle weight rating is the maximum weight that can be carried by one axle (front or rear axle). Do not exceed the maximum gross vehicle weight or the maximum gross axle weight rating for the front or rear axle.

Maximum permissible gross mass

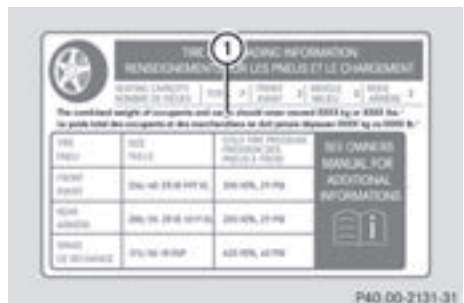

P40.00-2131-31

- Specification for maximum permissible load ① is listed on the Tire and Loading Information placard: "The combined weight of occupants and cargo should never exceed XXX kilograms or XXX lbs."

The gross weight of all vehicle occupants, cargo, luggage and trailer load/noseweight (if applicable) must not exceed the specified value.

- ① The specifications shown on the Tire and Loading Information placard in the illustration are examples. The maximum permissible load is vehicle-specific and may deviate from the data shown here. The maximum permissible load that applies for your vehicle can be found on your vehicle's Tire and Loading Information placard.

Number of seats

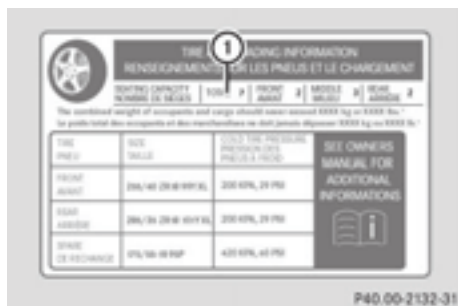

Maximum number of seats ① indicates the maximum number of occupants allowed to travel in the vehicle. This information can be found on the Tire and Loading Information placard.

- ① The specifications shown on the Tire and Loading Information placard in the illustration are examples. The number of seats is vehicle-specific and can differ from the details shown. The number of seats in your vehicle can be found on the Tire and Loading Information placard.

Determining the correct load limit

Step-by-step instructions

The following steps have been developed as required of all manufacturers under Title 49, Code of U.S. Federal Regulations, Part 575 pur-

suant to the "National Traffic and Motor Vehicle Safety Act of 1966".

- **Step 1:** Locate the statement "The combined weight of occupants and cargo should never exceed XXX kg or XXX lbs." on your vehicle's Tire and Loading Information placard.
- **Step 2:** Determine the combined weight of the driver and passengers that will be riding in your vehicle.
- **Step 3:** Subtract the combined weight of the driver and passengers from XXX kilograms or XXX lbs.
- **Step 4:** The resulting figure equals the available amount of cargo and luggage load capacity. Example: if the "XXX" amount equals 1400 lbs and there will be five 150 lbs passengers in your vehicle, the amount of available cargo and luggage load capacity is 650 lbs (1400 - 750 (5 x 150) = 650 lbs).
- **Step 5:** Determine the combined weight of luggage and cargo being loaded on the vehicle. That weight may not safely exceed the available cargo and luggage load capacity calculated in step 4.
- **Step 6 (if applicable):** If your vehicle will be towing a trailer, load from your trailer will be transferred to your vehicle. This reduces the available cargo and luggage load capacity of your vehicle (▷ page 298).

Example: steps 1 to 3

The following table shows examples on how to calculate total and cargo load capacities with varying seating configurations and number and size of occupants. The following examples use a maximum load of 1,500 lbs (680 kg). **This is for illustration purposes only.** Make sure you are using the actual load limit for your vehicle stated on your vehicle's Tire and Loading Information placard (▷ page 271).

The greater the combined weight of the occupants, the lower the maximum luggage load.

Additional information when towing a trailer (▷ page 298).

Step 1

	Example 1	Example 2	Example 3
Combined maximum weight of occupants and cargo (data from the Tire and Loading Information placard)	1500 lbs (680 kg)	1500 lbs (680 kg)	1500 lbs (680 kg)

Step 2

	Example 1	Example 2	Example 3
Number of people in the vehicle (driver and occupants)	5	3	1
Distribution of the occupants	Front: 2 Rear: 3	Front: 1 Rear: 2	Front: 1
Weight of the occupants	Occupant 1: 150 lbs (68 kg) Occupant 2: 180 lbs (82 kg) Occupant 3: 160 lbs (73 kg) Occupant 4: 140 lbs (63 kg) Occupant 5: 120 lbs (54 kg)	Occupant 1: 200 lbs (91 kg) Occupant 2: 190 lbs (86 kg) Occupant 3: 150 lbs (68 kg)	Occupant 1: 150 lbs (68 kg)
Gross weight of all occupants	750 lbs (340 kg)	540 lbs (245 kg)	150 lbs (68 kg)

Step 3

	Example 1	Example 2	Example 3
Permissible load (maximum gross vehicle weight rating from the Tire and Loading Information placard minus the gross weight of all occupants)	1500 lbs (680 kg) - 750 lbs (340 kg) = 750 lbs (340 kg)	1500 lbs (680 kg) - 540 lbs (245 kg) = =960 lbs (435 kg)	1500 lbs (680 kg) - 150 lbs (68 kg) = 1350 lbs (612 kg)

Vehicle identification plate

Even if you have calculated the total load carefully, you should still make sure that the gross vehicle weight rating and the gross axle weight rating are not exceeded. Details can be found on the vehicle identification plate on the B-pillar on the driver's side of the vehicle (▷ page 271).

Gross vehicle weight rating: the gross weight of the vehicle, all passengers, load and trailer load/noseweight (if applicable) must not exceed the gross vehicle weight rating.

Gross Axle Weight Rating (GAWR): the maximum permissible weight that can be carried by one axle (front or rear axle).

To ensure that your vehicle does not exceed the maximum permissible values (gross vehicle weight and maximum gross axle weight rating), have your loaded vehicle (including driver, occupants, load and full trailer load if applicable) weighed on a suitable vehicle weighbridge.

Trailer load/noseweight

The trailer load/noseweight affects the gross weight of the vehicle. If a trailer is attached, the trailer load/noseweight is included in the load along with occupants and luggage. The trailer load/noseweight is usually approximately 10 % of the gross weight of the trailer and its load.

Only use a trailer tow hitch that has been approved for your vehicle by Mercedes-Benz. Comply with the manufacturer's operating instructions for operation, care and maintenance.

Uniform Tire Quality Grading Standards

Overview of Tire Quality Grading Standards



Uniform Tire Quality Grading Standards are U.S. government specifications. Their purpose is to provide drivers with uniform reliable information on tire performance data. Tire manufacturers have to grade tires using three performance factors: ① tread wear grade, ② traction grade and ③ temperature grade. These regulations do not apply to Canada. Nevertheless, all tires sold in North America are provided with the corresponding quality grading markings on the sidewall of the tire.

Where applicable, the tire grading information can be found on the tire sidewall between the tread shoulder and maximum tire width.

Example:

- **Treadwear grade:** 200
- **Traction grade:** AA
- **Temperature grade:** A

All passenger car tires must conform to the statutory safety requirements in addition to these grades.

i The actual values for tires are vehicle-specific and may deviate from the values in the illustration.

Treadwear

The treadwear grade is a comparative rating based on the wear rate of the tire when tested under controlled conditions on a specified U.S. government course. For example, a tire graded 150 would wear one and one-half times as well

on the government test track as a tire graded 100.

The relative performance of tires depends upon the actual conditions of their use, however, and may depart significantly from the norm, due to variations in driving habits, service practices and differences in road characteristics and climate conditions.

Traction

⚠ WARNING

The traction grade assigned to this tire is based on straight-ahead braking traction tests, and does not include acceleration, cornering, hydroplaning, or peak traction characteristics.

❗ Avoid wheelspin. This can lead to damage to the drive train.

The traction grades, from highest to lowest, are AA, A, B, and C. Those grades represent the tire's ability to stop on a wet surface as measured under controlled conditions on specified government test surfaces of asphalt and concrete. A tire marked C may have poor traction performance.

The safe speed on a wet, snow covered or icy road is always lower than on dry road surfaces. You should pay special attention to road conditions when temperatures are around freezing point.

Mercedes-Benz recommends a minimum tread depth of $\frac{1}{8}$ in (4 mm) on all four winter tires. Observe the legally required minimum tire tread depth (▷ page 263). Winter tires can reduce the braking distance on snow-covered surfaces in comparison with summer tires. The braking distance is still much further than on surfaces that are not icy or covered with snow. Take appropriate care when driving.

Further information on winter tires (M+S tires) (▷ page 264).

Temperature

⚠ WARNING

The temperature grade for this tire is established for a tire that is properly inflated and

not overloaded. Excessive speed, underinflation, or excessive loading, either separately or in combination, can cause excessive heat build-up and possible tire failure.

The temperature grades are A (the highest), B, and C. These represent the tire's resistance to the generation of heat and its ability to dissipate heat when tested under controlled conditions on a specified indoor laboratory test wheel. Sustained high temperature can cause the material of the tire to degenerate and reduce tire life, and excessive temperature can lead to sudden tire failure. The grade C corresponds to a level of performance which all passenger car tires must meet under the Federal Motor Vehicle Safety Standard No. 109. Grades B and A represent higher levels of performance on the laboratory test wheel than the minimum required by law.

Tire labeling

Overview of tire labeling

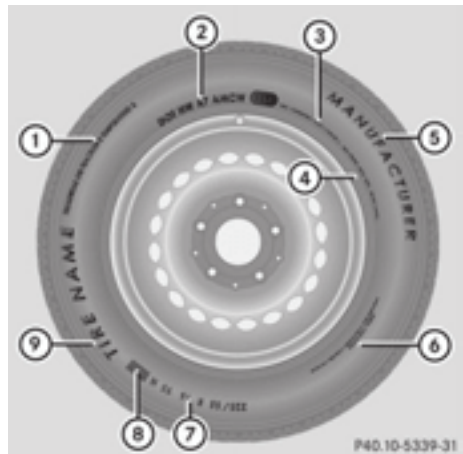

- ① Uniform tire Quality Grading Standard (▷ page 279)
- ② DOT tire Identification Number (▷ page 278)
- ③ Maximum tire load (▷ page 278)
- ④ Maximum tire pressures (▷ page 268)
- ⑤ Manufacturer
- ⑥ Tire material (▷ page 279)
- ⑦ Tire size designation, load-bearing capacity and speed rating (▷ page 276)

- ⑧ Load identification (▷ page 277)
- ⑨ Tire name

The markings described above are on the tire in addition to the tire name (sales designation) and the manufacturer's name.

- ❗ Tire data is vehicle-specific and may deviate from the data in the example.

Tire size designation, load-bearing capacity and speed rating

⚠ WARNING

Exceeding the stated tire load-bearing capacity and the approved maximum speed could lead to tire damage or the tire bursting. There is a risk of accident.

Therefore, only use tire types and sizes approved for your vehicle model. Observe the tire load rating and speed rating required for your vehicle.



- ① Tire width
- ② Height-width ratio in percentage
- ③ Tire code
- ④ Rim diameter
- ⑤ Load bearing index
- ⑥ Speed rating

General: depending on the manufacturer's standards, a letter is imprinted into the tire wall before the size description.

If there is no letter preceding the size description (as shown above): these are passenger vehicle tires according to European manufacturing standards.

If "P" precedes the size description: passenger vehicle tires according to U.S. manufacturing standards.

If "P" precedes the size description: light truck tires according to U.S. manufacturing standards.

If "T" precedes the size description: these are compact emergency spare wheels at high tire pressure, to be used only temporarily in an emergency.

Tire width: tire width ① shows the nominal tire width in millimeters.

Height-width ratio: height-width ratio ② is the ratio between tire height and tire width. The aspect ratio is calculated by dividing the tire width by the tire height. The resulting quotient is given as a percentage.

Tire code: tire code ③ shows the tire type. "R" represents radial tires; "D" represents diagonal tires; "B" represents diagonal radial tires.

Optionally, tires with a maximum speed of over 149 mph (240 km/h) may have "ZR" in the size description, depending on the manufacturer (e.g. 245/40 ZR 18).

Rim diameter: rim diameter ④ is the diameter of the bead seat, not the diameter of the rim flange. The rim diameter is specified in inches (in).

The load-bearing index: load-bearing index ⑤ (also load index), is a code that contains the maximum load-bearing capacity of a tire.

Do not overload the tires by exceeding the specified load limit. The maximum permissible load can be found on the vehicle's Tire and Loading Information placard on the B-pillar on the driver's side (▷ page 271).

Example:

Load-bearing index 91 indicates a maximum load of 1,356 lb (615 kg) that the tires can bear. For further information on the maximum tire load in kilograms and pounds, see (▷ page 278).

For further information on the load bearing index, see "Load index" (▷ page 277).

Speed rating: speed rating ⑥ specifies the approved maximum speed of the tire.

- ❗ Tire data is vehicle-specific and may deviate from the data in the example.

Regardless of the speed rating, always observe the speed limits. Drive carefully and adapt your driving style to the traffic conditions.

- ❗ Since 2009, tires in Europe which correspond to the noise limitations of Directive ECE-R 117 show an >>S<< (Sound) mark. This

identification follows the type approval number and has no connection with the speed rating.

Summer tires

Index	Speed rating
Q	up to 100 mph (160 km/h)
R	up to 106 mph (170 km/h)
S	up to 112 mph (180 km/h)
T	up to 118 mph (190 km/h)
H	up to 130 mph (210 km/h)
V	up to 149 mph (240 km/h)
W	up to 168 mph (270 km/h)
Y	up to 186 mph (300 km/h)
ZR...Y	up to 186 mph (300 km/h)
ZR...(..Y)	over 186 mph (300 km/h)
ZR	over 149 mph (240 km/h)

- Optionally, tires with a maximum speed of over 149 mph (240 km/h) may have "ZR" in the size description, depending on the manufacturer (e.g. 245/40 ZR18).

The service specification is made up of load-bearing index (5) and speed rating (6).

- If the size description of your tire includes "ZR" and there are no service specifications, ask the tire manufacturer in order to find out the maximum speed.

If a service specification is available, the maximum speed is limited according to the speed rating in the service specification. Example: 245/40 ZR18 97 Y. In this example, "97 Y" is the service specification. The letter "Y" represents the speed rating and the maximum speed of the tire is limited to 186 mph (300 km/h).

- The size description for all tires with maximum speeds of over 186 mph (300 km/h) must include "ZR", **and** the service specification must be given in parentheses. Example: 275/40 ZR 18 (99 Y). Speed rating "(Y)" indicates that the maximum speed of the tire is over 186 mph (300 km/h). Ask the tire manufacturer about the maximum speed.

All-weather tires and winter tires

Index	Speed rating
Q M+S ⁴	up to 100 mph (160 km/h)
T M+S ⁴	up to 118 mph (190 km/h)
H M+S ⁴	up to 130 mph (210 km/h)
V M+S ⁴	up to 149 mph (240 km/h)

- i** Not all tires with the M+S marking provide the driving characteristics of winter tires. In addition to the M+S marking, winter tires also have the  snowflake symbol on the tire wall. Tires with this marking fulfill the requirements of the Rubber Manufacturers Association (RMA) and the Rubber Association of Canada (RAC). These tires have been developed specifically for driving on snow.

When the electronic speed limiter is set, your vehicle is prevented from exceeding 130 mph (210 km/h).

The speed rating of tires mounted at the factory may be higher than the maximum speed that the electronic speed limiter permits.

Make sure that your tires have the required speed rating, e.g. when buying new tires. The required speed rating for your vehicle can be found in the "Tires" section (▷ page 286).

Further information about reading tire data can be obtained from any qualified specialist workshop.

Load index



In addition to the load bearing index, load rating (1) may be imprinted after the letters that

4 Or M+S  for winter tires.

identify speed rating ⑥ on the sidewall of the tire (> page 276).

- If no specification is given: no text (as in the example above), represents a standard load (SL) tire
- XL or Extra Load: represents a reinforced tire
- Light Load: represents a light load tire
- C, D, E: represents a load range that depends on the maximum load that the tire can carry at a certain pressure

i Tire data is vehicle-specific and may deviate from the data in the example.

Maximum load rating

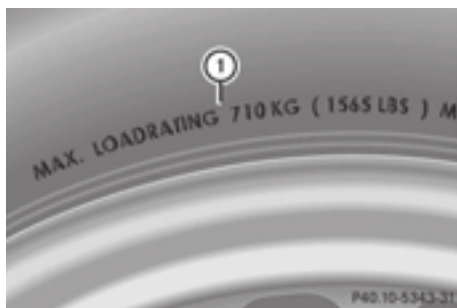

Maximum tire load ① is the maximum permissible weight for which the tire is approved.

Do not overload the tires by exceeding the specified load limit. The maximum permissible load can be found on the vehicle's Tire and Loading Information placard on the B-pillar on the driver's side (> page 271).

i The actual values for tires are vehicle-specific and may deviate from the values in the illustration.

DOT, Tire Identification Number (TIN)

U.S. tire regulations prescribe that every manufacturer of new tires or retreader has to imprint a TIN in or on the sidewall of each tire produced.



The TIN is a unique identification number. The TIN enables tire manufacturers to inform purchasers of recalls and other safety-relevant matters. It makes it possible for the purchaser to easily identify the affected tires.

The TIN is made up of manufacturer identification code ②, tire size ③, tire type code ④ and manufacturing date ⑤.

DOT (Department of Transportation): tire symbol ① indicates that the tire complies with the requirements of the U.S. Department of Transportation.

Manufacturer identification code: manufacturer identification code ② provides details on the tire manufacturer. New tires have a code with two symbols. Retreaded tires have a code with four symbols.

For further information about retreaded tires, see (> page 262).

Tire size: identifier ③ describes the tire size.

Tire type code: tire type code ④ can be used by the manufacturer as a code to describe specific characteristics of the tire.

Date of manufacture: date of manufacture ⑤ provides information about the age of a tire. The first and second positions represent the week of manufacture, starting with "01" for the first calendar week. Positions three and four represent the year of manufacture. For example, a tire that is marked with "3208", was manufactured in week 32 in 2008.

i Tire data is vehicle-specific and may deviate from the data in the example.

Tire characteristics

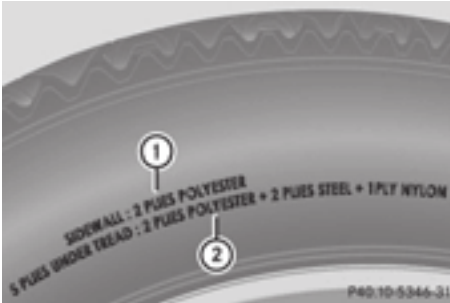

This information describes the type of tire cord and the number of layers in sidewall ① and under tire tread ②.

- ① Tire data is vehicle-specific and may deviate from the data in the example.

Definition of terms for tires and loading

Tire ply composition and material used

Describes the number of layers or the number of rubber-coated belts in the tread and the sidewall of the tire. These are made of steel, nylon, polyester and other materials.

Bar

Metric unit for tire pressure. 14.5038 pounds per square inch (psi) and 100 kilopascals (kPa) are the equivalent of 1 bar.

DOT (Department of Transportation)

DOT-marked tires fulfill the requirements of the U S Department of Transportation.

Normal occupant weight

The number of occupants for which the vehicle is designed multiplied by 68 kilograms (150 lbs).

Uniform Tire Quality Grading Standards

A uniform standard to grade the quality of tires with regards to tread quality, tire traction and temperature characteristics. The quality grading assessment is made by the manufacturer following specifications from the U.S. govern-

ment. The ratings are molded into the sidewall of the tire.

Recommended tire pressures

The recommended tire pressure applies to the tires mounted at the factory.

The Tire and Loading Information placard contains the recommended tire pressures for cold tires on a fully loaded vehicle and for the maximum permissible vehicle speed.

The tire pressure table contains the recommended pressures for cold tires for various operating conditions, i.e. differing load and speed conditions.

Increased vehicle weight due to optional equipment

The combined weight of all standard and optional equipment available for the vehicle, regardless of whether it is actually installed on the vehicle or not.

Rim

This is the part of the wheel on which the tire is mounted.

GAWR (Gross Axle Weight Rating)

The GAWR is the maximum gross axle weight rating. The actual load on an axle must never exceed the gross axle weight rating. The gross axle weight rating can be found on the vehicle identification plate on the B-pillar on the driver's side.

Speed rating

The speed rating is part of the tire identification. It specifies the speed range for which the tire is approved.

GTW (Gross Trailer Weight)

The GTW is the weight of a trailer including the weight of the load, luggage, accessories etc. on the trailer.

GVW (Gross Vehicle Weight)

The gross vehicle weight includes the weight of the vehicle including fuel, tools, the spare wheel, accessories installed, occupants, luggage and

the drawbar noseweight, if applicable. The gross vehicle weight must not exceed the gross vehicle weight rating GVWR as specified on the vehicle identification plate on the B-pillar on the driver's side.

GVWR (Gross Vehicle Weight Rating)

The GVWR is the maximum permissible gross weight of a fully loaded vehicle (the weight of the vehicle including all accessories, occupants, fuel, luggage and the drawbar noseweight, if applicable). The gross vehicle weight rating is specified on the vehicle identification plate on the B-pillar on the driver's side.

Maximum loaded vehicle weight

The maximum weight is the sum of:

- the curb weight of the vehicle
- the weight of the accessories
- the load limit
- the weight of the factory installed optional equipment

Kilopascal (kPa)

Metric unit for tire pressure. 6.9 kPa corresponds to 1 psi. Another unit for tire pressure is bar. 100 kilopascals (kPa) are the equivalent of 1 bar.

Load index

In addition to the load-bearing index, the load index may also be imprinted on the sidewall of the tire. This specifies the load-bearing capacity more precisely.

Curb weight

The weight of a vehicle with standard equipment including the maximum capacity of fuel, oil and coolant. It also includes the air-conditioning system and optional equipment if these are installed in the vehicle, but does not include passengers or luggage.

Maximum load rating

The maximum load rating is the maximum permissible weight in kilograms or lbs for which a tire is approved.

Maximum permissible tire pressure

Maximum permissible tire pressure for one tire.

Maximum load on one tire

Maximum load on one tire. This is calculated by dividing the maximum axle load of one axle by two.

PSI (pounds per square inch)

A standard unit of measure for tire pressure.

Aspect ratio

Relationship between tire height and tire width in percent.

Tire pressure

This is pressure inside the tire applying an outward force to each square inch of the tire's surface. The tire pressure is specified in pounds per square inch (psi), in kilopascals (kPa) or in bar. The tire pressure should only be corrected when the tires are cold.

Cold tire pressure

The tires are cold:

- if the vehicle has been parked without direct sunlight on the tires for at least three hours and
- if the vehicle has not been driven further than 1 mile (1.6 km)

Tread

The part of the tire that comes into contact with the road.

Bead

The tire bead ensures that the tire sits securely on the wheel. There are several steel wires in the bead to prevent the tire from coming loose from the wheel rim.

Sidewall

The part of the tire between the tread and the bead.

Weight of optional extras

The combined weight of those optional extras that weigh more than the replaced standard parts and more than 2.3 kg (5 lbs). These optional extras, such as high-performance brakes, level control, a roof rack or a high-performance battery, are not included in the curb weight and the weight of the accessories.

TIN (Tire Identification Number)

This is a unique identifier which can be used by a tire manufacturer to identify tires, for example for a product recall, and thus identify the purchasers. The TIN is made up of the manufacturer's identity code, tire size, tire type code and the manufacturing date.

Load bearing index

The load bearing index (also load index) is a code that contains the maximum load bearing capacity of a tire.

Traction

Traction is the result of friction between the tires and the road surface.

TWR (Tongue Weight Rating)

The TWR specifies the maximum permissible weight that the ball coupling of the trailer tow hitch can support.

Treadwear indicators

Narrow bars (tread wear bars) that are distributed over the tire tread. If the tire tread is level with the bars, the wear limit of $\frac{1}{16}$ in (1.6 mm) has been reached.

Occupant distribution

The distribution of occupants in a vehicle at their designated seating positions.

Total load limit

Nominal load and luggage load plus 150 lb (68 kilograms) multiplied by the number of seats in the vehicle.

Changing a wheel

Flat tire

The "Breakdown assistance" section (> page 250) contains information and notes on how to deal with a flat tire.

Rotating the wheels

WARNING

Interchanging the front and rear wheels may severely impair the driving characteristics if the wheels or tires have different dimensions. The wheel brakes or suspension components may also be damaged. There is a risk of accident.

Rotate front and rear wheels only if the wheels and tires are of the same dimensions.

! On vehicles equipped with a tire pressure monitor, electronic components are located in the wheel.

Tire-mounting tools should not be used near the valve. This could damage the electronic components.

Only have tires changed at a qualified specialist workshop.

Rotating front and rear wheels of differing dimensions can render the general operating permit invalid.

Always pay attention to the instructions and safety notices in the section on "Changing a wheel and mounting a spare wheel" (> page 282).

The wear patterns on the front and rear tires differ, depending on the operating conditions. Rotate the wheels before a clear wear pattern has formed on the tires. Front tires typically wear more on the shoulders and the rear tires in the center.

If your vehicle's tire configuration allows, you can rotate the wheels according to the intervals in the tire manufacturer's warranty book in your vehicle documents. If no warranty book is available, the tires should be rotated every 3,000 to 6,000 miles (5,000 to 10,000 km), or earlier if tire wear requires. Do not change the direction of wheel rotation.

Clean the contact surfaces of the wheel and the brake disc thoroughly every time a wheel is rota-

ted. Check the tire pressure and reactivate the tire pressure monitor (> page 268) if necessary.

Direction of rotation

Tires with a specified direction of rotation have additional benefits, e.g. if there is a risk of hydroplaning. You will only gain these benefits if the correct direction of rotation is observed.

An arrow on the sidewall of the tire indicates its correct direction of rotation.

You may mount the spare wheel against the direction of rotation. Adhere to the time restriction on use as well as the speed limitation specified on the spare wheel.

Storing wheels

Store tires that are not being used in a cool, dry and preferably dark place. Protect the tires from oil, grease, gasoline and diesel.

Mounting a wheel

Preparing the vehicle

WARNING

When you remove the spare wheel from the spare wheel bracket, the vehicle's weight distribution changes. If the vehicle is already raised, the jack could tip over. There is a risk of injury.

Remove the spare wheel from the spare wheel bracket before lifting the vehicle.

- ▶ Prepare the vehicle as described (> page 250).
- ▶ Remove the vehicle tool kit and the jack (> page 248).
- ▶ Secure the vehicle to prevent it from rolling away.
- ▶ Remove the spare wheel from the spare wheel bracket (> page 249).

i Vehicles without a spare wheel or emergency spare wheel are not equipped with a tire-change tool kit at the factory. For more information on which tools are required to perform a wheel change on your vehicle e.g.

lug wrench or jack, consult an authorized Mercedes-Benz Center.

Securing the vehicle to prevent it from rolling away

- ▶ **On level ground:** place chocks or other suitable items under the front and rear of the wheel that is diagonally opposite the wheel you wish to change.
- ▶ **On downhill gradients:** place chocks or other suitable items in front of the wheels of the front and rear axle.

Raising the vehicle

WARNING

If you do not position the jack correctly at the appropriate jacking point of the vehicle, the jack could tip over with the vehicle raised. There is a risk of injury.

Only position the jack at the appropriate jacking point of the vehicle. The base of the jack must be positioned vertically, directly under the jacking point of the vehicle.

- !** The jack is designed exclusively for jacking up the vehicle at the jacking points. Otherwise, your vehicle could be damaged.

Observe the following when raising the vehicle:

- To raise the vehicle, only use the vehicle-specific jack that has been tested and approved by Mercedes-Benz. If used incorrectly, the jack could tip over with the vehicle raised.
- The jack is designed only to raise and hold the vehicle for a short time while a wheel is being changed. It is not suited for performing maintenance work under the vehicle.
- Avoid changing the wheel on uphill and downhill slopes.
- Before raising the vehicle, secure it from rolling away by applying the parking brake and inserting wheel chocks. Do not disengage the parking brake while the vehicle is raised.
- The jack must be placed on a firm, flat and non-slip surface. On a loose surface, a large, load-bearing underlay must be used. On a slippery surface, a non-slip underlay must be used, e.g. rubber mats.
- Do not use wooden blocks or similar objects as a jack underlay. Otherwise, the jack will not

be able to achieve its load-bearing capacity due to the restricted height.

- Make sure that the distance between the underside of the tires and the ground does not exceed 1.2 in (3 cm).
- Do not place your hands or feet under the raised vehicle.
- Do not lie under the vehicle.
- Do not start the engine when the vehicle is raised.
- Do not open or close a door when the vehicle is raised.
- Make sure that no persons are present in the vehicle when the vehicle is raised.



- ▶ Using lug wrench ①, loosen the bolts on the wheel you wish to change by about one full turn. Do not unscrew the wheel bolts completely.

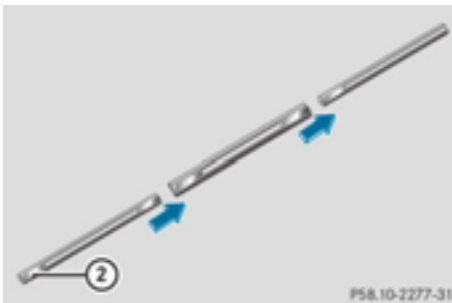

Pump lever ②

- ▶ Assemble the pump lever for the jack. It can be found with the vehicle tool kit (> page 248).

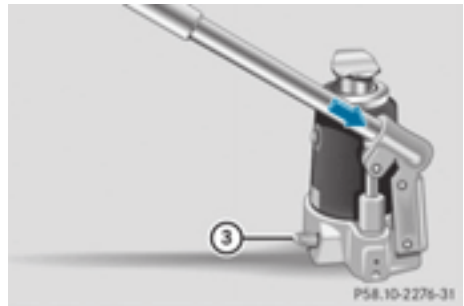

- ▶ Turn pressure release screw ③ clockwise as far as it will go using notch ② on the pump lever. Pressure release screw ③ is closed.

i Do not turn pressure release screw ③ by more than one to two revolutions. Otherwise, hydraulic fluid could escape.

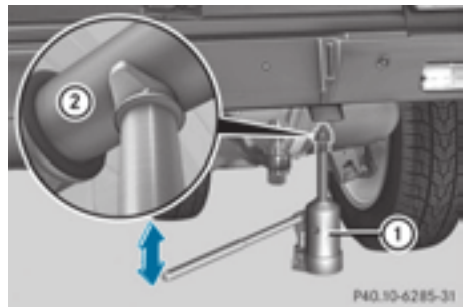

- ▶ Set jack ① on solid ground.
- ▶ Position jack ① on the axle carrier tube ② of the front or rear axle. Jack ① must always stand vertically, even on slopes. Make sure that jack ① is correctly positioned under axle carrier tube ②. The front or rear axle must sit securely in the recess of jack ①.
- ▶ Raise the vehicle by pumping in the direction of the arrow until the tire is 1.2 in (3 cm) off the ground at the most.

Removing a wheel

- !** Do not place wheel bolts in sand or on a dirty surface. The bolt and wheel hub threads could otherwise be damaged when you screw them in.
- ▶ Unscrew the wheel bolts.
- ▶ Remove the wheel.

Mounting a new wheel

WARNING

Oiled or greased wheel bolts/wheel nuts and damaged wheel bolt/wheel nut/wheel hub threads can cause wheel bolts/wheel nuts to come loose. As a result, you could lose a wheel while driving. There is a risk of an accident.

Never oil or grease wheel bolts/wheel nuts. In the event of damage to the threads, contact a qualified specialist workshop immediately. Have the damaged wheel bolts/wheel nuts or hub threads replaced/renewed. Do not continue driving.

WARNING

If you tighten the wheel bolts or wheel nuts when the vehicle is raised, the jack could tip over. There is a risk of injury.

Only tighten the wheel bolts or wheel nuts when the vehicle is on the ground.

! To prevent damage to the paintwork, hold the wheel securely against the wheel hub while screwing in the first wheel bolt.

Always pay attention to the instructions and safety notes in the "Changing a wheel" section (> page 281).

- ▶ Clean the wheel and wheel hub contact surfaces.
- ▶ Place the new wheel on the wheel hub and push it on.
- ▶ Tighten the wheel bolts until they are finger-tight.

Lowering the vehicle

WARNING

The wheels could work loose if the wheel nuts and bolts are not tightened to the specified tightening torque. There is a risk of accident.

Have the tightening torque immediately checked at a qualified specialist workshop after a wheel is changed.

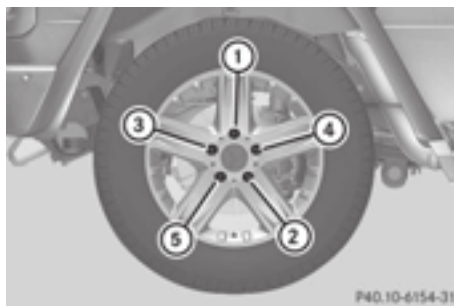

- ▶ Open the pressure release screw on the jack using the pump lever (> page 282) by approximately one turn.
- ▶ Lower the vehicle until it is once again standing firmly on the ground.
- ▶ Place the jack to one side.
- ▶ Tighten the wheel bolts evenly in a crosswise pattern in the sequencing indicated (① to ⑤). The specified tightening torque is 96 lb-ft (130 Nm).
- ▶ Disassemble the pump lever.
- ▶ Push the jack piston back in and close the drain plug.
- ▶ Use the bolts to secure the faulty wheel to the spare wheel bracket (> page 249).
- ▶ Stow the jack and the vehicle tools in the vehicle again.
- ▶ Check the tire pressure of the newly installed wheel and adjust it if necessary.

A table with the tire pressures for your vehicle can be found on the B-pillar on the driver's side.

Wheel and tire combinations

General notes

WARNING

If wheels and tires of the wrong size are used, the wheel brakes or suspension components may be damaged. There is a risk of an accident.

Always replace wheels and tires with those that fulfill the specifications of the original part.

When replacing wheels, make sure to use the correct:

- designation
- model

When replacing tires, make sure to use the correct:

- designation
- manufacturer
- model

Warning

A flat tire severely impairs the driving, steering and braking characteristics of the vehicle. There is a risk of an accident.

do not drive with a flat tire. Immediately replace the flat tire with your spare wheel, or consult a qualified specialist workshop.

! For safety reasons, Mercedes-Benz recommends that you only use tires, wheels and accessories which have been approved by Mercedes-Benz specifically for your vehicle. These tires have been specially adapted for use with the driving safety systems, such as ABS or ESP®.

Only use tires, wheels or accessories tested and approved by Mercedes-Benz. Certain characteristics, e.g. handling, vehicle noise emissions or fuel consumption, may otherwise be adversely affected. In addition, when driving with a load, tire dimension variations could cause the tires to come into contact with the bodywork and axle components. This could result in damage to the tires or the vehicle.

Mercedes-Benz accepts no liability for damage resulting from the use of tires, wheels or accessories other than those tested and approved.

Further information about wheels, tires and approved combinations can be obtained from any authorized Mercedes-Benz Center.

i The recommended pressures for various operating conditions can be found:

- on the Tire and Loading Information placard with the recommended tire pressures on the B-pillar on the driver's side
- in the tire pressure table on the inside of the fuel filler flap

Observe the notes on recommended tire pressure under various operating conditions. Check tire pressures regularly, and only when the tires are cold. Comply with the maintenance recommendations of the tire manufacturer in the vehicle document wallet.

Further information on recommended tire pressure as well as tire pressures for specific driving situations (> page 279).

i Notes on the vehicle equipment – always equip the vehicle with:

- tires of the same size on a given axle (left/right)
- tires of the same type on your vehicle at a given time (summer tires, winter tires, all-weather tires, all-terrain tires)

i The following pages contain information on approved wheels and tire sizes for equipping your vehicle with winter tires. Winter tires are not available at the factory as standard equipment or optional extras.

If you want to equip your vehicle with approved winter tires, it may be necessary to obtain wheel rims in the corresponding size. The size of the approved winter tires may differ from the standard tires. This is dependent on the model and the equipment installed at the factory.

The tires and wheel rims, as well as further information, can be obtained at a qualified specialist workshop.

i Not all wheel and tire combinations are available at the factory for all countries.

Tires**G 550****All-weather tires**

Tires (radial tires)	Alloy wheels
265/60 R18 110V M+S	7.5J x 18 H2 ET 43
265/60 R18 110 H M+S	7.5J x 18 H2 ET 43
275/55 R19 111V M+S ⁵	9.5J x 19 H2 ET 50

i You can obtain information about tires and tire dimensions that are not listed here at any authorized Mercedes-Benz Center.

G 63 AMG**Summer tires**

Tires	Alloy wheels
275/50 R20 113W XL ⁶	9.5J x 20 H2 ET 50

i You can obtain information about tires and tire dimensions that are not listed here at any authorized Mercedes-Benz Center.

All-weather tires

Tires	Alloy wheels
295/40 R21 111W XL M+S ⁶	10J x 21 ET45

i You can obtain information about tires and tire dimensions that are not listed here at any authorized Mercedes-Benz Center.

Winter tires

Tires	Alloy wheels
265/55 R19 109H M+S	9.5J x 19 H2 ET 50

i You can obtain information about tires and tire dimensions that are not listed here at any authorized Mercedes-Benz Center.

Spare wheel

! The spare wheel must be inflated to the maximum tire pressure given in the table on the inside of the fuel filler flap.

i The spare wheel corresponds to the standard tires.

⁵ Vehicles with AMG Sports package only.

⁶ Use of snow chains not permitted. Observe the notes in the "Snow chains" section.

- i** You can obtain information about tires and tire dimensions that are not listed here at any authorized Mercedes-Benz Center.

Useful information

- i** This Operator's Manual describes all models and all standard and optional equipment of your vehicle available at the time of publication of the Operator's Manual. Country-specific differences are possible. Please note that your vehicle may not be equipped with all features described. This also applies to safety-related systems and functions.
- i** Read the information on qualified specialist workshops: (▷ page 23).

Identification plates

Vehicle identification plate with vehicle identification number (VIN) and paint code number



- Open the driver's door. You will see vehicle identification plate ①.

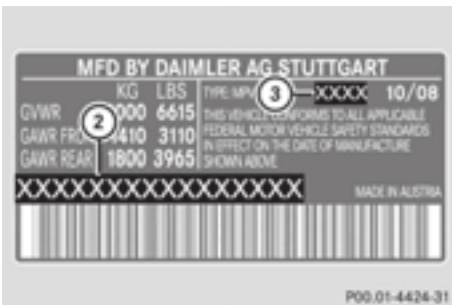

Example: vehicle identification plate (USA only)

- ② VIN
- ③ Paint code

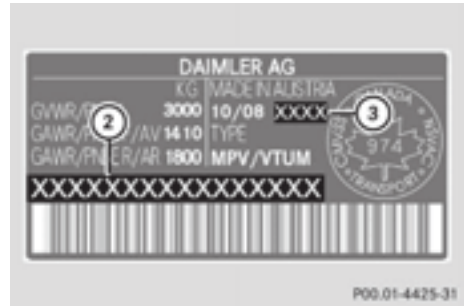

Example: vehicle identification plate (Canada only)

- ② VIN
- ③ Paint code

- i** The data shown on the vehicle identification plate is used only as an example. This data is different for every vehicle and can deviate from the data shown here. The correct data for your vehicle can be found on the vehicle identification plate that is mounted on your vehicle.

Vehicle identification number (VIN)

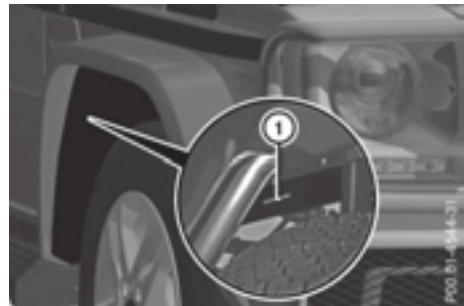

- ① VIN (stamped into the chassis on the right-hand side, when viewed in the direction of travel)

Fuel**Important safety notes** **WARNING**

Fuel is highly flammable. If you handle fuel incorrectly, there is a risk of fire and explosion.

You must avoid fire, open flames, creating sparks and smoking. Switch off the engine and, if applicable, the auxiliary heating before refueling.

 **WARNING**

Fuel is poisonous and hazardous to health. There is a risk of injury.

You must make sure that fuel does not come into contact with your skin, eyes or clothing and that it is not swallowed. Do not inhale fuel vapors. Keep fuel away from children.

If you or others come into contact with fuel, observe the following:

- Wash away fuel from skin immediately using soap and water.
- If fuel comes into contact with your eyes, immediately rinse them thoroughly with clean water. Seek medical assistance without delay.
- If fuel is swallowed, seek medical assistance without delay. Do not induce vomiting.
- Immediately change out of clothing which has come into contact with fuel.

Tank capacity

The total capacity of the fuel tank may vary depending on the equipment in the vehicle.

Model	Total capacity
All models	25.4 US gal (96.0 l)

Model	Of which reserve
All models	Approx. 3.7 US gal (14.0 l)

Gasoline**Fuel grade**

 Do not use diesel to refuel vehicles with a gasoline engine. Do not switch on the ignition if you accidentally refuel with the wrong fuel. Otherwise, the fuel will enter the fuel system. Even small amounts of the wrong fuel could result in damage to the fuel system and the engine. Notify a qualified specialist workshop and have the fuel tank and fuel lines drained completely.

 Only refuel using unleaded premium grade gasoline with at least 91 AKI/95 RON.

 Only use the fuel recommended. Operating the vehicle with other fuels can lead to engine failure.

 Do not use the following:

- E85 (gasoline with 85% ethanol)
- E100 (100% ethanol)
- M15 (gasoline with 15% methanol)
- M30 (gasoline with 30% methanol)
- M85 (gasoline with 85% methanol)
- M100 (100% methanol)
- Gasoline with metalliferous additives
- Diesel

Do not mix such fuels with the fuel recommended for your vehicle. Do not use additives. Otherwise, engine damage may occur. This does not include cleaning additives for the removal and prevention of residue build-up. Gasoline may only be mixed with cleaning additives recommended by Mercedes-Benz; see "Additives". You can obtain further information from any authorized Mercedes-Benz Center.

 To ensure the longevity and full performance of the engine, only premium-grade unleaded gasoline must be used.

If standard unleaded gasoline is unavailable and you have to refuel with unleaded gasoline of a lower grade, observe the following precautions:

- Only fill the fuel tank to half full with regular unleaded gasoline and fill the rest with premium-grade unleaded gasoline as soon as possible.
- Do not drive at the maximum speed.
- Avoid sudden acceleration and engine speeds over 3,000 rpm.

You will usually find information about the fuel grade on the pump. If you cannot find the label on the pump, ask the staff for assistance.

i For further information, consult a qualified specialist workshop or visit <http://www.mbusa.com> (USA only).

i E10 fuel contains up to 10% bioethanol. Your vehicle is E10-compatible. You can refuel your vehicle using E10 fuel.

As a temporary measure, if the recommended fuel is not available, you may also use regular unleaded gasoline with an octane rating of 87 AKI/91 RON. This may reduce engine performance and increase fuel consumption. Avoid driving at full throttle and sudden acceleration. Never refuel using fuel with a lower AKI. Information on refueling (▷ page 127).

AMG vehicles

! Only refuel using super-grade unleaded gasoline with at least 98 RON/88 MON that conforms to European standard EN 228 or an equivalent specification.

You could otherwise impair engine output or damage the engine.

! Premium-grade unleaded gasoline with an octane rating of 95 RON/85 MON may be used as a temporary measure if the recommended fuel is not available. This may reduce engine performance and increase fuel consumption. Do not drive at full throttle.

! Regular unleaded gasoline with an octane rating of 91 RON/82.5 MON may also be used as an emergency measure if the recommended fuel is not available.

Doing so results in noticeably higher fuel consumption, and the engine power output is noticeably reduced. Avoid driving at full throttle.

If only regular unleaded gasoline with an octane rating of 91 RON/82.5 MON or lower is available, you must have the vehicle adapted to this fuel at a qualified specialist workshop.

Additives

! Operating the engine with fuel additives added later can lead to engine failure. Do not mix fuel additives with fuel. This does not include additives for the removal and prevention of residue buildup. Gasoline must only be mixed with additives recommended by Mercedes-Benz. Comply with the instructions for use on the product label. More information about recommended additives can be obtained from any authorized Mercedes-Benz Center.

Mercedes-Benz recommends that you use branded fuels that have additives.

The quality of the fuel available in some countries may not be sufficient. Residue could build up in the fuel injection system as a result. In such cases, and in consultation with an authorized Mercedes-Benz Center, the gasoline may be mixed with the cleaning additive recommended by Mercedes-Benz. You must observe the notes and mixing ratios specified on the container.

Fuel consumption information

Environmental note

CO₂ (carbon dioxide) is the gas which scientists believe to be principally responsible for global warming (the greenhouse effect). Your vehicle's CO₂ emissions are directly related to fuel consumption and therefore depend on:

- efficient use of the fuel by the engine
- driving style
- other non-technical factors, such as environmental influences, road conditions or traffic flow

You can minimize your vehicle's CO₂ emissions by driving carefully and having it serviced regularly.

The vehicle will use more fuel than usual in the following situations:

- at very low outside temperatures
- in city traffic
- on short journeys
- in mountainous terrain
- when towing a trailer

Engine oil

General notes



! Never use engine oil or an oil filter of a specification other than is necessary to fulfill the prescribed service intervals. Do not change the engine oil or oil filter in order to achieve longer replacement intervals than those prescribed. You could otherwise cause engine damage or damage to the exhaust gas aftertreatment.

Follow the instructions in the service interval display regarding the oil change. Otherwise, you may damage the engine and the exhaust gas aftertreatment.

When handling engine oil, observe the important safety notes on service products (▷ page 289). The engine oils are matched to the performance of Mercedes-Benz engines and service intervals. For this reason, only use engine oils and oil filters that are approved for vehicles with a service system.

For a list of approved engine oils and oil filters, consult an authorized Mercedes-Benz Center or go to the Internet site

<http://bevo.mercedes-benz.com> (USA only).

The table shows which engine oils have been approved for your vehicle.

Model	MB-Freigabe or MB Approval
G 550	229.3 / 229.5
G 63 AMG	229.5

i The MB-Freigabe or MB Approval is stated on the oil containers.

Filling capacities

The following values refer to an oil change including the oil filter.

Vehicle model	Capacity including oil filter
G 550	2.4 US gal (9.0 l)
G 63 AMG	2.25 US gal (8.5 l)

Additives

! Do not use any additives in the engine oil. This could damage the engine.

Engine oil viscosity

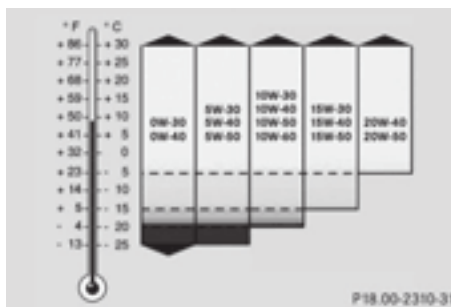

Viscosity describes the flow characteristics of a fluid. If an engine oil has a high viscosity, this means that it is thick; a low viscosity means that it is thin.

Select an engine oil with an SAE classification (viscosity) suitable for the prevailing outside temperatures. The table shows you which SAE classifications are to be used. The low-temperature characteristics of engine oils can deteriorate significantly, e.g. as a result of aging, soot and fuel deposits. It is therefore strongly recommended that you carry out regular oil changes using an approved engine oil with the appropriate SAE classification.

Climate control system refrigerant

Important safety notes

The climate control system of your vehicle is filled with refrigerant R-134a.

The instruction label regarding the refrigerant type used can be found on the radiator cross member.

! Only the refrigerant R-134a and the PAG oil approved by Mercedes-Benz may be used. The approved PAG oil may not be mixed with any other PAG oil that is not approved for R-134a refrigerant. Otherwise, the climate control system may be damaged.

Service work, such as topping up refrigerant or replacing components, may only be carried out by a qualified specialist workshop. All applicable regulations must be adhered to, SAE standard J639 included.

Always have work on the climate control system carried out at a qualified specialist workshop.

Refrigerant instruction label



Example: refrigerant instruction label

- ① Warning symbol
- ② Refrigerant filling capacity
- ③ Applicable standards
- ④ PAG oil part number
- ⑤ Type of refrigerant

Warning symbol ① advises you about:

- possible dangers
- having service work carried out at a qualified specialist workshop

Filling capacities

Missing values were not available at time of going to print.

AMG vehicles	Capacity
Refrigerant	
PAG oil	

All other models	Capacity
Refrigerant	
PAG oil	

Brake fluid

⚠ WARNING

The brake fluid constantly absorbs moisture from the air. This lowers the boiling point of the brake fluid. If the boiling point of the brake fluid is too low, vapor pockets may form in the brake system when the brakes are applied hard. This would impair braking efficiency. There is a risk of an accident.

You should have the brake fluid renewed at the specified intervals.

When handling brake fluid, observe the important safety notes on service products (▷ page 289).

The brake fluid change intervals can be found in the Maintenance Booklet.

Only use brake fluid approved by Mercedes-Benz according to MB-Freigabe or MB Approval 331.0.

Information about approved brake fluid can be obtained at any qualified specialist workshop or on the Internet at

<http://bevo.mercedes-benz.com>.

- i** Have the brake fluid regularly replaced at a qualified specialist workshop and the replacement confirmed in the Maintenance Booklet.

Coolant**Important safety notes****⚠ WARNING**

If antifreeze comes into contact with hot components in the engine compartment, it may ignite. There is a risk of fire and injury.

Let the engine cool down before you add antifreeze. Make sure that antifreeze is not spilled next to the filler neck. Thoroughly clean the antifreeze from components before starting the engine.

! Only add coolant that has been premixed with the desired antifreeze protection. You could otherwise damage the engine.

Further information on coolants can be found in the Mercedes-Benz Specifications for Service Products, MB BeVo 310.1, e.g. on the Internet at <http://bevo.mercedes-benz.com>. Or contact a qualified specialist workshop.

! Always use a suitable coolant mixture, even in countries where high temperatures prevail. Otherwise, the engine cooling system is not sufficiently protected from corrosion and overheating.

i Have the coolant regularly replaced at a qualified specialist workshop and the replacement confirmed in the Maintenance Booklet.

Comply with the important safety precautions for service products when handling coolant (> page 289).

The coolant is a mixture of water and antifreeze/corrosion inhibitor. It performs the following tasks:

- corrosion protection
- antifreeze protection
- raising the boiling point

If the coolant has antifreeze protection down to -35 °F (-37 °C), the boiling point of the coolant in the pressurized system is approximately 266 °F (130 °C).

The antifreeze/corrosion inhibitor concentration in the engine cooling system should:

- be at least 50%. This will protect the engine cooling system against freezing down to approximately -35 °F (-37 °C).
- not exceed 55% (antifreeze protection down to -49 °F [-45 °C]). Otherwise, heat will not be dissipated as effectively.

Mercedes-Benz recommends an antifreeze/corrosion inhibitor in accordance with MB Specifications for Service Products 310.1.

i When the vehicle is first delivered, it is filled with a coolant mixture that ensures adequate antifreeze and corrosion protection.

i The coolant is checked with every maintenance interval at a qualified specialist workshop.

The engine cooling system is filled with coolant at the factory which contains antifreeze/corrosion inhibitor that ensures protection down to approximately -35 °F (-37 °C).

Your vehicle has a range of aluminum components. Aluminum components in the engine make it necessary to use antifreeze/corrosion inhibitor that has been specifically formulated to protect the aluminum parts. Failure to use such anticorrosion/antifreeze coolant will result in a significantly shortened service life.

The coolant must be used throughout the year in order to maintain the necessary corrosion protection and to provide protection from overheating. In the Maintenance Booklet, you can find information on the intervals for renewal.

The renewal interval is determined by the coolant type and the engine cooling system design. The renewal interval in the Maintenance Booklet is only valid if the coolant is renewed or added to with Mercedes-Benz approved products. Therefore, only use MB 326.0 antifreeze/corrosion inhibitor or another Mercedes-Benz approved product of the same specification.

Information on other products with the same specifications that are approved by Mercedes-Benz can be obtained at an authorized Mercedes-Benz Center or on the Internet at <http://bevo.mercedes-benz.com>.

If the coolant level is too low, MB 325.0 antifreeze/corrosion inhibitor should be added. Have the engine cooling system checked for possible leaks.

Capacity

Model	Capacity
G 550	Approx. 11.1 US qt (10.5 l)
G 63 AMG	Approx. 14.6 US qt (13.8 l) Low-temperature circuit: approximately 3.1 US qt (2.9 l)

i Use MB 325.0 or MB 326.0 antifreeze/corrosion inhibitor.

Windshield/headlamp cleaning system

Important safety notes

⚠ WARNING

Windshield washer concentrate could ignite if it comes into contact with hot engine components or the exhaust system. There is a risk of fire and injury.

Make sure that no windshield washer concentrate is spilled next to the filler neck.

! Do not add distilled or de-ionized water to the washer fluid container. Otherwise, the level sensor may be damaged.

! Only MB SummerFit and MB WinterFit washer fluid should be mixed together. The spray nozzles may otherwise become blocked.

At temperatures above freezing:

- ▶ Fill the washer fluid reservoir with a mixture of water and windshield washer fluid, e.g. MB SummerFit.
- ▶ Add 1 part MB SummerFit to 100 parts water.

At temperatures below freezing:

- ▶ Fill the washer fluid reservoir with a mixture of water and washer fluid, e.g. MB WinterFit. For the correct mixing ratio refer to the information on the antifreeze reservoir.

i Add washer fluid concentrate, e.g. MB SummerFit or MB WinterFit, to the washer fluid all year round.

Vehicle data

General notes

Please note that for the specified vehicle data:

- the heights specified may vary as a result of:
 - tires
 - load
 - condition of the suspension
 - optional equipment
- the vehicle length specified includes the front license plate adapter.

Dimensions and weights

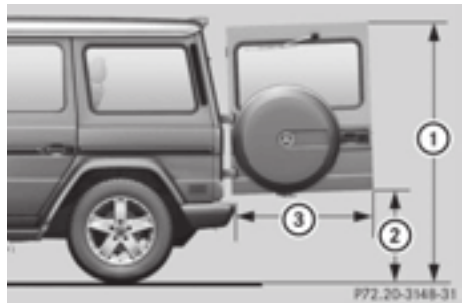

	G 550	G 63 AMG
① Upper-edge clearance	75 in - 78.9 in (1905 mm - 2005 mm)	74.5 in - 78.4 in (1892 mm - 1992 mm)
② Lower-edge clearance	26.8 in - 30.7 in (680 mm - 780 mm)	26.3 in - 30.2 in (667 mm - 767 mm)
③ Range of movement	36.7 in (931 mm)	36.7 in (931 mm)

G 550	
Vehicle length	187.6 in (4764 mm)
Vehicle width including exterior mirrors	80.9 in (2056 mm)
Vehicle height	76.9 in (1954 mm)
Vehicle height (sports suspension)	75.9 in (1928 mm)
Wheelbase	112.2 in (2850 mm)
Minimum ground clearance	7.6 in (193 mm)
Turning radius	44.6 ft (13.60 m)
Gross vehicle weight rating (GVWR)	7054.8 lb (3200 kg)
Gross axle weight rating (GAWR), front	3196.7 lb (1450 kg)
Gross axle weight rating (GAWR), rear	4188.8 lb (1900 kg)

G 63 AMG	
Vehicle length	187.8 in (4769 mm)
Vehicle width including exterior mirrors	80.9 in (2056 mm)
Vehicle height	76.3 in (1938 mm)
Wheelbase	112.2 in (2850 mm)
Minimum ground clearance	7.7 in (196 mm)
Turning radius	44.6 ft (13.60 m)
Gross vehicle weight rating (GVWR)	7054.8 lb (3200 kg)
Gross axle weight rating (GAWR), front	3417.1 lb (1550 kg)
Gross axle weight rating (GAWR), rear	4122.6 lb (1870 kg)

i GVWR is the maximum permissible gross weight of the vehicle. Gross vehicle weight (GVW) is the vehicle weight including fuel, service products, spare wheel, accessories installed, load and, if applicable, trailer drawbar load. The GVW must never exceed the GVWR.

i The GAWR is the maximum permissible axle weight.

Vehicle data for off-road driving

Fording depth

! The depth of water must not exceed the value specified in the table. Note that the possible fording depth is less in flowing water.



The table shows fording depth ① when loaded and ready to drive.

Fording depth	24 in (60 cm)
---------------	---------------

For more information about off-road fording, see (> page 135).

Approach/departure angle

⚠ WARNING

If you drive on a steep incline at an angle or turn when driving on an incline, the vehicle could slip sideways, tip and rollover. There is a risk of an accident.

Always drive on a steep incline in the line of fall (straight up or down) and do not turn the vehicle.

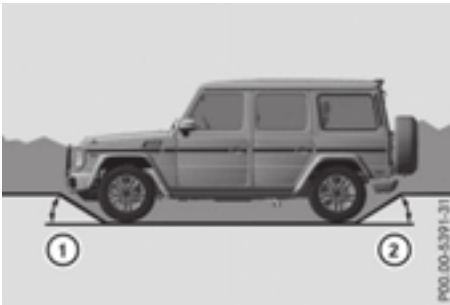

For vehicles with steel springs, loaded and ready to drive means: a full tank, all fluids refilled and the driver is in the vehicle.

	①	②
G 550	30°	30°
G 63 AMG	27°	27°

For further information about approach/departure angles, see (▷ page 140).

Maximum gradient-climbing capability

Note that the vehicle's gradient-climbing capability depends on the off-road conditions and the road surface conditions.

On good road surfaces the maximum gradient-climbing capability of your vehicle is 100%, which corresponds to an approach/departure angle of 45°.

Accelerate carefully and make sure that the wheels do not spin when driving on steep terrain.

- i If the load on the front axle is reduced when pulling away on a steep uphill slope, the front wheels have a tendency to spin. 4ETS detects this and brakes the wheels accordingly. The rear wheel torque is increased, making it easier to drive off.

For further information about the maximum gradient climbing ability, see (▷ page 140).

Trailer tow hitch

Mounting dimensions

- ! If you have a trailer tow hitch retrofitted, changes to the engine cooling system may be necessary, depending on the vehicle type.

If you have a trailer tow hitch retrofitted, observe the anchorage points on the chassis frame.

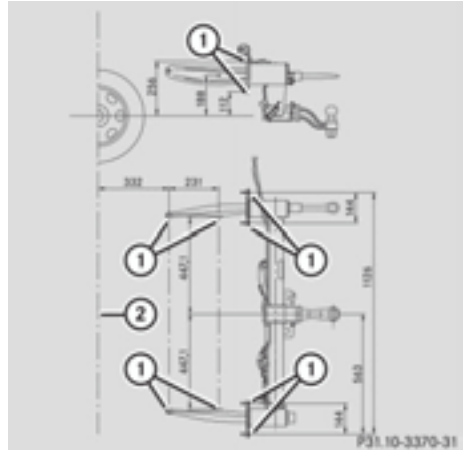

- ① Anchorage points
- ② Overhang dimension

For trailer tow hitches installed at the factory, the overhang dimension including protective covering is 35.2 in (895 mm).

Trailer loads

G 550

G 63 AMG

Permissible trailer load, unbraked	1653 lbs (750 kg)
Permissible trailer load, braked (at a minimum gradient-climbing capability of 12% from a standstill)	7716 lbs (3500 kg)
Permissible rear axle load when towing a trailer (the drawbar noseweight is not included in the towing weight)	4189 lbs (1900 kg)

Trailer drawbar noseweight

Number of people 150 lbs (68 kg) each	Seat occupancy	Trunk load	Maximum drawbar noseweight
2	Front seats	220 lbs (100 kg)	562 lbs (255 kg)
3	2 front seats 1 rear seat	176 lbs (80 kg)	562 lbs (255 kg)
4	2 front seats 2 Rear seats	132 lbs (60 kg)	456 lbs (207 kg)
5	2 front seats 3 rear seats	0 lbs (0 kg)	423 lbs (192 kg)

The actual noseweight may not be higher than the value which is given. The value can be found on the trailer tow hitch or trailer identification plates. The lowest weight applies.

The maximum permissible trailer drawbar noseweight is the maximum weight with which the trailer drawbar can be loaded. Limit for Mercedes-Benz-approved trailer couplings.

Ball position

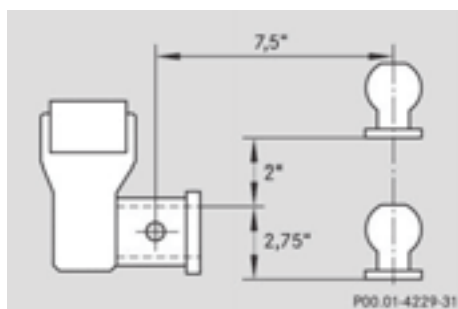

Ball position of the ball coupling

When choosing a ball coupling, the dimensions stated in the illustration must not be exceeded.

