

HANDBOOK



PEUGEOT 108





On-line handbook

Select one of the following means of access to view your handbook on-line...

Find your handbook on the Peugeot website, under "MyPeugeot".

Scan this code for direct access to your handbook.



If the "MyPeugeot" function is not available on the Peugeot public website for your country, you can find your handbook at the following address:

<http://public.servicebox.peugeot.com/ddb/>

Select:

- > the language,
- > the vehicle, its body style,
- > the print edition of your handbook appropriate for the date of registration of your vehicle.

Referring to the handbook on-line also gives you access to the latest information available, easily identified by the bookmark, associated with this symbol:



WeLCOMe

Your vehicle is fitted with only some of the equipment described in this document, depending on its trim level, version and the specification for the country in which it was sold.

! **We draw your attention to the following point:**
The fitting of electrical equipment or accessories which are not recommended by Peugeot may result in a failure of your vehicle's electronic system. Contact a Peugeot dealer to be shown the recommended equipment and accessories.

Thank you for choosing a 108.

This handbook has been designed to enable you to make the most of your 108 in all circumstances.

Key

! Warning:

this symbol marks warnings which it is essential to observe for your own safety, for the safety of others or to avoid any risk of damaging your vehicle.

♻️ Protection of the environment:

this symbol accompanies advice relating to protection of the environment.

i Information:

this symbol draws your attention to additional information for better use of your vehicle.

▶ Page reference:

this symbol invites you to refer to the pages which provide details of the function.

Contents

<p>Overview 1</p> <hr/> <p>eco-driving</p> <hr/> <p>Monitoring 1</p> <p>Instrument panel 10</p> <p>Rev counter 10</p> <p>Display screens 11</p> <p>Indicator and warning lamps 13</p> <p>Indicators 24</p> <p>trip computer 26</p> <p>Setting the time 28</p>	<p>Access 2</p> <p>Keys 30</p> <p>"Keyless entry and Starting" system 33</p> <p>Doors 38</p> <p>Boot 39</p> <p>Front electric windows 41</p> <p>Rear quarter windows 41</p> <p>electric fabric roof 42</p> <hr/> <p>Comfort 3</p> <p>Front seats 47</p> <p>Rear seats 49</p> <p>Mirrors 51</p> <p>Steering wheel adjustment 52</p> <p>Ventilation 53</p> <p>Heating 55</p> <p>Manual air conditioning 56</p> <p>Automatic air conditioning 58</p> <p>Front demist - defrost 62</p> <p>Rear screen demist - defrost 63</p> <hr/> <p>Fittings 4</p> <p>Interior fittings 64</p> <p>Rear parcel shelf 68</p> <p>Boot fittings 69</p>	<p>Driving 5</p> <p>Starting - stopping the engine with the key 71</p> <p>Starting - stopping the engine with the Keyless entry and Starting system 72</p> <p>Manual parking brake 76</p> <p>5-speed manual gearbox 76</p> <p>etg electronic gearbox 77</p> <p>gear shift indicator 81</p> <p>Hill start assist 82</p> <p>Stop & Start 83</p> <p>Speed limiter 86</p> <p>Reversing camera 92</p> <hr/> <p>Visibility 6</p> <p>Lighting control stalk 93</p> <p>Automatic illumination of headlamps 96</p> <p>Headlamp adjustment 98</p> <p>Wiper control stalk 99</p> <p>Courtesy lamp 101</p> <p>Boot lamp 101</p>
---	--	---

Safety 7	9	Technical data 11
<ul style="list-style-type: none"> Direction indicators 102 Horn 102 Hazard warning lamps 103 Under-inflation detection 103 eSC system 107 Seat belts 110 Airbags 113 	<ul style="list-style-type: none"> Fuel tank 134 Temporary puncture repair kit 136 Changing a wheel 141 Snow chains 146 Changing a bulb 147 Changing a fuse 152 12 V battery 161 electrical energy economy mode 164 Changing a wiper blade 164 Towing the vehicle 165 Fitting roof bars 166 Accessories 167 	<ul style="list-style-type: none"> engines 177 Weights 178 Dimensions 179 Identification markings 180 <hr/> <ul style="list-style-type: none"> Audio equipment and telematics 7-inch touch screen 181 Radio 221
Child safety 8	Checks 10	Visual search 12
<ul style="list-style-type: none"> Child seats 118 Deactivating the passenger's front airbag 121 ISOFIX child seats 127 Child lock 133 	<ul style="list-style-type: none"> Bonnet 170 Petrol engines 171 Checking levels 172 Checks 175 	<hr/> <ul style="list-style-type: none"> Alphabetical index 13

exterior

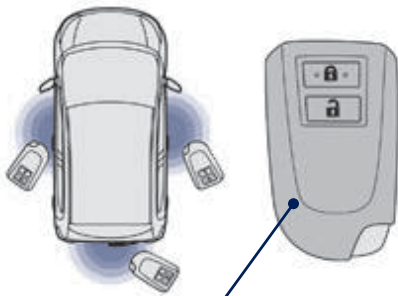

Electronic key: Keyless Entry and Starting

This system allows the locking, unlocking and starting the vehicle by keeping the key on your person and in the recognition zone.

▶ 33

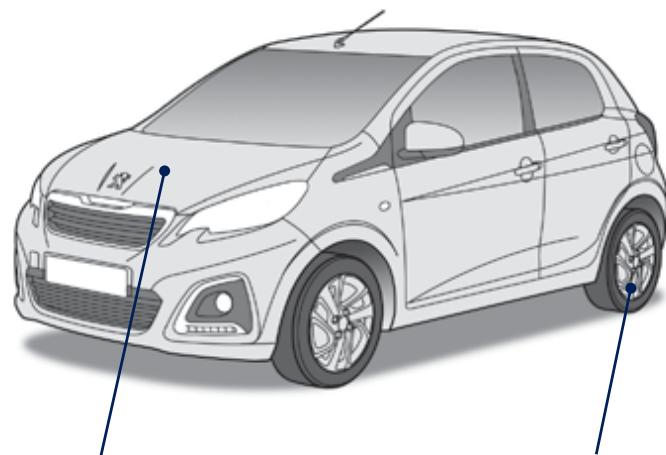

Stop & Start

This system puts the engine temporarily into standby during stops in the traffic (red lights, traffic jams, etc....). The engine restarts automatically as soon as you want to move off. The Stop & Start system reduces fuel consumption, exhaust emissions and the noise level when stationary.

▶ 83

Under-inflation detection

This system automatically checks the tyre pressures when driving and alerts you in the event of an under-inflated tyre.

▶ 103

exterior

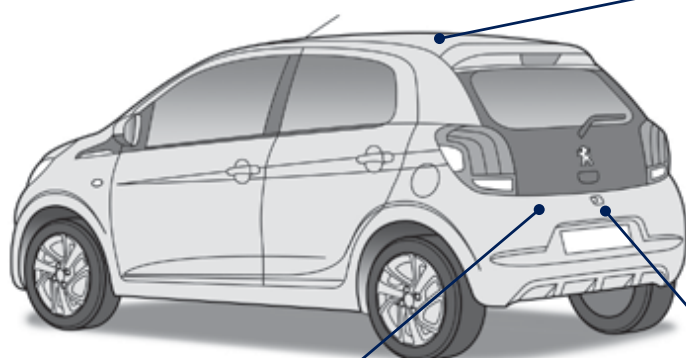
**Electric fabric roof**

This roof can be changed from closed to open configuration and then closed again with just a simple action on the control switch.

▶ 42

Temporary puncture repair kit

This kit is a complete system, consisting of a compressor and a sealant cartridge, for the temporary repair of a tyre.

▶ 136

Reversing camera

This system operates automatically when engaging reverse gear and provides an image in the touch screen.

▶ 92

Overview

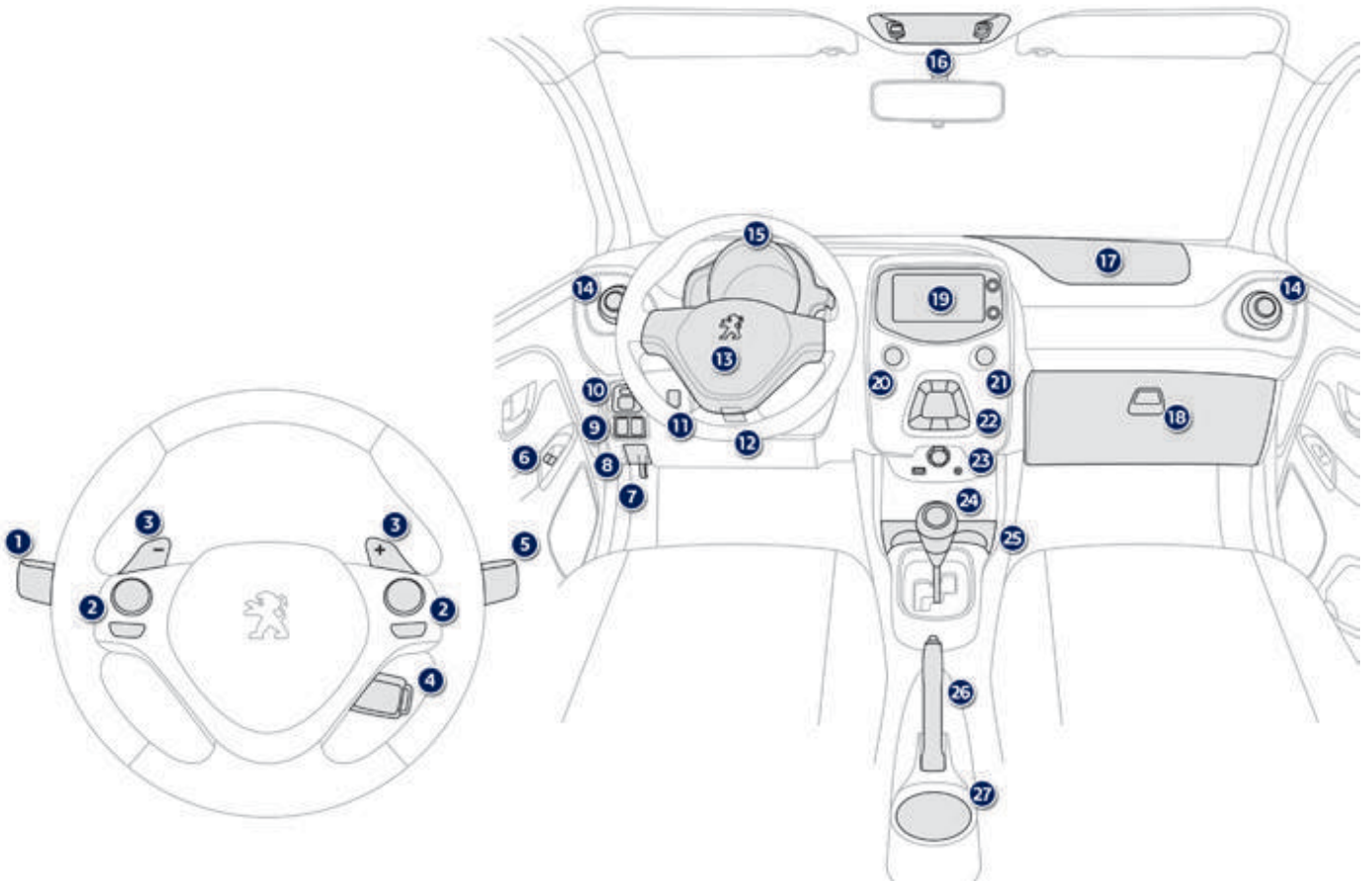

Instruments and controls

1. Lighting and direction indicator stalk
2. Steering mounted controls for the audio system or the touch screen
3. Steering mounted controls for the electronic gearbox
4. Speed limiter control
5. Screen wash/wipe control stalk
6. Electric window controls
7. Bonnet release
8. Fuel filler flap release
9. Deactivation of Stop & Start Headlamp height adjustment
10. Door mirror adjustment controls
11. Deactivation of VSC / ABS systems
12. Steering wheel adjustment control
13. Driver's front airbag
Horn
14. Side air vents
15. Instrument panel
16. Courtesy lamp
Electric fabric roof control
17. Passenger's front airbag
18. Glove box/
Deactivation of the passenger's front airbag/
Reinitialisation of the tyre under-inflation detection system
19. Radio, touch screen or open storage
20. Start/Stop button
21. Hazard warning lamps
22. Manual or automatic air conditioning controls
23. Auxiliary sockets for portable devices
24. Gear lever
25. Cup holder and storage
26. Parking brake
27. Can holder

eco-driving

eco-driving is a range of everyday practices that allow the motorist to optimise their fuel consumption and CO₂ emissions.

Optimise the use of your gearbox

With a manual gearbox, move off gently and change up without waiting. During acceleration change up early.

With an etg electronic gearbox, give preference to automatic (easy) mode and avoid pressing the accelerator pedal heavily or suddenly.

When the gear shift indicator invites you to engage the most suitable gear: as soon as the indication is displayed in the instrument panel, follow it straight away.

For vehicles fitted with an etg electronic gearbox, this indicator appears only in manual mode.

Drive smoothly

Maintain a safe distance between vehicles, use engine braking rather than the brake pedal, and press the accelerator progressively. These practices contribute towards a reduction in fuel consumption and CO₂ emissions and also help reduce the background traffic noise.

Control the use of your electrical equipment

Before moving off, if the passenger compartment is too warm, ventilate it by opening the windows and air vents before using the air conditioning. Above 30 mph (50 km/h), close the windows and leave the air vents open.

Remember to make use of equipment that can help keep the temperature in the passenger compartment down (sunroof and window blinds...).

Switch off the air conditioning, unless it has automatic regulation, as soon as the desired temperature is attained.

Switch off the demisting and defrosting controls, if not automatic.

Switch off the heated seat as soon as possible.

Switch off the headlamps and front foglamps when the level of light does not require their use.

Avoid running the engine before moving off, particularly in winter; your vehicle will warm up much faster while driving.

As a passenger, if you avoid connecting your multimedia devices (film, music, video game...), you will contribute towards limiting the consumption of electrical energy, and so of fuel.

Disconnect your portable devices before leaving the vehicle.

Limit the causes of excess consumption

Spread loads throughout the vehicle; place the heaviest items in the bottom of the boot, as close as possible to the rear seats.

Limit the loads carried in the vehicle and reduce wind resistance (roof bars, roof rack...). Use a roof box in preference.

Remove roof bars and roof racks after use.

At the end of winter, remove snow tyres and refit your summer tyres.

Observe the recommendations on maintenance

Check the tyre pressures regularly, when cold, referring to the label in the door aperture, driver's side.

Carry out this check in particular:

- before a long journey,
- at each change of season,
- after a long period out of use.

Don't forget the spare wheel and the tyres on any trailer or caravan.

Have your vehicle serviced regularly (engine oil, oil filter, air filter, passenger compartment filter...) and observe the schedule of operations recommended in the warranty and maintenance record.

When refuelling, do not continue after the third cut-off of the nozzle to avoid any overflow.

At the wheel of your new vehicle, it is only after the first 1 800 miles (3 000 kilometres) that you will see the fuel consumption settle down to a consistent average.

Instrument panel



1. Speedometer (mph or km/h).
2. Central display screen.
For more information, refer to the corresponding section.
3. gear shift indicator.
4. Display management button (Display).
Display of information in ascending order.
5. Display management button (Display).
Display of information in ascending order.

Rev counter*

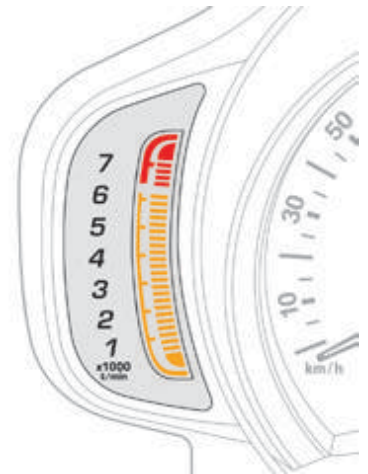

The engine speed is indicated by the display of orange bars. Above the maximum engine speed, the bars are displayed in red to indicate the need to change up.

* Depending on version.

Central display screen

The information displayed varies according to your vehicle's engine and type of gearbox.

Central display screen with the VTi 68 engine and manual gearbox



1. Ambient temperature.
It flashes if there is a risk of ice.
2. Vehicle information with:
 - total and trip distance recorders.
Refer to the corresponding section.
 - trip computer information.
Refer to the corresponding section.
 - Speed limiter information.
Refer to the corresponding section.
3. Fuel gauge.

Central display screen with the VTi 68 and ETG electronic gearbox



1. Gear lever position and gear engaged.
2. Vehicle information with:
 - total and trip distance recorders.
Refer to the corresponding section.
 - trip computer information.
Refer to the corresponding section.
 - Speed limiter information.
Refer to the corresponding section.
3. Fuel gauge.

Central display screen with the VTi 82 engine and manual gearbox



1. Speed limiter information.
Refer to the corresponding section.
2. Vehicle information with:
 - total and trip distance recorders.
Refer to the corresponding section.
 - trip computer information.
Refer to the corresponding section.
3. Fuel gauge.

Seat belts and passenger's front airbag warning lamps display screen



- A. Left hand rear seat belt unfastened warning.
- B. Right hand rear seat belt unfastened warning.
- C. Passenger's front airbag deactivated warning lamp.
- D. Passenger's front airbag activated warning lamp.

! Warning lamp **C** or **D** remains on, depending on the state of the passenger's front airbag (deactivated or activated).

Indicator and warning lamps

Visual indicators informing the driver that a system is in operation or is switched off (indicator lamp) or has a fault (warning lamp).

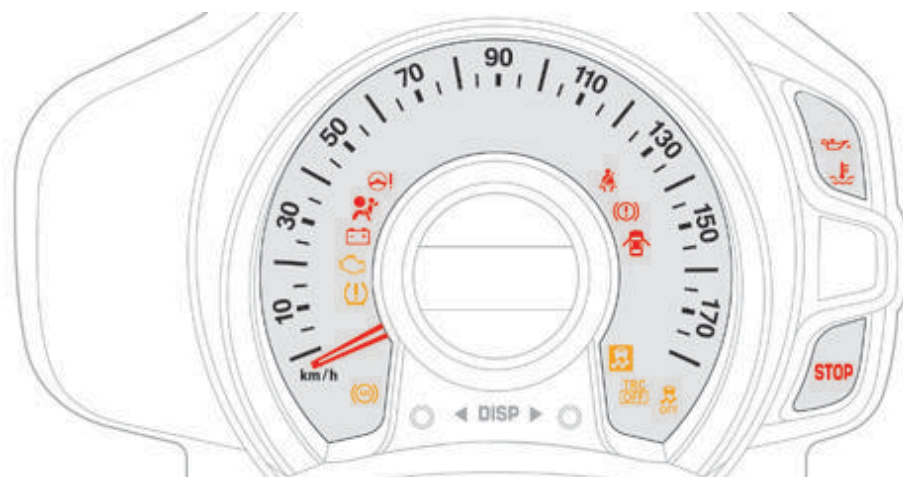

! Certain warning lamps may come on in one of two modes: fixed (continuous) or flashing. Only by relating the type of illumination to the operation of the vehicle can it be determined whether the situation is normal or a fault has occurred. Refer to the tables in the following pages for more information.

When the ignition is switched on

Certain warning lamps come on for a few seconds in the instrument panel when the vehicle's ignition is switched on.

When the engine is started, these same warning lamps should go off.

If they remain on, before moving off, refer to the information on the warning lamp concerned.







Associated warnings





the switching on of certain warning lamps may be accompanied by an audible signal.



the warning lamps may come on continuously (fixed) or flash.

Operation indicator lamps

Illumination of one of the following indicator lamps confirms that the corresponding system has been switched on. It may be accompanied by an audible signal.



Warning / indicator lamp		State	Cause	Action / Observations
	Left-hand direction indicator	flashing with buzzer.	the lighting stalk is pushed down.	
	Right-hand direction indicator	flashing with buzzer.	the lighting stalk is pushed up.	
	Sidelamps or dipped beam headlamps	fixed.	the sidelamps or dipped beam headlamps are on.	
	Main beam headlamps	fixed.	the lighting stalk is pulled towards you.	Pull the stalk to return to dipped beam headlamps.
	Front foglamps	fixed.	the front foglamps (if your vehicle has them) are switched on.	turn the ring on the stalk rearwards twice to switch off the front foglamps. Please note: if front foglamps have been fitted as an accessory, the control may be different.
	Rear foglamp	fixed.	the rear foglamp is switched on using the ring on the lighting control stalk.	turn the ring on the lighting control stalk to the rear to switch off the rear foglamp.

Warning / indicator lamp		State	Cause	Action / Observations
	Parking brake	fixed, accompanied by an audible signal.	the parking brake is applied or not properly released.	Release the parking brake to switch off the warning lamp, keeping your foot on the brake pedal. Observe the safety recommendations. For more information on the parking brake, refer to the corresponding section.
	Passenger's front airbag	fixed in the seat belt and passenger's front airbag warning lamps display.	the control switch, located in the glove box, has been placed in the "ON" position.	the passenger's front airbag is activated. In this case, do not install a "rearward facing" child seat.
	Stop & Start (e-VTi 68 engine)	fixed.	When the vehicle stops (red lights, traffic jams, ...) the Stop & Start system has put the engine into St OP mode.	the indicator lamp goes off and the engine restarts automatically in St ARt mode, as soon as you want to move off.
	Keyless Entry and Starting system	fixed.	the conditions for starting are met.	For more information, refer to the "Starting - stopping the engine with the Keyless entry and Starting system" section.
		flashing slowly.	the vehicle is in "ACC" mode. the accessories (audio system, 12V socket...) can be used.	

Warning / indicator lamp		State	Cause	Action / Observations
	Gear shift indicator.	fixed.	You can change up.	For more information, refer to the corresponding section.
			You can change down (only for the Vt i 68 engine).	
	Speed limiter (VTi 68 engine)	fixed.	the speed limiter is active.	

Deactivation indicator lamps

If one of the following indicator lamps comes on, this confirms that the corresponding system has been switched off intentionally. This may be accompanied by an audible signal.

Warning / indicator lamp	State	Cause	Action / Observations
 Passenger's front airbag	fixed, in the seat belt and front passenger's airbag warning lamps display.	the control switch, located in the glove box, is set to the OFF position.	the passenger's front airbag is deactivated. You can install a "rearward facing" child seat on the front seat unless there is a fault with the airbags (Airbag warning lamp on).
 Traction control (TRC)	fixed.	A brief press has been made on the button. the traction control (TRC) system is deactivated.	Press the button to activate the system. the TRC system is activated automatically when the vehicle is started. If deactivated, the system is reactivated automatically from around 30 mph (50 km/h). For more information, refer to the corresponding section.
 Dynamic stability control (DSC)	fixed.	Vehicle stationary , the button has been pressed for more than 3 seconds. the traction control (TRC) and dynamic stability control (DSC) systems are deactivated.	Press this button to activate the systems. the DSC system is activated automatically when the vehicle is started. For more information, refer to the corresponding section.

Monitoring



Warning / indicator lamp		State	Cause	Action / Observations
	Stop & Start (e-VTI 68 engine)	fixed.	the Stop & Start system has been deactivated.	Reactivate the function by pressing the button again. For more information, refer to the corresponding section.





Warning lamps



When the engine is running or the vehicle is being driven, illumination of one of the following warning lamps indicates a fault which requires action on the part of the driver.





Any fault resulting in the illumination of a warning lamp must be investigated further.





If you encounter any problems, do not hesitate to contact a Peugeot dealer or a qualified workshop.

Warning / indicator lamp		State	Cause	Action / Observations
STOP	STOP	flashing, associated with another warning lamp.	It is associated with the engine oil pressure or the engine coolant temperature.	Stop as soon as it is safe to do so. Park, switch off the ignition and call a Peugeot dealer or qualified workshop.
	Braking	fixed.	the braking system fluid level has dropped significantly.	top up with brake fluid recommended by Peugeot. If the problem persists, have the system checked by a Peugeot dealer or a qualified workshop.
			the braking system has a fault.	Stop as soon as it is safe to do so. Park, switch off the ignition and contact a Peugeot dealer or a qualified workshop.
	Engine oil pressure	fixed, associated with the STOP warning lamp.	the engine oil pressure is too low.	Stop as soon as it is safe to do so. Park, switch off the ignition and contact a Peugeot dealer or a qualified workshop.

Warning / indicator lamp		State	Cause	Action / Observations
	Coolant temperature	flashing (Vt i 68 engine only).	t he temperature of the engine coolant is increasing.	Drive gently.
		fixed.	t he temperature of the engine coolant is too high.	Stop as soon as it is safe to do so. Wait until the engine has cooled down before checking up the level; top up if necessary. If the problem persists, contact a Peugeot dealer or qualified workshop.
	Anti-lock Braking System (ABS)	fixed.	t he anti-lock braking system has a fault.	t he vehicle retains conventional braking. Drive carefully at reduced speed and contact a Peugeot dealer or a qualified workshop without delay.
	Dynamic stability control and traction control (DSC/TRC)	flashing.	t he DSC/t RC system is in action.	t he system optimises traction and improves the directional stability of the vehicle.
		fixed.	t he DSC/t RC system has a fault.	Have it checked by a Peugeot dealer or a qualified workshop.
	Emission control system	fixed.	t he emission control system has a fault.	Contact a Peugeot dealer or a qualified workshop without delay.
	Engine fault	fixed.	A major fault has been detected that does not have a specific warning lamp.	You must contact a Peugeot dealer or a qualified workshop.

Warning / indicator lamp		State	Cause	Action / Observations
	Low fuel level	fixed.	When it first comes on there remains approximately 5 litres of fuel in the tank.	You must refuel as soon as possible to avoid running out of fuel. This warning lamp will come on every time the ignition is switched on, until a sufficient addition of fuel is made. Fuel tank capacity: approximately 35 litres. Never continue to drive until you run out of fuel as this could damage the emission control and injection systems.
	Battery charge	fixed.	the battery charging circuit has a fault (dirty or loose terminals, slack or cut alternator belt, ...).	Contact a Peugeot dealer or a qualified workshop.
	Front seat belts	flashing accompanied by an audible signal.	the driver has not fastened or has unfastened their seat belt. the front passenger has unfastened their seat belt.	Pull the strap then insert the tongue in the buckle.

Warning / indicator lamp		State	Cause	Action / Observations
	Airbags	fixed.	One of the airbags or seat belt pretensioners has a fault.	Have it checked by a Peugeot dealer or a qualified workshop.
	ETG electronic gearbox	fixed.	the etg electronic gearbox has a fault.	Contact a Peugeot dealer or a qualified workshop without delay.
	Clutch	flashing, accompanied by an audible signal.	the clutch temperature is too high.	Stop as soon as it is safe to do so, place the etg electronic gearbox in position N , and wait about 15 minutes for the clutch cools down.
	Electric power steering	flashing or fixed, accompanied by an audible signal.	the electric power steering has a fault.	Drive carefully at reduced speed. Have it checked by a Peugeot dealer or qualified workshop.
	Under-inflation	fixed.	the pressure in one or more wheels is too low.	Check the pressure of the tyres as soon as possible. This check should preferably be carried out when the tyres are cold. You must reinitialise the system after the adjustment of one or more tyre pressures and after changing one or more wheels. For more information, refer to the "under-inflation detection" section.

Warning / indicator lamp		State	Cause	Action / Observations
	Stop & Start (e-VTi 68 engine)	flashing.	t he Stop & Start system has a fault.	Have the system checked by a Peugeot dealer or a qualified workshop.
	Speed limiter	fixed.	t he speed limiter has a fault.	Have it checked by a Peugeot dealer or a qualified workshop.
	Door(s) open / Boot open	fixed, accompanied by an audible signal.	A door or the boot is still open.	Close the door or boot.
	Keyless Entry and Starting system	flashing quickly.	t he steering column has not been unlocked.	Change to " OFF " mode, then " ON " mode and turn the wheel slightly to unlock the steering column.
		flashing, accompanied by an audible signal.	t he battery in the electronic key is discharged.	Replace the battery. Refer to the corresponding section.
			You are leaving the vehicle without activating " OFF " mode.	With the electronic key on your person, press the St ART /St OP button to change to " OFF " mode.
			t he electronic key has not been detected.	Check that you have the electronic key with you.
			t he Keyless entry and Starting system has a fault.	Have the system checked by a Peugeot dealer or a qualified workshop.

Indicators

Total/trip distance recorder



When the ignition is switched on, the distance recorder selected when the engine was switched off is displayed.



Press one of the buttons 1 to alternate the distance display:

- total with "ODO" (odometer) displayed,
- trip with "TRIP" displayed.

To reset the trip recorder to zero, when it is displayed, press and hold one of the two buttons 1.

Fuel gauge

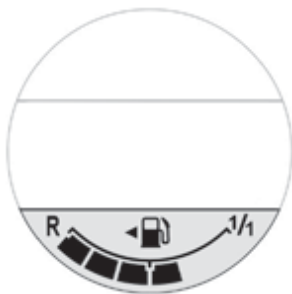

This indicates the quantity of fuel available:

- **1/1** and six bars, the fuel tank is full.
- **R** and one bar flashing, the fuel tank is on the reserve.

Low fuel level

When the low level in the fuel tank is reached, the last bar flashes accompanied by an audible signal.

You have approximately 5 litres remaining.

When the frequency of the flashing increases, **you have approximately 3 litres remaining.**

i At least 5 litres must be added after running out of fuel.

Trip computer

System that gives you information on the journey in progress (range, fuel consumption...).

Information display



- ☞ Press one of these buttons to display the various trip computer tabs in turn:
 - the total distance.
 - the trip "A".
 - the trip "B".
 - the Stop & Start partial time counter*.
 - the Stop & Start global time counter*.
 - the ambient temperature*.
 - the current fuel consumption.
 - the average fuel consumption.
 - the remaining range.
 - the average speed.
 - the lighting dimmer.

Lighting dimmer

System for the manual adjustment of the brightness of the instrument panel to suit the ambient light level.

It operates only when the sidelamps are on.

- ☞ When the "Lighting dimmer" menu is displayed, press and hold one of the buttons for access to the adjustment.
- ☞ then make repeated presses on one of the two buttons to increase or reduce the brightness.
- ☞ the display flashes to show you the brightness chosen.

Trip zero reset



- ☞ When the trip required is displayed, press one of the two buttons for more than two seconds.
- Trips "A" and "B" are independent but their use is identical.
- For example, trip "A" can be used for daily figures, and trip "B" for monthly figures.

* Depending on version.

With the touch screen

If your vehicle has a touch screen, you can view information on the current journey.



From the **Menu** page in the touch screen :

Select the **"Vehicle information"** tab. The **"Trip information"** window is displayed with the following information:

- **"Average speed"**,
- **"Elapsed time"**,
- **"Range"**,
- the current fuel consumption, presented in graphical form.

The **"Erase"** button resets the fuel consumption data in the touch screen and the instrument panel.

Trip computer, a few definitions

Range

(miles or km)

It is the distance which can still be travelled with the fuel remaining in the tank (related to the average fuel consumption over the last few miles (kilometres) travelled).

i This value may vary following a change in the style of driving or the relief, resulting in a significant change in the current fuel consumption.

When the fuel level is low, the message "Low Fuel" is displayed.

If only a small amount of fuel is added, the range may not be recalculated.

Current fuel consumption

(mpg or l/100 km or km/l)

Calculated over the last few seconds.

Average fuel consumption

(mpg or l/100 km or km/l)

Calculated since the last trip computer reset.

Average speed

(mph or km/h)

Calculated since the last trip computer reset.

Stop & Start time counter

(minutes / seconds or hours / minutes)

If your vehicle is fitted with Stop & Start, a time counter calculates the time spent in Stop mode during a journey.

It resets to zero every time the ignition is switched on.

Setting the time Radio

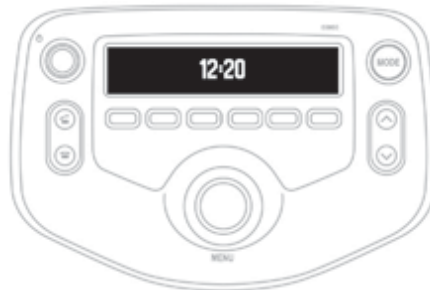
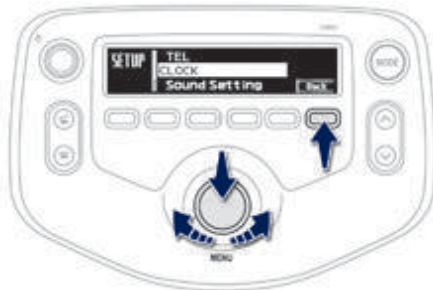

The time is adjusted using the "MENU" knob:

- press the knob for access to menus and to confirm a selection,
- turn the knob to select a function, an item in a list.

You can go back to the previous step at any time by using the "Back" button.

- ☞ Press the knob for access to the menus.
- ☞ Turn the knob to select "CLOCK".
- ☞ Press the knob to confirm. The hours figure flashes.
- ☞ Turn the knob to adjust the hours.
- ☞ Press the knob to confirm. The minutes figure flashes.
- ☞ Turn the knob to adjust the minutes.
- ☞ Press the knob to confirm and quit the menu.

Touch screen

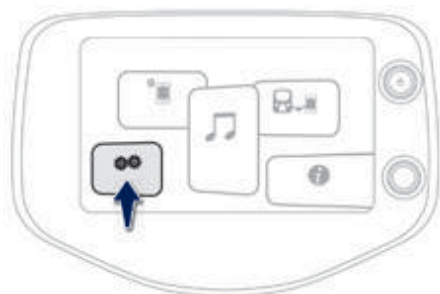

Press on "**Configuration**".



Press on "**General**".



Select "**Clock**".

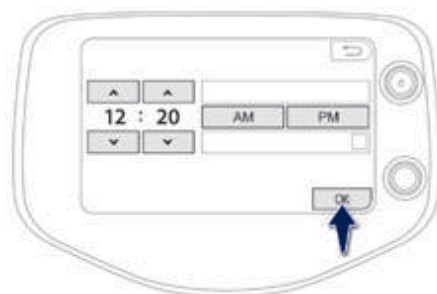

Adjust the hours and minutes using the virtual arrows in the screen.

Choose the time format.

Press on "**OK**" to confirm and quit the menu.

Keys

The keys allow you to switch on the ignition and operate the locks on the front doors, the boot, the steering lock and the passenger's front airbag deactivation switch.

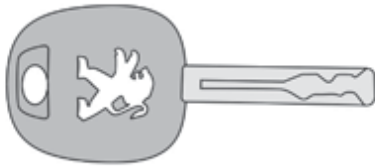

Locking

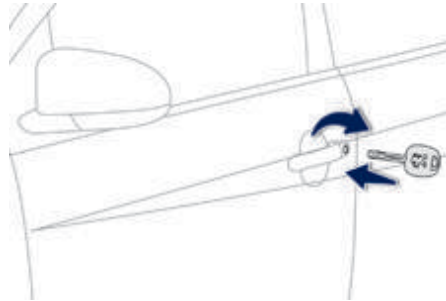

- Insert the key in one of the front door lock barrels and turn it towards the rear of the vehicle to lock the door in question.
- Insert the key in the boot lock barrel and turn it to the right to lock the boot.

Unlocking

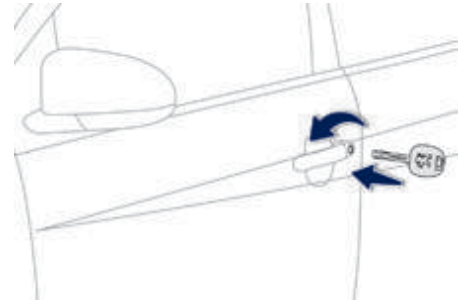

- Insert the key in one of the front door lock barrels and turn it towards the front of the vehicle to unlock the door in question.
- Insert the key in the boot lock barrel and turn it to the left to unlock the boot.

Remote control

This is used to lock, unlock and locate the vehicle at a distance.

Unfolding / Folding the key

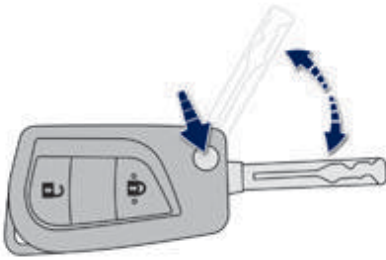

Press this button to unfold / fold the key.

Locking



Press the closed padlock to lock the vehicle.

The direction indicators flash once.

i After locking, if you notice that a door is not closed properly, close it then lock the vehicle again.

Unlocking



Press the open padlock to unlock the vehicle.

The direction indicators flash twice.

If the vehicle is unlocked and then none of the doors is opened, the vehicle will automatically lock itself again after about thirty seconds.

Locating your vehicle



Press the closed padlock to locate your locked vehicle in a car park.

This is indicated by lighting of the direction indicators for a few seconds.

i The high frequency remote control is a sensitive system; do not handle it in your pockets as there is a risk that it may unlock the vehicle without you being aware of this. Avoid pressing the buttons of your remote control out of range of your vehicle, you risk rendering it inoperative.

Changing the remote control battery

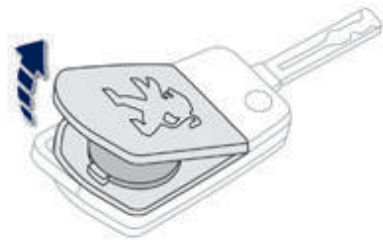

Battery ref.: CR 2016 / 3 volts.

- ☛ unclip the cover using a small screwdriver in the cut-out.
- ☛ Lift of the cover.
- ☛ Remove the old battery from its housing.
- ☛ Fit the new battery in its place, observing the direction of fitment.
- ☛ Clip the cover in place.

♻️ Do not discard the remote control batteries, they contain metals which are harmful to the environment. Take them to a Peugeot dealer, or to an approved collection point.

Electronic engine immobiliser

This locks the engine management system as soon as the ignition has been switched off and therefore prevents starting of the vehicle by anyone who does not have the key.

The ignition key has an electronic chip which has a special code. When the ignition is switched on, the code must be recognised for starting to be possible. In the event of a malfunction, your vehicle will not start.

Contact a Peugeot dealer or a qualified workshop.

! Do not make any modifications to the electronic immobiliser system.

"Keyless entry and Starting" system

System that allows the opening, closing and starting of the vehicle while keeping the electronic key on your person.

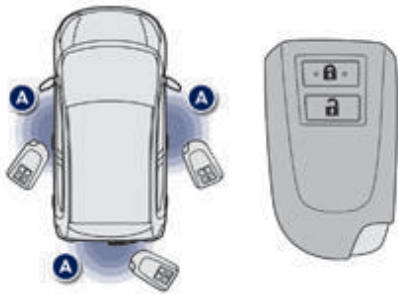

Unlocking the vehicle

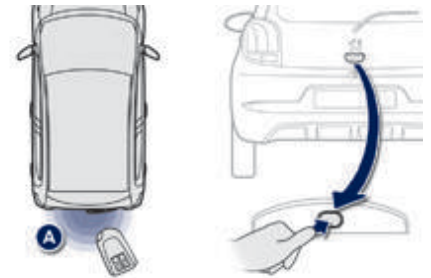
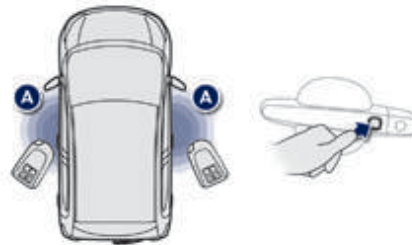

Electronic key

This electronic key can also be used as a remote control.

Refer to the "Remote control" section. It includes an integral emergency key.

i As a safety measure, the detection zones in which the the electronic key is operational have a radius of about 70 cm around each opening button.

Unlocking by the doors

- ☞ With the electronic key on your person and in one of the recognition zones **A**, press one of the buttons on the door handles to unlock the vehicle. Then pull on the door handle to open the door.

Unlocking by the boot

- ☞ With the electronic key on your person and in the recognition zone **A** located at the rear, press the button on the boot handle to unlock the vehicle and release the tailgate. Then raise the tailgate to open it.

i The direction indicators flash twice to confirm the unlocking of the vehicle.

Locking the vehicle



Locking

☞ With the electronic key in the recognition zone **A**, press one of the buttons on the front door handles or press the button on the boot sill.

i The direction indicators flash once.

i If one of the doors or the boot is still open or if the electronic key for the Keyless entry and Starting system has been left inside the vehicle, you are warned by an audible signal and the central locking does not take place.

! Never expose the electronic key to extreme temperatures (below -20°C or above $+60^{\circ}\text{C}$); this could cause faults.

i If the electronic key is left inside the vehicle after switching off the engine, there is a continuous audible signal on opening the driver's door.

! For reasons of safety and theft protection, do not leave your electronic key in the vehicle, even when you are close to it. It is recommended that you keep it on your person.

i If the vehicle is unlocked and no door or the boot is opened, the vehicle will lock again automatically after about thirty seconds.

Emergency procedure



The integral key is used to lock and unlock the vehicle when the electronic key cannot operate and in the event of a fault with the Keyless entry and Starting system:

- cell battery discharged, vehicle battery discharged or disconnected, ...
 - vehicle located in an area with strong electromagnetic signals.
- ☞ Press and hold the latch **1** to extract the integral key **2**.

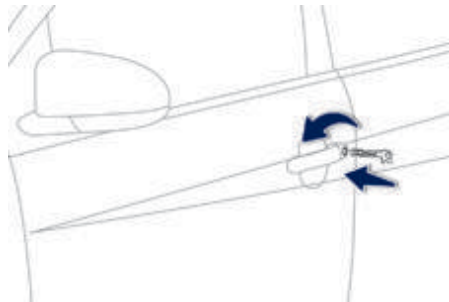

Unlocking

- ☞ Insert the integral key into the driver's door lock barrel and turn it towards the front of the vehicle to unlock the vehicle.

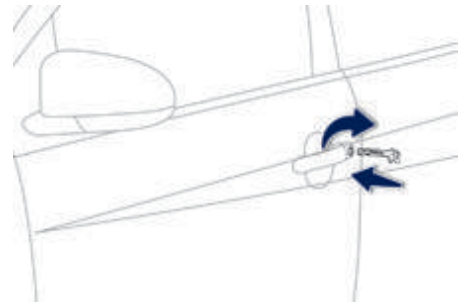

Locking

- ☞ Insert the integral key into the driver's door lock barrel and turn it towards the rear of the vehicle to lock the vehicle.

Saving the electronic key battery

To preserve the battery, it is possible to prevent the electronic key working (no reception of radio waves).



- ☞ Press on the open padlock twice, while pressing on and holding the closed padlock.



Check that the indicator lamp in the electronic key flashes 4 times.

When this function is activated, the "Keyless entry and Starting" system is inoperative.

To reactivate the electronic key, press one of the buttons (open or closed padlock).

Changing the battery of the electronic key

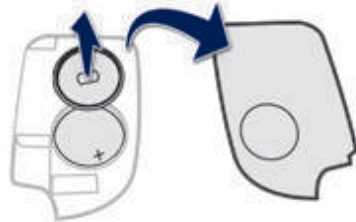

Battery ref.: CR2032 / 3 volts.



When replacement of the battery is needed, this warning lamp comes on in the instrument panel.

- ☞ Unclip the cover using a small screwdriver at the cutout.
- ☞ Remove the cover.
- ☞ Remove the protective battery holder, pulling it upwards.
- ☞ Remove the discharged battery from its housing.
- ☞ Fit the new battery into its housing observing the original direction of fitment.
- ☞ Refit the battery holder.
- ☞ Clip the cover onto the casing.

! Lost keys

Go to a Peugeot dealer with the vehicle's registration document, your personal identification documents and if possible the key code label. The Peugeot dealer will be able to look up the key code and the transponder code required to order a new key.

Remote control / Electronic key

These high frequency devices are sensitive systems; do not handle them while in your pocket as there is a risk of unlocking the vehicle, without you being aware of it. Do not repeatedly press the buttons of your remote control or electronic key out of range and out of sight of your vehicle. You run the risk of stopping it from working and the remote control would have to be reinitialised.

Locking the vehicle

As a safety precaution, never leave children alone in the vehicle, except for a very short period. In all cases, it is essential to remove the key from the ignition switch, or take the electronic key with you when leaving the vehicle.

When purchasing a second-hand vehicle

Have the pairing of all of the keys in your possession checked by a Peugeot dealer, to ensure that only your keys can be used to open and start the vehicle.

Doors

Locking/unlocking from the inside

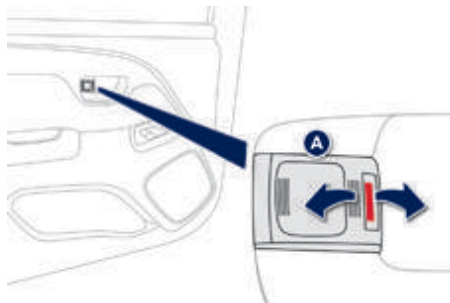

To lock/unlock a door, press/pull button **A**.

Vehicles without central locking

Pressing button **A** locks/unlocks the driver's door only.

Vehicles with central locking

Pressing button **A**, driver's side, locks/unlocks all of the doors and the boot.

Pressing button **A**, passenger's side, locks/unlocks just that door.

Door open



If a door is open, the courtesy lamp remains on if the button is in this position.

i Operating the handle always opens the door, even if it is locked.

! Driving with the doors locked may make access to the passenger compartment by the emergency services more difficult in an emergency.

Locking / unlocking and opening the boot

Using the key

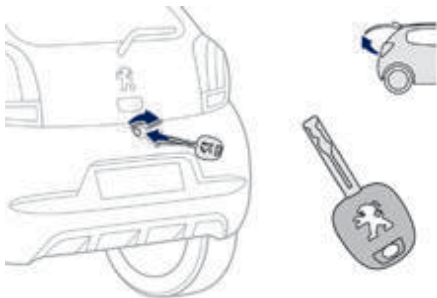

- Insert the key in the lock barrel and turn it to the right to unlock and release the tailgate. If the vehicle remains locked.
- Raise the tailgate by the exterior handle to open it.

As soon as you close the tailgate, it locks again.

Using the remote control

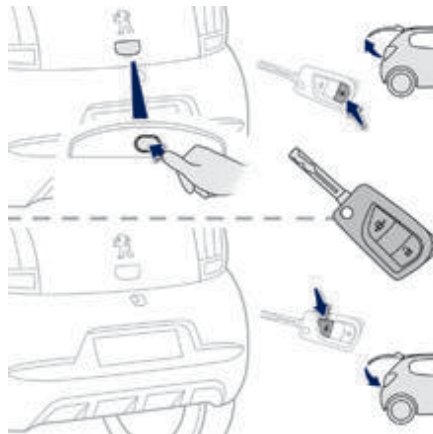

- ☞ Press the open padlock to unlock the vehicle and boot.

- ☞ Press the opening button to release the tailgate.
- ☞ Raise the tailgate by the exterior handle to open it.



- ☞ Press the closed padlock to unlock the boot and vehicle.

Using the Keyless Entry and Starting system

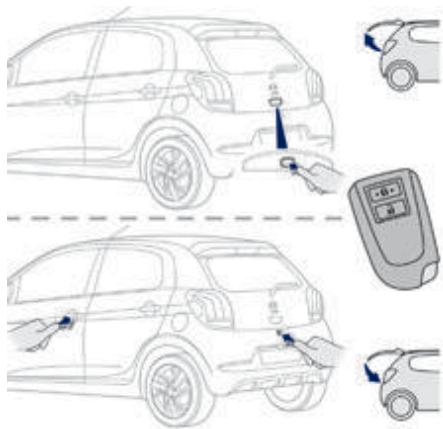

- ☞ With the electronic key on your person, press the boot opening control to unlock and release the tailgate. The vehicle is unlocked as well.
- ☞ Raise the tailgate by the exterior handle to open it.

If the vehicle had been previously unlocked by the front door, it is not necessary to have the electronic key on your person to use the boot opening control.

- ☞ With the electronic key on your person, press the button on the boot sill to lock it.
or
Lock the vehicle by the front doors.

! When closing the boot, do not slam shut the tailgate: guide it down and release it at the end of its travel.

Front electric windows*



1. Left hand front electric window.
2. Right hand front electric window.

After the ignition has been switched on, press one of the control switches to open or pull to close the window. The window stops when you release the control switch.

i The driver has controls for both front windows.

i The electric windows do not work with the ignition off.

! Closing the windows can cause serious injury. ensure that nothing is preventing the closing of the windows and take particular care with children.

* Depending on version.

Rear quarter windows

On the 5-door versions, system for ventilation of the rear seats by the partial opening of the window.

Opening



- ☞ Tilt the lever outwards.
- ☞ Push it fully to secure the window in the open position.

Closing

- ☞ Pull the lever to release the window.
- ☞ Tilt the lever fully inwards to secure the window in the closed position.

electric fabric roof*

Your vehicle may be fitted with an electrically operated fabric roof.

Electric opening and closing

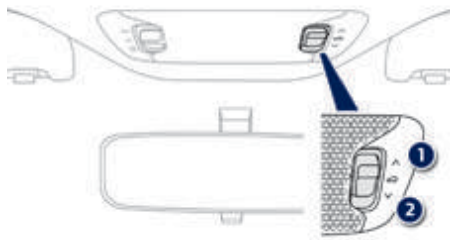

The roof is opened and closed by pressing the control at the interior lamp, in the opening direction **1** and in the closing direction **2**.

i The asymmetric shape of the opening control avoids closing the roof by mistake.

i Operation of the roof is possible with the ignition on and when driving.

! In order to maintain the state of charge of the battery, it is recommended that the roof be operated with the **engine running**.

i During operation of the roof with just the ignition on, starting the engine may cause the roof to stop, depending on the state of charge of the battery. To have the roof continue the operation, operate the control again after the engine has started.

! Operation of the roof could cause serious injuries: before operating the roof, ensure that no occupant of the vehicle or person outside the vehicle could be subject to any risk related to the movement of the roof and that no object could interfere with the operation.

* Depending on version.

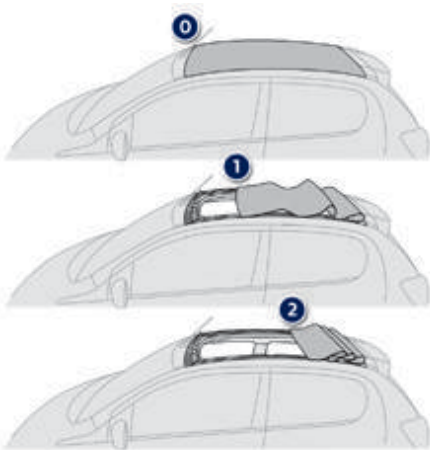

Opening

- ☞ Briefly press the control in the opening direction to open the the roof in stages.
- or
- ☞ Press and hold the control in the opening direction, until the manoeuvre is complete, to open the roof completely. Pressing again stops the movement of the roof.

Position of the roof

Position 0: Roof completely closed.

Position 1: Automatic stop position for the roof.

Position 2: Roof completely open.

Closing

- ☞ Briefly press the control in the closing direction to open the the roof in stages.
- or
- ☞ Press and hold the control in the closing direction, until the manoeuvre is complete, to close the roof to position **1**. Pressing again stops the movement of the roof.
- ☞ t o close the roof completely, press and hold the control (between positions **1** and **0**) until the roof locks closed.

! t he closing manoeuvre of the roof could cause serious injuries: take particular care with children.

If the roof does not close correctly:

- check that nothing is blocking the roof (ignition off),
- repeat the closing command (with the engine running).

If the problem persists, contact a Peugeot dealer or a qualified workshop.

Protection of the electric motors used for opening and closing the roof

Following repeated opening and closing of the roof, the electric motors may become too warm and no longer allow the roof to be opened or closed. Allow the motors to cool down with no operation of the roof for 10 minutes.

Operating fault

i In the event of an electrical fault, contact a Peugeot Ot dealer or a qualified workshop.

Aero-acoustic deflector

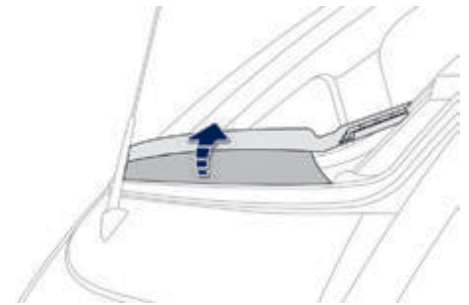

An aero-acoustic deflector is available to improve the acoustic comfort of occupants of the vehicle in certain driving conditions (high speed), by reducing the turbulence in the passenger compartment resulting from the displacement of air.

On opening the roof, the aero-acoustic deflector is deployed.

On closing the roof, the deflector folds away automatically.

Precautions for use

! Never place objects on the roof, whether open or closed.
Never sit on or place objects on the transverse roof support when the roof is open.

To avoid damaging the roof, do not open it under snowy or frosty conditions.

Never use sharp tools to remove ice or accumulations of snow on the roof.

To limit the creation of folds in the roof fabric, it is recommended that the roof not be left open for long periods.

The vehicle's air conditioning system should not be operated while the roof is open.

i In the event of prolonged storage of the vehicle outside, it is recommended that the roof be protected with a cover.

It is recommended that the roof be closed when the vehicle is left parked. Even if the roof is closed, it is prudent not to leave any valuable objects inside the vehicle.

When you leave the vehicle, switch off the ignition and remove the key (take the electronic key with you) to avoid any unwanted operation of the roof.

Recommendations on care of your vehicle

The general recommendations on the care of your vehicle are given in the warranty and maintenance record.

Fabric roof

i Before washing the fabric roof, first remove as much dirt as possible from the surface using a soft brush or a vacuum cleaner.

i To remove marks, sponge them (but never rub them) using soapy water, then immediately rinse with clean water.

! Never use chemical products, detergents, stain removers, solvents, alcohol, petrol, ... to clean the roof.

! To avoid damaging the roof.

- never use a high pressure jet wash,
- never wash your vehicle in an automatic roller-brush car wash.

! Remove bird droppings or tree resins as their acidity may damage the roof.

! To waterproof the roof, use only special waterproofing products for fabric roofs.

i Allow the vehicle to dry in a shaded area and avoid direct exposure to the sun.

i For the regular maintenance of the fabric roof and to conserve its original appearance, we recommend an ecological "Fly remover - Fabric roof cleaner" from the "t eCHNAt u Re" range. To obtain this product go to a Peugeot dealer.

Aero-acoustic deflector

i We recommend that you clean the aero-acoustic deflector **with care** using a soft brush.

Front seats with manual adjustments

As a safety measure, seat adjustments should only be carried out when stationary.

Forwards-backwards



- ☞ Raise the control and slide the seat forwards or backwards.

Seat backrest angle



- ☞ Take the weight of the backrest with your body.
- ☞ Turn the knob to obtain the desired angle.

Driver's seat height*

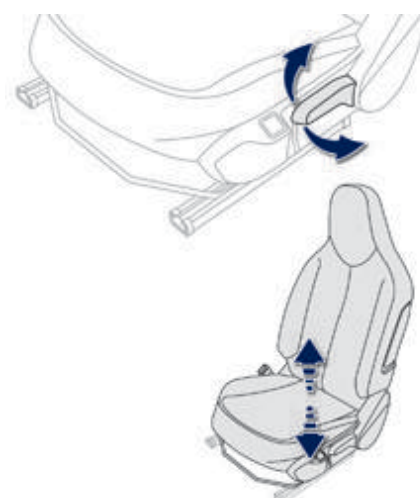

- ☞ Pull the control upwards to raise or push it downwards to lower, as many times as required, to obtain the position required.

* Depending on version.

i Before moving the seat backwards, ensure that there is nothing that might prevent the full travel of the seat, so as to avoid the risk of jamming the seat caused by the presence of objects on the floor behind the seat or rear passengers. If the seat jams, stop the movement immediately.

Heated seat control

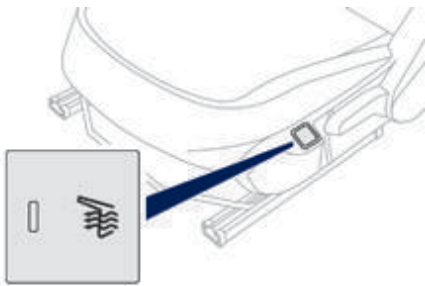

With the engine running, the front seats can be heated separately.

- ☞ Press the control switch. The indicator lamp comes on.
- ☞ Pressing the switch again stops the heating.

The temperature is controlled automatically.

The seat heating function is deactivated about two minutes after switching off the ignition. To reactivate it, switch the ignition on and press the control switch again.



Switch the seat heating off as soon as it is no longer needed, as reducing the vehicle's electrical current demand reduces fuel consumption.

Access to the rear seats (3-door)



- ☞ Pull this control toward you to fold the seat back and move the seat forward. When returning the seat to its initial position, guide it back until the seat and backrest lock into place.



ensure that no person or object prevents the seat slide from returning to its initial position. Check that the seat belt has reeled in correctly so as to not impede access for passengers to the rear seats.

Rear seats

Your vehicle is fitted with a fixed one-piece cushion bench rear seat, and depending on version:

- a folding split (50/50) backrest,
- a folding one-piece backrest.

Stowing the seat belts

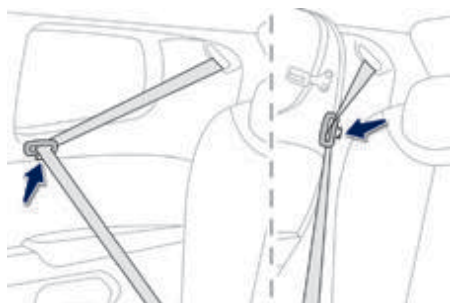

3-door

When not in use, or before folding the seat backrest(s), stow the rear seat belts by inserting their tongues in the dedicated holders, located on the side pillars.

5-door

Folding the seat backrest

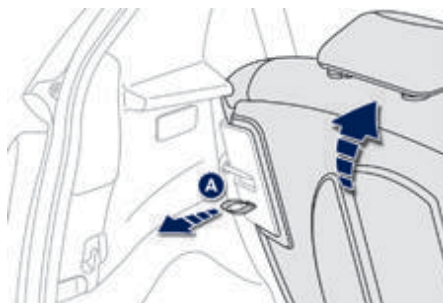

the seat backrest is folded from the rear of the vehicle, with the boot open.

- ☞ Place the head restraints in the low position. Refer to the "rear head restraints" section.
- ☞ Pull the strap(s) **A**, located behind the seat backrest(s) to release them, and lay them on the seat cushion.

Returning the backrest of the bench seat to its initial position

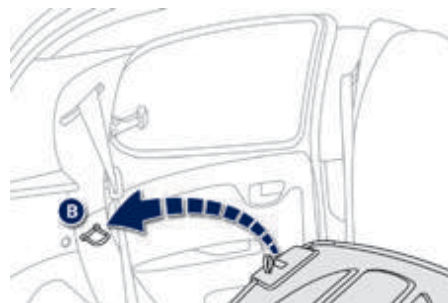

- ☞ unfold the backrest to the rear and engage it on the anchorage **B**.
- ☞ ensure that the seat back has locked in place correctly.

3

Rear head restraints*

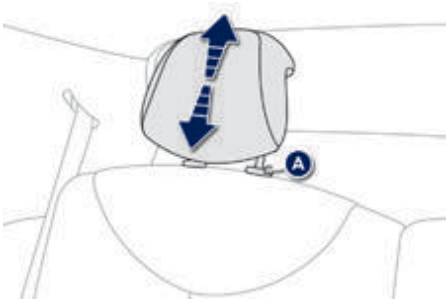

The rear head restraints can be removed and have two positions:

- high, position for use.
- low, storage position.

To raise the head restraint, pull it upwards.

To lower it, press lug **A** then the head restraint.

To remove it:

- tilt the seat back slightly,
- move the head restraint to the high position,
- press lug **A** pulling the head restraint upwards at the same time.

To refit it:

- tilt the seat back slightly,
- engage the rods of the head restraint in the openings.

To put the head restraint in the low position, press lug **A**.

* Depending on version.

Mirrors

Manual door mirrors

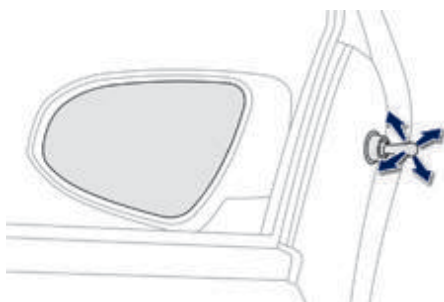

- ☞ Operate the lever in four directions to adjust the mirror.

Electric door mirrors



Adjustment

- ☞ Move control **A** to the right or to the left to select the corresponding mirror.
- ☞ Move control **B** in all four directions to adjust.
- ☞ Return control **A** to the central position.

! The objects observed are, in reality, closer than they appear. Take this into account in order to correctly judge the distance of vehicles approaching from behind.

Demisting - Defrosting



Use the heated rear window switch.

Refer to the "Rear screen demist - defrost" section.

Folding / Unfolding

When parking, the mirrors can be folded manually.

i The initial adjustments are retained when unfolding.

Steering wheel adjustment (with power steering)

Manual rear view mirror

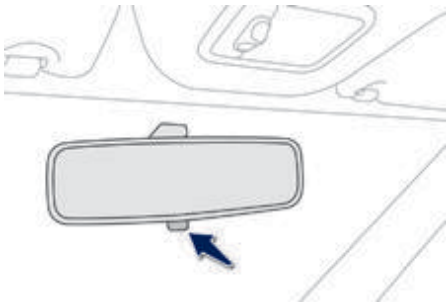

The rear view mirror has two positions:

- day (normal),
- night (anti-dazzle).

To change from one to the other, push or pull the lever on the lower edge of the mirror.



- ☞ **When stationary**, hold the steering wheel then lower the lever to release the adjustment mechanism.
- ☞ Adjust the steering wheel to the desired **height** and then raise the lever to lock the adjustment mechanism.

! For safety reasons, these operations must not be carried out while driving.

Correct driving position

Before taking to the road and to make the most of the ergonomics of your driving position, carry out these adjustments in the following order:

- backrest angle,
- cushion height,
- longitudinal position of the seat,
- height of the steering wheel,
- the interior and door mirrors.

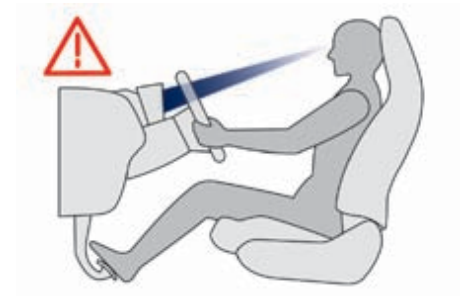

! Once these adjustments have been made, ensure that you can see the instrument panel clearly from your driving position.

Ventilation

1. Windscreen demisting/defrosting vent.
2. Centre vent.
3. Side vents.
4. Air outlets to the front footwells.
5. Air outlets to the rear footwells (depending on version).

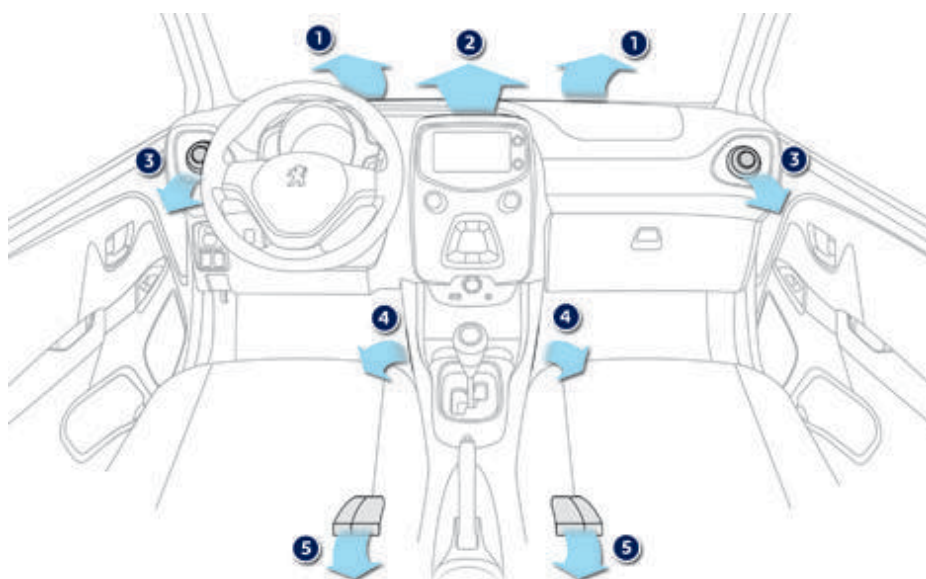

Recommendations for use

i If the interior temperature remains very high after a prolonged period parked in the sun, first ventilate the passenger compartment for a few minutes. For an even air distribution, make sure that you do not block the outside air inlet grille, the vents, the air passages and the air outlets to the footwells. ensure that the passenger compartment filter, located behind the glove box in the heater unit, is in good condition. Have the filter elements replaced regularly. If you drive in dusty conditions, change them twice as often. Operate the air conditioning system for 5 to 10 minutes, once or twice a month, to keep it in perfect working order. In order to ensure that your air conditioning system continues to operate correctly, you are advised to have it checked regularly. If the system does not produce cold air, do not use it and contact a Peugeot dealer or a qualified workshop.

i The condensation created by the air conditioning results in a flow of water under the vehicle when stationary which is perfectly normal.

 The air conditioning system does not contain chlorine and does not present any danger to the ozone layer.

Heating

The heating system works only when the engine is running.

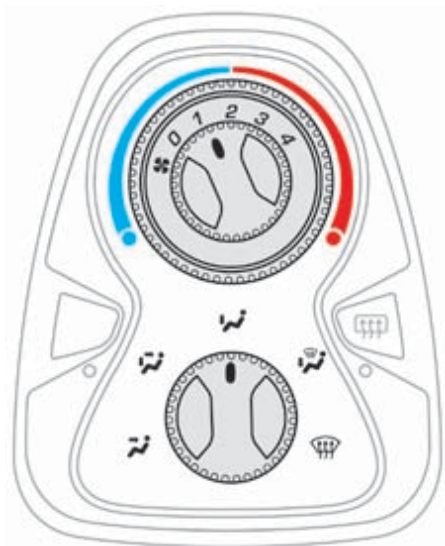

Temperature adjustment



Turn the control from blue (cold) to red (hot) to adjust the temperature to your wishes.

Air flow adjustment



Turn the knob from position 1 to 4 to obtain the desired flow of air.

! Avoid driving for too long without ventilation (risk of misting and deterioration of air quality).

Air distribution adjustment



Centre vent and side air vents.



Centre vent, side vents and footwells.



Footwells.



Windscreen and footwells.



Windscreen.

i The air distribution can be varied by placing the control in an intermediate position.

Manual air conditioning

This system only operates with the engine running.

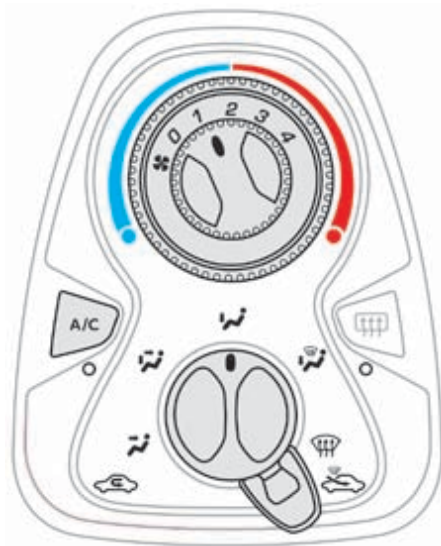

Temperature level adjustment



Turn the control knob from blue (cold) to red (hot) to adjust the temperature to your requirements.

Air flow adjustment



Turn the control knob from position 1 to position 4 to obtain a comfortable air flow.

If you put the air flow control in position 0 (system off), the temperature is no longer controlled. However, a slight flow of air can still be felt, resulting from the movement of the vehicle.

Air distribution adjustment



Centre and side vents.



Centre and side air vents, footwells.



Footwells.



Windscreen and footwells.



Windscreen.

Air intake / Air recirculation

The recirculation of interior air insulates the passenger compartment from exterior odours and smoke.

Return to exterior air intake as soon as possible to prevent deterioration of the air quality and the formation of mist.



- ☞ Move the manual control to the left for the "Recirculation of interior air" position.



- ☞ Move the manual control to the right to return to the "exterior air intake" position.

Air conditioning On / Off

A/C The air conditioning is designed to operate effectively in all seasons, with the windows closed.

It enables you to:

- lower the temperature, in summer,
- increase the effectiveness of the demisting in winter, above 3°C.

Switching on

- ☞ Press this button, the associated indicator lamp comes on.

i The air conditioning does not operate when the air flow adjustment is set to off.

Switching off

- ☞ Press the button again, the associated indicator lamp switches off.

Automatic air conditioning

The air conditioning operates when the engine is running.

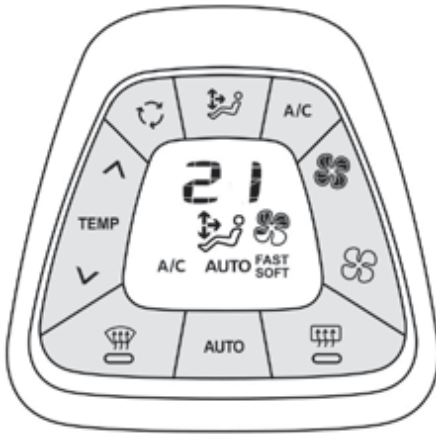

Automatic programme

We recommend that you use this mode. It provides optimised automatic control of all of the following functions: passenger compartment temperature, air flow, air distribution and air intake, in accordance with the comfort value that you have chosen. This system is designed to operate effectively in all seasons, with the windows and fabric roof closed.

For your comfort, when the engine is switched off, the settings are retained until the engine is switched on again.

To prevent too great a distribution of cold air when the engine is cold, the air flow will only reach its optimum level gradually.

AUTO

Press the "AUTO" button. The "AUTO" symbol comes on.

By pressing the "AUTO" button again, you can choose from one of the following settings in turn:

AUTO

Allows optimum operation of the system.

**AUTO
SOFT**

Offers temperature control while restricting air flow.

**FAST
AUTO**

Dynamic air distribution mainly towards the side air vents.

Manual override

It is possible to adjust one or more functions manually while leaving the other functions in automatic mode.

When the "AUTO" symbol switches off.

To return to automatic mode, press the "AUTO" button.

Switching to manual mode may not be suitable (temperature, humidity, odour, condensation) and does not provide optimum comfort.

Temperature adjustment

The value indicated in the screen corresponds to a level of comfort and not to a temperature in degrees Celsius or Fahrenheit.



Press this button downward to reduce the value and upward to increase it.

A setting around **21** gives optimum comfort. However, depending on your requirements, a setting between 18 and 24 is normal.

On entering the vehicle, if the interior is very cold or hot, there is no need to change the value displayed in order to reach the required level of comfort. The system corrects the temperature difference automatically and as quickly as possible.

i For maximum cooling or heating of the cabin, it is possible to go beyond the minimum 14 or maximum 28 value.

Press the temperature adjustment button down or up until "LO" or "HI" is displayed.

Air flow adjustment



Press this button to increase air flow.



Press this button to decrease air flow.

When the air flow symbol, the fan, fills progressively.

Air distribution adjustment



Press this button repeatedly to direct the air to:

- the centre and side air vents,
- the centre vent, side air vents and footwells,
- the footwells,
- the windscreen and footwells,
- the centre vent, side air vents and windscreen,
- the windscreen.

Air intake / Air recirculation



pressing this buttons isolates the passenger compartment from the outside air. the air recirculation symbol is displayed.

Air recirculation enables the passenger compartment to be isolated from exterior odours and smoke.

Press this button again or press the **"AUTO"** button to resume automatic management of the intake of air. the air recirculation symbol goes off.

! Avoid prolonged recirculation of interior air (risk of condensation or deterioration of the air quality).

Air conditioning on / off



Press this button to stop the air conditioning.

Stopping the air conditioning may cause some problems (humidity, misting). Automatic operation of the air conditioning is resumed when the button is pressed again. the **"A/C"** symbol is displayed.

Switching the system off



Press the air flow adjustment button until the fan symbol disappears.

This action switches off all of the functions of the air conditioning system.

Thermal comfort is no longer controlled. A slight flow of air resulting from the movement of the vehicle, remains perceptible however. Pressing the **"AUTO"** button again reactivates the system with the values set before it was switched off.



Avoid driving for long periods with the air conditioning switched off (risk of misting and reduction of the air quality in the cabin).

Front demist - defrost



These markings indicate the control positions for rapid demisting or defrosting of the windscreen and side windows.

During the winter period, direct the side air vents towards the side glasses to optimise their demisting and defrosting.

With the heating / ventilation system

- ☞ Put the temperature and air flow controls to the dedicated marked position.
- ☞ Put the air distribution control to the "Windscreen" position.

With the manual air conditioning system

- ☞ Put the temperature and air flow controls to the dedicated marked position.
- ☞ Put the air intake control to the "exterior air intake" position (manual control to the right).
- ☞ Put the air distribution control to the "Windscreen" position.
- ☞ Switch on the air conditioning by pressing the appropriate button; the indicator lamp in the button comes on.

With automatic air conditioning system

- ☞ Press this button.
The indicator lamp in the button comes on.
- ☞ Press this button again to switch it off.
The indicator lamp in the button goes off.

i Other settings (air flow, air distribution...) are controlled automatically.

Rear screen demist - defrost



The control button is located on the heating / ventilation or air conditioning system control panel.

Switching on

The heated rear screen can only operate when the engine is running.

- Press this button to demist/defrost the rear screen and, depending on version, the door mirrors. The indicator lamp associated with the button comes on.

Switching off

- Press this button again to switch off the heated rear screen. The indicator lamp associated with the button goes off.



- Switch off the demisting/defrosting of the rear screen and door mirrors (depending on version) as soon as appropriate, as lower current consumption results in reduced fuel consumption.

Front fittings

1. Sun visor.
2. Glove box.
3. Radio, touch screen or storage.
4. 12 volts accessory socket (120 W maxi).
Do not exceed the power rating to avoid
damaging your accessory.
5. USB port.
6. Auxiliary socket.
7. Storage or cup holder.
8. Cup holder.
9. Door pockets.
Storage for a bottle of water.

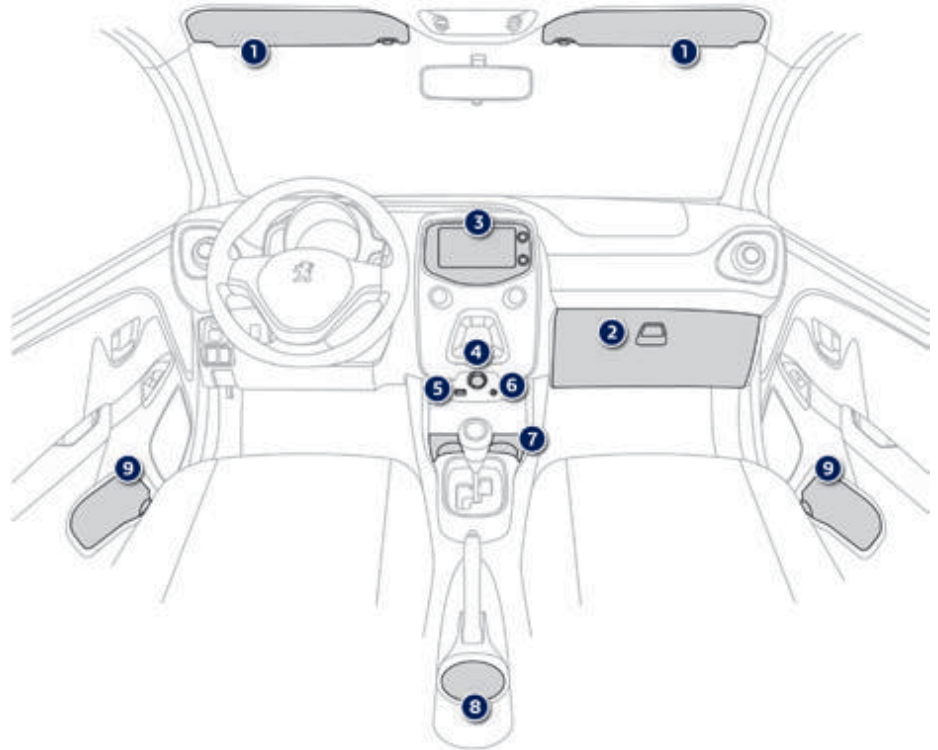

Sun visor

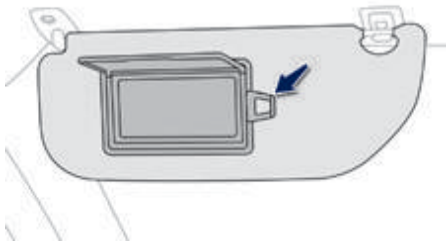

Component which protects against sunlight from the front or the side. All the sun visors are fitted with a vanity mirror, with a concealing flap and a map holder (or ticket holder).

Glove box

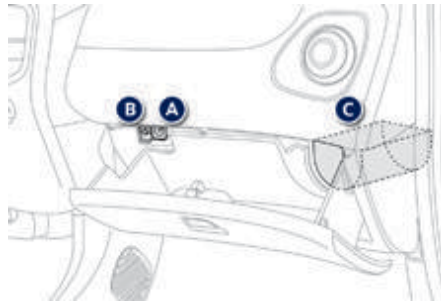

It can be used to hold the vehicle's handbook pack...
 To open the glove box, raise the handle. It houses the front passenger airbag deactivation switch **A** and the reinitialisation button (**B**) for the tyre under-inflation detection system (depending on equipment). On one side there is a location **C** intended to hold a water bottle (1 litre maximum).

12 V accessory socket



To connect a 12 V accessory (maximum power: 120 Watts), lift the cover and connect a suitable adaptor.

! Do not exceed the maximum power rating of the socket (risk of damage to your device).

4

USB port



It permits the connection of a portable device, such as a digital audio player of the iPod® type or uSB memory stick.

It reads the audio files which are sent to your audio system, to be heard via the vehicle's speakers.

You can manage these files using the steering mounted controls or those on the audio system control panel.

i Connected to the uSB port, the portable device charges automatically while in use.

For more information on the use of this equipment, see the "Audio equipment and telematics" section.

Auxiliary socket



It permits the connection of a portable device to listen to your music files using the vehicle's speakers.

the management of the files is done using your portable device.

i For more information on the use of this equipment, refer to the "Audio equipment and telematics" section.

Mats

Removable carpet protection.

Fitting

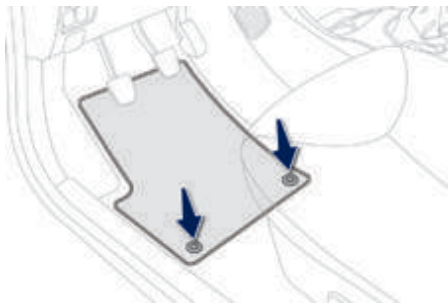

When fitting the mat for the first time, on the driver's side use only the fixings provided in the wallet attached.

The other mats are simply placed on the carpet.

Removal

To remove the mat on the driver's side:

- ☞ move the seat as far back as possible,
- ☞ unclip the fixings,
- ☞ remove the mat.

Refitting

To refit the mat on the driver's side:

- ☞ position the mat correctly,
- ☞ refit the fixings by pressing,
- ☞ check that the mat is secured correctly.

- !** To avoid any risk of jamming of the pedals:
- only use mats which are suited to the fixings already present in the vehicle; these fixings must be used,
 - never fit one mat on top of another.
- The use of mats not approved by Peugeot may interfere with access to the pedals and hinder the operation of the speed limiter or electronic gearbox.

Rear parcel shelf

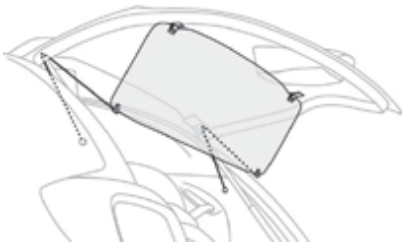

To facilitate loading of the boot, the rear parcel shelf is fitted to the tailgate.

When closing the tailgate, check that nothing could interfere with the return to position of the shelf.

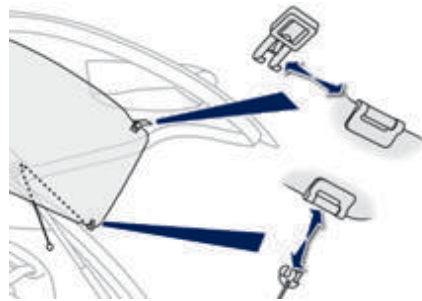

To remove the shelf:

- ☞ open the tailgate,
- ☞ unclip the two cords,
- ☞ pull firmly on the shelf to disengage it from its hinges on the tailgate inner trim.

You can then stow the shelf behind the front seats.



To refit the shelf:

- ☞ open the tailgate,
- ☞ position the underside of the shelf facing you,
- ☞ clip the shelf into the two hinges,
- ☞ pass the two cords through the guides either side of the struts,
- ☞ clip the two cords in place.

i Do not place heavy loads on the shelf, as they may cause the shelf to unclip.

Boot fittings

1. Hooks
2. Temporary use spare wheel and tools.
or
Storage box

! The wheel or storage box must be put in place under the carpet before loading the boot.

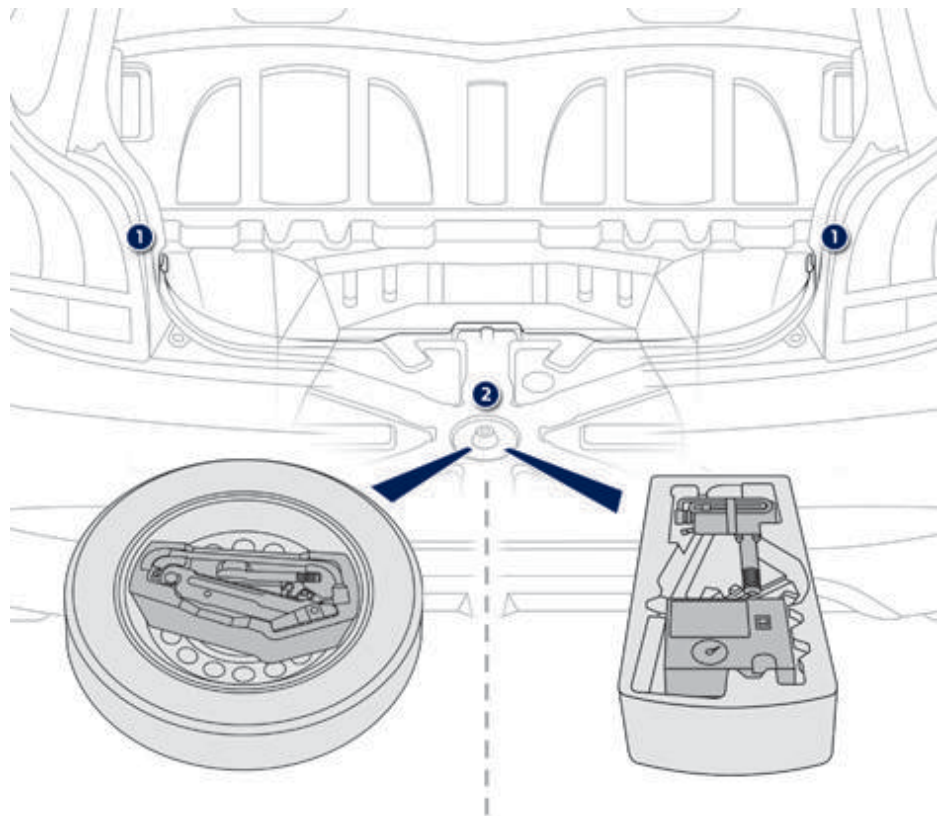

Hooks

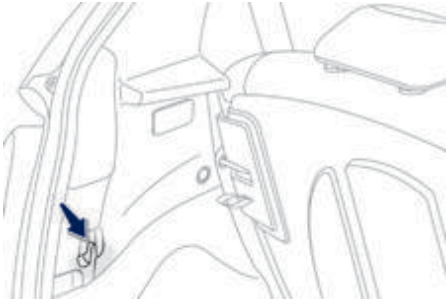

These hooks can be used to secure shopping bags.

! Maximum authorised load on the hooks: **2 kg**.

Storage box

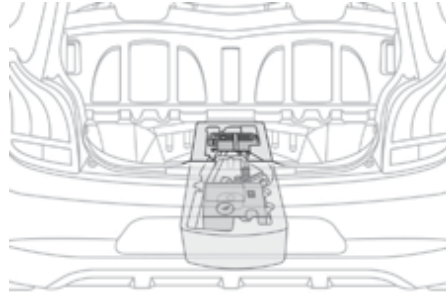

Remove the boot carpet for access to the storage box.

Depending on the configuration, it is laid out for storing:

- a towing eye,
- a temporary puncture repair kit,
- ...

! For versions with storage box: it must be in place before loading the boot.

Starting - stopping the engine with the key

Ignition switch



1. "LOCK" position.
2. "ACC" position.
3. "ON" position.
4. "START" position.

i If you use the accessories for a prolonged period (key in position **2** or **3**), you risk discharging the battery. Starting your vehicle will then no longer be possible. **Be aware.**

Starting using the key

For vehicle fitted with a manual gearbox:

- ☞ Insert the key in the ignition switch.
- ☞ Turn the key to position **2** and unlock the steering column, by turning wheel slightly.
- ☞ Fully depress the clutch pedal.
- ☞ Put the gear lever into neutral.
- ☞ Operate the starter by turning the key to position **4 (START)**.
- ☞ Once the engine is running, release the key.
The key returns automatically to position **3 (ON)**.

For vehicles fitted with an ETG electronic gearbox:

- ☞ Insert the key in the ignition switch.
- ☞ Turn the key to position **2** and unlock the steering column, by turning wheel slightly.
- ☞ **Press and hold the brake pedal.**
- ☞ Put the gear lever into position **N**.
- ☞ Operate the starter by turning the key to position **4 (START)**.
- ☞ Once the engine is running, release the key.
The key returns automatically to position **3 (ON)**.

Stopping

- ☞ Immobilise the vehicle.
- ☞ Put the gear lever into neutral (vehicles fitted with a manual gearbox), or position **N** (vehicles fitted with an etg electronic gearbox).
- ☞ Turn the key towards you to position **2 (ACC)**.
- ☞ Press in and turn the key to position **1 (LOCK)**.
- ☞ Remove the key from the ignition switch.
- ☞ Turn the steering until the steering column locks.

i Avoid attaching heavy objects to the key, which would weigh down on its blade in the ignition switch and could cause a malfunction.

i Key in ignition

If the key has been left in the ignition, an audible signal is heard on opening the driver's door.

Starting - stopping the engine with the Keyless entry and Starting system

Changing the mode of the vehicle



i If you use the accessories for a prolonged period, the vehicle will automatically switch to "OFF" mode after about 20 minutes.
Be aware in order to avoid discharging the battery.



With the electronic key inside the vehicle ; each press on the "START/STOP" button, with no action on the pedals, changes the vehicle's mode :

- ☞ First press ("ACC" mode).
The accessories (radio, 12V socket...) can be used.
- ☞ Second press ("ON" mode).
Ignition on.
- ☞ Third press ("OFF" mode).

Starting using the electronic key



With the first press on the "**START/STOP**" button, this indicator lamp flashes slowly in the instrument panel.

For vehicles fitted with a manual gearbox:

- With the electronic key inside the vehicle, put the gear lever into neutral and fully depress the clutch pedal.



This indicator lamp comes on in the instrument panel.



- Press and release the "**START/STOP**" button.

For vehicles fitted with an ETG electronic gearbox:

- With the electronic key inside the vehicle, put the gear lever at **N** and press the brake pedal.



This indicator lamp comes on in the instrument panel.



- Press and release the "**START/STOP**" button.



Depending on the ambient temperature, each attempt at starting can take up to around 30 seconds. During this period, do not press the "**START/STOP**" button again, or release the clutch pedal or brake pedal (depending on the type of gearbox).

After this period, if the engine has not started, press the "**START/STOP**" button again for another attempt at starting.



If one of the starting conditions is not met, the Keyless entry and Starting system indicator lamp flashes in the instrument panel. In some circumstances, it is necessary to turn the steering wheel slightly while pressing the "**START/STOP**" button to assist unlocking of the steering.

The presence of the electronic key in the vehicle is essential for switching on the ignition and starting only. Once the engine has started, make sure that the electronic key remains with the vehicle until the end of the journey: otherwise you would not be able to lock the vehicle.

Switching off using the electronic key

- ☞ Immobilise the vehicle.
- ☞ Place the gear lever in neutral for vehicles fitted with a manual gearbox, or at **N** for vehicles fitted with an etg electronic gearbox.



- ☞ With the electronic key inside the vehicle, press the "**START/STOP**" button.

The engine stops.

The steering locks when a door is opened or on locking the vehicle.

i If the vehicle is not immobilised, the engine will not stop.

There is an audible signal when the driver's door is opened and the vehicle is not in "**OFF**" mode.



- ☞ Press the "**START/STOP**" button again to change to "**OFF**" mode.

Emergency starting



When the electronic key is in the recognition zone and your vehicle does not start after pressing the "**START/STOP**" button, this warning lamp flashes in the instrument panel.

- ☞ Place the gear lever at **N** for vehicles with an etg electronic gearbox or neutral for vehicles with a manual gearbox.
- ☞ Put the corner of the electronic key, where the indicator lamp is located, in contact with the "**START/STOP**" button. There is an audible signal when the electronic key is recognised; the vehicle changes to "**ON**" mode.
- ☞ Press the brake pedal on vehicles with an etg electronic gearbox, or fully declutch with a manual gearbox.
- ☞ Check that the "Keyless entry and Starting" indicator lamp comes on in green in the instrument panel.
- ☞ Press the "**START/STOP**" button. The engine starts.

If the engine does not start, contact a Peugeot dealer or a qualified workshop.

Emergency switch-off

In the event of an emergency only, the engine can be switched off without conditions. To do this, press and hold the **"START/STOP"** button for more than 2 seconds.

In this case the steering column locks as soon as the vehicle stops.

Electronic key not recognised

If the electronic key is no longer in the recognition zone when driving or when you (later) request switching off the engine, there is an audible signal to warn you.



Press and hold the **"START/STOP"** button for more than 2 seconds if you want to force switching off the engine (**note that restarting will not be possible without the key**).

Manual parking brake

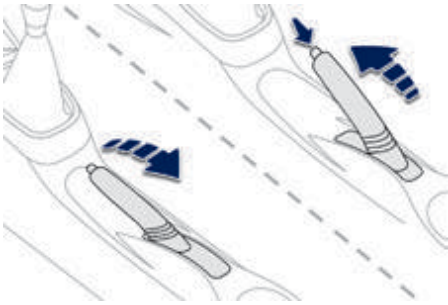

Applying

- ☞ Pull the parking brake lever up to immobilise your vehicle.

Releasing

- ☞ Pull the parking brake lever up gently, press the release button then lower the lever fully.



When the vehicle is being driven, if the parking brake is still on or has not been fully released, this warning lamp comes on accompanied by an audible signal.



When parking on a slope, direct your wheels against the kerb, apply the parking brake, switch off the ignition and engage a gear (vehicles fitted with a manual gearbox).

5-speed manual gearbox

Engaging reverse gear

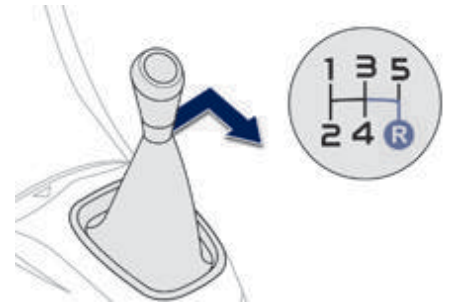

- ☞ Press the clutch pedal fully down.
- ☞ Push the gear lever fully to the right then backwards.



Only engage reverse gear when the vehicle is stationary with the engine at idle.

etg electronic gearbox

The five-speed etg electronic gearbox offers a choice between the ease of **automated operation** or the pleasure of **manual gear changing**.

Gear lever

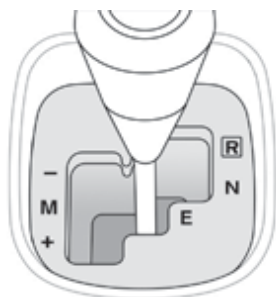

- R** Reverse: with your foot on the brake pedal, move the lever to the right then forward to select this position.
- N** Neutral: with your foot on the brake pedal, select this position to start the engine.
- E** Automatic (easy) mode: move the lever back to select this mode.
- M** Manual mode with sequential gear changing: move the lever back then to the left to select this mode.

Steering mounted control paddles



- ☞ Press behind the "+" steering mounted control paddle to change up.



- ☞ Press behind the "-" steering mounted control paddle to change down.

i The steering mounted control paddles cannot be used to select neutral or to engage or come out of reverse gear.

Display in the instrument panel

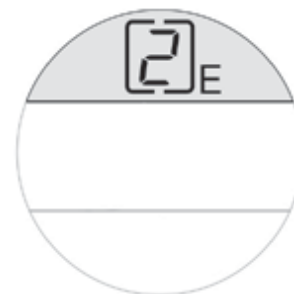

The position of the gear lever (**R**, **N**, **E** or **M**) is displayed in the instrument panel. In automatic (easy) mode, when you temporarily take control of gear changing, the gear engaged is also displayed in the instrument panel.

Moving off

- ☞ With the parking brake applied, press the brake pedal then select position **N**.
- ☞ Start the engine.

i If you do not press the brake pedal or if the gear lever is not in position **N**, engine starting is not possible.

- ☞ With your foot on the brake pedal, select position **R**, **E** or **M**.
- ☞ Release the parking brake.
- ☞ Progressively release the brake pedal. Accelerate away.

Creep function

This function makes manoeuvring the vehicle at low speed easier (parking, traffic jams...). After first placing the lever in position **E**, **M** or **R**, **the vehicle moves off as soon as you take your foot off the brake pedal**, at low speed, with the engine at idle.

! Never leave a child unsupervised inside the vehicle with the engine running.

i The creep function may be temporarily unavailable if the clutch temperature is too high or the gradient too steep. An audible signal gives a warning if the clutch temperature is too high.

Automatic (EASY) mode

- ☞ Select position **E** using the gear lever. The gearbox then operates in auto-active mode, without any intervention required by the driver. It continuously selects the most suitable gear for:

- optimised fuel consumption,
- the driving style,
- the profile of the road,
- the load in the vehicle.

To obtain optimum acceleration, when overtaking another vehicle for example, press firmly on the accelerator pedal going beyond the point of resistance.

It is possible to change mode at any time, by moving the gear lever from position **E** to position **M** and the other way round.

! Never select neutral **N** when the vehicle is moving.

Temporarily taking control of gear changes

You can temporarily take control of gear changes using the "+" and "-" steering mounted control paddles.

Gear change commands are only acted on if the engine speed allows. There is an audible signal if a command is not accepted.

The gear engaged is displayed in the instrument panel.

This function allows you to anticipate certain situations such as overtaking a vehicle or approaching a corner.

After a few moments with no action on the controls, the gearbox returns to automatic control of the gears.

Manual mode

- ☞ Place the gear lever in position **M**.
- ☞ Change up or down using:
 - the gear lever, pushing:
 - back, "+" to change up,
 - forward, "-" to change down.
 - or the "+" or "-" steering mounted control paddle.

The gear engaged is displayed.

Gear change commands are only acted on if the engine speed allows.

It is not necessary to release the accelerator pedal during gear changes. There is an audible signal if a command is not accepted.

When braking or slowing down, the gearbox automatically changes down so that pick-up is in the right gear.

Under sharp acceleration, the gearbox will not change up without action by the driver on the gear lever or steering mounted control paddles (unless the engine speed is close to maximum).

It is possible to change mode at any time, by moving the gear lever from position **E** to position **M** and the other way round.

 Never select neutral **N** when the vehicle is moving.

Reverse

To engage reverse, the vehicle must be stationary with your foot on the brake pedal.

☞ Select position **R**.

There is an audible signal on engaging reverse.

Stopping the vehicle

The vehicle can be stopped whatever the position of the gear lever (**N**, **E** or **R**). However, there is an audible signal on opening the driver's door if the gear lever is not in position **N**.

! In all cases, it is **essential that you apply the parking brake** to immobilise the vehicle.

! When the vehicle is stopped with the engine running, always put the gear lever into neutral **N**.

! Before doing anything under the bonnet, check that the gear lever is in neutral **N** and the parking brake is applied.

Operating fault



With the ignition on, illumination of this warning lamp indicates a gearbox fault. Contact a Peugeot dealer or a qualified workshop.

g ear shift indicator

System which reduces fuel consumption by recommending the most appropriate gear.

Operation

Depending on the driving situation and your vehicle's equipment, the system may advise you to change gear.

the gear engagement recommendations must not be considered compulsory. In fact, the configuration of the road, the amount of traffic and safety remain determining factors when choosing the best gear. Therefore, the driver remains responsible for deciding whether or not to follow the advice given by the system. This function cannot be deactivated.

example:

- You are in third gear.
- You press the accelerator pedal.
- the system may suggest that you engage a higher gear.



the information appears in the instrument panel in the form of an arrow.

i the system adapts its gear change recommendation according to the driving conditions (slope, load, ...) and the demands of the driver (power, acceleration, braking, ...).

the system never suggests:

- engaging first gear,
- engaging reverse gear.

i With an etg electronic gearbox, the system is only active in manual mode.

i With the Vt i 82 engine, the system only suggests when to change up.

Hill start assist

System which keeps your vehicle immobilised temporarily (approximately 2 seconds) when starting on a gradient, the time it takes to move your foot from the brake pedal to the accelerator pedal.

This system only operates when:

- the vehicle is completely stationary, with your foot on the brake pedal,
- certain conditions of slope are met,
- with the driver's door closed.

The hill start assist system cannot be deactivated.

! Do not exit the vehicle while it is being held in the hill start assist phase. If you need to exit the vehicle with the engine running, apply the parking brake manually.

Operation

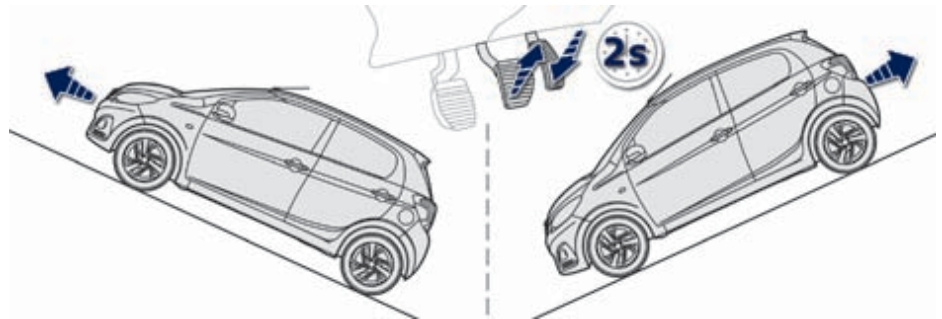

On an ascending slope, with the vehicle stationary, the vehicle is held for a momentarily when you release the brake pedal:

- if you are in first gear or neutral with a manual gearbox,
- if you are in position **E** or **M** with an etg electronic gearbox.

On a descending slope, with the vehicle stationary and reverse gear engaged, the vehicle is held momentarily when you release the brake pedal.

Operating fault



If a fault in the system occurs, this warning lamp comes on. Contact a Peugeot dealer or a qualified workshop to have the system checked.

Stop & Start (e-Vt i 68 engine)

The Stop & Start system puts the engine temporarily into standby - St OP mode - during stops in the traffic (red lights, traffic jams, or other...). The engine restarts automatically - St ARt mode - as soon as you want to move off. The restart takes place instantly, quickly and silently. Perfect for urban use, the Stop & Start system reduces fuel consumption and exhaust emissions as well as the noise level when stationary.

Operation

Going into engine STOP mode



This indicator lamp comes on in the instrument panel and the engine goes into standby automatically:

- when stationary, in neutral, and you release the clutch pedal.

Stop & Start time counters

A partial time counter counts the periods in St OP mode during a journey.

It is displayed in the trip computer once the Stop & Start acts.

Press one of the screen management buttons to return to the previous display.

A global time counter counts the periods in St OP mode since the last reset.

When it is displayed, press one of the screen management buttons to reset the counter.



For smoother operation, during parking manoeuvres St OP mode is not available for a few seconds after coming out of reverse gear. St OP mode does not affect the vehicle's systems, such as for example, braking, power steering...



Never refuel with the engine in St OP mode; you must switch off the ignition with the button.

Special cases: STOP mode not available

St OP mode is not invoked principally when:

- the driver's door is open,
- the driver's seat belt is not fastened,
- the engine is needed to maintain a comfortable temperature in the passenger compartment,
- demisting is active,
- some special conditions (battery charge, engine temperature, braking assistance, vehicle stopped on a steep gradient, high altitude...) where the engine is needed to assure control of a system.

Going into engine START mode



At this indicator lamp goes off and the engine starts automatically:

- when you **fully** depress the clutch pedal.

Special cases: START invoked automatically

Start mode is invoked automatically when:

- you open the driver's door,
- you open the bonnet,
- you unfasten the driver's seat belt,
- some special conditions (battery charge, engine temperature, braking assistance, descending a steep gradient, adjustment of the air conditioning...) where the engine is needed for control of a system.

Operating fault



In the event of a fault with the system, this warning lamp flashes in the instrument panel.

Have it checked by a Peugeot dealer or a qualified workshop.

Maintenance

- ! Before doing anything under the bonnet, deactivate the Stop & Start system to avoid any risk of injury resulting from automatic operation of St Art mode.



This system requires a 12 V battery with a special specification and technology (reference numbers available from Peugeot Ot dealers). Fitting a battery not listed by Peugeot Ot introduces the risk of malfunction of the system. For charging, use a 12 V charger and do not reverse the polarity.

- ! The Stop & Start system makes use of advanced technology. For any work on the system go to a qualified workshop with the skills and equipment required, which a Peugeot Ot dealer is able to provide.

Deactivation



At any time, press this button to deactivate the system.



This is confirmed by the illumination of this indicator lamp in the instrument panel.

If the system has been deactivated in St OP mode, the engine restarts immediately.

Reactivation

Press this button again. The system is active again; this is confirmed by the indicator lamp going off in the instrument panel.

The system is reactivated automatically at every new engine start by the driver.

Speed limiter (Vt i 82 engine)

System which prevents the vehicle from exceeding the speed programmed by the driver.

The speed limiter is **switched on** manually: this can be done whatever the speed of the vehicle. However, if you are driving at less than 20 mph (30 km/h), the programmed speed will be fixed at 20 mph (30 km/h).

The speed limiter is **paused** by operation of the control.

The programmed speed can be exceeded temporarily by pressing the accelerator firmly beyond the point of resistance.

To return to the programmed speed, simply release the accelerator pedal until the vehicle returns to the programmed speed limit.

i The programmed speed remains in the memory when the ignition is switched off.

! The speed limiter cannot, in any circumstances, replace the need to observe speed limits, nor can it replace the need for vigilance on the part of the driver.

Steering mounted controls



The controls are grouped together on this control stalk at the steering wheel.

1. Speed limiter on / off: by pressing the end of the control stalk.
2. Decrease setting: by pushing the control stalk down.
3. Increase setting: by pushing the control stalk up.
4. Speed limiter on / pause: by pulling the control stalk towards you.

Displays in the instrument panel



The information is grouped together in the instrument panel screen.

5. Speed limiter mode selection indication.
6. Speed limiter on / pause indication.
7. Speed value setting.

Switching on



- ☞ Press the end of the control stalk: the speed limiter mode is selected but is not switched on.
- ☞ Switch the speed limiter on by pulling the control stalk towards you, if the speed displayed is suitable (by default, the last speed programmed).

Pause

- ☞ You can temporarily stop the the speed limiter by pulling the control stalk towards you again: the display confirms that it has been stopped (Pause).
- ☞ Pull the control stalk towards you again to restore the speed limiter.

Adjusting the speed limit setting

i You do not have to switch the speed limiter on in order to set the speed.

Once the function is selected, you can modify the speed setting by:

- by pushing the control stalk up to increase the setting,
- by pushing the control stalk down to decrease the setting.

A brief push on the control stalk modifies the speed setting by + or - 1 km/h.

A maintained push on the control stalk modifies the speed setting by + or - 5 km/h.

5

Temporarily exceeding the programmed speed

- ☞ Press **firmly** on the accelerator pedal, going beyond the **point of resistance**, to exceed the programmed speed limit. The speed limiter is deactivated temporarily and the displayed programmed speed flashes.

i An audible signal accompanies the flashing of the programmed speed when exceeding the speed is not due to an action by the driver (steep hill...).

As soon as the vehicle's speed returns to the programmed value, the limiter operates again: the display of the programmed speed becomes steady again.

Switching off

- ☞ Press the end of the control stalk. The display of information related to the speed limiter disappears.

Operating fault



Illumination of this warning lamp in the instrument panel indicates a fault with the speed limiter. Have it checked by a Peugeot Ot dealer or a qualified workshop.

- !** The use of mats not approved by Peugeot Ot may interfere with the operation of the speed limiter. To avoid any risk of jamming of the pedals:
 - ensure that the mat is secured correctly,
 - do not fit one mat on top of another.

Speed limiter (Vt i 68 engine)

System which prevents the vehicle from exceeding the speed programmed by the driver.

The speed limiter is **switched on** manually: this can be done whatever the speed of the vehicle. However, if you are driving at less than 20 mph (30 km/h), the programmed speed will be fixed at 20 mph (30 km/h).

The speed limiter is **paused** by operation of the control.

The programmed speed can be exceeded temporarily by pressing the accelerator firmly beyond the point of resistance.

To return to the programmed speed, simply release the accelerator pedal until the vehicle returns to the programmed speed limit.

i The programmed limit speed is erased when switching off the ignition.

! The speed limiter cannot, in any circumstances, replace the need to observe speed limits, nor can it replace the need for vigilance on the part of the driver.

Steering mounted controls

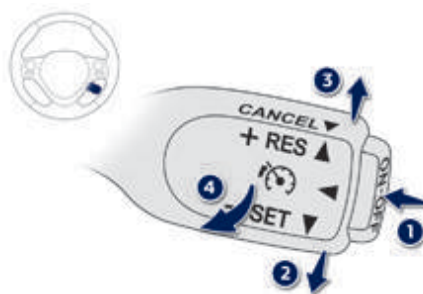

The controls are grouped together on this control stalk at the steering wheel.

1. Speed limiter on / off: by pressing the end of the control stalk.
2. Programming the speed, then
Decrease the setting: by pushing the control stalk down.
3. Restore speed limiter
Increase the setting: by pushing the control stalk up.
4. Pause speed limiter: by pulling the control stalk towards you.

Displays in the instrument panel



The information is grouped together in the instrument panel screen.

5. Speed limiter on / pause indication.
6. Speed value setting.

If you choose to display other information (trip **A** for example), the speed limiter information is automatically displayed again after about 6 seconds.

5

Switching on

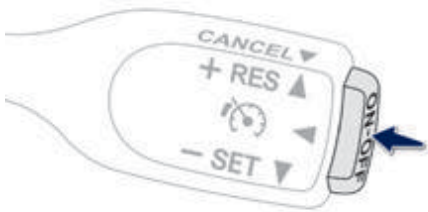

- ☞ Press the end of the control stalk: the speed limiter is switched on.



This indicator lamp comes on in the instrument panel.

- ☞ Accelerate or decelerate to attain the desired speed.
- ☞ Push the control stalk down and release, to programme the speed.
The speed at which the vehicle is running at the moment when you release the control stalk becomes the programmed speed.

Pause

- ☞ You can temporarily stop the speed limiter by pulling the control stalk towards you.
- ☞ Push the control stalk up to restore operation of the speed limiter with the same speed setting.

Adjusting the speed limit setting

Once a speed is programmed, you can modify it by pushing and releasing the control stalk:

- up to increase the speed setting,
- down to reduce the speed setting.

A brief push on the control stalk modifies the speed setting by + or - 1 km/h.

A maintained push on the control stalk modifies the speed setting by + or - 5 km/h.

Temporarily exceeding the programmed speed

- Press **firmly** on the accelerator pedal, going beyond the **point of resistance**, to exceed the programmed speed limit. The speed limiter is deactivated temporarily and the displayed programmed speed flashes.

i An audible signal accompanies the flashing of the programmed speed when exceeding the speed is not due to an action by the driver (steep hill...).

As soon as the vehicle's speed returns to the programmed value, the limiter operates again: the display of the programmed speed becomes steady again.

Switching off

- Press the end of the control stalk. The display of information related to the speed limiter disappears.

Operating fault



Illumination of this warning lamp in the instrument panel indicates a fault with the speed limiter.

Have it checked by a Peugeot dealer or a qualified workshop.



The use of mats not approved by Peugeot may interfere with the operation of the speed limiter. To avoid any risk of jamming of the pedals:

- ensure that the mat is secured correctly,
- do not fit one mat on top of another.

Reversing camera

The reversing camera is activated automatically when reverse gear is engaged.

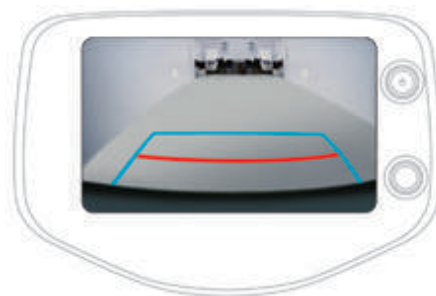

! The reversing camera cannot in any circumstances be a substitute for the vigilance of the driver.

The image is provided in the touch screen only, with an indication of the limit of the rear bumpers (red line) and the general direction of the vehicle (blue lines).

! Never reverse the vehicle looking only at the screen.

! **High pressure jet washing**
When washing your vehicle, do not direct the lance within 30 cm of the camera lens.

The field of vision covered by the camera is limited: objects in the immediate proximity of the bumper or located below it are not visible.

The camera's wide-angle lens deforms the image presented in the screen: the distances visible in the screen may be different from the true distances. This deformation varies according to the loading of the vehicle and the slope of the road.

i Clean the reversing camera regularly using a soft, dry cloth.

Lighting control stalk

Control stalk for the selection and operation of the various front and rear lamps providing the vehicle's lighting.

Main lighting

The various front and rear lamps of the vehicle are designed to adapt the driver's visibility progressively according to the climatic conditions:

- sidelamps, to be seen,
- dipped beam headlamps to see without dazzling other drivers,
- main beam headlamps to see clearly when the road is clear.

Additional lighting

Other lamps are provided to meet the requirements of particular driving conditions:

- a rear foglamp,
- front foglamps,
- daytime running lamps to be more visible during the day.

i In some weather conditions (e.g. low temperature or humidity), the presence of misting on the internal surface of the glass of the headlamps and rear lamps is normal; it disappears after the lamps have been on for a few minutes.

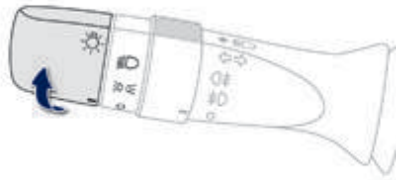

Model without AUTO lighting

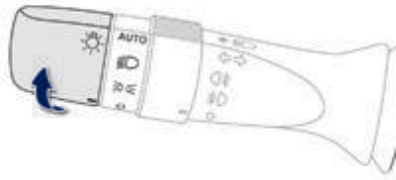

Model with AUTO lighting

Selection ring for main lighting mode

Turn the ring to position the symbol required facing the mark.



Lighting off / Daytime running lamps.



Sidelamps only.



Dipped or main beam headlamps.



Automatic illumination of headlamps.

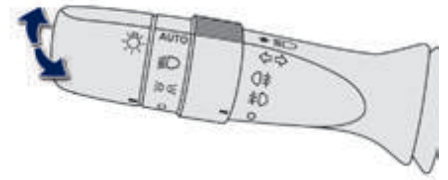

Dipping the headlamps

With dipped beam on, push the control stalk away from you to change to main beam. Pull the stalk toward you change back to dipped beam.

In the lighting off and sidelamps modes, the driver can switch on the main beam headlamps temporarily ("headlamp flash") by maintaining a pull on the stalk.

Displays

Illumination of the corresponding indicator lamp in the instrument panel confirms the lighting switched on.

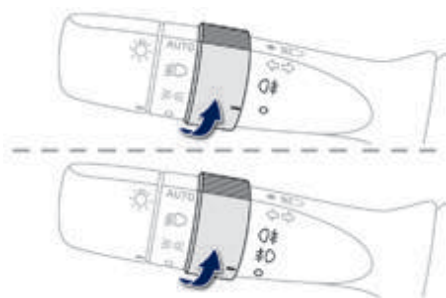

Foglamp selection ring

The front foglamps operate with dipped and main beam headlamps.



Front foglamps and rear foglamp

Rotate and release the ring:

- ☞ forward once to switch on the rear foglamp,
- ☞ forward again to switch on the front foglamps,
- ☞ rearward once to switch off the front foglamps,
- ☞ rearward again to switch off the rear foglamp.

! In good or rainy weather, both day and night, the front foglamps and the rear foglamp are prohibited. In these situations, the power of their beams may dazzle other drivers. They should only be used in fog or snow.

In these weather conditions, it is your responsibility to switch on the foglamps and dipped beam headlamps manually as the sunshine sensor may detect sufficient light.

Do not forget to switch off the front foglamps and the rear foglamp when they are no longer necessary.

When the headlamps switch off with automatic illumination of headlamps (Auto model) or when the dipped beam headlamps are switched off manually, the foglamps and sidelamps remain on.

- ☞ Turn the ring rearward to switch off all the lamps.

i Switching off the lamps when the ignition is switched off

On switching off the ignition, all of the lamps turn off immediately, except for dipped beam if guide-me-home lighting is activated.

i Switching on the lamps after the ignition is switched off

To reactivate the lighting control, rotate the ring to the "0" position - lamps off, then to the desired position.

On opening the driver's door a temporary audible signal warns the driver that the lighting is on.

Automatic illumination of headlamps

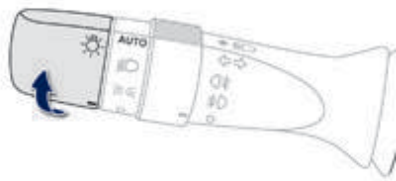

Using a sunshine sensor, if a low level of ambient light level is detected, the sidelamps and dipped beam headlamps come on automatically, without any action by the driver. When the ambient light returns to a sufficient level or the wipers are switched off, the lighting is switched off automatically. The sensor is located at the base of the windscreen.

Switching on

Turn the ring to the "AUTO" position.

Switching off

Turn the ring to another position.

! In foggy weather or in snow, the sunshine sensor may detect sufficient light. The lighting will not come on automatically. Do not cover the sunshine sensor, the associated functions will no longer be controlled.

Manual guide-me-home lighting*



Temporarily keeping the dipped beam headlamps on after the vehicle's ignition has been switched off makes the exit of the vehicle's occupants easier when the light is poor.

Switching on

- ☞ Place the lighting control stalk in the "lighting off" or "Auto" position.
 - ☞ With the ignition off, "flash" the headlamps using the lighting control stalk.
- The lighting comes on for about 30 seconds.

Switching off

- The manual guide-me-home lighting switches off immediately if you.
- flash the headlamps again,
 - place the lighting control stalk in another position,
 - switch the ignition on.

* Depending on version.

Headlamp adjustment

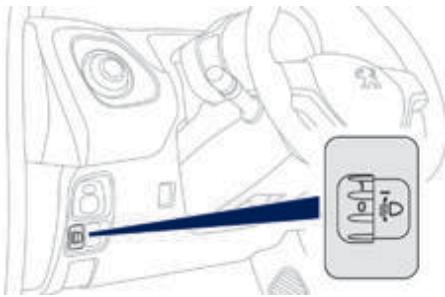

To avoid causing a nuisance to other road users, the height of the headlamps should be adjusted according to the load in the vehicle.

- 0.** Driver only.
- 0.5.** Driver + front passenger.
- 1.5.** 4 people.
- 3.** 4 people + maximum authorised load.
- 3.5.** Driver + maximum authorised load.

i Travelling abroad

If using your vehicle in a country that drives on the other side of the road, the headlamps must be adjusted to avoid dazzling on-coming drivers. Contact a Peugeot dealer or a qualified workshop.

i The initial setting is position "0".

Wiper control stalk

i In wintry conditions, remove snow, ice or frost present on the windscreen, around the wiper arms and blades and the windscreen seal, before operating the wipers.

! Do not operate the wipers on a dry windscreen. Under extremely hot or cold conditions, ensure that the wiper blades are not stuck to the windscreen before operating the wipers.

Manual controls



the wipers are controlled directly by the driver.

Windscreen wipers

Wiping speed control stalk: raise or lower the stalk to the desired position.

 Single wipe.

For a single wipe of the windscreen, raise and release the control stalk.

 Park.

 Intermittent wipe.

 Normal wipe (moderate rain).

 Fast wipe (heavy rain).

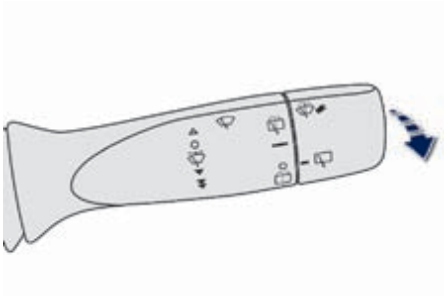

Windscreen wash

Pull the wiper stalk towards you. The windscreen wash, then the windscreen wipers, operate for a pre-determined time.

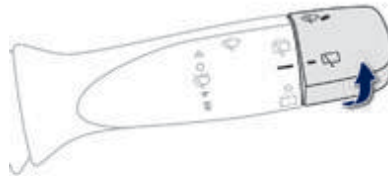

Rear wiper



Turn the ring to this position for a steady wipe.

Pushing the stalk away from you operates the wash during wiping.

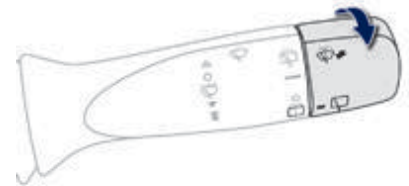

Rear screenwash

Wiper off, turn the control stalk towards you to operate the rear screenwash, accompanied by several sweeps of the rear wiper.

i Do not use the front or rear screenwash when the screenwash reservoir is empty. You risk damaging the pump.

Courtesy lamp

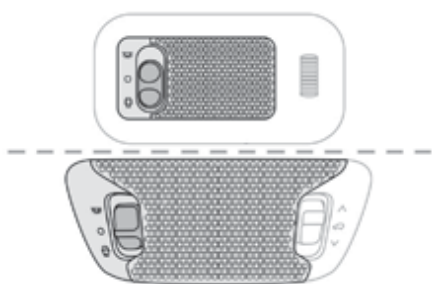

In this position, it comes on when one of the doors is opened.



In this position, the courtesy lamp is permanently off.



In this position, the courtesy lamp is permanently on.

i If left in the "permanently on" position, the courtesy lamp will switch off about 20 minutes after the last door is closed.

Boot lamp*



This comes on automatically when the boot is opened and goes off automatically when the boot is closed.

* Depending on version.

Direction indicators

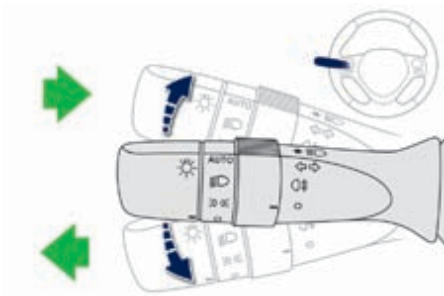

- ☞ Left: lower the lighting stalk passing the point of resistance.
- ☞ Right: raise the lighting stalk passing the point of resistance.

Three flashes of the direction indicators

- ☞ Press briefly upwards or downwards, without going beyond the point of resistance; the direction indicators will flash 3 times.

Horn

Audible warning system to alert other road users to an imminent danger.



- ☞ Press one of the steering wheel spokes.



- ☞ Press the central part of the steering wheel.

! When manoeuvring the vehicle, take care not to operate the horn unintentionally.

Hazard warning lamps

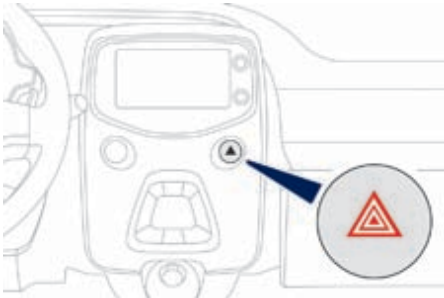

A visual warning by means of the direction indicators to alert other road users to a vehicle breakdown, towing or accident.

☞ Press this button, the direction indicators flash.

They can operate with the ignition off.

Under-inflation detection

System which automatically checks the pressures of the tyres while driving.

The system monitors the pressures in the four tyres, once the vehicle is moving.

It compares the information given by the four wheel speed sensors with **reference values, which must be reinitialised every time the tyre pressures are adjusted or a wheel changed.**

The system triggers an alert as soon as it detects a drop in the inflation pressure of one or more tyres.

! The under-inflation detection system does not replace the vigilance or the responsibility of the driver. This system does not avoid the need to check the tyre pressures (including the spare wheel) every month as well as before a long journey. Driving with under-inflated tyres impairs road holding, extends braking distances and causes premature tyre wear, particularly under arduous conditions (high loading, high speed, long journey).



Driving with under-inflated tyres increases fuel consumption.



The inflation pressures defined for your vehicle can be found on the tyre pressure label. See the "Identification markings" section.

Tyre pressures should be checked when the tyres are "cold" (vehicle stopped for 1 hour or after a journey of less than 6 miles (10 km) at moderate speeds).

Otherwise (when hot), add 0.3 bar to the pressures shown on the label.

Under-inflation alert



This is given by fixed illumination of this warning lamp, accompanied by an audible signal.

- ☞ Reduce speed immediately, avoid excessive steering movements and sudden braking.
- ☞ Stop the vehicle as soon as it is safe to do so.

! The loss of pressure detected does not always cause visible bulging of the tyre. Do not satisfy yourself with just a visual check.

☞ If you have a compressor (such as the one in the temporary puncture repair kit) check the pressures of the four tyres when cold. If it is not possible to carry out this check straight away, drive carefully at reduced speed.

or

☞ In the event of a puncture, use the temporary puncture repair kit or the spare wheel (depending on equipment).

i The alert is maintained until the system is reinitialised.

Reinitialisation



It is necessary to reinitialise the system every time one or more tyre pressure is adjusted, and after changing one or more wheels. A label attached to the middle pillar, driver's side, gives a reminder of this.

! Before reinitialising the system, ensure that the pressures of the four tyres are correct for the use of the vehicle and in line with the recommendations on the tyre pressure label. The under-inflation detection system does not give a warning if a pressure is incorrect at the time of reinitialisation.

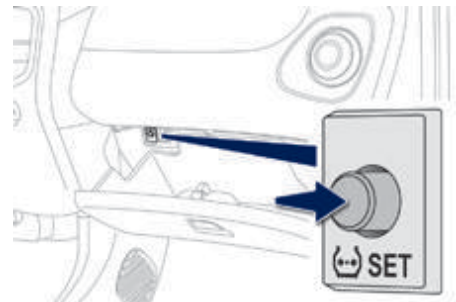

Reinitialisation of the system is done with the **ignition on** (ignition switch in the "ON" position or "ON" mode) and the vehicle stationary.

- ☞ Open the glove box.
- ☞ Press the reinitialisation button.



- ☞ This warning lamp flashes 3 times in the instrument panel when the reinitialisation is done.
- ☞ Wait a few minutes before switching off the ignition (ignition switch in the "ACC" or "LOCK" position, or "OFF" mode).

The new pressure settings registered are considered to be reference values by the system.

i **Snow chains**

The system does not have to be reinitialised after fitting or removing snow chains.



The under-inflation alert can only be considered reliable if reinitialisation of the system is done with the the four tyre pressures correctly set.

Operating fault



The flashing and then fixed illumination of the under-inflation warning lamp indicates a fault with the system.

In this case, under-inflation monitoring of the tyres is no longer assured.

Have the system checked by a Peugeot dealer or a qualified workshop.



Before doing anything to the system, the pressures of the four tyres must be checked and the system reinitialised.

electronic stability control (eSC)

electronic Stability Control (eSC) incorporating the following systems:

- anti-lock braking system (ABS) and the electronic brake force distribution (eBFD),
- emergency braking assistance,
- traction control (t RC),
- dynamic stability control (DSC).

Definitions

Anti-lock braking system (ABS) and electronic brake force distribution (EBFD)

These systems improve the stability and manoeuvrability of your vehicle when braking and contribute towards better control in corners, in particular on poor or slippery road surfaces.

The ABS prevents wheel lock in the event of emergency braking.

The electronic brake force distribution system manages the braking pressure wheel by wheel.

Emergency braking assistance

In an emergency, this system enables you to reach the optimum braking pressure more quickly and therefore reduce the stopping distance.

It is triggered according to the speed at which the brake pedal is pressed. This is felt by a reduction in the resistance of the pedal and an increase in the effectiveness of the braking.

Traction control (TRC)

This system optimises traction in order to limit wheel slip by acting on the brakes of the driving wheels and on the engine. It also improves the directional stability of the vehicle on acceleration.

Dynamic stability control (DSC)

If there is a difference between the path followed by the vehicle and that required by the driver, this system monitors each wheel and automatically acts on the brake of one or more wheels and on the engine to return the vehicle to the required path, within the limits of the laws of physics.

Operation

Anti-lock braking system (ABS) and electronic brake force distribution (EBFD)



Illumination of this warning lamp, accompanied by an audible signal, indicates that there is a fault with the ABS system, which could cause loss of control of the vehicle when braking.

Drive carefully at reduced speed, and contact a Peugeot dealer or a qualified workshop.



Illumination of this warning lamp, accompanied by an audible signal, indicates that there is a fault with the electronic brake force distribution (eBFD), which could cause loss of control of the vehicle when braking.

You **must** stop as soon as it is safe to do so. Contact a Peugeot dealer or a qualified workshop as soon as possible.

i When changing wheels (tyres and rims), make sure that these are approved for your vehicle. Normal operation of the ABS may make itself felt by slight vibration of the brake pedal.

i In emergency braking, press very firmly without releasing the pressure.



Dynamic stability control (DSC) and traction control (TRC)

Activation

These systems are activated automatically each time the vehicle is started. As soon as they detect a problem of grip or trajectory, these systems act on the operation of the engine and brakes.



Activation of the DSC system is signalled by the flashing of this indicator lamp in the instrument panel, accompanied by an audible signal.



Activation of the TRC system is signalled by the flashing of this indicator lamp in the instrument panel.

Deactivation

In exceptional conditions (starting a vehicle which is bogged down, stuck in snow, on soft ground...), it may be advisable to deactivate the DSC system, so that the wheels can move freely and regain grip.

However, it is recommended that the system be reactivated as soon as possible.

Deactivation of the TRC system only



Press this button briefly.



This warning lamp comes on: the TRC system no longer acts on the operation of the engine.

Deactivation of the TRC and DSC systems



Vehicle stationary, press this button for at least than 3 seconds.



These warning lamps come on: the TRC and DSC systems no longer act on the operation of the engine.

Reactivation

The TRC and DSC control systems are reactivated automatically every time the engine is started.



Press the button again to reactivate it manually.

When the TRC system only is deactivated, it is reactivated as the vehicle's speed increases.

When both the TRC and DSC systems are deactivated, they do not reactivate themselves even if the speed of the vehicle increases.

Operating fault



Illumination of this warning lamp, accompanied by an audible signal, indicates a fault with the system.

Drive carefully at reduced speed and contact a Peugeot dealer or a qualified workshop to have the system checked.

! The TRC and DSC systems offer increased safety in normal driving, but should not encourage the driver to take extra risks or drive at high speed. The correct operation of these systems depends on observation of the manufacturer's recommendations regarding the wheels (tyres and rims), the braking components, the electronic components and the assembly and repair procedures used by Peugeot dealers. After an impact, have the system checked by a Peugeot dealer or a qualified workshop.

Seat belts

Front seat belts



The front seat belts are fitted with a pretensioning and force limiting system. This system improves safety in the front seats in the event of a front or side impact. Depending on the severity of the impact, the pretensioning system instantly tightens the seat belts against the body of the occupants. The pretensioning seat belts are active when the ignition is on. The force limiter reduces the pressure of the seat belt on the chest of the occupant, so improving their protection.

Rear seat belts

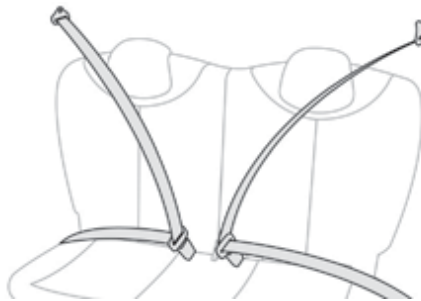

The rear seats are each fitted with a three-point seat belt.

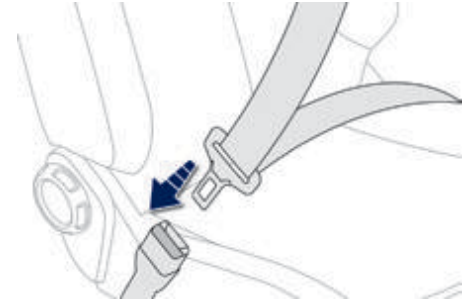

Fastening

- ☞ Pull the strap, then insert the tongue in the buckle.
- ☞ Check that the seat belt is fastened correctly by pulling the strap.

Unfastening

- ☞ Press the red button on the buckle.
- ☞ Guide the seat belt as it reels in.



Seat belt not fastened / unfastened warning lamps

1. Front seat belts not fastened / unfastened warning lamp, in the instrument panel.
2. Left hand rear seat belt unfastened warning lamp, in the seat belts and passenger's front airbag display screen.
3. Right hand rear seat belt unfastened warning lamp, in the seat belts and passenger's front airbag display screen.



i If you place a load on the front passenger seat, this may cause the warning lamp to come on.

Front seat belt(s) warning lamp

The warning lamp **1** comes on in the instrument panel if the front seat belt is not fastened or is unfastened.

From about 12 mph (20 km/h) and for about 30 seconds, illumination of the warning lamp is accompanied by an audible signal.

Beyond this time, if the seat belt is still not fastened, the tone of the audible signal changes and remains active for about a further 90 seconds.

Rear seat belt warning lamp(s)

The warning lamp(s) **2** and/or **3** come on in the seat belts and passenger's front airbag warning lamp display screen when one or more rear passengers unfasten their seat belt.

From about 12 mph (20 km/h) and for about 30 seconds, illumination of the warning lamp is accompanied by an audible signal.

Beyond this time, if the seat belt is still not fastened, the tone of the audible signal changes and remains active for about a further 90 seconds.

i The driver must ensure that passengers use the seat belts correctly and that they are all restrained securely before setting off. Wherever you are seated in the vehicle, always fasten your seat belt, even for short journeys. Do not interchange the seat belt buckles as they will not fulfil their role fully. The seat belts are fitted with an inertia reel permitting automatic adjustment of the length of the strap to your size. The seat belt is stowed automatically when not in use. Before and after use, ensure that the seat belt is reeled in correctly. The lower part of the strap must be positioned as low as possible on the pelvis. The upper part must be positioned in the hollow of the shoulder. The inertia reels are fitted with an automatic locking device which comes into operation in the event of a collision, emergency braking or if the vehicle rolls over. You can release the device by pulling the strap firmly and then releasing it so that it reels in slightly.

In order to be effective, a seat belt must:

- be tightened as close to the body as possible,
- be pulled in front of you with a smooth movement, checking that it does not twist,
- be used to restrain only one person,
- not bear any trace of cuts or fraying,
- not be converted or modified to avoid affecting its performance.

In accordance with current safety regulations, for all repairs on your vehicle's seat belts, go to a qualified workshop with the skills and equipment needed, which a Peugeot dealer is able to provide. Have your seat belts checked regularly by a Peugeot dealer or a qualified workshop, particularly if the straps show signs of damage. Clean the seat belt straps with soapy water or a textile cleaning product, sold by Peugeot dealers. After folding or moving a seat or rear bench seat, ensure that the seat belt is positioned and reeled in correctly.

Recommendations for children

Use a suitable child seat if the passenger is less than 12 years old or shorter than one and a half metres. Never use the same seat belt to secure more than one person. Never allow a child to travel on your lap. For more information, refer to the "Child seats" section.

In the event of an impact

Depending on the nature and seriousness of the impact, the pretensioning device may be deployed before and independently of the airbags. Deployment of the pretensioners is accompanied by a slight discharge of harmless smoke and a noise, due to the activation of the pyrotechnic cartridge incorporated in the system. In all cases, the airbag warning lamp comes on. Following an impact, have the seat belts system checked, and if necessary replaced, by a Peugeot dealer or a qualified workshop.

Airbags

System designed to contribute towards the safety of the occupants in the event of violent collisions. The airbags supplement the action of the force-limiting seat belts.

If a collision occurs, the electronic detectors record and analyse the front and side impacts sustained in the impact detection zones:

- in the case of a serious impact, the airbags are deployed instantly and contribute towards better protection of the occupants of the vehicle; immediately after the impact, the airbags deflate rapidly so that they do not hinder visibility or the exit of the occupants,
- in the case of a minor or rear impact or in certain roll-over conditions, the airbags may not be deployed; the seat belt alone contributes towards providing your protection in these situations.

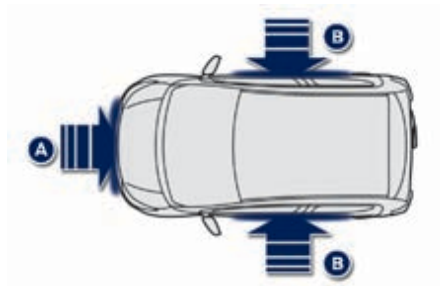

Impact detection zones

- A. Front impact zone.
- B. Side impact zone.

i The deployment of an airbag is accompanied by a slight emission of smoke and a noise, due to the detonation of the pyrotechnic charge incorporated in the system. This smoke is not harmful, but sensitive individuals may experience slight irritation. The detonation noise associated with the deployment of an airbag may result in a slight loss of hearing for a short time.

7

! The airbags do not operate when the ignition is switched off.

! This equipment will only deploy once. If a second impact occurs (during the same or a subsequent accident), the airbag will not be deployed again.

Front airbags

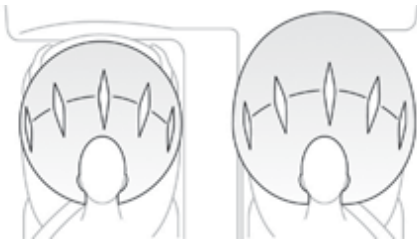

System which protects the driver and front passenger in the event of a serious front impact in order to limit the risk of injury to the head and thorax.

The driver's airbag is fitted in the centre of the steering wheel; the front passenger's airbag is fitted in the dashboard above the glove box.

Deployment

When the airbags are deployed, except the passenger's front airbag if it is deactivated, in the event of a serious front impact to all or part of the front impact zone **A**, in the longitudinal centreline of the vehicle on a horizontal plane and directed from the front to the rear of the vehicle.

The front airbag inflates between the thorax and head of the front occupant of the vehicle and the steering wheel, driver's side, and the dashboard, passenger's side to cushion their forward movement.

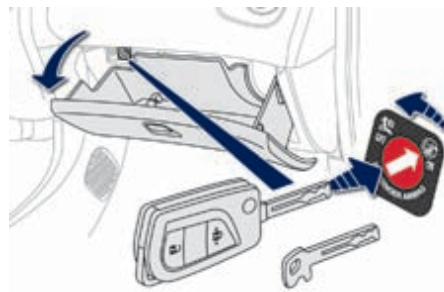

Deactivating the passenger's front airbag

Only the passenger's front airbag can be deactivated.

- ☛ **With the ignition off**, insert the key in the passenger airbag deactivation switch.
- ☛ Turn it to the **"OFF"** position.
- ☛ Remove the key keeping the switch in the new position.



When the ignition is on, this warning lamp comes on in the seat belt and passenger's front airbag display screen. It stays on while the airbag is deactivated.

! To assure the safety of your child, the passenger's front airbag must be deactivated when you install a "rearward facing" child seat on the front passenger seat. Otherwise, the child would risk being seriously injured or killed if the airbag were deployed.

Reactivating the passenger's front airbag

When you remove a "rearward facing" child seat, **with the ignition off**, turn the switch to the **"ON"** position to reactivate the airbag and so assure the safety of your front passenger in the event of an impact.



When the ignition is switched on, this warning lamp comes on in the seat belt and passenger's front airbag display screen. It stays on while the front airbag is activated.

Operating fault



Illumination of this warning lamp in the instrument panel indicates a fault with the airbags.

Contact a Peugeot dealer or a qualified workshop without delay to have the system checked. The airbags may no longer be deployed in the event of a serious impact. In this case, do not install a child seat or seat an adult on the front passenger seat.

Lateral airbags



System which protects the driver and front passenger in the event of a serious side impact in order to limit the risk of injury to the chest, between the hip and the shoulder. Each lateral airbag is fitted in the seat backrest frame, door side.

Deployment

They are deployed unilaterally in the event of a serious side impact applied to all or part of the side impact zone **B**, perpendicular to the longitudinal centreline of the vehicle on a horizontal plane and directed from the outside towards the inside of the vehicle.

The lateral airbag inflates between the hip and shoulder of the front occupant of the vehicle and the corresponding door trim panel.

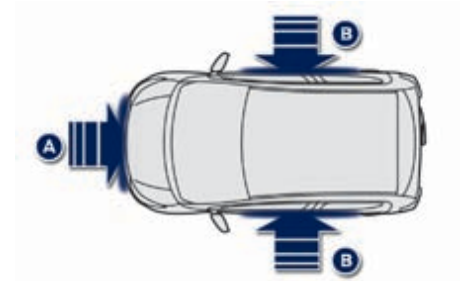

Impact detection zones

- A. Front impact zone.
- B. Side impact zone.

i The lateral airbags may also be deployed during certain front impacts.

Curtain airbags

System which contributed towards the improved protection of the driver and passengers in the event of a serious side impact in order to limit the risk of injury to the side of the head.
Each curtain airbag is built into the pillars and the upper passenger compartment area.

Deployment

It is deployed at the same time as the corresponding lateral airbag in the event of a serious side impact applied to all or part of the side impact zone **B**, perpendicular to the longitudinal centreline of the vehicle on a horizontal plane and directed from the outside towards the inside of the vehicle.
The curtain airbag inflates between the front or rear occupant of the vehicle and the windows.

Operating fault



If this warning lamp comes on in the instrument panel, contact a Peugeot dealer or a qualified workshop to have the system checked. The airbags may no longer be deployed in the event of a serious impact.



In the event of a minor impact or bump on the side of the vehicle or if the vehicle rolls over, the airbags may not be deployed.
In the event of a rear or front collision, none of the lateral airbags is deployed.

! For the airbags to be fully effective, observe the following safety rules:

Sit in a normal upright position.
 Wear a correctly adjusted seat belt.
 Do not leave anything between the occupants and the airbags (a child, pet, object...). This could hamper the operation of the airbags or injure the occupants.
 After an accident or if the vehicle has been stolen or broken into, have the airbag systems checked.
 All work on the airbag system must be carried out by a Peugeot dealer or a qualified workshop.
 even if all of the precautions mentioned are observed, a risk of injury or of minor burns to the head, chest or arms when an airbag is deployed cannot be ruled out. The bag inflates almost instantly (within a few milliseconds) then deflates within the same time discharging the hot gas via openings provided for this purpose.

Front airbags

Do not drive holding the steering wheel by its spokes or resting your hands on the centre part of the wheel.
 Passengers must not place their feet on the dashboard.
 Do not smoke as deployment of the airbags can cause burns or the risk of injury from a cigarette or pipe.
 Never remove or pierce the steering wheel or hit it violently.
 Do not fit or attach anything to the steering wheel or dashboard, this could cause injuries with deployment of the airbags.

Lateral airbags

use only approved covers on the seats, compatible with the deployment the lateral airbags. For information on the range of seat covers suitable for your vehicle, you can contact a Peugeot dealer.
 Refer to the "Accessories" section.
 Do not fix or attach anything to the seat backs (clothing...). This could cause injury to the chest or arms if the lateral airbag is deployed.
 Do not sit with the upper part of the body any nearer to the door than necessary.

Curtain airbags

Do not fix or attach anything to the roof. This could cause injury to the head if the curtain airbag is deployed.
 If fitted on your vehicle, do not remove the grab handles installed on the roof, they play a part in securing the curtain airbags.

General points relating to child seats

Although one of Peugeot's main criteria when designing your vehicle, the safety of your children also depends on you.

For maximum safety, please observe the following recommendations:

- in accordance with European regulations, **all children under the age of 12 or less than one and a half metres tall must travel in approved child seats suited to their weight**, on seats fitted with a seat belt or ISOFIX mountings*.
- **statistically, the safest seats in your vehicle for carrying children are the rear seats,**
- **a child weighing less than 9 kg must travel in the "rearward facing" position both in the front and in the rear.**

i **PEUGEOT recommends** that children should travel on the **rear seats** of your vehicle:

- **"rearward-facing"** up to the age of 3,
- **"forward-facing"** over the age of 3.

* The regulations on carrying children are specific to each country. Refer to the legislation in force in your country.

Child seat at the rear

"Rearward facing"



When a "rearward facing" child seat is installed **on a rear passenger seat**, move the vehicle's front seat forwards and straighten the backrest so that the "rearward facing" child seat does not touch the vehicle's front seat.

"Forward facing"

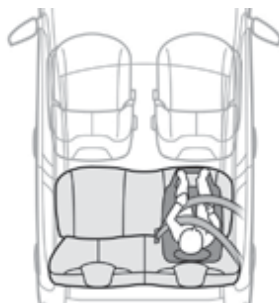

When a "forward facing" child seat is installed **on a rear passenger seat**, move the vehicle's front seat forwards and straighten the backrest so that the legs of the child in the "forward facing" child seat do not touch the vehicle's front seat.

i ensure that the seat belt is correctly tensioned.
For child seats with a support leg, ensure that this is in firm contact with the floor.

Child seat in the front*

"Rearward facing"



When a "rearward facing" child seat is installed on the **front passenger seat**, adjust the seat to the fully back position, with the backrest straightened.

The passenger's front airbag must be deactivated. Otherwise, **the child would risk being seriously injured or killed if the airbag were to inflate.**

"Forward facing"



When a "forward facing" child seat is installed on the **front passenger seat**, adjust the vehicle's seat to the fully back position with seat backrest straightened and leave the passenger's front airbag activated.



Passenger seat adjusted to the fully back position.

i ensure that the seat belt is correctly tensioned.
For child seats with a support leg, ensure that the support leg is in stable contact with the floor. If necessary, adjust the passenger seat.

* Refer to the current legislation in your country before installing a child seat on this seat.

Deactivating the passenger's front airbag

! Never install a rearward facing child restraint system on a seat protected by an active front airbag. This could cause the death of the child or serious injury.

The warning label present on both sides of the passenger's sun visor repeats this advice. In line with current legislation, the following tables contain this warning in all of the languages required.



Passenger airbag OFF



8



i For information on deactivating the passenger's front airbag, refer to the "Airbags" section.

AR	لا يجب أبداً تركيب نظام لإجلاء الطفل للوجه باتجاه الورااء على مقعد سيارة مجهز بوسادة أمان هوائية أمامية مغلقة، فقد يؤدي هذا إلى التسبب بموت الطفل أو بإصابات خطيرة لديه.
Bg	НИКОГА НЕ инсталирайте детско столче на седалка с АКТИВИРАНА предна ВЪЗДУШНА ВЪЗГЛАВНИЦА. Това може да причини СМЪРТ или СЕРИОЗНО НАРАНЯВАНЕ на детето.
CS	NIKDY neumistujte dětské zádržné zařízení orientované směrem dozadu na sedadlo chráněné AKTIVOVANÝM čelním AIRBAGEM. Hrozí nebezpečí SMRTI DÍTĚTE nebo VÁŽNĚHO ZRANĚNÍ.
DA	Brug ALDRIG en bagudvendt barnestol på et sæde, der er beskyttet af en AKT IV AIRBAG . BARNe t risikerer at blive ALVORLig t KVÆSt et eller DRÆBt .
De	Montieren Sie auf einem Sitz mit AKt IVleRt eM Front-Airbag NieMALS einen Kindersitz oder eine Babyschale entgegen der Fahrtrichtung, das Kind könnte schwere oder sogar tödliche Verletzungen erleiden.
eL	Μη χρησιμοποιείτε ΠΟΤΕ παιδικό κάθισμα με την πλάτη του προς το εμπρός μέρος του αυτοκινήτου, σε μια θέση που προστατεύεται από ΜΕΤΩΠΙΚΟ αερόσακο που είναι ΕΝΕΡΓΟΣ. Αυτό μπορεί να έχει σαν συνέπεια το ΘΑΝΑΤΟ ή το ΣΟΒΑΡΟ ΤΡΑΥΜΑΤΙΣΜΟ του ΠΑΙΔΙΟΥ
eN	Ne VeR use a rearward facing child restraint on a seat protected by an ACt IVe AIRBAG in front of it, DeAt H or SeRIOu S INJu RY to the CHILD can occur
eS	NO INST ALAR Nu NCA un sistema de retención para niños de espaldas al sentido de la marcha en un asiento protegido mediante un AIRBAG frontal ACTIVADO, ya que podría causar lesiones GRAVES o incluso la MUERTE del niño.
et	Ärge MItte Ku NAg I paigaldage "seljaga sõidusuunas" lapseistet juhi kõrvalistemele, mille eStu RVAPADI on AKt IVe eRItu D. t urvapadja avanemine võib last t ÖSISeLt või eLu ÖHt LIKuLt vigastada.
FI	ÄLÄ KOSKAAN aseta lapsen turvaistuinta selkã ajosuuntaan istuimelle, jonka edessä suojana on käyttöön aktivoitu tu RVAt YYNY. Sen laukeaminen voi aiheuttaa LAPSeN Ku OLeMAN tai VAKAVAN LOu KKAANt u MISEN.
FR	NE JAMAIS installer de système de retenue pour enfants faisant face vers l'arrière sur un siège protégé par un COUSSIN GONFLABLE frontal ACTIVÉ. Cela peut provoquer la MORT de l'eNFANt ou le BLeSSeR g RAVeMeNt
HR	NIKADA ne postavljati dječju sjedalicu leđima u smjeru vožnje na sjedalo zaštićeno UKLJUČENIM prednjim ZRAČNIM JASTUKOM. To bi moglo uzrokovati SMRT ili TEŠKU OZLJEDU djeteta.
Hu	SOHA ne használjon menetiránynak háttal beszerelt gyermekülést AKTIVÁLT (BEKAPCSOLT) FRONTLÉGSÁKKAL védett ülésen. Ez a gyermek HALÁLÁT vagy SÜLYÖS SÉRÜLÉSÉT okozhatja.
It	NON installare MAI seggiolini per bambini posizionati in senso contrario a quello di marcia su un sedile protetto da un AIRBAG frontale At t IVAt O. Ciò potrebbe provocare la MORT e o FeRIt e g RAVI al bambino.
Lt	NIEKADA neįrenkite vaiko prilaikymo priemonės su atgal atgrežtu vaiku ant sėdynės, kuri saugoma VEIKIANČIOS priekinės ORO PAGALVĖS. Išsiskleidus oro pagalvei vaikas gali būti MIRTINAI arba SUNKIAI TRAUMUOTAS.
LV	NEKAD NEuzstādiet uz aizmuguri vērstu bērnu sēdekļiti priekšējā pasažiera sēdvietā, kurā ir AKTIVIZĒTS priekšējais DROŠĪBAS GAISA SPILVeNS. Tas var izraisīt BĒRNA NĀVI vai radīt NOPIETNUS IEVAINOJUMUS.

Mt	Qatt m'għandek thalli tifel/tifla marbut f'siggu dahru lejn l-Airbag attiva, għaliex tista' tikkawza korriment serju jew anke mewt lit-tifel/tifla
NL	Plaats NOOIt een kinderzitje met de rug in de rijrichting op een zitplaats waarvan de AIRBAG is ING eSCHAKeLD. Bij het afgaan van de airbag kan het KIND Le VeNSg eVAARLIJK ge WOND RAKeN
NO	Installer ALDRI et barnesete med ryggen mot kjøretningen i et sete som er beskyttet med en frontal AKT IVeRt KOLLISJONSPu te , BARNet risikerer å bli DRePt eller HARDt SKADet .
PL	NIGDY nie instalować fotelika dziecięcego w pozycji "tyłem do kierunku jazdy" na siedzeniu wyposażonym w CZOŁOWĄ PODUSZKĘ POWIETRZNĄ w stanie AKTYWNYM. Może to doprowadzić do ŚMIERCI DZIECKA lub spowodować u niego POWAŻNE OBRAŻENIA CIAŁA.
Pt	Nu NCA instale um sistema de retenção para crianças de costas para a estrada num banco protegido por um AIRBAG frontal ACt IVADO. Esta instalação poderá provocar FERIMENTOS GRAVES ou a MORTE da CRIANÇA.
RO	Nu instalati NICIODAt A un sistem de retinere pentru copii, dispus cu spatele in directia de mers, pe un loc din vehicul protejat cu AIRBAG frontal ACt IVAt . Aceasta ar putea provoca MOARt e A COPILu Lu I sau RANIRe A lui g RAVA.
Ru	ВО ВСЕХ СЛУЧАЯХ ЗАПРЕЩАЕТСЯ использовать обращенное назад детское удерживающее устройство на сиденье, защищенном ФУНКЦИОНИРУЮЩЕЙ ПОДУШКОЙ БЕЗОПАСНОСТИ, установленной перед этим сиденьем. Это может привести к ГИБЕЛИ РЕБЕНКА или НАНЕСЕНИЮ ЕМУ СЕРЬЕЗНЫХ ТЕЛЕСНЫХ ПОВРЕЖДЕНИЙ
SK	NIKDY neinštalujte detské zádržné zariadenie orientované smerom dozadu na sedadlo chránené AKTIVOVANÝM čelným AIRBAGOM. Mohlo by dôjsť k SMRTELNÉMU alebo VÁŽNEMU PORANENIU DIEŤATA.
SL	NIKOLI ne nameščajte otroškega sedeža s hrbtom v smeri vožnje, če je VARNOSTNA BLAZINA pred sprednjim sopotnikovim sedežem AKTIVIRANA. Takšna namestitve lahko povzročijo SMRT OTROKA ali HUDE POŠKODBE.
SR	NIKADA ne koristite dečje sedišta koje se okreće unazad na sedištu zaštićenim AKTIVNIM VAZDUŠNIM JASTUKOM ispred njega, jer mogu nastupiti SMRT ili OZBILJNA POVREDA DETETA.
SV	Passagerarkrockkudden fram MÅSt e vara avaktiverad om en bakåtvänd bilbarnstol installeras på denna plats. Annars riskerar barnet att DÖDAS eller SKADAS ALLVARLig t .
t R	KESİNLKLE HAVA YASTIĞI AKTİF olan ön koltuğa yüzü arkaya dönük bir çocuk koltuğu yerleştirmeyiniz. Bu ÇOCUĞUN ÖLMESİNE veya ÇOK AĞIR YARALANMASINA sebep olabilir.

Child seats recommended by Peugeot Ot

Peugeot Ot offers a range of recommended child seats which are secured using a **three point seat belt**.

Group 0+: from birth to 13 kg	
	<p>L1 "RÖMeR Baby-Safe Plus" Installed in the rearward facing position.</p>
Groups 2 and 3: from 15 to 36 kg	
	<p>L4 "KLIPPAN Optima" From 22 kg (approximately 6 years), the booster is used on its own.</p>
	<p>L5 "RÖMeR KIDFIX" Can be fitted to the vehicle's ISOFIX mountings. The child is restrained by the seat belt.</p>

Installation of child seats attached using the seat belt

In accordance with european regulations, this table indicates the options for installing child seats secured using a seat belt and universally approved **(a)** in accordance with the weight of the child and the seat in the vehicle.

Seat	Weight of the child and indicative age			
	Under 13 kg Groups 0 (b) and 0+ up to about 1 year	From 9 to 18 kg Group 1 From about 1 to 3 years	From 15 to 25 kg Group 2 From about 3 to 6 years	From 22 to 36 kg Group 3 From about 6 to 10 years
Front passenger seat (c) (e)	U (R)*	U (R)*	U (R)*	U (R)*
Rear seats (d)	U	U	U	U

8

* On a front seat:

- For the installation of a child seat with a base: if there is interference with the vehicle's seat backrest when fitting a child seat with base, adjust the backrest until there is no longer any interference.
- For the installation of a "forward facing" child seat: if there is a gap between the child seat and the vehicle seat's backrest, adjust the backrest until the child seat is in contact with the backrest. If the upper seat belt anchorage is in front of the belt guide on the child seat, move the vehicle seat forward.
- For the installation of a booster cushion: if the child is in a too vertical position, adjust the backrest to give a more comfortable position. If the upper seat belt anchorage is in front of the belt guide on the child seat, move the vehicle seat forward.

- a:** universal child seat: child seat that can be installed in any vehicle using the vehicle's seat belt.
 - b:** group 0: from birth to 10 kg. Infant car seats and "car cots" cannot be installed on the front passenger seat
When installed on the 2nd row, they may prevent the use of the other seats
 - c:** Refer the legislation in force in your country before installing your child on this seat.
 - d:** to install a child seat on a rear seat, rearward or forward facing, move the vehicle's seats in front forwards and straighten the backrests to leave enough space for the child seat and the child's legs.
 - e:** When a "rearward facing" child seat is installed **on the front passenger seat**, the passenger's front airbag must be deactivated. Otherwise, **the child would risk being seriously injured or killed during deployment of the airbag.**
When a "rearward facing" child seat is installed **on the front passenger seat**, the passenger's front airbag must remain active.
- U:** Seat suitable for the installation of a universally approved child seat secured using a seat belt, "rearward facing" and/or "forward facing", with the passenger seat adjusted to the midway longitudinal position.
- U (R):** same as for **U**, with the vehicle's seat in the fully back position and the backrest straightened.

i Remove and stow the head restraint before installing a child seat with a backrest on a passenger seat. Refit the head restraint once the child seat has been removed.

"ISOFIX" mountings

Your vehicle has been approved in accordance with the **latest ISOFIX regulation**. The seats, represented below, are fitted with regulation ISOFIX mountings:

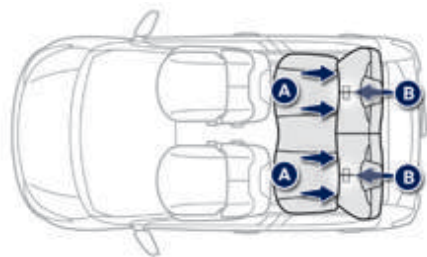

There are three anchorages for each seat:



- two anchorages **A**, located between the vehicle seat back and cushion, indicated by a marking,

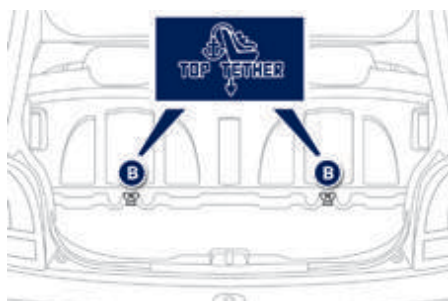

- an anchorage **B** behind the seat for fixing the upper strap, referred to as the **Top Tether**. It is identified by a marking.

The top tether is used to secure the upper strap of child seats that have one. This arrangement limits the forward tipping of the child seat in the event of a front impact.

This ISOFIX mounting system provides fast, reliable and safe fitting of the child seat in your vehicle.

The **ISOFIX child seats** are fitted with two latches which are secured on the two anchorages **A**.

Some seats also have an **upper strap**, known as the top tether, which is attached to anchorage **B**.

To secure the child seat to the top tether:

- remove and stow the head restraint before installing the child seat in this seating position (refit it once the child seat has been removed),
- pass the strap of the child seat over the top of the seat backrest, between the apertures for the head restraint rods,
- fix the hook of the upper strap to the anchorage **B**,
- tighten the upper strap.

i The incorrect installation of a child seat in a vehicle compromises the child's protection in the event of an accident.

! Follow the instructions for fitting child seats contained in the seat manufacturer's installation guide.

For information on the possibilities for installing ISOFIX child seats in your vehicle, refer to the summary table.

ISOFIX child seats recommended by Peugeot Ot and approved for your vehicle

Baby P2C Mini and its ISOFIX base (size category: E)

Group 0+: from birth to 13 kg



Installed "rearward facing" using an ISOFIX base which is attached to the anchorage rings **A**.
The base has a support leg, adjustable for height, which sits on the vehicle's floor.
This seat can also be secured with a seat belt.
In this case only the seat shell is used.

"Baby P2C Midi" and its ISOFIX base (size categories: D, C, A, B, B1)

Group 1: from 9 to 18 kg



Installed "rearward facing" using an ISOFIX base which is attached to the anchorage rings **A**.
The base has a support leg, adjustable for height, which sits on the vehicle's floor.
This child seat can also be used "forward facing".
This seat can **not** be secured with a seat belt.
We recommend that you use the seat in the "rearward facing" position up to the age of 3 years.

i Follow the instructions for fitting child seats contained in the seat manufacturer's installation guide.
The ISOFIX BABY P2C base must be installed in a way that the ISOFIX latches 3, 4 and 5 are visible. And the support leg must have 6 holes visible.

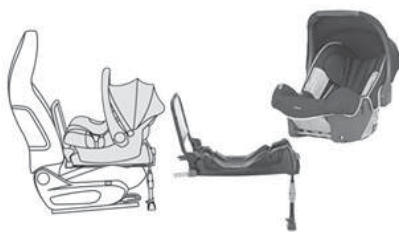
"RÖMER Baby-Safe Plus and its Baby-Safe Plus ISOFIX base" (size category: E)**Group 0+: from birth to 13 kg**

Installed "rearward facing" using an ISOFIX base which is attached to the rings **A**. The base has a support leg, adjustable for height, which sits on the vehicle's floor. This child seat can also be secured with a seat belt. In this case, only the shell is used and attached to the vehicle's seat by the three-point seat belt.

i Follow the instructions for fitting child seats contained in their manufacturer's installation guide.

"RÖMER Duo Plus ISOFIX" (size category B1)

Group 1: from 9 to 18 kg



Is installed only in the forward facing position.
Is attached to the anchorage rings **A** and the upper anchorage ring **B**, referred to as the top tether, using an upper strap.
Three seat body angles: sitting, reclining, lying down.
We recommend the lying down position.

i This seat can be used on seats not equipped with ISOFIX mountings.
In this case, it must be attached to the vehicle's seat using the three-point seat belt.
Adjust the front seat of the vehicle so that the child's feet do not touch the backrest.

Follow the instructions for fitting child seats contained in the seat manufacturer's installation guide.

Table of locations for ISOFIX child seats

In accordance with the European regulation, this table indicates the options for the installation of ISOFIX child seats on the vehicle seats fitted with ISOFIX mountings.

In the case of the universal and semi-universal ISOFIX child seats, the child seat's ISOFIX size category, determined by a letter between **A** and **G**, is indicated on the child seat next to the ISOFIX logo.

	Weight of the child / indicative age									
	Less than 10 kg (group 0) up to about 6 months		Less than 10 kg (group 0) Less than 13 kg (group 0+) up to about 1 year			From 9 to 18 kg (group 1) From about 1-3 years				
Type of ISOFIX child seat	Infant carrier		"rearward facing"			"rearward facing"		"forward facing"		
ISOFIX size category	F	G	C	D	E	C	D	A	B	B1
Front passenger seat	Not ISOFIX									
Rear seats	X		IL-SU (2)	IL-SU (1)		IL-SU (2)	IL-SU (1)	IUF IL-SU		

IUF: Seat suitable for the installation of an Universal Isofix seat, "Forward facing" with the "top tether" upper strap.

IL-SU: Seat suitable for the installation of a Semi-Universal ISOFIX seat, that is:

- "rearward facing" fitted with an upper strap or a support leg
- "forward facing" fitted with a support leg
- an infant carrier fitted with an upper strap or a support leg.

To attach the upper strap, refer to the "ISOFIX mountings" section.

(1): The front seat must be adjusted to 9 notches back from the fully forward position.

(2): The front seat must be adjusted to 4 notches back from the fully forward position.

i Remove and stow the head restraint before installing a child seat with a backrest on a passenger seat. Refit the head restraint once the child seat has been removed.

Recommendations on child seats

! The incorrect installation of a child seat in a vehicle compromises the child's protection in the event of an accident.

Check that there is no seat belt or seat belt buckle under the child seat as this could destabilise it.

Remember to fasten the seat belts or the child seat harnesses **keeping the slack** in relation to the child's body **to a minimum**, even for short journeys.

For the installation of a child seat using a seat belt, ensure that this is well tensioned on the child seat and that it is holding the child seat firmly against the seat of your vehicle. If your front passenger seat is adjustable, move it forward if necessary.

At the rear seats, always leave sufficient space between the front seat and:

- a rearward facing child seat,
- the feet of a child seated in a forward facing child seat.

For this, move the front seat forward and if necessary straighten its backrest.

For optimum installation of the "forward facing" child seat, ensure that the back of the child seat is as close as possible to the backrest of the vehicle's seat, or in contact if possible.

The head restraint must be removed before installing a child seat with a backrest on the passenger seat.

ensure that the head restraint is stowed or attached securely so that it is not thrown around the vehicle in the event of sharp braking.

Refit the head restraint as soon as the child seat is removed.

Children at the front

The legislation on carrying a child on the front passenger seat is specific to each country. Refer to the legislation in force in your country.

Deactivate the passenger's front airbag when a "rearward facing" child seat is installed on the front seat. Otherwise, the child would risk being seriously injured or killed if the airbag were deployed.

Installing a booster cushion

The chest part of the seat belt must be positioned on the child's shoulder without touching the neck.

ensure that the lap part of the seat belt passes correctly over the child's thighs.

Peugeot recommends the use of a booster seat which has a back, fitted with a seat belt guide at shoulder level.

As a safety precaution, never leave:

- one or more children alone and unsupervised in a vehicle,
- a child or an animal in a vehicle which is exposed to the sun, with the windows closed,
- the keys within reach of children inside the vehicle.

To prevent accidental opening of the doors, use the "Child lock".

Take care not to open the rear windows by more than one third.

To protect young children from the rays of the sun, fit side blinds on the rear windows.

Child lock

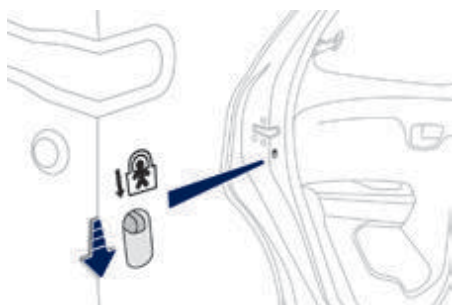

This prevents the opening of the rear doors from the inside.

The controls are located on the edge of each rear door.

☞ Lower the control.

Check the status of this safety device before switching on the ignition.

This system is independent of the central locking.

Fuel tank

The capacity of the fuel tank is approximately 35 litres.

Low fuel level



When the low fuel level is reached, this warning lamp comes on and the last bar flashes, accompanied by an audible signal.

You have approximately 5 litres remaining.

In certain driving conditions and depending on the engine, the distance which can be travelled with the fuel remaining may be less than 30 miles (50 km).

When the frequency of the flashing increases, **you have approximately 3 litres remaining.**



If you run out of fuel, the emission control system warning lamp may come on in the instrument panel. It will go off automatically after the engine has been started a few times.

Refuelling

Refuelling must only be done **with the engine stopped and the ignition switched off** (ignition switch in the "LOCK" position or "OFF" mode).

Additions of fuel must be of at least 5 litres to be registered by the fuel gauge.

A label on the inside of the flap reminds you which type of fuel to use.

It may be an inrush of air when removing the filler cap. This vacuum is perfectly normal and results from the sealing of the fuel system.



To refuel in complete safety:

- ☞ **You must stop the engine and switch off the ignition (ignition in "LOCK" position or "OFF" mode).**
- ☞ Pull the control on the lower dashboard, driver's side, to release the filler flap.
- ☞ Open the fuel filler flap.

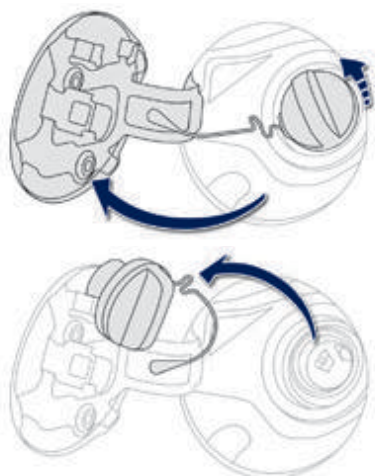

- ☞ Unscrew the filler cap and hook it on the bracket on the inner face of the filler flap.
- ☞ Insert the filler nozzle as far as it will go, before starting delivery of fuel (risk of blow-back).
- ☞ Keep the nozzle in this position while refuelling.

Once refuelling is complete:

- ☞ Fit and tighten the filler cap until you hear a click.
When you release the filler cap, it turns slightly in the opposite direction.
- ☞ Push the filler flap to close it.

When you fill the fuel tank, do not continue after the 3rd cut-off of the pump; this could cause malfunctions.

Your vehicle is fitted with a catalytic converter that reduces harmful exhaust emissions. The filler neck has a narrower aperture that only admits nozzles on pumps delivering **unleaded petrol**.

Quality of the fuel used for petrol engines

The petrol engines are compatible with e10 type petrol biofuels (containing 10 % ethanol), conforming to European standards eN 228 and eN 15376. e85 type fuels (containing up to 85 % ethanol) are reserved exclusively for vehicles marketed for the use of this type of fuel (BioFlex marketed vehicles). The quality of the ethanol must comply with European standard eN 15293.

Temporary puncture repair kit

Complete system consisting of a compressor and a sealant cartridge which permits **temporary repair** of a tyre so that you can drive to the nearest garage.

It is designed to repair most punctures which could affect the tyre, located on the tyre tread or shoulder.

Access to the kit

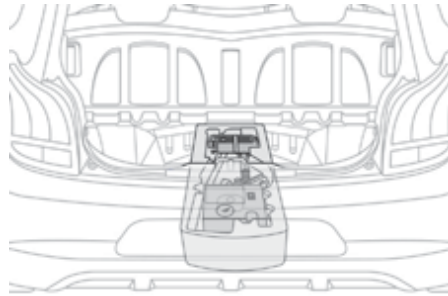

This kit is installed in the storage box, under the boot floor.

i If the vehicle's electric system allows the connection of a compressor for long enough to inflate a tyre after a puncture repair or for inflating a small inflatable accessory.

Composition of the kit

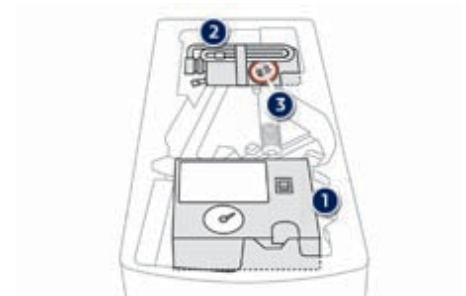

1. 12 V compressor, with integral pressure gauge.
2. Sealant cartridge, with integral hose.
3. Speed limit sticker.

i The speed limit sticker must be secured to the interior of the vehicle in the driver's field of vision, to remind you that a wheel is in temporary use.

! Do not exceed a speed of 50 mph (80 km/h) when driving with a tyre repaired using this type of kit.

Repair procedure



- ☞ Switch off the ignition.
- ☞ Secure the speed limit sticker inside the vehicle.



- ☞ Uncoil the pipe stowed under the compressor.
- ☞ Connect the pipe from the compressor to the sealant cartridge.
- ☞ Turn the sealant cartridge and secure it in the cut-out provided on the compressor.

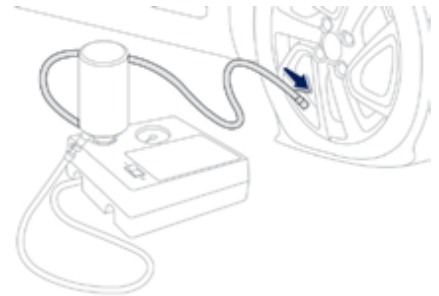

- ☞ Remove the valve cap from the tyre to be repaired, and place it in a clean area.
- ☞ Connect the hose from the sealant cartridge to the valve of the tyre to be repaired and tighten firmly.

i Avoid removing any foreign bodies which have penetrated into the tyre.

Practical information

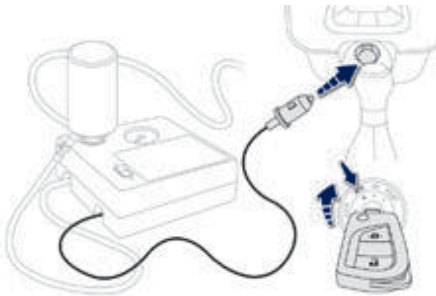

- ☞ Check that the compressor switch is at the "O" position).
- ☞ Uncoil fully the electric cable, stowed under the compressor.
- ☞ Connect compressor's plug to the vehicle's 12 V socket.
- ☞ Switch on the ignition.

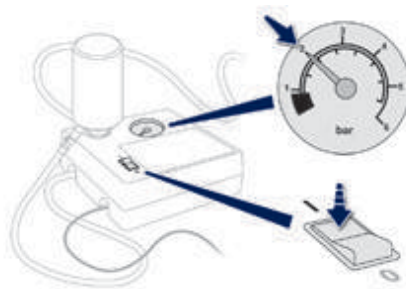

- ☞ Start the compressor by placing the switch at the "I" position and leave it running until the tyre pressure reaches 2.0 bar. The sealant product is injected into the tyre under pressure; do not disconnect the pipe from the valve during this operation (risk of splashing and stains).

i If after around 5 to 7 minutes the pressure is not attained, this indicates that the tyre is not repairable; contact a Peugeot dealer or a qualified workshop for assistance.

! Take care, the sealant product is harmful (e.g. ethylene-glycol, colophony...) if swallowed and causes irritation to the eyes. Keep this product out of the reach of children. The use-by date is marked on the cartridge. After use, do not discard the cartridge by the roadside, take it to a Peugeot dealer or an authorised waste disposal site. Don't forget to obtain a new sealant cartridge, available from a Peugeot dealer or a qualified workshop.

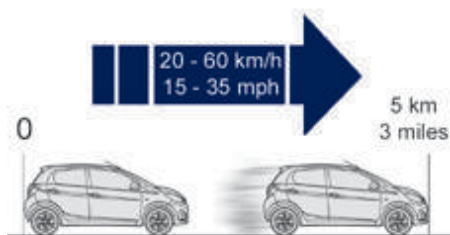

- ☞ Place the switch in the "O" position.
- ☞ Remove the kit.
- ☞ Drive immediately for approximately three miles (five kilometres), at reduced speed (between 15 and 35 mph (20 and 60 km/h)), to plug the puncture.
- ☞ Stop to check the repair and the tyre pressure using the kit.

Checking / adjusting tyre pressures

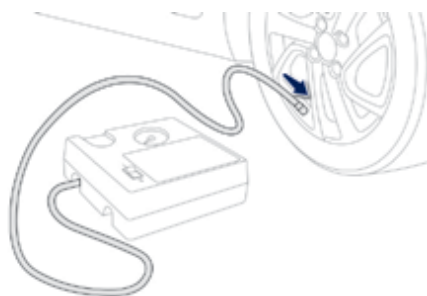

You can also use the compressor, without injecting sealant, to check and if necessary adjust the tyre pressures

- ☞ Remove the valve cap from the tyre and place it in a clean area.
- ☞ uncoil the pipe stowed under the compressor.
- ☞ Screw the pipe onto the valve and tighten firmly.

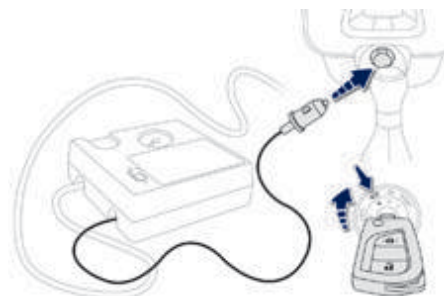

- ☞ Check that the compressor switch is at the "O" position.
- ☞ uncoil fully the electric cable, stowed under the compressor.
- ☞ Connect the compressor's plug to the vehicle's 12 V socket.
- ☞ Switch on the ignition.

Practical information

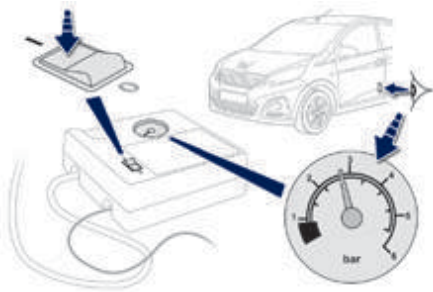

- ☞ Start the compressor by placing the switch at the "I" position and adjust the pressure to the value shown on the vehicle's tyre pressure label.
- ☞ To deflate: press the black button on the compressor pipe, at the valve connector.
- ☞ Once the correct pressure is reached, put the switch to the "O" position.
- ☞ Remove the kit then stow it.

i Tyre under-inflation detection

After repair of the tyre, the warning lamp will remain on until the system is reinitialised.
For more information, refer to the "u nder-inflation detection" section.

- ! Should the pressure of one or more tyres be adjusted, it is necessary to reinitialise the under-inflation detection system.
Refer to the "u nder-inflation detection" section.

Changing a wheel

Procedure for replacing a wheel by the spare wheel using the tools supplied with the vehicle.

Parking the vehicle

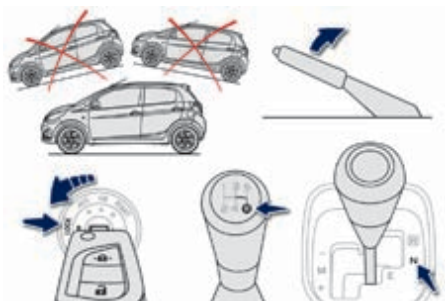

- ☞ As far as possible, immobilise the vehicle on level, stable, non-slippery ground.
- ☞ Apply the parking brake, switch off the ignition ("**OFF**" mode for vehicles fitted with "Keyless entry and Starting") and engage first gear or reverse for the manual gearbox, position **N** for the electronic gearbox.

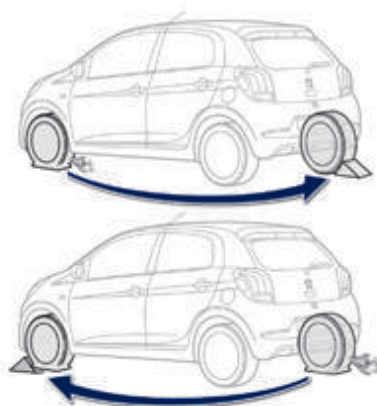

- ☞ If necessary, chock the wheel diagonally opposite the wheel to be changed.
- ☞ You must ensure that the occupants leave the vehicle and wait in a safe location.

Access to the spare wheel and tools

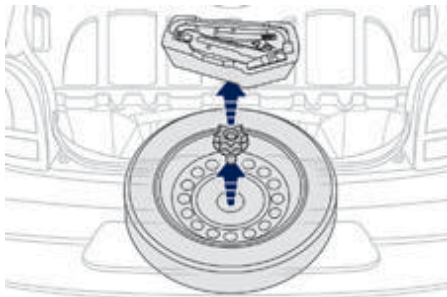

Depending on version, the spare wheel and tools are stowed in the boot under the floor.

- 🔧 Remove the boot carpet.
- 🔧 Remove the tool carrier.
- 🔧 Slacken the central wheel retaining bolt.
- 🔧 Remove the wheel.

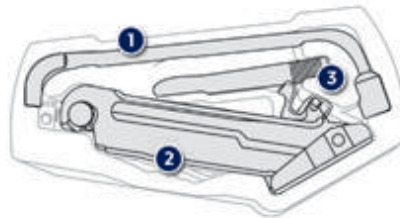

Tools provided

The following tools are installed in a carrier, located in the centre of the spare wheel:

1. Wheelbrace
2. Jack with handle
3. Removable towing eye.
Refer to the "Towing the vehicle" section.

i All of these tools are specific to your vehicle and can vary according to equipment. Do not use them for any other purposes. Never go underneath a vehicle supported only by a jack (use an axle stand).

Do not use:

- the jack for anything other than lifting the vehicle,
- any other jack than the one provided by the manufacturer.

Tyre pressures

These are indicated on the label affixed to the middle pillar of the left door, driver's side. Refer to the "Identification markings" section.

Removing a wheel

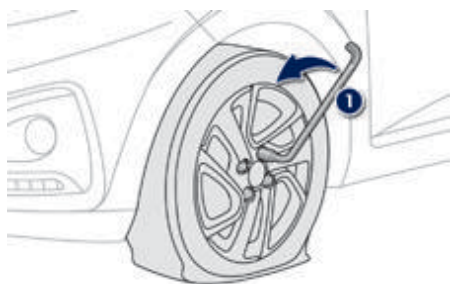

- ☞ Remove the label from the middle of the spare wheel (indicating that a wheel needs repair), and fix it inside the vehicle, where the driver can see it.
- ☞ Remove the wheel trim using the end of the wheelbrace.
- ☞ Slacken the wheel bolts using the wheelbrace 1.

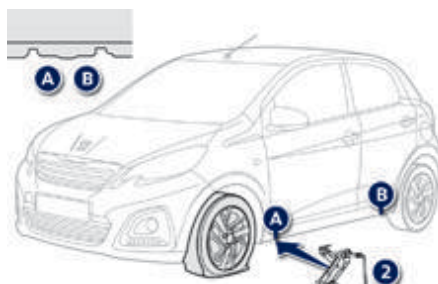

- ☞ Position the foot of the jack 2 on the ground and ensure that it is directly below one of the jacking points **A** or **B** located on the underbody, closest to the wheel to be changed.
- ☞ extend the jack 2 until its head is in contact with the jacking point **A** or **B** used. The contact surface **A** or **B** on the vehicle used must engage correctly with the middle of the head of the jack.



- ☞ Raise the vehicle until there is sufficient space between the wheel and the ground, so that the (not punctured) spare wheel can be easily fitted.

! ensure that the jack is stable. If the ground is slippery or loose, the jack may slip or drop - Risk of injury!
 ensure that the jack is positioned only at one of the jacking points **A** or **B** under the vehicle, making sure that the vehicle's contact surface is centred on the head of the jack. Otherwise there is a risk of damage to the vehicle and/or of the jack dropping - Risk of injury!

Fitting a wheel

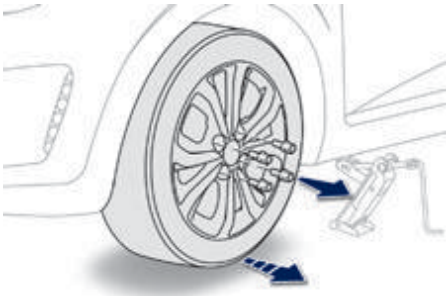

- ☞ Remove the bolts and put them in a clean place.
- ☞ Remove the wheel.



i Fitting the "space-saver" type spare wheel

If your vehicle is fitted with alloy wheels, it is **normal** to notice when tightening the wheel bolts that the washers do not come into contact with the "space-saver" type spare wheel. The wheel is secured by the conical contact surface on each bolt.

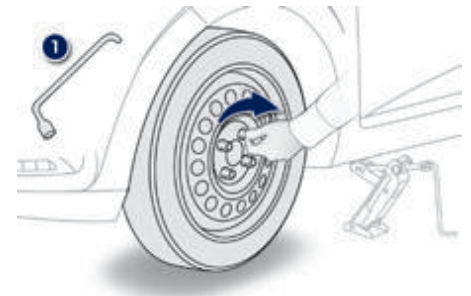

- ☞ Position the wheel on the hub.
- ☞ Screw in the bolts fully by hand.
- ☞ Pre-tighten the bolts using the wheelbrace 1 only.

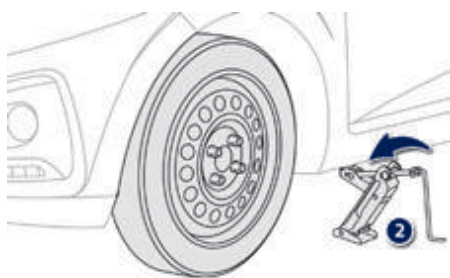

- ☞ Lower the vehicle to the ground.
- ☞ Fold the jack **2** and detach it.

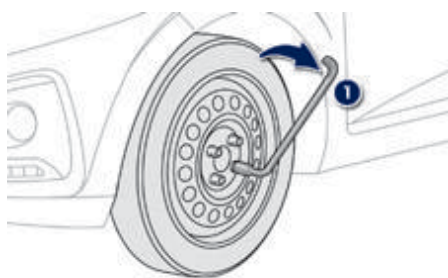

- ☞ Tighten the wheel bolts using the wheelbrace **1**.
- ☞ Store the tools and the wheel in the boot.

i After changing a wheel

As soon as possible, have the tightness of the wheel bolts and the pressure of the spare wheel checked by a Peugeot dealer or a qualified workshop.
Have the punctured tyre repaired or replaced and refit it to the vehicle as soon as possible.

! Do not exceed 50 mph (80 km/h) when using the "space-saver" spare wheel.

Snow chains

In wintry conditions, snow chains improve traction as well as the behaviour of the vehicle when braking.

i The snow chains must be fitted only to the front wheels. They must never be fitted to "space-saver" type spare wheels.

i Take account of the legislation in force in your country on the use of snow chains and the maximum running speed authorised.

Use only the chains designed to be fitted to the type of wheel fitted to your vehicle:

Original tyre size	Maximum link size.
165/65 R14	9 mm
165/60 R15	

i For more information on snow chains, contact a Peugeot dealer or a qualified workshop.

Advice on installation

- ☞ If you have to fit the chains during a journey, stop the vehicle on a flat surface on the side of the road.
- ☞ Apply the parking brake and position any wheel chocks to prevent movement of your vehicle.
- ☞ Fit the chains following the instructions provided by the manufacturer.
- ☞ Move off gently and drive for a few moments, without exceeding 30 mph (50 km/h).
- ☞ Stop your vehicle and check that the snow chains are correctly tightened.

i Avoid driving with snow chains on roads that have been cleared of snow, to avoid damaging your vehicle's tyres and the road surface. If your vehicle is fitted with alloy wheels, check that no part of the chain or its fixings is in contact with the wheel rim.

i It is strongly recommended that before you leave, you practise fitting the snow chains on a level and dry surface.

Changing a bulb

Front lamps

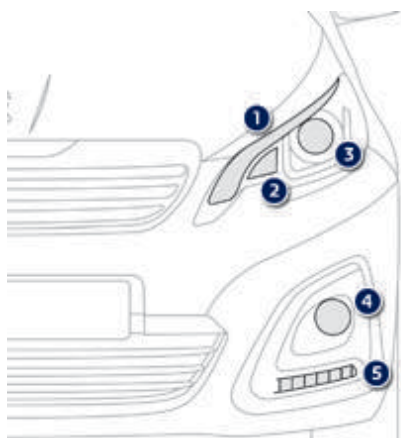

1. Sidelamps (LEDs*).
2. Direction indicators (PY21W amber).
3. Dipped beam / Main beam headlamps (HiR2-55W).
4. Front foglamps.
5. Daytime running lamps (LEDs*).

* LeD: light-emitting diode.

i In some weather conditions (e.g. low temperature or humidity), the presence of misting on the internal surface of the glass of the headlamps and rear lamps is normal; it disappears after the lamps have been on for a few minutes.

! The headlamps are fitted with polycarbonate glass with a protective coating:

- ☞ **do not clean them using a dry or abrasive cloth, nor with a detergent or solvent product,**
- ☞ use a sponge and soapy water or a pH neutral product,
- ☞ when using a high pressure washer on persistent marks, do not keep the lance directed towards the lamps or their edges for too long, so as not to damage their protective coating and seals.

Changing a bulb should only be done after the headlamp has been switched off for several minutes (risk of serious burns).

- ☞ Do not touch the bulb directly with your fingers, use a lint-free cloth.

It is imperative to use only anti-ultraviolet (uV) type bulbs to avoid damaging the headlamp.

Always replace a failed bulb with a new bulb with the same type and specification.



Sidelamps (LEDs)

For the replacement of these lamps, contact a Peugeot dealer or a qualified workshop.

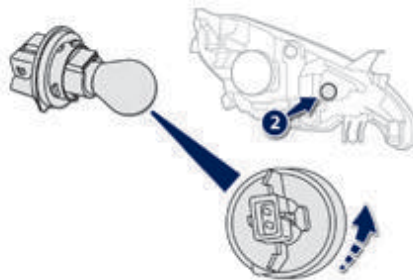

Direction indicators (PY 21W amber)

- ☞ Turn the bulb holder one quarter of a turn and remove it.
 - ☞ Remove the bulb and change it.
- If you encounter any difficulties, contact a Peugeot dealer or a qualified workshop.

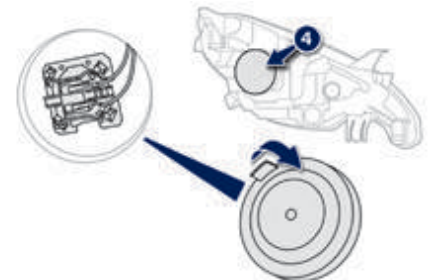

Dipped / Main beam headlamps (HiR2-55W)

- ☞ Remove the protective cover by pulling the clip.
- ☞ Spread the spring to free the bulb holder.
- ☞ Remove the assembly of bulb holder and bulb and change it.

To reassemble, carry out these operations in reverse order.

If you encounter any difficulties, contact a Peugeot dealer or a qualified workshop.

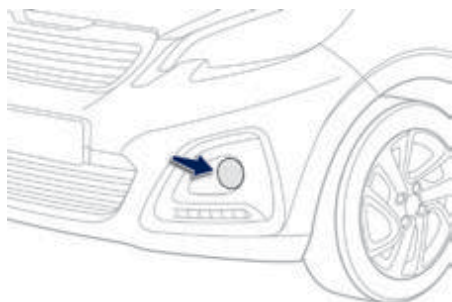

Front foglamps

For replacement of these bulbs, contact a Peugeot dealer or a qualified workshop.



LED daytime running lamps

For the replacement of these lamps, contact a Peugeot dealer or qualified workshop.

Rear lamps



1. Brake lamps (P21/5W)
2. Sidelamps (P21/5W)
3. Direction indicators (PY21W)
4. Reversing lamp (P21W), near side
Foglamp (P21W), offside

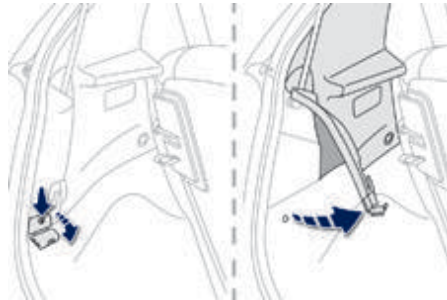

These bulbs are changed by removing the lamp unit:

- ☞ Open the boot,
- ☞ tip the plastic cover and remove the screw.
- ☞ Move the boot trim firmly aside. Deformation of the trim is normal.
- ☞ Unscrew the nut and remove it (take care not to drop it in the wing).
- ☞ Remove the lamp unit by pulling it firmly outwards.

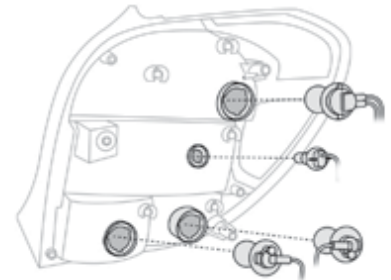

- ☞ At the back of the lamp, remove the failed bulb and change it.

When refitting, proceed in the reverse order, taking care to position the lamp unit correctly.



Number plate lamps (W5W)

- ☞ Insert a thin screwdriver into one of the cutouts in the the lens.
- ☞ Push it outwards to unclip it.
- ☞ Remove the lens.
- ☞ Change the faulty bulb.

t o refit, press on the lens to clip it in place.

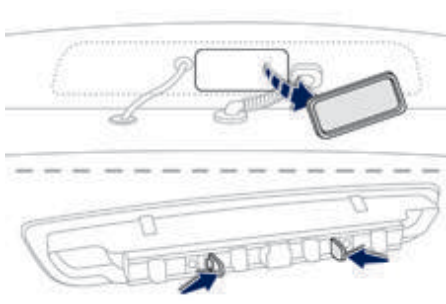

Third brake lamp (4 W5W bulbs)

- ☞ With the boot open, unclip the plastic cover.
- ☞ Press the metal clips to disengage the lamp.
- ☞ Remove the lamp via the exterior of the tailgate.
- ☞ Remove the bulb-holder by squeezing the plastic catches.
- ☞ Change the failed bulb(s).

t o refit, carry out these operations in reverse order.

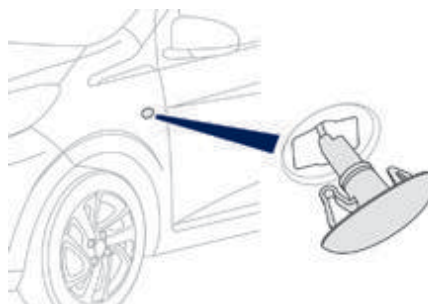

Direction indicator side repeaters (WY 5W amber)

- ☞ Push the repeater forwards or rearwards and detach it by pulling towards you.
- ☞ Disconnect the bulb holder and change it.

Changing a fuse

the fuseboxes are located behind the dashboard in the passenger compartment and next to the battery under the bonnet.

Access to tools

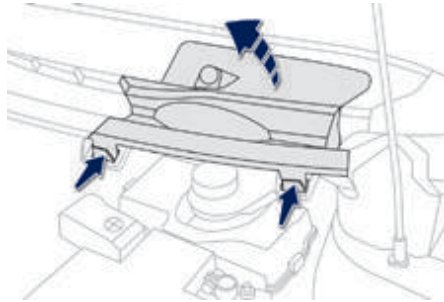

the extraction tweezers is fixed at the front of the underbonnet fusebox.

- ☞ unclip the plastic cover, located below the windscreen, by pressing on the two catches.

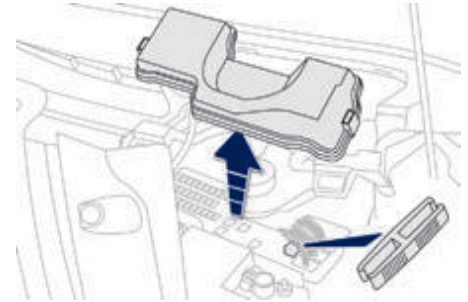

- ☞ unclip the fusebox cover by pressing on the lug on the right.
- ☞ Remove the tweezers.

i When unclipping the plastic cover, take care not to remove the seal.

Replacing a fuse

Before changing a fuse, it is necessary to

- ☞ immobilise the vehicle and switch off the ignition,
- ☞ switch off all electrical consumers,
- ☞ identify the failed fuse using the fuse allocation tables and diagrams in the following pages,
- ☞ identify and correct the cause of the problem.

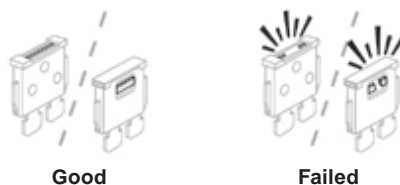

Good

Failed



Tweezer

When replacing a fuse, you must always:

- ☞ use the special tweezers to extract the fuse from its holder and check the condition of its element,
- ☞ replace a failed fuse by one of the same rating (same colour); the use of a different rating fuse could cause a fault (risk of fire).

If the problem recurs after replacing the fuse, have the vehicle's electrical system checked by Peugeot dealer or a qualified workshop.

i Installation of electrical accessories

Your vehicle's electrical system is designed to operate with standard or optional equipment.

Before installing other electrical equipment or accessories on your vehicle, contact a Peugeot dealer or a qualified workshop.

- ! Peugeot will not accept any responsibility for the costs incurred in repairing your vehicle or for the malfunctions resulting from the installation of auxiliary accessories which were not supplied or recommended by Peugeot and which were not installed in accordance with its instructions, in particular where the current consumption of all the the additional equipment connected exceeds 10 milliamps.

Dashboard fuses

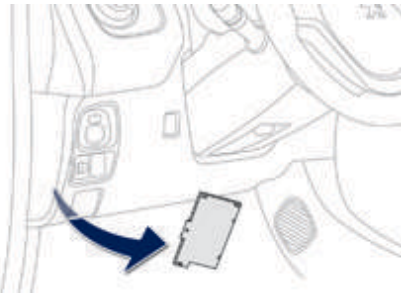

The fusebox is located below the dashboard (driver's side).

☞ Unclip the plastic cover for access to the fuses.

When you have finished, carefully refit the cover.

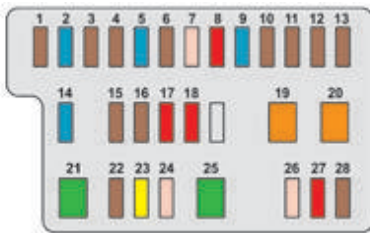

Fuse N°	Rating (A)	Functions
1	5	Fuel injection system - Audio system - VSC system
2	15	Front and rear screenwash
3	5	Main distribution unit - Instrument panel - Display screen - Air conditioning - Heated rear screen and door mirror heating - Heated seats - electric fabric roof - Audio system
4	5	electric power steering - Stop & Start
5	15	Rear wiper
6	5	Cooling fan - ABS system eSP - VSC system
7	25	Front wiper
8	10	Heated door mirrors
9	15	12 V socket (120 W max)
10	7.5	Door mirrors - Audio system - Stop & Start - Instrument panel - Display screen

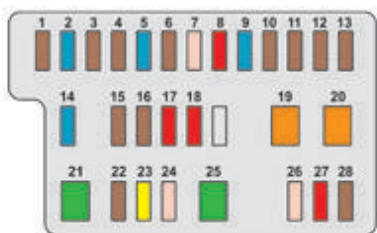

Fuse N°	Rating (A)	Functions
11	5	Steering lock - Fuel injection system - electronic gearbox
12	7.5	Airbags
13	5	Instrument panel - Display Screen - Stop & Start
14	15**	Steering - Fuel injection system - Brake lamps
	7.5*	
15	7.5**	Fuel injection system - Stop & Start
	10*	
16	7.5	engine diagnosis
17	10	Brake lamps - third brake lamp - Fuel injection system - ABS system - VSC system - electronic gearbox - Keyless entry and Starting system
18	10	Sidelamps - Number plate lamps - Rear foglamp - Front foglamps - Rear lamps - Lighting dimmer
19	40	Air conditioning

* Vt i 82 engine.
 ** Vt i 68 engine.

Practical information

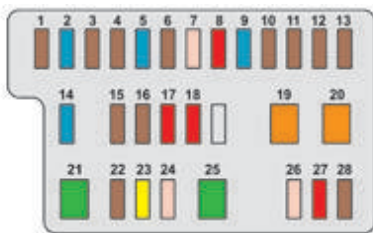

Fuse N°	Rating (A)	Functions
20	40	Air conditioning - engine self-diagnosis - Sidelamps - Number plate lamps - Rear foglamp - Front foglamps - Rear lamps - Lighting dimmer - Brake lamps - t hird brake lamp - Fuel injection system - ABS system - VSC system - e lectronic gearbox - "Keyless entry and Starting" system - e lectric windows
21	30	Fuel injection system - Stop & Start - Main distribution unit
22**	7,5	Fuel injection system
23**	20	Fuel injection system - Stop & Start
24	25	Main distribution unit
25	30	e lectric windows
26	25	e lectric windows
27	10	Air conditioning
28	5	Rear foglamp

** Vt i 68 engine.

Fuses under the bonnet

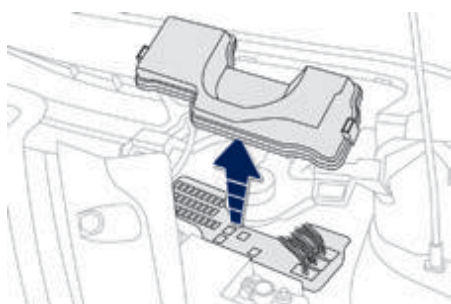

- ☞ unclip the plastic cover, located below the windscreen, by pressing on the two catches.
- ☞ unclip the fusebox cover by pressing on the lug on the right, for access to the fuses.

When you have finished, carefully refit the cover.

Fuse N°	Rating (A)	Functions
1	10	Right hand dipped beam
2	10	Left hand dipped beam - Headlamp adjustment
3	7.5	Right hand main beam
4	7.5	Left hand main beam
5*	15	Fuel injection system
6*	7.5	Fuel injection system
7*	15	Fuel injection system
8*	7.5	Cooling fan
9	7.5	Air conditioning
10**	7.5	Fuel injection system - Brake lamps - Hand brake lamp
11	5	Courtesy lamp - Boot lamp
12	10	Direction indicators - Hazard warning lamps - Instrument panel - Display screen

* Vt i 82 engine.

** Vt i 68 engine.

Practical information

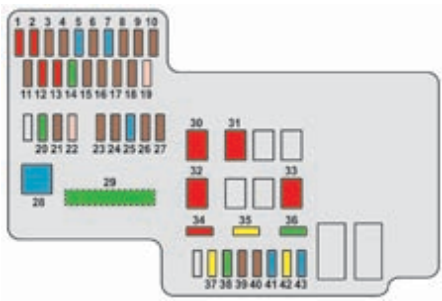

Fuse N°	Rating (A)	Functions
13	10	Horn
14	30	Distribution units
15**	7.5	electronic gearbox
16	7.5	Fuel injection system
17	7.0	Keyless entry and Starting system
18**	7.5	Battery
19	25	Fuel injection system - Cooling fan
20	30	Starter motor
21	7.5	Steering lock
22	25	Front lamps
23	7.5	Fuel injection system
24	7.5	Fuel injection system - Starter motor - electronic gearbox - Stop & Start
25	15	Audio system - "Keyless entry and Starting" system
26	7.5	Instrument panel - Display screen

** Vt i 68 engine.

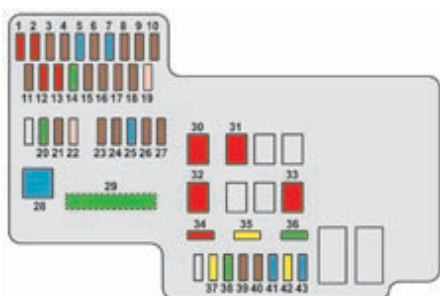

Fuse N°	Rating (A)	Functions
27	7.5	VSC system
28	60	Passenger compartment fusebox
29**	125***	Heated rear screen and door mirror heating - Heated seats - electric fabric roof - ABS system - VSC system - Cooling fan - Front foglamps - LeD daytime running lamps
30	50	electronic gearbox
	40	Stop & Start
31	50	Power steering
32	50*	Cooling fan
	30	
	40	
33	50	ABS system - VSC system
34	10	Spare fuse

* Vt i 82 engine.

** Vt i 68 engine.

*** t his fuse must be replaced only by a Peugeot dealer or a qualified workshop.

Practical information

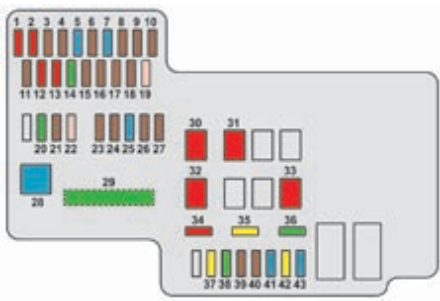

Fuse N°	Rating (A)	Functions
35	20	Spare fuse
36	30	Spare fuse
37	20	Heated rear screen and door mirror heating
38	30	ABS system - VSC system
39	7.5	Front foglamps - Instrument panel - Display screen
40	7.5	LeD daytime running lamps
41	15	Right hand heated seat
42	20	electric fabric roof
43	15	Left hand heated seat

12 V battery

Procedure for starting the engine using another battery or charging a discharged battery.



! The presence of this label, in particular with the Stop & Start system, indicates the use of a 12 V lead-acid battery with special technology and specification; the involvement of a Peugeot dealer or a qualified workshop is essential when replacing or disconnecting the battery.

i After refitting the battery, the Stop & Start system will only be active after a continuous period of immobilisation of the vehicle, a period which depends on the climatic conditions and the state of charge of the battery (up to about 8 hours).

! Before doing any work

Immobilise the vehicle: apply the parking brake, put the gearbox in neutral, then switch off the ignition. Check that all electrical equipment is switched off.

! Do not push the vehicle to start the engine if you have an etg electronic gearbox.

Access to the battery

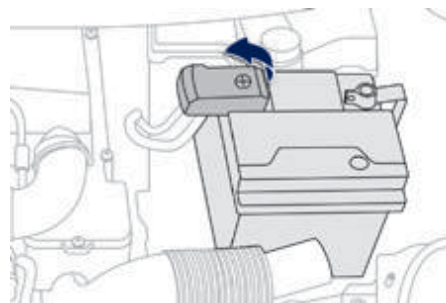

The battery is located under the bonnet.

For access to the (+) terminal:

- ☞ release the bonnet using the interior lever, then the exterior safety catch,
- ☞ raise the bonnet and secure it with its stay,
- ☞ lift the plastic cover for access to the (+) terminal.

Starting using another battery

When your vehicle's battery is discharged, the engine can be started using a slave battery (external or on another vehicle) and jump lead cables.

! First check that the slave battery has a nominal voltage of 12 V and a capacity at least equal to that of the discharged battery.
Do not try to start the engine by connecting a battery charger.
Do not disconnect the (+) terminal when the engine is running.

- ☞ Connect the red cable to the positive terminal (+) of the flat battery **A**, then to the positive terminal (+) of the slave battery **B**.
- ☞ Connect one end of the green or black cable to the negative terminal (-) of the slave battery **B** (or earth point on the other vehicle).
- ☞ Connect the other end of the green or black cable to the earth point **C** on the broken down vehicle (or on the engine mounting).
- ☞ Start the engine of the vehicle with the good battery and leave it running for a few minutes.

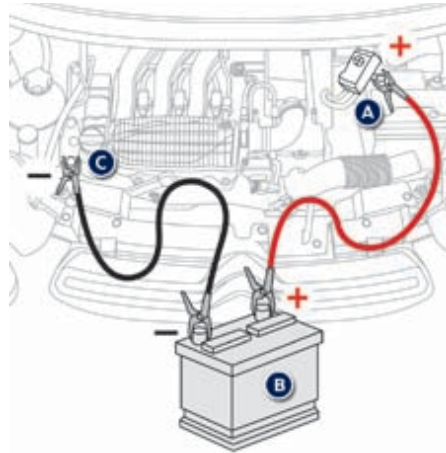

- ☞ Operate the starter on the broken down vehicle and let the engine run. If the engine does not start straight away, switch off the ignition and wait a few moments before trying again.
- ☞ Wait until the engine returns to idle then disconnect the jump lead cables in the reverse order.

Before disconnecting the battery

Wait 2 minutes after switching off the ignition before disconnecting the battery. Close the windows, the fabric roof and the doors before disconnecting the battery.

Following reconnection of the battery

Following reconnection of the battery, switch on the ignition and wait 1 minute before starting to permit initialisation of the electronic systems. However, if problems remain following this operation, contact a Peugeot dealer or a qualified workshop.

Charging the battery using a battery charger

- ☞ Disconnect the battery from the vehicle.
- ☞ Follow the instructions for use provided by the manufacturer of the charger.
- ☞ Connect the battery starting with the positive terminal (+).
- ☞ Check that the terminals and connectors are clean. If they are covered with sulphate (whitish or greenish deposit), remove them and clean them.

i Some functions are not available if the battery is not sufficiently charged.

i It is advisable to disconnect the battery if the vehicle is to be left unused for more than one month.



! The batteries contain harmful substances such as sulphuric acid and lead. They must be disposed of in accordance with regulations and must not, in any circumstances, be discarded with household waste. Take used remote control batteries and vehicle batteries to a special collection point.



Protect your eyes and face before handling the battery. All operations on the battery must be carried out in a well ventilated area and away from naked flames and sources of sparks, so as to avoid the risk of explosion or fire. Do not try to charge a frozen battery; the battery must first be thawed out to avoid the risk of explosion. If the battery has been frozen, before charging have it checked by a Peugeot dealer or a qualified workshop who will check that the internal components have not been damaged and the casing is not cracked, which could cause a leak of toxic and corrosive acid. Do not reverse the polarity and use only a 12 V charger. Do not disconnect the terminals while the engine is running. Do not charge the batteries without disconnecting the terminals first. Wash your hands afterwards.

electrical energy economy mode*

System which manages the duration of use of certain functions to conserve a sufficient level of charge in the battery.

After the engine has stopped, you can still use functions such as the audio system, windscreen wipers, dipped beam headlamps, courtesy lamps, etc. for a maximum combined duration of twenty minutes.

This period may be greatly reduced if the battery is not fully charged.

Switching to economy mode

Once this time has elapsed the active functions are put on standby.

Exiting economy mode

These functions are reactivated automatically next time the vehicle is driven.

To restore the use of these functions immediately, start the engine and let it run for at least 5 minutes.

! Let the engine run for the duration specified to ensure that the battery charge is sufficient.
Do not repeatedly and continuously restart the engine in order to charge the battery.
A flat battery prevents the engine from starting.
Refer to the "Battery" section.

* Only on vehicles with the "Keyless entry and Starting" system.

Changing a wiper blade

Removing the front wiper blade

- ☞ Raise the wiper arm.
- ☞ Remove the wiper blade, sliding it towards the outside.

Fitting the front wiper blade

- ☞ Put the corresponding new wiper blade in place and fix it.
- ☞ Fold down the wiper arm carefully.

i To conserve the effectiveness of the flat-blade type wiper blades, we recommend that they are:

- handled with care,
- cleaned regularly with soapy water,
- not used to hold a cardboard sheet against the windscreen,
- replaced at the first signs of wear.

Towing the vehicle

! Your vehicle can only be towed at the front.



- ☞ Take the removable towing eye stowed in the tool box, under the boot carpet.
- ☞ Unclip the plastic cover, by pressing at the bottom.
- ☞ Fully screw in the towing eye.

- ☞ Install the towing bar.
- ☞ Put the gear lever into neutral (position **N** for the etg electronic gearbox). Failure to observe this instruction may lead to damage to certain components (braking, transmission, ...) and the absence of braking assistance when the engine is started.
- ☞ Unlock the steering and release the parking brake.
- ☞ Switch on the hazard warning lamps on both vehicles.

! Never use the radiator crossmember.

! General recommendations

Observe the legislation in force in your country, ensure that the weight of the towing vehicle is higher than that of the towed vehicle.

The driver must remain at the wheel of the towed vehicle and must have a valid driving licence.

When towing a vehicle with all four wheels on the ground, always use an approved towing arm; rope and straps are prohibited.

The towing vehicle must move off gently.

When towing a vehicle with the engine off, there is no longer any power assistance for braking or steering.

In the following cases, you must always call on a professional recovery service:

- vehicle broken down on a motorway or fast road,
- four-wheel drive vehicle,
- when it is not possible to put the gearbox into neutral, unlock the steering, or release the parking brake,
- towing with only two wheels on the ground,
- where there is no approved towing arm available...

Fitting roof bars

When fitting transverse roof bars, use the accessories recommended by Peugeot and follow the manufacturer's fitting instructions. For more information, contact a Peugeot dealer or a qualified workshop.

Maximum weight authorised on the bars, for a loading height not exceeding 40 cm (except bicycle carrier): 40 kg.
If the height exceeds 40 cm, adapt the speed of the vehicle to the profile of the road to avoid damaging the roof bars.

i Please refer to national legislation in order to comply with the regulations concerning the transportation of objects which are longer than the vehicle.

Accessories

A wide range of accessories and genuine parts is available from the Peugeot Ot dealer network. All these accessories and parts are all suitable for your vehicle and benefit from Peugeot Ot 's recommendation and warranty.

"Comfort": air deflectors, insulated module, sun blinds, scented air freshener, portable ashtray, coat hanger fitted to head restraint, reading lamp, front and rear parking sensors, centre armrest, cigarette lighter...

"Style": ligne S body kit, ligne S personalised mats, aluminium gear lever knob, alloy wheels, exterior personalisation stickers, chrome side mouldings, chrome mirror shells, chrome door handles, door sill finishers, personalised remote control shells, ...

"Protection": mats, mud flaps, vehicle cover, seat covers, bumper protectors, ...
to prevent the mat from becoming caught under the pedals:

- ensure that the mat is secured correctly,
- never fit one mat on top of another.

"Transport solutions": boot carpet, boot liner, boot net, transverse roof bars, bicycle carrier, ski carrier, roof boxes, boot dividers, ...

"Security and safety": anti-theft alarm, vehicle tracking system, snow chains, wheel non-slip covers, wheel security bolts, child seats, first aid kit, warning triangle, high visibility vest, breathalyzer, fire extinguisher, pet seat belt, foglamp kit, seat belt cutter/glass hammer, ...

"Multimedia": CD player, audio system, speaker, semi-integral navigation systems, hands-free kit, driving assistance systems, 230 V socket, rear multi-media support, DVD players, portable satellite navigation system, telephone/smartphone support, digital radio, ...

i **Installation of radio communication transmitters**

Before installing any after-market radio communication transmitter, you can contact a Peugeot dealer for the specification of transmitters which can be fitted (frequency, maximum power, aerial position, specific installation requirements), in line with the Vehicle electromagnetic Compatibility Directive (2004/104/EC).

i Depending on the legislation in force in the country, certain safety equipment may be compulsory: high visibility safety vests, warning triangles, breathalyzers, spare bulbs, spare fuses, fire extinguisher, first aid kit, mud flaps at the rear of the vehicle.

! The fitting of electrical equipment or accessories which are not recommended by Peugeot may result in a failure of your vehicle's electronic system and excessive electrical consumption. Contact a Peugeot dealer for information on the range of recommended equipment and accessories.



- ▶ 208 Hybrid FE, a technology demonstrator with exceptional characteristics: 1.9 l/100 km (148.7 mpg) and 0 to 100 km/h (0 to 62 mph) in 8 seconds.

Peugeot & Total AL, A PARTNERSHIP TO DELIVER BETTER PERFORMANCE!

Innovation, the key to success

Peugeot AL Research and Development and Peugeot teams work together to develop high quality lubricants that meet the requirements of Peugeot vehicles. For you, this is the assurance that the performance of your engine is optimised while also ensuring its durability. The 208 Hybrid FE demonstrates the ability of Peugeot and Total AL to develop innovative technologies and provide other ways of moving towards the future.

Reduced exhaust emissions, a true reality

Total AL lubricants are formulated to optimise the efficiency of engines and the protection of the emissions post-treatment systems. It is important to observe the servicing recommendations made by Peugeot to assure correct operation.

PEUGEOT RECOMMENDS TOTAL



10

Bonnet

Protects the components of the engine and provides access for checking levels.

Opening



- ☞ Pull towards you the interior release lever, located in the lower dashboard.



- ☞ Push the exterior safety catch to the left and raise the bonnet.

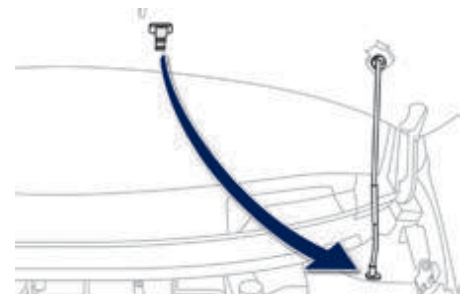

- ☞ Unclip the bonnet stay from its housing.
- ☞ Fix the stay in the notch to hold the bonnet open.

! The cooling fan may start after switching off the engine: take care with articles and clothing that might be caught by the fan blades.

! Do not open the bonnet when there is a very strong wind. When the engine is hot, handle the exterior safety catch and the stay with care (risk of burns).

! Because of the presence of electrical equipment under the bonnet, it is recommended that exposure to water (rain, washing, ...) be limited.

Closing

- ☞ Take the stay out of the support notch.
- ☞ Clip the stay in its housing.
- ☞ Lower the bonnet and release it near the end of its travel.
- ☞ Pull on the bonnet to check that it is fully latched.

Petrol engines

1. Screenwash fluid reservoir.
2. Coolant header tank.
3. Air filter.
4. Brake fluid reservoir.
5. Battery.
6. Fusebox.
7. engine oil dipstick.
8. engine oil filler cap.

i For access to the brake fluid reservoir and the fusebox, unclip the plastic cover at the base of the windscreen, pressing on the two tongues. Refer to the "Changing a fuse" section.

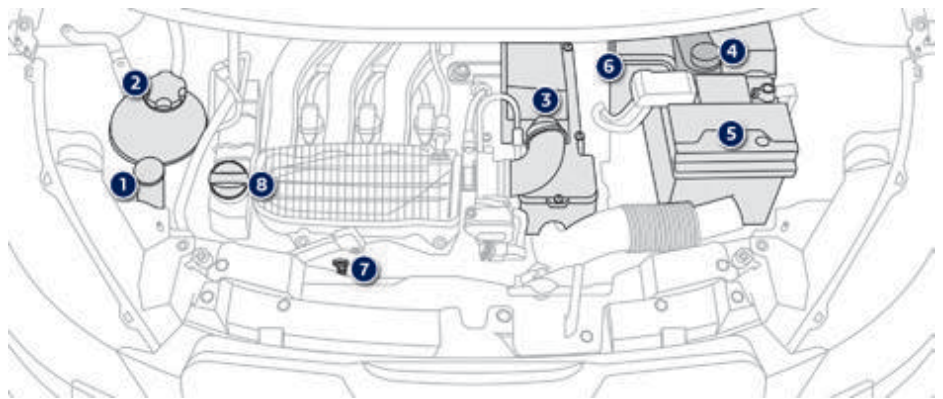

VTi 82

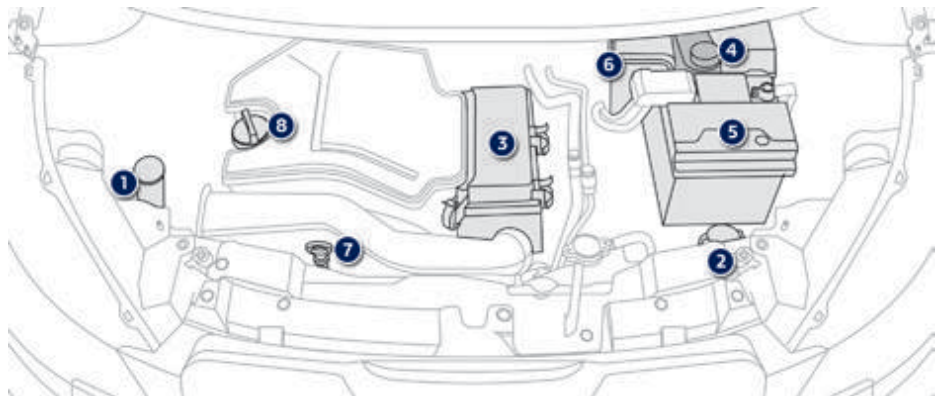

VTi 68

Checking levels

Check all of these levels regularly, in line with the warranty and maintenance record. Top them up if necessary, unless otherwise indicated. If a level drops significantly, have the corresponding system checked by a Peugeot dealer or a qualified workshop.

! Take care when working under the bonnet, as certain areas of the engine may be extremely hot (risk of burns) and the cooling fan could start at any time (even with the ignition off).

Oil level



The check of the oil level is carried out with the dipstick, located under the bonnet. For the position of the dipstick, refer to the under-bonnet view on a previous page.

i To ensure the accuracy of the reading, your vehicle must be on a level surface, with the engine off for at least 30 minutes.

It is normal to top up the oil level between two services (or oil changes). Peugeot recommends that you check the level, and top up if necessary, every 3 000 miles (5 000 km).

Checking with dipstick

Refer to the under-bonnet view for the location of the dipstick on your vehicle.

- ☞ Take the dipstick by its coloured grip and pull it out completely.
- ☞ With the end of the dipstick with a clean and non-fluffy cloth.
- ☞ Refit the dipstick and push it fully down, then pull it out again for a visual check of the oil level: the level must be between the two marks **A** and **B**.

If you find that the oil level is above the **A** mark or below the **B** mark, **do not start the engine.**

- If the level is above the **MAX** mark (risk of engine damage), contact a Peugeot dealer or a qualified workshop.
- If the level is below the **MIN** mark, you must top-up the engine oil.



Topping-up the engine oil

Oil grade

The oil must be the correct grade for your engine and conform to the manufacturer's recommendations.

Refer to the under-bonnet view for the location of the oil filler cap on your vehicle.

- ☞ Unscrew the filler cap for access to the filler orifice.
- ☞ Pour in the oil in small quantities, avoiding spills onto the engine (risk of fire).
- ☞ Wait a few minutes before checking the level again using the dipstick.
- ☞ Top-up again if necessary.
- ☞ After checking and topping up, carefully refit the oil filler cap and the dipstick to its housing.

Engine oil change

Refer to the warranty and maintenance record for details of the interval for this operation.

In order to maintain the reliability of the engine and emissions control system, never use additives in the engine oil.

Brake fluid level



The brake fluid level should be close to the "MAX" mark. If it is not, check the brake pad wear.

Changing the fluid

Refer to the warranty and maintenance record for details of the interval for this operation.

Fluid specification

The brake fluid must conform to the manufacturer's recommendations.

Coolant level



The coolant level must be:

- between the "**FULL**" or "**F**" and "**LOW**" or "**L**" marks for Vt i 68 and e-Vt i 68 engines,
- between the "**MIN**" and "**MAX**" marks for the Vt i 82 engine.

When the engine is warm, the temperature of the coolant is regulated by the fan.

The cooling fan may start after switching off the engine: take care with articles and clothing that might be caught by the fan blades.

In addition, as the cooling system is pressurised, wait at least one hour after switching off the engine before carrying out any work.

To avoid any risk of scalding, unscrew the cap by two turns to allow the pressure to drop. When the pressure has dropped, remove the cap and top up the level.

Fluid specification

The coolant must conform to the manufacturer's recommendations.

Screenwash fluid level



Top up the level when necessary.

Fluid specification

For optimum cleaning and to avoid freezing, this fluid must not be topped up or replaced with plain water.

In wintry conditions, it is recommended that you use an ethyl alcohol or methanol based fluid.

Used products



Avoid prolonged contact of used oil or fluids with the skin. Most of these fluids are harmful to health or indeed very corrosive.



Do not discard used oil or fluids into sewers or onto the ground. Take used oil to a Peugeot dealer or a qualified workshop (France) or to an authorised waste disposal site.

Checks

Unless otherwise indicated, check these components in accordance with the warranty and maintenance record and according to your engine. Otherwise, have them checked by a Peugeot dealer or a qualified workshop.

12 V battery



The battery does not require any maintenance. However, check that the terminals are clean and correctly tightened, particularly in summer and winter.

When carrying out work on the battery, refer to the "12 V battery" section for details of the precautions to be taken before disconnecting the battery and following its reconnection.

Air filter and passenger compartment filter



Refer to the warranty and maintenance record for details of the replacement intervals for these components.

Depending on the environment (e.g. dusty atmosphere) and the use of the vehicle (e.g. city driving), **replace them twice as often if necessary.**

A clogged passenger compartment filter may have an adverse effect on the performance of the air conditioning system and generate undesirable odours.

Oil filter



Replace the oil filter each time the engine oil is changed. Refer to the warranty and maintenance record for details of the replacement interval for this component.

Manual gearbox



The gearbox does not require any maintenance (no oil change). Refer to the warranty and maintenance record for the checking interval for this component.

Clutch

The clutch is operated mechanically and requires regular adjustment. Refer to the warranty and maintenance record for information on when the adjustment should be checked.

i In the event of an operating fault (difficulty moving off, for example), contact a Peugeot dealer or a qualified workshop.

ETG electronic gearbox



The etg gearbox does not require any maintenance (no oil change). Refer to the warranty and maintenance record for information on when this unit should be checked.

Brake pads



Brake wear depends on the style of driving, particularly in the case of vehicles used in town, over short distances. It may be necessary to have the condition of the brakes checked, even between vehicle services. Unless there is a leak in the circuit, a drop in the brake fluid level indicates that the brake pads are worn.

Brake disc wear



For information on checking brake disc wear, contact a Peugeot dealer or a qualified workshop.

Parking brake



If excessive travel or a loss of effectiveness of this system is noticed, the parking brake must be checked, even between two services.

Checking this system must be done by a Peugeot dealer or a qualified workshop.

! Only use products recommended by Peugeot or products of equivalent quality and specification. In order to optimise the operation of units as important as those in the braking system, Peugeot selects and offers very specific products. After washing the vehicle, dampness, or in wintry conditions, ice can form on the brake discs and pads: braking efficiency may be reduced. Make light brake applications to dry and defrost the brakes.

engines

Petrol engine	VTi 68		e-VTi 68	VTi 82
	Manual gearbox (5-speed)	ETG electronic gearbox (5-speed)	Manual gearbox (5-speed)	Manual gearbox (5-speed)
Model codes PM, PN	PSCFBB-B1A000 PSCFBB-H1A000 PSCFBB-P1A000 PSCFBB-W1A000	PSCFBB-B1C000 PSCFBB-H1C000 PSCFBB-P1C000 PSCFBB-W1C000	PSCFB2-B1B000 PSCFB2-H1B000 PSCFB2-P1B000 PSCFB2-W1B000	PAHMTB-B1A000 PAHMTB-H1A000 PAHMTB-P1A000 PAHMTB-W1A000
Cubic capacity (cc)	998	998	998	1 199
Bore x stroke (mm)	71 x 84	71 x 84	71 x 84	77 x 85.8
e u standard maximum power (kW)*	50	50	50	60
Max power engine speed (rpm)	6 000	6 000	6 000	5 750
e u standard max torque (Nm)	95.5	95.5	95.5	116
Max torque engine speed (rpm)	4 800	4 800	4 800	2 750
Fuel	u nleaded petrol		u nleaded petrol	u nleaded petrol
Catalytic converter	Yes		Yes	Yes
engine oil capacity (with filter replacement)	3.2	3.2	3.2	3.25

* t he maximum power corresponds to the value type-approved on a test bed, under conditions defined in european legislation (Directive 1999/99/eC).

technical data

Weights (in kg)

Engine	VTi 68		e-VTi 68	VTi 82
	Manual gearbox (5-speed)	ETG electronic gearbox (5-speed)	Manual gearbox (5-speed)	Manual gearbox (5-speed)
Model codes	PSCFBB-B1A000 PSCFBB-H1A000 PSCFBB-P1A000 PSCFBB-W1A000	PSCFBB-B1C000 PSCFBB-H1C000 PSCFBB-P1C000 PSCFBB-W1C000	PSCFB2-B1B000 PSCFB2-H1B000 PSCFB2-P1B000 PSCFB2-W1B000	PAHMTB-B1A000 PAHMTB-H1A000 PAHMTB-P1A000 PAHMTB-W1A000
Kerb weight	840	860	860	865
g ross vehicle weight (g VW)	1 240	1 240	1 240	1 240
g ross train weight (g t W)	1 240	1 240	1 240	1 240

i The design of your vehicle does not permit the fitting of a towbar.

Dimensions (in mm)

† these dimensions have been measured on a vehicle that is not loaded.

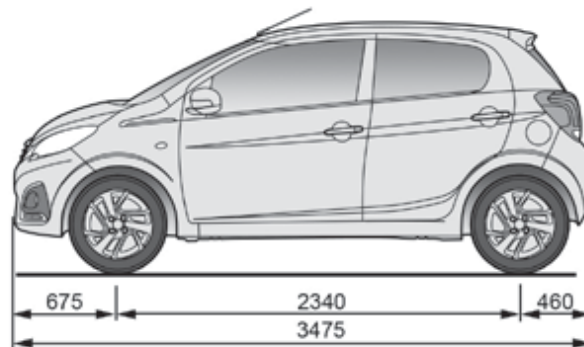
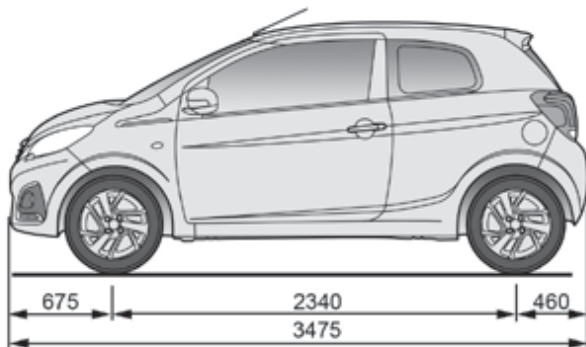
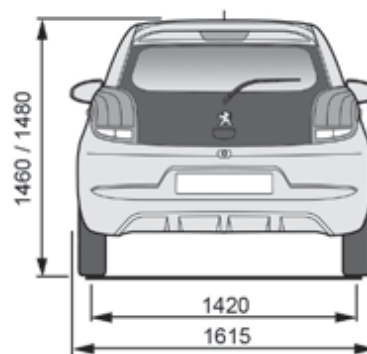
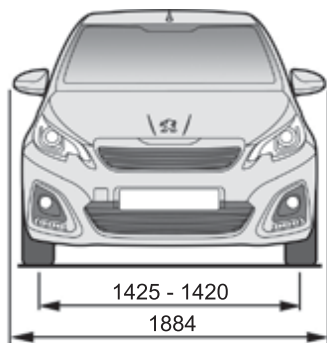

Identification markings

A. Vehicle Identification Number (VIN) on the body.

This number is engraved on the middle door pillar, or the rear door pillar, right hand side.

B. Vehicle Identification Number (VIN) in the passenger compartment.

This is engraved on the crossmember, under the front right seat.

C. Tyre label.

This label on the middle door pillar, driver's side, carries the following information:

- the tyre sizes,
- the tyre pressures.



3-door

5-door

i The tyre pressures must be checked when cold, at least once a month.

☘ Low tyre pressures increase fuel consumption.



7-Inch touch screen

Multimedia system
Bluetooth® telephone
Mirror Screen®



For safety reasons, the driver must carry out operations which require prolonged attention while the vehicle is stationary.

To prevent discharging of the battery, the system cuts off following activation of energy economy mode, 20 minutes after switching off the engine on vehicles fitted with the "Keyless entry and Starting" system.

CONTENTS

01	General operation	p.	182
02	First steps - Control panel	p.	184
03	Steering mounted controls	p.	185
04	Media	p.	186
05	Telephone	p.	198
06	Connections	p.	206
	06-1 iPhone® connection	p.	206
	06-2 MirrorLink® connection	p.	210
07	Configuration	p.	214
	Frequently asked questions	p.	218

01 GENERAL OPERATION

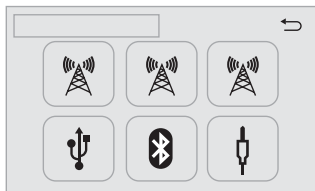

"Audio source"
select the music source and view photos and videos.



"Telephone"
connect a telephone by Bluetooth.

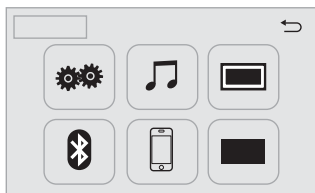

"Configuration"
settings for sounds, brightness and activation or deactivation of functions according to use.

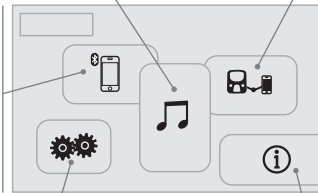

"Mirror Screen®"**
run certain applications on your smartphone.

"Vehicle information"
access to the trip computer.

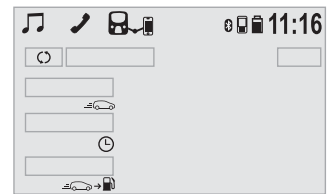
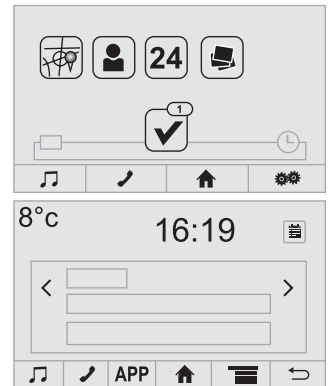

* Depending on equipment.

01 GENERAL OPERATION

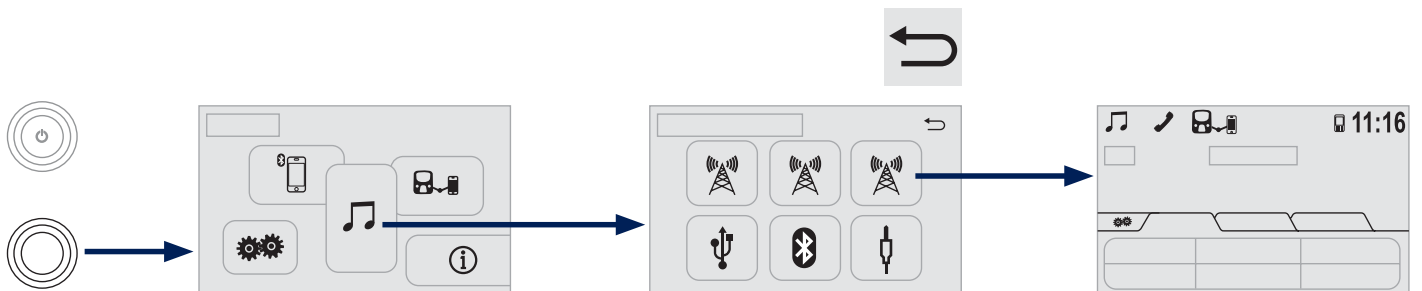

In ACC mode or when starting the vehicle, the system comes on. Use the button at bottom right of the screen for access to the main menus. A second press returns the system to the last source activated, then press the virtual buttons in the screen.

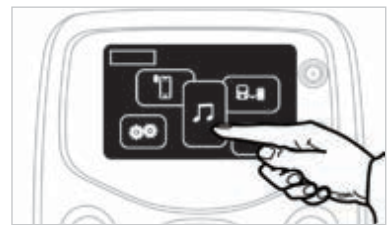

i In the event of prolonged exposure to sunlight and very hot conditions, the system may go into stand-by (screen and sound completely off) for at least 5 minutes. Return to normal operation takes place when the temperature in the passenger compartment drops.

02 FIRST STEPS

Short-cuts: using virtual buttons in the top bar of the screen, it is possible to go directly to the choice of audio source, telephone functions or "Mirror Screen®" mode.

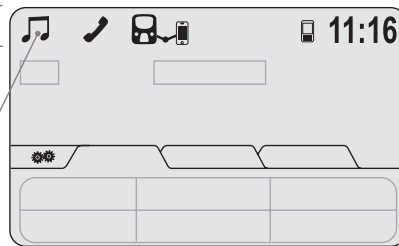

Volume (each source is independent).

Press to mute the sound.
A long press reinitialises the system.

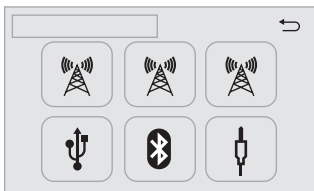

Select audio source (depending on version):

- "FM" / "AM" / "DAB"* radio.
- "uSB" player.
- telephone connected by Bluetooth and with Bluetooth streaming.
- Media player connected to the auxiliary socket (jack, cable not supplied).

i Pressing with more than one finger is not recognised.
The screen can be used when wearing gloves.

! To clean the screen, use a soft non-abrasive cloth (spectacles cloth) without any additional product or a damp cloth.
Do not use pointed objects on the screen.
Do not touch the screen with wet hands.

* Depending on equipment.

03 STEERING MOUNTED CONTROLS

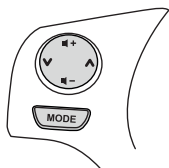
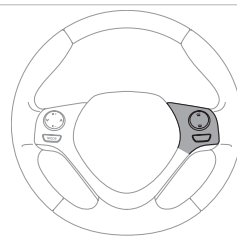

MODE

Short press: change multimedia source.
Long press: mute / restore sound from the radio or pause media sources.



Increase volume.



Decrease volume.



Radio: change to preset radio stations in ascending order.
Media: next track.



Radio: change to preset radio stations in descending order.
Media: previous track.

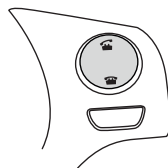







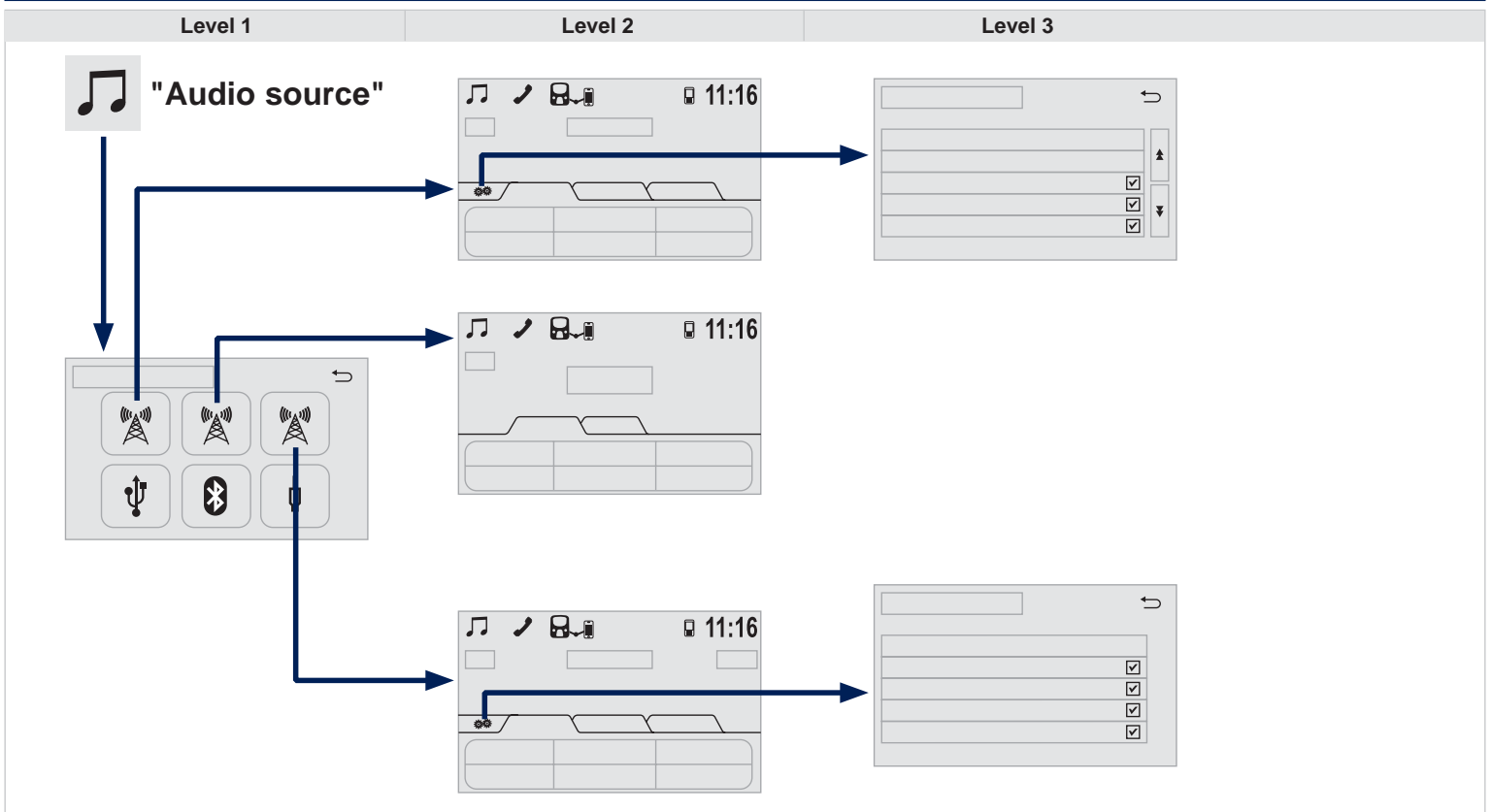

Accept an incoming call.
Other than on a call: press to open the list of contacts; a second press opens the calls history.



Reject the incoming call.
end the call in progress.
Other than on a call: press to return to the radio screen or the clock if the radio is not active.









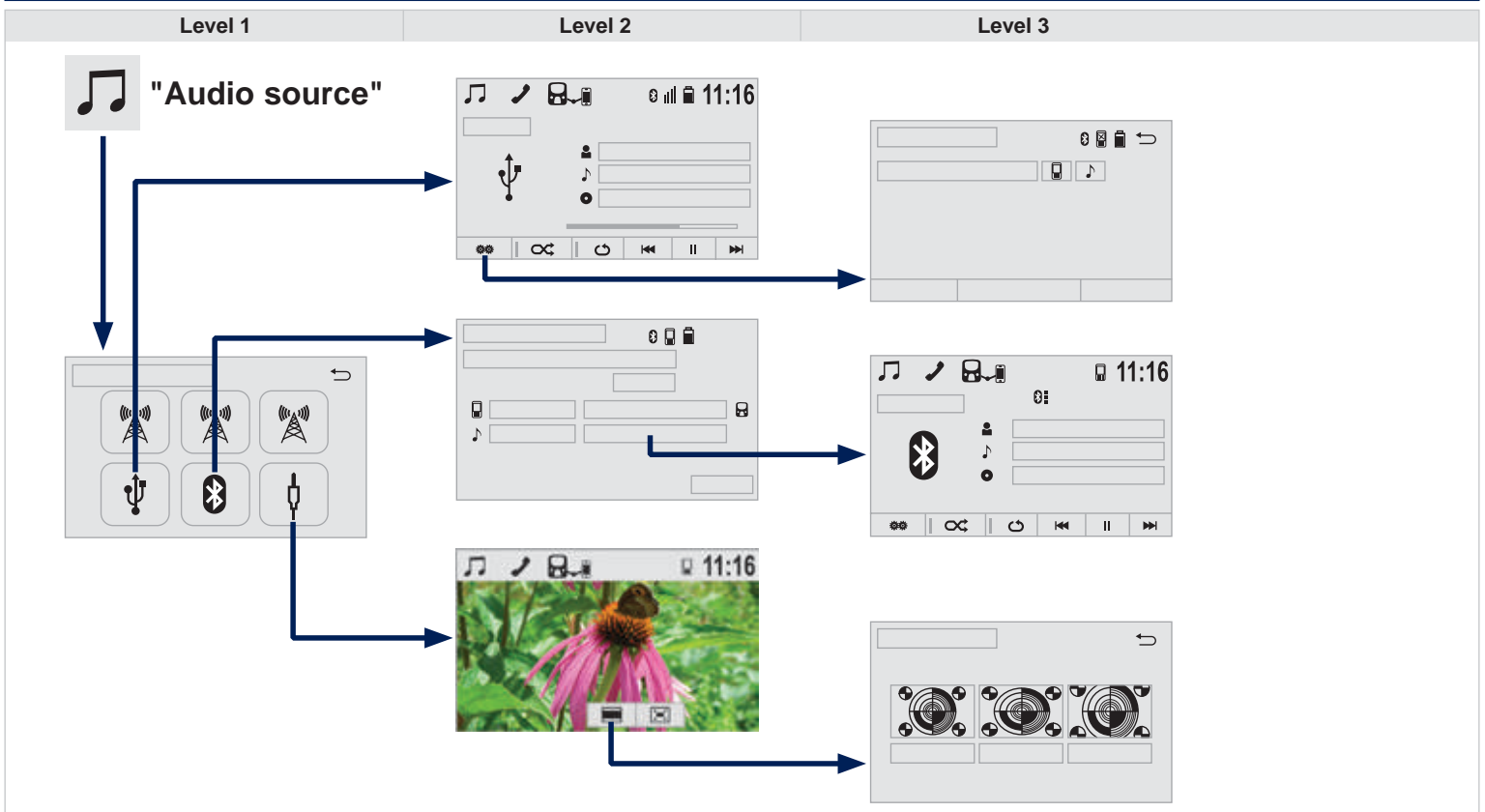













04 MEDIA



Level 1		Level 2		Level 3		Comment	
 	Audio source ↓ FM →		FM radio configuration		u pdate the list of stations	u pdate the list to take account of reception.	
					List of stations	Choose to list by "Broadcaster" or "Alphabetic".	
				<input checked="" type="checkbox"/>	FM traffic announcements	Activate or deactivate options.	
				<input checked="" type="checkbox"/>	FM alternative frequencies		
				<input checked="" type="checkbox"/>	Change regional code		
<input checked="" type="checkbox"/>	FM radiotext						
	Presets		List of preset stations.				
	Stations		List of radio stations received.				
	Manual		Search for stations step by step or automatically.				
 	Audio source ↓ AM →		Presets		List of preset stations.		
			Manual		Search for stations step by step or automatically.		
 	Audio source ↓ DAB →		DAB radio configuration		u pdate the list of stations	u pdate the list to take account of reception.	
				<input checked="" type="checkbox"/>	L-Band	Activate or deactivate options.	
				<input checked="" type="checkbox"/>	DAB traffic announcements		
				<input checked="" type="checkbox"/>	DAB alternative frequencies		
				<input checked="" type="checkbox"/>	DAB radiotext		
					Presets		List of preset stations.
					Stations		List of radio stations received.
	Manual		Search for stations step by step or automatically.				

04 MEDIA



Level 1		Level 2		Level 3		Comment		
 	Audio source ↓ USB →		 Scan			Choose the play setting.		
			Random play					
			Repeat play					
			Previous track					
			Play					
			Next track					
 	Audio source ↓ Bluetooth audio →		Telephone			First connection, refer to the telephone section.		
			Audio play		System configuration			Activate or deactivate options.
					Random play			Choose the play setting.
					Repeat play			
					Previous track			
					Play			
					Next track			
 	Audio source ↓ A / V →		Screen format	Normal		Choose the most suitable screen format.		
				Stretched				
				Zoom				
			Full screen			Display in full screen mode.		

04 RADIO

Selecting a station

1

Press on "**Audio source**" to display the carousel of sound sources.



2

Select "**FM**".



3

Select the "**Station**" tab then select a radio station from the stations received.



Select "**FM radio configuration**" then "**Update the list of stations**" to refresh the list.



1

If necessary, select change of source by pressing on the "**Audio source**" shortcut in the upper bar of the carousel.



2

Select "**AM**" or "**DAB**".





!

the exterior environment (hills, buildings, tunnel, car park, below ground...) may prevent reception, even in RDS alternative frequencies mode. This phenomenon is normal in the propagation of radio waves and is in no way indicative of a fault with the audio system.

* Depending on equipment.

04 RADIO

Changing a radio frequency

- 1 Press on "**Audio source**" to display the carousel of sound sources. 
- 2 Select "**FM**". 
- 3 Select the "**Manual**" tab to search for a station. 



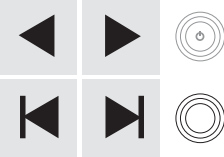

 Press the step by step buttons, the automatic buttons or turn the button at bottom right of the screen to search for frequencies up or down.



Preset a station

- 1 Select a radio station or frequency (refer to the "Changing a frequency" section).
- 2 Select the "**Presets**" tab then make long press on one of the numbered preset locations. 

Activate/ Deactivate RDS

- 1 Press on "**Audio source**" to display the carousel of audio sources. 
- 2 Select "**FM**". 
- 3 Select "**FM radio configuration**". 
- 4 Activate/deactivate "**Change of regional code**". 

i RDS, if activated, allows you to continue listening to the same station by automatic retuning to alternative frequencies. However, in certain conditions, coverage of an RDS station may not be assured throughout the entire country as radio stations do not cover 100 % of the territory. This explains the loss of reception of the station during a journey.

04 RADIO

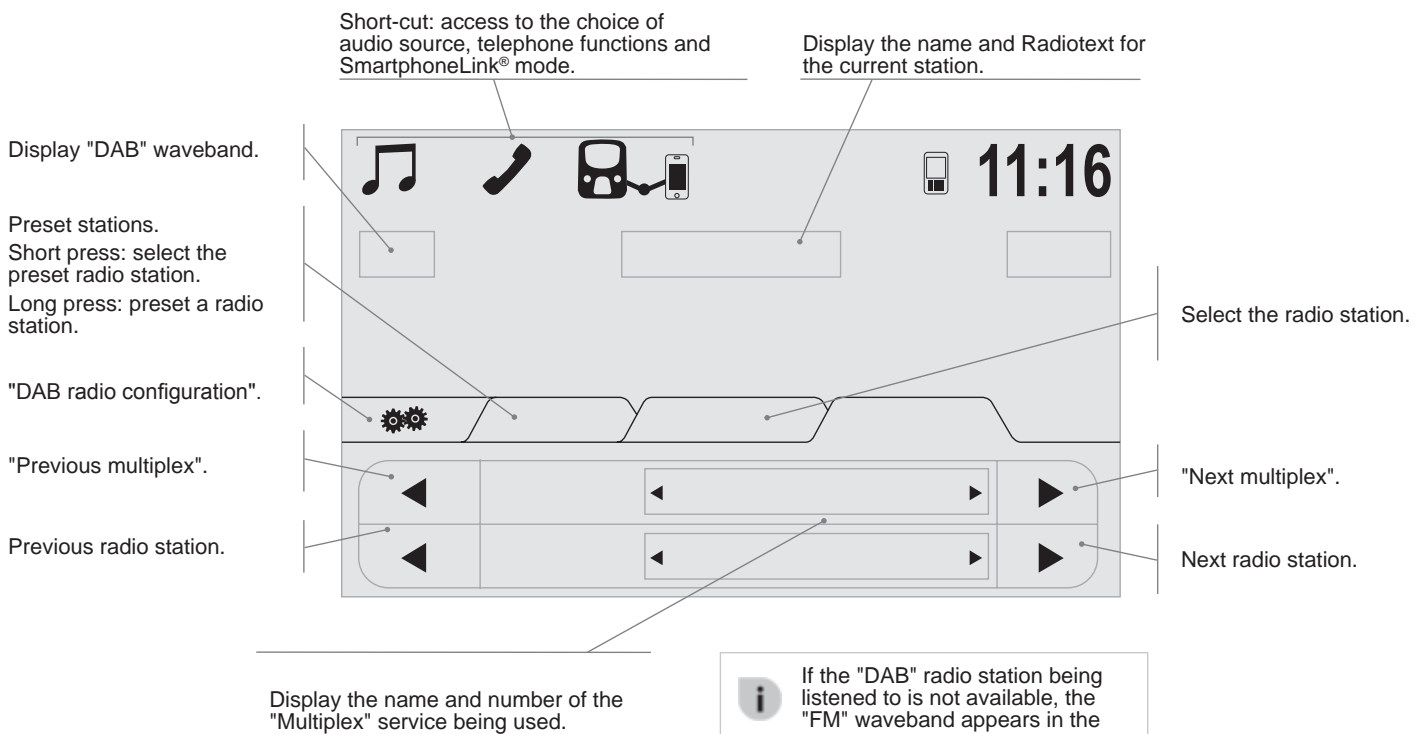



04 RADIO

DAB (Digital Audio Broadcasting) Digital radio

- !** Digital radio provides higher quality reception and also the display of additional information (album artwork...) on the radio station being listened to. Select "DAB" in the carousel of audio sources. The range of multiplexes available is displayed in alphabetical order.

1 Press on "**Audio source**" to display the carousel of sound sources. 

2 Select "**DAB**". 

3 Select "**DAB radio configuration**" then activate "**L-band**".  

4 Select the "**Station**" tab then select a station from those received. 

5 Select the "**Manual**" tab to search for a station. 

Digital radio - DAB station tracking

- i** "DAB" does not cover 100% of the territory. When the digital signal is weak, the "**Alternative DAB frequency**" option makes it possible to continue listening to the same station, by automatically switching to the corresponding "FM" station (if there is one).

1 Press "**Audio source**" to display the carousel of audio sources. 

2 Select "**DAB**". 

3 Select "**DAB radio configuration**" then activate "**Alternative DAB frequency**".  

- i** If "**Alternative DAB frequency**" tracking is activated, there is a difference of a few seconds when the system switches to the "FM" analogue radio station with sometimes a variation in volume. When the digital signal is restored, the system automatically changes back to "DAB".

- !** If the "DAB" station being listened to is not available, or if "**L-band**" is not activated, the sound will cut out while the digital signal is too weak.

04 MUSIC

USB player

- 1a** Insert the uSB memory stick in the uSB player or connect the uSB peripheral device to the uSB port using a suitable cable (not supplied).

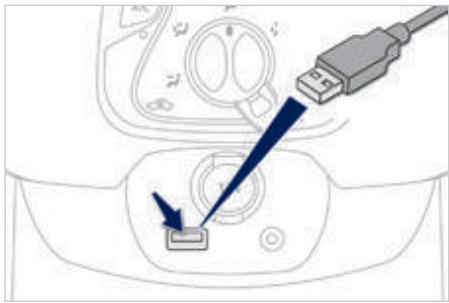

- !** t he system builds playlists (in temporary memory), an operation which can take from a few seconds to several minutes at the first connection.
Reduce the number of non-music files and the number of folders to reduce the waiting time.
t he playlists are updated every time the ignition is switched off or connection of a uSB memory stick. However, the audio system memorises these lists and if they are not modified, the loading time will be shorter.

Using the auxiliary input (A/V) (audio cable not supplied)

- 1b** Connect the portable device (MP3 player...) to the auxiliary JACK socket using an audio cable.

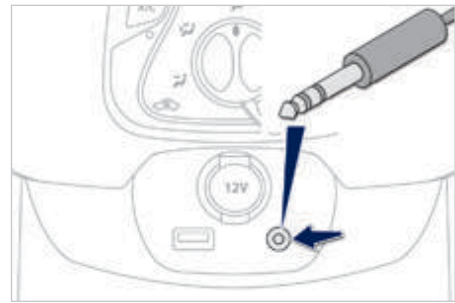

04 MUSIC

Selection of source

2

Press on "**Audio source**" to display the carousel of audio sources.



3a

Select the "**USB**" auxiliary source.



OR

3b

Select the "**A/V**" auxiliary source.



4

use the play settings at the bottom of the screen.



Pressing the "**MODE**" button at the steering mounted controls changes to the next media, available if the source is active.

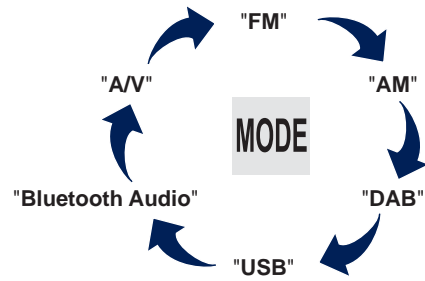

04 MUSIC

MP3 / USB player

Information and advice



The audio system plays files with the extension:
".wma", type Ver7 and Ver8 with bit rate between 48 and 192 Kbps
and type Ver9 with bit rate between 48 and 320 Kbps.
".aac", with bit rate between 16 and 320 Kbps.
".mp3 - MPeg 1" with bit rate between 32 and 320 Kbps and ".mp3 -
MPeg 2" with bit rate between 8 and 160 Kbps.
The sampling rates supported are 11, 22, 44 and 48 KHz.



In order to be read, a uSB memory stick must be formatted FAT 16
or 32.



It is advisable to restrict file names to 20 characters, without using of
special characters (e.g.: " " ? ; ù) to avoid any playing and displaying
problems.



The system supports uSB mass storage devices or Apple® players
via uSB ports. The adaptor cable not supplied.
Control of the peripheral device is with the audio system controls.
Other peripherals, not recognised on connection, must be connected
to the auxiliary socket using a Jack cable (not supplied).



The system can alternatively read files via the Bluetooth® system
and the uSB port.



It is recommended that official Apple® uSB cables are used to
ensure correct operation.

04 MUSIC

Audio streaming



Streaming allows audio files on your telephone to be played via the vehicle's speakers.

1

Connect the telephone : see the "**Telephone**" section, then **Bluetooth**.
Choose either "**Connect all**" or "**Connect as audio player**" profile.

2

If play does not start automatically, it may be necessary to start audio play from the telephone.
Control is from the peripheral device or by using the audio system controls.

!

Once connected for streaming, the telephone is considered as a media source.
It is recommended that "**Repeat**" mode be activated in the Bluetooth device.

Connecting Apple® players

1

Connect the Apple® player to the uSB port using a suitable cable (not supplied).
Play starts automatically.



2

Control is via the audio system.

i

The classifications available are those of the portable device connected (artists / albums / genres / tracks / playlists / audio books / podcasts).









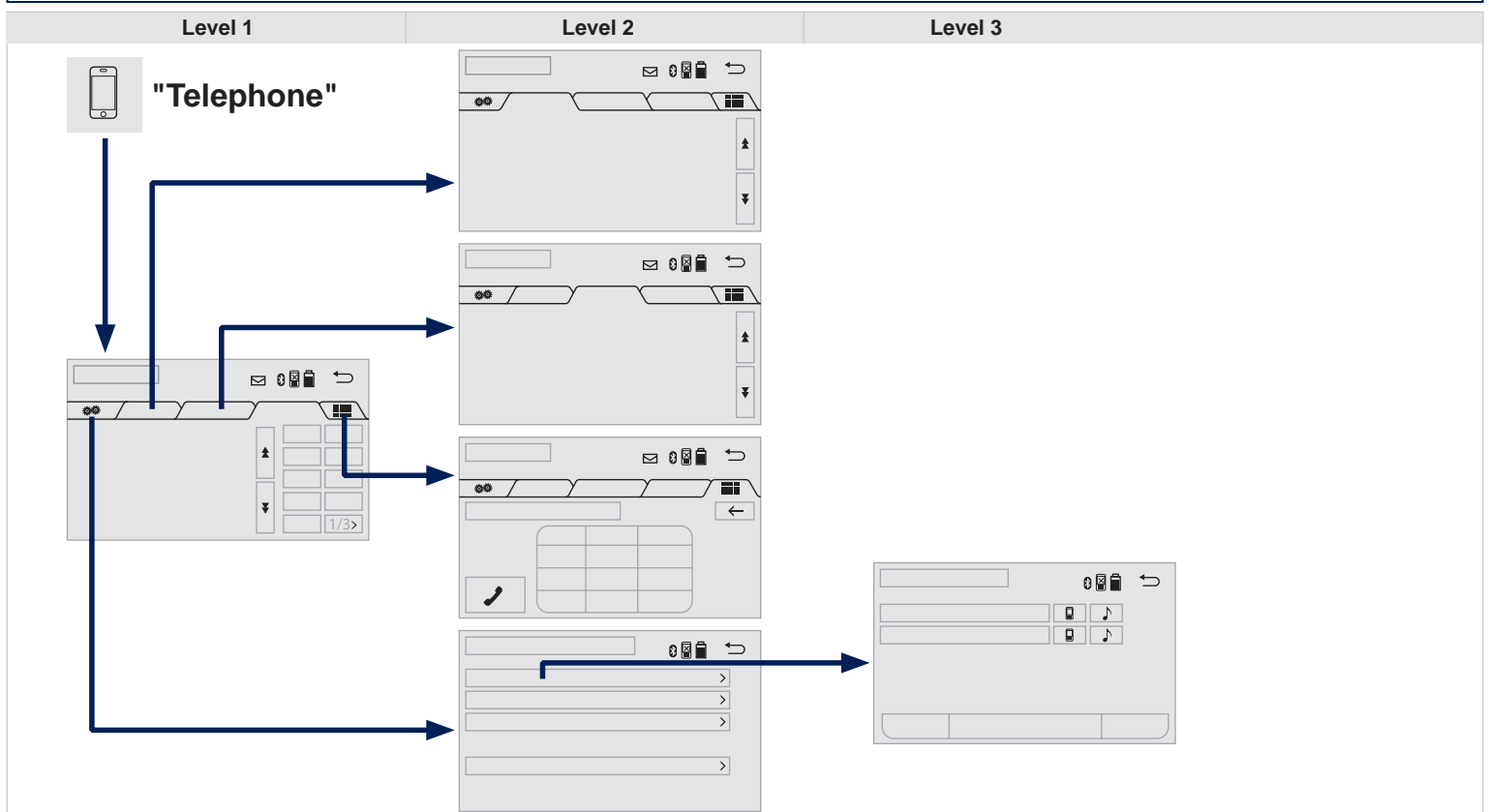

















The default classification used is by artist. To modify the classification used, return to the first level of the menu then select the desired classification (playlists for example) and confirm to go down through the menu to the desired track.

!

The version of software in the audio system may not be compatible with the generation of your Apple® player.

05 TELEPHONE



	Level 1	Level 2	Level 3	Comment		
	Contacts					
	Favourites			After making choices, start the call.		
	Call history					
	Enter a number	 Call		enter a number then start the call.		
	Telephone/message configuration		Connect the telephone	 t telephone	Select the services to use on the peripheral device	
				 Audio player		
			Sounds configuration	 Ringtone		
				  Ringtone volume		
				 Incoming SMS/MMS tone		
				  Incoming SMS/MMS volume		
				 Incoming e-mail tone		
				  Incoming e-mail volume		
				  Incoming call volume		
			Contacts/call history configuration	<input checked="" type="checkbox"/> Automatic transfer		
				 u pdate telephone contacts		
				 Sort contacts by		
				 Add favourite		
				 Remove favourite		
			Message configuration	 Display of incoming calls		
<input checked="" type="checkbox"/> Contacts/call history transfer state						
	Telephone display configuration	 Display of incoming calls				
		<input checked="" type="checkbox"/> Contacts/call history transfer state				

05 BLUETOOTH

Pairing a Bluetooth telephone First connection

! For reasons of safety and because they require prolonged attention on the part of the driver, the operations for pairing the Bluetooth mobile telephone to the hands-free system of the audio system must be carried out with the **vehicle stationary**.

1 Activate the telephone's Bluetooth function and ensure that it is "visible to all" (telephone configuration).



2 Press on "**Audio source**" to display the carousel of audio sources.



3 Select "**Bluetooth audio**".



4 Select the "**Add**" tab in the system. The list of telephone detected is displayed.



5 Select the name of the desired peripheral from the list.

i If the telephone is not detected, it is recommended that you switch the Bluetooth function on your telephone off and then on again.

6 Select the system on your telephone.



7 Enter a code of at least 4 figures for the connection then confirm.



8 Enter this same code in the telephone then accept the connection.



9 The system displays that the services to be used on the telephone are: "**Telephone**" and "**Audio player**".



10 Select "**Telephone**" then select the name of the telephone. The system offers to connect the telephone:

- with "**Connect all**",
- with "**Connect as telephone**" (hands-free kit, telephone only),
- with "**Connect as audio player**" (streaming: wireless play of audio files on the telephone).

05 BLUETOOTH

Managing paired telephones



The services available depend on the network, the SIM card and the compatibility of the Bluetooth telephone used. Check the telephone manual and with your network provider for details of the services available to you.



The profiles compatible with the system are: HFP, OPP, PBAP, A2DP, AVRCP, MAP.

Automatic reconnection

1

When the ignition is switched on, the last telephone connected when the ignition was switched off reconnects automatically, if this connection made had been activated during the pairing procedure (see previous pages).

2

Connection is confirmed by the display of a message and the name of the telephone.



This function allows the connection or disconnection of a peripheral device as well as the deletion of a pairing.

1

Press "**Telephone**".



2

Select "**Telephone/message configuration**" then select "**Connect telephone**" to display the list of paired devices.



3

Select "**Remove**" then select the device in the list and confirm.

05 BLUETOOTH

Receiving a call

1

An incoming call is announced by a ring and a superimposed display in the screen.

2a

Make a short press on this steering mounted button to accept an incoming call.



2b

Press on this steering mounted button to reject a call or to end a call.



Making a call

Calling a new number

!

u se of the telephone is not recommended while driving. We recommended that you park safely or make use of the steering mounted controls.

1

Press "**Telephone**".



2

Press the keypad tab.



2

enter the phone number using the keypad then press the telephone button to start the call.



05 CONTACTS

Calling a contact

1

Press on **"Telephone"**.



Or press this steering mounted button to open the list of contacts.



2

Select the **"Contacts"** tab.



3

Select the desired contact from the list offered to start the call.

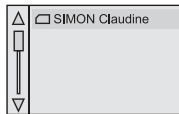

Calling a recently used number

1

Press on **"Telephone"**.



Or press this steering mounted button to open the list of contacts; a second press opens the calls history.



2

Select the **"Calls history"** tab.



3

Select the desired contact from the list offered to start the call.

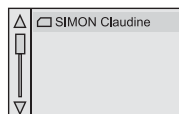

05 CONTACTS

Managing contacts / Entries

1

Press on "**Telephone**" to display the primary page.



2

Select "**Telephone/message configuration**" then "**Contacts config./calls history**".



3

Select:

- "**Automatic transfer**" to automatically transfer the contacts from your smartphone or telephone.
- "**Update telephone contacts**" to update the list of contacts.
- "**Sort contacts by**" to sort by first or second name.
- "**Add favorites**" to add favorites to the list in the system.
- "**Remove favorite**" to remove favorites from the list in the system.



05 SETTINGS

Ringtones

1

Press on "**Telephone**".



2

Select "**Telephone/message configuration**" then select "**Sound configuration**" to display the list of audio sources.



3

You can select the ringtone used and adjust its volume.

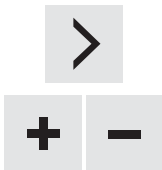

06 CONNECTIONS

06-1 iPhone® smartphone connection Use the USB port and JACK auxiliary socket

i For reasons of safety and because it requires the sustained attention of the driver, using a smartphone while driving is prohibited. The operations must be carried out **with the vehicle stationary**.

! Synchronisation of the system with the smartphone allows the driver to check their smartphone in the screen. The principles and standards are constantly changing with new models of smartphone. For more information, contact a Peugeot dealer.

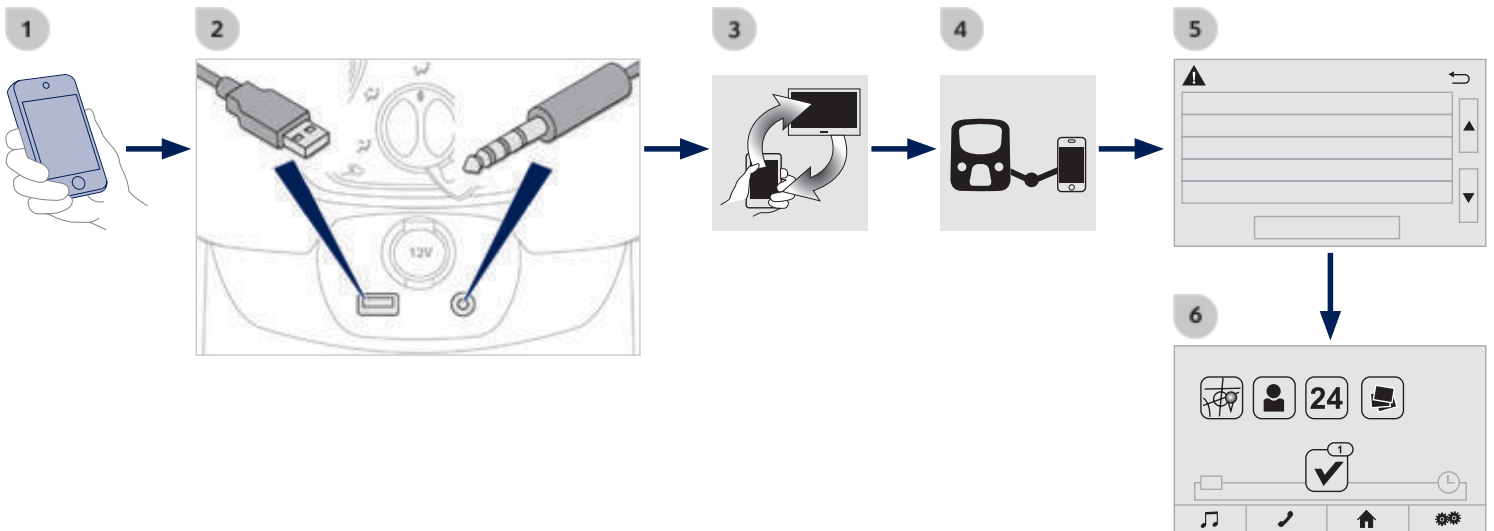

06 CONNECTIONS

1

Download the "**AppinCar**[®]" application to your smartphone.



i

For reasons of safety and ease of use:

- certain applications on your smartphone are not carried over to the system screen.
- certain applications operate only when the vehicle is stationary.

2

Connect the smartphone to the u SB port or JACK auxiliary socket using a suitable cable, available as an accessory from Peugeot dealers.



3

Start the "**AppinCar**[®]" application from your smartphone.



4

Press on "**Mirror Screen**[®]" in the system.



5

During the procedure, a page showing the conditions for use is displayed. Accept to start and end the connection.



6

Once connected you can use certain applications on your smartphone as well as the functions of your system: "**Audio source**", "**Telephone**" and configure the "**Display (video)**".

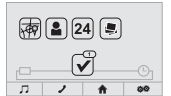









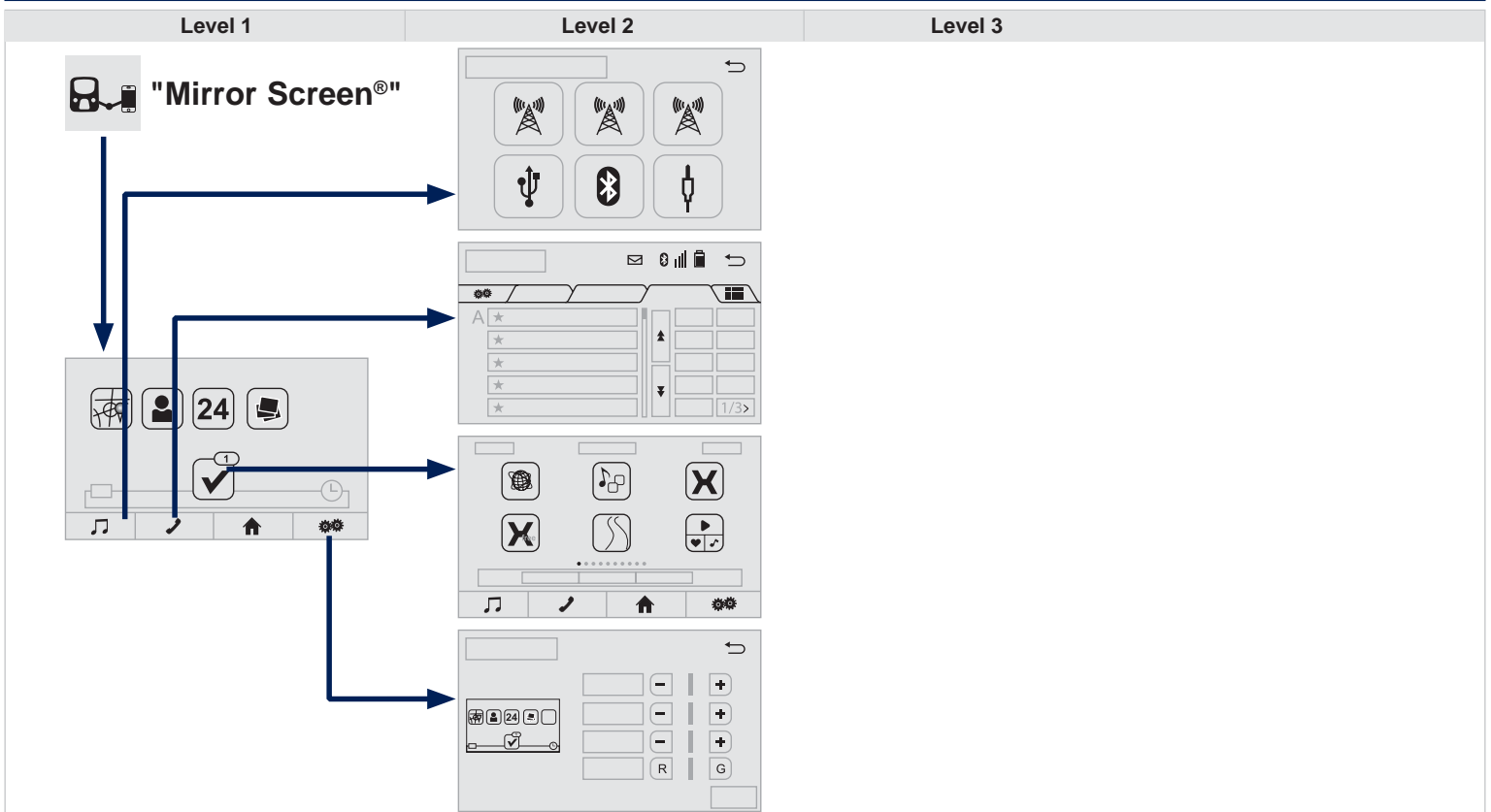















!

It is recommended that both connections be used: u SB / Apple[®] and Bluetooth. The smartphone charges while connected.



06 CONNECTIONS



Level 1		Level 2		Level 3	Comments
 	Mirror Screen® ↓ Audio source →	 FM			Choose the audio source. Choose settings, activate or deactivate options.
		 AM			
		 DAB			
		 USB			
		 Bluetooth audio			
		 A / V			
 	Mirror Screen® ↓ Telephone →		Contacts		After making choices, start the call. Choose settings, activate or deactivate options.
			Favorites		
			Call history		
			Enter a number		
			Telephone/message configuration		
 	Mirror Screen® ↓ AppinCar® →				use the "AppinCar®" applications via the system.
 	Mirror Screen® ↓ Home →				Return to the "Mirror Screen®" home page.
 	Mirror Screen® ↓ Display (video) →	 + - Brightness			Choose the settings.
		 + - Contrast			
		 + - Tone			
		 + - Color			
		 OK	OK		

06 CONNECTIONS

06-2 Connecting MirrorLink® smartphones Using the USB port

i For reasons of safety and because it requires the sustained attention of the driver, using a smartphone while driving is prohibited. The operations must be carried out **with the vehicle stationary**.

! Synchronisation of the system with the smartphone allows the driver to check their smartphone in the screen. The principles and standards are constantly changing with new models of smartphone. For more information, contact a Peugeot dealer.

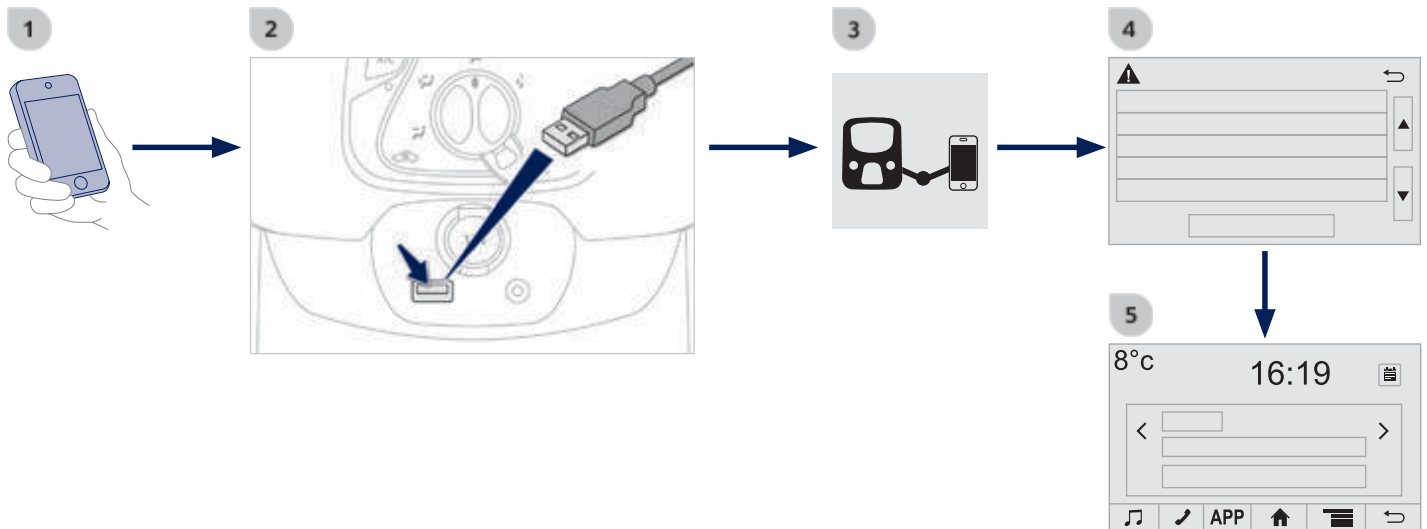

06 CONNECTIONS

1

Depending on the model of your smartphone, it may be necessary to download an application.



i

For reasons of safety and ease of use:

- certain applications on your smartphone are not carried over to the system screen.
- certain applications operate only when the vehicle is stationary.

2

Connect the smartphone to the uSB port using a suitable cable, available as an accessory from Peugeot dealers.



3

Press on "**Mirror Screen**[®]" in the system.



4

During the procedure, a page showing the conditions for use is displayed. Accept to start and end the connection.



5

Once connected you can use certain applications on your smartphone as well as the functions of your system: "**Source audio**", "**Telephone**".

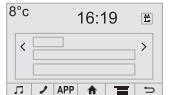









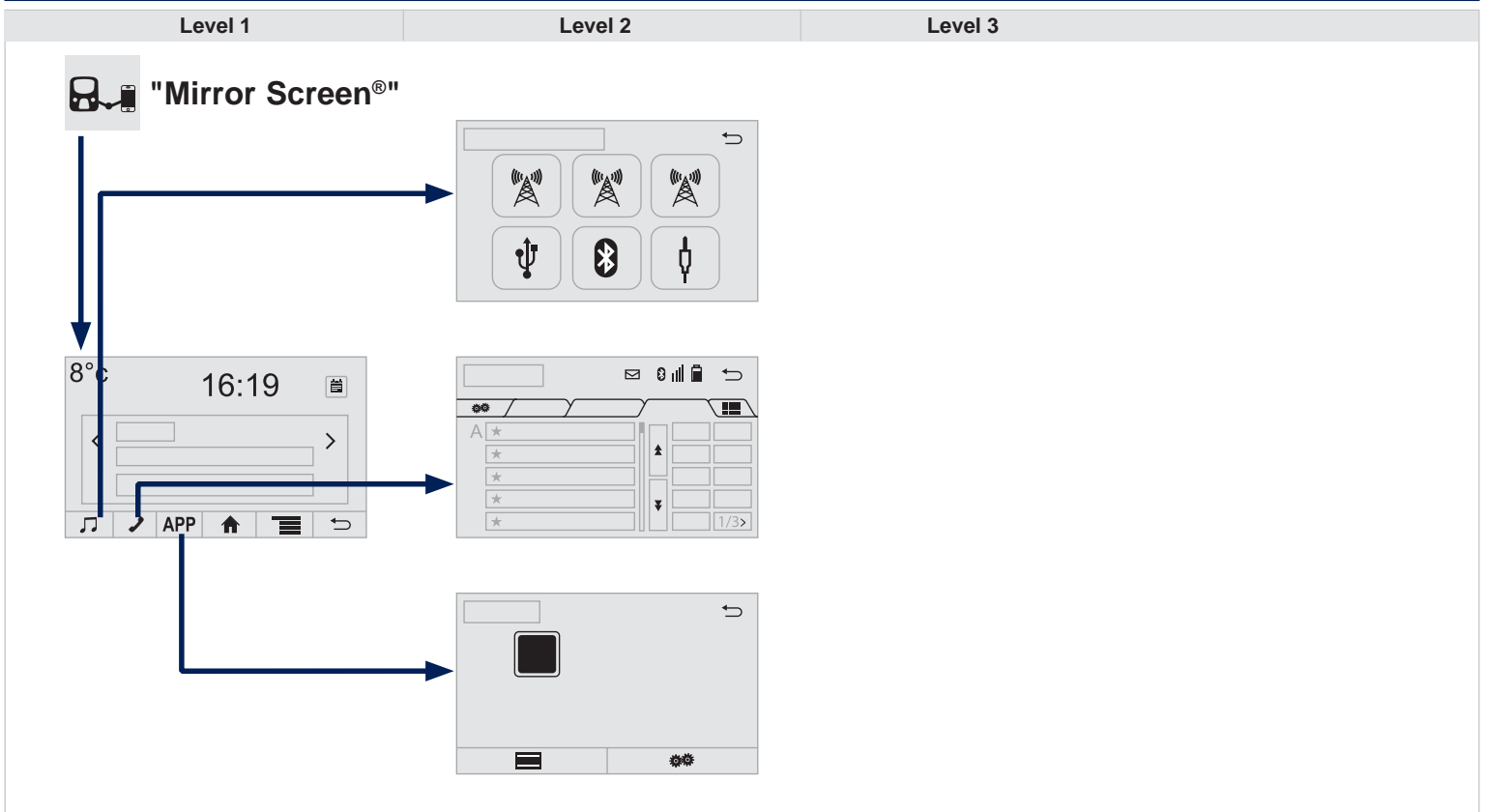







!

It is recommended that both connections be used: uSB / MirrorLink[®] and Bluetooth. The smartphone charges while connected.









06 CONNECTIONS

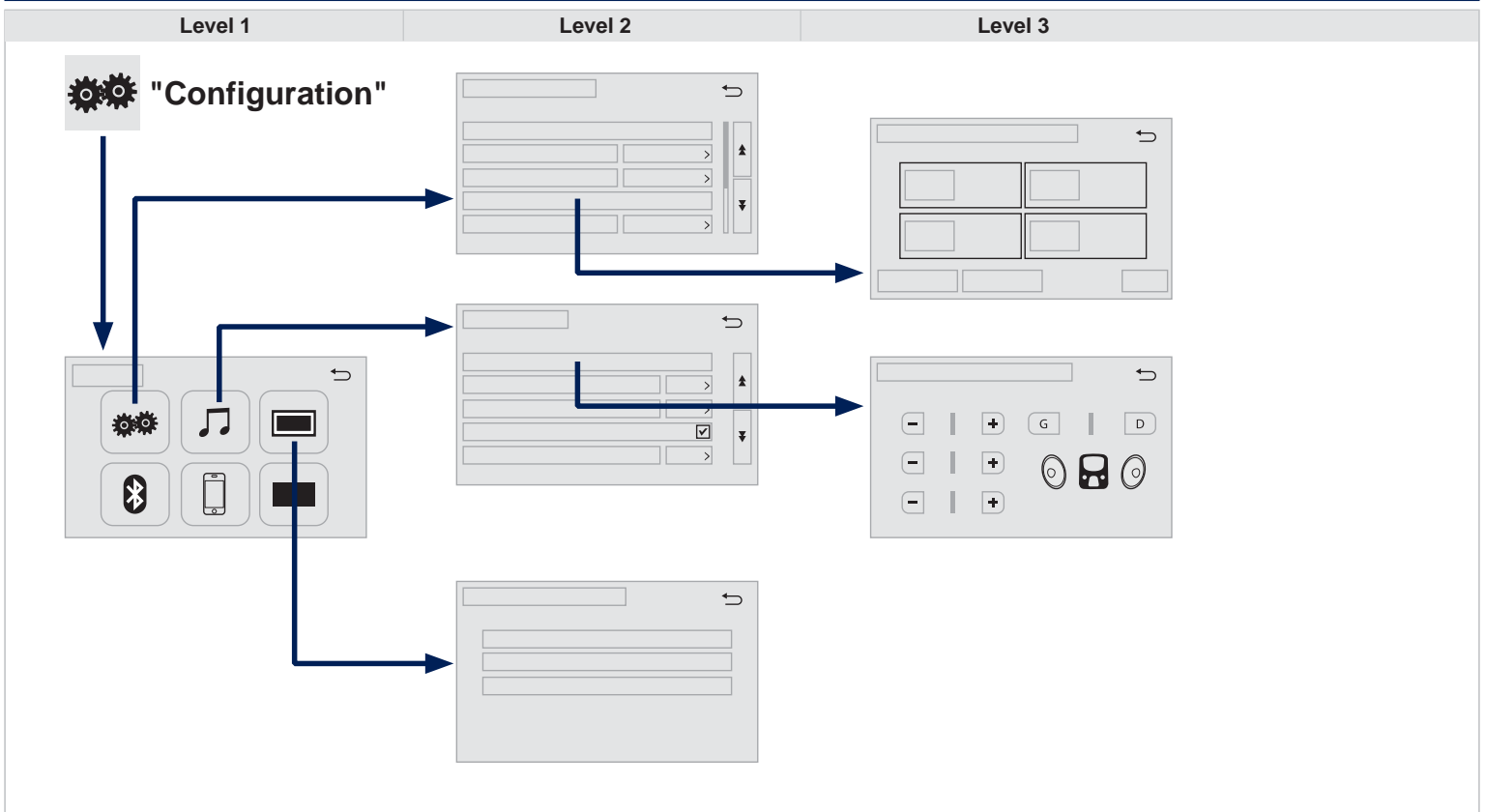

Level 1		Level 2		Level 3	Comments
 	Mirror Screen® ↓ Audio source →	 FM			Choose the audio source. Choose the settings, activate or deactivate options.
		 AM			
		 DAB			
		 USB			
		 Bluetooth audio			
		 A / V			
 	Mirror Screen® ↓ Telephone →		Contacts		After making choices, start the call. Choose the settings, activate or deactivate options.
			Favorites		
			Call history		
			Enter a number		
			Telephone/message configuration		
 APP	Mirror Screen® ↓ MirrorLink® →				use the "MirrorLink®" applications via the system.
 	Mirror Screen® ↓ Home →				Return to the "Mirror Screen®" home page.









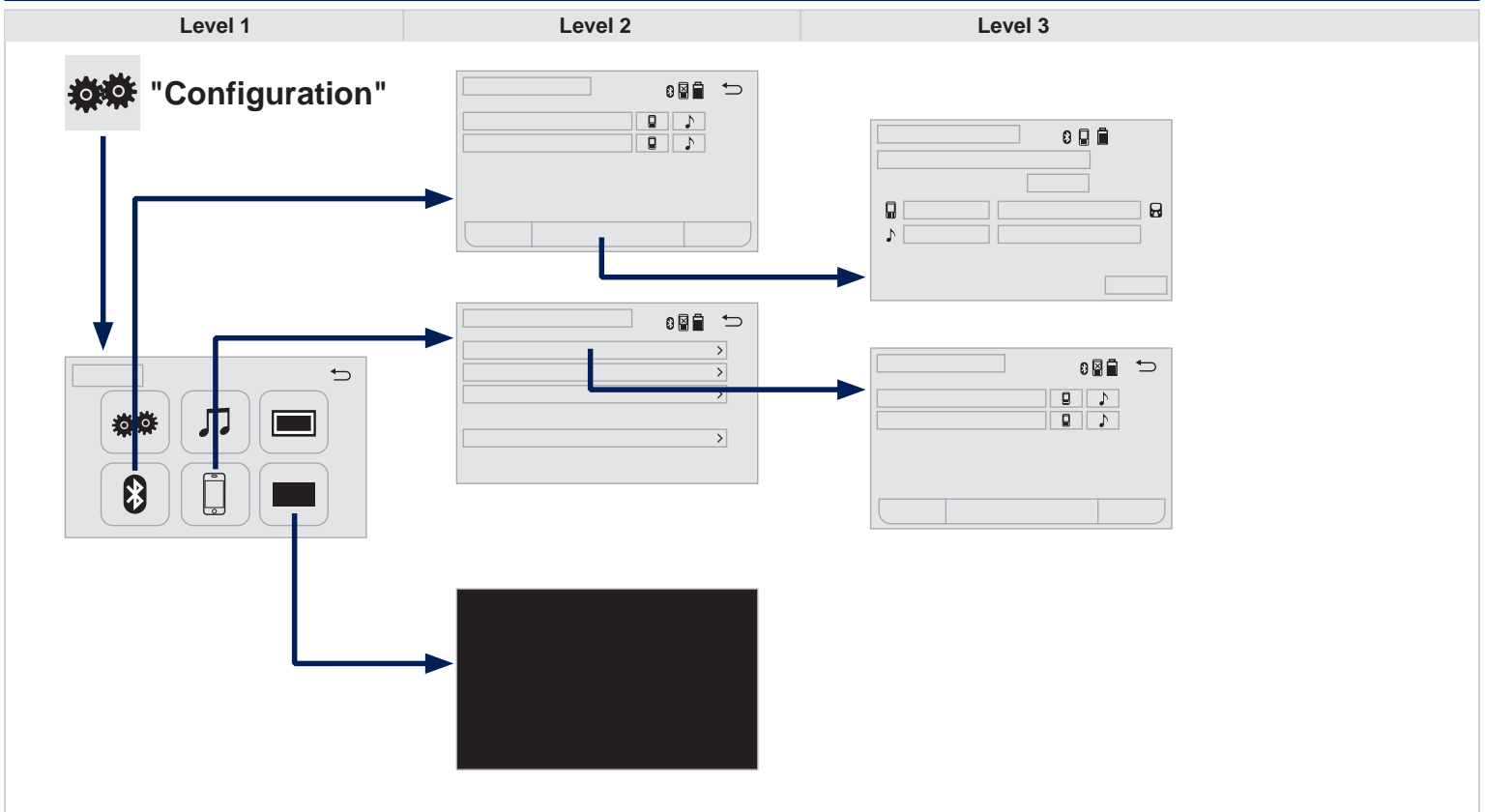

07 CONFIGURATION



Level 1	Level 2	Level 3	Comment	
  Configuration ↓ General →	Clock	OK OK	Save settings.	
	Language	<input checked="" type="checkbox"/>		Select the language.
	Beep	<input checked="" type="checkbox"/>		Activate or deactivate beep mode.
	Personalise the startup image		t ransfer	Store images in a folder initially called "Startupimage", before copying them to the system.
			Delete all	
		OK	OK	Save the settings.
	Animation	<input checked="" type="checkbox"/>		Activate or deactivate animation mode.
	Delete personal data		Delete	Choose settings, activate or deactivate options.
			Do not delete	
Update software				
Software information				
  Configuration ↓ Audio →	Audio Bluetooth sound configuration		Choose settings.	
	iPod® sound input	<input checked="" type="checkbox"/>	u SB	Activate or deactivate iPod® sound inputs.
		<input checked="" type="checkbox"/>	Au X	
	Video input mode	<input checked="" type="checkbox"/>	Nt SC	Activate or deactivate the video input modes.
		<input checked="" type="checkbox"/>	PAL	
	<input checked="" type="checkbox"/> Sleeve configuration			Activate or deactivate sleeve configuration.
Automatic sound adjustment	<input checked="" type="checkbox"/>	Off	Activate or deactivate the automatic sound adjustment modes.	
	<input checked="" type="checkbox"/>	Low		
	<input checked="" type="checkbox"/>	Medium		
	<input checked="" type="checkbox"/>	High		
  Configuration ↓ Display →	General		Select the display configuration.	
	Video			

07 CONFIGURATION



Level 1		Level 2		Level 3		Comment
 	Configuration ↓ Bluetooth →		Telephone			Select the services to use on the peripheral device.
			Audio player			
			Add			Connect a new peripheral device.
			System configuration		t telephone	Select the services to use on the peripheral device.
					Audio player	
			Cancel			
	Remove			Disconnect and remove a peripheral device from the list.		
 	Configuration ↓ Telephone →		Connect the telephone			See the telephone section.
			Sounds configuration			
			Contacts/call history configuration			
			Message configuration			
 	Configuration ↓ Screen off →					Select this mode to switch off the screen, touch the screen to restore.

FREQUENTLY ASKED QUESTIONS

The following table groups together the answers to the most frequently asked questions concerning your audio system.

QUESTION	ANSWER	SOLUTION
Telephone, Bluetooth		
I cannot connect my Bluetooth telephone.	The telephone's Bluetooth function may be switched off or the telephone may not be visible.	<ul style="list-style-type: none"> - Check that your telephone's Bluetooth function is switched on. - Check in the telephone settings that it is "visible to all".
	The Bluetooth telephone is not compatible with the system.	You can check the compatibility of your telephone at www.peugeot.co.uk (services).
The volume of the telephone connected in Bluetooth mode is inaudible.	The volume depends both on the system and on the telephone.	Increase the volume of the audio system, to maximum if required, and increase the volume of the telephone if necessary.
	The ambient noise level has an influence on the quality of telephone communication.	Reduce the ambient noise level (close the windows, reduce the booster fan speed, slow down, ...).
Contacts are not shown in alphabetical order.	Some telephones offer display options. Depending on the settings chosen, contacts can be transferred in a specific order.	Modify the display setting in the telephone directory.
The system does not receive SMS text messages.	The Bluetooth mode on your telephone does not permit sending SMS text messages to the system.	

FREQUENTLY ASKED QUESTIONS

QUESTION	ANSWER	SOLUTION
USB, portable player		
There is a long waiting period following the connection of a USB memory stick.	When a new medium is inserted, the system reads a certain amount of data (directory, title, artist, etc.). This may take from a few seconds to a few minutes.	This phenomenon is normal.
Some characters in the media information are not displayed correctly while playing.	The audio system does not display some types of characters.	Use standard characters to name tracks and folders.
Playing of streaming files does not start.	The peripheral device connected does not support automatic play.	Start the playback from the device.
The names of tracks and the track length are not displayed on the screen when streaming audio.	The Bluetooth profile does not allow the transfer of this information.	
Radio		
The quality of reception of the radio station listened to gradually deteriorates or the stored stations do not function (no sound, 87.5 Mhz is displayed...).	The vehicle is too far from the transmitter used by the station listened to or there is no transmitter in the geographical area through which the vehicle is travelling.	Activate the "RDS" function to enable the system to check whether there is a more powerful transmitter in the geographical area.
	The environment (hills, buildings, tunnels, basement car parks...) block reception, including in RDS mode.	This phenomenon is normal and does not indicate a fault with the audio system.
	The aerial is absent or has been damaged (for example when going through a car wash or into an underground car park).	Have the aerial checked by a Peugeot dealer.

FREQUENTLY ASKED QUESTIONS

QUESTION	ANSWER	SOLUTION
I cannot find some radio stations in the list of stations received.	the station is not received or its name has changed in the list.	
the name of the radio station changes.	Some radio stations send other information in place of their name (the title of the song for example). the system interprets this information as the name of the station.	
Settings, configuration		
there is a difference in sound quality between the different audio sources (radio, USB...).	For optimum sound quality, the audio settings (Volume, Treble, Medium, Bass) can be adapted to the different sound sources, which may result in audible differences when changing source (radio, USB...).	Check that the audio settings are adapted to the sources listened to. It is advisable to select automatic sound adjustment (Low, Medium, High). Check the quality and format of your recording.
With the engine off, the system switches off after a few minutes of use.	When the engine is switched off, the system's operating time depends on the battery charge. the switch-off is normal: the system switches to economy mode and switches off to prevent discharging of the vehicle's battery.	Start the vehicle's engine to increase the battery charge.



RADIO



For safety reasons, the driver must only carry out operations which require prolonged attention while the vehicle is stationary.

to preserve the state of charge of the battery, on vehicle fitted with "Keyless Entry and Starting" the audio system switches off following activation of energy economy mode, 20 minutes after stopping the engine.

CONTENTS

01 First steps	p. 222
02 Steering mounted controls	p. 224
03 Radio	p. 225
04 Media	p. 228
05 Telephone	p. 231
06 Settings	p. 233
Frequently asked questions	p. 234

01 FIRST STEPS

Audio system with Bluetooth®

On/Off.
Volume (each source is independent).

Accept an incoming call.

Reject an incoming call.
end call.



Select AM, FM and DAB* wavebands.
Select the Bt A (Bluetooth Audio) and Au X source.

Select:

- the next radio frequency up/down automatically.
- the previous/next line in a list or a menu.
- the previous/next media folder.

Display menu and set options.
Rotate: scroll through a list or change radio station.
Press: confirm the option displayed in the screen.

AM radio buttons 1 to 6: select a preset radio station.
FM buttons 1 to 5: select a preset radio station.
FM list: display the radio stations received.
Long press: preset a radio station.
Back: abandon current operation, up on level in the menu.

* Depending on equipment.

01 FIRST STEPS

Audio system



02 STEERING MOUNTED CONTROLS

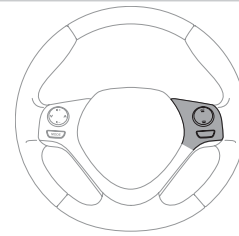

		<p>Short press: Select AM and FM wavebands and Bt A (Bluetooth Audio) and Au X sources. Long press: Mute / restore sound from the radio or pause media sources.</p>
		<p>Increase volume.</p>
		<p>Decrease volume.</p>
		<p>Radio: change to preset radio stations in ascending order. Media: next track.</p>
		<p>Radio: change to preset radio stations in descending order. Media: previous track.</p>

		<p>Accept an incoming call.</p>
		<p>Reject the incoming call. end the call in progress.</p>

03 RADIO

Selecting a station

The surroundings (hills, buildings, tunnel, parking, under ground...) may prevent reception, including RDS alternative frequencies. This phenomenon is normal in the propagation of radio waves and does not in any way imply a fault with the audio system.

1 Press on "**MODE**" to select the FM or AM waveband.



2a Briefly press one of the buttons to carry out an automatic search down/up for radio stations.



2b Turn the dial to carry out a manual search down/up for radio stations.



3 In FM mode, press the "**List**" button to display the list of stations received locally. Press one of the buttons to select the chosen radio station then confirm. Press on "**Update**" to refresh the list.

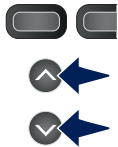

Presetting a station

1 Press on "**MODE**" to select the FM or AM waveband.



2 Briefly press one of these buttons to start an automatic search up/down for frequencies.



3 Make a long press one of the buttons to preset the current radio station. The name of the station is displayed and an audible signal confirms the preset.



03 RADIO

Alternative frequencies (AF) / RDS

! When alternative frequencies is activated, the system selects the best frequency (Region code) for the station being listened to. However, in certain conditions, tracking of a station is not available throughout the whole country, as radio stations do not cover 100% of the country. When reception becomes poor, the frequency changes to a regional station.

1 Press on "**MENU**" to display the list.



2 Select "**RADIO**" then press to confirm.



3a Select "**FM AF**" then press to activate or deactivate the frequency.



3b Select "**Region code**" then press to activate or deactivate.



Receiving TA messages

! The TA (Traffic Announcement) function gives priority to playing TA alert messages. To be active, this function requires good reception of a radio station that broadcasts this type of message. As soon as traffic information is broadcast, the media playing is interrupted automatically to transmit the TA message. Normal play of the media is restored after transmission of the message.

1 Press on "**MENU**" to display the list.



2 Select "**RADIO**" then press to confirm.





3 Select "**FM TA**" then press to switch traffic announcements on or off.



03 RADIO

DAB (Digital Audio Broadcasting) Digital radio



- !** Digital radio provides higher quality reception and also additional categories of traffic announcements (TA INFO). The range of multiplexes available is displayed in alphabetical order.

- 1** Press on "**MODE**" to select the DAB waveband. 
- 2** Briefly press one of the buttons to automatically search down/up for stations. 
- 3** Turn the knob to manually search down/up for stations. 
- 4** In DAB mode, press the "**Text**" button to display Radiotext (Text) for the current station.
Make a long press on a button to preset (save) the station being listened to. The name of the station is displayed and an audible signal confirms the preset.



Digital radio - DAB / FM station tracking

- i** "DAB" does not cover 100% of the country. When the digital signal is weak, the alternative DAB frequency option, "**DAB AF**", makes it possible to continue listening to the same station, by automatically switching to the corresponding "FM" station (if there is one).

- 1** Press on **MENU** to display the list. 
 - 2** Select "**RADIO**" then press to confirm. 
 - 3** Select "**DAB AF**" then press to activate or deactivate the frequency. 
- i** If "**DAB AF**" tracking is activated, there is a difference of a few seconds when the system switches to the "FM" analogue radio station with sometimes a variation in volume. When the digital signal is restored, the system automatically changes back to "DAB".

- !** If the "DAB" station being listened to is not available, or if "**DAB AF**" is not activated, the sound will cut out while the digital signal is too weak.

04 MEDIA

USB player

- 1a** Insert the uSB memory stick in the uSB player or connect the uSB peripheral device to the uSB port using a suitable cable (not supplied).

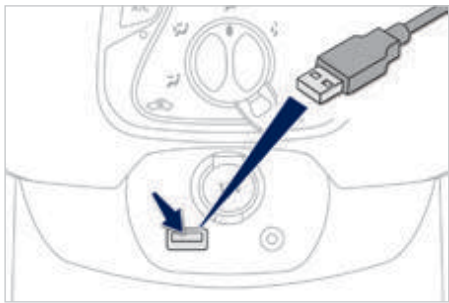

When the system builds playlists (in temporary memory), an operation which can take from a few seconds to several minutes at the first connection.
Reduce the number of non-music files and the number of folders to reduce the waiting time.
The playlists are updated every time the ignition is switched off or connection of a uSB memory stick. However, the audio system memorises these lists and if they are not modified, the loading time will be shorter.

Using the auxiliary input (A/V) (audio cable not supplied)

- 1b** Connect the portable device (MP3 player...) to the auxiliary JACK socket using an audio cable.

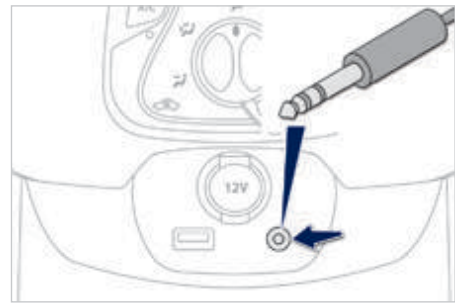

04 MEDIA

MP3 / USB player

Information and advice



The audio system plays files with the extension:
".wma", type Ver7 and Ver8 with bit rate between 48 and 192 Kbps
and type Ver9 with bit rate between 48 and 320 Kbps.
".aac", with bit rate between 16 and 320 Kbps.
".mp3 - MPeg 1" with bit rate between 32 and 320 Kbps and ".mp3 -
MPeg 2" with bit rate between 8 and 160 Kbps.
The sampling rates supported are 11, 22, 44 and 48 KHz.



In order to be read, a uSB memory stick must be formatted FAT 16
or 32.



It is advisable to restrict file names to 20 characters, without using of
special characters (e.g.: " " ? ; ù) to avoid any playing and displaying
problems.



The system supports uSB mass storage devices or Apple® players
via uSB ports. The adaptor cable not supplied.
Control of the peripheral device is with the audio system controls.
Other peripherals, not recognised on connection, must be connected
to the auxiliary socket using a Jack cable (not supplied).



The system can alternatively read files via the Bluetooth® system
and the uSB port.



It is recommended that official Apple® uSB cables are used to
ensure correct operation.

04 MEDIA

Audio streaming



Streaming allows audio files on your telephone to be played via the vehicle's speakers.

1

Connect the telephone: see the "**Telephone**" section.
Select "**Bluetooth**", then "**Pairing**".



2

You can also view, activate or deactivate system settings related to the Bluetooth function.
Press on "**MENU**" to display the list.
Select "**Bluetooth**" then press to display the list.



!

Once connected for streaming, the telephone is considered as a media source.

If play does not start automatically, it may be necessary to start audio play from the telephone.

Connecting Apple® players

1

Connect the Apple® player to the u SB port using a suitable cable (not supplied).
Play starts automatically.



2

Control is via the audio system.

i

The classifications available are those of the portable device connected (artists / albums / genres / tracks / playlists / audio books / podcasts).

The default classification used is by artist. To modify the classification used, return to the first level of the menu then select the desired classification (playlists for example) and confirm to go down through the menu to the desired track.

!

The version of software in the audio system may not be compatible with the generation of your Apple® player.

05 TELEPHONE

Pairing a Bluetooth telephone First connection

! For reasons of safety and because they require prolonged attention on the part of the driver, the operations for pairing the Bluetooth mobile telephone to the hands-free system of the audio system must be carried out with the **vehicle stationary**.

1

Switch on the Bluetooth function of your telephone and ensure that it is "visible to all" (telephone configuration).



2

Press on **"Menu"** to display the list.
Select **"Bluetooth"** then press to display the list.



3

Select **"Pairing"** then press to display the system name and code.



4

Using the telephone's keypad, enter the PIN displayed in the screen of the system or confirm in the telephone the PIN displayed.



i

If the operation fails, we recommend switching the function Bluetooth of your telephone off and then on again.



5

When the pairing procedure has finished successfully, a screen page with **"Connection successful"** appears.

Once the procedure has been successfully completed, a list appears with the **"TEL"** option. Select **"TEL"** then press to display the list for sound settings, contacts and the transfer of your telephone's history*.

You can then enter the settings for each of these functions.



6

Press this button to navigate through the telephone menu.



7

You can quit at any time by pressing this button.



* If your telephone is fully compatible.

05 TELEPHONE

Receiving a call

1 An incoming call is announced by a ring and a superimposed display in the screen.

2a Press this button to accept the incoming call.



2b Or press this steering mounted button to accept the call.



Ending a call

1a To reject or end a call, press this button.



1b Or press this steering mounted button.



Making a call

1a Press this button to navigate in the telephone menu.



1b Select "**Phonebook**" to go to your contacts, then navigate using the knob.



1c To dial a number, select "**Enter a phone num**" in the list.



06 SETTINGS

System settings

1

Press on "**MENU**" to display the list of options.



2

Select "**Bluetooth**" then press to display the list of Bluetooth settings.



3

Select "**Default**" then press to display the list of settings:

- "**All initialize**"
- "**Sound setting**"
- "**Car device info**"

then press to confirm.



4

Press the "**Yes**" or "**No**" button to activate or deactivate the options



Audio settings

1

Press on "**MENU**" to display the list of options.



2

Select "**Sound setting**" then press to display the list of settings for activating or deactivating options:

- "**BASS**"
- "**TREBLE**"
- "**FADER***"
- "**BALANCE**"



i

The audio settings are different and independent for each audio source.

* Depending on equipment.

FREQUENTLY ASKED QUESTIONS

The following table groups together the answers to the most frequently asked questions concerning your audio system.

QUESTION	ANSWER	SOLUTION
Telephone, Bluetooth		
I cannot connect my Bluetooth telephone.	The telephone's Bluetooth function may be switched off or the telephone may not be visible.	<ul style="list-style-type: none"> - Check that your telephone's Bluetooth function is switched on. - Check in the telephone settings that it is "visible to all".
	The Bluetooth telephone is not compatible with the system.	You can check the compatibility of your telephone at www.peugeot.co.uk (services).
The volume of the telephone connected in Bluetooth mode is inaudible.	The volume depends both on the system and on the telephone.	Increase the volume of the audio system, to maximum if required, and increase the volume of the telephone if necessary.
	The ambient noise level has an influence on the quality of telephone communication.	Reduce the ambient noise level (close the windows, reduce the booster fan speed, slow down, ...).
Contacts are not shown in alphabetical order.	Some telephones offer display options. Depending on the settings chosen, contacts can be transferred in a specific order.	Modify the display setting in the telephone directory.
The system does not receive SMS text messages.	The Bluetooth mode on your telephone does not permit sending SMS text messages to the system.	

FREQUENTLY ASKED QUESTIONS

QUESTION	ANSWER	SOLUTION
USB, portable player		
There is a long waiting period following the connection of a USB memory stick.	When a new medium is inserted, the system reads a certain amount of data (directory, title, artist, etc.). This may take from a few seconds to a few minutes.	This phenomenon is normal.
Some characters in the media information are not displayed correctly while playing.	The audio system does not display some types of characters.	Use standard characters to name tracks and folders.
Playing of streaming files does not start.	The peripheral device connected does not support automatic play.	Start the playback from the device.
The names of tracks and the track length are not displayed on the screen when streaming audio.	The Bluetooth profile does not allow the transfer of this information.	
Radio		
The quality of reception of the radio station listened to gradually deteriorates or the stored stations do not function (no sound, 87.5 Mhz is displayed...).	The vehicle is too far from the transmitter used by the station listened to or there is no transmitter in the geographical area through which the vehicle is travelling.	Activate the "RDS" function to enable the system to check whether there is a more powerful transmitter in the geographical area.
	The environment (hills, buildings, tunnels, basement car parks...) block reception, including in RDS mode.	This phenomenon is normal and does not indicate a fault with the audio system.
	The aerial is absent or has been damaged (for example when going through a car wash or into an underground car park).	Have the aerial checked by a Peugeot dealer.

FREQUENTLY ASKED QUESTIONS

QUESTION	ANSWER	SOLUTION
I cannot find some radio stations in the list of stations received.	the station is not received or its name has changed in the list.	
the name of the radio station changes.	Some radio stations send other information in place of their name (the title of the song for example). the system interprets this information as the name of the station.	
Settings, configuration		
there is a difference in sound quality between the different audio sources (radio, USB...).	For optimum sound quality, the audio settings (Volume, Treble, Medium, Bass) can be adapted to the different sound sources, which may result in audible differences when changing source (radio, USB...).	Check that the audio settings are adapted to the sources listened to. It is advisable to select automatic sound adjustment (Low, Medium, High). Check the quality and format of your recording.
With the engine off, the system switches off after a few minutes of use.	When the engine is switched off, the system's operating time depends on the battery charge. the switch-off is normal: the system switches to economy mode and switches off to prevent discharging of the vehicle's battery.	Start the vehicle's engine to increase the battery charge.

exterior

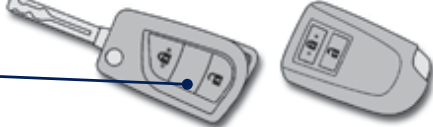
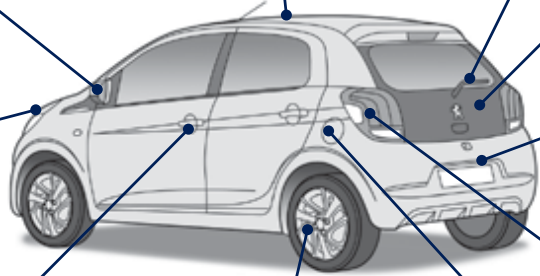
Keys	30		Wipers	99-100
Remote control	31-32		Changing a wiper blade	164
"Keyless entry and Starting" system	33-36		electric fabric roof	42-46
Remote control battery	32, 36		Roof bars	166
Starting	71, 73		Accessories	167-168
Door mirrors	51		Boot temporary puncture repair kit	39-40 136-140
Lighting control stalk	93-97		Reversing camera	92
Adjusting the headlamps	98		towing	165
Changing bulbs	147-149, 151		Changing bulbs	150-151
- front lamps			- rear lamps	
- direction indicator repeaters			- 3 rd brake lamp	
Doors	38-40		- number plate lamps	
- opening / closing			Fuel tank, refuelling	134-135
- central locking			Fuel gauge	25
electric windows	41		electronic stability programme	107-109
Quarter lights (5-door)	41		Snow chains	146
			under-inflation detection	103-106
			tyre pressures	180
			Changing a wheel	141-145
			- tools	
		- removal / fitting		

Interior

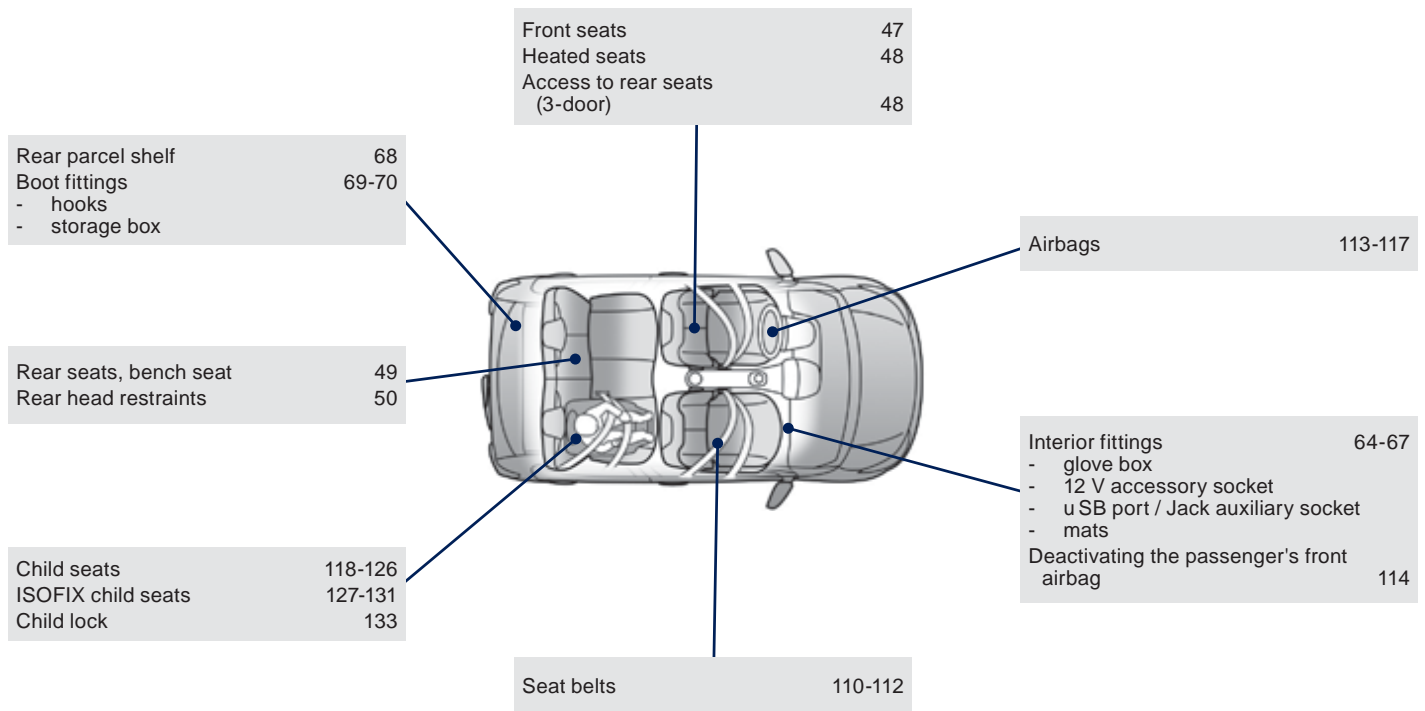

Instruments and controls

<table border="0"> <tr> <td>Courtesy lamp</td> <td>101</td> </tr> <tr> <td>Control for electric fabric roof</td> <td>42</td> </tr> <tr> <td>Rear view mirror</td> <td>52</td> </tr> <tr> <td>Sun visors</td> <td>65</td> </tr> </table>	Courtesy lamp	101	Control for electric fabric roof	42	Rear view mirror	52	Sun visors	65	<table border="0"> <tr> <td>7-inch touch screen</td> <td>181-220</td> </tr> <tr> <td>Setting the time</td> <td>29</td> </tr> <tr> <td>Radio</td> <td>221-236</td> </tr> <tr> <td>Setting the time</td> <td>28</td> </tr> </table>	7-inch touch screen	181-220	Setting the time	29	Radio	221-236	Setting the time	28
Courtesy lamp	101																
Control for electric fabric roof	42																
Rear view mirror	52																
Sun visors	65																
7-inch touch screen	181-220																
Setting the time	29																
Radio	221-236																
Setting the time	28																
<table border="0"> <tr> <td>Door mirrors</td> <td>51</td> </tr> <tr> <td>electric windows</td> <td>42</td> </tr> </table>	Door mirrors	51	electric windows	42	<table border="0"> <tr> <td>Heating, ventilation</td> <td>53-55</td> </tr> <tr> <td>Manual air conditioning</td> <td>56-57</td> </tr> <tr> <td>Automatic air conditioning</td> <td>58-61</td> </tr> <tr> <td>Windscreen demist / defrost</td> <td>62</td> </tr> <tr> <td>Rear screen demist / defrost</td> <td>63</td> </tr> </table>	Heating, ventilation	53-55	Manual air conditioning	56-57	Automatic air conditioning	58-61	Windscreen demist / defrost	62	Rear screen demist / defrost	63		
Door mirrors	51																
electric windows	42																
Heating, ventilation	53-55																
Manual air conditioning	56-57																
Automatic air conditioning	58-61																
Windscreen demist / defrost	62																
Rear screen demist / defrost	63																
<table border="0"> <tr> <td>Opening the bonnet</td> <td>170</td> </tr> </table>	Opening the bonnet	170	<table border="0"> <tr> <td>12 V accessory socket</td> <td>65</td> </tr> <tr> <td>uSB port</td> <td>66</td> </tr> <tr> <td>Jack auxiliary socket</td> <td>66</td> </tr> </table>	12 V accessory socket	65	uSB port	66	Jack auxiliary socket	66								
Opening the bonnet	170																
12 V accessory socket	65																
uSB port	66																
Jack auxiliary socket	66																
<table border="0"> <tr> <td>Dashboard fuses</td> <td>152-156</td> </tr> </table>	Dashboard fuses	152-156	<table border="0"> <tr> <td>Manual gearbox</td> <td>76</td> </tr> <tr> <td>e.g. electronic gearbox</td> <td>77-80</td> </tr> <tr> <td>gear shift indicator</td> <td>81</td> </tr> <tr> <td>Stop & Start</td> <td>83-85</td> </tr> <tr> <td>Hill start assist</td> <td>82</td> </tr> </table>	Manual gearbox	76	e.g. electronic gearbox	77-80	gear shift indicator	81	Stop & Start	83-85	Hill start assist	82				
Dashboard fuses	152-156																
Manual gearbox	76																
e.g. electronic gearbox	77-80																
gear shift indicator	81																
Stop & Start	83-85																
Hill start assist	82																
<table border="0"> <tr> <td>Manual parking brake</td> <td>76</td> </tr> </table>	Manual parking brake	76															
Manual parking brake	76																



Instruments and controls (continued)

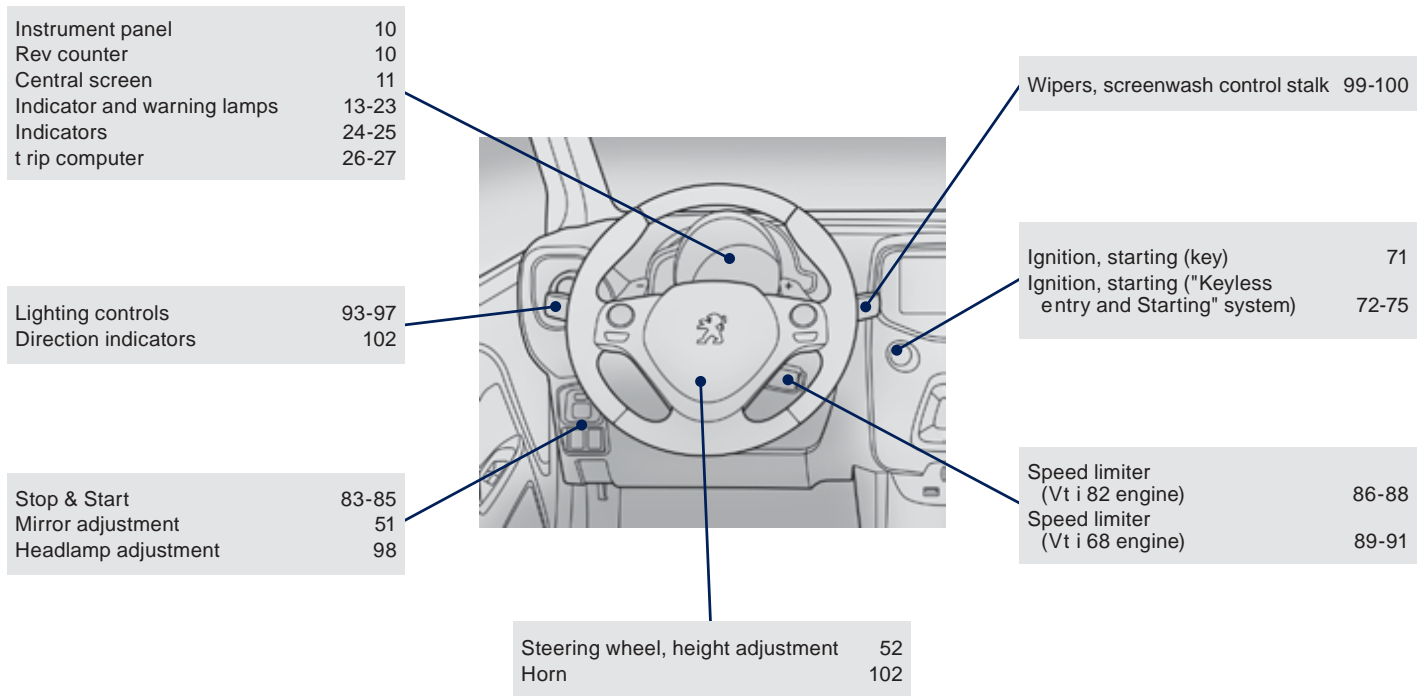

Maintenance - technical data

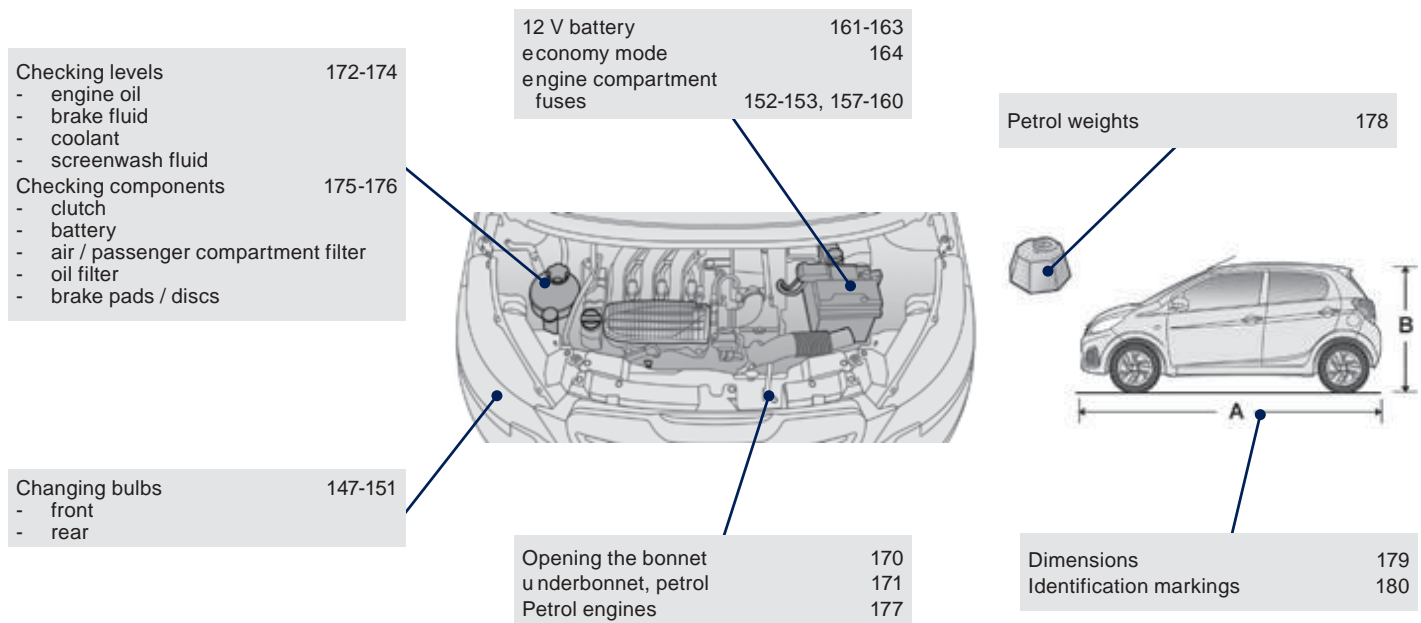

A

ABS 107, 108
 Accessories 167
 Accessory socket, 12V 64, 65
 Access to rear seats (3-door) 48
 Adjusting headlamps 98
 Adjusting the steering wheel 52
 Airbags 22, 113
 Airbags, curtain 116, 117
 Airbags, front 114, 117
 Airbags, lateral 115, 117
 Air conditioning 8, 57, 60
 Air conditioning, automatic 58
 Air conditioning, manual 56
 Air distribution adjustment 55
 Air filter 175
 Air flow 53
 Air flow adjustment 56, 59
 Air intake 57, 60
 Air recirculation 57, 60
 Air vents 53
 Anti-lock braking system (ABS) 107, 108
 Audible warning 102
 Audio cable 194, 228
 Audio streaming (Bluetooth) 195, 197, 230
 Automatic illumination of headlamps 94, 96
 Auxiliary socket 64, 66, 194, 195, 228

B

Battery 161-163, 175
 Battery, charging 163
 Battery for electronic key 36
 Battery, remote control 32
 Bluetooth (hands-free) 200, 231
 Bluetooth (telephone) 200, 231

Bonnet 170
 Boot 39
 Boot lamp 101
 Brake discs 176
 Brake lamps 150
 Brake pads 176

C

Capacity, fuel tank 134
 Central locking 31, 33, 38
 Changing a bulb 147-151
 Changing a fuse 152-160
 Changing a wheel 141-145
 Changing a wiper blade 164
 Changing the electronic key battery 36
 Changing the remote control battery 32
 Checking levels 172-174
 Checking tyre pressures (using the kit) 139
 Checks 171, 175, 176
 Child lock 133
 Children 112, 114, 118-133
 Child seats 118-132
 Child seats, conventional 124
 Child seats, ISOFIX 128, 129
 Closing the boot 39
 Closing the doors 34
 Clutch 175
 Colour screen 182, 183
 Connectors, audio 64, 66, 195, 228
 Coolant level 174
 Cup holder 64

D

DAB
 (Digital Audio Broadcasting) 192, 193, 227
 Daytime running lamps 94, 147, 149
 Deactivating the passenger airbag 114
 Defrosting 53, 56, 63
 Defrosting, front 62
 Demisting 53, 56, 58, 62, 63
 Demisting, front 62
 Demisting the rear screen 63
 Digital Audio Broadcasting
 (DAB) 192, 193, 227
 Dimensions 179
 Dipped beam 93, 148
 Dipstick 172
 Direction indicators 102, 148, 150
 Display screen 11, 24
 Doors 38
 Door pockets 64
 Driving economically 8
 Driving mode 77
 Dynamic stability control (DSC) 17, 20, 107-109

E

easy mode (automatic mode) 77
 eBA (emergency braking assistance) 107
 eBFD 107, 108
 eco-driving 8
 economy mode 164
 electronic brake force distribution
 (eBFD) 107, 108
 electronic engine immobiliser 32
 emergency starting 162
 emergency warning lamps 103
 energy economy mode 164
 engine compartment 171
 engine compartment fusebox 157

engine, petrol..... 135, 171, 177
 engines 177
 environment.....8 , 54, 63, 103, 163, 174

F

Filling with fuel 134, 135
 Fitting a wheel..... 144
 Fittings, boot 69
 Flashing indicators..... 102, 148, 150, 151
 Folding/unfolding the door mirrors 51
 Frequency (radio) 191, 225
 Front foglamps 95, 149
 Front seats 47
 Fuel..... 8, 25, 134, 135
 Fuel gauge 25, 134
 Fuel tank..... 25, 134
 Fusebox, dashboard 154
 Fuses..... 152

G

gearbox - etg 8, 77, 176
 gearbox, manual 8, 76, 83, 175
 gear lever 8
 gear lever, etg gearbox..... 77
 gear lever, manual gearbox 76
 gear shift indicator 81
 glove box 64, 65

H

Hands-free kit 200, 231
 Hazard warning lamps 103
 Headlamps 93, 98, 148, 149

Head restraints, rear 50
 Heating 55, 56, 59
 Hill start assist..... 82
 Hooks 70

I

Identification plates..... 180
 Indicators, direction 102
 Inflating accessories (using the kit) 139
 Inflating tyres 8, 180
 Instrument panel 10
 Instrument panel screen 11
 Interior fittings 64, 65
 Interior lamp 101
 iPhone connection 206
 ISOFIX 131
 ISOFIX mountings..... 127, 131

J

Jack 142
 Jack cable 194, 228
 JACK socket..... 64, 66, 194, 228

K

Keeping children safe 112, 114, 118-133
 Key 30
 Key, electronic..... 33-35, 37
 Key in ignition warning..... 71
 Keyless entry and Starting 33, 34, 72

L

Lamps, front 148-149
 Lamps, rear 150-151
 Lamps, warning and indicator 13-23
 Level, brake fluid 173
 Levels and checks 171-174
 Lighting 148
 Lighting bulbs (replacement) 147-151
 Lighting control stalk 93, 94
 Lighting dimmer 26
 Lighting, guide-me home 97
 Lighting on reminder 95
 Loading 8
 Locating your vehicle 31
 Locking/unlocking a door from the inside..... 38

M

Main beam 93, 148
 Maintenance 8
 Manual mode 77
 Mat 67
 Menu 186, 188, 198, 214, 216
 Menus (touch screen) 182
 Mini fuel level 25, 134
 Mirrorlink connection 210-212
 Mirror, rear view 52
 Mirrors, door 51
 Mountings for ISOFIX seats 127, 131

N

Number plate lamps 151

Alphabetical index

O

Oil filter..... 175
 Oil level..... 172
 Opening the bonnet 170
 Opening the boot 33, 39
 Opening the doors 33
 Operation indicator lamps 13-23

P

Parcel shelf, rear..... 68
 Parking brake 76, 176
 Passenger compartment filter 175
 Pedal, clutch..... 175
 Port, USB 64, 66, 194, 228
 Power steering 22
 Protecting children 112, 114, 118-133
 Puncture..... 136, 141

R

Radio 190-193, 225-227
 RDS 191, 226
 Rear demisting 63
 Rear foglamp..... 95, 150
 Rear quarter panel windows..... 41
 Rear screen (demisting)..... 63
 Recharging the battery 163
 Remote control..... 31, 37
 Removing and fitting a fuse 152-160
 Removing a wheel 143
 Removing the mat..... 67
 Replacing bulbs 147-151
 Replacing the air filter 175
 Replacing the oil filter 175

Replacing the passenger
 compartment filter 175
 Replacing wiper blades..... 164
 Rev counter..... 10
 Reversing camera..... 92
 Reversing lamps 150
 Roof bars..... 166
 Roof, electric fabric..... 42
 Routine checks 175, 176

S

Screen menu..... 186, 188, 198, 214, 216
 Screenwash 100
 Screenwash fluid level..... 174
 Screen-wash reservoir 174
 Seat adjustment..... 47, 49
 Seat belts 49, 110-112, 124
 Seat, rear, folding backrest..... 49
 Seats, rear..... 48, 49
 Servicing 8
 Setting the clock 28, 29
 Sidelamps 93, 94, 148
 Side repeater 151
 Snow chains..... 146
 Spare wheel..... 142
 Speed limiter 86, 89
 Speedometer 24
 Starting using another battery..... 162
 Starting the vehicle..... 71, 72, 74, 77
 Steering mounted controls, audio 185, 224
 Steering wheel adjustment 52
 Stopping the vehicle 71, 72, 74, 77
 Stop Start..... 27, 83, 85
 Storage..... 64, 65
 Sun visor 64, 65

T

Tables of fuses 152
 Telephone 200, 231
 Temperature adjustment..... 55, 56, 59
 Temporary puncture repair kit 70, 136
 Three flashes function
 (direction indicators) 102
 Third brake lamp 151
 Time 28, 29
 Tools..... 142
 Touch screen..... 181
 Touch screen (Menus) 182
 Towing another vehicle 165
 Towing eye 70, 165
 Traffic information (t A) 226
 TRC (traction control) 17, 20, 107-109
 Trip computer 26, 27
 Trip distance recorder..... 24
 Tyre pressures 140, 180
 Tyres..... 8
 Tyre
 under-inflation detection..... 22, 103-106, 140

U

Under floor storage 70
 Under-inflation (detection) 103
 Unlocking 31, 33
 USB 64, 66, 194, 195, 228

V

Vanity mirror..... 65
 Ventilation 53, 56, 59
 Visibility 53

W

Warning lamps	13-23
Wash-wipe, rear	100
Weights	178
Wheel, changing	141
Wheel traction control (t RC)	17, 20, 107-109
Window controls	41
Wiper control stalk	99
Wipers	99



Declaration of Conformity (DoC)

Hereby, Panasonic Corporation, declares that this Bluetooth Module ASSY [YEP0PTA605] is in compliance with the essential requirements and other relevant provisions of Directive 1999/5/EC.

The latest original "DECLARATION of CONFORMITY" (DoC) is available at the address below.
<http://www.ptc.panasonic.de/>

(To see the DoC for the product's component, input the product search number: YEP0PTA605)

С настоящото, Рапанасоник Корпорация, декларира, че YEP0PTA605 е в съответствие със съществени те изисквания и другите приложими разпоредби на Директива 1999/5/EC.
Panasonic Corporation tímto prohlašuje, že tento YEP0PTA605 je ve shodě se základními požadavky a dalšími příslušnými ustanoveními směrnice 1999/5/ES.
Undertegnede Panasonic Corporation erklærer herved, at følgende udstyr YEP0PTA605 overholder de væsentlige krav og øvrige relevante krav i direktiv 1999/5/EF.
Hierbij verklaart Panasonic Corporation dat het toestel YEP0PTA605 in overeenstemming is met de essentiële eisen en de andere relevante bepalingen van richtlijn 1999/5/EG.
Hereby, Panasonic Corporation, declares that this YEP0PTA605 is in compliance with the essential requirements and other relevant provisions of Directive 1999/5/EC.
Käesolevaga kinnitab Panasonic Corporation seadme YEP0PTA605 vastavust direktiivi 1999/5/EÜ põhinõuetele ja nimetatud direktiivist tulenevatele teistele asjakohastele sätetele.
Panasonic Corporation vakuuttaa täten että YEP0PTA605 tyyppinen laite on direktiivin 1999/5/EY oleellisten vaatimusten ja sitä koskevien direktiivin muiden ehtojen mukainen.
Par la présente Panasonic Corporation déclare que l'appareil YEP0PTA605 est conforme aux exigences essentielles et aux autres dispositions pertinentes de la directive 1999/5/CE.
Hiermit erkläre Panasonic Corporation, dass sich das Gerät YEP0PTA605 in Übereinstimmung mit den grundlegenden Anforderungen und den übergeneinschlägigen Bestimmungen der Richtlinie 1999/5/EG befindet.
ΜΕ ΤΗΝ ΠΑΡΟΥΣΑ Panasonic Corporation ΔΗΛΩΝΕΙ ΟΤΙ ΥΕΡ0ΡΤΑ605 ΣΥΜΜΟΡΦΩΝΕΤΑΙ ΠΡΟΣ ΤΙΣ ΟΥΣΙΩΔΕΙΣ ΑΠΑΙΤΗΣΕΙΣ ΚΑΙ ΤΙΣ ΛΟΙΠΕΣ ΣΧΕΤΙΚΕΣ ΔΙΑΤΑΞΕΙΣ ΤΗΣ ΟΔΗΓΙΑΣ 1999/5/ΕΚ.
Alulírott, Panasonic Corporation nyilatkozik, hogy a YEP0PTA605 megfelel a vonatkozó alapvető követelményeknek és az 1999/5/EC irányelv egyéb előírásainak.
Con la presente Panasonic Corporation dichiara che questo YEP0PTA605 è conforme ai requisiti essenziali ed alle altre disposizioni pertinenti stabilite dalla direttiva 1999/5/CE.

Ar šo Panasonic Corporation deklarē, ka YEP0PTA605 atbilst Direktīvas 1999/5/EK būtiskajām prasībām un citiem ar to saistītajiem noteikumiem.
Šīuo Panasonic Corporation deklaruoja, kad šis YEP0PTA605 atitinka esminiūs reikalavimus ir kitas 1999/5/EB Direktyvos nuostatas.
Hawnehkk, Panasonic Corporation, jiddikjara li dan YEP0PTA605 jikkonforma mal-htijijiet essenzejali u ma prowedimentit ohrainj relevantit li hemm tid-Dirretiva 1999/5/EC.
Niniejszym Panasonic Corporation oświadcza, że YEP0PTA605 jest zgodny z zasadniczymi wymogami oraz pozostałymi stosownymi postanowieniami Dyrektywy 1999/5/EC.
Panasonic Corporation declara que este YEP0PTA605 está conforme com os requisitos essenciais e outras disposições da Directiva 1999/5/CE.
Prin prezenta, Panasonic Corporation, declara că aparatul YEP0PTA605 este în conformitate cu cerințele esențiale și cu altele prevederi pertinente ale Directivei 1999/5/CE.
Panasonic Corporation týmto vyhlasuje, že YEP0PTA605 splňa základné požiadavky a všetky príslušné ustanovenia Smernice 1999/5/ES.
Panasonic Corporation izjavlja, da je ta YEP0PTA605 v skladu z bistvenimi zahtevami in ostalimi relevantnimi določili direktive 1999/5/ES.
Por medio de la presente Panasonic Corporation declara que el YEP0PTA605 cumple con los requisitos esenciales y cualesquiera otras disposiciones aplicables o exigibles de la Directiva 1999/5/CE.
Härmed intygar Panasonic Corporation att denna YEP0PTA605 står i överensstämmelse med de väsentliga egenskapskrav och övriga relevanta bestämmelser som framgår av direktiv 1999/5/EG.
Hér með lýsir Panasonic Corporation yfir því að YEP0PTA605 er í samræmi við grunnkröfur og aðrar kröfur, sem gerðar eru í tilskipun 1999/5/EC.
Panasonic Corporation erklærer herved at udstyret YEP0PTA605 er i samsvar med de grundlæggende krav og øvrige relevante krav i direktiv 1999/5/EF.
Ovím, Panasonic Corporation, izjavljuje da ovaj YEP0PTA605 je uskladen sa bitnim zahtjevima i drugim relevantnim odredbama Direktive 1999/5/EC.
Nepermyet kesaj, Panasonic Corporation, deklaruj qe ky YEP0PTA605 eshte ne pajtim me kerkesat thebesore dhe dispozitat e tjera perkatese te Direktives 1999/5/EC.
Ovím Panasonic Corporation, izjavljuje da je YEP0PTA605 u skladu s bitnim zahtjevima drugim relevantnim odredbama Direktive 1999/5/EC.
Овим, Panasonic Corporation, изјављује да је овај YEP0PTA605 је у складу са основним захтевима и другим битним одредбама Директиве 1999/5/ЕЦ.

This handbook describes all of the equipment available in the whole range.

Your vehicle will be fitted with some of this equipment described in this document, depending on its trim level, version and the specification for the country in which it is sold.

The descriptions and illustrations are given without any obligation. Automobiles Peugeot reserves the right to modify the technical specifications, equipment and accessories without having to update this edition of the handbook.

This document is an integral part of your vehicle. It should be passed on to the new user in the event of sale or transfer. In addition, there are labels present in your vehicle to warn you of the need for certain precautions to take for your safety; don't remove them, they will be useful again for a new owner.

Automobiles Peugeot declares, by application of the provisions of the European regulation (Directive 2000/53) relating to end of Life Vehicles, that it achieves the objectives set by this regulation and that recycled materials are used in the manufacture of the products that it sells.

Reproduction or translation of all or part of this document is prohibited without written authorisation from Automobiles Peugeot.

For any work on your vehicle, use a qualified workshop that has the technical information, competence and equipment required, which a Peugeot dealer is able to provide.

Printed in the eu



PEUGEOT

Automobiles PEUGEOT - Siège Social : 75, avenue de la Grande-Armée 75016 PARIS

Tél. 33 (0)1 40 66 55 11 - Fax 33 (0)1 40 66 54 14

Adresse postale : Automobiles PEUGEOT B.P. 01 75761 PARIS cedex 16 - Adresse Internet : <http://www.peugeot.com>

Société Anonyme au capital de 172 771 770 Euros - R.C.S. PARIS B 552 144 503. SIRET 552 144 503 00018. APE 341 Z

Anglais

04-14

