

LATITUDE

DRIVER'S HANDBOOK



RENAULT recommends ELF

ELF has developed a complete range of lubricants for RENAULT:

- ▶ engine oils
- ▶ manual and automatic gearbox oils

Warning: to ensure the engine operates optimally, the use of a lubricant may be restricted to certain vehicles. Please refer to your maintenance document.

Benefiting from the research applied to Formula 1, lubricants are very high-tech products.

Updated with the help of RENAULT's technical teams, this range is perfectly compatible with the specific features of the brand's vehicles.

▶ ELF lubricants enhance your vehicle's performance significantly.



RENAULT recommends approved ELF lubricants for oil changes and top-ups.
Contact your RENAULT Dealer or visit www.lubrifiants.elf.com



Une marque de TOTAL

Welcome to your new vehicle

This Driver's Handbook contains the information necessary:

- for you to familiarise yourself with your vehicle, to use it to its best advantage and to benefit fully from all the functions and the technical developments it incorporates.
- to ensure that it always gives the best performance by following the simple, but comprehensive advice concerning regular maintenance.
- to enable you to deal quickly with minor faults not requiring specialist attention.

It is well worth taking a few minutes to read this handbook to familiarise yourself with the information and guidelines it contains about the vehicle and its functions and new features. If certain points are still unclear, our Network technicians will be only too pleased to provide you with any additional information.

The following symbol will help you when reading this handbook:



To indicate a hazard, danger or safety recommendation.

The descriptions of the models given in this handbook are based on the technical specifications at the time of writing. **This handbook covers all items of equipment** (both standard and optional) **available for these models but whether or not these are fitted to the vehicle depends on the version, options selected and the country where the vehicle is sold.**

This handbook may also contain information about items of equipment to be introduced later in the model year.

Throughout the manual, the “approved Dealer” is your RENAULT Dealer.

Enjoy driving your new vehicle.

Translated from English. Copying or translation, in part or in full, is forbidden unless prior written permission has been obtained from the car manufacturer.



C O N T E N T S

Sections

Getting to know your vehicle

1

Driving

2

Your comfort

3

Maintenance

4

Practical advice

5

Technical specifications

6

Alphabetical index

7



Section 1: Getting to know your vehicle

RENAULT card: general information, use, deadlocking	1.2
Doors	1.9
Automatic locking when driving	1.13
Headrests/Seats	1.14
Seat belts.	1.20
Additional method of restraint	1.23
methods of restraint in addition to the front seat belts	1.23
methods of restraint in addition to the rear seat belts	1.27
side protection devices.	1.28
Child safety: general information.	1.30
choosing a child seat mounting	1.33
fitting a child seat	1.35
deactivating/activating the front passenger air bag	1.40
Steering wheel/power-assisted steering	1.43
Driving position	1.44
Control instruments	1.48
Trip computer and warning system	1.53
Vehicle settings customisation menu.	1.62
Clock and exterior temperature	1.63
Rear view mirrors	1.64
Audible and visual signals	1.66
Exterior lighting and signals.	1.67
Headlight beam adjustment.	1.70
Windscreen wash/wipe	1.71
Fuel tank	1.74

RENAULT CARD: general information (1/2)

26787

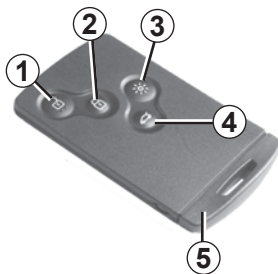

- 1 Unlocking the doors and trunk lid
- 2 Locking all the doors and trunk lid
- 3 Switching on the lighting remotely
- 4 Unlocking/locking the trunk lid
- 5 Integrated key

The RENAULT card is used for:

- locking/unlocking the doors and trunk lid;
- switching on the vehicle lighting remotely (refer to the following pages);
- depending on the vehicle, automatically closing the electric windows and sunroof remotely (see the information on “Electric windows/Electric panoramic sunroof” in Section 3);
- starting the engine (refer to the information on “Starting the engine” in Section 2);

RENAULT card battery life

Make sure that the correct battery type is being used, and that the battery is in good condition and inserted correctly. Its service life is approximately two years: replace it when the message “Low card battery” appears on the instrument panel (refer to the information on the “RENAULT card: Battery” in Section 5).

Note: you can still lock/unlock and start your vehicle, even with a flat battery. Refer to the information on “Locking/unlocking the doors” in Section 1 and “Starting the engine” in Section 2.

Range of the RENAULT card

This varies according to the environment. It is important to make sure when handling the RENAULT card that you do not lock or unlock the doors by inadvertently pressing the buttons.



Driver's responsibility

Never leave your vehicle with the RENAULT card inside and never leave a child (or a pet) unsupervised, even for a short while.

They may pose a risk to themselves or to others by starting the engine, activating equipment such as the electric windows or by locking the doors.

Risk of serious injury.

RENAULT CARD: general information (2/2)

30325

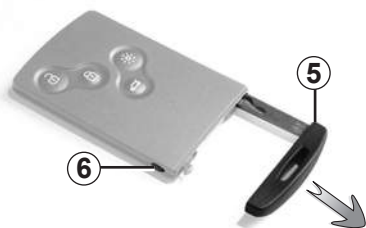

Integrated key 5

The integrated key is used to lock or unlock the front left-hand door if the RENAULT card does not work:

- when the RENAULT card battery is drained, discharged battery, etc.
- use of devices using the same frequency as the card;
- vehicle located in a high electromagnetic radiation zone.

Access to key 5

Press button **6** and pull key **5** then release the button.

Using the key

To use the integrated key, refer to Section 1 “Locking/unlocking the doors”.

Once you have accessed the vehicle using the integrated key, replace it in its housing in the RENAULT card, then insert the RENAULT card into the card reader to start the vehicle.

Advice

Avoid leaving the RENAULT card in hot, cold or humid areas.

Do not store the RENAULT card in an area where it may accidentally become bent or damaged. The RENAULT card may be damaged if it is sat on when placed in the back pocket of a garment.

Replacement: need for an additional RENAULT card

If you lose your RENAULT card or require another, you can obtain one from an approved dealer.

If a RENAULT card is replaced, it will be necessary to take the vehicle and **all of its RENAULT cards** to an approved dealer to initialise the system.

You can use up to four RENAULT cards per vehicle.

REMOTE CONTROL RENAULT CARD: use

26787

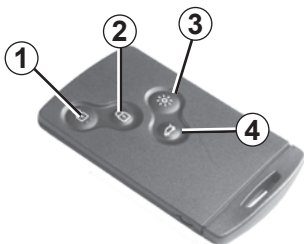

Unlocking the doors and trunk lid

Press unlocking button **1**.

The hazard warning lights **flash once** to indicate that the doors have been unlocked.

Locking the doors and trunk lid

Press locking button **2**.

The hazard warning lights **flash twice** to indicate that the doors have locked. If a door or the luggage compartment is open or not properly closed, or if a RENAULT card is still in the reader, the doors and luggage compartment lock then quickly unlock and the hazard warning lights **do not flash**.

Unlocking/locking the trunk lid only

Press button **4** to unlock or lock the trunk lid.

The flashing status of the hazard warning lights informs you of the vehicle status:

- **one flash** indicates that the vehicle is unlocked;
- **two flashes** indicates that the vehicle is locked.

Distance lighting function

This can, for example, identify the vehicle from a distance when parked in a car park.

The dipped beam headlights, side lights and interior lights come on for approximately 30 seconds when button **3** is pressed.

Note: pressing button **3** again switches off the lighting.

RENAULT card non-detection alarm

The message “Keycard not detected” and a beep will warn you if you open a door with the engine running and the card is not in the reader. The warning disappears when the card is inserted in the reader again.

The card buttons are deactivated when the engine is running.

HANDS-FREE RENAULT CARD: use (1/3)



30158

Use

On equipped vehicles, in addition to the functions of the remote control RENAULT card, it can be used to lock and unlock without using the RENAULT card, when it is in access zone **1**.

Note: Ensure that the RENAULT card is not in contact with other electronic equipment (computer, PDA, phone, etc.) as this could hinder its operation.

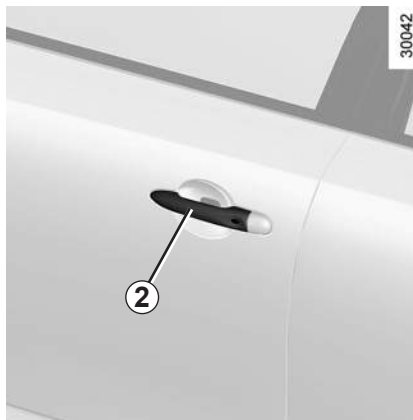

30042

Unlocking the vehicle

With the RENAULT card in zone **1**, you may unlock the vehicle by placing your hand in door handle **2**; the vehicle will unlock (in some cases, you may need to pull door handle **2** twice to unlock the vehicle and open the door).

Pressing button **3** also unlocks all the doors and the trunk lid.

The hazard warning lights **flash once** to indicate that the doors have been unlocked.

Note: if no door is opened within a few minutes of the vehicle being unlocked by pressing the locking/unlocking button on the RENAULT card, the doors will automatically relock.

30240

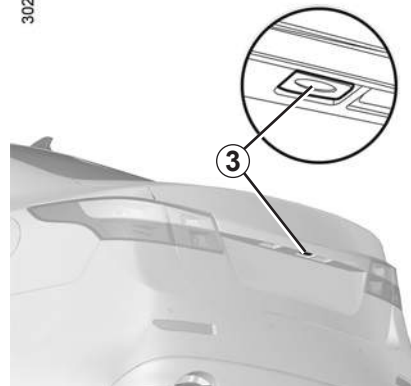

Note: if the RENAULT card is inside the luggage compartment, the vehicle locks/unlocks quickly. Ensure that you always have the RENAULT card on your person, as the vehicle may not unlock if there is any wavelength interference.

HANDS-FREE RENAULT CARD: use (2/3)

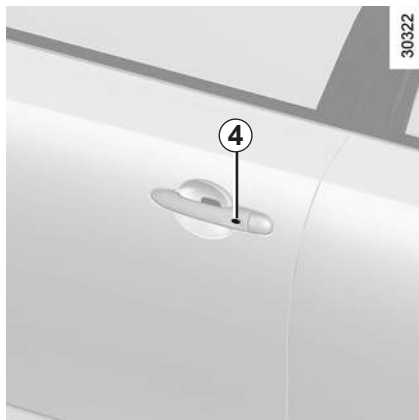

Locking the vehicle

There are three ways to lock the vehicle: remotely, using button **4**, or using the RENAULT card.

Remote locking

With the RENAULT card on you, and doors and trunk lid closed, move away from the vehicle: it will lock automatically once you have left zone **1**.

Note: the distance at which the vehicle locks depends on the surroundings.

The hazard warning lights flash twice and a beep sounds to indicate that the doors have locked.

The beep may be switched off. Consult an approved Dealer.



If a door or the trunk lid is open or not properly closed, or a card is in the passenger compartment (or the card reader) the vehicle will not lock. In this situation, **no beep sounds and the hazard warning lights do not flash.**

Locking using button **4**

With the doors and trunk lid closed and the RENAULT card on you, press button **4** on the front door handle. The vehicle will lock.

If a door or the trunk lid is open or not properly closed, or if a RENAULT card is in the card reader, the doors or trunk lid will not lock and the hazard warning lights will not flash, even if button **4** is pressed.

Note: The RENAULT card must be within the vehicle's access zone **1** to be able to lock the vehicle using the button.

Special note:

If you wish to check that the doors are locked after locking with button **4**, you have approximately **three** seconds to try the door handles without unlocking them.

After this time, the "hands-free" mode is activated once again and any movement of a handle will unlock the vehicle.

Access zone **1**, in which the vehicle locks, depends on the surroundings. It is important to make sure when handling the RENAULT card that you do not lock or unlock the doors by inadvertently pressing the buttons.

HANDS-FREE RENAULT CARD: use (3/3)



Locking the vehicle (continued)

Locking using the RENAULT card

With the doors and trunk lid closed, press button **5**. The vehicle will lock. The hazard warning lights **flash twice** to indicate that the doors have locked.

Note: the maximum distance at which the vehicle locks depends on the surroundings.



Special note:

The vehicle will not lock if:

- a door or the trunk lid is open or not properly closed;
- a card is still in zone **6** (or in the card reader) and no other card is in the external detection zone.

Even if the RENAULT card is still in zone **6**, the vehicle may lock if it is close to any (metal) object which is capable of causing wavelength interference.

With the engine running, if, after having opened and closed a door, the card is no longer in the passenger compartment, the message “Keycard not detected” (accompanied by a beep when the speed passes a certain level) warns you that the card is no longer in the vehicle. This prevents you driving away after having dropped off a passenger who has the card, for example. The warning disappears when the card is detected again.

After locking/unlocking the vehicle or the luggage compartment only using the buttons on the RENAULT card, remote locking and unlocking in hands-free mode are deactivated.

To reactivate the “hands-free” mode: restart the vehicle.

RENAULT CARD: deadlocking

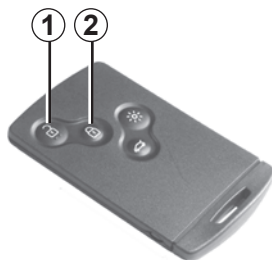

26787

If the vehicle is equipped with a deadlocking function, this allows you to lock the opening elements and to prevent the doors from being unlocked using the interior handles (for example, by breaking the window and then trying to open the door from the inside).



Never use deadlocking if someone is still inside the vehicle.

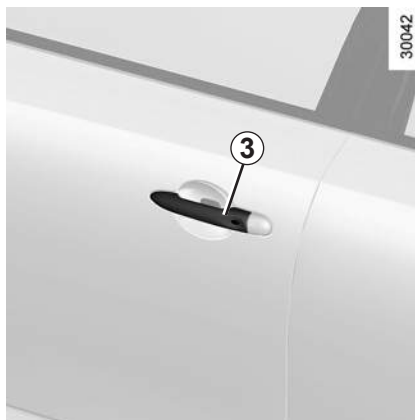

30042

To activate deadlocking

You can choose between two deadlocking activation modes:

- press button **2** twice in quick succession;
- or, press the button on the driver's door handle **3** twice in quick succession.

The hazard warning lights flash **five** times to indicate locking.

To deactivate deadlocking

Unlock the vehicle using button **1** on the RENAULT card.

The hazard warning lights flash once to indicate that the doors have been unlocked.

Activating deadlocking also remotely closes the windows and/or the electric sunroof, on equipped vehicles.

After activating the deadlocking function using button **2**, remote locking and unlocking in hands-free mode are deactivated.

To reactivate the “hands-free” mode: restart the vehicle.

OPENING AND CLOSING THE DOORS (1/2)

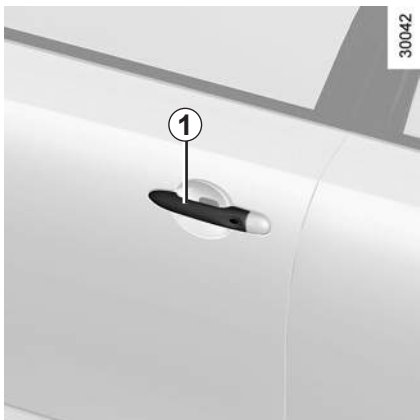

Opening from the outside

With the doors unlocked, hold handle **1** and pull it towards you.

In some cases, it may be necessary to pull the handle twice to open the door.

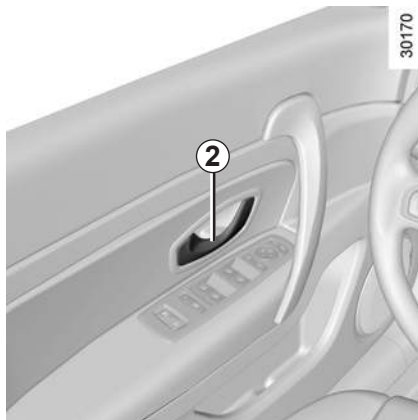

Opening from the inside

Pull handle **2**.

Note: with the doors locked, if you pull the door handle, the door will be opened and the other doors will be unlocked.

Lights on reminder buzzer

If you have switched off the ignition and left the lights switched on, a reminder buzzer will sound when a door is opened.

Card reminder buzzer

A beep will let you know if you have left the card in the reader when you open the driver's door, and the "Please remove keycard" message will appear on the instrument panel.

Special features

After switching off the engine, the lights and any accessories that are in operation (radio, etc.) will continue to operate. They stop after the driver's door is opened or all the doors and trunk lid are locked from the outside.

With the engine switched off, insert the RENAULT card in the reader to allow some of the electrical functions to operate.

Door/trunk lid open buzzer

If a door (or trunk lid) is open or not properly closed, as soon as the vehicle reaches a speed of approximately 12 mph (20 km/h) the message "Door open" or "Boot open" (depending on which is open) will appear on the instrument panel accompanied by a warning light.

OPENING AND CLOSING THE DOORS (2/2)

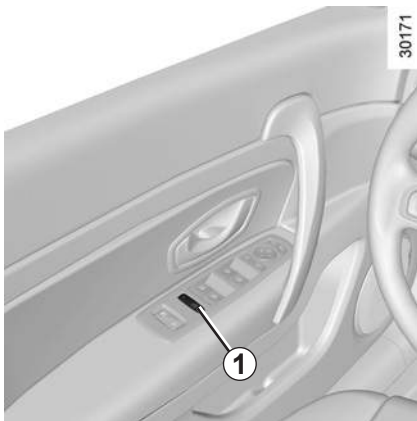

Child safety



Vehicle with switch 1

Press switch **1** to authorise opening of the rear doors. If the vehicle is equipped with electric rear windows, this action will also authorise their use.

The indicator light in the switch lights up to confirm that the child safety function is activated.



Safety of rear occupants

The driver can authorise operation of the rear doors and, depending on the vehicles, the electric windows by pressing switch **1** on the side with the illustration.

Depending on the vehicle, in the event of a fault:

- a beep sounds;
- a message is displayed on the instrument panel;
- the integrated indicator does not light up.

If the battery has been disconnected, press switch **1** on the side with the symbol, to lock the rear doors.



Driver's responsibility when parking or stopping the vehicle

Never leave an animal, child or adult who is not self-sufficient alone on your vehicle, even for a short time.

They may pose a risk to themselves or to others by starting the engine, activating equipment such as the electric windows or by locking the doors.

Also, in hot and/or sunny weather, please remember that the temperature inside the passenger compartment increases very quickly.

Risk of death or serious injury.

LOCKING AND UNLOCKING THE DOORS (1/2)

Locking/unlocking the doors from the outside

This is done using the RENAULT Card; see the “RENAULT Card” information in Section 1.

In certain cases, the RENAULT card may not work, or its access area will be modified:

- if the RENAULT card battery is weak, flat, etc.
- if equipment operating on the same frequency as the card (mobile phones, etc.) is used;
- vehicle located in a high electromagnetic radiation zone.

It is then possible:

- to use the key integrated into the RENAULT card to unlock the front left-hand door;
- to lock each of the doors manually;
- to use the interior door locking/unlocking control (refer to the following pages).

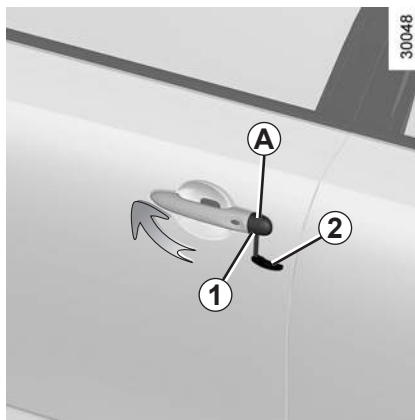

Using the integrated key

- Pull out the integrated key (refer to the “RENAULT card: general information” section).
- insert the end of integrated key **2** in slot **1** then make a movement upwards to remove cover **A** behind which you will find a lock.
- insert the key into the lock in the front left-hand door and lock or unlock.



Locking the doors manually

Turn screw **3** with the door open (using the end of the key) and close the door.

This means that the doors are then locked from the outside.

The doors may then only be opened from the inside or by using the key in the front left-hand door.

LOCKING AND UNLOCKING THE DOORS (2/2)



Interior locking/unlocking door control

Switch **4** simultaneously controls the doors and the trunk lid.

If a door or the trunk lid is open or not closed properly, after pressing switch **4**, the doors and trunk lid lock/unlock quickly.

If you need to transport objects with the trunk lid open, you can still lock the doors. With the engine switched off, remove the RENAULT card from the reader then press and hold switch **4** for more than 5 seconds.

Locking the doors without the RENAULT card

For example, in the event of a discharged battery or the RENAULT card temporarily not working, etc.

With the engine switched off and a door or trunk lid open, press and hold switch **4** for more than five seconds to lock all the doors and the trunk lid.

When the door is closed, all the doors and the trunk lid will be locked.

Check by pulling the door handles that all the doors are locked.

Unlocking the vehicle from the outside will only be possible with the RENAULT card in the vehicle's access zone or using the key integrated in the RENAULT card.

Doors and trunk lid status indicator light

Switch **4** has an integrated indicator light which shows whether or not the doors and trunk lid are locked:

- indicator light on, the doors and trunk lid are locked,
- indicator light off, the doors and trunk lid are unlocked.

When you lock the vehicle from the outside, the indicator light remains lit for approximately one minute, then goes out.



Driver's responsibility

Never leave your vehicle with the RENAULT card inside.



If you decide to keep the doors locked when you are driving, remember that it may be more difficult for the emergency services to gain access to the passenger compartment in the event of an emergency.

After locking/unlocking the vehicle or the luggage compartment only using the buttons on the RENAULT card, remote locking and unlocking in hands-free mode are deactivated.

To reactivate the hands-free mode: restart the vehicle.

AUTOMATIC LOCKING WHEN DRIVING

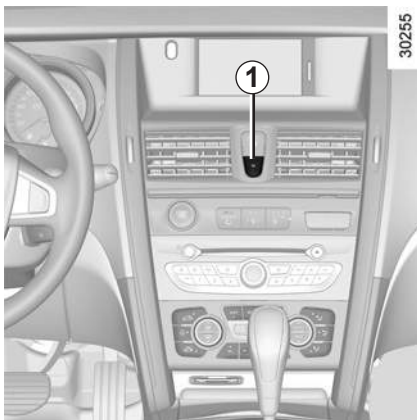

Operating principle

After the vehicle is started, the system automatically locks the doors once your speed reaches approximately 6 mph (10 km/h) and over.

The door can be unlocked:

- by pressing door unlocking button **1**.
- when stationary, by opening the driver's door.

Note: if a door is unlocked, it will automatically lock again when the vehicle reaches a speed of 6 mph (10 km/h).

Activating/deactivating the function

Refer to the information on “Vehicle settings customisation menu” in Section 1; “Auto door locking while driving” function:



: function activated.



: function deactivated.

Operating faults

If you experience an operating fault (no automatic locking, the indicator light incorporated in button **1** does not light up when trying to lock the doors and trunk lid, etc.), firstly check that the doors and trunk lid are properly closed. If they are properly closed, contact an approved dealer.



Driver's responsibility

If you decide to keep the doors locked when you are driving, remember that it may be more difficult for those assisting you to gain access to the passenger compartment in the event of an emergency.

FRONT HEADRESTS

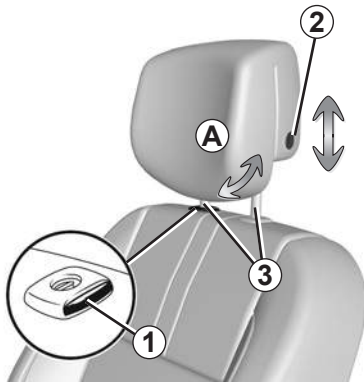

30238

To raise the headrest

Pull the headrest upwards to the desired height.

To lower the headrest

Raise the headrest slightly, then press tab **2** and lower it to the required height.

To adjust the angle of the headrest

Depending on the vehicle, tilt section **A** towards or away from you to the required position.

To remove the headrest

Lift the headrest to its highest position. Press button **1** and lift the headrest to release it (tilt the seatback backwards if necessary).

Note: when the headrest is removed, take care not to change the positions of rods **3**.

To refit the headrest

Pull out the headrest rods **3** as far as possible by pulling from the top. Take care to ensure they are clean and correctly aligned and, if there are any problems, check that the notches are facing forwards.

Insert the headrest rods into the holes (tilt the seatback backwards if necessary).

Lower the headrest until it locks, press button **1** and lower the headrest as far as possible.

Check that each headrest rod **3** is securely locked in the seatback by trying to pull them up or push them down.

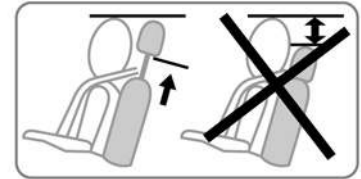

26342



The headrest is an important safety component: ensure that it is in place and in the correct position. The distance between your head and the headrest and the distance between the head and section **A** should be as small as possible.

FRONT SEATS (1/2)



Front seats with electric control

To move the seat forwards or back
Move switch **2** forwards or backwards.

To raise or lower the seat base
Move the rear of switch **2** upwards or downwards.

To raise or lower the front of the seat base
(depending on the vehicle)

Move the front of switch **2** upwards or downwards.

To tilt the seatback

Move the top of button **3** forwards or backwards.

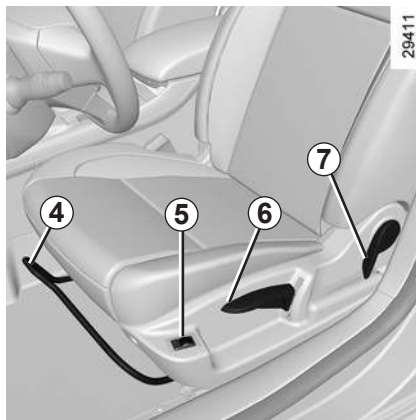

Front seats with manual control

To move the seat forwards or back
Lift handle **4** and simultaneously move the seat base forwards or backwards. When in the desired position, release the handle. Ensure it is correctly locked in place.

To raise or lower the seat base (driver's seat)

Move lever **6** as many times as necessary upwards or downwards to raise or lower the seat base.

To tilt the seatback

Lift lever **7** and simultaneously adjust the seatback. When in the desired posi-

tion, release the lever. Ensure it is correctly locked in place.

Heated seats

With the engine running, turn control **1** or **5** to the desired position, depending on the temperature required. An  indicator light on the instrument panel comes on once one of the front seat heating system is operating.

The system, which has a thermostat, decides whether heating is needed depending on the position selected and stops heating once a certain temperature has been reached.

Turn control **1** or **5** to position **0** to stop the function.

FRONT SEATS (2/2)

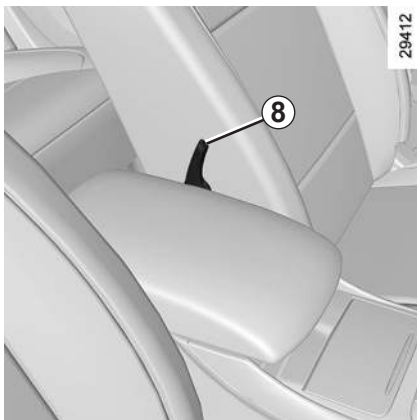

Adjusting the lumbar support on the driver's seat

(depending on the vehicle)

Lower handle **8** to increase the support and lift to decrease it. Depending on the vehicle, you may adjust the electrically-controlled support. Refer to the information on the "Driver's seat with massage function" in Section 1.



For safety reasons, carry out any adjustments when the vehicle is not being driven.

We would advise you not to recline the seatbacks too far to ensure that the effectiveness of the seat belts is not reduced.

Nothing should be placed on the floor (area in front of driver) as such objects may slide under the pedal during braking manoeuvres, thus obstructing its use.

DRIVER'S SEAT WITH POSITION MEMORY (1/2)

Depending on the vehicle, it is possible to store **three driving positions**.

A driving position includes the settings for the driver's seat base and seatback and the door mirrors.

Operation

The storage of the driving position and the recall of the driving position by pressing the buttons are possible:

- with the “hands-free” RENAULT card detected or, depending on the vehicle, the RENAULT card in the card reader;
- when the driver's door is opened.

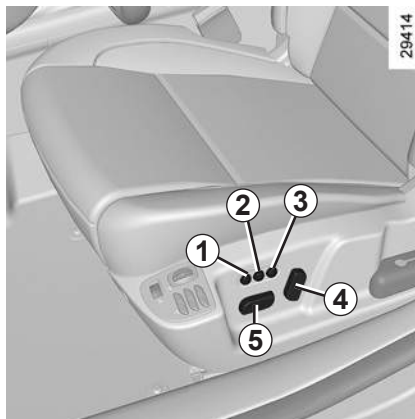

Storing your driving position

Adjust the seat using switches **4** and **5** (see previous pages).

Adjust the door mirrors (refer to the information on “Rear view mirrors” in Section 1).

Adjust the angle of the rear view mirrors for reversing (refer to the information on the “Rear view mirrors” in Section 1).

Press button **1**, **2** or **3** until you hear a beep: the driving position (seat and door mirrors) is stored. To store other driving positions, repeat this procedure for each of buttons **1**, **2** and **3**.

Recalling a stored driving position

With the vehicle stationary, briefly press button **1**, **2** or **3** depending on the required stored driving position.

Note: recall of the stored driving position is interrupted if one of the seat adjustment buttons is pressed during recall.

When driving, it is not possible to recall a driving position.

DRIVER'S SEAT WITH POSITION MEMORY (2/2)

Driver's seat with easy access

This system allows the driver to access the driver's seat more easily, as the seat automatically moves forwards or backwards.

The seat moves backwards:

- with the engine off, when the driver's door is opened;
- with the driver's door open, when the engine is switched off.

The seat returns to the normal position:

- with the engine started;
- when the RENAULT card is inserted in the card reader;
- by pressing the engine Start/Stop switch, without depressing the pedal (if there is a "hands-free" RENAULT card).

Note: to deactivate the system, refer to the information on the "Vehicle settings customisation menu" in Section 1.

Activating/deactivating the function

Refer to the information on the "Vehicle settings personalisation menu" in Section 1; "Driver easy access" function:



: function activated



: function deactivated.

DRIVER'S SEAT WITH MASSAGE FUNCTION

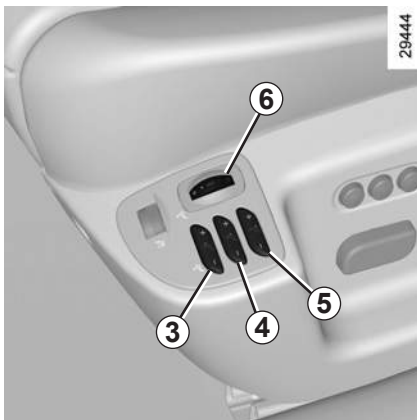

Adjusting the lumbar support on the driver's seat

You can increase or reduce the support by pressing the (+) or (-) button on switch **3/4/5** for the top, middle and bottom of the lumbar support respectively.

- Take care not to damage the seatback with sharp objects. The air tubes incorporated in the seatback may also be damaged.
- In the event of prolonged use of the massage function, you may start to feel uncomfortable.

Driver's seat with massage function

When the engine is running, you may use the massage function. If you start the system, the air pressure drops completely and the massage function starts running one minute later. The massage cycle is approximately 10 minutes and the break time is 10 seconds between two cycles.

Note: Three massage cycles in a row are followed by a 15 minute break to prevent the system from overheating.

Operation

The air tubes in the seatback will operate according to each mode by turning control **6** to the desired mode:

 : **Mode 2**

Operating in order from bottom air tube.

 : **Mode 1**

Operating softly in order from bottom air tube.

 : **Random Mode 1**

Operating softly at random.

 : **Random Mode 2**

Operating at random.

Note: if you change mode, the new mode selected replaces the current mode.

Stopping the function

- Turn control **6** to the **OFF** position.
 - When you restart the system after having stopped it, the air pressure drops completely before the massage function can start running.
 - With the massage function stopped, if you wish to use the lumbar support device wait until the air pressure has dropped completely.
- Stop the engine.

Note: If the massage function is running, you cannot use the support device at the same time.



For safety reasons, avoid making any adjustments when driving. The driver must always be alert to sudden events which may occur when driving.

SEAT BELTS (1/3)

Always wear your seat belt when traveling in your vehicle. You must also comply with the legislation of the particular country you are in.

Make sure that the rear bench seat is locked in position correctly so that the rear seat belts will operate efficiently. Refer to Section 3 “Rear bench seat”.



Seat belts which are incorrectly adjusted or twisted may cause injuries in the event of an accident.

Use one seat belt per person, whether child or adult.

Even pregnant women should wear a seat belt. In this case, ensure that the lap belt is not exerting too much pressure on the abdomen, but do not allow any slack.

Before starting, adjust your driving position and then have each occupant adjust their seat belt to ensure optimum protection.

Adjusting your driving position

- **Sit well back in your seat (having first removed your coat or jacket).** This is essential to ensure your back is positioned correctly.
- **adjust the distance between the seat and the pedals.** Your seat should be as far back as possible while still allowing you to depress the brake pedal fully. The seatback should be adjusted so that your arms are slightly bent when you hold the steering wheel;
- **adjust the position of your headrest.** To ensure the highest level of safety, the top of the headrest should be as close as possible to the top of the head;
- **adjust the height of the seat.** This adjustment allows you to select the seat position which offers you the best possible view.
- **adjust the position of the steering wheel.**

13622



Adjusting the seat belts

Sit with your back firmly against the seatback.

Shoulder strap **1** must be as close as possible to the base of the neck. It must not in any case rest on the neck.

Lap belt **2** should be worn flat over the thighs and against the pelvis.

The seat belt should be worn as close to your body as possible; avoid wearing clothes that are too thick, or holding any objects that could obstruct the seat belt, for example.

SEAT BELTS (2/3)

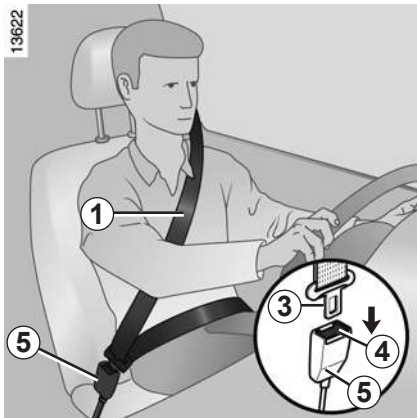

Locking

Slowly pull the belt from the inertia reel and push buckle **3** into catch **5** until you hear a click (check that the belt is secure by pulling buckle **3**). If the seat belt locks and refuses to unwind enough to be buckled, pull firmly on the belt and then release it. Then try again. If the seat belt locks and refuses to return, pull 3 cm of the belt out slowly, then release it. It will retract automatically. Then gently pull the seat belt out of the inertia reel.

If there is still a problem, contact an approved dealer.



Front seat belt reminder warning light

This lights up on the central display when the engine is started then, if the driver's or front passenger's seat belt (if this seat is occupied) is not fastened and the vehicle has reached approximately 12 mph (20 km/h), it flashes and a beep sounds for around 120 seconds. Afterwards, just the warning light is on.

Note: an object placed on the passenger seat base may activate the warning light in some cases.

Rear seat belt reminder (depending on the vehicle)

The number of rear seat belts fastened appears on the instrument panel for approximately 30 seconds each time:

- the vehicle is started;
- a door is opened;
- a rear seat belt is fastened or unfastened.

Check that the rear passengers are wearing seat belts and that the number of seat belts shown as fastened corresponds to the number of rear bench seats occupied.

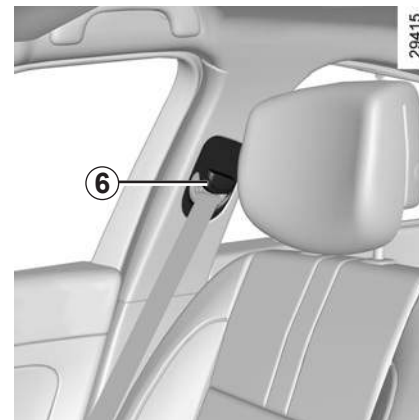

Adjusting the front seat belt height

Press button **6** to adjust the seat belt height so that shoulder strap **1** is worn as shown previously:

- to lower the seat belt, push button **6** and lower the seat belt simultaneously;
- to raise the seat belt, push button **6** upwards.

Make sure that the seat belt is locked in position correctly after you have adjusted it.

SEAT BELTS (3/3)

13622



Unfastening

Press button **4** on catch **5** while pulling the buckle. Pull the seat belt gently. Do not release the seat belt; the belt may retract very quickly to the original position.

The following information applies to the vehicle's front and rear seat belts.



- No modification may be made to the component parts of the restraint system (belts and seats and their mountings) fitted originally.
- For special operations (e.g.: fitting child seats) contact an approved Dealer.
- Do not use devices which allow any slack in the belts (e.g. clothes pegs, clips, etc.): a seat belt which is worn too loosely may cause injury in the event of an accident.
- Never wear the shoulder strap under your arm or behind your back.
- Never use the same belt for more than one person and never hold a baby or child on your lap with your seat belt around them.
- The belt should never be twisted.
- Following an accident, have the seat belts checked and replaced if necessary. Always replace your seat belts as soon as they show any signs of wear.
- When putting back the rear bench seat, take care that the seat belts are correctly positioned so that they can be used properly.
- Make sure that the buckle is inserted into the appropriate catch.

METHODS OF RESTRAINT IN ADDITION TO THE FRONT SEAT BELTS (1/4)

Depending on the vehicle, they may comprise:

- seat belt inertia reel pretensioners;
- lap belt pretensioners;
- chest-level load limiters;
- air bags for driver and front passenger.

These systems are designed to act independently or together when the vehicle is subjected to a frontal impact.

Depending on the severity of the impact, the system can trigger:

- seat belt locking;
- the seat belt inertia reel pretensioner (which engages to correct seat belt slack);
- the lap seat belt pretensioners to hold the occupant in his seat;
- the low volume front air bag;
- the large volume front air bag.

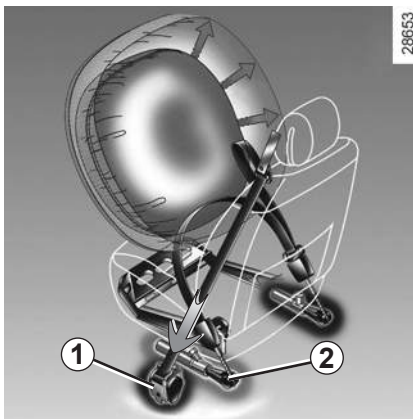

Pretensioners

The pretensioners, which instantly retract the seat belt, hold the occupant more securely against the seat, thus increasing the seat belt's efficiency.

In the event of a severe frontal impact and if the ignition is switched on, the system may engage the following depending on the force of the impact:

- seat belt inertia reel pretensioner **1** which instantly retracts the seat belt.
- piston **2** on the front seats.



– Have the entire restraint system checked following an accident.

– No operation whatsoever is permitted on any part of the system (pretensioners, air bags, computers, wiring) and the system components must not be reused on any other vehicle, even if identical.

– To avoid incorrect triggering of the system which may cause injury, only qualified personnel from an approved dealer may work on the pretensioner and air bag system.

– The electric trigger system may only be tested by a specially trained technician using special equipment.

– When the vehicle is scrapped, contact an approved dealer for disposal of the pretensioner and air bag gas generators.

METHODS OF RESTRAINT IN ADDITION TO THE FRONT SEAT BELTS (2/4)

Load limiters

Above a certain level of impact force, this mechanism is used to limit the force of the belt against the body so that it is at an acceptable level.

Air bags for driver and front passenger

The driver's air bag is on the steering wheel, and the passenger's air bag on dashboard **A**.

An "SRP AIR BAG" marking on the steering wheel and the dashboard (air bag area **B**) indicates that this device is fitted.

Each air bag system consists of:

- an air bag and gas generator fitted on the steering wheel for the driver and in the dashboard for the front passenger;
- an electronic unit for intelligent system monitoring which controls the electrical trigger system and the gas generator;
- an air bag warning light on the instrument panel ;
- remote sensors for the device.

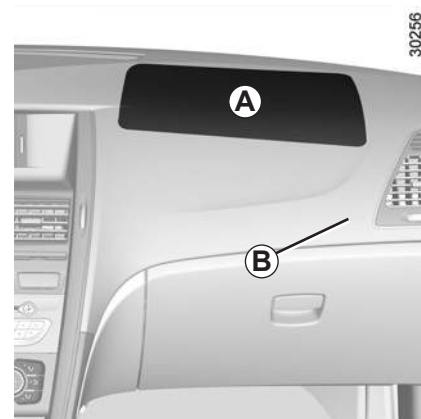

The air bag system uses pyrotechnic principles. This explains why, when the air bag inflates, it will generate heat, produce smoke (this does not mean that a fire is about to start) and make a noise upon detonation. In a situation where an air bag is required, it will inflate immediately and this may cause some minor, superficial grazing to the skin or other problems.

METHODS OF RESTRAINT IN ADDITION TO THE FRONT SEAT BELTS (3/4)

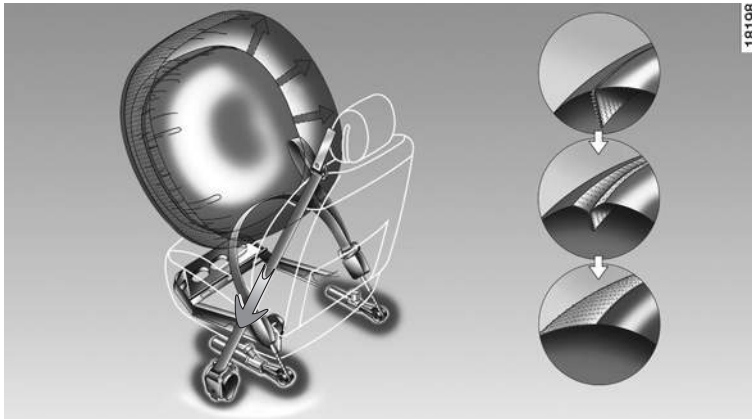

Operation

This system is only operational when the ignition is switched on.

In a severe **frontal** impact, the air bags inflate rapidly. This cushions the impact of the driver's head and chest against the steering wheel and of the front passenger against the dashboard.

The air bags then deflate immediately so that the passengers are not in any way hindered from leaving the vehicle.

Special features of the front air bag

After a violent impact, it has two deployment volumes and integrates a ventilation system:

- low volume air bag, this is the first stage of operation;
- large volume air bag: the air bag seams tear so that a greater volume of gas is released into the air bag (for the most severe impacts).

METHODS OF RESTRAINT IN ADDITION TO THE FRONT SEAT BELTS (4/4)

All of the warnings below are given so that the air bag is not obstructed in any way when it is inflated and also to prevent the risk of serious injuries caused by items which may be dislodged when the air bag inflates.



Warnings concerning the driver's air bag

- Do not modify the steering wheel or the steering wheel boss.
- Do not cover the steering wheel boss under any circumstances.
- Do not attach any objects (badge, logo, clock, telephone holder, etc.) to the steering wheel boss.
- The steering wheel must not be removed (except by qualified personnel from our Network).
- When driving, do not sit too close to the steering wheel. Sit with your arms slightly bent (see the information on “Adjusting your driving position” in Section 1). This will allow sufficient space for the air bag to deploy correctly and be fully effective.

Warnings concerning the passenger air bag

- Do not attach or glue any objects (badge, logo, clock, telephone holder, etc.) to the dashboard on or near the air bag.
- Do not place anything between the dashboard and the passenger (pet, umbrella, walking stick, parcels, etc.).
- The passenger must not put his or her feet on the dashboard or seat as there is a risk that serious injuries may occur. In general, parts of the body should be kept away from the dashboard (knees, hands, head, etc.).
- The devices in addition to the front passenger seat belt should be reactivated as soon as a child seat is removed, to ensure the protection of the passenger in the event of an impact.

A REAR-FACING CHILD SEAT MUST NOT BE FITTED TO THE FRONT PASSENGER SEAT UNLESS THE ADDITIONAL RESTRAINT SYSTEMS, I.E. THE PASSENGER AIR BAG, ARE DEACTIVATED.

(refer to Section 1 “Child safety: deactivating/activating the front passenger air bag”)

METHODS OF RESTRAINT IN ADDITION TO THE REAR SEAT BELTS

Depending on the vehicle, they are composed of:

- **seat belt pretensioners built into the inertia reels,**
- **force limiter.**

These systems are designed to act independently or together when the vehicle is subjected to a frontal impact.

There are two possibilities, depending on the force of the impact:

- protection is provided by the seat belt only;
- the pretensioner is triggered to rectify seat belt slack.

Rear seat belt pretensioners

This system is only operational when the ignition is switched on.

If the vehicle is subjected to a severe **frontal** impact, a device retracts the seat belt, pulling the seat belt tight against the body and thus improving its effectiveness.



– Have the entire restraint system checked following an accident.

– No operation whatsoever is permitted on any part of the system (pretensioners, air bags, computers, wiring) and the system components must not be reused on any other vehicle, even if identical.

- To avoid incorrect triggering of the system which may cause injury, only qualified personnel from an approved dealer may work on the pretensioner and air bag system.
- The electric trigger system may only be tested by a specially trained technician using special equipment.
- When the vehicle is scrapped, contact an approved dealer for disposal of the pretensioner and air bag gas generators.

Force limiter

Above a certain severity of impact, this mechanism is used to limit the force of the belt against the body so that it is at an acceptable level.

SIDE PROTECTION DEVICES

Side air bags

These air bags are fitted to each front seat and, depending on the country, the rear side seats; the air bags are activated at the sides of the seats (door side) to protect the occupants in the event of a severe side impact.

Curtain air bags

These are air bags fitted along the sides of the vehicle in the ceiling which trigger along the front and rear side windows to protect the passengers in case of a severe side impact.



Warnings concerning the side air bag

- **Fitting seat covers:** seats equipped with an air bag require covers specifically designed for your vehicle. Contact an approved Dealer to find out if these covers are available. The use of any covers other than those designed for your vehicle (including those designed for another vehicle) may affect the operation of the air bags and reduce your protection.
- Do not place any accessories, objects or even pets between the seatback, the door and the internal fittings. Do not cover the seatback with any items such as clothes or accessories. This may prevent the air bag from operating correctly or cause injury when the air bag is deployed.
- No work or modification whatsoever may be carried out on the seat or internal fittings, except by qualified personnel from an approved dealer.

ADDITIONAL METHODS OF RESTRAINT

All of the warnings below are given so that the air bag is not obstructed in any way when it is inflated and also to prevent the risk of serious injuries caused by items which may be dislodged when the air bag inflates.



The air bag is designed to complement the action of the seat belt. Both the air bags and seat belts are integral parts of the same protection system. It is therefore essential to wear seat belts at all times. If seat belts are not worn, the occupants are exposed to the risk of serious injury in the event of an accident. It may also increase the risk of minor superficial injuries occurring when the air bag is deployed, although such minor injuries are always possible with air bags.

If the vehicle should overturn or suffer a rear impact, however severe, the pretensioners and air bags are not always triggered. Shocks to the underbody of the vehicle, e.g. from pavements, potholes or stones, can all trigger these systems.

- No work or modification whatsoever may be carried out on any part of the air bag system (air bags, pretensioners, computer, wiring harness, etc.), except by qualified personnel from an approved dealer.
- To ensure that the system is in good working order and to avoid accidental triggering of the system which may cause injury, only qualified Network personnel may work on the air bag system.
- As a safety precaution, have the air bag system checked if your vehicle has been involved in an accident, or is stolen or broken into.
- When selling or lending the vehicle, inform the user of these points and hand over this driver's handbook with the vehicle.
- When scrapping your vehicle, contact your approved dealer for disposal of the gas generator(s).



Operating faults

Air bag indicator light **1** will light up on the instrument panel when the ignition is switched on and then go out after a few seconds.

If it does not light up when the ignition is switched on, or lights up while the engine is running, there is a fault in the system (air bags, pretensioners, etc.) in the front and/or rear seats.

In this case, stop the vehicle in a safe area and consult an approved dealer as soon as possible. Your protection will be reduced until this fault is rectified.

CHILD SAFETY: general information (1/2)

Carrying children

Children, and adults, must be correctly seated and strapped in for all journeys. The children being carried in your vehicle are your responsibility.

A child is not a miniature adult. Children are at risk of specific injuries as their muscles and bones have not yet finished growing. The seat belt alone would not provide suitable protection. Use an approved child seat and ensure you use it correctly.



To prevent the doors being opened, use the “Child safety” device (refer to the information on “Opening and closing the doors” in Section 1).



A collision at 30 mph (50 km/h) is the same as falling a distance of 10 metres.

Transporting a child without a restraint is the equivalent of allowing him or her to play on a fourth-floor balcony without railings.

Never travel with a child held in your arms. In the event of an accident, you will not be able to keep hold of the child, even if you yourself are wearing a seat belt.

If your vehicle has been involved in a road accident, replace the child seat and have the seat belts and ISOFIX fittings checked.



Driver's responsibility when parking or stopping the vehicle

Never leave an animal, child or adult who is not self-sufficient alone on your vehicle, even for a short time.

They may pose a risk to themselves or to others by starting the engine, activating equipment such as the electric windows or by locking the doors.

Also, in hot and/or sunny weather, please remember that the temperature inside the passenger compartment increases very quickly.

Risk of death or serious injury.

CHILD SAFETY: general information (2/2)

Using a child seat

The level of protection offered by the child seat depends on its ability to restrain your child and on its installation. Incorrect installation compromises the protection it offers the child in the event of harsh braking or an impact.

Before purchasing a child seat, check that it complies with the regulations for the country you are in and that it can be fitted in your vehicle. Consult an approved dealer to find out which seats are recommended for your vehicle.

Before fitting a child seat, read the manual and respect its instructions. If you experience any difficulties during installation, contact the manufacturer of the equipment. Keep the instructions with the seat.

Set a good example by always fastening your seat belt and teaching your child:

- to strap themselves in correctly.
- to always get in and out of the car at the kerb, away from busy traffic.

Do not use a second-hand child seat or one without an instruction manual.

Check that there are no objects in the vicinity of the child seat which could impede its operation.



Never leave a child unattended in the vehicle.

Check that your child is always strapped in and that the belt or safety harness used is correctly set and adjusted. Avoid wearing bulky clothing which could cause the belts to slacken. Never let your child put their head or arms out of the window. Check that the child is in the correct position for the entire journey, especially if asleep.

CHILD SAFETY: choosing a child seat



31235

Rear-facing child seats

A baby's head is, proportionally, heavier than that of an adult and its neck is very fragile. Transport the child in this position for as long as possible (until the age of 2 at the very least). It supports both the head and the neck.

Choose a bucket type seat for best side protection and change it as soon as the child's head is higher than the shell.



31233

Forward-facing child seats

The child's head and abdomen need to be protected as a priority. A forward-facing child seat which is firmly attached to the vehicle will reduce the risk of impact to the head. Place your child in a forward-facing seat as long as their size permits.

Choose a bucket type seat for optimum side protection.



31234

Booster cushions

From 15 kg or 4 years, the child can travel using a booster seat, which will enable the seat belt to be adapted to suit his/her size and shape. The booster seat cushion must be fitted with guides to position the seat belt on the child's thighs rather than the stomach. A seat-back equipped with a belt strap guide is recommended to place the seat belt in the middle of the shoulder. It must never rest on the neck or on the arm. Choose a bucket type seat for optimum side protection.

CHILD SAFETY: choosing a child seat mounting (1/2)

There are two child seat mounting systems: via the seat belt or using the ISOFIX system.

Attachment via the seat belt

The seat belt must be adjusted to ensure that it is effective in the event of harsh braking or an impact.

Ensure that the strap paths indicated by the child seat manufacturer are respected

Always check that the seat belt is correctly fastened by pulling it up, then pulling it out fully whilst pressing on the child seat.

Check that the seat is correctly held by moving it from side to side and back to front: the seat should remain firmly fixed.

Check that the child seat has not been installed at an angle and that it is not resting against a window.



Do not use the child seat if it may unfasten the seat belt restraining it: the base of the seat must not rest on the buckle and/or catch of the seat belt.

Some child seats cannot be fitted in your vehicle. In particular, some rear-facing child seats cannot be securely fitted because of their size. Before purchasing a child seat, check that it can be securely fitted in your vehicle.



No modifications may be made to the component parts of the restraint system (belts, ISOFIX and seats and their mountings) originally fitted.



The seat belt must never be twisted or the tension relieved. Never pass the shoulder strap under the arm or behind the back.

Check that the seat belt has not been damaged by sharp edges. If the seat belt does not operate normally, it will not protect the child. Consult an approved dealer. Do not use this seat until the seat belt has been repaired.

Attachment with the ISOFIX system

Authorised ISOFIX child seats are approved in accordance with regulation ECE-R44 in one of the three following scenarios:

- ISOFIX universal 3-point forward-facing seat
- ISOFIX semi-universal 2-point seat
- specific

For the latter two, check that your child seat can be installed by consulting the list of compatible vehicles.

Attach the child seat with the ISOFIX locks, if these are provided. The ISOFIX system allows quick, easy, safe fitting.

The ISOFIX system consists of 2 rings. In some cases, there may be a third ring.



Before using an ISOFIX child seat that you purchased for another vehicle, check that its installation is authorised. Consult the list of vehicles which can be fitted with the seat with the equipment manufacturer.

CHILD SAFETY: choosing a child seat mounting (2/2)

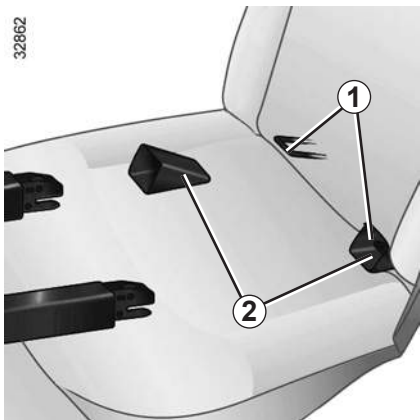

The two rings **1** are located between the seatback and the seat base.

To ensure your child seat can be easily fitted and locked on the rings **1**, use the access guides **2** supplied with the child seat.

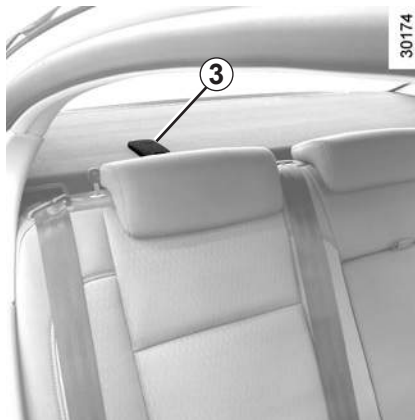

The third ring is used to attach the upper strap on some child seats.

To attach the belt hook in the third ring, lift cover **3**.

Then, pull the belt so that the seatback of the child seat comes into contact with the seatback of the vehicle seat.



The ISOFIX anchorage points have been exclusively designed for child seats with the ISOFIX system. Never fit a different type of child seat, seat belt or other objects to these fittings.

Check that nothing is obstructing the anchorage points.

If your vehicle has been involved in a road accident, have the ISOFIX fittings checked and replace your child seat.



Check that the seatback of the forward-facing child seat is in contact with the seatback of the vehicle seat.

In this case, the child seat may not always rest on the seat base of the vehicle seat.

CHILD SAFETY: fitting a child seat (1/5)

Some seats are not suitable for fitting child seats. The diagram on the following page shows you how to attach a child seat.

The types of child seat indicated may not be available. Before using a different child seat, check with the manufacturer that it can be fitted.



Fit the child seat in a rear seat wherever possible.

Check that when installing the child seat in the vehicle it is not at risk of coming loose from its base.

If you have to remove the headrest, check that it is correctly stored so that it does not come loose under harsh braking or impact.

Always attach the child seat to the vehicle even if it is not in use so that it does not come loose under harsh braking or impact.

In the front seat

The laws concerning children travelling in the front passenger seat differ in every country. Consult the legislation in force and follow the indications on the diagram on the following page.

Before fitting a child seat in this seat (if authorised):

- lower the seat belt as far as possible;
- move the seat as far back as possible;
- gently tilt the seatback away from vertical (approximately 25°);
- on equipped vehicles, raise the seat base as far as possible.

Do not change these settings after the child seat is installed.



RISK OF DEATH OR SERIOUS INJURY:

before installing a rear-facing child seat in the front passenger seat, make sure the air bag has been deactivated (refer to the information on “Child safety: deactivating/activating the front passenger air bag” Section 1).

In the rear side seat

A carrycot can be installed across the vehicle and will take up at least two seats. Position the child with his or her feet nearest the door.

Move the front seat as far forward as possible when installing a rear-facing child seat. Then, push it back in compliance with the child seat instructions. For the safety of the child in the forward-facing position, do not push back the seat in front of the child more than halfway along its runners. Do not recline the seatback too far (maximum of 25°) and raise the seat as much as possible.

Check that the forward-facing child seat is resting against the back of the vehicle seat and that the headrest of the vehicle is not obstructing its use.

CHILD SAFETY: fitting a child seat (2/5)

30175

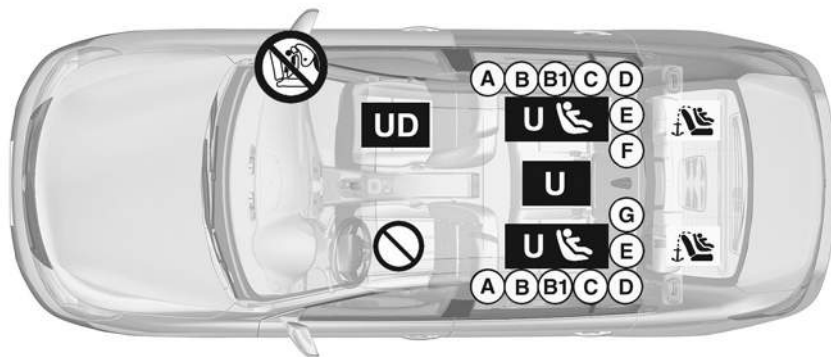

Vehicle with passenger airbag that can be deactivated



Check the status of the air bag before fitting a child seat or allowing a passenger to use the seat.



Seat not suitable for fitting child seats.



RISK OF DEATH OR SERIOUS INJURY: before installing a rear-facing child seat in the front passenger seat, make sure the air bag has been deactivated (refer to the information on “Child safety: deactivating/activating the front passenger air bag” Section 1).

Child seat attached using the belt



Seat which allows a child seat with “Universal” approval to be attached by a seat belt.



Seat which **only** allows a **rear-facing seat** with “Universal” approval to be attached with a seat belt.

Child seat attached using the ISOFIX fitting



Seat which allows an ISOFIX child seat to be fitted.



The rear seats are fitted with an anchorage point which allows a forward-facing ISOFIX child seat with “Universal” approval to be fitted. The anchorage points are located behind the headrests of the rear seats.

The size of the ISOFIX child seat is indicated by a letter:

- A, B and B1: for forward-facing seats in group 1 (9 to 18 kg);
- C: rear-facing seats in group 1 (9 to 18 kg);
- D and E: shell seat or rear-facing seats in group 0 or 0+ (less than 13 kg);
- F and G: carrycots in group 0 (less than 10 kg).



Using a child safety system which is not approved for this vehicle will not correctly protect the baby or child. They risk serious or even fatal injury.

CHILD SAFETY: fitting a child seat (3/5)

30176

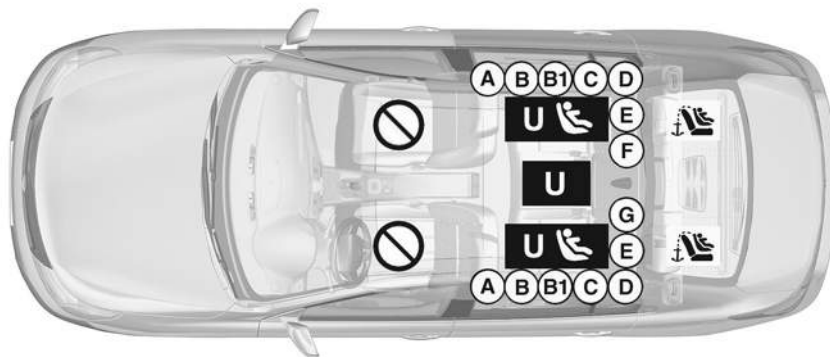

Vehicle with passenger airbag that cannot be deactivated



Seat not suitable for fitting child seats.

Child seat attached using the belt



Seat which allows a child seat with "Universal" approval to be attached by a seat belt.



Using a child safety system which is not approved for this vehicle will not correctly protect the baby or child. They risk serious or even fatal injury.

Child seat attached using the ISOFIX fitting



Seat which allows an ISOFIX child seat to be fitted.



The rear seats are fitted with an anchorage point which allows a forward-facing ISOFIX child seat with "Universal" approval to be fitted. The anchorage points are located behind the headrests of the rear seats.

The size of the ISOFIX child seat is indicated by a letter:

- A, B and B1: for forward-facing seats in group 1 (9 to 18 kg);
- C: rear-facing seats in group 1 (9 to 18 kg);
- D and E: shell seat or rear-facing seats in group 0 or 0+ (less than 13 kg);
- F and G: carrycots in group 0 (less than 10 kg).

CHILD SAFETY: fitting a child seat (4/5)

The table below summarises the information already shown on the diagram on the previous page, to ensure the regulations in force are respected.

Type of child seat	Weight of the child	Size of ISOFIX seat	Front passenger seat with airbag		Rear side seat	Rear centre seat
			WITH deactivation (1) (3)	WITHOUT deactivation (2)		
Carrycot fitted across the vehicle Group 0	< 10 kg	F, G	X	X	U - IL (4)	U (4)
Shell seat/rear-facing seat Group 0 or 0+	< 13 kg and 9 to 18 kg	E, D	U	X	U - IL (5)	U (5)
Rear-facing seat Group 0+ and 1	9 to 18 kg	C	U	X	U - IL (5)	U (5)
Forward-facing seat Group 1	9 to 18 kg	A, B, B1	X	X	U - IUF - IL (6)	U (6)
Booster cushions Group 2 and 3	15 to 25 kg and 22 to 36 kg	-	X	X	U (6)	U (6)



(1) RISK OF DEATH OR SERIOUS INJURY: before fitting a rear-facing child seat in the front passenger seat, check that the air bag has been deactivated (refer to the information on “Deactivating the front passenger air bags” at the end of the paragraph).

(2) RISK OF DEATH OR SERIOUS INJURY: never fit a child seat to this seat.

CHILD SAFETY: fitting a child seat (5/5)

X = Seat not suitable for fitting child seats.

U = Seat allowing a child seat with “Universal” approval to be attached by seat belt; check that it can be fitted correctly.

IUF/IL = On equipped vehicles, seat which allows a child seat with “universal/semi-universal or vehicle specific approval” to be fitted using the ISOFIX system; check that it can be fitted correctly.

- (3) Only a rear-facing child seat can be fitted in this seat: position the vehicle seat as far back as possible and gently tilt the seat-back (approximately 25°).
- (4) A carrycot can be fitted across the vehicle and will take up at least two seats. Position the child with his or her feet nearest the door.
- (5) Move the front seat as far forward as possible to fit a rear-facing child seat, then move back the seat(s) in front in accordance with the child seat instructions.
- (6) Forward-facing child seat; position the seatback of the child seat in contact with the seatback of the vehicle seat. Adjust the headrest, or remove it if necessary. Do not push the front seat more than halfway back on its runners and do not recline the seatback more than 25°.

CHILD SAFETY: deactivating and activating the front passenger air bag (1/3)



Deactivating the front passenger air bag (on equipped vehicles)

You **must** deactivate certain devices in addition to the front passenger seat belt before fitting a child seat in the front passenger seat.



To deactivate the air bag: when the vehicle is stationary, push and turn lock 1 to the **OFF** position.

With the ignition on, you **must** check that indicator light 2  is lit on the central display and, depending on the vehicle, that the message "Passenger airbag off" is displayed.

This indicator light remains constantly lit while the air bag is deactivated.



The passenger air bag must only be deactivated or activated **with the ignition off**.

If it is interfered with when the vehicle is being driven, indicator

lights  and  will come on.

Switch the ignition off then on again to reset the air bag in accordance with the lock.

CHILD SAFETY: deactivating and activating the front passenger air bag (2/3)

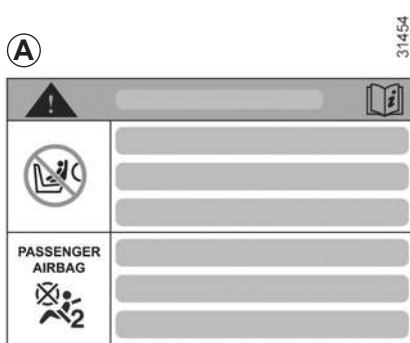

DANGER

Since front passenger air bag triggering and the position of a rear-facing child seat are incompatible, **NEVER** fit a rear-facing child seat in this position unless the vehicle is fitted with a front air bag deactivation device. The child may suffer very serious injuries if the air bag inflates.

The markings on the dashboard and label **A** on every side of the front passenger sun visor **3** remind you of these instructions.

CHILD SAFETY: deactivating and activating the front passenger air bag (3/3)



Activating the front passenger air bag

Reactivate the front passenger air bag as soon as you remove the child seat from the front passenger seat to ensure the protection of the front passenger in the event of an impact.

To reactivate the air bag: when the vehicle is stationary, push and turn lock **1** to the **ON** position.

With the ignition on, it is **essential** to

check that warning light **2**,  is off. The front passenger seat belt additional restraint systems are activated.



Operating faults

Contact your approved dealer as soon as possible.

It is forbidden to fit a rear-facing child seat to the front seat if a fault is noted when activating/deactivating the front passenger air bag.

Allowing any other passenger to sit in that seat is not recommended.

STEERING WHEEL/POWER-ASSISTED STEERING

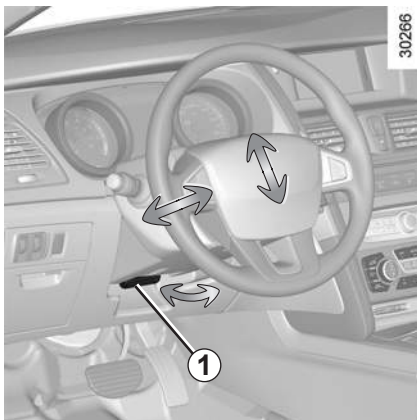

Height and reach adjustment

(reach adjustment depending on the vehicle)

Pull lever **1** and move the steering wheel to the desired position; then, push lever **1** **fully back in, beyond the point of resistance**, to lock the steering wheel.

do not apply too much pressure to the steering wheel when the steering wheel is adjusted. This may damage the steering wheel support.

Make sure that the steering wheel is correctly locked.



For safety reasons, only adjust the steering wheel when the vehicle is stationary.

Variable power-assisted steering

The variable power-assisted steering system is equipped with an electronic control system which alters the level of assistance to suit the vehicle speed.

Steering is made easier during parking manoeuvres (for added comfort) whilst the force needed to steer increases progressively as the speed rises (for enhanced safety at high speeds).

Never leave the steering wheel at full lock while stationary.

With the engine switched off, or if there is a system fault, it is still possible to turn the steering wheel. The force required will be greater.

DRIVING POSITION: LEFT-HAND DRIVE (1/2)

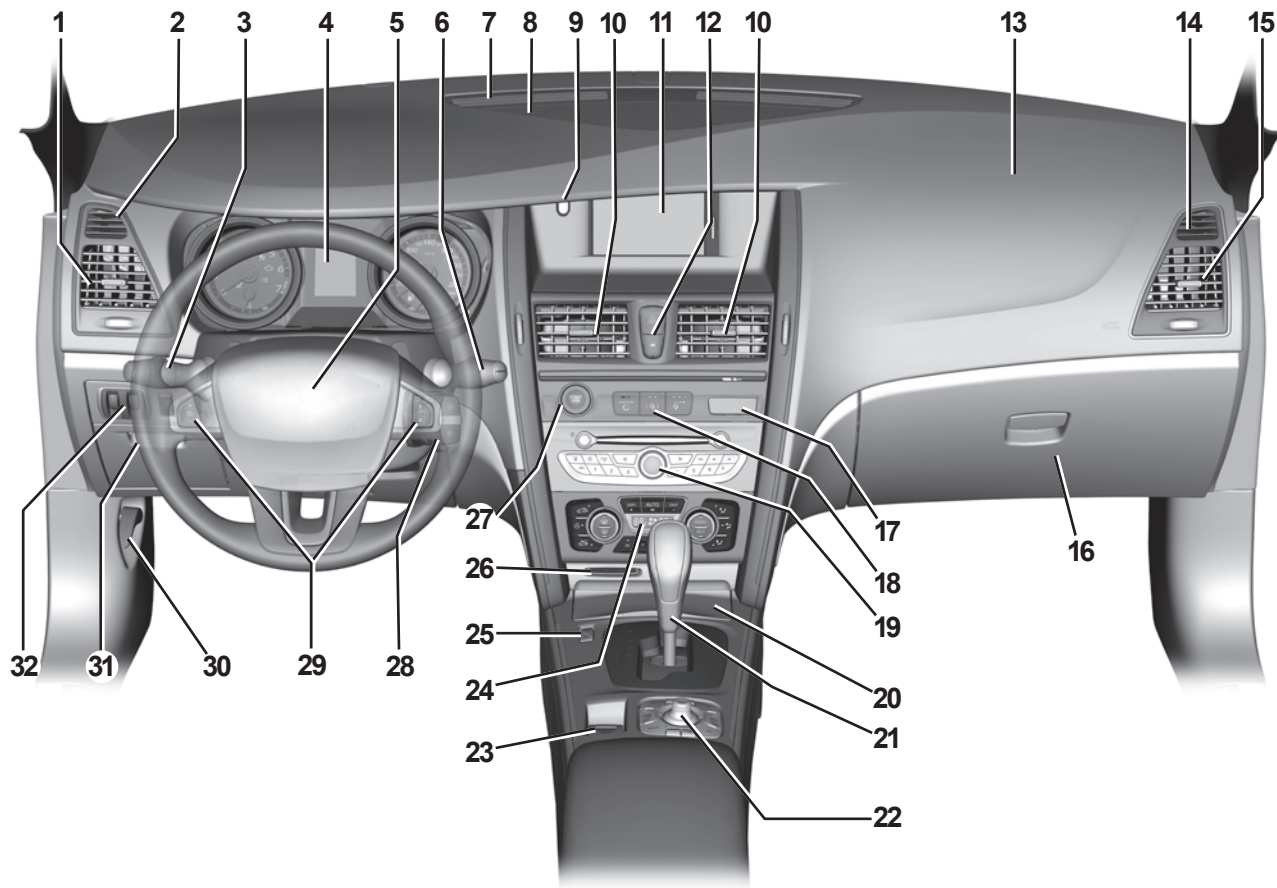

30261

DRIVING POSITION: LEFT-HAND DRIVE (2/2)

The equipment fitted, described below, **DEPENDS ON THE VERSION AND COUNTRY.**

- 1** Side air vent
- 2** Side window demister outlets
- 3** Stalk for:
 - direction indicators
 - exterior lights
 - front fog lights
 - rear fog lights
- 4** Instrument panel
- 5** Driver's air bag and horn location.
- 6** Stalk for:
 - windscreen washer/wiper;
 - trip computer information readout control and vehicle settings personalisation menu.
- 7** Windscreen demisting outlets
- 8** Dashboard upper air vents
- 9** Driver and front passenger seat belt unfastened and passenger airbag deactivated warning light
- 10** Centre air vents
- 11** Display of the time, temperature, radio information, navigation system information, etc.
- 12** Switch
 - Central opening element locking/unlocking switch
 - Hazard warning lights switch
- 13** Passenger air bag location
- 14** Side window demister outlets
- 15** Side air vent
- 16** Glove box
- 17** Fragrance diffuser cartridge holder
- 18** Fragrance diffuser/ionizer control
- 19** Location for radio
- 20** Ashtray/cigar lighter
- 21** Gear lever
- 22** Navigation controls
- 23** Assisted parking brake
- 24** Heating and ventilation controls
- 25** Cruise control/speed limiter main switch
- 26** RENAULT card reader
- 27** Engine start/stop button
- 28** Remote control audio adjustments
- 29** Cruise control/speed limiter controls
- 30** Bonnet release
- 31** Dashboard storage compartment
- 32** Controls for:
 - electric headlight beam adjustment,
 - control instrument lighting rheostat,
 - activation/deactivation of the traction control

DRIVING POSITION: RIGHT-HAND DRIVE (1/2)

30311

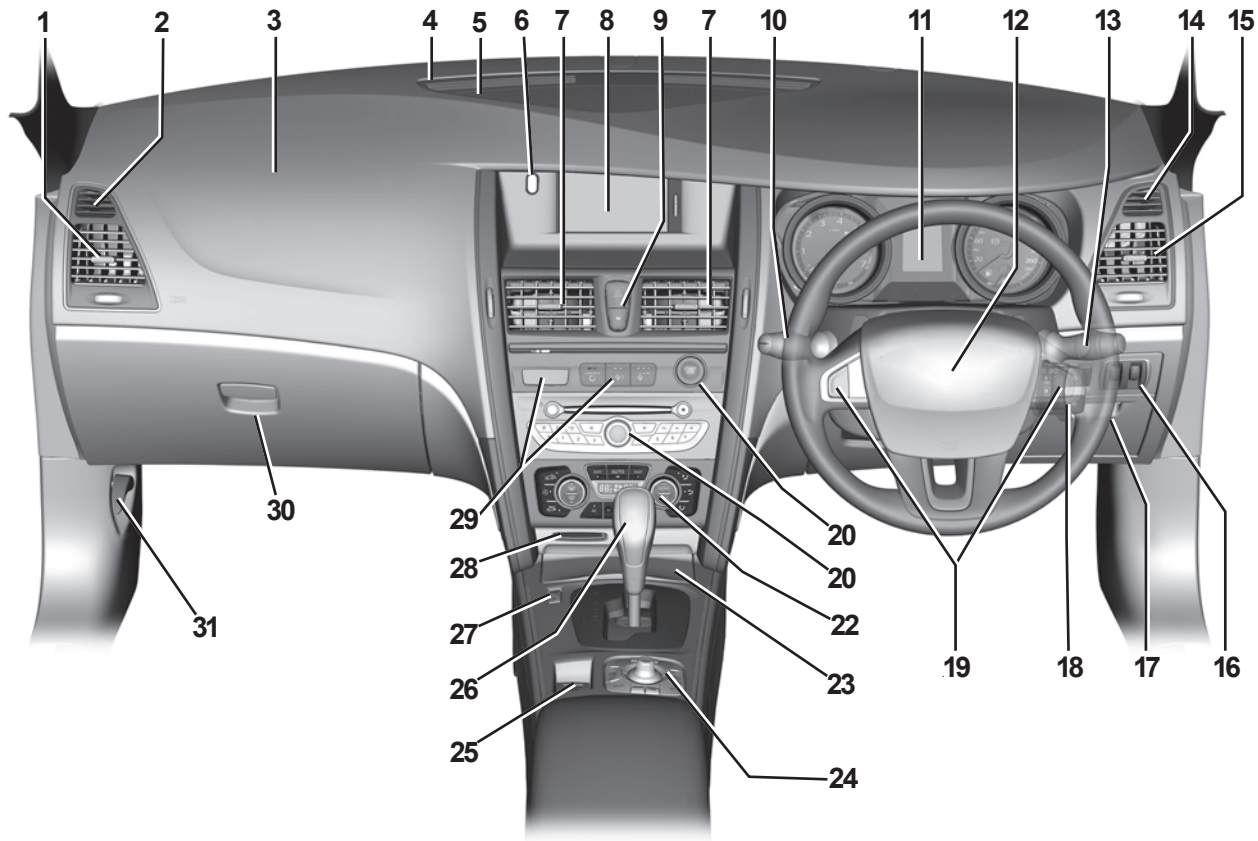

DRIVING POSITION: RIGHT-HAND DRIVE (2/2)

The equipment fitted, described below, **DEPENDS ON THE VERSION AND COUNTRY.**

- 1** Side air vent
- 2** Side window demister outlets
- 3** Passenger air bag location
- 4** Windscreen demisting outlets
- 5** Dashboard upper air vents
- 6** Driver and front passenger seat belt unfastened and passenger airbag deactivated warning light
- 7** Centre air vents
- 8** Display of the time, temperature, radio information, navigation system information, etc.
- 9** Switch
 - Central opening element locking/unlocking switch
 - Hazard warning lights switch
- 10** Stalk for:
 - direction indicators
 - exterior lights
 - front fog lights
 - rear fog lights
- 11** Instrument panel
- 12** Driver's air bag and horn location.
- 13** Stalk for:
 - windscreen washer/wiper;
 - trip computer information readout control and vehicle settings personalisation menu.
- 14** Side window demister outlets
- 15** Side air vent
- 16** Controls for:
 - electric headlight beam adjustment;
 - control instrument lighting rheostat;
 - activation/deactivation of the traction control.
- 17** Dashboard storage compartment
- 18** Remote control audio adjustments
- 19** Cruise control/speed limiter controls
- 20** Engine start/stop button
- 21** Location for radio
- 22** Heating and ventilation controls
- 23** Ashtray/cigar lighter
- 24** Navigation controls
- 25** Assisted parking brake
- 26** Gear lever
- 27** Cruise control/speed limiter main switch
- 28** RENAULT card reader
- 29** – Fragrance diffuser cartridge holder
 - Fragrance diffuser/ionizer control
- 30** Glove box
- 31** Bonnet release

WARNING LIGHTS (1/4)

The presence and operation of the warning lights **DEPEND ON THE EQUIPMENT AND COUNTRY.**



The instrument panel **A** lights up when the ignition is switched on.

In some cases, the appearance of a warning light is accompanied by a message.

The  warning light means you should **drive very carefully** to an approved Dealer as soon as possible. If you fail to follow this recommendation, you risk damaging your vehicle.



Side light tell-tale light



Headlight main beam tell-tale light



Dipped beam headlight tell-tale light



Front fog light tell-tale light



Rear fog light tell-tale light



Handbrake “on” or electronic parking brake warning light

Refer to the information on the “Handbrake” or “Electronic parking brake” in Section 2.



Brake circuit fault warning light

The warning light comes on when the ignition is switched on, and goes off after a few seconds. If it lights up together with the **STOP** warning light and a beep, it indicates a fault in the braking system. Stop as soon as traffic conditions allow and consult an approved Dealer.



Left-hand direction indicator tell-tale light



Right-hand direction indicator tell-tale light



Warning light **STOP** requires you to stop immediately, for your own safety, as soon as traffic conditions allow.

Switch off the engine and do not restart it. Contact an approved Dealer.



If no lights or sounds are apparent, this indicates a fault in the instrument panel. This indicates that it is essential to stop immediately (as soon as traffic conditions allow). Ensure that the vehicle is correctly immobilised and contact an approved Dealer.

WARNING LIGHTS (2/4)

The presence and operation of the warning lights **DEPEND ON THE EQUIPMENT AND COUNTRY.**



Not used



Anti-lock braking system warning light (ABS).

This lights up when the ignition is switched on and goes out after a few seconds. If it does not go out after the ignition is switched on, or lights up when driving, there is a fault with the ABS. Braking will then be as normal, without the ABS system.

Contact your approved Dealer as soon as possible.



Heated seat indicator light

indicates that the driver's or passenger's heated seat is operating.



Toxic fume filter system warning light

This lights up when the ignition is switched on, and goes off after a few seconds.

- If it lights up continuously, consult your approved Dealer as soon as possible;
- if it flashes, reduce the engine speed until the light stops flashing. Contact your approved Dealer as soon as possible.

Refer to the information on “Antipollution, fuel economy and driving” in Section 2.



Air bag warning light

This comes on when the ignition is switched on, and goes off after a few seconds.

If it does not come on when the ignition is switched on, or comes on when the engine is running, there is a fault in the system.

Contact your approved Dealer as soon as possible.

WARNING LIGHTS (3/4)

The presence and operation of the warning lights **DEPEND ON THE EQUIPMENT AND COUNTRY.**

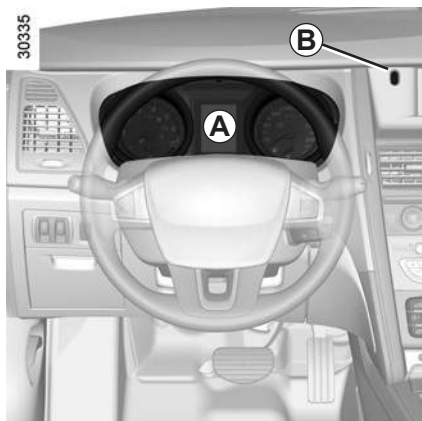

STOP STOP light

This lights up when the ignition is switched on and goes out as soon as the engine is started.

It comes on with other warning lights and/or messages, and is accompanied by a beep.

It requires you to stop immediately, for your own safety, as soon as traffic conditions allow. Switch off the engine and do not restart it.

Contact an approved Dealer.



Warning light

This lights up when the ignition is switched on and goes out as soon as the engine is started. It may light up in conjunction with other warning lights and/or messages on the instrument panel.

It means you should **drive very carefully** to an approved Dealer as soon as possible. If you fail to follow this recommendation, you risk damaging your vehicle.



Low fuel level warning light

This lights up when the ignition is switched on, and goes off after a few seconds. It lights up if the fuel level is too low; when the vehicle is being driven, it is accompanied by a beep. Fill up as soon as possible.

These indicator lights light up on instrument panel B:



Front seat belt reminder warning light

This comes on when the engine is started then, if the driver's or front passenger's seat belt (if this seat is occupied) is not fastened and the vehicle has reached approximately 12 mph (20 km/h), it flashes and a bleep sounds for around 120 seconds.

Note: an object placed on the passenger seat base may activate the warning light in some cases.

Rear seat belt reminder

The number of rear seat belts fastened appears on instrument panel A for approximately 30 seconds each time:

- the vehicle is started;
- a door is opened;
- a rear seat belt is fastened or unfastened.

Check that the rear passengers are wearing seat belts and that the number of seat belts shown as fastened corresponds to the number of rear bench seat places occupied.

WARNING LIGHTS (4/4)

The presence and operation of the warning lights **DEPEND ON THE EQUIPMENT AND COUNTRY.**



The following warning lights are indicated on trip computer and warning system screen C:



Driving correction device indicator light

Refer to the information on “Driving correction devices” in Section 2.



Battery charge warning light

If it comes on together with the **STOP** warning light and a beep, it indicates that the electrical circuit is overcharged or undercharged. Stop as soon as traffic conditions allow and consult an approved Dealer.



Coolant temperature warning light

If it lights up while you are driving accompanied by the **STOP** warning light and a beep, the message is displayed on the instrument panel. You must stop, switch off the ignition and wait for the temperature to drop. If it remains lit, refer to the information on “Levels” in Section 4, check the coolant level and top up if necessary. If the warning light does not go out, consult an approved Dealer as soon as possible.



Oil pressure warning light

If it comes on when you are driving accompanied by the **STOP** warning light and a beep, it is essential to stop and switch off the ignition. Check the oil level (refer to the information on the “Engine oil level” in Section 4). If the level is correct, the light has come on for another reason; consult an approved Dealer.



Speed limiter and cruise control indicator lights

See the information on the “Speed limiter” and “Cruise control” in Section 2.



Preheating warning light (diesel version)

This warning light comes on when the ignition is switched on. It means that preheating is in progress. Once preheating is completed, the warning light goes out and the engine starts.

DISPLAYS AND INDICATORS

30251

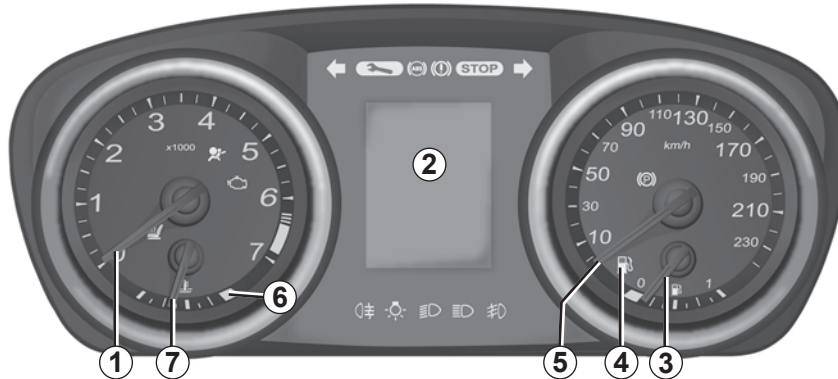

Rev counter 1 (rpm x 1000)

Speedometer 5 (mph or km/h)

Trip computer and warning system 2

The trip parameters and warning messages are displayed on display 2. Refer to the information on the “Trip computer and warning system” in Section 1.

Coolant temperature indicator 7

In normal use, the needle should be positioned before zone 6. It may approach zone 6 under severe conditions of use. This is not serious unless the **STOP** warning light comes on accompanied by the  warning light on display 2, a message on the instrument panel and a beep.

Fuel level gauge 3

If the minimum level is reached, warning light 4 integrated into the indicator comes on. Fill up as soon as possible. There are only approximately 8 litres of fuel left after the warning light first comes on. The useable level of fuel is even lower than this amount. Depending on the vehicle's position

and the driving conditions, the correct fuel level may not be indicated, or the warning light may not come on automatically.

Gear engaged indicator

The gear engaged is shown on display 2. For more information, refer to the information on the “Automatic gear-box” in Section 2.

Door open/closed indicator

If a door or the trunk lid is open or not properly closed, display 2 will warn you of this.

With the engine off, if you press the engine start/stop button during filling up, the new fuel level may not register on fuel level gauge 3.

TRIP COMPUTER AND WARNING SYSTEM (1/9)



Trip computer and warning system 1

Depending on the vehicle, this includes the following functions:

- distance travelled;
- journey parameters;
- information messages;
- operating fault messages (associated with the  warning light);
- warning messages (associated with the **STOP** warning light);
- vehicle settings customisation menu.

All these functions are described on the following pages.

27968



Display selection keys 2 and 3

Scroll through the following information upwards (button 2) or downwards (button 3) by pressing briefly and successively (the display depends on the vehicle equipment and country).

- a) total mileage and trip mileage recorder;
- b) journey parameters:
 - fuel used;
 - average fuel consumption;
 - current fuel consumption;
 - estimated range;
 - distance travelled;
 - average speed;

- c) mileage before service;
- d) tyre pressure monitor;
- e) cruise control/speed limiter programmed speed;
- f) vehicle settings customisation menu;
- g) on-board log, operating fault and information message readout.

TRIP COMPUTER AND WARNING SYSTEM (2/9)

27968



trip mileage resetting

With “trip mileage recorder” selected on the display, press button **2** or **3** until the mileage recorder resets to zero.

Resetting the journey parameters (reset button)

With one of the journey parameters selected on the display, press button **2** or **3** until the display resets.

Interpreting some of the values displayed after resetting

The values showing average fuel consumption, range and average speed will become more stable and reliable the further you travel after pressing the reset button.

For the first few miles after pressing the reset key you will notice that the range increases as you travel. This range takes into account the average fuel consumption since the last time the reset button was pressed. Therefore, the average fuel consumption may decrease when:



- the vehicle stops accelerating;
- the engine reaches its operating temperature (if the engine was cold when reset key was pressed);
- when driving from an urban area onto the open road.

Automatic resetting of the journey parameters

Resetting occurs automatically when the maximum value of any of the parameters is exceeded.







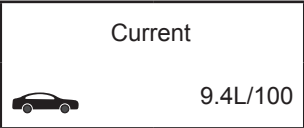

TRIP COMPUTER AND WARNING SYSTEM (3/9)

The display of information shown below **DEPENDS ON THE VEHICLE EQUIPMENT AND COUNTRY.**

Examples of selections	Interpreting the display selected
<div data-bbox="137 311 432 434" style="border: 1px solid black; padding: 10px; text-align: center;">101778 km 112.4 km</div>	<p>⇒ a) Total mileage and trip mileage recorder.</p>
<div data-bbox="137 508 432 639" style="border: 1px solid black; padding: 10px; text-align: center;">Fuel used  25.2 L</div>	<p>⇒ b) Journey parameters. Fuel used. Fuel consumed since the last reset.</p>
<div data-bbox="137 751 432 882" style="border: 1px solid black; padding: 10px; text-align: center;">Average  7.2L/100</div>	<p>⇒ Average fuel consumption since the last reset. The value is displayed after having travelled at least 400 metres since the last reset.</p>

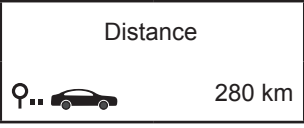
TRIP COMPUTER AND WARNING SYSTEM (4/9)

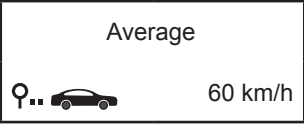
The display of information shown below **DEPENDS ON THE VEHICLE EQUIPMENT AND COUNTRY.**

Examples of selections	Interpreting the display selected
	 <p>Current fuel consumption This value is displayed above a speed of approximately 18 mph (30 km/h).</p>
	 <p>Estimated range with remaining fuel This range takes into account the average fuel consumption since the last time the reset button was pressed. The value is displayed after driving 400 metres (it disappears if the fuel level warning light comes on). Note: the information displayed may not correspond to the actual range depending on the trajectory, driving style, the road conditions (uphill or downhill, etc.) and the vehicle speed.</p>
	 <p>Distance travelled since the last reset</p>
	 <p>Average speed since the last reset The value is displayed after driving 400 metres.</p>

TRIP COMPUTER AND WARNING SYSTEM (5/9)



The display of information shown below **DEPENDS ON THE VEHICLE EQUIPMENT AND COUNTRY.**

Examples of selections	Interpreting the display selected
<div data-bbox="137 350 432 463" style="border: 1px solid black; padding: 10px; text-align: center;">“Service in 1936 km/2 mo.”</div>	<p data-bbox="621 275 913 300">c) Mileage before service.</p> <p data-bbox="648 312 1427 362">Distance remaining until the next service (displayed in miles (kilometres) and months), then when the service nears, several scenarios are possible:</p> <ul data-bbox="648 367 1427 501" style="list-style-type: none"><li data-bbox="648 367 1427 445">– range less than 900 miles (1,500 km) or one month.; the message “Service due in” is displayed accompanied by the nearest term (distance or time);<li data-bbox="648 445 1427 501">– range equal to 0 miles (0 km) or date of service reached: the message “Service due” is displayed accompanied by warning light . <p data-bbox="648 512 1191 537">The vehicle requires a service as soon as possible.</p>
<p data-bbox="84 602 1427 680">Note: depending on the vehicle, the distance before a service changes according to driving style (frequent driving at low speeds, door-to-door journeys, extensive use at idle speed, towing a trailer etc.). The distance remaining until the next service can therefore decrease more quickly in some cases than the actual distance travelled.</p> <p data-bbox="84 706 1003 731">Resetting the display after service in accordance with the maintenance schedule</p> <p data-bbox="84 743 1427 794">The mileage before service must only be reset after a service which complies with the recommendations in the Maintenance Service Document.</p> <p data-bbox="84 798 1427 848">If you decide to change the oil more frequently, do not reset this data each time the oil is changed to avoid exceeding the replacement intervals for other parts in the maintenance schedule.</p> <p data-bbox="84 853 1427 903">Special note: To reset the distance before service, press and hold one of the display reset buttons for approximately 10 seconds until the display shows the mileage permanently. The message flashes and then the display resets.</p>	

TRIP COMPUTER AND WARNING SYSTEM (6/9)

Journey parameters

The display of information shown below **DEPENDS ON THE VEHICLE EQUIPMENT AND COUNTRY.**

Examples of selections	Interpreting the display selected
<div data-bbox="137 253 443 402" style="border: 1px solid black; padding: 10px; text-align: center;">Tyre pressure 32  32 32  32</div>	<p>⇒ d) Tyre pressure monitor Refer to the information on the “Tyre pressure monitor” in Section 2.</p>
<div data-bbox="137 479 443 598" style="border: 1px solid black; padding: 10px; text-align: center;">“Settings menu: press and hold”</div>	<p>⇒ f) Vehicle settings customisation menu Enables certain vehicle functions to be set (instrument panel language, parking distance control, etc.). Refer to the information on “Vehicle settings customisation menu” in Section 1.</p>
<div data-bbox="137 742 443 861" style="border: 1px solid black; padding: 10px; text-align: center;">“No message memorised”</div>	<p>⇒ g) Computer log Successive display of:</p> <ul style="list-style-type: none">– information messages (passenger air bag OFF etc.),– operating fault messages (check the injection system, etc.).

TRIP COMPUTER AND WARNING SYSTEM (7/9)

Information messages

These can help in the vehicle starting phase, or give information about a selection or a driving status.

Examples of messages	Interpreting the display selected
"Battery low start engine"	Indicates that the vehicle must be started to recharge the battery (eg. after the engine has been switched off for some time whilst listening to the radio).
"Please remove keycard"	Request to remove the RENAULT card from the reader when you leave the vehicle.
"Checking control functions"	Displayed with the ignition on when the vehicle is running self-diagnostics.
"Traction control off"	Indicates that you have deactivated the Traction Control function.
"Turn steering wheel + START"	Turn the steering wheel slightly whilst pressing the vehicle start button to unlock the steering column.
"No messages memorised"	No warning is stored.
"Steering wheel not locked"	Indicates that the steering column has not been locked. Consult an approved Dealer.

TRIP COMPUTER AND WARNING SYSTEM (8/9)

Operating fault messages

These appear with the  warning light and mean that you should drive very carefully to an approved Dealer as soon as possible. If you fail to follow this recommendation, you risk damaging your vehicle.

They disappear when the display selection key is pressed or after several seconds and are stored in the computer log. The  warning light stays on. Examples of operating fault messages are given in the following pages.

Examples of messages	Interpreting the display selected
"Clean diesel filter"	Indicates the presence of water in the diesel filter. Contact your approved Dealer as soon as possible.
"Check lighting"	Indicates a fault in the directional headlights.
"Check vehicle"	Indicates a fault in one of the pedal sensors, battery management system or oil level sensor.
"Check airbag"	Indicates a fault in the restraint system in addition to the seat belts. In the event of an accident, it is possible that they may not be triggered.
"Check antipollution system"	Indicates a fault in the vehicle's particle filter system.

TRIP COMPUTER AND WARNING SYSTEM (9/9)

Warning messages

These appear with the **STOP** warning light and require you to stop immediately, for your own safety, as soon as traffic conditions allow. Stop your engine and do not restart it. Contact an approved Dealer.

Examples of warning messages are given in the following pages. **Note:** the messages appear on the display either individually or alternately (when there are several messages to be displayed), and may be accompanied by a warning light and/or a beep.

Examples of messages	Interpreting the display selected
“Engine failure hazard”	Indicates engine overheating, or an injection or engine oil pressure fault.
“Power steering fault”	Indicates a fault in the steering system.
“Risk of steering locking”	Indicates a fault in the steering.
“Battery charging fault”	Indicates a fault with the vehicle’s battery charging circuit.
“Braking system fault”	Indicates a fault with the braking circuit.
“Stop vehicle”	Indicates a fault on the connection between the parking brake system and the instrument panel.
“Puncture”	Indicates a puncture on the wheel displayed on the trip computer and warning system screen.
“Parking brake fault”	Indicates an electronic parking brake fault. Immobilise the vehicle using wheel chocks.

VEHICLE SETTINGS CUSTOMISATION MENU



This function, integrated into trip computer and warning system **1**, allows certain vehicle functions to be activated/ deactivated and adjusted.

Accessing the vehicle settings customisation menu

With the vehicle stationary, press either button **2** or **3** several times until the message “Settings menu: press and hold” appears on screen **1**. Press either button **2** or **3** for longer than 2 seconds to enter the menu.

27968



Adjusting the settings

Press one of buttons **2** or **3** to select a function to change:

- Auto door locking while driving;
- Driver easy access;
- Front parking sensor;
- Rear parking sensor;
- Parking sensor volume;
- Instrument panel language.

Once a line has been selected, keep pressing either button **2** or **3** to change the function:



: function activated



: function deactivated

If you select either “parking sensor volume” or “language”, you will have to make a further selection (sound volume of the parking distance control or instrument panel language). In this case, make your selection and confirm it by holding either button **2** or **3**, the value

selected is shown by a  in front of the line.

To exit the menu, select “exit” or “back” then confirm by keeping either button **2** or **3** pressed. It may be necessary to carry out this operation several times.

The vehicle settings customisation menu cannot be used when driving. At speeds of above 12 mph (20 km/h) for vehicles with a manual gearbox (0 mph for vehicles with an automatic gearbox), the on-board display returns automatically to the trip computer and warning system mode.

CLOCK AND EXTERIOR TEMPERATURE



With the ignition on, the time and, depending on the vehicle, the exterior temperature are displayed on display 1.

Vehicles equipped with a navigation system, radio, etc.

For vehicles equipped with a navigation system or radio, refer to the specific equipment instructions to discover the special features.

If the electrical supply is cut (battery disconnected, broken supply wire, etc.), the clock will lose its time setting. The time must then be set.

We recommend that you do not adjust these settings while driving.

Exterior temperature indicator

Special note: Depending on the vehicle, when the exterior temperature is between -3°C and $+3^{\circ}\text{C}$, the $^{\circ}\text{C}$ characters flash (indicates risk of black ice on the road).



External temperature indicator

As ice formation is related to climatic exposure, local air humidity and temperature, the external temperature alone is not sufficient to detect ice.

REAR VIEW MIRRORS (1/2)

30183

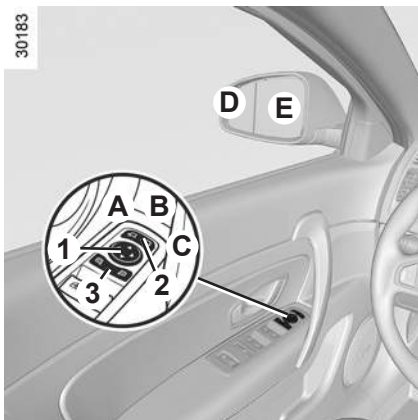

Door mirrors

Adjustment

Select the door mirror using switch **3**, then use button **1** to adjust it to the desired position.

Heated door mirrors

Mirror de-icing is carried out at the same time as rear screen de-icing.



For safety reasons, carry out any adjustments when the vehicle is not being driven.

Storing the setting

For vehicles fitted with a driver's seat with position memory, refer to the information on the "Driver's seat with position memory" in Section 1.

Folding door mirrors

(depending on the vehicles)

The door mirrors automatically fold in when the vehicle is locked (switch **2** in position **B**). In this case, they will fold out when the ignition is next switched on.

In any case, you can make the door mirrors fold in (switch **2** in position **C**) or fold out (switch **2** in position **A**).

Automatic mode is then deactivated. To reactivate it, position switch **2** to **B**.

Note: if the mirrors are forced manually, you may hear a noise when the mirrors are folded in or out in automatic mode.



The driver's door mirror may have two clearly defined zones. Zone **E** shows what can normally be seen in an ordinary rear view mirror. Zone **D** increases rear side visibility.

The objects in zone D look much further away than they really are.

Rear view mirrors which tilt in reverse gear

For vehicles equipped with the driver's seat with position memory, you can tilt the door mirrors when reversing and store the position.

Tilting the door mirrors

With the vehicle stationary and reverse gear engaged, select the door mirror using switch **3**:

- left side of switch **3**: tilt left-hand door mirror
- right side of switch **3**: tilt right-hand door mirror

Returning to the driving position

- after reverse gear has been disengaged;
- speed above 4 mph (7 km/h);
- engine switched off;
- switch **3** in the neutral position.

Setting and storage

With the mirrors tilted, you can readjust the angle by pressing button **1**, then store the setting by moving switch **3** to the neutral position.

You can store the angle of rear view mirror in driving position (refer to the information on the "Driver's seat with position memory" in Section 1).

REAR VIEW MIRRORS (2/2)

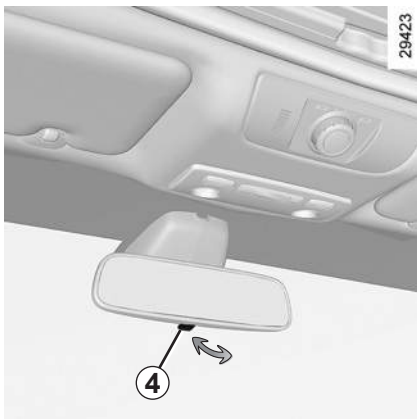

Interior rear view mirror

Its position can be adjusted.

Rear view mirror with lever 4

Night driving

When driving at night, to avoid being dazzled by the headlights of the vehicle behind, depress small lever 4 located behind rear view mirror.

Note: depressing lever 4 may reduce the clarity of the image in the rear view mirror, as the reflection of light is reduced.

Daytime driving

Move lever 4 back to its daytime driving position.

Rear view mirror without lever 4

The rear view mirror darkens automatically to prevent the driver from being dazzled by the vehicle behind.



For safety reasons, carry out any adjustments when the vehicle is not being driven.

AUDIBLE AND VISUAL SIGNALS



Horn

Press on the top or sides of steering wheel boss **A**.

Headlight flasher

Pull stalk **1** towards you to flash the headlights.

Direction indicators

Move stalk **1** parallel to the steering wheel and in the direction you are going to turn it.

When driving on the motorway, the steering wheel is not often turned enough to return the stalk automatically to **0**. There is an intermediate position in which the stalk may be held when changing lanes.

When the stalk is released, it automatically returns to **0**.

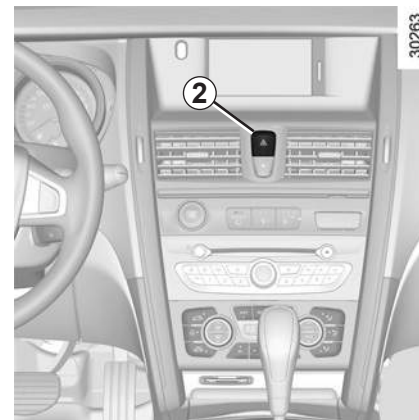

Hazard warning lights

Press switch **2**. The direction indicator lights (front, rear and side) flash. They warn other drivers when you need to park the vehicle in an emergency, in a prohibited location, or when you are driving or transporting goods in hazardous circumstances.

Depending on the vehicle, the hazard warning lights may come on automatically under heavy deceleration. You can switch them off by pressing switch **2**.

EXTERIOR LIGHTING AND SIGNALS (1/3)

26972



Side lights

Turn ring **2** on stalk **1** until the symbol is opposite mark **3**. The side lights and number plate light come on. The brightness of the instrument panel and dashboard can be adjusted by turning control knob **4**. If the side lights are not switched on, it is not possible to set the brightness of the instrument panel with control knob **4**.



Dipped beam headlights

Manual operation

Turn ring **2** on the stalk until the symbol is opposite mark **3**. This indicator light on the instrument panel comes on.

Automatic operation

(depending on the vehicle)

Turn ring **2** on the stalk until the **AUTO** symbol is opposite mark **3**. With the engine running, the dipped beam headlights come on or go out automatically according to the outside light.

30267

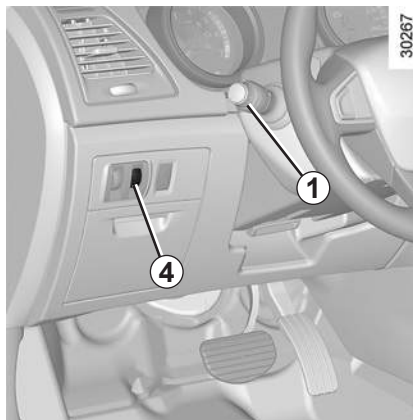

Daytime running lights function

(only relates to front lights)

Depending on the vehicle, the lights come on without using stalk **1** when the engine is started.



Main beam headlights

With the engine running and the dipped beam headlights lit, pull stalk **1** towards you. This indicator light on the instrument panel comes on. To return to the dipped headlights position, pull stalk **1** towards you again.



Before driving at night: check the electrical equipment is operating correctly, and depending on the vehicle, adjust your headlights (if your vehicle is not carrying its normal load). As a general precaution, check that the lights are not obscured (by dirt, mud, snow or objects being transported).

EXTERIOR LIGHTING AND SIGNALS (2/3)

26972



Directional headlights

(depending on the vehicle)

With the dipped beam headlights on and under certain conditions (speed, steering wheel angle, forwards gear selected, etc.) during cornering, the dipped beam headlights move to light the inside of the bend.

The directional headlights only operate when the dipped beam headlights or main beam headlights are lit.

Operating faults

If the headlight tell-tale flashes on the instrument panel accompanied by the message “Check lighting” ( warning light lit), it means there is a lighting fault. Consult an approved Dealer.

Special note:

- If the dipped beam headlights are manually switched on and if the light is sufficient, the directional headlights will remain fixed;
- If the lights come on automatically when cornering, the directional headlights will start working from the next time the vehicle corners;

Switching off the lights

There are two possibilities:

- Manually
Turn ring **2** until symbol **0** is opposite mark **3**.
- Automatically
The lights go out when the engine is stopped and the driver's door opened. In this case, the next time the engine is started the lights will be switched back on according to the position of ring **2**.

“Follow-me-home lighting” function

This function is used to switch on the dipped beam headlights temporarily (useful in a dark car park, for example).

With the engine and lights switched off, pull stalk **1** towards you. The dipped beam headlights come on for approximately thirty seconds.

To extend this period, you can pull the stalk up to four times within 10 seconds of the first action. The total time is limited to two minutes. The message “See-me-home _ _ _” along with the times the lights will be on for is displayed on the instrument panel to confirm this action.

To switch off the lights before they go out automatically, turn ring **2** to any position, then return it to its initial position.

EXTERIOR LIGHTING AND SIGNALS (3/3)

26972



Lights-on reminder buzzer

If the lights are switched on after the engine is switched off, they will not go out when the driver's door is opened. In this case, a **lights-on reminder buzzer** sounds to warn you that the lights are still on.

Front fog lights

Turn centre ring **5** on stalk **1** until the symbol faces mark **6**, then release it.

An indicator light on the instrument panel then comes on.

Operation of the fog lights depends on the exterior lighting position selected.

Rear fog lights

Turn centre ring **5** on stalk **1** until the symbol is opposite mark **6**, then release it.

An indicator light on the instrument panel then comes on.

The rear fog lights only come on when the front fog lights or exterior lights are on.

To avoid inconveniencing other road users, remember to switch off this light when it is no longer needed.

Note: depending on the vehicle, only the fog light is located on the driver's side.

Switching off the lights

Turn ring **5** again until mark **6** is opposite the symbol for the fog light that you wish to switch off.

The front and rear fog lights switch off when the exterior lights are switched off.

In foggy weather, the fog lights do not come on automatically.

Switching on the fog lights remains the responsibility of the driver: the indicator lights on the instrument panel inform you when they are on (indicator light on) or off (indicator light off).

ELECTRICAL ADJUSTMENT OF THE DIPPED BEAM HEADLIGHTS

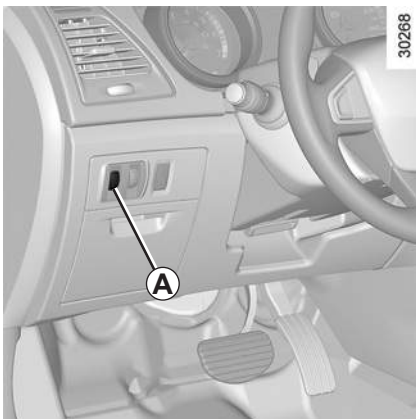

On vehicles fitted with this function, control **A** allows you to adjust the height of the beams according to the load.

Turn control **A** downwards to lower the headlights and upwards to raise them.

For vehicles not fitted with control **A**, adjustment is automatic.

	Examples of positions for adjusting control A according to the load
Driver alone or with front passenger	0
Driver with one front passenger and one rear passenger	0
Driver with one front passenger and two or three rear passengers	1
Driver with one front passenger, three rear passengers and luggage	2
Driver with luggage or (load) reaching the maximum permissible all-up weight	3

WINDSCREEN WASH AND WIPE (1/3)

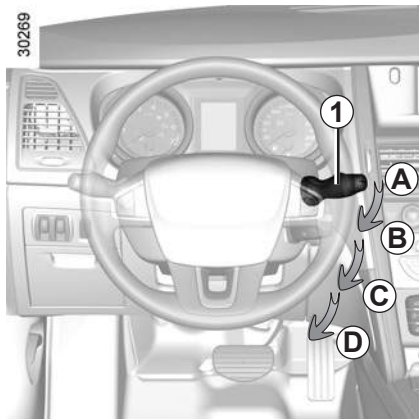

Vehicle fitted with intermittent windscreen wipers

- **A park**
- **B intermittent wiping**
The wipers will pause for several seconds between sweeps. It is possible to change the time between sweeps by turning ring **2**.
 - **E** minimum speed
 - **F** maximum speed
- **C normal wiping speed**
- **D fast wiping speed**

27968

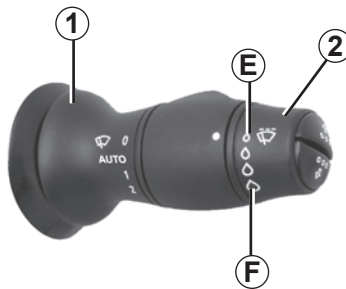

Special note

When driving, the wiping speed slows down whenever the vehicle stops. For example, fast wiping speed will slow to normal wiping speed. As soon as the vehicle moves off, wiping will return to the speed originally selected. With the vehicle stationary, moving stalk **1** overrides the automatic function.

For all vehicles, position **C** can be accessed with the ignition on and positions **B** and **D** can only be accessed with the engine running.

Vehicle fitted with front windscreen wiper rain sensor

- **A park**
- **B automatic wiper function**

When this position is selected, the system detects water on the windscreen and triggers the wipers at a suitable wiping speed. The activation threshold can be modified by turning ring **2**.

- **E** minimum sensitivity
- **F** maximum sensitivity
- **C normal wiping**
- **D fast wiping**

WINDSCREEN WASH AND WIPE (2/3)

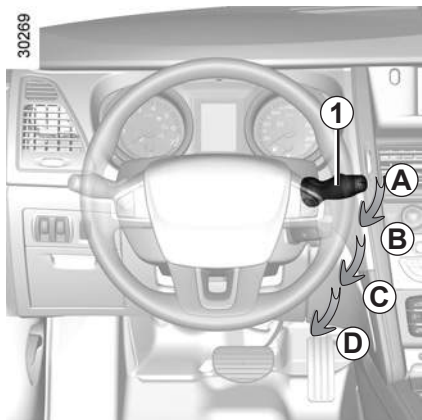

Precautions

- In foggy or snowy weather, automatic wiping (stalk in position **B**) is not activated automatically, and remains under the driver's control.
- If it is not raining, place the stalk in position **A** (park).

27968



Windscreen washer

With the ignition on, pull stalk **1** towards you, then release.

A brief pull will trigger a single sweep of the wipers, in addition to the windscreen washer.

A longer pull will trigger three sweeps of the wipers followed, a few seconds later, by a fourth, in addition to the windscreen washer.

Headlight washers

Headlights on

On equipped vehicles, hold stalk **1** pulled towards you for about 1 second, and the headlight washers and windscreen washers will be activated at the same time.

Note: when the minimum windscreen washer fluid level is reached, the headlight washer system may be deprived.

Fill the windscreen washer fluid and then activate the windscreen washer, **with the engine running**, to reprime the system.

In freezing or snowy weather, ensure they are not stuck to the windscreen (including the central area located behind the interior rear-view mirror) and the rear screen before starting the wipers (risk of motor overheating).

WINDSCREEN WASH AND WIPE (3/3)

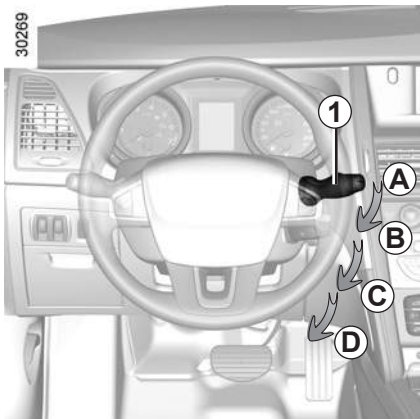

Before any action on the windscreen (washing the vehicle, de-icing, cleaning the windscreen, etc.) return stalk **1** to position **A** (park).

Risk of injury and/or damage.

In icy weather, clear the windscreen before starting the wipers (risk of motor overheating).

Check the condition of the wiper blades. Under all circumstances, replace the wipers as soon as they lose their efficiency.

To replace the wiper blades, switch off the engine and place the stalk in position **D**. Refer to the information on the “Wiper blades” in Section 5.

Make sure the windscreen is clean. Organic solvents or anti-rain treatments may damage the wiper blades and make wiping difficult.

If you switch off the engine while the wipers are operating, they may not return to the normal position.

FUEL TANK (1/2)

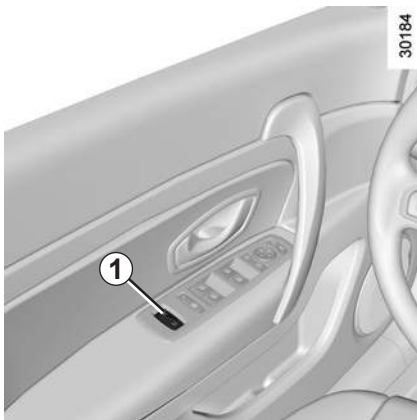

Useful capacity of fuel tank:

- Petrol versions: approximately **70 litres**;
- Diesel versions: approximately **66 litres**.

Press the left side of switch **1** to open cover **A**.

Fuel filler cap **B** is integrated into the filler pipe. For more information, refer to the information on “Filling with fuel” in the following pages.

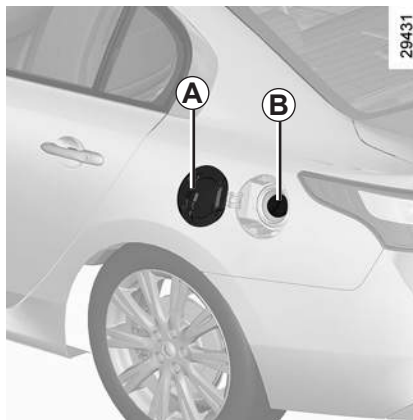

Fuel grade

Always use a high-grade fuel, that complies with legislation in force in each country, and conforms to the specifications given on the label inside cover **A**. Refer to the information on “Engine specifications” in Section 6.

Vehicles running on ethanol-based fuel

It is **necessary** to use unleaded petrol or fuel containing a maximum of 85% ethanol (E85).

In very cold conditions, it may be very difficult or even impossible to start the engine. To avoid this problem, use unleaded petrol or, for equipped vehicles, use the heater integrated into the engine: connect the specified end of the extension piece supplied into the socket integrated into the radiator grille and the other end into a **220V** socket for at least 6 hours before starting.

Note: you may notice an increase in fuel consumption with this type of fuel.



Do not mix even small amounts of petrol (unleaded or E85) with diesel.

Do not use ethanol-based fuel if your vehicle is not compatible with this fuel.

FUEL TANK (2/2)

Filling with fuel

Unscrew fuel filler cap **B** anticlockwise to open it. Insert the nozzle fully before turning it on to fill the fuel tank (risk of splashing).

Keep the nozzle in this position throughout the entire filling operation. When the pump cuts out automatically at the end of the filling procedure, a maximum of two further filling attempts may be made, as there must be sufficient space in the fuel tank to allow for expansion.

Make sure that no water enters the fuel tank during filling. Fuel filler cap **B** and its surround must remain clean.

Petrol versions

Using leaded petrol will damage the antipollution system and may lead to a loss of warranty.

To ensure that the fuel tank is not filled with leaded petrol, the fuel tank filler neck contains a restrictor fitted with a foolproof system which **only allows the nozzle for unleaded petrol to be used** (at the pump).



Persistent smell of fuel

If you notice a persistent smell of fuel you should:

- stop the vehicle as soon as traffic conditions allow and switch off the ignition;
- switch on the hazard warning lights and ask your passengers to leave the vehicle and to keep away from traffic;
- contact an approved Dealer.



No modifications whatsoever are permitted on any part of the fuel supply system (computers, wiring, fuel circuit, injector, protection covers, etc.) as this may be dangerous (such work must be undertaken by qualified Network personnel).



Section 2: Driving

(Advice on use relating to fuel economy and the environment)

Running in	2.2
Starting - stopping the engine	2.3
Stopping the engine.	2.6
Special features of petrol versions	2.7
Special features of diesel versions	2.8
Gear lever/handbrake	2.9
Electronic parking brake	2.10
Advice: antipollution and fuel economy	2.14
Environment	2.17
Tyre pressure monitor	2.18
Driving correction devices	2.21
Speed limiter	2.25
Cruise control	2.28
Parking distance control	2.33
Reversing camera	2.36
Automatic gearbox.	2.37

RUNNING IN

Petrol version

For approximately the first **600 miles (1,000 km)**, do not exceed 3,000 to 3,500 rpm.

Do not exceed 78 mph (130 km/h) in the highest gear, and avoid sudden acceleration, starting or stopping.

After **600 miles (1,000 km)**, you may drive faster. Your vehicle will only perform optimally after approximately 1,800 miles (3,000 km).

Service interval: refer to the Maintenance Service Document for the vehicle.

Diesel version

For the first **900 miles (1,500 km)**, do not exceed 2,500 rpm. After this mileage, you may drive faster. Your vehicle will only perform optimally after approximately 3,600 miles (6,000 km).

Do not accelerate hard while the engine is still cold and do not let the engine over-rev or stop suddenly.

Service interval: refer to the Maintenance Service Document for the vehicle.

STARTING THE ENGINE (1/3)

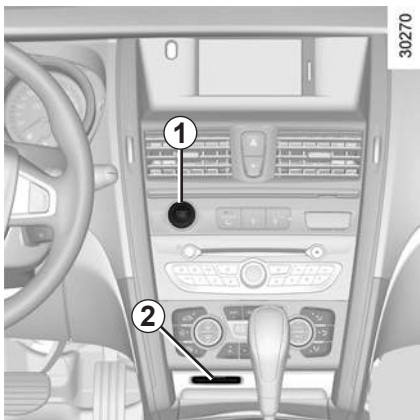

Remote control RENAULT card

When you get into the vehicle, insert the RENAULT card fully into card reader **2**. To start, press button **1**. If a gear is engaged, depress the clutch pedal to start the vehicle.

Hands-free RENAULT card

The RENAULT card must be in detection zone **3** or inserted in card reader **2**. To start, depress the brake or clutch pedal and press button **1**. If a gear is engaged, the vehicle may only be started by depressing the clutch pedal.



30185

Vehicles with an automatic gearbox

The lever should be in position **P**.

For all vehicles:

- If one of the starting conditions is not met, the message “Apply brake + START”, “Press clutch + START” or “Gear lever to P” is displayed on the instrument panel.
- In some cases it will be necessary to move the steering wheel while pressing start button **1** to assist in unlocking the steering column; a message on the instrument panel “Turn steering wheel + START” warns of this.

Starting with the trunk lid open (in hands-free mode)

In this case, the RENAULT card must not be located in the luggage compartment.

If the doors and/or trunk lid are locked by pressing the button on the door handle, or using the locking/unlocking button on the hands-free RENAULT card, you must insert the card in reader **2** to start the vehicle.

STARTING THE ENGINE (2/3)

What to do if the vehicle will not start

If the starting conditions are not met, the messages or warning lights shown below will be displayed on the instrument panel:

- “Gear lever to P”: place the gear lever in position **P** and start the engine;
- “Apply brake + START” or “Press clutch + START”: depress the brake/clutch pedal then press the Start/Stop button;
- “Turn steering wheel + START”: if the steering column is locked, you will need to move the steering wheel while pressing the Start/Stop button to unlock it;
- “Low card battery” or “Please insert keycard”: insert the card in the card reader if the card battery is discharged or faulty;

- on diesel versions, if the  warning light comes on, it indicates preheating (the engine may not start); wait until the light goes out. Once preheating is completed, the warning light goes out and the engine starts automatically.

Precautions

- In cold weather, or if the vehicle has not been started for a while, do not accelerate hard when the engine is cold.
- In cold weather, the rpm may increase initially
- You may hear noise until the engine has warmed up.

STARTING THE ENGINE (3/3)



Accessories function

(switching on the ignition)

Once you have gained access to your vehicle, you may use some of its functions (radio, navigation, wipers, etc.).

To use the other functions, press button **1**, without depressing any pedals.

Note: depending on the vehicle, pressing button **1** starts the engine.

Operating faults

In some cases, the hands-free RENAULT card will not operate, or its access area will be modified:

- when the RENAULT card battery is drained, flat battery, etc.
- near to appliances operating on the same frequency as the card (monitor, mobile phone, video game, etc.);
- vehicle located in a high electromagnetic radiation zone.

The message “Please insert keycard” is displayed on the instrument panel.

Insert the RENAULT card fully in reader **2**.



Driver's responsibility

Never leave your vehicle with the RENAULT card inside and never leave a child (or a pet) unsupervised, even for a short while.

They may pose a risk to themselves or to others by starting the engine, activating equipment such as the electric windows or by locking the doors.

Risk of serious injury.

STOPPING THE ENGINE

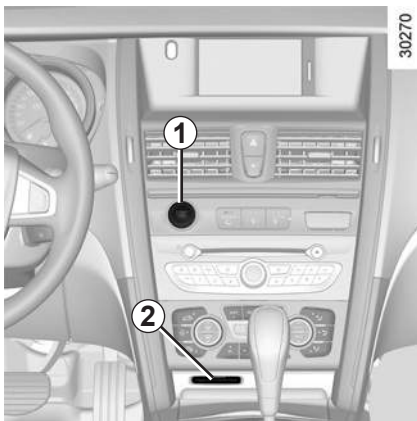

Conditions for stopping the engine

The vehicle must be stationary, with the gear lever at **N** or **P** (vehicles with an automatic transmission).

Remote control RENAULT card

With the card in reader **2**, press button **1**: the engine will stop. Removing the card from reader **2** locks the steering column.

If the card is no longer in the reader when you press button **1**, the message “No keycard Press and hold” appears on the instrument panel. Press and hold button **1** to stop the engine.

Hands-free RENAULT card

With the card in the vehicle, press button **1**: the engine will stop. The steering column is locked when the driver's door is opened or the vehicle is locked. If the card is no longer in the passenger compartment when you press button **1**, the message “No keycard Press and hold” appears on the instrument panel. Press and hold button **1** to stop the engine.

With the engine switched off, any accessories being used (radio, etc.) will continue to function for approximately 10 minutes.

When the driver's door is opened, the accessories stop working.

Note: if the accessories (radio, etc.) have been switched on after the engine has been switched off, they will switch off when the driver's door is opened (however, the exterior lights do not go out, but a beep sounds).



When you leave your vehicle, especially if you have your RENAULT card with you, check that the engine is completely switched off.



Never leave your vehicle with the RENAULT card inside and never leave a child (or a pet) unsupervised, even for a short while.

There is a risk that they could start the engine or operate electrical equipment (electric windows etc.) and trap part of their body (neck, arms, hands, etc.).

Risk of serious injury.

Never switch off the ignition before the vehicle has stopped completely. Once the engine has stopped, the brake servo, power-assisted steering, etc. and the passive safety devices such as air bags and pretensioners will no longer operate.

SPECIAL FEATURES OF PETROL VERSIONS

The following operating conditions:

- driving for long periods when the low fuel level warning light is lit;
- using leaded petrol;
- using fuel or lubrication additives which are not approved.

Or operating faults such as:

- faulty ignition system, running out of fuel or spark plug disconnected resulting in the engine misfiring and hesitation when driving;
- loss of power;

may cause the catalytic converter to overheat, reducing its efficiency which may irreparably **damage it and cause heat damage to the vehicle.**

If you notice any of the above operating faults, have the necessary repairs carried out as soon as possible by an approved dealer.

You can avoid these problems by regularly taking your vehicle to an approved dealer at the intervals specified in the Maintenance Service Document.

Starting problems

To avoid damaging the catalytic converter, **do not keep trying to start the engine (using the start button, or by pushing or towing the vehicle) without having identified and corrected the starting fault.**

If you cannot identify the cause of the fault, do not try to start the engine. Consult an approved dealer.





Do not park the vehicle or run the engine in locations where combustible substances or materials such as grass or leaves can come into contact with the hot exhaust system.

SPECIAL FEATURES OF DIESEL VERSIONS

Diesel engine speed

Diesel engines are fitted with injection equipment **which prevents the engine speed being exceeded** irrespective of the gear selected.

If the message “Check antipollution system” is displayed on the instrument

panel accompanied by the  and  warning light; consult an approved Dealer straight away.

When driving, depending on the fuel grade used, it is possible that white smoke may be emitted.

This is due to the exhaust particle filter being cleaned automatically, and does not affect the way the vehicle runs.

Running out of fuel

If the **tank has been completely drained**, the system must be reprimed after the tank is refilled.

Precautions to be taken in winter

To avoid faults in icy weather:

- ensure that the battery is always fully charged;
- always keep the diesel tank relatively full to avoid water vapour condensing in it and accumulating at the bottom of the tank.



Do not park the vehicle or run the engine in locations where combustible substances or materials such as grass or leaves can come into contact with the hot exhaust system.

GEAR LEVER/HANDBRAKE



Selecting reverse gear

Vehicles with manual gearbox: follow the grid drawn on knob **1**, and depending on the vehicle, lift ring **2** against the gear lever knob to select reverse.

Vehicle with automatic gearbox: refer to the information on the “Automatic gearbox” in Section 2.

The reversing lights will come on as soon as reverse gear is selected with the ignition on.



An impact to the underside of the vehicle (e.g.: striking a post, raised kerb or other street furniture) may result in damage to the vehicle (e.g.: deformation of an axle).

To avoid any risk of accident, have your vehicle checked by an approved Dealer.

Handbrake

To release:

Pull lever **4** slightly, press button **3** and then lower the lever to the floor.

To apply:

Pull lever **4** upwards and make sure the vehicle is immobilised.



Make sure that the handbrake is properly released when driving (red indicator light off), otherwise overheating may occur.



When stationary and depending on the slope and/or vehicle load, it may be necessary to pull up the handbrake at least two extra notches and engage a gear (1st or reverse gear) for vehicles with a manual gearbox or position **P** for vehicles with an automatic transmission.

ELECTRONIC PARKING BRAKE (1/4)



Automatic operation

The electronic parking brake can be used to immobilise the vehicle **when the engine is stopped by pressing button 1**.

In all other instances, e.g. engine stalling, the electronic parking brake is not applied automatically. Manual mode must be used.

For certain country-specific model versions, the automatic brake application function is not activated. Refer to the information on “Manual operation”.



To confirm that the electronic parking brake is applied, the message “Parking brake on” and the indicator light  on the instrument panel and indicator light **2** on the switch light up.

After the engine is switched off, indicator light **2** goes out several minutes after the electronic parking brake has been applied and indicator light  goes out when the vehicle is locked.

Note: the message “Apply parking brake” is displayed on the instrument panel, accompanied by a beep, to warn you that the electronic parking brake is released:

- with the engine running: when the driver’s door is opened;

- with the engine switched off (eg. when the engine stalls): when a front door is opened.

In this case, pull and release switch **3** to apply the electronic parking brake.

Automatic releasing of the electronic parking brake

The brake will be released as soon as the vehicle starts and accelerates.



Before leaving the vehicle, check that the electronic parking brake is fully applied. Indicator light **2** on the

switch **3** and indicator light  on the instrument panel lights up to show that the parking brake is applied but go out when the doors are locked.

ELECTRONIC PARKING BRAKE (2/4)

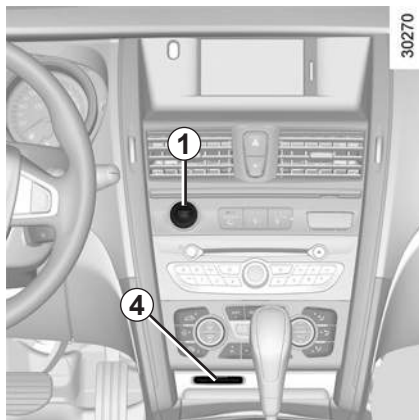

Manual operation

Applying the electronic parking brake

Pull switch **3**. To confirm that the electronic parking brake is applied, the message “Parking brake on” and indicator

light **(P)** on the instrument panel and indicator light **2** on the switch light up.

Releasing the electronic parking brake

With the ignition on, depress the brake pedal then press switch **3**: indicator lights **2** and **(P)** go out.



Brief stop

In all circumstances, you can manually activate the electronic parking brake (stopping at traffic lights, on a slope, etc.). Pull switch **3** and release it.

The brake is released as soon as the vehicle is started up again.

Special cases

When parking on a slope or towing a trailer, pull switch **3** for a few seconds to obtain maximum braking.

Note: if the vehicle is not immobilised when the parking brake is applied, the message “Stop vehicle” is displayed on the instrument panel.

In this case, move the vehicle and park it on level ground.

To park the vehicle without applying the electronic parking brake (if there is a risk of freezing, for example):

- with the engine running and the RENAULT card in reader **4**, switch off the engine by pressing engine Start/Stop button **1**;
- select a gear (manual gearbox) or position **P** (automatic gearbox);
- depress the brake pedal and press switch **3** at the same time;
- remove the RENAULT card from the card reader.

When the driver's door is opened, the message “Apply parking brake” is displayed on the instrument panel accompanied by a beep. The beep stops when the door is closed.

ELECTRONIC PARKING BRAKE (3/4)



Versions with an automatic gearbox

If the driver's door is open or not properly closed, automatic release is deactivated for safety reasons if the gear lever is not at **P** or **N** (to prevent the vehicle from moving on its own). The message "Release manually parking brake" is displayed on the instrument panel. In this case, to start, release the parking brake manually by depressing the brake pedal and pressing switch **3**.

Automatic release is reactivated when the driver's door is closed and the gear lever moved to position **P** or **N** before moving to **D** or **R**.



It is therefore essential to immobilise the vehicle by engaging first gear (manual gearbox) or position **P** (automatic gearbox). If the slope requires it, chock the vehicle.



Never leave your vehicle without moving the selector lever to position **P** or **N**.

This is because when the vehicle is stationary with the engine running and a gear engaged, the vehicle may begin to move if you accelerate.

There is a risk of accidents.

ELECTRONIC PARKING BRAKE (4/4)



Operating faults

- If the parking brake status is not displayed on the instrument panel, the message “Stop vehicle” appears accompanied by a beep.

Apply the parking brake manually by pulling switch **3** before leaving the vehicle. If the problem recurs, consult an approved Dealer.

- If there is a fault, the  warning light on the instrument panel comes on accompanied by the message “Check parking brake”.



Contact your approved Dealer as soon as possible.

- If there is a fault with the connection between the braking system and the instrument panel, the message “Stop vehicle” is displayed on the instrument panel accompanied by the  warning light and a beep.

Stop as soon as traffic conditions allow and consult an approved Dealer.



It is therefore essential to immobilise the vehicle by engaging first gear (manual gearbox) or position **P** (automatic gearbox). If the slope requires it, chock the vehicle.

- If there is a serious fault, the message “Parking brake fault” is displayed on the instrument panel accompanied by the  and  warning lights and a beep.

In this case, stop as soon as traffic conditions allow and consult an approved Dealer.



If no lights or sounds are apparent, this indicates a fault in the instrument panel. This indicates that it is essential to stop immediately (as soon as traffic conditions allow). Ensure that the vehicle is correctly immobilised and contact an approved Dealer.

ADVICE: antipollution, fuel economy and driving (1/3)

By virtue of its design, moderate fuel consumption and initial settings, your vehicle conforms to current antipollution regulations. The manufacturer is actively striving to reduce pollutant exhaust gas emissions and to save energy. But the fuel consumption of your vehicle and the level of pollutant exhaust gas emissions are also your responsibility. Ensure that it is maintained and used correctly.

Aiding fuel economy

Depending on the vehicle, in order to optimise consumption, an indicator light on the instrument panel will inform you of the best moment to upshift or downshift gears:



shift up a gear;



shift down a gear.

Maintenance

It is important to remember that failure to respect antipollution regulations could lead to legal action being taken against the vehicle owner. In addition, replacing engine, fuel supply system and exhaust components with parts other than those originally recommended by the manufacturer may alter your vehicle so that it no longer complies with antipollution regulations.

Have your vehicle adjusted and checked by an approved Dealer, in accordance with the instructions given in your maintenance schedule: they will have all the equipment necessary for ensuring that your vehicle is maintained to its original standard.

Engine adjustments

- **ignition:** this does not require adjustment.
- **spark plugs:** for optimum fuel economy, efficiency and performance the specifications laid down by our Design Department must be strictly applied.

If the spark plugs have to be changed, use the make, type and gap specified for your vehicle's engine. Contact an approved Dealer for this.
- **idle:** this does not require adjustment.
- **air filter, diesel filter:** a clogged element reduces performance. It must be replaced.

ADVICE: antipollution, fuel economy and driving (2/3)

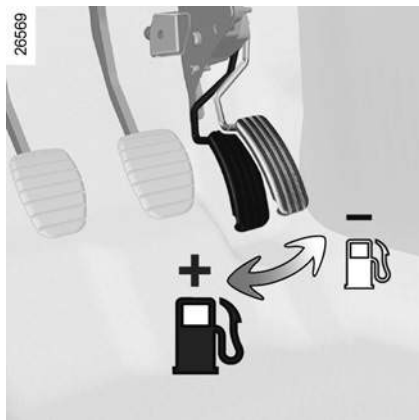

Exhaust gas monitoring system

The exhaust gas monitoring system will detect any operating faults in the vehicle's antipollution system.

If this system malfunctions, toxic substances may be released into the atmosphere or damage may occur.



This warning light on the instrument panel will indicate if there are any faults in the system:

This lights up when the ignition is switched on and goes out when the engine is started.

- If it lights up continuously, consult an approved Dealer as soon as possible;
- if it flashes, reduce the engine speed until the light stops flashing. Contact your approved Dealer as soon as possible.

Driving

- Drive carefully for the first few miles until the engine reaches its normal operating temperature, rather than let it warm up while the vehicle is stationary.
- Speed is expensive.
- Sporty driving uses a lot of fuel: drive with a light right foot.
- Brake as little as possible. If you anticipate an obstacle or bend in advance, you may then simply release the accelerator pedal.
- Avoid sudden acceleration.
- Do not overrev the engine in the intermediate gears.

Always use the highest gear possible without labouring the engine.

On versions with an automatic gearbox, it is preferable to keep the gear lever in position **D**.

- Do not try to maintain the same speed up a hill, accelerate no more than you would on the level. Keep your foot in the same position on the accelerator pedal.
- Double declutching and accelerating before switching off are unnecessary in modern vehicles.
- Bad weather, flooded roads:



Do not drive through floods if the water is above the lower edge of the wheel rims.



Obstructions to the driver

On the driver's side, only use mats adapted to the vehicle that attach to the pre-installed parts, and regularly check their mounting. Do not place several mats on top of each other.

Risk of pedals jamming

ADVICE: antipollution, fuel economy and driving (3/3)

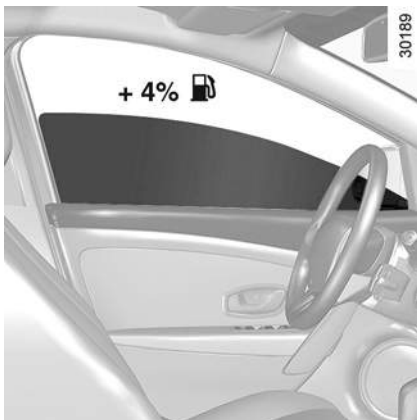

Advice on use

- Electricity is fuel; switch off all the electrical components which are not really needed. **However** (safety first), keep your lights on when the visibility is bad ("see and be seen").
- Use the air vents. Driving with the windows open at 60 mph (100 km/h) will increase fuel consumption by 4%.

- In vehicles fitted with air conditioning, it is normal to observe an increase in fuel consumption (especially in urban conditions) when it is used. For vehicles fitted with manual air conditioning, switch off the system when it is not required.

Advice for reducing consumption and therefore helping to preserve the environment:

If the vehicle has been parked in the sun, open the doors for a few moments to let the hot air escape before starting the engine.

- Never fill the fuel tank right to the brim to avoid overflow.
- Do not leave an empty roof rack fitted to the vehicle.
- It is better to fit a trailer for bulky objects.
- When towing a caravan, fit a wind deflector and adjust it carefully.

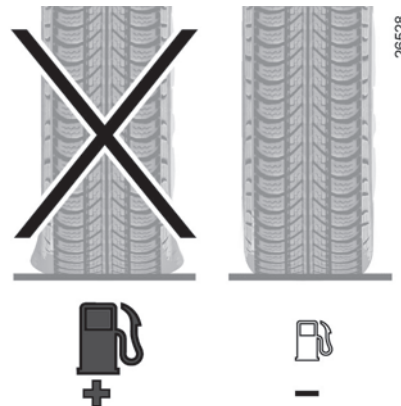

- Avoid using the car for door-to-door calls (short journeys with long waits in between) because the engine never reaches its normal operating temperature.

Tyres

- An underinflated tyre increases fuel consumption.
- The use of non-recommended tyres can increase fuel consumption.

ENVIRONMENT

Your vehicle has been designed with respect for the **environment** in mind for its entire service life: during production, use and at the end of its life.

This commitment is illustrated by the Renault eco² group signature.



31016

Manufacture

Your vehicle has been manufactured at an industrial site which uses a progress policy to reduce environmental impacts on rivers and natural areas (reduction of water and energy consumption, visual and noise pollution, atmospheric emissions and waste water, sorting and reusing waste).

Emissions

Your vehicle has been designed to emit fewer greenhouse gases (CO₂) while in use, and therefore to consume less fuel (eg. 140 g/km, equivalent to 5.3 l/100 km for a diesel vehicle).

Our vehicles are also equipped with a particle filter system including a catalytic converter, an oxygen sensor and an active carbon filter (the latter prevents vapour from the fuel tank being released into the open air).

Please make your own contribution towards protecting the environment too.

- Worn parts replaced in the course of routine vehicle maintenance (vehicle battery, oil filter, air filter, batteries, etc.) and oil containers (empty or filled with used oil) must be disposed of through specialist organisations.
- At the end of the vehicle's service life, it should be sent to approved centres to ensure that it is recycled.
- In all cases, comply with local legislation.

Recycling

Your vehicle is 85% recyclable and 95% recoverable.

To achieve these objectives, many of the vehicle components have been designed to enable them to be recycled. The materials and structures have been carefully designed to allow these components to be easily removed and reprocessed by specialist companies.

In order to preserve raw material resources, this vehicle incorporates numerous parts made from recycled plastics or renewable materials (vegetable or animal-derived materials such as cotton or wool).

TYRE PRESSURE MONITOR (1/3)

If the vehicle is equipped with the function, this system monitors the tyre pressure.

Operating principle

Each wheel (except for the emergency spare wheel) has a sensor in the inflation valve which periodically measures the tyre pressure.

The system informs the driver via trip computer and warning system **1** that the tyres are sufficiently inflated and warns if they are underinflated or leaking.

The system displays tyre pressure information on trip computer and warning system **1**:

- with the ignition on, by scrolling through the information using control **2** (refer to the information on the “Trip computer and warning system” in Section 1);
- or if there is a fault when driving (refer to the following page to find out more about the warning messages).

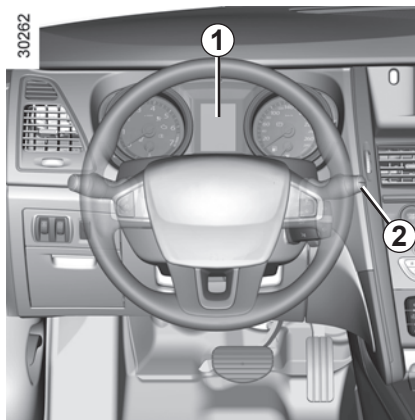

This function is an additional driving aid.

However, the function does not take the place of the driver. It cannot, therefore, under any circumstances replace the vigilance or the responsibility of the driver.

Check the tyre pressures, including the emergency spare wheel, once a month.

The pressures must be adjusted when the tyres are cold.

Refer to the information on “Tyre pressures”.

If tyre pressures cannot be checked when the tyres are **cold**, increase the recommended values by **0.2 to 0.3 bar** (3 psi).

Never deflate a hot tyre.

TYRE PRESSURE MONITOR (2/3)

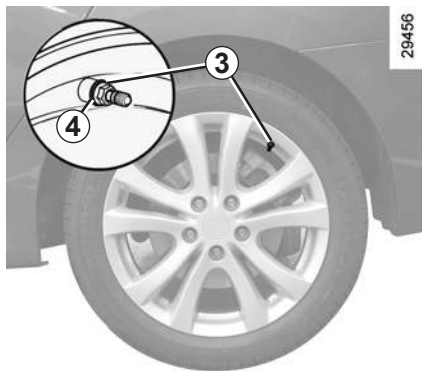

Changing wheels around

If you wish to swap the wheels around, you **must** consult an approved dealer to reinitialise the system.

To mark the correct position of the wheel, note the colour of ring **4** (after cleaning, if necessary) on each valve:

- A** yellow ring
- B** black ring
- C** red ring
- D** green ring

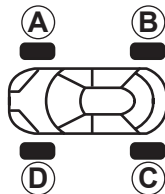

Each of the sensors incorporated in the valves **3** is dedicated to a single wheel: under no circumstances should you swap the wheels, without resetting the system.

There is a risk of incorrect information which could have serious consequences.

Emergency spare wheel

The emergency spare wheel has no sensor and cannot therefore be detected by the system.

When it is fitted to the vehicle, the message “Tyre pressure sensors absent” is displayed on the instrument panel.

Replacing wheels/tyres

This operation requires specific equipment (wheels, tyres, wheel trims, etc.). Consult an approved dealer to fit new tyres. The use of any other accessory may prevent the system from operating correctly.

Tyre repair products

Because the sensors built into the valves are specially designed, use only products approved by our Technical Department.





Fitting wheels (changing or use in winter)

There are some precautions which must be taken. Consult an approved dealer.

TYRE PRESSURE MONITOR (3/3)

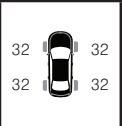
Operating faults

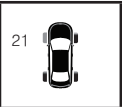
If there are any anomalies during inflation, the following messages will appear on the instrument panel to inform you:

Examples of selections		Interpreting the display selected
"Inflate tyres for motorway"		The tyre pressure is not suitable for the driving speed. Slow down or inflate all four tyres to motorway pressure (refer to the information on "Tyre pressure" in Section 4).
"Adjust tyre pressure"		The indicated tyre pressure is lower than normal.
"Puncture"		The STOP warning light comes on accompanied by a beep. Replace it or contact an approved dealer. The indicated tyre is punctured or severely underinflated.
"Tyre pressure sensors absent"		A wheel disappearing indicates that the sensor on this wheel is missing or faulty (e.g. if the emergency spare wheel is fitted).
"Check tyre pressure sensors"		Not all of the sensors are detected or there is a system fault.

DRIVING CORRECTION DEVICES (1/4)

Depending on the vehicle, they may comprise:

- the **ABS (anti-lock braking system)**;
- **emergency brake assist with, depending on the vehicle, braking anticipation**;
- the **electronic stability program ESP with understeer control and traction control ASR**.



These functions are an additional aid in the event of critical driving conditions, enabling the vehicle behaviour to be adapted to suit the driving conditions.

However, the functions do not take the place of the driver. **They do not increase the vehicle's limits and should not encourage you to drive more quickly.** Therefore, they can under no circumstances replace the vigilance or responsibility of the driver when manoeuvring the vehicle (the driver must always be ready for sudden incidents which may occur when driving).

ABS (anti-lock braking system)

Under heavy braking, the ABS prevents the wheels from locking, allowing the stopping distance to be managed and keeping control of the vehicle.

Under these circumstances, the vehicle can be steered to avoid an obstacle whilst braking. In addition, this system can increase stopping distances, particularly on roads with low surface grip (wet ground etc.).

You will feel a pulsation through the brake pedal each time the system is activated. The ABS does not in any way improve the vehicle's physical performance relating to the road surface and roadholding. It is still **essential** to follow the rules of good driving practice (such as driving at a safe distance from the vehicle in front etc.).

In an emergency, apply firm and continuous pressure to the brake pedal. There is no need to pump it repeatedly. The ABS will modulate the force applied in the braking system.

DRIVING CORRECTION DEVICES (2/4)

Operating faults:

-  and  lit on the instrument panel accompanied by the message “Check ABS”: this means the ABS is deactivated. Braking safety is still guaranteed.

Consult an approved Dealer.

-  and  lit on the instrument panel accompanied by the message “Braking system fault”: this indicates a fault in the braking system.

Stop the vehicle as soon as possible and consult an approved Dealer.



Your braking systems are partially operational. However, it is **dangerous to brake suddenly** and it is essential to stop immediately, as soon as traffic conditions allow. Contact an approved Dealer.

Emergency brake assist

This is an additional system to ABS which helps reduce vehicle stopping distances.

Operating principle

The system is for detecting an emergency braking situation. In this case, braking assistance instantly develops its maximum power and may trigger ABS regulation.

ABS braking is maintained as long as the brake pedal is applied.

Hazard warning lights switching on

Depending on the vehicle, these may light up in the event of sudden deceleration.

Operating faults

When the system detects an operating fault, the message “Check braking system” is displayed on the instrument panel accompanied by the  warning light.

Consult an approved Dealer.

Braking anticipation

Depending on the vehicle, when you rapidly release the accelerator, the system anticipates the braking manoeuvre in order to reduce stopping distances.

Special cases

When using the cruise control:

- if you use the accelerator, when you release it, the system may be triggered;
- if you do not use the accelerator, the system will not be triggered.

DRIVING CORRECTION DEVICES (3/4)

Electronic stability program ESP with understeer control and traction control ASR

Electronic Stability Program (ESP)

This system helps you to keep control of the vehicle in critical driving conditions (avoiding an obstacle, loss of grip on a bend, etc.).

Operating principle

A sensor in the steering wheel detects the direction selected by the driver. Other sensors throughout the vehicle measure the actual direction.

The system compares driver input to the actual trajectory of the vehicle and corrects the trajectory if necessary by controlling the braking of certain wheels and/or engine power. In the event that the system is engaged, indicator light



comes on the instrument panel.

Understeer control

This system optimises the action of the ESP in the case of pronounced understeering (loss of front axle road holding).

Traction Control ASR

This system helps to limit wheelspin of the drive wheels and to control the vehicle when pulling away accelerating or decelerating.

Operating principle

The system uses wheel sensors to constantly measure and compare the speed of the drive wheels and detect spinning. If a wheel is starting to slip, the system brakes automatically until the drive supplied becomes compatible with the level of grip under the wheel again.

The system also adjusts the engine speed to the grip available under the wheels, independently of the pressure exerted on the accelerator pedal.



lit indicates that the ESP system (with the ASR) is active. When the ESP is active, there may be a slight vibration. This is completely normal.

If you depress the brake pedal continuously when driving downhill for long periods, the braking system may heat up, reducing the quality of the braking. In this case, use the engine brake.

DRIVING CORRECTION DEVICES (4/4)

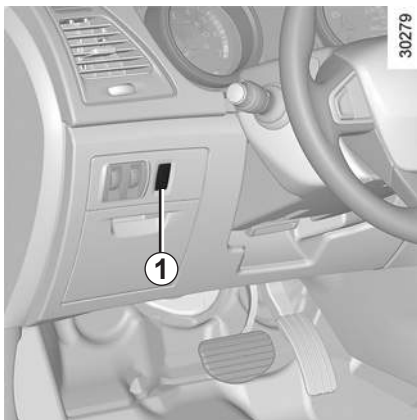

Operating faults

When the system detects an operating fault, the  warning light appears on the instrument panel accompanied by the message “Check ESP”.

In this case, the ESP and the ASR are deactivated. Consult an approved Dealer.

Disabling the ASR function

In some situations (driving on very wet ground: snow, mud, etc. or driving with snow chains fitted), the system may reduce the engine output to limit wheel-spin. If this is not required, it is possible to deactivate the function by pressing switch **1**.

The message “Traction control off” appears on the instrument panel to warn you.

The ASR is an additional safety system. It is not advisable to drive with the function disabled. Correct this as soon as possible by pressing switch **1** again.

Note: the function is automatically re-activated when the vehicle exceeds a speed of approximately 24 mph (40 km/h).

CRUISE CONTROL - SPEED LIMITER: limiter function (1/3)



The speed limiter function helps you stay within the driving speed limit that you choose, known as the **limit speed**.

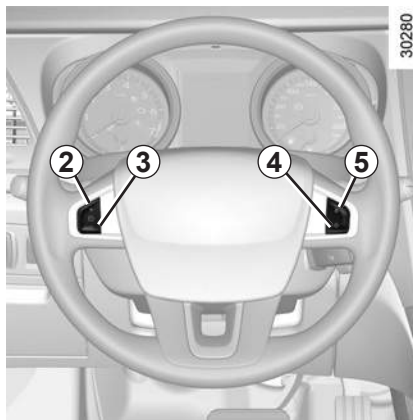

Controls

- 1 Main “On/Off” switch.
- 2 Limit speed activation, storage and increase switch (+).
- 3 Decrease limit speed (-).
- 4 Switch the function off (with limit speed storage) (O).
- 5 Activation and recall of stored limit speed (R).

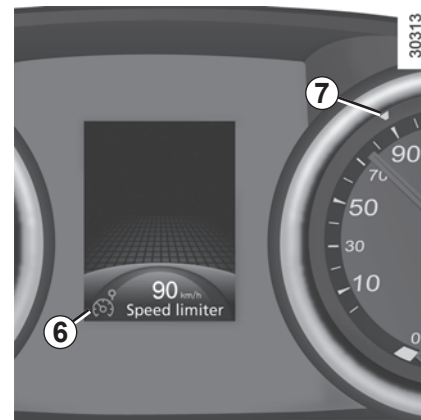

Switching on

Press switch **1** on the side showing . Indicator light **6** comes on, lit orange, and the message “speed limiter” appears on the instrument panel, accompanied by dashes to indicate that the speed limiter function is activated and waiting to store a limit speed.

To store the current speed, press switch **2** (+):

- the limited speed will replace the dashes;
- indicator light **7** comes on, lit orange, and indicates the limited speed.

The minimum stored speed is 20 mph (30 km/h).

CRUISE CONTROL - SPEED LIMITER: limiter function (2/3)



Driving

When a limited speed has been stored and this speed is not reached, driving is similar to driving a vehicle without the speed limiter function.

Once you have reached the stored speed, no effort on the accelerator pedal will allow you to exceed the programmed speed except in an emergency (refer to information on “Exceeding the limit speed”).

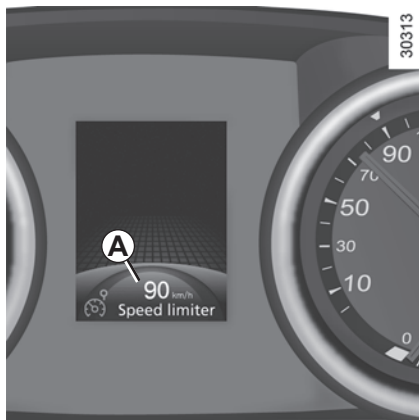

Varying the limit speed

To vary the limit speed, press switch **2** (+) repeatedly to increase the speed or switch **3** (-) to decrease.

Exceeding the limit speed

It is possible to exceed the limit speed at any moment. To do this: press the accelerator pedal **firmly and fully** (beyond the kickdown point).

The programmed speed flashes on the instrument panel along with the illumination of zone **A** in red.

Then, release the accelerator pedal: the speed limiter function will return as soon as you reach a speed lower than the stored speed.

Limited speed cannot be maintained

If driving up or down a steep gradient, the system is unable to maintain the limit speed: the stored speed on the instrument panel will flash and zone **A** light up in red to inform you of this situation.



The speed limiter function is in no way linked to the braking system.

CRUISE CONTROL - SPEED LIMITER: limiter function (3/3)



Putting the function on standby

The speed limiter function is suspended when you press switch **4** (O). In this case, the limit speed remains stored and the message “Memorised” accompanied by this speed appears on the instrument panel.

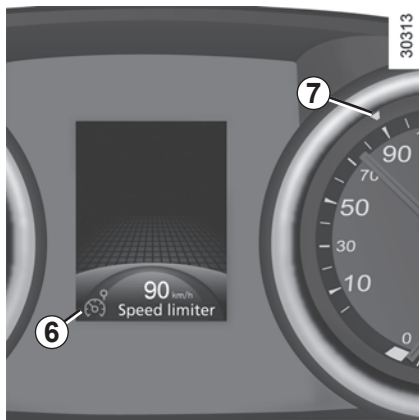

Recalling the limit speed

If a speed has been stored, it can be recalled by pressing switch **5** (R).

When the speed limiter is suspended, pressing switch **2** (+) reactivates the function without taking into account the stored speed: it is the speed at which the vehicle is moving that is taken into account.



Switching off the function

The speed limiter function is deactivated if you press switch **1**: in this case a speed is no longer stored. The instrument panel orange indicator lights **6** and **7** go out to confirm that the function is deactivated.

CRUISE CONTROL - SPEED LIMITER: cruise control function (1/5)



The cruise control function helps you to maintain your driving speed at a speed that you choose, called the **cruising speed**.

This cruising speed may be set at any speed above 20 mph (30 km/h).



The cruise control function is in no way linked to the braking system.



This function is an additional driving aid. However, the function does not take the place of the driver.

Therefore, it can under no circumstances replace the driver's responsibility to respect speed limits and to be vigilant (the driver must always be ready to brake). Cruise control must not be used in heavy traffic, on undulating or slippery roads (black ice, aquaplaning, gravel) and during bad weather (fog, rain, side winds etc.).

There is a risk of accidents.

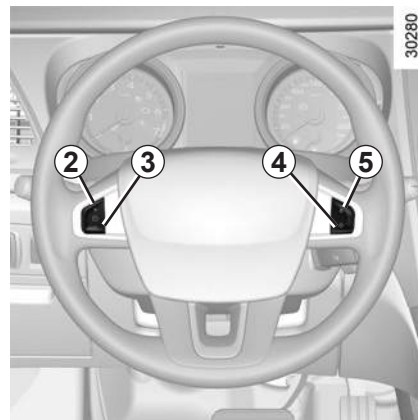

Controls

- 1 Main "On/Off" switch.
- 2 Cruising speed activation, storage and increase switch (+).
- 3 Decrease cruising speed (-).
- 4 Switch the function off (with storage of cruising speed) (O).
- 5 Activation with recall of stored cruising speed (R).

CRUISE CONTROL - SPEED LIMITER: cruise control function (2/5)



Switching on

Press switch **1** on the side showing . Indicator light **6** comes on, lit green, and the message “cruise control” appears on the instrument panel, accompanied by dashes to indicate that the cruise control function is activated and waiting to store a cruising speed.

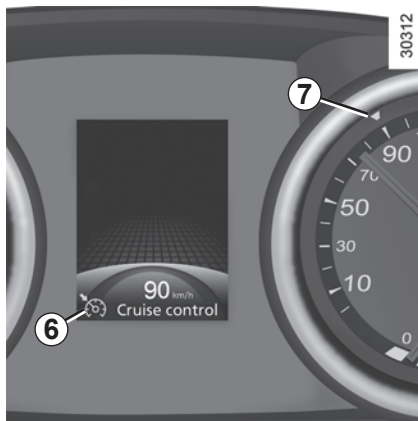

Activating cruise control

At a steady speed (above 20 mph (30 km/h) approximately) press switch **2** (+): the function is activated and the current speed is stored.

Cruise control activation is confirmed when indicator light **7** is lit up in green in addition to indicator light **6**. Light **7** also indicates the cruising speed by coming at the level of the figure corresponding to the selected speed.

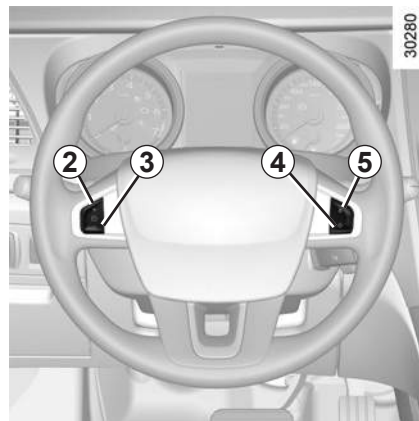

Driving

Once a cruising speed is stored and the cruise control function is active, you may lift your foot off the accelerator pedal.



Important: you are nevertheless advised to keep your feet close to the pedals in order to react if necessary.

CRUISE CONTROL - SPEED LIMITER: cruise control function (3/5)



Adjusting the cruising speed

The cruising speed may be changed by pressing the following repeatedly:

- switch **2** (+) to increase the speed,
- switch **3** (-) to decrease the speed.

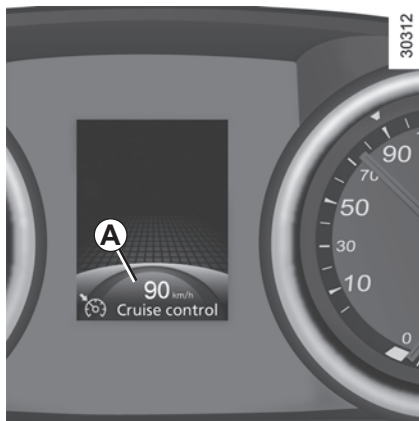

Exceeding the cruising speed

The cruising speed may be exceeded at any time by depressing the accelerator pedal. The cruising speed flashes on the instrument panel along with the illumination of zone **A** in red.

Then, release the accelerator: after a few seconds, the vehicle will automatically return to its set cruising speed.



The cruise control function is in no way linked to the braking system.

Cruising speed cannot be maintained

If driving up or down a steep gradient, the system is unable to maintain the cruising speed: the stored speed on the instrument panel will flash and zone **A** light up in red to inform you of this situation.

CRUISE CONTROL - SPEED LIMITER: cruise control function (4/5)



Putting the function on standby

The function is suspended when you:

- press switch **4** (O);
- depress the brake pedal;
- depress the clutch pedal or shift into neutral if the vehicle has an automatic gearbox.

In all three cases, the cruising speed remains stored and the message “Memorised” appears on the instrument panel.

Standby is confirmed when indicator light **7** goes out.

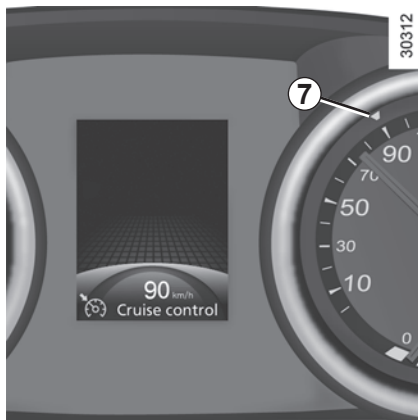

Returning to the cruising speed

If a speed is stored, it can be recalled, once you are sure that the road conditions are suitable (traffic, road surface, weather conditions, etc.). With a vehicle speed above 20 mph (30 km/h), press switch **5** (R).

Note: if the speed previously stored is much higher than the current speed, the vehicle will accelerate more rapidly to reach this threshold.

When the cruise control is suspended, pressing switch **2** (+) reactivates the function without taking into account the stored speed: it is the speed at which the vehicle is moving that is taken into account.

CRUISE CONTROL - SPEED LIMITER: cruise control function (5/5)



Switching off the function

The cruise control function is deactivated if you press switch **1**: in this case a speed is no longer stored. The instrument panel green indicator lights **6** and **7** go out, confirming that the function is deactivated.

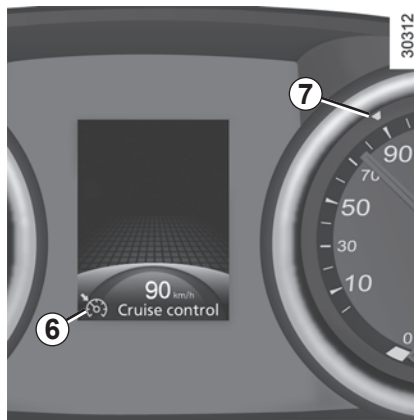

Putting the cruise control on standby or switching it off does not cause a rapid reduction in speed: you must brake by depressing the brake pedal.

PARKING DISTANCE CONTROL (1/3)

Operating principle

Ultrasonic sensors in the front or rear bumper measure the distance between the vehicle and an obstacle.

This measurement is indicated by beeps which become more frequent the closer you come to the obstacle, until they become a continuous beep when the vehicle is approximately 30 centimeters from the obstacle.

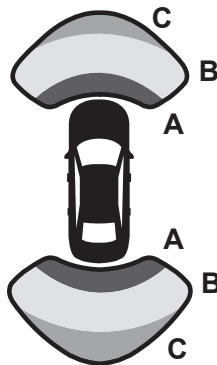

30254

Parking distance indicator

When this function is operating, the indicator is displayed on the instrument panel.

The parking distance indicator comprises coloured zones **A**, **B** and **C** indicating the distance between the vehicle and an obstacle:

- **A** (red): less than approximately 30 centimeters away from the vehicle;
- **B** (yellow): less than approximately 70 centimeters away from the vehicle;
- **C** (green): less than approximately 1 meter away from the front bumper and approximately 1.2 meters away from the rear bumper.



This function is an additional aid that indicates the distance between the vehicle and an obstacle whilst reversing, using sound signals.

Under no circumstances should it replace the driver's care or responsibility whilst reversing.

The driver should always look out for sudden hazards during driving: always ensure that there are no moving obstacles (such as a child, animal, pram or bicycle, etc.) or small, narrow objects such as stones or posts in your path when manoeuvring.

PARKING DISTANCE CONTROL (2/3)

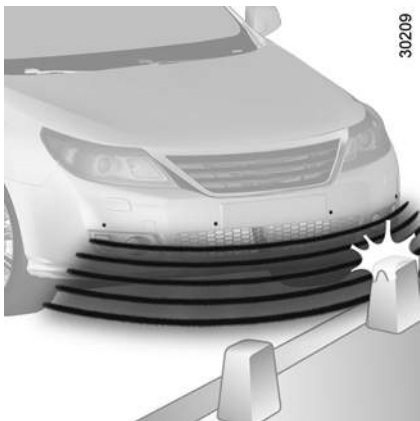

Front parking distance control

(Depending on the vehicle)

Operation

The parking distance control system is only activated when the vehicle is driven at a speed below approximately 4 mph (6 km/h).

Any object located less than approximately 60 centimetres away from the front of the vehicle is detected and a beep is emitted.

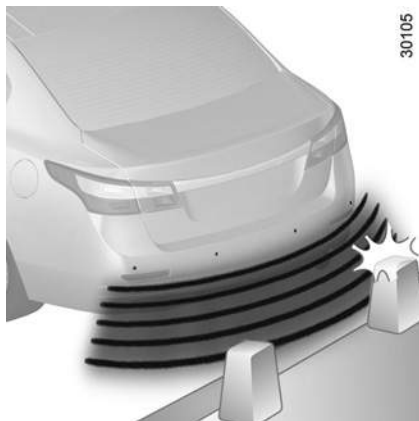

Automatic activation/deactivation of front parking distance control

The system deactivates:

- when the vehicle speed is above approximately 4 mph (6 km/h);
- When the vehicle is stationary for more than five seconds: only in the case that the vehicle speed dropped from above approximately 4 mph (6 km/h) and an obstacle is more than 30 centimetres away from the vehicle (e.g., traffic jam);
- when the vehicle is in neutral or when the gear lever has been shifted to **N** or **P** for automatic gearboxes.

Rear parking distance control

Operation

When reversing, any objects located less than approximately 1.2 metres away from the rear of the vehicle are detected and a beep is emitted.

If there are obstacles located close to both the front and rear of the vehicle, only the closest of the two will be acknowledged and the corresponding front or rear beep sound will be emitted. If obstacles are detected both to the front and to the rear of the vehicle at the same time, and they are both less than 30 centimetres away from the vehicle, the corresponding front and rear beeps will be emitted alternately.

Automatic activation/deactivation of rear parking distance control

The system deactivates:

- when the vehicle speed is above approximately 4 mph (6 km/h);
- when the vehicle is in neutral or when the gear lever has been shifted to **N** or **P** for automatic gearboxes.

PARKING DISTANCE CONTROL (3/3)

Prolonged deactivation of the system

You may permanently activate or deactivate the front or rear parking distance control separately.

From the vehicle settings customisation menu (refer to the information on the “Vehicle settings customisation menu” in Section 1), select the line “Front parking sensor” or “Rear parking sensor” then activate or deactivate the system:



: function deactivated



: function activated



An impact to the underside of the vehicle (e.g.: striking a post, raised kerb or other street furniture) may result in damage to the vehicle (e.g.: deformation of an axle).

To avoid any risk of accident, have your vehicle checked by an approved Dealer.

You can adjust the volume of the parking distance control by selecting “Parking sensor volume” in the vehicle settings customisation menu.

Special features

Make sure that the ultrasonic sensors are not obscured (by dirt, mud, snow, etc.).

Operating faults

When the system detects an operating fault, the message “Check parking sensor” is displayed on the instrument panel accompanied by the  warning light, and a beep sounds for 5 seconds to warn you. Consult an approved dealer.

Under the following conditions, the parking distance control system may not function:

- the sensors are obscured (dirt, mud, snow, etc.);
Clean with a soft cloth.
- the sensors are frozen.

Under the following conditions, the parking distance control system may malfunction:

- uneven surface, gravel track, hill, forest track, etc.
- floods or water splashes.

The system may not detect objects such as the following:

- narrow obstacles (sharp-edged objects or rope);
- materials which absorb sound waves easily (cotton, sponge, snow, etc.)

Some sources of noise (motorbike, bicycle, lorry, snow, radio transmitter, horn, etc.) may trigger beeps.

REVERSING CAMERA

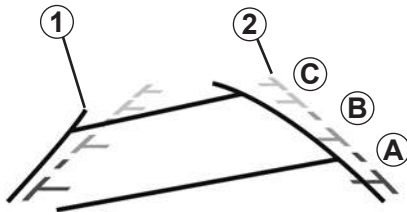

29589

Operation

When reversing (and up to approximately 5 seconds after shifting to another gear), a view of the surroundings to the rear of the vehicle is displayed on the navigation screen accompanied by two clearance gauges 1 and 2 (mobile and fixed).

Note: make sure that the reversing camera is not obscured (by dirt, mud, snow, etc.).

Mobile clearance gauge 1

(for vehicles fitted with electronic stability program)

This is shown in blue on the navigation screen. It indicates the vehicle trajectory according to the position of the steering wheel.

Fixed clearance gauge 2

The fixed clearance gauge comprises coloured markers **A**, **B** and **C** indicating the distance behind the vehicle:

- **A** (red) approximately 50 centimetres from the vehicle;
- **B** (yellow) approximately 1 metre from the vehicle;
- **C** (green) approximately 2 to 3 metres from the vehicle;

The screen shows a reverse image. The frames are a representation projected onto flat ground; this information must not be taken into account when superimposed on a vertical object or an object on the ground.

Objects which appear on the edge of the screen may be deformed.

In very bright light (snow, vehicle in sunshine etc.), the camera vision may be adversely affected.

When the luggage compartment is open or not closed properly, the message "Boot open" is displayed on the navigation screen (risk of incorrect information on-screen).

This gauge remains fixed and indicates the vehicle trajectory if the wheels are in line with the vehicle.

This system is initially used with the aid of the gauges (mobile for the trajectory and fixed for the distance), then when the red zone is reached, use the representation of the bumper to stop accurately.

Note: depending on the vehicle, certain parameters can be adjusted. Refer to the handbook for the equipment.



This function is an additional aid. It cannot, therefore, under any circumstances replace the vigilance or the responsibility of the driver.

The driver should always pay attention to sudden incidents during driving: always ensure that there are no moving obstacles (such as a child, animal, pram, bicycle, etc.) or small, narrow objects such as stones or posts in your path when manoeuvring.

AUTOMATIC GEARBOX (1/3)



Operation

With gear lever **1** in position **P**, switch on the ignition.

With your foot on the brake pedal (warning light  on display **3** goes out), move the lever out of position **P**.

To move out of position P, you must apply the brake before pressing unlocking button 2.

Only engage D or R when the vehicle is stopped, with your foot on the brake and the accelerator pedal released.

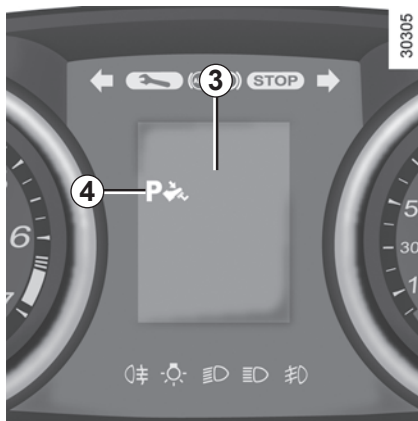

Display **3** on the instrument panel shows the mode and gear selected.

4 : zone displaying gearbox mode or gear engaged in manual mode

- P**: park
- R**: reverse gear
- N**: neutral
- D**: automatic mode
- M**: manual mode

Driving in automatic mode

Select position **D**. In the majority of traffic conditions, you will not have to touch the gear selector lever again: the gear will be changed automatically at the right time and at the most suitable

engine speed because the automatic system takes into account the vehicle load and road contour and adjusts itself to the particular driving style you have chosen.

Economical driving

When driving, leave the lever in position **D**, keeping the accelerator pedal lightly depressed to ensure automatic gear changes at comparatively low engine speeds.

Accelerating and overtaking

Depress the accelerator pedal firmly and fully (so that it goes beyond the kickdown point).

This will enable you to change down to the optimum gear within the engine range.

AUTOMATIC GEARBOX (2/3)

Driving in manual mode

With the selector lever in position **D**, move the lever to the left. Shifting the lever repeatedly allows you to change gears manually:

- To move down through the gears, push the lever backwards;
- To move up through the gears, push the lever forwards.

The gear selected is displayed on the instrument panel.

Special cases

In certain driving conditions (eg. engine protection, operation of the electronic stability program: ESP) the automatic system may change the gear automatically.

Likewise, to prevent incorrect manoeuvres, a gear change may be refused by the automatic system: in this case the gear display flashes for a few seconds as a warning.



When driving at top speed, do not suddenly shift down a gear. There is a risk of an accident if the engine brake is activated suddenly.

Special circumstances

- **If the road contour and bends do not allow you to stay in automatic mode** (eg. in the mountains), we recommend that you change to manual mode.

This will prevent the automatic gearbox from changing gear repeatedly when climbing, and permit engine braking on long descents.

- **In cold weather**, to avoid stalling the engine, wait a few seconds before moving the lever from position **P** or **N** and selecting **D** or **R**.

With the gear lever in a position other than **P** or **N**, the vehicle will move forward or back as soon as you release the brake pedal, without the accelerator being depressed. To immobilise the vehicle, depress the brake pedal.

- **Vehicle not equipped with a traction control system (ASR)**: on slippery roads or roads with low grip, to avoid wheelspin when pulling away, simply switch to manual mode and select second or third gear before starting.

- **Starting on a steep slope**: lever in position **D** or **R** and handbrake engaged, on equipped vehicles, as a security measure, release the brake pedal, depress the accelerator and release the handbrake as soon as the vehicle starts. On equipped vehicles, the electronic parking brake is automatically released once the vehicle starts by depressing the accelerator.



When starting after stopping on a steep slope, even if the gear lever is in position **D**, the vehicle may slide backwards (or forwards in position **R**); as a safety measure, use the parking brake.

AUTOMATIC GEARBOX (3/3)

Parking the vehicle

When the vehicle is stopped, move the lever to position **P** while keeping your foot on the brake pedal. The gearbox is in neutral and the drive wheels are mechanically locked by the driveshaft.

Engage the handbrake or, depending on the vehicle, ensure that the electronic parking brake is engaged (refer to the information on the “handbrake” or “Electronic parking brake” in Section 2).



An impact to the underside of the vehicle (e.g.: striking a post, raised kerb or other street furniture) may result in damage to the vehicle (e.g.: deformation of an axle).

To avoid any risk of accident, have your vehicle checked by an approved Dealer.

Operating faults

- **when driving**, if the “Check auto gearbox” message appears on the instrument panel, it indicates a fault.
Contact your approved dealer as soon as possible.
- **When driving**, if the message “Auto gearbox overheating” appears on the instrument panel, stop to allow the gearbox to cool down, with the gear lever at **P**. If the message does not disappear, consult an approved dealer.
- **If a vehicle with an automatic gearbox breaks down**, refer to the information on “Towing” in Section 5.

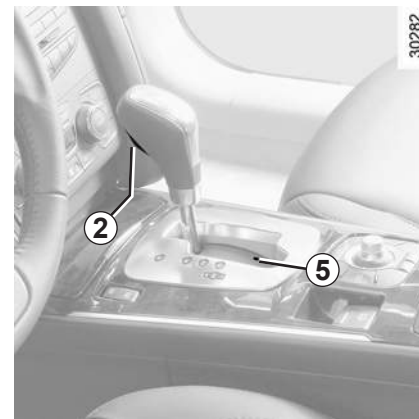

When setting off, if the lever is locked in position **P** even though you are depressing the brake pedal, the lever can be released manually.

Carry out these manoeuvres simultaneously:

- depress the brake pedal;
- press the button, inserting an object into hole **5**;
- simultaneously press unlocking button **2**.

Section 3: Your comfort

Air Vents	3.2
Fragrance diffuser	3.4
Air ionizer.	3.5
Automatic climate control	3.6
Air conditioning: information and advice on use	3.12
Electric windows/electric panoramic sunroof.	3.13
Sun visor/Sun blinds	3.16
Interior lighting.	3.17
Passenger compartment storage/ fittings.	3.20
Cigar lighter, Accessories socket, Ashtray.	3.24
Rear headrests	3.25
Rear bench seat	3.26
Luggage compartment.	3.27
Storage compartments	3.28
Multimedia equipment	3.29
Transporting objects/Towing	3.30

AIR VENTS (air outlet)

30284

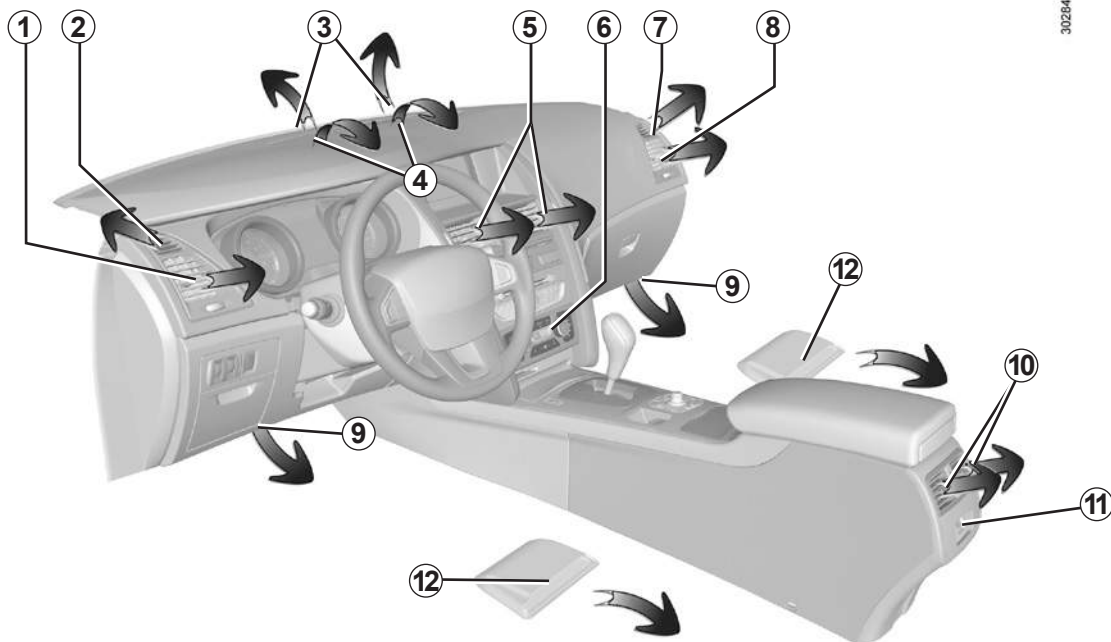

- 1 Left-hand air vent
- 2 Left-hand side window demister outlets
- 3 Windscreen demister outlet
- 4 Air vents at the top of the dashboard

- 5 Centre air vents
- 6 Air conditioning control panel
- 7 Right-hand side window demister outlet
- 8 Right-hand air vent

- 9 Front passenger footwell heater outlets
- 10 Centre air vents for the rear seats
- 11 Air conditioning control panel for the rear seats
- 12 Rear passenger footwell heater outlets (underneath the front seats)

AIR VENTS

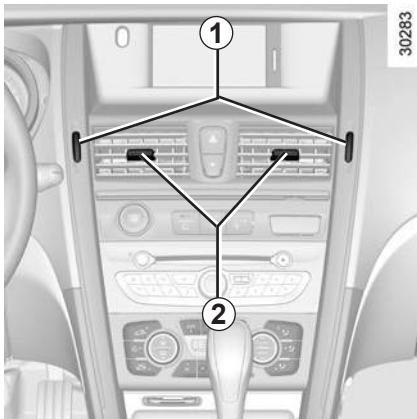

Air flow

Turn control knob **1**.

Up: maximum air flow

Down: closed

Turn control knob **3**.

Towards the windows: maximum air flow

Towards the interior: closed

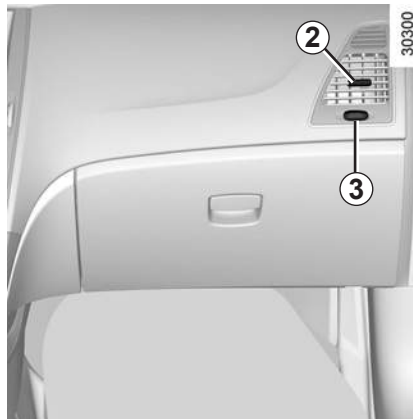

Direction

Right/left: move tabs **2** to the right or left.

Up/down: move tabs **2** up or down.

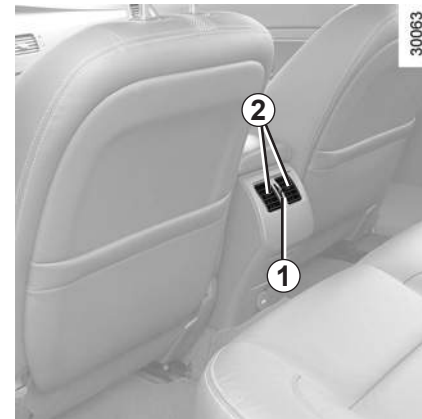

To remove bad odours from your vehicles, only use the systems designed for this purpose. Consult an approved Dealer.



Do not add anything to the vehicle's ventilation circuit (for example, to remove bad odours).

There is a risk of damage or of fire.

FRAGRANCE DIFFUSER



Controls

- 1 Fragrance diffuser outlet.
- 2 Capsule holder.
- 3 Fragrance diffuser intensity adjustment.
- 4 Fragrance selection.

Selecting fragrance

Press button **4** to select one of the two fragrances. The integrated indicator light comes on to show you the fragrance selected:

- Left-hand capsule;
- Right-hand capsule.

Fragrance diffuser intensity adjustment

Press button **3** to adjust the diffuser intensity. The integrated indicator light comes on to show you the intensity selected:

- Minimum intensity;
- Moderate intensity;
- Maximum intensity;
- Stop (all the integrated indicators go out).

When the system stops, you can restart the system by pressing button **3**. The last fragrance used is selected.

Replacing one of the fragrance diffuser capsules

Press capsule holder **2** to open it. Replace the capsule and push capsule holder **2** to close it.

Note: if used for 1 hour a day, a capsule may last for approximately 3 months. Capsules can be purchased from approved Dealers.

Precautions

- Capsules approved by our Technical Department must be used.
- Do not strip or refill the fragrance diffuser capsule.
- Keep out of reach for children.
- Keep the fragrance diffuser capsule out of direct rays of the sun.
- If the fragrance diffuser capsule contacts with eyes or skin, wash the affected area with plenty of clean water. If necessary, consult a doctor.
- Do not use the fragrance diffuser capsule for other purpose.



For safety reasons, do not replace the fragrance diffuser capsule while driving.

AIR IONIZER



Selecting the operating mode

With the air conditioning on, press button **1** to select one of the three following modes. The integrated indicator light comes on to show you the mode selected:

- CLEAN: removes harmful matter from the air (bacteria, dust, etc.);
- RELAX: provides a clean and relaxing driving environment by emitting ions;
- Stop (all the integrated indicator lights go out).

AUTOMATIC CLIMATE CONTROL (1/6)

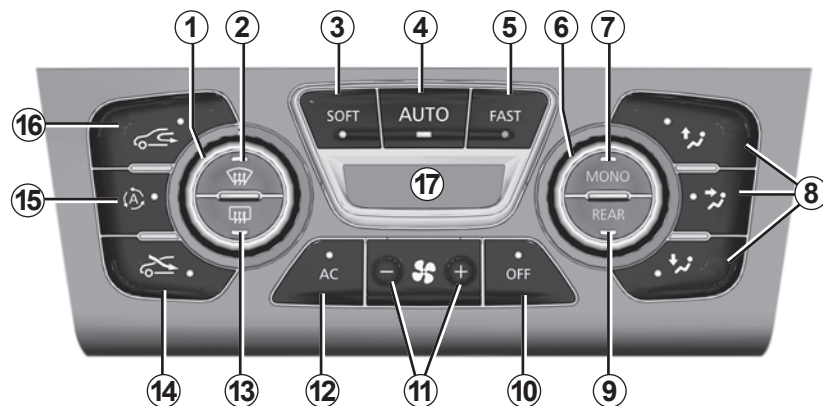

30247

The controls

(depending on the vehicle)

- 1 and 6 air temperature.
- 2 “Clear View” function.
- 3, 4 and 5 Automatic programmes.
- 7 Deactivating separated air temperature adjustment by zone.
- 8 Distribution of air in the passenger compartment.
- 9 Rear temperature adjustment (available on vehicles equipped with rear temperature setting).
- 10 Stopping the system.
- 11 Ventilation speed.
- 12 Air conditioning (on/off).
- 13 De-icing/demisting of the rear screen and door mirrors.
- 14 Air recirculation off.
- 15 Automatic air recirculation.
- 16 Air recirculation on.
- 17 Display.

Automatic modes

The automatic climate control system guarantees comfort in the passenger compartment and good visibility (except in the event of extreme conditions), whilst optimising consumption.

The system controls the ventilation speed, air distribution, air recirculation, and starting and stopping the air conditioning and air temperature. Three programmes are available:

AUTO: allows the selected comfort level to be best attained, depending on the exterior conditions. Press button 4.

SOFT: gently brings the temperature to the desired comfort level. The comfort level is then maintained gently and silently. Press button 3.

FAST: emphasises the actions of the system to reach the desired comfort level more quickly. Press button 5.

AUTOMATIC CLIMATE CONTROL (2/6)



30246

Adjusting the air temperature

Turn control **1** to adjust the temperature on the driver's side and control **6** for the passenger side.

Special note: the highest and lowest settings allow the system to produce maximum hot or cold temperature levels ("LO" and "HI" on display **17**).

Some buttons have an operating tell-tale which indicates the operating status.

Adjusting the rear air temperature from the front (depending on the vehicle)

Press button **9**: the set rear temperature flashes on display **A**. Turn control **6**.

Deactivating separated air temperature adjustment by zone

Press button **7**: the integrated indicator light comes on. The temperature of the front left, front right and rear passenger compartments is set to the temperature of the driver's side. Turn control **1** to set the temperature of front and rear seats.



Adjusting the rear air temperature from the rear (depending on the vehicle)

Press button **18** to set the rear air temperature, the rear air temperature independently of one another.

AUTOMATIC CLIMATE CONTROL (3/6)



30246

Switching air conditioning on or off

In automatic mode, the system switches the air conditioning system on or off, depending on the climate conditions. Press button **12** to switch off the air conditioning.

Where possible, it is recommended that automatic mode is used by selecting one of the automatic programmes: AUTO, SOFT or FAST.

In automatic mode (indicator light for button **4** on), all heating and air conditioning functions are controlled by the system.

You can also change the system selection, in this case, indicator light for button **4** will go out and the changed function, which is no longer controlled by the system, is shown on display **17**.

To return to automatic mode, press one of programmes: **AUTO, SOFT or FAST**.

The displayed temperature values show a comfort level.

However, when the vehicle is started in hot or cold weather and the set temperature is lowered or raised, it is not possible for this temperature to be rapidly reached, regardless of the value displayed. In particular, when the heating system is switched on in winter, the ventilation system will not immediately operate at maximum, but will gradually optimise the ventilation speed until the engine is sufficiently warm. This process may take a few seconds or even several minutes.

Generally speaking, unless there is a particular reason not to, the dashboard air vents should remain open.

AUTOMATIC CLIMATE CONTROL (4/6)

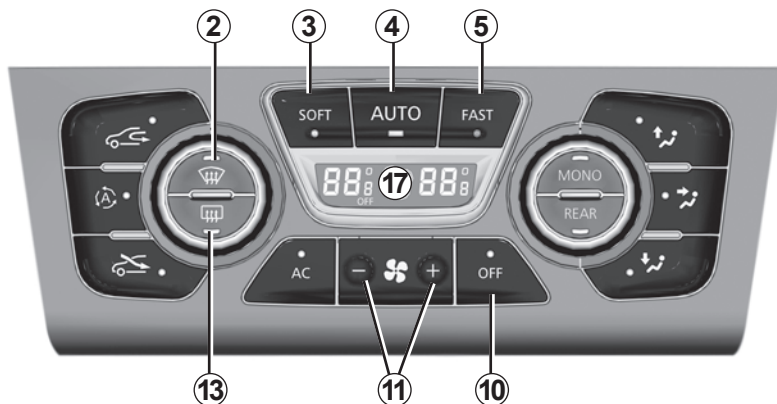

30246

Adjusting the ventilation speed

In automatic mode, the system uses the best ventilation speed to reach and maintain the desired comfort level.

You can still adjust the ventilation speed by pressing buttons **11** to increase or reduce the ventilation speed.

In this situation, the ventilation speed, which is no longer automatically controlled, appears on the display.

Stopping the system

Press button **10** to switch off the whole system; in this case, "OFF" is shown on display **17**.

To switch the system on, press one of the following buttons:

- Automatic mode **3**, **4** and **5**;
- Adjusting the ventilation speed **11** (+);
- "Clear View" function **2**.

Clear View function

Press button **2**: the integrated indicator light comes on.

This function quickly demists and deices the windscreen, the rear screen, the front side windows and the door mirrors (depending on the vehicle). The air conditioning and rear screen de-icing functions are activated automatically.

Press button **13** to stop the rear screen de-icer function. The integrated indicator light in button **13** will go out.

You may modify the ventilation speed (possibility of noise in the passenger compartment) by pressing button **11**.

To exit this function, press:

- button **2** again;
- one of either button **3**, **4** or **5**.

AUTOMATIC CLIMATE CONTROL (5/6)

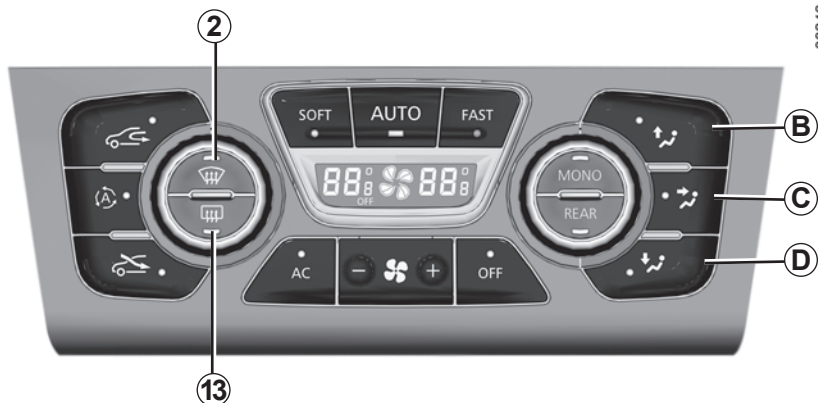

30246

Rear screen de-icing/ demisting

Press button **13**: the integrated indicator light comes on.

This function permits rapid demisting/de-icing of the rear screen and de-icing of the door mirrors (on equipped vehicles).

To exit this function, press button **13** again. Demisting automatically stops by default.

Adjusting the distribution of air in the passenger compartment

There are three air distribution options and the options can be combined.

Press button **B**, **C** or **D** to adjust the distribution of air. The integrated indicator light comes on to show you the distribution selected:

 the air flow is directed towards the side window and windscreen demisting vents.

 the air flow is directed towards the front and rear centre air vents.

 the air flow is directed mainly towards the footwells.

In this situation, the distribution of air in the passenger compartment, which is no longer automatically controlled, appears on the display.

Note: If the options **B** and **C** (or **B**, **C** and **D**) are combined, the air flow is directed towards the outlet located on the top of the dashboard and the front and rear centre air vents (not towards the side window and windscreen demisting vents).

If no air distribution option is selected, the air flow is directed towards the direction which was selected last time.

AUTOMATIC CLIMATE CONTROL (6/6)

Automatic air recirculation

Press button **15**. The integrated indicator light comes on.

The sensor located at the air intake detects atmospheric pollution, which automatically switches air recirculation on or off, depending on the ambient level of gas.

Press button **15** again or press button **2** or **16** to stop this function.

Manual air recirculation

Pressing button **16** activates air recirculation mode (the integrated indicator comes on):

- during recirculation, air is taken from the passenger compartment and recycled, with no air being taken from outside the vehicle;
- air recirculation allows the external atmosphere to be cut off (when driving in polluted areas, etc.).

Prolonged use of this position may lead to odours, caused by non-renewal of air, and the formation of condensation on the windows.

It is therefore recommended to return to normal operation (outside air) by pressing button **14**.



The demisting/de-icing will still take priority over the air recirculation.

In some situations (high humidity, low temperature, etc.) air recirculation is not activated automatically, to ensure visibility remains the priority (ventilation is maintained using air from the outside).

If you activate air quality system when driving in an urban or industrial area, the air recirculation will run for longer, which may cause condensation to form on the windows.

With this system activated, press button **2** to remove it.

Drive using normal operation (outside air) and switch the air conditioning system on to ensure good visibility on a day where a lot of condensation is likely to form.

AIR CONDITIONING: information and advice on use

Advice on use

In some situations, (air conditioning off, air recirculation activated, ventilation speed at zero or low, etc.) you may notice that condensation starts to form on the windows and wind-screen.

If there is condensation, use the “**Clear View**” function to remove it, then use the air conditioning in automatic mode to stop it forming again. If the condensation does not clear, use the FAST programme.

After having used the air conditioning system, an odour may occur caused by the humidity remaining inside the air vents. Try to switch off the air conditioning five minutes before stopping the engine to remove any remaining humidity in the air vents.



Do not open the refrigerant fluid circuit. The fluid may damage eyes or skin.

Fuel consumption

You will normally notice an increase in fuel consumption (especially when driving in town) when the air conditioning is operating.

For vehicles fitted with manual air conditioning, switch off the system when it is not required.

Advice for reducing consumption and therefore helping to preserve the environment:

Drive with the air vents open and the windows closed.

If the vehicle has been parked in the sun, open the doors for a few moments to let the hot air escape before starting the engine.

Maintenance

Refer to the Maintenance Service Document for your vehicle for the inspection frequency.

Operating faults

As a general rule, contact your approved Dealer in the event of an operating fault:

- **reduction in de-icing, demisting or air conditioning performance.** This may be caused by the passenger compartment filter cartridge becoming clogged;
- **no cold air is being produced.** Check that the controls are set correctly and that the fuses are sound. Otherwise, switch off the system.

Note

Presence of water under the vehicle. After prolonged use of the air conditioning system, it is normal for water to be present under the vehicle. This is caused by condensation.

ELECTRIC WINDOWS AND ELECTRIC PANORAMIC SUNROOF (1/3)

These systems operate with the ignition on or off, until the driver's door is opened.



Safety of rear occupants

Depending on the vehicle, the driver can disable operation of the electric windows and the rear doors by pressing switch **4**. The indicator light integrated in the switch lights up to confirm that the locks have been activated.

Driver's responsibility

Never leave your vehicle with the RENAULT card inside and never leave a child (or a pet) unsupervised, even for a short while. The reason for this is that the child may endanger himself or others by starting the engine, activating equipment such as the electric window, or locking the doors. If any part of the body becomes trapped, reverse the direction of the window immediately by pressing the relevant switch.

Risk of serious injury.

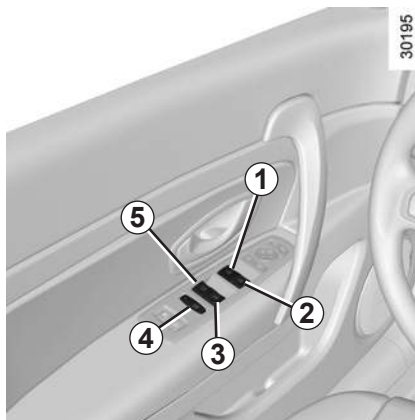

Electric windows

Press or pull the switch to raise or lower a window to the desired height (the rear windows do not open fully); Operate the switches as follows:

- **1** for the driver's side;
- **2** for the front passenger's side;
- **3** and **5** for the rear windows.

From the passenger and rear seats, Press switch **6**.

Avoid resting any objects against a half-open window: there is a risk that the electric window winder could be damaged.

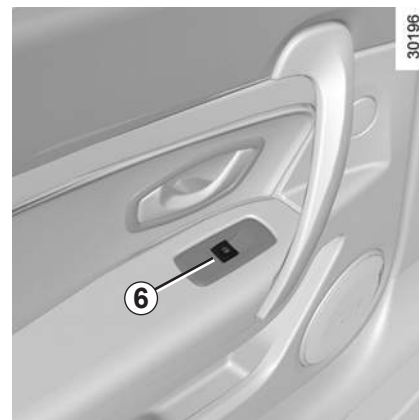

One-touch mode

Depending on the vehicle, this mode works in addition to the operation of the electric windows described previously. It may be fitted to the driver's and passenger's window only, or to all the windows. Press or pull the window switch fully: the window is fully lowered or raised. Pressing the switch again stops the window moving.

Note: if the window detects resistance when closing (e.g. fingers, branch of a tree, etc.) it stops and then lowers again by a few centimetres.

ELECTRIC WINDOWS AND ELECTRIC PANORAMIC SUNROOF (2/3)

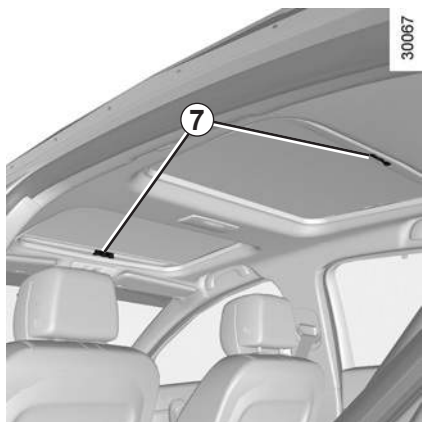

Sunroof blind

Check that the sunroof is closed before opening or closing the blind.

- **to open:** push handle **7** upwards and guide the blind as it retracts.
- **to close:** Take hold of handle **7** and close the blind until it is secured in the lock.

- Never operate the sunroof with the blind closed.
- Never drive with the sunroof open and the sun blind closed.

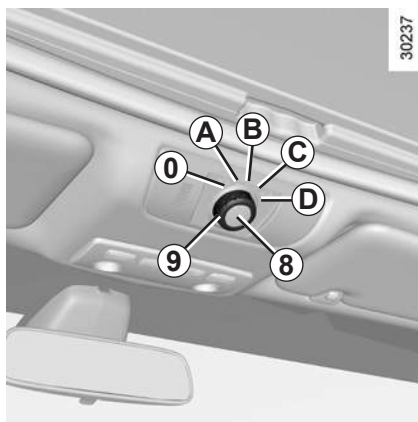

Tilting the sunroof

To tilt: open the blind before turning control knob **9** to position **A**.

To close: turn control knob **9** to position **0**.

Sliding the sunroof

To open: open the blind and move control knob **9** to position **B**, **C** or **D**, depending on the position required.

To close: turn control knob **9** to position **0**.

Special note

Your vehicle is equipped with an anti-pinch facility: when the sunroof encounters resistance whilst closing, (somebody's fingers, etc.) it stops and then moves back several centimetres.



Driver's responsibility

Never leave your vehicle with the RENAULT card inside and never leave a child (or a pet) unsupervised, even for a short while. The reason for this is that the child may endanger himself or others by starting the engine, activating equipment such as the electric window, or locking the doors. If any part of the body becomes trapped, reverse the direction of the window immediately by pressing the relevant switch.

Risk of serious injury.

ELECTRIC WINDOWS AND ELECTRIC PANORAMIC SUNROOF (3/3)

Remote control window closing

(for vehicles with one-touch windows on all windows).

When you lock the doors from the outside, **press the locking button on the RENAULT card twice in quick succession, or the driver's door button in hands-free mode**, and all the windows will close automatically.

It is recommended that the user only operates the system when the vehicle can be seen clearly and no one is inside.

Note: closing with the RENAULT card deactivates hands-free mode.



Closing windows can cause serious injury.



If the vehicle is equipped with this function, this action will activate deadlocking.

Check that there is no-one still inside the vehicle.

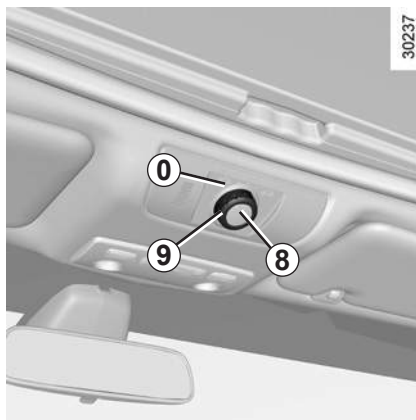

Operating faults

Electric windows

If the window does not close, the system switches to non one-touch mode.

Pull the switch as many times as necessary until the window closes completely, hold the switch (still on the closing side) for three seconds, then completely lower then raise the window to reinitialise the system. Once reinitial-

Important: during this operation, the sunroof anti-pinch facility is deactivated. Contact your approved dealer as soon as possible.

isation is complete, one-touch mode returns to normal operation.

If necessary, contact an approved Dealer.

Sunroof

If the sunroof will not close, check that there are no obstacles and move control knob **9** to **0** and keep button **8** pressed until the sunroof closes.

If the fault is still present, consult an approved Dealer as soon as possible.

Precautions during use

- **check** that the sunroof is properly closed before leaving your vehicle;
- **clean** the seal every three months using products recommended by our Technical Department.
- **do not open** the sunroof immediately after the vehicle has been driven in the rain or after your car has been washed. Water may enter the passenger compartment.

SUN VISOR/SUN BLINDS



Front sun visor

Lower sun visor **1** over the windscreen or unclip it and turn it over side window.

Courtesy mirror

Slide cover **3**. Depending on the vehicle, light **2** is lit.

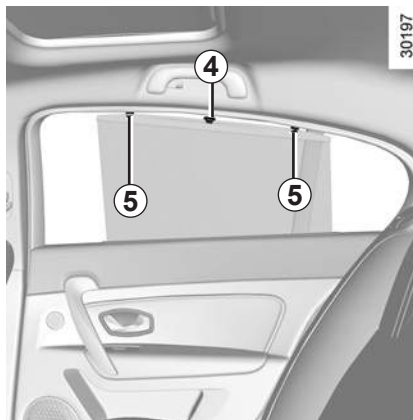

Side sun blind

(depending on the vehicle)

Pull the sun blinds upwards, holding them by tab **4** to secure them in hook **5** (check that they are securely attached).

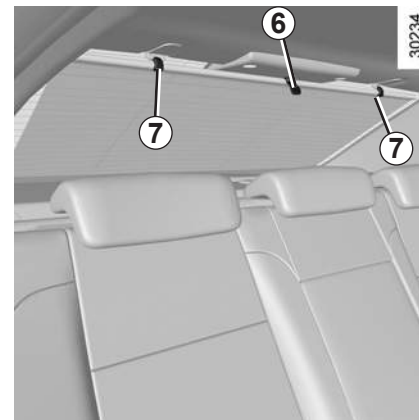

Rear sun blind

(depending on the vehicle)

Pull the sun blinds upwards, holding them by tab **6** until hooks **7** engage in their housing (check that they are securely attached).

INTERIOR LIGHTING (1/3)

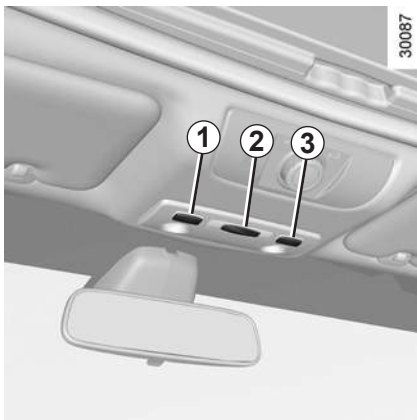

Front/rear courtesy lights

Press switch **2**.

- Left: permanent lighting
- Middle (centre position): the light comes on when you open a door and goes out a few seconds after it is closed. It also comes on for a few seconds when the engine is stopped, when the RENAULT card is removed or when the vehicle is unlocked with the RENAULT card.
- Right: the light does not come on even when the door is opened.

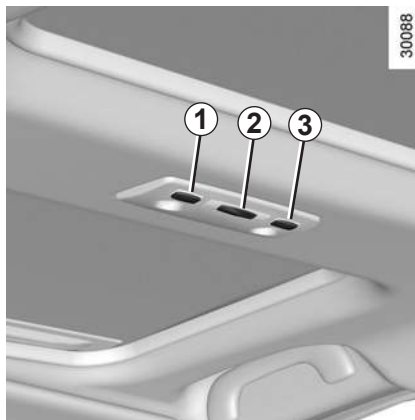

Front/rear map reading lights (depending on the vehicle)

Press switch **1** or **3** to switch on the selected light.

Press the same switch again to turn it off.

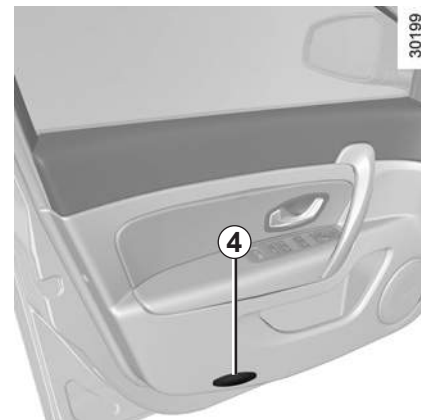

Front door lights

The light comes on when the door is opened and goes out a few seconds after it is closed. Light **4** also comes on for a few seconds when the engine is stopped, when the RENAULT card is removed or when the vehicle is unlocked with the RENAULT card.

The courtesy lights and the front door lights come on for a few moments when the vehicle is unlocked.

INTERIOR LIGHTING (2/3)



Glove box light 5

Light 5 comes on when the glove box is opened.



Front footwell lights 6

The light comes on when the door is opened and goes out a few seconds after it is closed. Light 6 also comes on for a few seconds when the engine is stopped, when the RENAULT card is removed or when the vehicle is unlocked with the RENAULT card.

INTERIOR LIGHTING (3/3)

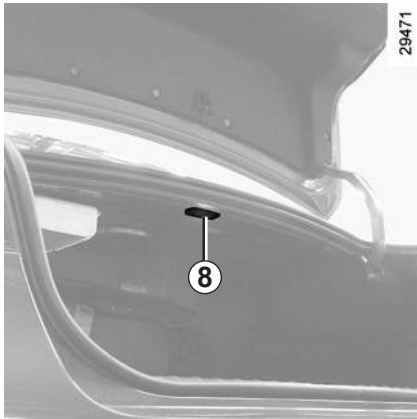

Luggage compartment light 8

Light **8** comes on when the luggage compartment is opened.

PASSENGER COMPARTMENT STORAGE AND FITTINGS (1/4)



Door pockets 1

These can be used for storing books, road maps, etc.



Ensure that no hard, heavy or pointed objects are placed in the “open” storage compartments in such a way that they may fall onto passengers during sudden turning or braking.

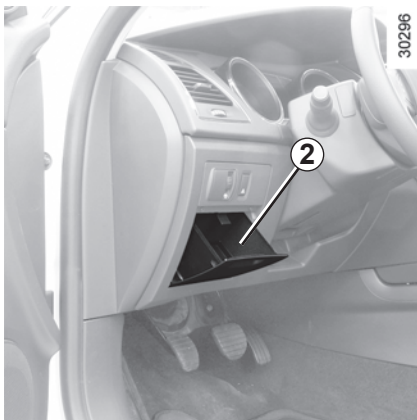

Dashboard storage compartment 2



Nothing should be placed on the floor area in front of the driver as such objects may slide under the pedal during braking manoeuvres, thus obstructing its use.

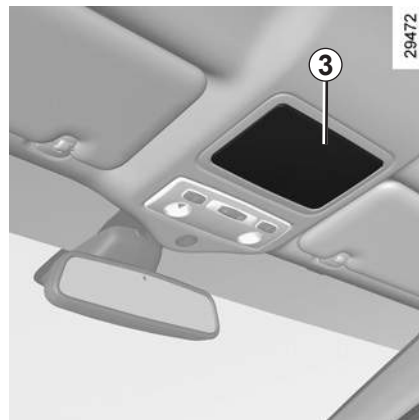

Sunglasses holder 3 (depending on the vehicle)

To open the sunglasses holder, press 3.



Do not hang any heavy and/or sharp objects which may fall whilst driving. Risk of injury. Before opening the upper storage compartments, take the necessary precautions to avoid falling objects. Risk of injury.

PASSENGER COMPARTMENT STORAGE AND FITTINGS (2/4)

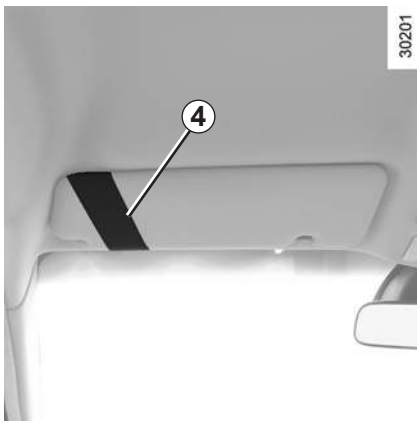

Sun visor storage 4

It can be used to hold motorway passes.

Centre console storage compartment

Press control 5 and raise armrest 7.



Centre console storage compartment with two layers (depending on the vehicle)

Using the upper layer

Press control 5 and raise armrest 7.

Using the lower layer

Press control 8 and lift armrest 7 to lift the upper layer.

Coin holder 9

Cup holder 10

Press 10 to open the cover and use the cup holder.



Front armrest

(depending on the vehicles)

Pull lever 6 upwards and slide the armrest to the desired position.



When turning corners, accelerating or braking, ensure that the receptacle being held by the cup holder is not dislodged.

There is a risk of burning if hot liquid escapes.

PASSENGER COMPARTMENT STORAGE AND FITTINGS (3/4)

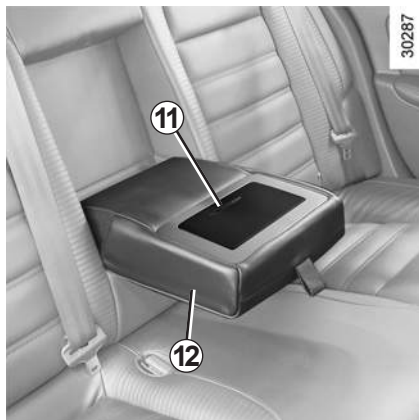

Cup holder 11

Lower the central rear armrest and press **11** to allow the cup holder to be used.

Central rear armrest 12

Lower the central rear armrest.



When turning corners, accelerating or braking, ensure that the receptacle being held by the cup holder is not dislodged.

There is a risk of burning if hot liquid escapes.

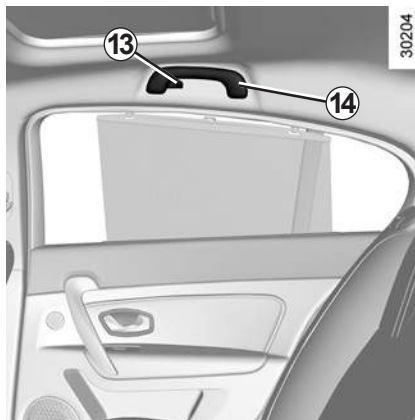

Clothes hooks 13

Grab handle 14

This offers support when the vehicle is moving. Do not use it for getting into or out of the vehicle.



Glove box

Pull handle **15** to open it.

Depending on the vehicles, the glove box is locked and unlocked using the provided key (refer to the information on the "Rear bench seat" in Section 3).

You can use it to store A4 size documents or a large bottle of water.

It is ventilated and refrigerated.

Note: When driving, objects contained in the glove box may cause noise.

PASSENGER COMPARTMENT STORAGE AND FITTINGS (4/4)



Rear door storage compartment 16

It can be used to hold a beverage.



Front seat storage compartments 17

It can be used to hold magazines or road maps, etc.



Ensure that no hard, heavy or pointed objects are placed in the “open” storage compartments in such a way that they may fall onto passengers during sudden turning or braking.

CIGAR LIGHTER, ACCESSORIES SOCKET, ASHTRAY



Cigar lighter 2

Open cover **1** by pushing it in the direction shown by the arrow.

With the ignition on, push in cigar lighter **2**

It will spring back with a click when it is ready. Pull it out to use. After use, replace it without pushing it all the way in.

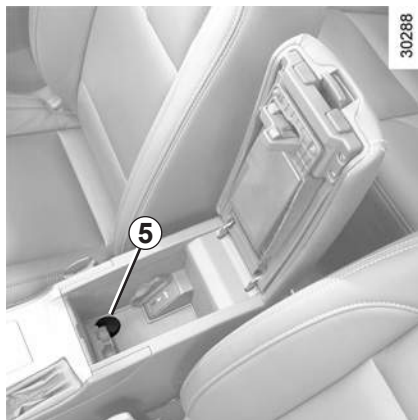

Accessories socket 5, 6 (depending on the vehicle)

The accessories socket is designed for connecting accessories with a maximum power rating of 120 Watts (voltage: 12V, 10A).



Connect accessories with a maximum power of 120 Watts only.

Fire hazard.

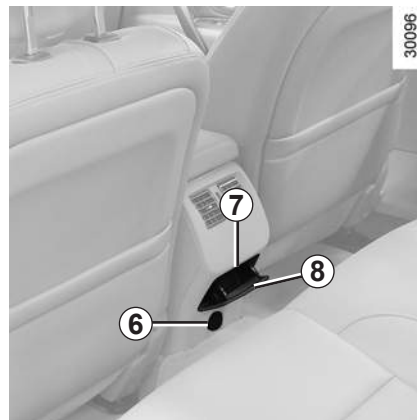

Ashtray 4, 8

You can use the ashtray by pushing cover **1** in the direction shown by the arrow or by pulling cover **8**. To empty it, pull side **3** or press tab **7**.

To close cover **1**, push it again in the direction shown by the arrow.

REAR HEADRESTS



There may be adjustable headrests on the rear bench seat, depending on the vehicle.

To raise the headrest

Pull it upwards to the required position.

To lower the headrest

Guide the headrest down to the desired height whilst pressing tab **1**.

To remove the headrest

Lift the headrest to release it, whilst pressing tab **1**.

To refit the headrest

Insert the headrest rods into the sleeves, and lower the headrest to the first notch.

Storage position A

Press tab **1** and lower the headrest completely.

When the headrest is completely lowered (position A), this is for storage only. The headrest must be correctly adjusted when a passenger is seated.

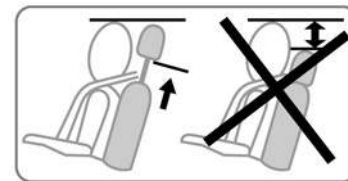

The headrest is an important safety component: ensure that it is in place and in the correct position. The distance between your head and the headrest and the distance between the head and section **A** should be as small as possible.

REAR BENCH SEAT



The seatbacks can be folded down in order to transport large objects.

In all situations, lower the rear headrests (refer to the information on the “Rear headrests” in Section 3).

Rear bench seat

Press button **2** towards the front of the vehicle and lower seatback **A**



For safety reasons, carry out any adjustments when the vehicle is not being driven.

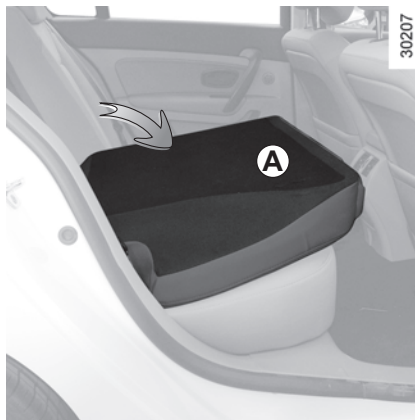

To put the seatback back in position, raise it then check that it is locked correctly.

Note: You can lock/unlock the rear bench seat using the provided key **1**.



When refitting the seatback, make sure it is correctly locked in place.

If seat covers are fitted, make sure these do not prevent the seatback latch from locking in.

Make sure that the seat belts are positioned correctly.

Reposition the headrests.

When moving the rear seats, ensure that nothing obstructs the anchorage points (passenger's arm or leg, a pet, gravel, cloth, toys, etc.).

LUGGAGE COMPARTMENT

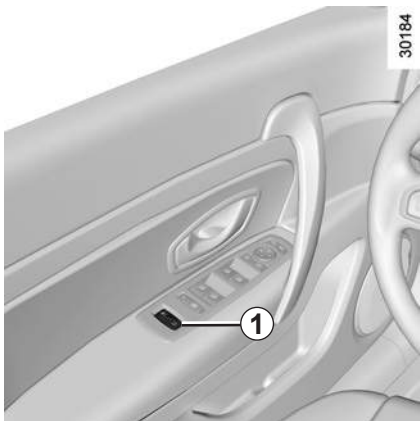

30184

To open

- Press the right side of switch **1** to open the trunk lid.
- With the doors or trunk lid unlocked press button **2** and lift the trunk lid.

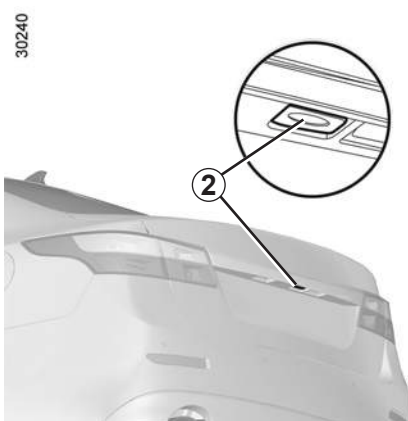

30240

To close

Lower the trunk lid using handle **3** inside the trunk lid to help you. Check that the trunk lid is closed securely.

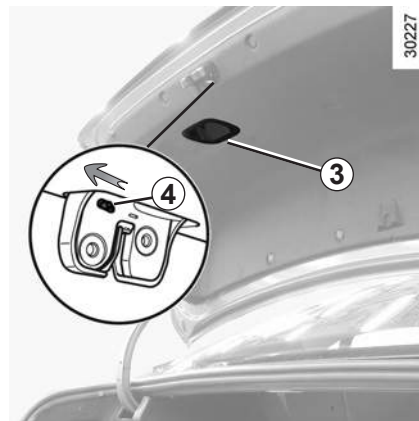

30227

Opening manually from inside the vehicle

Special note:

If it is impossible to unlock the trunk lid, it can be done from inside.

- Access the luggage compartment by folding forward the seatback(s) of the rear bench seat,
- Slide unit **4** as shown in the illustration,
- Push the trunk lid to open it.

STORAGE COMPARTMENTS

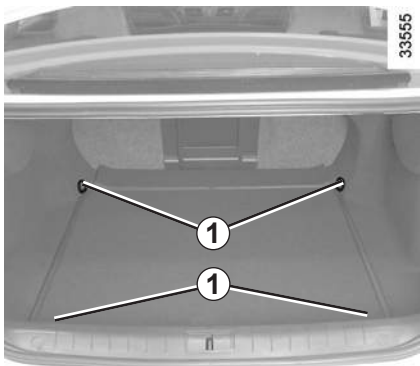

Anchorage points

You can secure the load using anchorage points **1**.

Always position objects being transported so that the heaviest items are resting against the back of the rear bench seat.



Do not place any objects, especially heavy or hard objects, on the parcel shelf.

These may pose a risk to the vehicle occupants if the driver has to brake suddenly or if the vehicle is involved in an accident.

MULTIMEDIA EQUIPMENT

Navigation system

The equipment described below may or may not be fitted to the vehicle, and its location may vary, depending on the vehicle navigation system version.

- 1 Navigation display;
- 2 Radio;
- 3 Central control;
- 4 Navigation DVD reader;
- 5 Auxiliary input;
- 6 Steering column controls;
- 7 Microphone.

Hands-free telephone integrated control

On equipped vehicles, use microphone 7 and steering column control 6.

To use this equipment, consult the instructions for the equipment which should be kept with the other vehicle documentation.



Using the telephone

We remind you of the need to conform to the legislation in force concerning the use of such equipment.

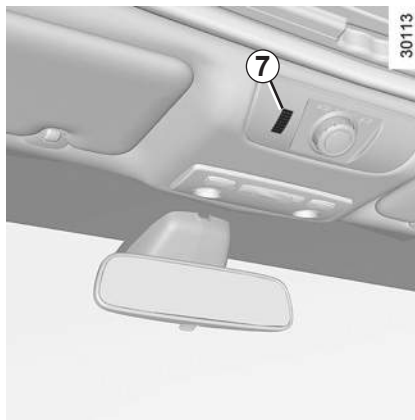
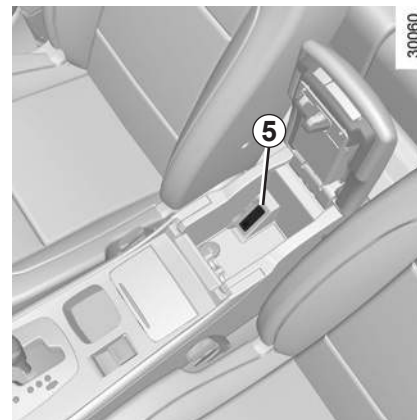
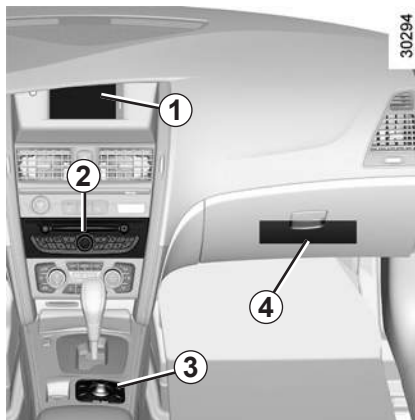

TRANSPORTING OBJECTS/TOWING



Transporting objects in the luggage compartment

Always place the objects to be transported so that their largest side rests against the back of the rear bench seat, for normal loads (Example A), or against the back of the front seats when the rear bench seatbacks are folded down.

If you have to place objects on the folded seatback, it is necessary that you lower the headrests before folding the seatback so that it can be folded as flat as possible against the seat.

Transporting objects on roof bars

The fitting of roof bars is prohibited on this vehicle.

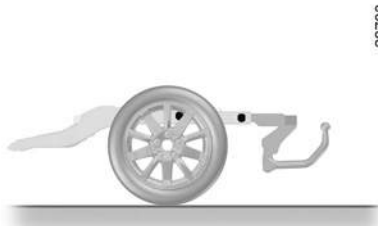
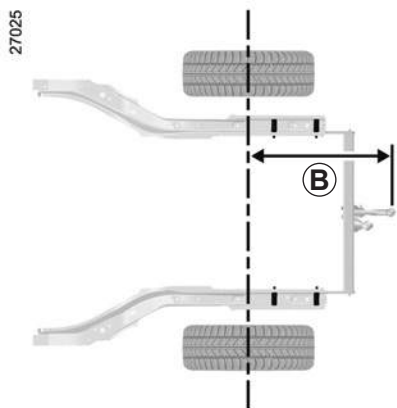

B = 1175 mm

Permissible nose weight, maximum permissible towing weight, braked and unbraked: refer to the information on "Weights" in Section 6.



Always position the heaviest items directly on the floor. Use the lashing points on the floor of the luggage compartment, if these are fitted to the vehicle. The luggage should be loaded in such a way that no items will be thrown forward and strike the occupants if the driver has to brake suddenly. Fasten the rear seat belts, even if the seats are not occupied.

Section 4: Maintenance

Bonnet	4.2
Engine oil level: general information	4.3
Engine oil level: topping up/filling	4.5
Engine oil change	4.7
Levels	4.8
engine coolant	4.8
power-assisted steering oil.	4.8
brake fluid.	4.9
windscreen/headlight washer reservoir	4.10
continuously variable transmission oil	4.10
Filters	4.10
Battery	4.11
Tyre pressure.	4.12
Bodywork maintenance	4.13
Interior trim maintenance.	4.15

BONNET



Opening the bonnet

Pull handle **1** located on the bottom left of the dashboard. Lift the bonnet by pushing tab **2** as shown.



The engine may be hot when carrying out operations in close proximity. In addition, the engine cooling fan can come on at any moment.

Risk of injury.



In the event of even a slight impact involving the radiator grille or bonnet, have the bonnet lock checked by an approved Dealer as soon as possible.

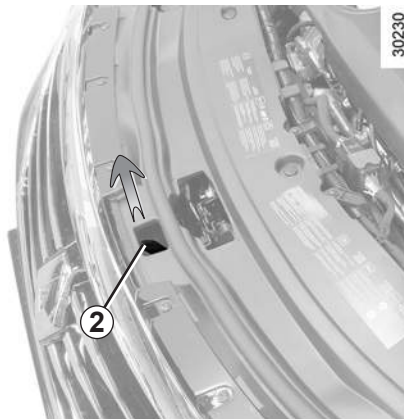

Closing the bonnet

Before closing the bonnet, check that nothing has been left in the engine compartment which may prevent it from operating correctly (tools, sheets of paper, cloth, etc.)

Hold the middle of the bonnet and guide it down to 30 cm above the closed position, then release. It will latch automatically under its own weight.



Ensure that the bonnet is properly locked.

ENGINE OIL LEVEL: general information (1/2)

It is normal for an engine to use oil for lubrication and cooling of moving parts and it is normal to top up the level between oil changes.

Frequency: check the oil level from time to time and always before any long journey to avoid the risk of damaging your engine.

Reading the oil level

The oil level should be read with the vehicle on level ground, after the engine has been switched off for some time.

The dipstick must be used to read the exact oil level and make sure that the maximum level has not been exceeded (risk of engine damage). Refer to the following pages.

The instrument panel display only alerts the driver when the oil level is at its minimum

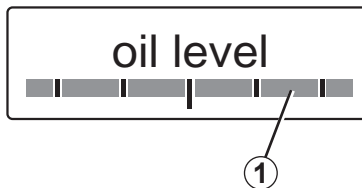

Oil level information on the instrument panel

While starting the engine, press either button **2** or **3** when the message “Checking control functions” appears. The message “Oil level” appears with bar **1** on the instrument panel display. As the oil level drops, the bar **1** decreases.

Note: it is possible that the exact oil level will not be displayed after a short journey.

30304

27454



Minimum oil level warning on the instrument panel

The message “Top up oil level” appears.

The oil must be topped up as soon as possible.



The display only warns the driver if the oil level is at the minimum level. It does not inform the driver that the oil level has exceeded the maximum level as this can only be measured using a dipstick.

ENGINE OIL LEVEL: general information (2/2)

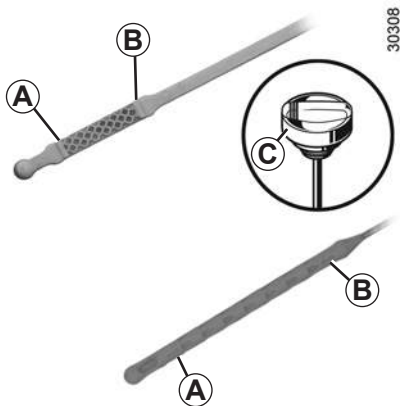

Reading the engine oil level with the dipstick

- remove the dipstick (refer to the following pages for its location) and wipe it with a clean lint-free cloth;
- push the dipstick in as far as it will go (for vehicles equipped with a cap-type dipstick **C**, screw the cap in as far as it will go);
- take out the dipstick again;
- read the level: it should never fall below minimum mark **A** or exceed maximum mark **B**.

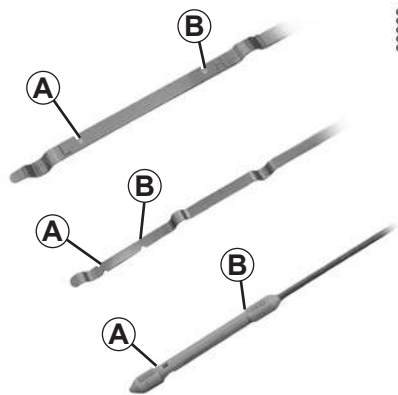

Once the operation has been completed, ensure that the dipstick is pushed in as far as it will go or that the "cap-type dipstick" is completely screwed in.



Under no circumstance should maximum filling level **B** be exceeded: this could damage the engine and the catalytic converter.

Maximum engine oil level exceeded.

The oil level should only be read with the dipstick as explained above.

If the oil level exceeds the maximum level, **do not start your vehicle** and contact an approved Dealer.

Consult your approved Dealer at once if you notice an abnormal or repeated drop in any of the fluid levels.

To prevent splashback, you are recommended to use a funnel to top up the oil.



The engine may be hot when carrying out operations in close proximity. In addition, the engine cooling fan can come on at any moment.

Risk of injury.

ENGINE OIL LEVEL: topping up and filling (1/3)

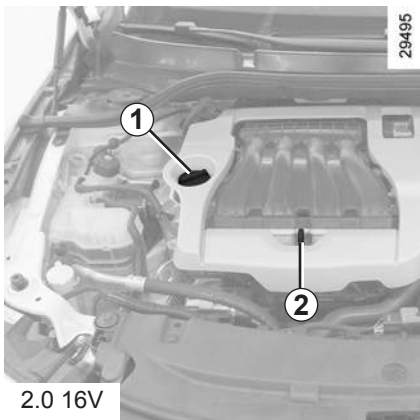

Topping up/filling

The engine oil must be topped up and filled on level ground, with the engine switched off and cold (for instance, before the engine is started up for the first time in the day).

Engine oil grade

Refer to the Maintenance Service Document for your vehicle.

To prevent splashback, you are recommended to use a funnel to top up the oil.

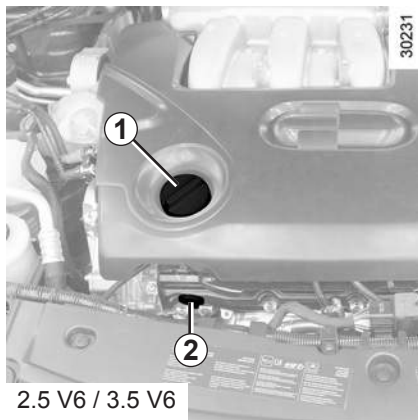

- Open cap **1**.
- Add oil to top up the level (as a guide, the capacity between the minimum and maximum reading on dipstick **2** is between 1.5 and 2 litres, depending on the engine).
- Wait for approximately 20 minutes to allow the oil to flow into the engine.
- Check the level using dipstick **2** (as described above).

Do not exceed the max level and do not forget to refit cap **1** and dipstick **2**.

ENGINE OIL LEVEL: topping up and filling (2/3)

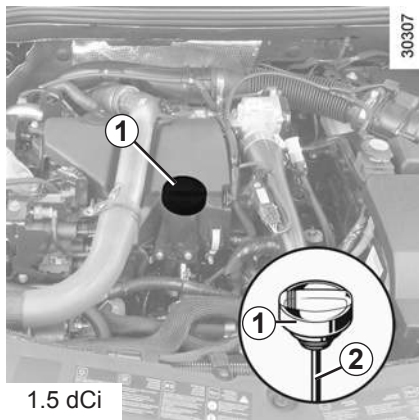

Topping up/filling

The engine oil must be topped up and filled on level ground, with the engine switched off and cold (for instance, before the engine is started up for the first time in the day).

Engine oil grade

Refer to the Maintenance Service Document for your vehicle.

To prevent splashback, you are recommended to use a funnel to top up the oil.

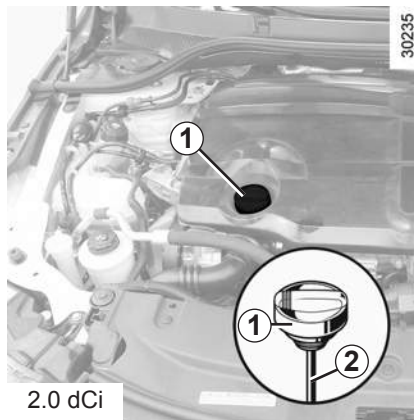

- Open cap **1**.
- Add oil to top up the level (as a guide, the capacity between the minimum and maximum reading on dipstick **2** is between 1.5 and 2 litres, depending on the engine).
- Wait for approximately 20 minutes to allow the oil to flow into the engine.
- Check the level using dipstick **2** (as described above).

Do not exceed the max level and do not forget to refit cap **1** and dipstick **2**.

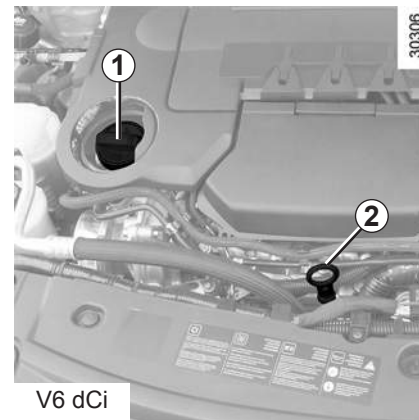

ENGINE OIL LEVEL: topping up and filling (3/3)/ENGINE OIL CHANGE

Oil change

Service interval: refer to the Maintenance Service Document for your vehicle.

Average capacities for oil change including oil filter

(for information)

The engine capacity depends on the power of the engine and on the associated anti-pollution regulations.

2.0 16V engine: 4.2 litres

2.5 V6 engine: 5.7 litres

3.5 V6 engine: 5.7 litres

1.5 dCi engine: 4.5 litres

2.0 dCi engine (127 kW): 7.4 litres

2.0 dCi engine (110 kW, except Euro 3): 8.2 litres

2.0 dCi engine (110 kW, Euro 3): 6.6 litres

V6 dCi engine : 6.8 litres

If you have some doubt about the identification of your engine, consult an approved Dealer.

In every case, it is imperative to check the level with the dipstick. Proceed as

Consult your approved Dealer at once if you notice an abnormal or repeated drop in any of the fluid levels.

explained in the paragraph "Topping up and filling" in section 4.

Engine oil grade

Refer to the Maintenance Service Document for your vehicle.



Engine oil change: if you are changing the oil when the engine is hot, be careful not to scald yourself if the oil overflows.



Filling: take care when topping up the oil that no oil drips onto engine components - risk of fire. Remember to refit the cap securely as there is a risk of fire if oil splashes onto hot engine components.



The engine may be hot when carrying out operations in close proximity. In addition, the engine cooling fan can come on at any moment.
Risk of injury.



Never run the engine in an enclosed space as exhaust gases are poisonous.

LEVELS (1/3)

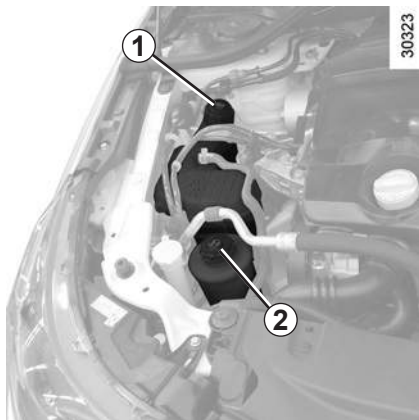

Coolant

The level when cold should be between the MINI and MAXI marks on coolant reservoir **1**.

Top this level up when cold before it reaches the MINI mark.



The engine may be hot when carrying out operations in close proximity. In addition, the engine cooling fan can come on at any moment.

Risk of injury.

Checking intervals

Check the coolant level regularly (very severe damage is likely to be caused to the engine if it runs out of coolant).

If the level needs to be topped up, only use products approved by our Technical Department which ensure:

- protection against freezing
- anti-corrosion protection of the cooling system

Replacement intervals

Refer to the Maintenance Service Document for your vehicle.

Consult your approved Dealer at once if you notice an abnormal or repeated drop in any of the fluid levels.

Power-assisted steering oil

The power-assisted steering oil level on reservoir **2** must be between the MINI and MAXI marks.

Fill up before the level reaches the MINI mark.

Depending on the vehicle, reservoir **2** is hidden at the below of the engine compartment. Contact an approved Dealer to check and fill up the oil



No operations should be carried out on the cooling circuit when the engine is hot.

Risk of burns.

LEVELS (2/3)

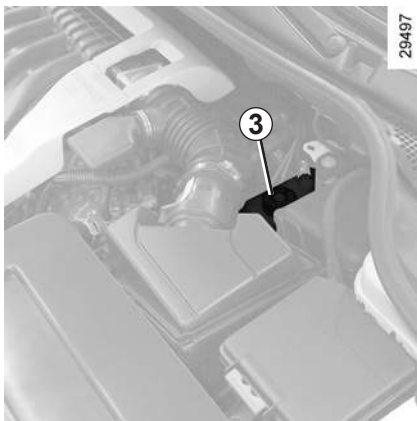

Brake fluid

This should be checked frequently, and immediately if even the slightest variation in braking efficiency is noticed.

Fluid level

It is normal for the level to drop as the brake shoes become worn, but it must never drop lower than the “**MINI**” warning line on reservoir **3**.

If you wish to check the disc wear yourself, you should obtain the document explaining the checking procedure from our network or from the manufacturer's website.

Topping up

After any operation on the hydraulic circuit, a specialist must replace the fluid.

Only use fluids approved by our Technical Department (and taken from a sealed container).

Replacement intervals

Refer to the Maintenance Service Document for your vehicle.



The engine may be hot when carrying out operations in close proximity. In addition, the engine cooling fan can come on at any moment.

Risk of injury.

LEVELS (3/3)/FILTERS

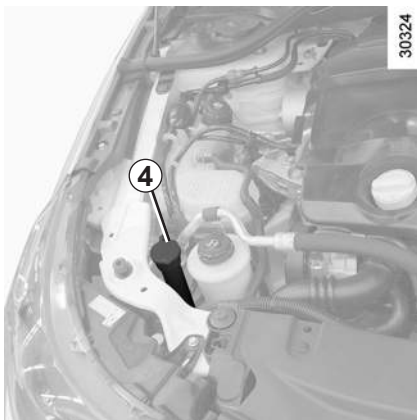

Windscreen/headlight washer reservoir

Topping up

Open cap **4**, fill until you can see the fluid, then refit the cap.

Liquid

Screen wash product (product with antifreeze in winter).

Jets

Use a tool such as a needle to adjust the height of the windscreen washer jets.

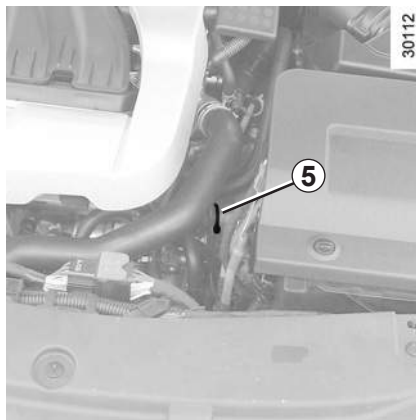

Continuously variable transmission oil dipstick **5**

Consult an approved Dealer.

Filters

The replacement of filter elements (air filter, cabin filter, diesel fuel filter, etc.) is scheduled in the maintenance operations for your vehicle.

Replacement intervals for filter elements: refer to the Maintenance Service Document for your vehicle.

BATTERY

Depending on the vehicle, the battery is in the engine compartment or in the luggage compartment.

It is always maintenance-free.

Depending on the vehicle, A system continuously checks the battery charge status. If this decreases, the message "Battery low start engine" is displayed on the instrument panel. In this case, start the engine. Then the message "Battery charging" appears on the instrument panel for the duration of the charging time.

The charge status of your battery can decrease especially if you use your vehicle:

- for short journeys;
- for driving in town;
- when the temperature drops;
- after extended use of electrical equipment (radio etc.) with the engine switched off.



The engine may be hot during operations in close proximity. In addition, the engine cooling fan may start at any moment.

Risk of injury.

Replacing the battery

To replace the battery, you must contact an approved Dealer.

Do not connect any external equipment to battery with cables. There is a risk of damage to the vehicle and a risk of injury.



Handle the battery with care as it contains sulphuric acid, which must not come into contact with eyes or skin. If it does, wash the affected area with plenty of cold water. If necessary, consult a doctor.

Ensure that naked flames, red hot objects and sparks do not come into contact with the battery as there is a risk of explosion.

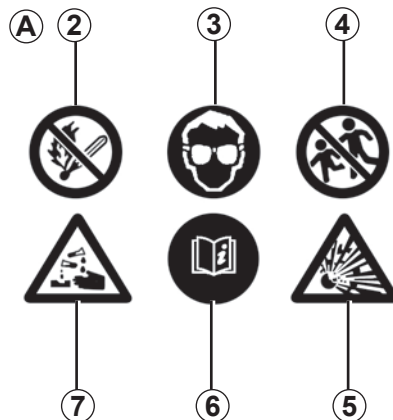

28705

Label A

- Observe the indications on the battery:
- **2** naked flames and smoking forbidden;
 - **3** eye protection required;
 - **4** keep away from children;
 - **5** explosive materials;
 - **6** refer to the handbook;
 - **7** corrosive materials.



The battery is a **specific type**, please ensure it is replaced with the same type, Consult an approved

Dealer.

TYRE PRESSURE

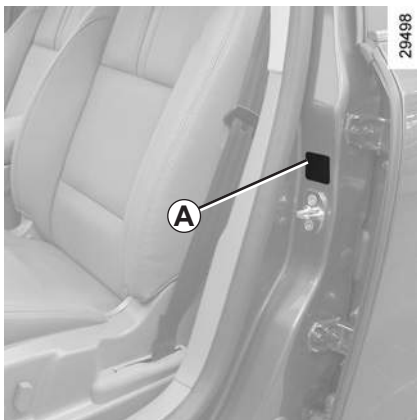

The tyre pressure is indicated on label **A** affixed to the vehicle's body. Open the door to read it.

B: dimension of the tyres fitted to the vehicle.

C: tyre pressures for the front wheels (non-motorway).

D: tyre pressures for the rear wheels (non-motorway).

E: tyre pressures for the front wheels (motorway).

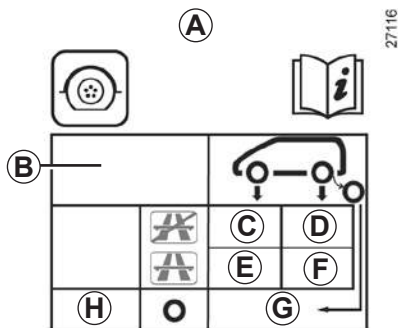

F: tyre pressures for the rear wheels (motorway).

G: tyre pressure for the emergency spare wheel.

H: emergency spare wheel tyre dimension if different to the four tyres fitted to the vehicle.

Tyre safety and use of snow chains

Refer to the information on “Tyres” in Section 5 for the servicing conditions and, depending on the version, the use of chains.

Special note

For vehicles used fully laden (maximum permissible all-up weight) **and towing a trailer**. The maximum speed must be limited to **60 mph (100 km/h)** and the tyre pressure increased by **0.2 bar**.

Refer to the information on “Weights” in Section 6.



When they need to be replaced, only tyres of the same make, size, type and profile should be used.

Tyres fitted to the vehicle should either be identical to those fitted originally or conform to those recommended by your approved Dealer.

BODYWORK MAINTENANCE (1/2)

A well-maintained vehicle will last for longer. It is therefore recommended to regularly maintain the vehicle exterior

Protection against the effects of corrosive agents

Although your vehicle has been treated with very effective anti-corrosion products, it nevertheless remains subject to the effects of:

– **corrosives in the atmosphere**

- atmospheric pollution (urban and industrial areas),
- saline atmospheres (near the sea, particularly in hot weather),
- seasonal and damp climatic conditions, (e.g.: road salt in winter, water from road cleaners, etc.).

– **abrasives**

Wind-borne dust and sand, mud, road grit thrown up by other vehicles, etc.

– **minor impacts**

You should take a minimum number of precautions in order to safeguard your vehicle against such risks and not to lose the benefit of your vehicle's anti-corrosion protection.

What you should not do

- Degrease or clean mechanical components (e.g. the engine compartment), underneath the body, parts with hinges (e.g. inside the fuel tank flap) and painted plastic external fittings (e.g. bumpers) using high-pressure cleaning equipment or by spraying on products not approved by our Technical Department. If adequate precautions are not taken, this could give rise to corrosion or operational faults.
- Wash the vehicle in bright sunlight or freezing temperatures.
- Scrape off mud or dirt without pre-wetting.
- Allow dirt to accumulate.

- Allow rust to form following minor impacts.
- Use solvents not approved by our Technical Department to remove stains as this could damage the paintwork.
- Drive frequently in snow or muddy conditions without washing the vehicle, particularly under the wheel arches and body.

BODYWORK MAINTENANCE (2/2)

You should

- Observe the vehicle stopping distances when driving on gravelled surfaces to prevent paint damage.
- Repair, or have repaired quickly, areas where the paint has been damaged, to prevent corrosion spreading.
- Remember to visit the body shop periodically if your vehicle has an anti-corrosion warranty. Refer to the Maintenance Service Booklet.
- Respect local regulations about washing vehicles (e.g. do not wash your vehicle on a public highway).

- Wash your car frequently, **with the engine off**, with cleaning products recommended by our Technical Department (never use abrasive products) and be sure to jet-rinse off:

- spots of tree resin and industrial grime;

- **bird droppings, which cause a chemical reaction with the paint that rapidly discolours paintwork and may even cause the paint to peel off;**

Wash the vehicle **immediately** to remove these marks since it is impossible to remove them by polishing;

- salt, particularly in the wheel arches and underneath the body after driving in areas where the roads have been gritted;
 - mud in the wheel arches and underneath the body which forms damp patches.

- Before going through a roller type car wash, return the windscreen wiper stalk to the Park position (refer to the information on the “Windscreen wash/wipe” in Section 1). Check the mounting of external accessories, additional lights and mirrors, and ensure that the wiper blades are secured with adhesive tape.

Remove the radio aerial mast if your vehicle is fitted with this equipment.

Remember to remove the tape and refit the antenna after washing.

- Spray mechanical components, hinges, etc. with products approved by our Technical Department to protect them after they have been cleaned.

We have selected special products to care for your vehicle and you can obtain these from the manufacturer's accessory outlets.

INTERIOR TRIM MAINTENANCE (1/2)

A well-maintained vehicle will last longer. It is therefore recommended to maintain the interior of the vehicle regularly.

A stain should always be dealt with swiftly.

Whatever type of stain is on the trim, use **cold** (or warm) **soapy water with natural soap**.

Detergents (washing-up liquid, powdered products, alcohol-based products) should not be used.

Use a soft cloth.

Rinse and soak up the excess.

Glass instrument panel

(e.g. instrument panel, clock, exterior temperature display, radio display, etc.)

Use a soft cloth (or cotton wool).

If this does not clean it properly, use a soft cloth (or cotton wool) slightly moistened with soapy water and then wipe clean with a soft damp cloth or cotton wool.

Finally, **carefully** dry off with a soft dry cloth.

Cleaning products containing alcohol must not be used under any circumstances.

Seat belts

These must be kept clean.

Use products selected by our Technical Department (Approved outlets) or warm, soapy water and a sponge and wipe with a dry cloth.

Detergents or dyes must not be used under any circumstances.

Textiles (seats, door trim, etc)

Vacuum-clean the textiles **regularly**.

Liquid stain

Use soapy water.

Dab lightly (never rub) with a soft cloth, rinse and remove the excess.

Solid or pasty stain

Carefully remove the excess solid or pasty material **immediately** with a spatula (working from the edges to the centre to avoid spreading the stain).

Clean as for a liquid stain.

Special instructions for sweets or chewing gum: put an ice cube on the stain to solidify it then proceed as for a solid stain.

INTERIOR TRIM MAINTENANCE (2/2)

Removal/replacing removable equipment originally fitted in the vehicle

If you need to remove equipment in order to clean the passenger compartment (for example, mats), always ensure that they are correctly refitted and are the right way around (the driver's mat should be fitted on the driver's side, etc.) and fit them with the components supplied with the equipment (for example, the driver mat should always be fixed using the pre-fitted mounting components).

With the vehicle stationary, ensure that nothing will impede driving (anything obstructing the pedals, heel wedged by the mat, etc.).

You should not:

You are strongly advised not to position objects such as deodorants, scents, etc. near air vents, as this could damage your dashboard trim.



You are strongly advised not to use high-pressure or spray cleaning equipment inside the passenger compartment: use of such equipment could impair the correct functioning of the electrical or electronic components in the vehicle, or have other detrimental effects.

Section 5: Practical advice

Puncture	5.2
Tyre inflation kit	5.3
Tool kit (jack - wheelbrace, etc.)	5.6
Wheel trim	5.6
Changing a wheel	5.7
Tyres	5.9
Headlights (changing bulbs)	5.12
Rear and side lights (changing bulbs)	5.15
Interior lights (changing bulbs)	5.18
Fuses	5.21
Battery	5.23
RENAULT card: battery	5.25
Accessories	5.26
Wipers (replacing blades)	5.27
Towing: breakdown	5.28
Operating faults	5.30

PUNCTURE



In the event of a puncture, depending on the vehicle, you will have:

An emergency spare wheel or tyre inflation kit (refer to the information on the following pages).

Emergency spare wheel

This is located in the luggage compartment. To access it:

- open the trunk lid.
- lift up the luggage compartment carpet **A**. If necessary, take out the luggage compartment carpet.
- lift and take out jack in the tool kit (depending on the vehicle).
- unscrew central mounting anticlockwise.
- lift and take out the tool kit.
- remove emergency spare wheel.

Special note:

The Tyre Pressure Monitor function does not check the emergency spare wheel (the wheel replaced by the emergency spare wheel disappears from the instrument panel display).

Refer to Section 2 “Tyre pressure monitor”.



If the emergency spare wheel has been stored for several years, have it checked by your Dealer to ensure that it is safe to use.

Vehicles fitted with an emergency spare wheel smaller than the four other wheels:

- Never fit more than one emergency spare wheel to the same vehicle.
- Replace the emergency spare wheel as soon as possible with a wheel with the same dimensions as the original.
- When this is fitted to the vehicle, which must only be a temporary measure, the driving speed must not exceed the speed indicated on the label on the wheel.
- Fitting an emergency spare wheel may alter the way the vehicle usually runs. Avoid sudden acceleration or deceleration and reduce your speed when cornering.
- If you need to use snow chains, fit the emergency spare wheel to the rear axle and check the tyre pressure.

TYRE INFLATION KIT (1/3)

32788



The kit repairs tyres when tread **A** has been damaged by objects smaller than 4 mm. It cannot repair all types of puncture, such as cuts larger than 4 mm, or cuts in tyre sidewall **B**.

Ensure also that the wheel rim is in good condition.

Do not pull out the foreign body causing the puncture if it is still in the tyre.



Do not attempt to use the inflation kit if the tyre has been damaged as a result of driving with a puncture.

You should therefore carefully check the condition of the tyre sidewalls before any operation.

Driving with underinflated, flat or punctured tyres can be dangerous and may make the tyre impossible to repair.

This repair is temporary

A tyre which has been punctured should always be inspected (and repaired, where possible) as soon as possible by a specialist.

When taking a tyre which has been repaired using this kit to be replaced, you must inform the specialist.

When driving, vibration may be felt due to the presence of the repair product injected into the tyre.



The kit is only approved for inflating the tyres of the vehicle originally equipped with the kit.

It must never be used to inflate the tyres of another vehicle, or any other inflatable object (rubber ring, rubber boat, etc.).

Avoid spillage on skin when handling the repair liquid bottle. If droplets do leak out, rinse them off with plenty of water.

Keep the repair kit away from children.

Do not dispose of the empty bottle in the countryside. Return it to your approved dealer or to a recycling organisation.

The bottle has a limited service life which is indicated on its label. Check the expiry date.

Contact an approved dealer to replace the inflation tube and repair product bottle.

TYRE INFLATION KIT (2/3)

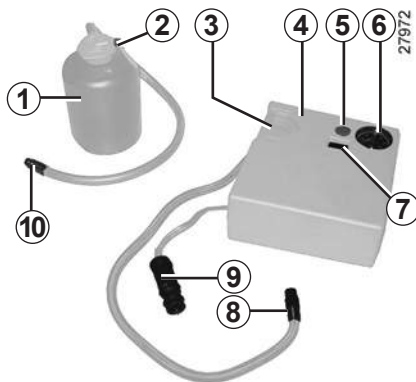

Depending on the vehicle, in the event of a puncture, use the tyre inflation kit.



Before using this kit, park the vehicle at a sufficient distance from traffic, switch on the hazard warning lights, apply the handbrake, ask all passengers to leave the vehicle and keep them away from traffic.

- Take out compressor **4** and bottle **1** located under the luggage compartment carpet;
- unroll inflation hose **8** and lead **9** located under the compressor and inflation hose **10**. Attach the bottle to its mounting **3** and screw inflation hose **8** onto end piece **2**.

With the engine running and the parking brake applied,

- unscrew the valve cap of the wheel concerned and screw inflation hose **10** onto the valve;
- connect end piece **9** to one of the vehicle's accessories sockets (refer to the information on the "Accessories socket" in Section 3) then press switch **7** to inflate the tyre to the recommended pressure (refer to the label located on the edge of the driver's door);
- After a maximum of 5 minutes, stop inflating and read the pressure on pressure gauge **6**. To adjust the pressure if necessary: continue inflating to increase the pressure or press button **5** to decrease it.

If a minimum pressure of 1.8 bar is not reached after 15 minutes, repair is not possible; do not drive the vehicle but contact an approved dealer.



If the vehicle is parked on the hard shoulder, you must warn other road users of your vehicle's presence with a warning triangle or with other devices as per the legislation applying to the country you are in.

TYRE INFLATION KIT (3/3)



Once the tyre is inflated correctly:

- stop using the kit;
- slowly unscrew the two inflation end pieces **8** and **10**;
- screw end piece **10** onto the bottle so that no product escapes;



Nothing should be placed around the driver's feet as such objects may slide under the pedals during sudden braking manoeuvres and obstruct their use.

Affix the driving recommendation label, located under bottle **1**, to the dashboard where it can easily be seen by the driver;

- store the kit;
- After the first inflation procedure the tyre will still be leaking; it is vital to drive in order to plug the hole;
- Start immediately and drive at between 12 and 36 mph (20 and 60 km/h) to distribute the product evenly throughout the tyre, stopping after a distance of 2 miles (3 kilometres) to check the pressure;
- If the pressure is above 1.3 bar but lower than the recommended pressure, readjust it (refer to the label affixed to the edge of the driver's door), otherwise contact an approved dealer: repair is not possible.

Note: after using the inflation kit, you should visit an approved Dealer to replace the inflation hose and the bottle of repair product.

Precautions when using the kit

The kit should not be operated for more than 15 consecutive minutes.



Please be aware that a poorly tightened or missing valve cap can make the tyres less airtight and lead to pressure loss.

Always use valve caps identical to those fitted originally and tighten them fully.



Following repair with the kit, do not travel further than 120 miles (200 km). In addition, reduce your speed and under no circumstances exceed 48 mph (80 km/h). The sticker, which you must affix in a prominent position on the dashboard, reminds you of this.

Depending on the country or local legislation, a tyre repaired with the inflation kit may need to be replaced.

TOOL KIT/WHEEL TRIM - WHEEL

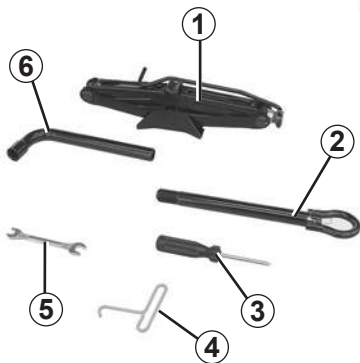

The tool kit is located under the luggage compartment carpet (tools varies depending on the vehicle).

1 Jack

When replacing the jack, fold it correctly and position the wheelbrace correctly before replacing it in its position.



The jack is designed for wheel changing purposes only. Under no circumstances should it be used for carrying out repairs underneath the vehicle or to gain access to the underside of the vehicle.

2 Towing hitch

Refer to the information on “Towing” in Section 5.

3 Screwdriver

4 Hubcap tool

This tool is used to remove the wheel trims.

5 Nut wrench

6 Wheelbrace



Do not leave the tools unsecured inside the vehicle as they may come loose under braking. After use, check that all the tools are correctly clipped into the tool kit, then position it correctly in its housing: there is a risk of injury.

If wheel bolts are supplied in the tool kit, only use these bolts for the emergency spare wheel: refer to the label affixed to the emergency spare wheel.

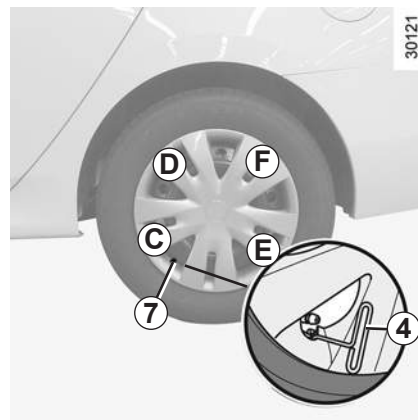

Wheel trim

Remove it using hubcap tool 4 by engaging the hook in the opening provided near valve 7.

To refit the hubcap, align it with valve 7. Push the retaining hooks in fully, starting with side C near the valve, followed by D and E, finishing at F opposite the valve.

Note: if you are using anti-theft bolts, refer to the information on “Changing a wheel”.

CHANGING A WHEEL (1/2)

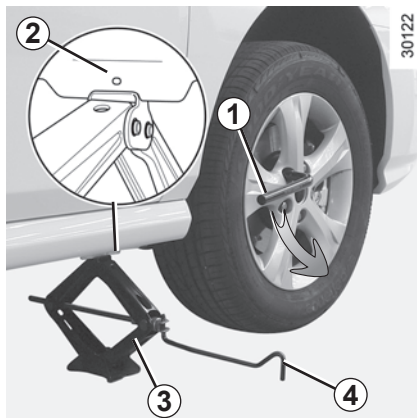

Switch on the hazard warning lights.

Keep the vehicle away from traffic and on a level surface where it will not slip (if necessary, place a solid support under the jack base).

Apply the parking brake and engage a gear (first or reverse, or P for automatic transmissions).

Ask all the passengers to leave the vehicle and keep them away from traffic.

Vehicles equipped with jack and wheel wrench

If necessary, remove the wheel trim.

- Undo the wheel bolts as shown by the arrow using wheelbrace **1**. Position wheelbrace **1** so that you press down on it.
- Position jack **3** horizontally. The jack head **must** be positioned at the same height as plate mounting **2**, as close as possible to the wheel concerned.

- start cranking the jack using handle **4** to position the jack head in the centre of plate mounting **2** (which should be pushed slightly under the vehicle).
- turn handle **4** several times to lift the wheel off the ground.



If the vehicle is parked on the hard shoulder, you must warn other road users of your vehicle's presence with a warning triangle or with other devices as per the legislation applying to the country you are in.

If the vehicle is not equipped with the jack and wheel wrench, these can be obtained from an approved dealer.



To prevent any risk of injury or damage to the vehicle, only crank the jack until the wheel you are replacing is a maximum of 3 centimetres off the ground.

CHANGING A WHEEL (2/2)

- undo the bolts and take off the wheel.
- fit the emergency spare wheel on the central hub and turn it to locate the mounting holes in the wheel and the hub.

If bolts are supplied with the emergency spare wheel, only use these bolts for the emergency spare wheel. Tighten the bolts, checking that the wheel is correctly positioned on its hub and lower the jack.

With the wheel on the ground, tighten the bolts fully and have the tightness of the bolts checked (tightening torque: 130 Nm for steel wheel, 145 Nm for alloy wheel) and the emergency spare wheel pressure checked as soon as possible.

Anti-theft bolts

If you use anti-theft bolts, fit these nearest the valve (wheel embelisher may not be able to fit).



If you have a puncture, replace the wheel as soon as possible.

A tyre which has been punctured should always be inspected (and repaired, where possible) by a specialist.

TYRES (1/3)

Tyre and wheel safety

The tyres are the only point of contact between the vehicle and the road. It is therefore imperative that they are kept in good condition.

You must make sure that your tyres conform to local road traffic regulations.



When they need to be replaced, only tyres of the same make, size, type and profile should be used.

Tyres fitted to the vehicle should either be identical to those fitted originally or conform to those recommended by your approved dealer.



Maintaining the tyres

The tyres must be in good condition and the tread form must have sufficient depth; tyres approved by our technical department have tread wear indicators **1** which are **indicators moulded into the tread at several points.**

When the tyre tread has been worn to the level of the wear indicators, **they become visible 2**: it is **then** necessary to replace your tyres because the tread rubber is **no more than 1.6 mm deep, resulting in poor roadholding on wet roads.**

An overloaded vehicle, long journeys by motorway, particularly in very hot weather, or continual driving on poorly surfaced minor roads will lead to more rapid tyre wear and affect safety.



Incidents which occur when driving, such as striking the kerb, may damage the tyres and wheel rims, and could also lead to misalignment of the front or rear axle geometry. In this case, have the condition of these checked by an approved dealer.

TYRES (2/3)

Tyre Pressure

Comply with the specified tyre pressures (including the emergency spare wheel). These must be checked at least once a month and before any long journey (refer to Section 4 “Tyre pressure”).



Incorrect tyre pressures

lead to abnormal tyre wear and unusually hot running. These are factors which may seriously affect safety and lead to:

- poor road holding,
- risk of bursting or tread separation.

The pressure depends on the load and the speed of use. Adjust the pressure according to the conditions of use (refer to the information on “Tyre pressures”).

Pressures should be checked when the tyres are cold; ignore higher pressures which may be reached in hot weather or following a fast journey.

If tyre pressures cannot be checked when the tyres are **cold**, the normal pressures must be increased by **0.2** to **0.3 bar (or 3 psi)**.

Never deflate a hot tyre.

Special features

Depending on the vehicle, there may be an adapter which needs to be positioned on the valve before air is added.



Please be aware that a poorly tightened or missing valve cap can make the tyres less airtight and lead to pressure loss.

Always use valve caps identical to those fitted originally and tighten them fully.

Fitting new tyres



For safety reasons, this operation must be carried out by a specialist.

Fitting different tyres may change your vehicle as follows:

- It may mean that your vehicle no longer conforms to current regulations;
- It may change the way it handles when cornering;
- It may cause the steering to be heavy;
- It may affect the use of snow chains.

Emergency spare wheel

Refer to Section 5 “Emergency spare wheel” and “Changing a wheel”.

TYRES (3/3)

Changing the position of the wheels

It is strongly recommended that you do not change the position of the wheels.

Use in winter

Chains

For safety reasons, fitting snow chains to the rear axle is strictly forbidden.

Fitting larger tyres than the original ones **will prevent chains from being fitted.**

Snow or Winter tyres

We would recommend that these be fitted to all **four wheels** to ensure that your vehicle retains maximum adhesion.

Warning: these tyres may be asymmetrical “snow” tyres (for use in winter), with different inside and outside properties. Check the direction of rotation and the **INSIDE/OUTSIDE** markings on the tyre sidewall before fitting it.

The maximum speed code for these “snow” tyres (for use in winter) may be lower than the maximum speed for your vehicle. It consists of several letters shown on the tyre sidewall.

Studded tyres

This type of equipment may only be used for a limited period and as laid down by local legislation. It is necessary to observe the speed specified by current legislation.

These tyres must, at a minimum, be fitted to the two front wheels.



Chains may only be fitted to tyres of the same size as those originally fitted to **your vehicle.**

If your vehicle is originally fitted with tyres with a diameter of 17”, snow chains may be used but only if specific chains are used. Consult an approved dealer.

If your vehicle is fitted with tyres with a diameter of 18”, consult an approved dealer to find out if snow chains can be used.

In all cases, consult an approved Dealer who will be able to advise you to select the best equipment (snow tyres, chains, etc.) for your vehicle.



Vehicles fitted with the tyre pressure monitor

Each of the sensors incorporated in the valves is dedicated to a single wheel: under no circumstances should you swap the wheels, without having the system reset.

There is a risk of incorrect information which could have serious consequences.

HALOGEN HEADLIGHTS: changing bulbs

29442

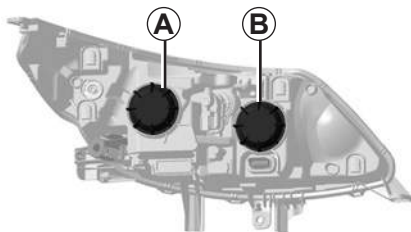

The bulbs are not easy to access (requires bodywork or mechanical components to be removed) and there is a risk of injury during removal. We therefore recommend **that you have your bulbs replaced by an approved Dealer.**

To comply with current legislation, or as a precaution, you can obtain an emergency kit from an approved Dealer containing a set of spare bulbs and fuses.

29443

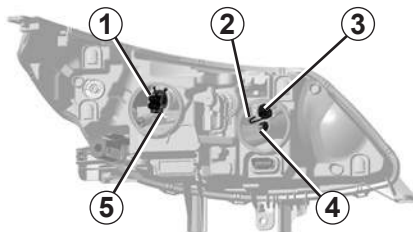

Dipped beam/main beam headlights

Turn cover **A** or **B** a quarter turn anticlockwise, then remove connector **1** or **3**.

Remove clip **2** or **5**, pressing down on it, then remove the bulb holder.

Replace the bulb.

Bulb type: **only** use anti UV 55W bulbs to ensure the plastic glass on the headlights is not damaged.

Dipped beam 1 → H7

Main beam 3 → H1

Do not touch the bulb glass with your fingers. Hold it by its base.

When the bulb has been changed, make sure you refit the cover correctly.

Front side lights

Turn cover **B** a quarter turn anticlockwise, then unclip bulb holder **4**, pulling it upwards to remove the bulb.

Bulb type: **W5W.**

Direction indicator lights

Consult an approved Dealer.



The bulbs are under pressure and can break when replaced.

Risk of injury.



The engine may be hot when carrying out operations in close proximity. In addition, the engine cooling fan can come on at any moment.

Risk of injury.

XENON HEADLIGHTS: changing bulbs

29440

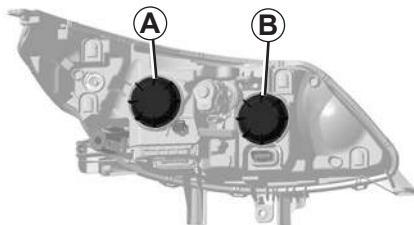

Because some components (the battery, its mounting) need to be removed, **you are advised to have your bulbs replaced by an approved Dealer.**

Dipped beam headlights A

Never remove cover A. Fire hazard.



Dealer.

Due to the danger involved in handling high-voltage devices, this type of bulb must be replaced by an approved

29441

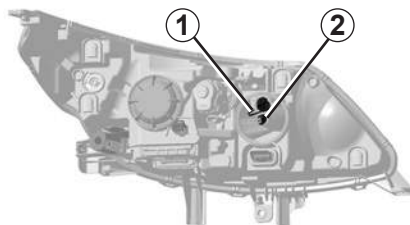

Main beam headlights

Turn cover **B** a quarter turn anticlockwise, then unclip bulb holder **2**, pulling it upwards to remove the bulb.

Replace the bulb.

Bulb type: H1

Do not touch the bulb glass with your fingers.

Once the bulb has been replaced, reposition the lens.



A special mounting is required to fit this type of headlight, **it is forbidden to fit a headlight with xenon bulbs to a vehicle which was not designed for it.**

Front side lights

Turn cover **B** a quarter turn anticlockwise, then unclip bulb holder **2**, pulling it upwards to remove the bulb.

Bulb type: W5W.

Direction indicator lights

Consult an approved Dealer.

Cleaning the headlights

The lights contain plastic glass; clean them with a soft cloth or sponge.

If this does not clean them properly, use a soft cloth or sponge with a little soapy water. Finally, wipe them **carefully** with a soft, dry cloth. **Under no circumstances should alcohol-based products be used.**



The engine may be hot when carrying out operations in close proximity. In addition, the engine cooling fan can come on at any moment.

Risk of injury.

HEADLIGHTS: fog lights, additional lights

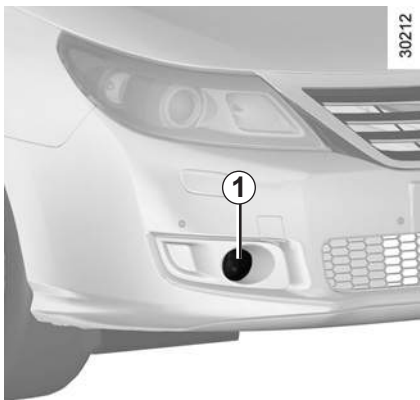

Front fog lights 1

Changing bulbs

Consult an approved Dealer.



The bulbs are under pressure and can break when replaced.

Risk of injury.

Rear fog lights

Refer to Section 5 “Rear lights and indicator lights: changing bulbs”.

Additional lights

If you wish to fit fog lights or long range headlights to your vehicle, consult an approved Dealer.



Any operation on (or modification to) the electrical system must be performed by an approved Dealer since an incorrect connection might damage the electrical equipment (harness, components and in particular the alternator). In addition, your Dealer has all the parts required for fitting these units.

REAR AND SIDE LIGHTS: changing bulbs (1/3)



Direction indicator lights

Remove the lights access cover by undoing **2** from inside the luggage compartment. Remove the nuts **1**, release the light unit and pull the light unit to remove it.

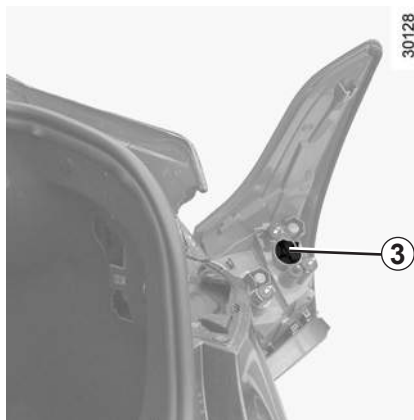

Turn bulb holder **3** a quarter turn anti-clockwise, then unscrew the bulb in the same way while pressing down on it.

Bulb type: PY21W.



The bulbs are under pressure and can break when replaced.

Risk of injury.



LED brake light **4**

Consult an approved Dealer.

REAR AND SIDE LIGHTS: changing bulbs (2/3)



Reversing lights/rear fog lights.

Remove the clip from the inside of the trunk lid using a flat-blade screwdriver, then pull back **A**.

Note: take care not to break **A** when pulling it back.



The bulbs are under pressure and can break when replaced.

Risk of injury.

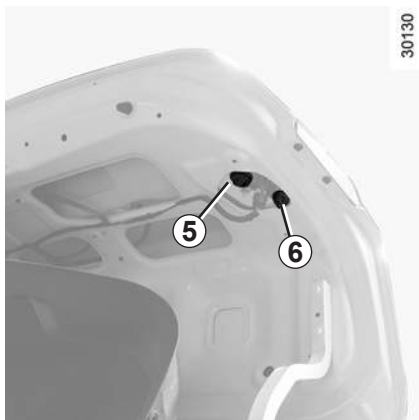

Undo bulb holder **5/6** a quarter turn anticlockwise, then remove the bulb by pulling it upwards.

Reversing lights **6**

Bulb type: W16W.

Rear fog lights **5**

Bulb type: P21W.

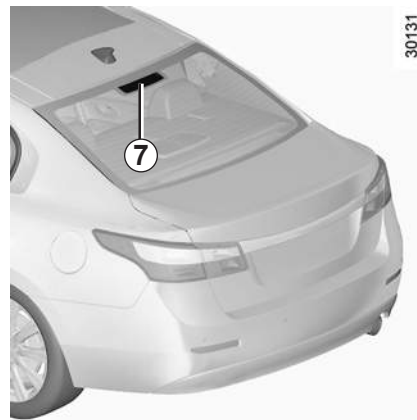

High-level LED brake light **7**

Consult an approved Dealer.

REAR AND SIDE LIGHTS: changing bulbs (3/3)

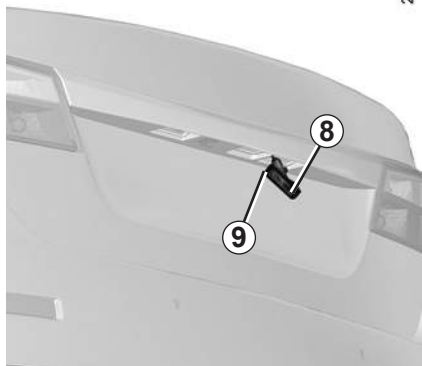

Number plate light 8

- Unclip light **8** by pressing tab **9** using a flat-blade screwdriver type tool.
- Replace the bulb.

Bulb type: W5W.



The bulbs are under pressure and can break when replaced.

Risk of injury.

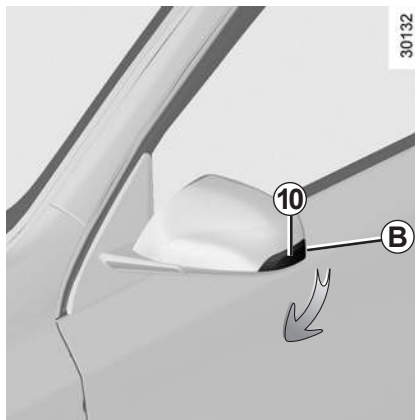

Side direction indicator lights 10

Unclip indicator light **10** (using a flat-blade screwdriver type tool positioned at **B** to move the indicator light towards the front of the vehicle).

Turn the bulb holder a quarter of a turn and take out the bulb.

Bulb type: WY5W.

INTERIOR LIGHTS: changing bulbs (1/3)



Courtesy light

Unclip lens **1** using a flat-blade screwdriver type tool under the courtesy light.

Remove the bulb concerned;

Bulb type: W5W.



Front door lights

Unclip light **2** using a flat-blade screwdriver type tool under each side of the front door light.

When using a tool, place a cloth on the mirror to prevent scratching.

Bulb type: W5W.

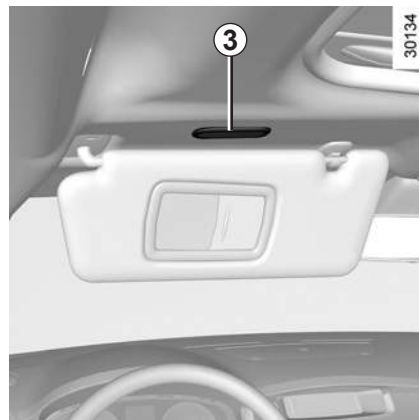

Courtesy mirror light **3**

Unclip the light cover using a flat-blade screwdriver type tool under the cover.

Place a cloth on the mirror to prevent scratching.

Replace the bulb.

Bulb type: W5W.



The bulbs are under pressure and can break when replaced.

Risk of injury.

INTERIOR LIGHTS: changing bulbs (2/3)

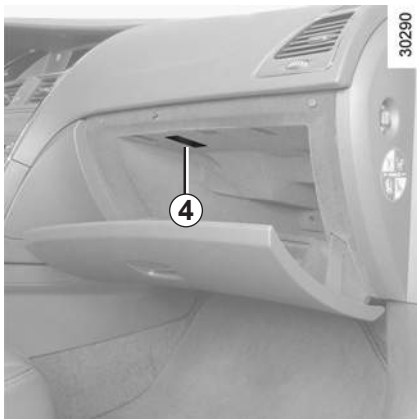

Glove box light 4

Consult an approved Dealer.

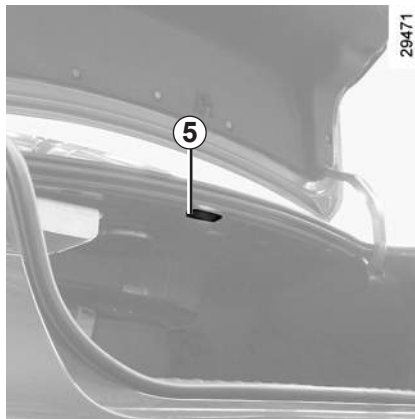

Luggage compartment light 5

Unclip light 5 using a flat-blade screwdriver type tool under the left-hand side of the light.

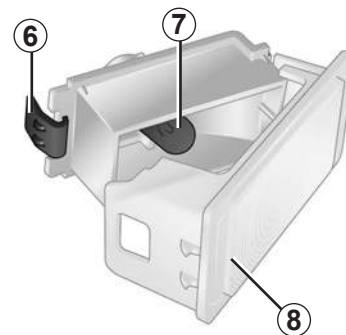

Disconnect the light.

Press tab 6 to release lens 8 and access bulb 7.

Bulb type: W5W.



The bulbs are under pressure and can break when replaced.

Risk of injury.

INTERIOR LIGHTS: changing bulbs (3/3)



Front floor lights 9

There are lights under the glove box or the steering column.

Remove the bulb concerned;

Bulb type: W5W.



The bulbs are under pressure and can break when replaced.

Risk of injury.

FUSES (1/2)

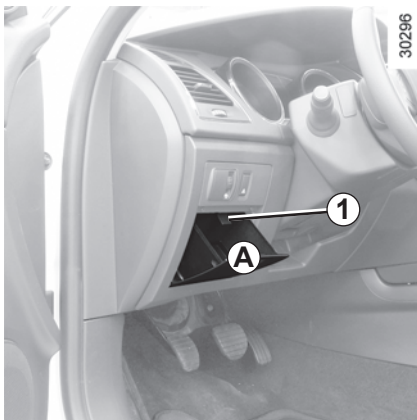

Fuse box

If any electrical component does not work, check the condition of the fuses. Open storage compartment **A**, depending on the vehicle, open the glove box. Press tab **1** and pull it towards you to unclip it.

Find the corresponding fuse, referring to the label at the back of storage compartment **A** or cover **B** and the fuse allocation table on the next page.

In accordance with local legislation or as a precautionary measure:
Obtain an emergency kit containing a set of spare bulbs and fuses from an approved Dealer.

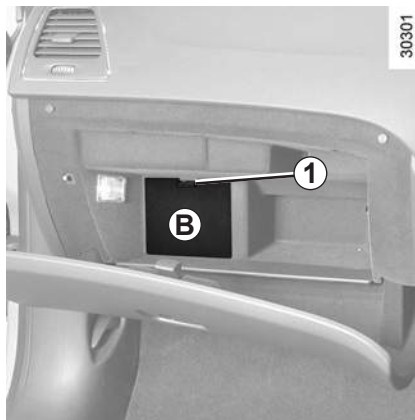

To refit the fuse box in place, push storage compartment **A** or cover **B**, starting from the bottom.



Check the fuse in question and **replace it**, if necessary, **by a fuse of the same rating**.

If a fuse is fitted where the rating is too high, it may cause the electrical circuit to overheat (risk of fire) in the event of an item of equipment using an excessive amount of current.

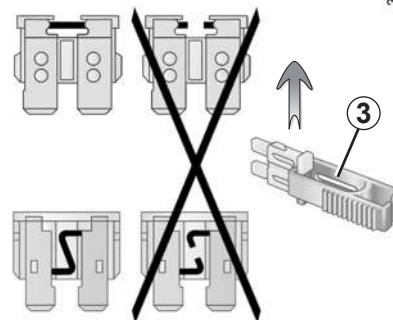

Tweezers 3 and replacement fuses













On the back of cover **A** and **B**, there is a pair of tweezers **3** and some replacement fuses. Release the fuse using tweezers **3**, then slide the fuse sideways to remove it from the tweezers. It is not advisable to use the free fuse locations.















To replace a fuse, stop the engine, remove the RENAULT card from its reader and switch off all electrical equipment.

FUSES (2/2)

Allocation of fuses (depending on the equipment level)

The optional equipment is also marked with an asterisk "*" in the label.

Symbol	Allocation
	Interior lighting
	Interior rear-view mirror
	Heated rear screen
	Horn
	Child safety
BCM	Body Control Module
DIAG	Diagnostic socket
	Direction indicators
	Front seat electric windows
	Heated seats
	Trunk lid
	Sunroof
	Electronic parking brake
	Towing equipment supply
	Front passenger seat adjustment in rear

Symbol	Allocation
STOP	Brake lights
	Radio amplifier
	Rear electric windows
	Radio
	Instrument panel
	ABS/ESP
	Fuel filler flap
	Electric seats
	Accessories sockets
	Ventilation
	Air conditioning
	Cigar lighter
	Heating system
	Windscreen washer
	Headlight height adjustment
	Electric rear sunblind

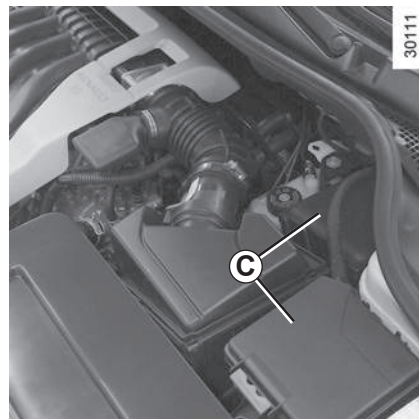

Some accessories are protected by fuses located in the engine compartment in fuse box **C**.

However, because of their reduced accessibility, you are advised to have the fuses in box **C** replaced by an approved Dealer.

BATTERY: troubleshooting (1/2)

To avoid all risk of sparks:

- Ensure that any consumers are switched off before disconnecting or reconnecting the battery.
- when charging, stop the charger before connecting or disconnecting the battery.
- do not place metal objects on the battery, to avoid creating a short circuit between the terminals.
- Always wait at least one minute after the engine has been switched off before disconnecting a battery.
- make sure that you reconnect the battery terminals after refitting.

Connecting a battery charger

The battery charger must be compatible with a battery with a nominal voltage of 12 volts.

Follow the instructions given by the manufacturer of the battery charger you are using.

Starting the vehicle using the battery from another vehicle

If you have to use the battery from another vehicle to start, obtain suitable jump leads (with a large cross section) from an approved dealer or, if you already have jump leads, ensure that they are in perfect condition.

The two batteries must have an identical nominal voltage of 12 volts. The battery supplying the current should have a capacity (amp-hours, Ah) which is at least the same as that of the discharged battery.



Handle the battery with care as it contains sulphuric acid, which must not come into contact with eyes or skin. If it does, wash the affected area with plenty of cold water. If necessary, consult a doctor.

Ensure that naked flames, red hot objects and sparks do not come into contact with the battery as there is a risk of explosion.

The engine may be hot when carrying out operations in close proximity. In addition, the engine cooling fan can come on at any moment.

Risk of injury.



Special procedures may be required to charge some batteries. Contact an approved Dealer.

Avoid all risk of sparks which may cause an immediate explosion, and charge the battery in a well-ventilated area.

Risk of serious injury.

BATTERY: troubleshooting (2/2)

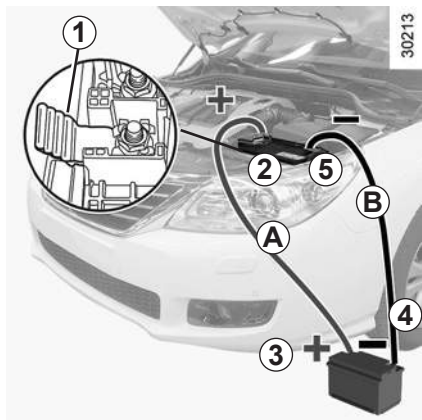

Starting the vehicle using the battery from another vehicle (continued)

Ensure that there is no risk of contact between the two vehicles (risk of short circuiting when the positive terminals are connected) and that the discharged battery is properly connected. Switch off your vehicle ignition.

Start the engine of the vehicle supplying the current and run it at an intermediate engine speed.

Leads **A** and **B** must only be connected to the terminals indicated.

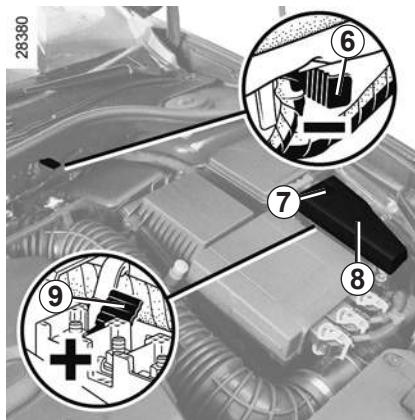

Battery in the engine compartment

Attach positive lead **A** to **mounting 1** attached to (+) **terminal 2** then to (+) **terminal 3** of the battery supplying the current.

Attach negative lead **B** to the (-) **terminal 4** of the battery supplying the current, then to (-) **terminal 5** of the discharged battery.

Start the engine. As soon as it is running, disconnect leads **A** and **B** in the reverse order (**5-4-3-2** or **6-4-3-9**).

Battery in the luggage compartment (V6 engines)

Use the terminals in the engine compartment.

Turn screw **7** one quarter of a turn clockwise then pull cover **8** upwards to access the (+) terminal **9**. Attach the positive lead **A** to the (+) **terminal 9** then to the (+) **terminal 3** of the battery supplying the current.

Attach the negative lead **B** to the (-) **terminal 4** of the battery supplying the current then to the (-) **terminal 6**.



Check that there is no contact between leads **A** and **B** and that the positive lead **A** is not touching any metal parts on the vehicle supplying the current.
Risk of injury or damage to the vehicle.

RENAULT CARD: battery

30325



Replacing the battery

When the message “Low card battery” appears on the instrument panel, replace the RENAULT card battery, press button **1** pulling on emergency key **2**, then unclip the cover **3** using tab **4**.

Remove the battery by pressing on one side (movement **A**) and by lifting the other (movement **B**) then replace it, ensuring the polarity and model, shown on cover **3** are respected.

To refit, proceed in the reverse order to removal, checking that cover **3** is correctly clipped on (risk of an incorrect

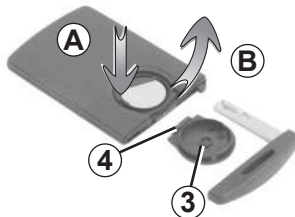

seal if it is not fully clipped on), then press one of the card buttons, whilst in the vicinity of the vehicle; the message will disappear.

Note: it is not advisable to touch the electronic circuit or contacts on the RENAULT card when replacing the battery.

26862

26913

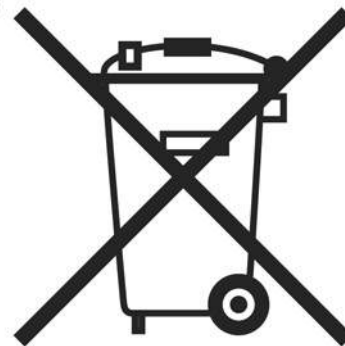

Operating faults

If the battery is too weak to ensure correct operation, you may start (insert the RENAULT card in the card reader) and lock/unlock the vehicle (refer to Section 1 “Locking/unlocking the doors”).



Do not throw away your used batteries; give them to an organisation responsible for collecting and recycling batteries.

The batteries are available from approved Dealers. These batteries have a service life of approximately two years. Check that there is no dye on the battery: risk of an incorrect electrical contact.

ACCESSORIES



Before fitting an electrical or electronic device (particularly for transmitters/receivers: frequency bandwidth, power level, position of the aerial, etc.), ensure that it is compatible with your vehicle.

Consult an approved Dealer for this information.



Use of transmission/receiving devices (telephones, CB equipment etc.).

Telephones and CB equipment with integrated aerials may cause interference to the original electronic systems fitted to the vehicle: it is advisable only to use equipment with an external aerial.

Furthermore, we remind you of the need to comply with the legislation in force concerning the use of such equipment.



Fitting after-market accessories

If you wish to install accessories on the vehicle: consult an approved dealer.

Also, to ensure the correct operation of your vehicle, and to avoid any risk to your safety, we recommend that you use only specific accessories, designed for your vehicle, which are the only accessories for which the manufacturer will provide a warranty.



If you are using an anti-theft device, only attach it to the brake pedal.



Electrical and electronic accessories

– Connect accessories with a maximum power of 120 Watts only.

Fire hazard.

- No work may be carried out on the vehicle's electrical or radio circuits, except by approved Dealers: an incorrectly connected system may result in damage being caused to the electrical equipment and/or the components connected to it;
- if the vehicle is fitted with any aftermarket electrical equipment, make sure that the unit is correctly protected by a fuse. Establish the rating and position of this fuse.

WIPER BLADES

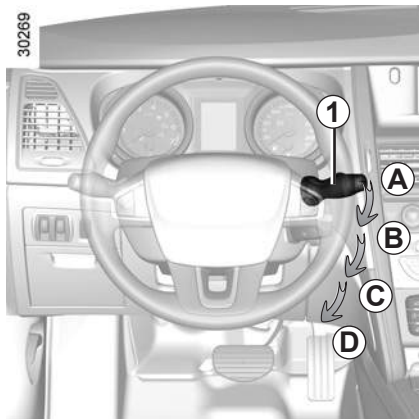

Replacing windscreen wiper blades 2

With the ignition on and the engine switched off, lower windscreen wiper stalk **1** to position **D**; wiper arms **3** stop away from the bonnet.

Lift wiper arm **3**, press tab **4** (movement **E**), move the wiper blade to **F** after having separated it from the arm.

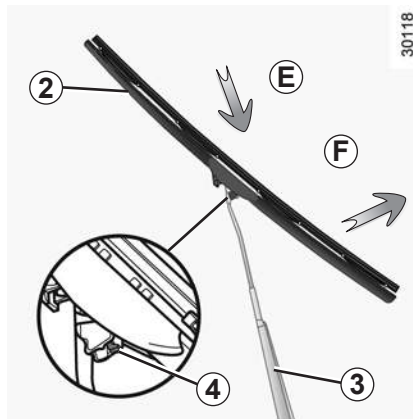

To refit

To refit the wiper blade, proceed in the reverse order to removal. Make sure that the blade is correctly locked in position.

Return windscreen wiper stalk **1** to park position **A**.

Do not pull up the wiper arm when it is not stopped away from the bonnet.

If you pull it up by force, the wiper arm and bonnet could be damaged.

Check the condition of the wiper blades. You are responsible for their service life:

- Clean the blades and the windscreen regularly with soapy water.
- do not use them when the windscreen is dry;
- free them from the windscreen when they have not been used for a long time.



– in frosty weather, make sure that the wiper blades are not stuck by ice (to avoid the risk of the motor overheating);

- Check the condition of the wiper blades.

Replace the wiper blades as soon as they begin to lose efficiency (approximately once a year).

Whilst changing the blade, take care not to drop the arm onto the window after it has been removed as this may break the window.

TOWING: breakdown (1/2)

Before towing, unlock the steering column: with the clutch depressed, engage **first gear** (lever in position **N** or **R** for vehicles with automatic transmissions), insert the RENAULT card in the card reader then press the engine start button for **two seconds**.

Reposition the lever to neutral (position **N** for vehicles fitted with an automatic gearbox).

The column is unlocked, the accessory functions are supplied: the vehicle lights can be used (indicators, brake lights etc.). At night the vehicle must have its lights on.

Once you have finished towing, press the engine start button twice (risk of running down the battery).



Do not remove the RENAULT card from the reader when the vehicle is being towed.

The speed specified by current legislation for towing must always be observed. If your vehicle is the towing vehicle, do not exceed the maximum towing weight for your vehicle (refer to the information on “Weights” in Section 6).

Towing a vehicle with an automatic gearbox

With the engine switched off, the transmission is no longer lubricated. It is preferable to tow this type of vehicle on a trailer or tow it with the front wheels off the ground.

Under exceptional circumstances, you may tow the vehicle with all four wheels on the ground, only going forward, with the gear lever in the **N** position, and for a distance not exceeding 30 miles (50 km).



If the lever is stuck in **P**, even though you are depressing the brake pedal, the lever can be released manually. To do this, insert a rigid rod in the hole **1**, press the rod and unlocking button located on the gear lever knob simultaneously.

TOWING: breakdown (2/2)

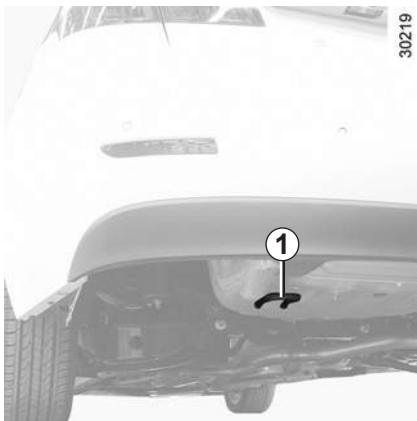

Only use rear towing point **1** and front towing point **4** (never use the drive shafts). These towing points may only be used for towing; never use them for lifting the vehicle directly or indirectly.

Towing points: precautions for use 1

- Use only a rope or a cable to tow the vehicle (check the legal requirements), **not a bar**.
- Check that the rope is level when using the rope.

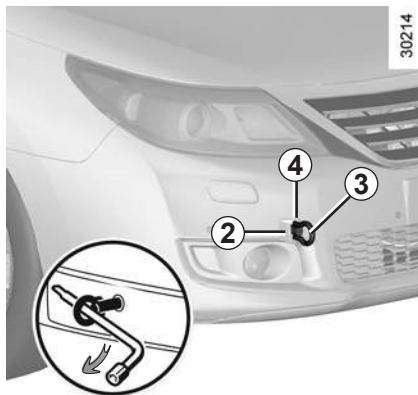

Access to towing points

Unclip cover **2**.

Screw in towing hitch 3 as far as it will go: first screw in hitch **3** by hand, then finish tightening it using the wheelbrace.

Towing hitch **3** and the wheelbrace are located in the tool kit in the luggage compartment (refer to Section 5 “Tool kit”).



When the engine is stopped, steering and braking assistance are not operational.



– Use a rigid towing bar. If a rope or cable is used (where the law allows this), the vehicle being towed must be able to brake.

- A vehicle must not be towed if it is not fit to be driven.
- Avoid accelerating or braking suddenly when towing, as this may result in damage being caused to the vehicle.
- When towing a vehicle, it is advisable not to exceed 15 mph (25 km/h).

OPERATING FAULTS (1/5)

The following advice will enable you to carry out quick, temporary repairs. For safety reasons you should always contact an approved dealer as soon as possible.

Using the RENAULT card	POSSIBLE CAUSES	WHAT TO DO
The RENAULT card does not lock or unlock the doors.	Card battery is flat.	Replace the battery. You can still lock/unlock and start your vehicle (refer to the information on "Locking/unlocking the doors" in Section 1 and "Starting/Stopping the engine" in Section 2).
	Use of appliances operating on the same frequency as the card (mobile phone, etc.).	Stop using the equipment or use the emergency key (refer to the information on "Locking/unlocking the doors" in Section 1).
	Vehicle located in a high electromagnetic radiation zone. Vehicle battery flat.	Use the emergency key integrated in the card (refer to the information on "Locking/unlocking the doors" in Section 1).

OPERATING FAULTS (2/5)

The starter is activated	POSSIBLE CAUSES	WHAT TO DO
<p>The instrument panel indicator lights are weak or fail to light up and the starter does not turn.</p>	<p>Battery terminals not tight, battery terminals disconnected or oxidised.</p>	<p>Retighten or reconnect the terminals, or clean them if they are oxidised.</p>
	<p>Discharged battery or not operational.</p>	<p>Connect another battery to the faulty battery. Refer to information on “Battery: troubleshooting” in Section 5 or replace the battery if necessary. Do not push the vehicle if the steering column is locked.</p>
<p>The engine will not start.</p>	<p>Starting conditions are not fulfilled.</p>	<p>Refer to the information on “Starting/stopping the engine” in Section 2.</p>
	<p>The hands-free RENAULT card does not work.</p>	<p>Insert the card in the card reader in order to start the engine. Refer to the information on “Starting/stopping the engine” in Section 2.</p>
<p>The engine cannot be switched off.</p>	<p>Card not detected.</p>	<p>Insert the card in card reader.</p>
	<p>Electronic fault.</p>	<p>Press the starter button quickly five times.</p>

OPERATING FAULTS (3/5)

On the road	POSSIBLE CAUSES	WHAT TO DO
Vibrations.	Tyres not inflated to correct pressures, incorrectly balanced or damaged.	Check the tyre pressures: if this is not the problem, have them checked by an approved dealer.
White smoke from the exhaust.	This is not necessarily a fault. Smoke may be caused by regeneration of the particle filter.	Refer to the information on “Special features of diesel versions” in Section 2.
Smoke under the bonnet.	Short-circuit or cooling system leak.	Stop, switch off the ignition, stand away from the vehicle and contact an approved dealer.
The oil pressure warning light comes on:		
on a bend or when braking.	The level is too low.	Top up the engine oil (refer to the information on “Engine oil level – Topping up/refilling” in Section 4).
is slow to go out or remains lit when accelerating.	Loss of oil pressure.	Stop the vehicle and contact an approved Dealer.

OPERATING FAULTS (4/5)

On the road	POSSIBLE CAUSES	WHAT TO DO
Steering becomes heavy.	Assistance overheating.	Consult an approved dealer.
The engine overheats. The coolant temperature indicator is in the warning zone and the STOP warning light comes on.	Engine cooling fan not working.	Stop the vehicle, switch off the engine and contact an approved dealer.
	Coolant leaks.	Check the coolant reservoir: it should contain fluid. If there is no coolant, consult an approved dealer as soon as possible.



Radiator: If there is a significant lack of coolant, remember that it must never be topped up using cold coolant while the engine is very warm. After any procedure on the vehicle which has involved even partial draining of the cooling system, it must be refilled with a new mixture prepared in the correct proportions. Reminder: only products approved by our Technical Department may be used for this purpose.

OPERATING FAULTS (5/5)

Electrical equipment	POSSIBLE CAUSES	WHAT TO DO
The wipers do not work.	Wiper blades stuck. Faulty electrical circuit.	Free the blades before using the wipers. Consult an approved dealer.
The wiper does not stop.	Faulty electrical controls.	Consult an approved dealer.
Direction indicators flashing more quickly.	Blown bulb.	See information on “Headlights: changing the bulbs” or “Rear lights: changing the bulbs” in section 5.
The direction indicators do not work.	Faulty electrical circuit.	Consult an approved dealer.
The lights do not come on or go off.	Faulty electrical circuit or control.	Consult an approved dealer.
Traces of condensation in the lights.	Traces of condensation may be a natural phenomenon caused by variations in temperature. In this situation, these traces soon disappear when the lights are switched on.	

Section 6: Technical specifications

Vehicle identification plates	6.2
Engine identification plates	6.3
Dimensions (in metres)	6.5
Engine specifications.	6.6
Weights	6.7
Towing weights	6.7
Replacement parts	6.8
Service sheets	6.9
Anti-corrosion check	6.15

VEHICLE IDENTIFICATION PLATES

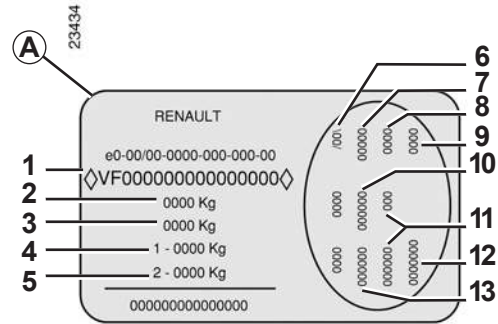
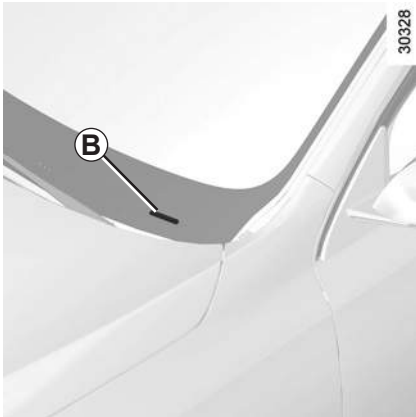

The information shown on the vehicle identification plate should be quoted on all correspondence or orders.

Vehicle identification plate A

- 1 Vehicle type and chassis number.
- Depending on the vehicle, this information is also given on marking B.**
- 2 Maximum permissible all-up weight.
- 3 Total train weight (vehicle fully loaded, with trailer).
- 4 Front axle Maximum permissible weight.

- 5 Rear axle Maximum permissible weight.
- 6 Technical specifications of vehicle.
- 7 Vehicle paint reference.
- 8 Equipment level.
- 9 Vehicle type.
- 10 Trim code.
- 11 Additional equipment specification.
- 12 Fabrication number.
- 13 Interior trim code.

ENGINE IDENTIFICATION PLATES (1/2)

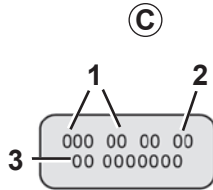

27193

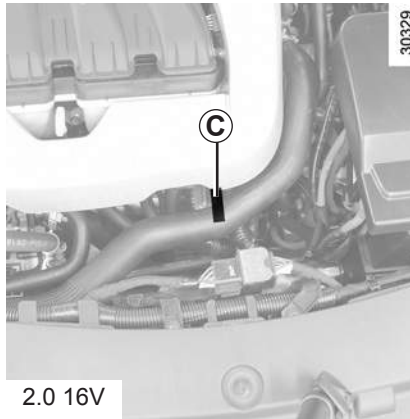

30329

The information on the engine plate (or label) C should be quoted on all your correspondence or orders.

(Location varies depending on engine)

- 1 Engine type.
- 2 Engine suffix.
- 3 Engine number.

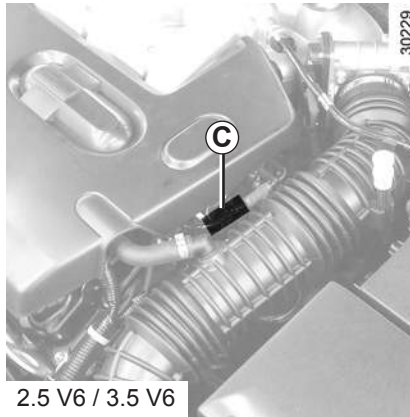

30229

ENGINE IDENTIFICATION PLATES (2/2)

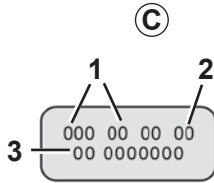

27193

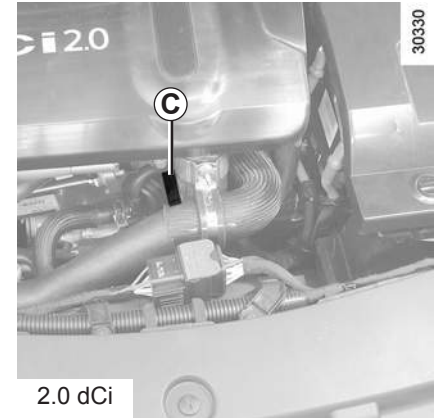
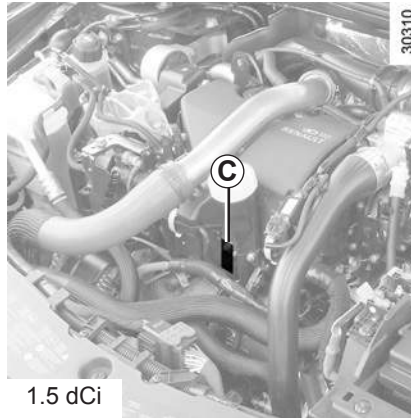

The information on the engine plate (or label) C should be quoted on all your correspondence or orders.

(Location varies depending on engine)

- 1 Engine type.
- 2 Engine suffix.
- 3 Engine number.

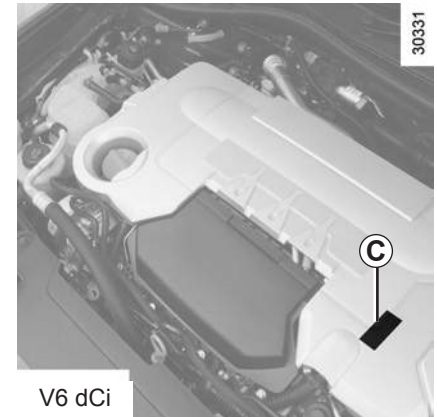

DIMENSIONS (in metres)

30216

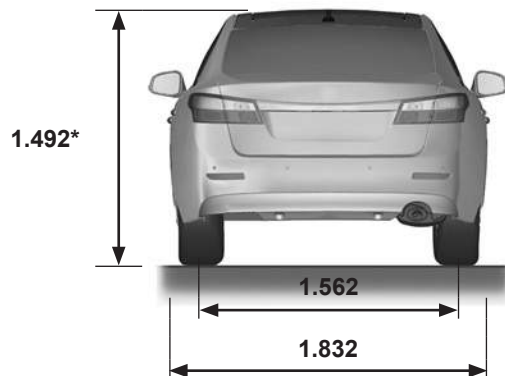
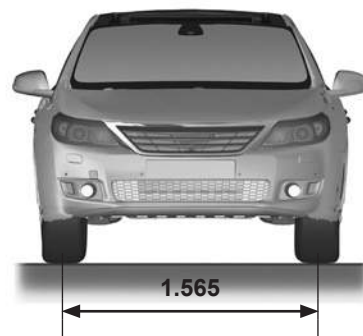
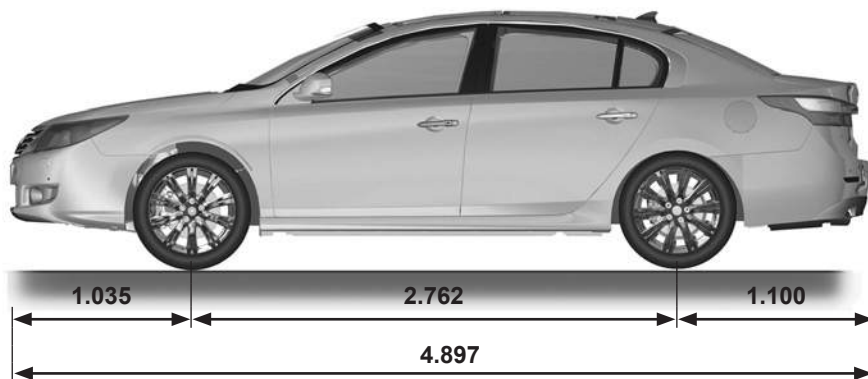

* Unladen

ENGINE SPECIFICATIONS

Versions	2.0 16V	2.5 V6	3.5 V6	1.5 dCi	2.0 dCi	V6 dCi
Engine type (see engine plate)	M4R	2ZV	5ZV	K9K	M9R	V9X
Cubic capacity (cc)	1997	2495	3498	1461	1995	2993
Type of fuel	<p>It is essential that you use unleaded petrol of the octane rating stated on the label inside the fuel filler flap.</p> <p>If not available, for a limited time only, use unleaded fuel:</p> <ul style="list-style-type: none"> – with an octane rating of 91 for a label showing 95 or 98; – with an octane rating of 87 for a label showing 91, 95 or 98. 			<p style="text-align: center;">Diesel</p> <p style="text-align: center;">The label located inside the fuel filler flap indicates authorised fuels.</p>		
Spark plugs	<p>Only use the spark plugs specified for your vehicle's engine.</p> <p>The type should be marked on a label affixed inside the engine compartment. If it is not then contact your approved Dealer.</p> <p>Fitting spark plugs which are not to specification may damage the engine.</p>			–		

WEIGHTS (in kg)

The weights indicated for a basic vehicle without options: they vary depending on the your vehicle's equipment. Consult your approved Dealer.

Maximum permissible all-up weight (MMAC) Total train weight (MTR)	Weights are indicated on the vehicle identification plate (refer to the information on "Vehicle identification plates" in Section 6)
Braked trailer weight	found by calculating: MTR - MMAC
Unbraked trailer weight	650
Permissible nose weight	75
Permissible load on the roof with the carrying device	forbidden

Towing weight (Towing a caravan, boat, etc.)

- It is important to comply with the towing weights, governed by local legislation in each country and, in particular, laid down in the Road Traffic Regulations. Contact an approved Dealer about any towing equipment.
- When towing, under no circumstances may **the total train weight (vehicle + trailer) be exceeded**. However the following is permitted:
 - the Maximum permissible weight at the rear may be exceeded by no more than 15%,
 - the maximum permissible all-up weight may be exceeded by no more than 10% or 100 kg (whichever occurs first).

In either case, the maximum speed of the towing assembly must not exceed 60 mph (100 km/h) and the tyre pressure must be increased by 0.2 bar (3 PSI).

- The engine output and climbing capability are reduced with altitude. We recommend that the maximum load be reduced by 10% at an altitude of 1,000 metres and by an additional 10% for each 1,000 metres thereafter.

REPLACEMENT PARTS AND REPAIRS

Original RENAULT parts are based on strict specifications and are subjected to highly-specialised tests. Therefore, they are of at least the same level of quality as the parts fitted originally.

If you always fit genuine RENAULT parts to your vehicle, you will ensure that it performs well. Furthermore, repairs carried out within the manufacturer's Network using original parts are guaranteed according to the conditions set out on the reverse of the repair order.

SERVICE SHEETS (1/6)

VIN:

Date: _____ Miles (Km): _____		Invoice number: _____		Comments/miscellaneous	
Type of operation:		Stamp			
Service <input type="checkbox"/>					
..... <input type="checkbox"/>					
Anti-corrosion check:					
OK <input type="checkbox"/> Not OK* <input type="checkbox"/>					
*See specific page					

Date: _____ Miles (Km): _____		Invoice number: _____		Comments/miscellaneous	
Type of operation:		Stamp			
Service <input type="checkbox"/>					
..... <input type="checkbox"/>					
Anti-corrosion check:					
OK <input type="checkbox"/> Not OK* <input type="checkbox"/>					
*See specific page					

Date: _____ Miles (Km): _____		Invoice number: _____		Comments/miscellaneous	
Type of operation:		Stamp			
Service <input type="checkbox"/>					
..... <input type="checkbox"/>					
Anti-corrosion check:					
OK <input type="checkbox"/> Not OK* <input type="checkbox"/>					
*See specific page					

SERVICE SHEETS (2/6)

VIN:

Date: _____ Miles (Km): _____		Invoice number: _____		Comments/miscellaneous	
Type of operation:		Stamp			
Service <input type="checkbox"/>					
..... <input type="checkbox"/>					
Anti-corrosion check:					
OK <input type="checkbox"/> Not OK* <input type="checkbox"/>					
*See specific page					

Date: _____ Miles (Km): _____		Invoice number: _____		Comments/miscellaneous	
Type of operation:		Stamp			
Service <input type="checkbox"/>					
..... <input type="checkbox"/>					
Anti-corrosion check:					
OK <input type="checkbox"/> Not OK* <input type="checkbox"/>					
*See specific page					

Date: _____ Miles (Km): _____		Invoice number: _____		Comments/miscellaneous	
Type of operation:		Stamp			
Service <input type="checkbox"/>					
..... <input type="checkbox"/>					
Anti-corrosion check:					
OK <input type="checkbox"/> Not OK* <input type="checkbox"/>					
*See specific page					

SERVICE SHEETS (3/6)

VIN:

Date:	Miles (Km):	Invoice number:	Comments/miscellaneous
Type of operation: Service <input type="checkbox"/> <input type="checkbox"/>		Stamp	
Anti-corrosion check: OK <input type="checkbox"/> Not OK* <input type="checkbox"/> *See specific page			

Date:	Miles (Km):	Invoice number:	Comments/miscellaneous
Type of operation: Service <input type="checkbox"/> <input type="checkbox"/>		Stamp	
Anti-corrosion check: OK <input type="checkbox"/> Not OK* <input type="checkbox"/> *See specific page			

Date:	Miles (Km):	Invoice number:	Comments/miscellaneous
Type of operation: Service <input type="checkbox"/> <input type="checkbox"/>		Stamp	
Anti-corrosion check: OK <input type="checkbox"/> Not OK* <input type="checkbox"/> *See specific page			

SERVICE SHEETS (4/6)

VIN:

Date: _____ Miles (Km): _____		Invoice number: _____		Comments/miscellaneous	
Type of operation:		Stamp			
Service <input type="checkbox"/>					
..... <input type="checkbox"/>					
Anti-corrosion check:					
OK <input type="checkbox"/> Not OK* <input type="checkbox"/>					
*See specific page					

Date: _____ Miles (Km): _____		Invoice number: _____		Comments/miscellaneous	
Type of operation:		Stamp			
Service <input type="checkbox"/>					
..... <input type="checkbox"/>					
Anti-corrosion check:					
OK <input type="checkbox"/> Not OK* <input type="checkbox"/>					
*See specific page					

Date: _____ Miles (Km): _____		Invoice number: _____		Comments/miscellaneous	
Type of operation:		Stamp			
Service <input type="checkbox"/>					
..... <input type="checkbox"/>					
Anti-corrosion check:					
OK <input type="checkbox"/> Not OK* <input type="checkbox"/>					
*See specific page					

SERVICE SHEETS (5/6)

VIN:

Date: _____ Miles (Km): _____		Invoice number: _____		Comments/miscellaneous	
Type of operation:		Stamp			
Service <input type="checkbox"/>					
..... <input type="checkbox"/>					
Anti-corrosion check:					
OK <input type="checkbox"/> Not OK* <input type="checkbox"/>					
*See specific page					

Date: _____ Miles (Km): _____		Invoice number: _____		Comments/miscellaneous	
Type of operation:		Stamp			
Service <input type="checkbox"/>					
..... <input type="checkbox"/>					
Anti-corrosion check:					
OK <input type="checkbox"/> Not OK* <input type="checkbox"/>					
*See specific page					

Date: _____ Miles (Km): _____		Invoice number: _____		Comments/miscellaneous	
Type of operation:		Stamp			
Service <input type="checkbox"/>					
..... <input type="checkbox"/>					
Anti-corrosion check:					
OK <input type="checkbox"/> Not OK* <input type="checkbox"/>					
*See specific page					

SERVICE SHEETS (6/6)

VIN:

Date: _____ Miles (Km): _____		Invoice number: _____		Comments/miscellaneous	
Type of operation:		Stamp			
Service <input type="checkbox"/>					
..... <input type="checkbox"/>					
Anti-corrosion check:					
OK <input type="checkbox"/> Not OK* <input type="checkbox"/>					
*See specific page					

Date: _____ Miles (Km): _____		Invoice number: _____		Comments/miscellaneous	
Type of operation:		Stamp			
Service <input type="checkbox"/>					
..... <input type="checkbox"/>					
Anti-corrosion check:					
OK <input type="checkbox"/> Not OK* <input type="checkbox"/>					
*See specific page					

Date: _____ Miles (Km): _____		Invoice number: _____		Comments/miscellaneous	
Type of operation:		Stamp			
Service <input type="checkbox"/>					
..... <input type="checkbox"/>					
Anti-corrosion check:					
OK <input type="checkbox"/> Not OK* <input type="checkbox"/>					
*See specific page					

ANTICORROSION CHECK (1/5)

If the continuation of the warranty is subject to repair, it is indicated below.

VIN:

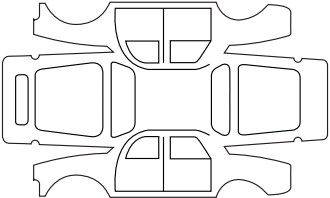
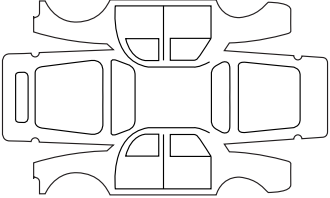
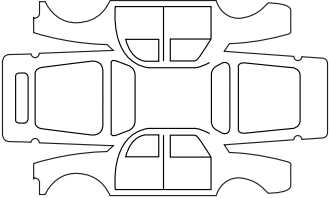
Corrosion repair operation to be carried out:		Stamp
Date of repair:		
Repair to be carried out:		Stamp
Date of repair:		
Repair to be carried out:		Stamp
Date of repair:		

ANTICORROSION CHECK (2/5)

If the continuation of the warranty is subject to repair, it is indicated below.

VIN:

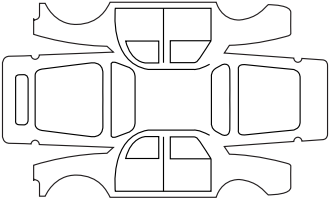
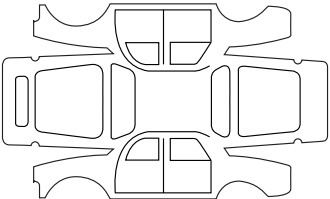
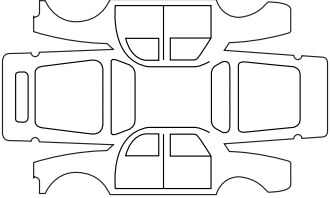
Corrosion repair operation to be carried out:		
Corrosion repair operation to be carried out:		Stamp
Date of repair:		
Repair to be carried out:		
Repair to be carried out:		Stamp
Date of repair:		
Repair to be carried out:		
Repair to be carried out:		Stamp
Date of repair:		

ANTICORROSION CHECK (3/5)

If the continuation of the warranty is subject to repair, it is indicated below.

VIN:

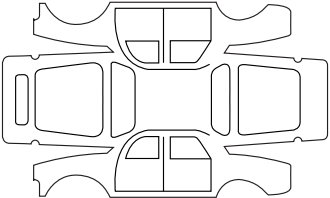
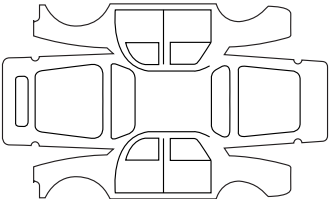
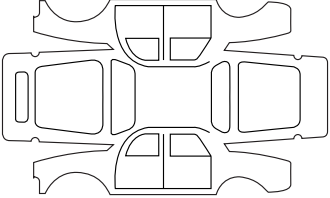
Corrosion repair operation to be carried out:		
Corrosion repair operation to be carried out:		Stamp
Date of repair:		
Repair to be carried out:		
Repair to be carried out:		Stamp
Date of repair:		
Repair to be carried out:		
Repair to be carried out:		Stamp
Date of repair:		

ANTICORROSION CHECK (4/5)

If the continuation of the warranty is subject to repair, it is indicated below.

VIN:

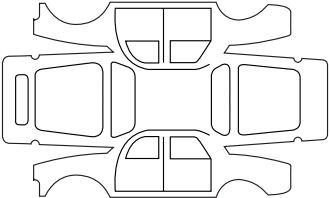
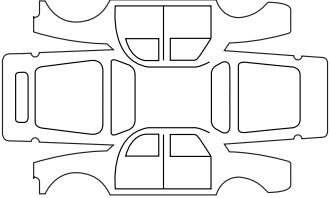
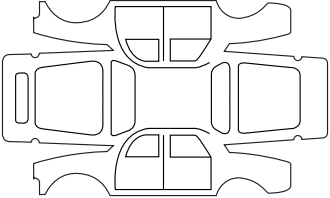
Corrosion repair operation to be carried out:		
Corrosion repair operation to be carried out:		Stamp
Date of repair:		
Repair to be carried out:		
Repair to be carried out:		Stamp
Date of repair:		
Repair to be carried out:		
Repair to be carried out:		Stamp
Date of repair:		

ANTICORROSION CHECK (5/5)

If the continuation of the warranty is subject to repair, it is indicated below.

VIN:

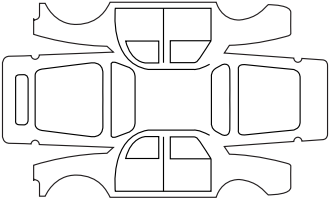
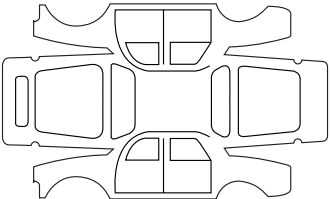
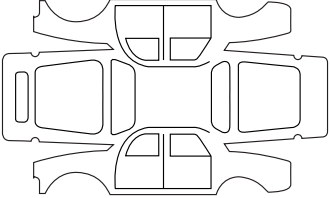
Corrosion repair operation to be carried out:		Stamp
Date of repair:		
Repair to be carried out:		Stamp
Date of repair:		
Repair to be carried out:		Stamp
Date of repair:		

ALPHABETICAL INDEX (1/4)

A

ABS	2.21 → 2.24
accessories	5.26
accessories socket	3.24
additional methods of restraint	1.23 → 1.26, 1.29
side protection	1.28
to the rear seat belts	1.27
advice on antipollution	2.14 → 2.16
air bag	1.23 → 1.29
activating the front passenger air bags	1.42
deactivating the front passenger air bags	1.40
air conditioning	3.6 → 3.12
air vents	3.2 – 3.3
anti-corrosion check	6.15 → 6.19
anti-corrosion protection	4.13 – 4.14
antipollution	
advice	2.14
armrest:	
front	3.21
rear	3.22
ashtray	3.24
ASR (traction control)	2.21 → 2.24
automatic gearbox (use)	2.37 → 2.39
automatic gearbox selector lever	2.37 → 2.39

B

battery	4.11
troubleshooting	5.23 – 5.24
bonnet	4.2
bulbs	
changing	5.13 → 5.17

C

catalytic converter	2.7
central door locking	1.8, 1.12 – 1.13
changing a bulb	5.12, 5.15 → 5.17

changing a wheel	5.7 – 5.8
changing gear	2.37 → 2.39
child restraint/seat	1.30 → 1.39
child safety	1.10, 1.30 → 1.39
child seats	1.30 → 1.39
cigar lighter	3.24
clock	1.63
controls	1.44 → 1.47
coolant	1.52
courtesy light	3.17 → 3.19, 5.18 → 5.20
courtesy mirrors	3.16
cruise control	2.25 → 2.32
cruise control-speed limiter	2.25 → 2.32
customising the vehicle settings	1.62

D

dashboard	1.46 – 1.47
deadlocking the doors	1.8
dimensions	6.5
display	1.48 → 1.52
doors	1.8 → 1.10
driver's position	1.46 – 1.47
driving	2.2 → 2.6, 2.14 → 2.16, 2.18 → 2.32, 2.37 → 2.39
driving position	
settings	1.20

E

electric windows	3.13 → 3.15
electronic parking brake	2.10 → 2.13
emergency brake assist	2.21 → 2.24
emergency braking	2.21 → 2.24
emergency key	1.3
emergency spare wheel	5.2, 5.6
engine	
technical specifications	6.6
engine oil	4.3

ALPHABETICAL INDEX (2/4)

engine oil level.....	4.3 – 4.4
engine start/stop button.....	2.3 → 2.6
external temperature.....	1.63

F

faults	
operating faults.....	5.30 → 5.34
filter.....	4.10
fog lights.....	5.14
fragrance diffuser.....	3.4
front lights	
changing bulbs.....	5.12 – 5.13
front passenger air bag deactivation.....	1.40
front seat	
driver's position memory.....	1.17
front seat adjustment.....	1.15 – 1.16
electric controls.....	1.15
manual controls.....	1.15
fuel	
advice on fuel economy.....	2.14
grade.....	1.74 – 1.75
fuel economy.....	2.14 → 2.16
fuel filler cap.....	1.74
fuel level.....	1.52
fuel tank capacity.....	1.74 – 1.75
fuses.....	5.21 – 5.22

H

handbrake.....	2.9
hands-free telephone integrated control.....	3.29
hazard warning lights signal.....	1.66
headlight flashers.....	1.66
headrest.....	1.14, 3.25
heating and air conditioning system.....	3.12
heating system.....	3.6 → 3.11
horn.....	1.66

hubcap tool.....	5.6
------------------	-----

I

indicator lights.....	1.66
instrument panel.....	1.44 – 1.45, 1.48 → 1.61
instrument panel messages.....	1.55 → 1.61
interior trim	
maintenance.....	4.15 – 4.16
ionizer.....	3.5

J

jack.....	5.6
-----------	-----

L

levels:	
brake fluid.....	4.9
coolant.....	4.8
windscreen washer reservoir.....	4.10
lighting:	
exterior.....	1.67 → 1.69
instrument panel.....	1.67
interior.....	3.17 → 3.19, 5.18 → 5.20
lights:	
brake lights.....	5.15 – 5.16
dipped beam headlights.....	1.67
direction indicators.....	5.15, 5.17
fog lights.....	1.69, 5.16
main beam headlights.....	1.68
number plate lights.....	5.17
reversing lights.....	5.16
side lights.....	1.67
lights-on warning buzzer.....	1.69
locking the doors.....	1.2 → 1.8, 1.11 – 1.12

ALPHABETICAL INDEX (3/4)

M

maintenance:	
bodywork	4.13 – 4.14
mechanical.....	6.9 → 6.14
mileage before service.....	6.9 → 6.14
map reading lights	3.17 → 3.19
massage seat	1.19
menu for customising the vehicle settings.....	1.62
methods of restraint in addition to the seat belts.....	1.27
multimedia equipment	3.29

N

navigation	3.29
navigation system.....	3.29

O

opening the doors.....	1.9 – 1.10
operating faults.....	5.30 → 5.34

P

paintwork	
maintenance	4.13 – 4.14
parking distance control.....	2.33 → 2.35
power-assisted steering.....	1.43
puncture.....	5.2, 5.6 → 5.8

R

radio.....	3.29
rear bench seat.....	3.26
rear screen de-icing/demisting	3.10
rear seats	
functions	3.26
rear view mirrors.....	1.64 – 1.65
RENAULT card	
battery.....	5.25
use.....	1.4 → 1.8

RENAULT card battery	5.25
replacement parts.....	6.8
roof bars	3.30
running in.....	2.2

S

screen wash/wipe	1.71 → 1.73
seat belt pretensioners	1.23 → 1.26
seat belts	1.20 → 1.26
see-me-home lighting	1.69
service sheets.....	6.9 → 6.14
side indicator lights	
changing bulbs.....	5.17
side protection devices	1.28
signals and lights	1.67 → 1.69
special features of diesel versions.....	2.8
special features of petrol vehicles	2.7
speed limiter	2.25 → 2.27
starting the engine	2.3 → 2.6
steering wheel	
adjustment	1.43
stopping the engine.....	2.6
storage compartment.....	3.23, 3.28
sun blinds	3.16
sun visor	3.16
sunroof.....	3.13 → 3.15

T

tailgate	3.28
tanks and reservoirs	
brake fluid	4.9
coolant	4.8
tanks and reservoirs:	
windscreen washer	4.10
technical specifications.....	6.2 → 6.5, 6.7 – 6.8
telephone.....	3.29

ALPHABETICAL INDEX (4/4)

temperature regulation	3.6 → 3.11
tool kit	5.6
towing	
breakdown	5.28 – 5.29
towing a caravan	6.7
towing rings	5.29
towing weights	6.7
transporting children	1.30 → 1.39
transporting objects	
in the luggage compartment	3.30
trip computer and warning system	1.53 → 1.61
tyre inflation kit	5.3 → 5.5
tyre pressure monitor	2.18 → 2.20
tyre pressures	2.18 → 2.20, 4.12, 5.10
tyres	2.18 → 2.20, 5.9 → 5.11

U

unlocking the doors	1.2 → 1.7, 1.11 – 1.12
---------------------------	------------------------

V

vehicle identification plates	6.2 → 6.4
ventilation	3.6 → 3.11

W

warning buzzer	1.9
warning lights	1.48 → 1.51, 1.53 → 1.61
washing	4.13 – 4.14
weights	6.7
wheel trim	5.6
wheelbrace	5.6
wheels (safety)	5.9 → 5.11
windscreen de-icing/demisting	3.10
wiper blades	5.27

X

xenon headlight	1.70
-----------------------	------

(www.e-guide.renault.com)

RENAULT S.A.S. SOCIÉTÉ PAR ACTIONS SIMPLIFIÉE AU CAPITAL DE 533 941 113 € / 13-15, QUAI LE GALLO
92100 BOULOGNE-BILLANCOURT R.C.S. NANTERRE 780 129 987 — SIRET 780 129 987 03591 / TÉL. : 0810 40 50 60

NU 949-3 – 99 91 097 09R – 01/2012 – Edition anglaise



9 9 9 1 0 9 7 0 9 R

DS