


## How you can contribute to a cleaner environment

The fuel consumption of your Škoda - and thus the level of pollutants contained in the exhaust - is also determined by how you drive.

The noise level and wear and tear are also influenced by how you personally handle your vehicle.

This Owner's Manual tells you how to drive your Škoda to achieve the minimum impact on the environment, and how to save money at the same time. Look up „Environment“ in the Index to find out more.

Please also refer to all the texts identified with a  in this Owner's Manual.

## Make your contribution - for the sake of the environment.

[www.skoda-auto.com](http://www.skoda-auto.com)

Návod k obsluze  
Rapid anglicky 09.11  
S55.5613.01.91  
5J5 012 003

SIMPLY CLEVER

ŠKODA



**ŠKODA Rapid**  
OWNER'S MANUAL

## Thank you for your trust

What this Škoda offers you is a car featuring the most modern engineering and a wide range of convenience equipment which you will undoubtedly wish to use to the full in your daily motoring.

**Before the first use, please read and follow the information in this Owner's Manual so that you become familiar with the vehicle quickly and comprehensively and are able to recognize and avoid possible dangers to yourself and others.**

If you have questions about your vehicle, or if you think that the instructions are not complete, please contact your Škoda partner. He will be ready at any time to receive your questions, suggestions and criticisms.

We hope you enjoy using your vehicle and wish you pleasant motoring.

**Your Škoda auto**

## Table of Contents

<b>About this Owner's Manual</b> .....	3	Airbag system .....	60	Engine coolant .....	140
		Child seats (accessories) .....	66	Vehicle battery .....	144
<b>Abbreviations</b> .....	4	<b>Lights and visibility</b> .....	71	<b>Care and maintenance of the vehicle</b> .....	148
		Lights .....	71	Maintaining and cleaning the vehicle exterior .....	148
		Sun screen .....	76	Maintaining and cleaning the interior .....	156
		Windscreen wipers and washers .....	77	Wheels and tyres .....	160
		Mirrors .....	79	Accessories, replacement of parts, repairs and Modifications .....	172
<b>Vehicle overview</b> .....	6	<b>Transporting</b> .....	81	Consumer information .....	179
Exterior views .....	6	Driving tips .....	81	Engine control and emission control system .....	181
Side view .....	6	<b>Useful equipment</b> .....	85		
Front view .....	7	Storage facilities .....	85	<b>Do-it-yourself</b> .....	183
Rear view .....	8	Cup holders .....	89	<b>Practical information</b> .....	183
Vehicle interior .....	10	Ashtrays and cigarette lighter .....	91	Questions and answers .....	183
Overview of the driver's door .....	10	Power socket .....	92	In an emergency .....	185
Overview of the driver's side .....	12	<b>When driving</b> .....	94	Emergency closing or opening .....	187
Overview of centre console .....	14	Starting, shifting gears, parking .....	94	Tool kit .....	190
Overview of the passenger side .....	16	Starting and stopping the engine .....	94	Wheel trims .....	192
Instrument cluster .....	17	Shifting gears .....	98	Wheel change .....	194
Warning and indicator lights .....	17	Braking, stopping and parking .....	104	Fuses .....	200
Instruments .....	19	Driving in an environmentally conscious manner .....	112	Changing a bulb .....	203
Skoda information system .....	23	Steering .....	115	Jump starting .....	209
		<b>Air conditioning</b> .....	117	Tow-starting and towing .....	212
<b>Before driving</b> .....	26	Air conditioning system .....	117		
Before you start .....	26	<b>At the petrol station</b> .....	123	<b>Index</b> .....	216
Driving tips .....	26	Refuelling .....	123		
Technical data .....	29	Fuel .....	127		
<b>Opening and closing</b> .....	32	<b>Maintenance, cleaning, servicing</b> ...	131		
Vehicle key set .....	32	In the engine compartment .....	131		
Central locking and closing system .....	35	Preparing to work in the engine compartment .....	131		
Doors .....	38	Engine oil .....	136		
Boot lid .....	40				
Power windows .....	42				
<b>Sitting properly and safely</b> .....	44				
Adjusting the seat position .....	44				
Seat features .....	51				
Seat belts .....	52				

## About this Owner's Manual

- For an alphabetical [index](#), see the end of the manual.
- A [list of acronyms and abbreviations](#) explains technical abbreviations and terms at the end of the manual.
- [Directions](#) such as left, right, front, rear generally refer to the direction of travel, unless otherwise indicated.
- [Illustrations](#) are intended for orientation and shall be understood as schematic diagrams.
- Technical changes to the vehicle that have arisen after the time of publication are explained in an [addendum](#) to the Owner's Manual.

All items of equipment and models are described without being labelled as optional equipment and model variants. Therefore, items of equipment may be described that your vehicle may not have or that are only available in some markets. For your vehicle equipment, please see the sales documentation and for further information about it, please contact your Škoda partner.

All information in this Owner's Manual corresponds to the information at the time of publication. Due to ongoing development of the vehicle, there may be deviations between the vehicle and the information in this Owner's Manual. It is therefore not possible for legal claims to be made based on different data, illustrations and descriptions contained in this Owner's Manual.

Should you sell or lend the vehicle, make sure that the complete Owner's Manual is always in the vehicle.

### Integral parts of the Owner's Manual:

- Service schedule
- Owner's Manual

### Additional parts of the Owner's Manual:

- Addendum
- Radio
- Mobile phone preparation
- *Other attachments*

Vehicle overview

Before driving

When driving

Maintenance, cleaning, servicing

Do-it-yourself

## Abbreviations

Abbreviation	Meaning
rpm	Engine revolutions per minute (engine speed).
ABS	Anti-lock brake system.
AG6	6-speed automatic gearbox.
ccm	Cubic centimetres. Unit for stating the displacement.
CO <sub>2</sub>	Carbon dioxide.
DIN	Deutsches Institut für Normung (German Institute for Standardization).
EN	European Standard.
EPC	Engine control unit (Electronic Power Control).
ETC	Electronic Toll Collection System.
g/km	Carbon dioxide output in grams per kilometre.
kW	Kilowatt, engine power rating.
LED	Light Emitting Diode.
MFA	Multi-function display (German abbreviation)
MKB	Engine code letter (German abbreviation).
Nm	Newton metres, unit for specifying engine torque.
BHP	Brake horse power, (obsolete) engine power rating.
RON	Research Octane Number, unit for specifying the knock resistance of petrol fuel.
SG5	5-speed manual gearbox.
TDI®	Diesel engine with direct injection and turbocharging (Turbocharged Direct or Diesel Injection).

Vehicle overview

Before driving

When driving

Maintenance, cleaning, servicing

Do-it-yourself

## Vehicle overview

### Exterior views

#### Side view

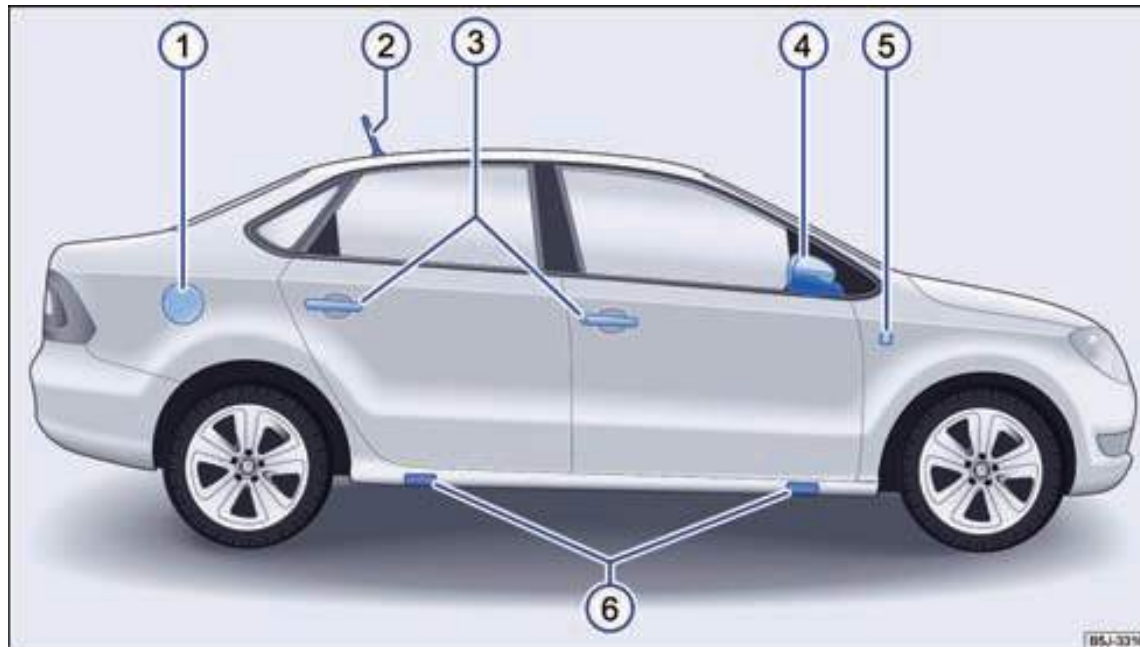


Fig. 1 Overview of the vehicle side.

Legend to fig. 1:

① Fuel filler flap .....	123
② Roof aerial .....	179
③ Door opening lever .....	38
④ Exterior mirrors .....	79
⑤ Additional turn signal light .....	71
⑥ Jacking points for positioning the car jack .....	194 ■



## Front view

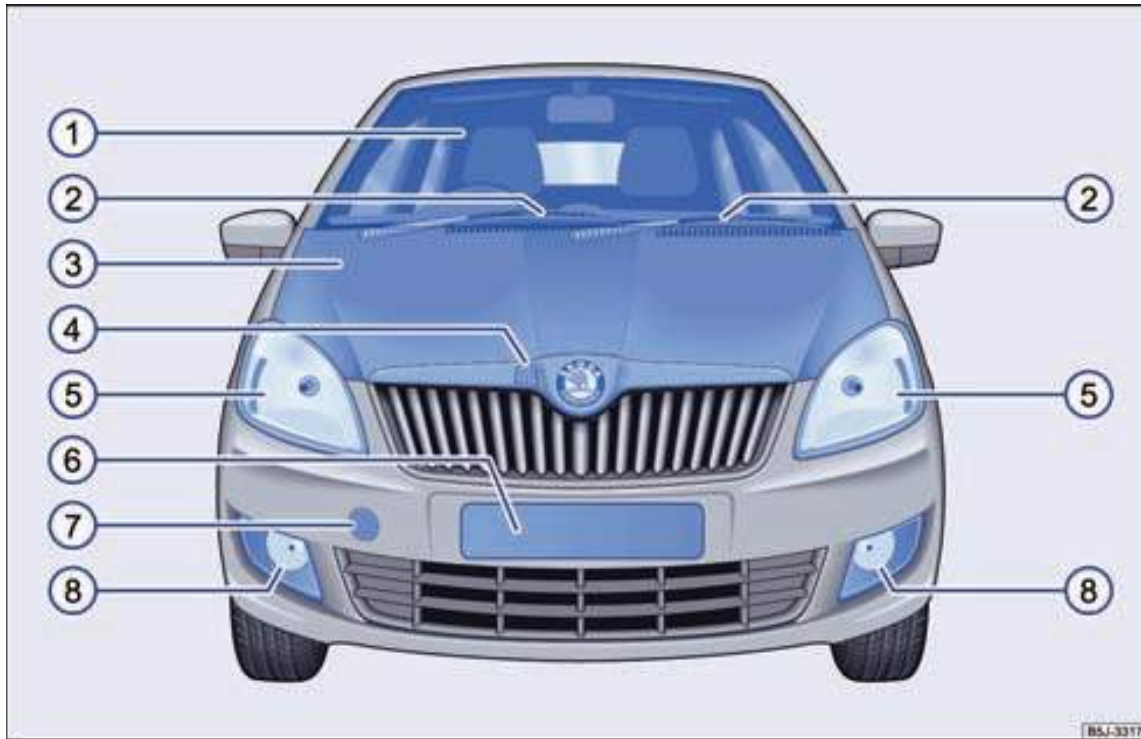


Fig. 2 Overview of the vehicle front.

Legend to fig. 2:

①	Windscreen	
②	Front windscreen wiper .....	77
③	Bonnet .....	131
④	Release lever for the bonnet .....	131
⑤	Headlight with integrated turn signal light .....	71, 203
⑥	Front licence plate holder	
⑦	Mount of the front towing eye behind a cover .....	212
⑧	Fog lights .....	71 ■

Vehicle overview

Before driving

When driving

Maintenance, cleaning, servicing

Do-it-yourself

## Rear view



Fig. 3 Overview of the vehicle rear.

Legend to fig. 3:

①	Roof aerial .....	179
②	Rear window	
③	High-mounted brake light	
④	Licence plate lighting .....	203
⑤	Tail lights .....	71, 203
⑥	Rear licence plate holder	
⑦	Lock cylinder to open the boot lid .....	40
⑧	Rear towing eye .....	212 ■

Vehicle overview

Before driving

When driving

Maintenance, cleaning, servicing

Do-it-yourself

## Vehicle interior

### Overview of the driver's door

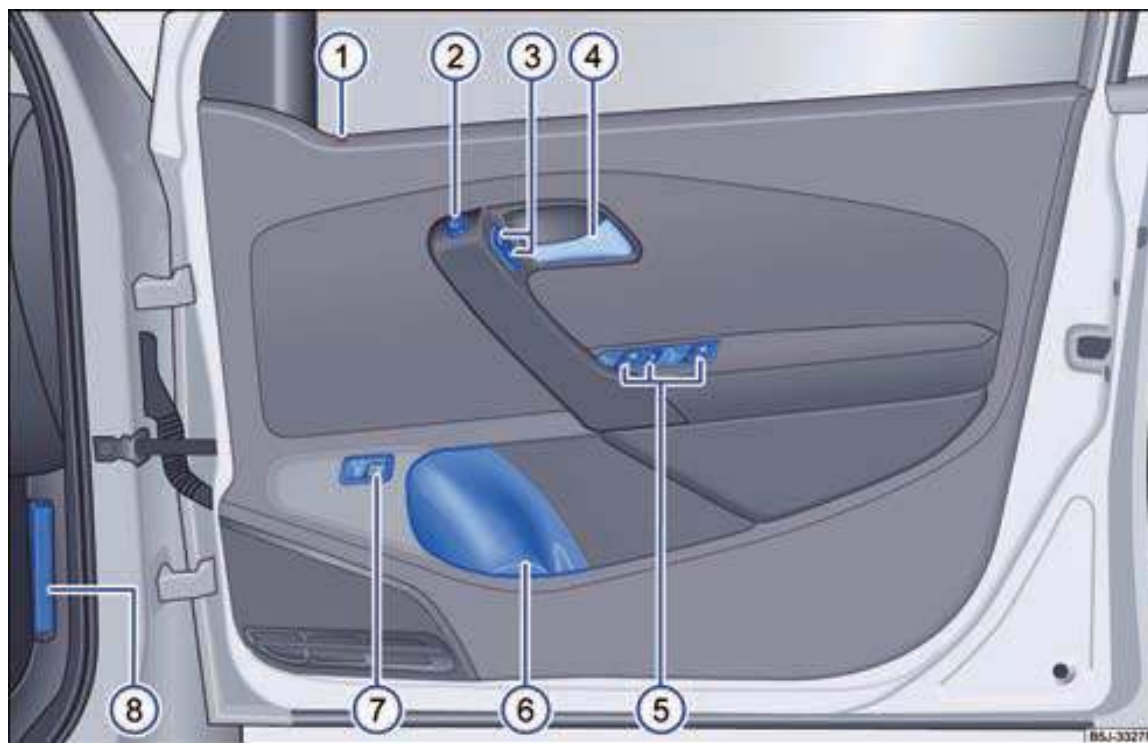


Fig. 4 Overview of the control elements in the driver's door.

Legend to fig. 4:

① Warning light for central locking system .....	35
② Switch for adjusting the exterior mirrors L - 0 - R: .....	79
③ Central locking button for locking and unlocking the vehicle  -  ..	35
④ Door opening lever .....	38

⑤ Buttons for operating the power windows: .....	42
- Power windows	
- Security button for the rear power windows	
⑥ Beverage bottle holder .....	85
⑦ Button to unlock the boot lid .....	40
⑧ Handle to release the bonnet .....	131 ■



## Overview of the driver's side

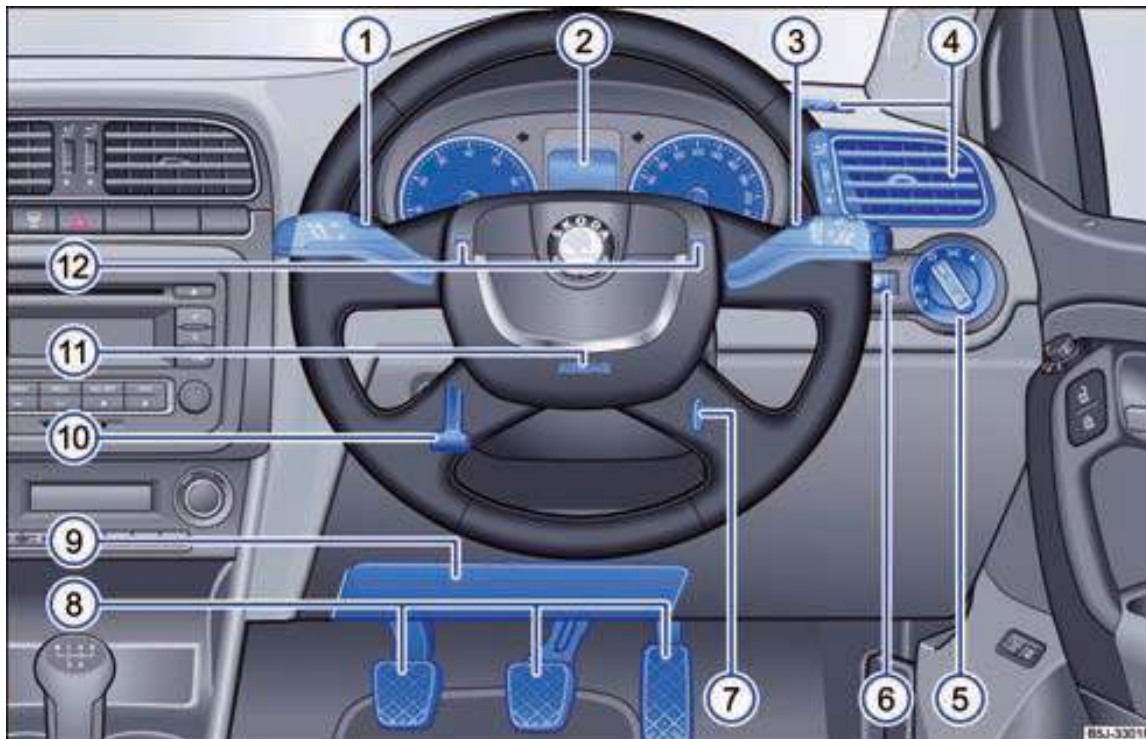


Fig. 5 Overview of the driver's side.









Legend to fig. 5:

- ① Lever for: .....
  - Main beam  $\Rightarrow$
  - Headlight flasher  $\Rightarrow$

71

- Turn signal lights  $\leftrightarrow$
- Parking light  $\Leftarrow$
- ② Instrument cluster:
  - Instruments ..... 19
  - Display ..... 19
  - Warning and indicator lights ..... 17
- ③ Lever for windscreen wipers and washers: ..... 77
  - Windscreen wipers **HIGH, LOW**
  - "Flick wipe"  $\times$
  - Windscreen wipers  $\nabla$



- Automatic wash-wipe for the windscreen 
- Rocker button to operate the multi-function display **TRIP, OK/RESET** . 23
- ④ Air outlet **0**,  ..... 117
- ⑤ Light switch : ..... 71
  - Light off **0**
  - Parking lights and low beam lights , 
  - Fog lights , 
- ⑥ Headlamp beam adjustment  ..... 71
- ⑦ Ignition lock ..... 94
- ⑧ Pedals ..... 98
- ⑨ Fuse box cover ..... 200
- ⑩ Lever for the adjustable steering column ..... 44
- ⑪ Driver's front airbag ..... 60
- ⑫ Horn (works only with the ignition on) ■



## Overview of centre console

### Top part of the centre console



Fig. 6 Overview of the top part of the centre console.

Legend to fig. 6:

①	Air outlet 0, 	117
②	Button for:	
	– Rear window heater .....	117
	– Button for switching the hazard warning light system on and off  .....	185
③	Radio (factory installed) ⇒ Booklet Radio.	
④	Control elements for:	
	– Manual air conditioning and heating .....	117
	– Climatronic and heating .....	117 ■



**Bottom part of the centre console**

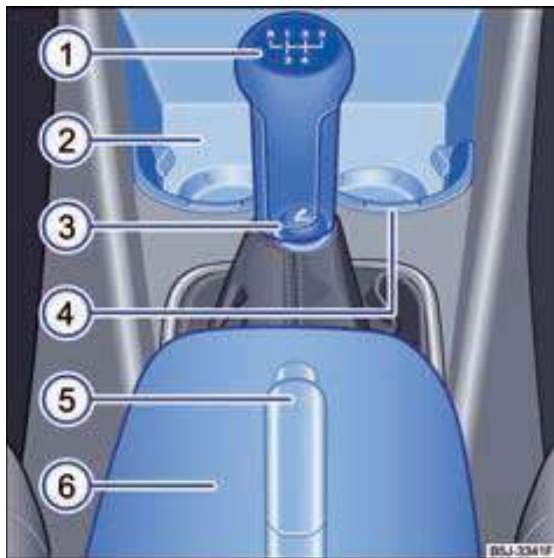


Fig. 7 Overview of the bottom part of the centre console.

Legend to fig. 7:

① Lever for:	
– Manual gearbox .....	98
– Automatic gearbox .....	98
② Stowage compartment in front centre console .....	85
③ Cigarette lighter, 12-volt power socket .....	92
④ Cup holder .....	89
⑤ Handbrake lever .....	104
⑥ Stowage compartment in centre armrest .....	85 ■

## Overview of the passenger side

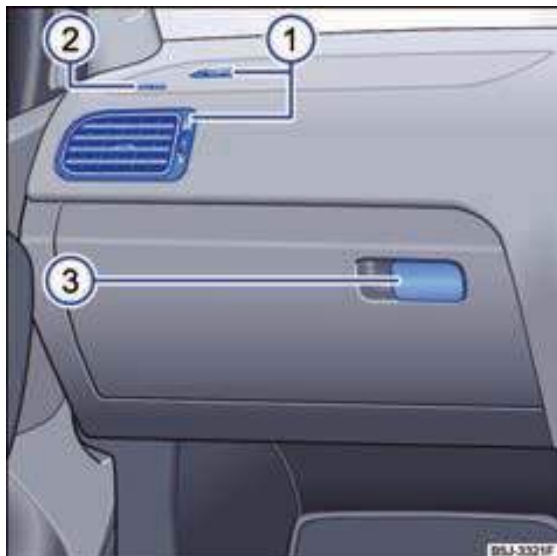




Fig. 8 Overview of the passenger side.

Legend to fig. 8:

① Air outlet 0, 2	117
② Installation position of the front passenger airbag in the instrument panel	60
③ Opening lever for the storage compartment	85 ■

## Instrument cluster











### Warning and indicator lights











The warning and indicator lights indicate warnings ⇒ , problems ⇒  or certain functions. Some warning and indicator lights illuminate when you switch on the ignition and should go out with the engine running or while driving.

Depending on the model, text messages may also be shown in the instrument cluster display that give more information or request any actions ⇒ page 19, Instruments.

Depending on the vehicle equipment, instead of a warning light a symbolic representation may be shown on the instrument cluster display.

Some warning and indicator lights are accompanied by acoustic signals.

Symbol	Meaning ⇒ 	See
	Handbrake applied	⇒ page 104
	<b>Do not drive the vehicle!</b> Brake fluid level is too low or brake system is disturbed.	⇒ page 104
	<b>Do not drive the vehicle!</b> illuminates: Engine coolant temperature too high or flashes: Engine coolant system is disturbed.	⇒ page 140
	<b>Do not drive the vehicle!</b> Engine oil pressure is too low.	⇒ page 136
	<b>Do not drive the vehicle!</b> At least one vehicle door is open or not closed properly.	⇒ page 38
	Alternator is disturbed.	⇒ page 144
	ABS is disturbed or failed.	⇒ page 104
	Rear fog light switched on.	⇒ page 71
	illuminates: Driving lights failed partially or completely.	⇒ page 203

Symbol	Meaning ⇒ 	See
	Engine control or emission control system disturbed.	⇒ page 181
	illuminates: Heating glow plugs of diesel engine or flashes: Engine control disturbed.	
<b>EPC</b>	Engine control disturbed.	
	Steering disturbed.	⇒ page 115
	Fuel tank nearly empty.	⇒ page 123
	Airbag system disturbed.	⇒ page 60
	Front passenger airbag turned off.	⇒ page 60
	Turn signal light left or right.	⇒ page 71
	Warning light system switched on.	⇒ page 185
	illuminates: Depress brake pedal! or flashes: The lock button in the selector lever is not engaged.	Change gear ⇒ page 98 Brake, stop and park ⇒ page 104
	Main beam switched on or headlight flasher operated.	⇒ page 71

#### WARNING

Ignoring illuminated warning lights and text messages may result in breaking down in traffic, accidents and serious injury.

- Never ignore illuminated warning lights and text messages.
- Stop the vehicle as soon as it is possible and safe to do so.

 **WARNING (Continued)**

- Park the vehicle in a safe distance from moving traffic such that no parts of the exhaust system come in contact with highly flammable materials under the vehicle such as dry grass, fuel.
- A broken-down vehicle is a high accident risk to itself and other road users. If necessary, turn on the hazard warning light system and place the warning triangle on the side of the road to warn other road users.
- Before opening the engine compartment lid, switch off the engine and let it cool down sufficiently.
- The engine compartment of every vehicle is a dangerous area and may cause serious injury ⇒ page 131.

 **NOTICE**

Ignoring illuminated indicator lights and text messages may lead to vehicle damage.

## Instruments

### Introduction

This chapter contains information on the following subjects:

Overview of the instruments .....	19
Displays .....	20
Service interval display .....	21

At low outside temperatures, the display on the instrument cluster may be slightly more time-delayed than at warm outside temperatures.

### Overview of the instruments

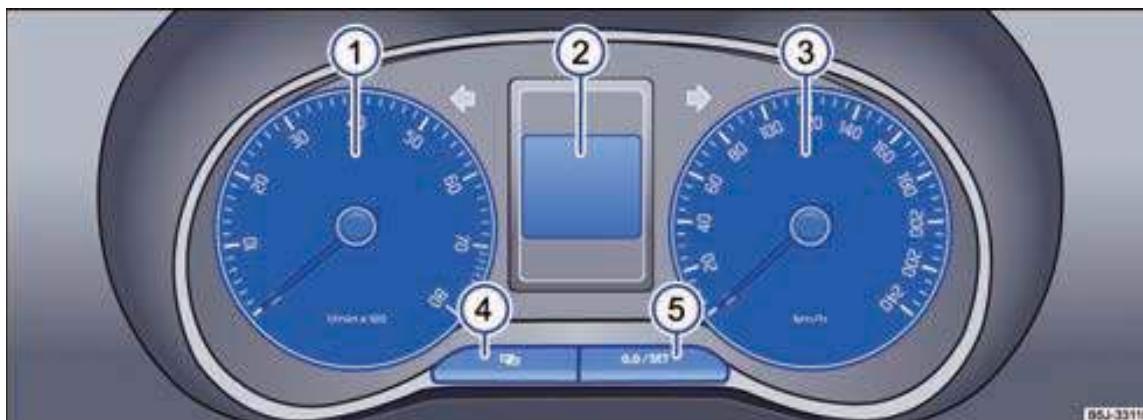


Fig. 9 Instrument cluster on the instrument panel.

First read and observe the introductory information and safety warnings  on page 19.

#### Additional information and warnings:



- Warning and indicator lights ⇒ page 17
- Display of the gears engaged (automatic gearbox) ⇒ page 98
- Information on service intervals ⇒ Booklet Service schedule





#### WARNING

Driver inattention can lead to accidents and injuries.

- Never press the buttons in the instrument cluster to operate while driving.

Explanation of the instruments ⇒ fig. 9:

- ① **Revolutions counter** (revolutions x 1000 per minute of the running engine). The start of the red zone in the revolutions counter indicates the maximum permissible engine speed for all gears for an engine which has been run in and is operating at normal temperature. Before reaching the red zone, shift up to the next higher gear, select the selector lever position **D**, or take your foot off the accelerator pedal ⇒ .
- ② **Displays** ⇒ page 20. 

- ③ **Speedometer.**
- ④ **Adjust button for the clock.**
  - Press the button  to select the hour or minute display.
  - To advance the setting, press the  button ⑤. Press and hold to fast forward.
  - Press the  button again to complete setting the clock.
- ⑤ **Reset button** for the display of the daily trip counter (**trip**).
  - Press the  button to set to zero.

### ! NOTICE

To prevent engine damage, the pointer of the revolutions counter may enter the red zone of the scale only for a short time.

## Displays

 **First read and observe the introductory information and safety warnings  on page 19.**

The display of the instrument cluster  $\Rightarrow$  fig. 9 ② may show various information, depending on the vehicle equipment:

- Warning and information texts.
- Mileage (kilometre) indicators.
- Time.
- Outside temperature.

### For the sake of the environment

Shifting to a higher gear as early as possible are ways to minimise fuel consumption and to reduce operating noise levels.




### Note

The fuel gauge is located in the lower section of the displays ②. ■

- Selector lever positions  $\Rightarrow$  page 98.
- Multi-function display (MFD)  $\Rightarrow$  page 23.
- Service interval display  $\Rightarrow$  page 21.

### Warning and information texts

When switching on the ignition or while driving, some functions in the vehicle and vehicle components are checked for their condition. Malfunctions are indicated by red and yellow warning symbols with text messages on the instrument cluster display ( $\Rightarrow$  page 17) and may also be signalled acoustically. The presentation may vary depending on the design of the instrument cluster.


Notification	Symbol colour	Explanation
Priority 1 warning message.	red	Symbol flashes or lights – some with warning signals.  <b>Do not drive the vehicle!</b> There is a danger $\Rightarrow$  ! Check impaired function and eliminate the cause. Get professional assistance, if necessary.
Priority 2 warning message.	yellow	Symbol flashes or lights – some with warning signals. Malfunctions or lack of fluids may cause vehicle damage and failure of the vehicle! $\Rightarrow$  ! Check impaired function as soon as possible. Get professional assistance, if necessary.
Informational text.	–	Information on various operations on the vehicle.

### Mileage (kilometre) indicators

The *odometer* registers the total distance travelled of the vehicle.

The *trip counter (trip)* shows the miles (kilometres), which were driven after the last reset of the trip counter. The last digit indicates 1/10 miles (100 metres). ►

### Outside temperature display

At outside temperatures colder than +39 °F (+4 °C), a "snow flake symbol" (black ice warning) also appears on the outside temperature display. This symbol flashes initially and then stays lit until the outside temperature increases above +43 °F (+6 °C) ⇒ .

If the vehicle is stationary (or driven at a very low speed), the temperature indicated may be slightly higher than the actual outside temperature because of heat radiated by the engine.

The measurement range is from -40 °F (-40 °C) to +122 °F (+50 °C).

### Selector lever positions

The set selector lever position is shown both at the side of the selector lever and on the display on the instrument cluster. In the positions **D** and **S** and in Tiptronic, the display may show the current gear.

#### WARNING

Ignoring illuminated warning lights and text messages may result in breaking down in traffic, accidents and serious injury.

- Never ignore illuminated warning lights and text messages.
- Stop the vehicle as soon as it is possible and safe to do so.
- A broken-down vehicle is a high accident risk to itself and other road users. If necessary, turn on the hazard warning light system and place the warning triangle on the side of the road to warn other road users.
- Park the vehicle in a safe distance from moving traffic such that no parts of the exhaust system come in contact with highly flammable materials under the vehicle such as dry grass, fuel.

#### WARNING

Roads and bridges may be icy at temperatures above freezing.

- Ice may be present at temperatures above +39 °F (+4 °C), even if no "ice crystal symbol" is displayed as a warning of black ice.
- Never rely only on the outside temperature display!

#### NOTICE

Ignoring illuminated indicator lights and text messages may lead to vehicle damage.

#### Note

There are different instrument clusters, so the designs and displays may vary. On the display without warning or information texts, problems are shown only via indicator lights.

#### Note

If there are more than one warning, the symbols appear one after the other for a few seconds. The symbols continue to appear until the cause is eliminated. ■

### Service interval display



**First read and observe the introductory information and safety warnings  on page 19.**


The service event is shown in the instrument cluster display ⇒ [fig. 9 ②](#).

Service appointments at Škoda are distinguished between events *with* engine oil change, such as interval service, and events *without* engine oil change, such as inspection service. The service interval display only tells you the service appointments, which include an engine oil change. All other service appointments, such as the next due inspection service or brake fluid change are indicated on the sticker on the door frame of the vehicle or in the service schedule.

For vehicles with **time- or mileage-dependent service**, fixed service intervals are specified.


#### Service reminder

If a service is due soon, a **service reminder** appears when switching on the ignition.

On *vehicles without text messages* in the instrument cluster display, a wrench symbol , and a **miles** display appear. The stated mileage is the maximum number of miles that can be driven until the service appointment is due. The display will change after a few seconds. A clock symbol and the number of days until the due service appointment will appear.



On *vehicles with text messages* (MAXIDOT) in the instrument cluster display, **Service in --- miles or --- days** will appear.

#### Service event

When a **service is due**, an acoustic signal sounds and the flashing wrench symbol  appears for a few seconds when you switch on the ignition. On *vehicles with text messages* in the instrument cluster display, **Service now** will appear. ►

**Retrieving service message**

The current **service message** can be checked with the ignition switched on, the engine switched off and the vehicle stationary:

- Press the  button in the instrument cluster repeatedly until the wrench symbol  appears.

An **overdue service** is indicated by a minus sign in front of the mileage or number-of-days indication. On *vehicles with text messages* in the instrument cluster display, **Service since – miles or – days** will appear.


**Resetting service interval display**

If the service was not carried out by a Škoda partner, the display can be reset as follows:

**On vehicles with text messages (MAXIDOT):**

Select the **Settings** menu.

In the **Service** sub-menu, select the **Reset** menu item.



Acknowledge the confirmation prompt with .

**On vehicles without text messages:**

Switch off the ignition.


Press and hold the  button.

Switch the ignition on again.

Release the  button and press the  button within approx. 20 seconds.

Do **not** reset the service display between service intervals, as this will result in incorrect displays.

** Note**

The service message will extinguish after a few seconds with the engine running or by pressing the  button. ■



## Škoda information system

### Introduction

This chapter contains information on the following subjects:


Overview of the multi-function display (MFD) .....	23
<b>MFD menu (multi-function display)</b> .....	23
Operating the menus in the instrument cluster .....	24

With the ignition switched on, various driving and consumption data from the multi-function display (MFD) can be shown on the display.

The scope of the menus in the instrument cluster display depends on the vehicle electronics and the equipment level of the vehicle.

A specialist garage may program or modify additional functions depending on the vehicle equipment. Škoda recommends a Škoda partner for this purpose.

Some menu items can only be selected when the vehicle is stopped.

The display is located between the two horizontal lines of the display ⇒ [fig. 9](#) .

The multi-function display (MFD) is switched by using the buttons on the wind-screen wiper lever.

### MFD menu (multi-function display)

 **First read and observe the introductory information and safety warnings  on page 23.**

### WARNING

Driver inattention can lead to accidents and injuries.


- Never select any menus in the instrument cluster while driving.

### Overview of the multi-function display (MFD)

 **First read and observe the introductory information and safety warnings  on page 23.**

- Driving time
- Current fuel consumption
- Average fuel consumption
- Range
- Distance travelled
- Average speed
- Digital speedometer
- Speed warning
- Outside temperature

The multi-function display (MFD) is equipped with two automatic memories: **1 - Single-trip memory** and **2 - Total-distance-driven memory**. The number of the memory currently shown appears on the top right of the centre display.

To change between the two memories, press the  button while the ignition is switched on and memory 1 or 2 is displayed.

1	Single-trip memory.	The memory collects driving and fuel consumption data from the time the ignition is switched on until it is switched off. The memory is cleared automatically after the driving time is interrupted for more than two hours. If the drive continues within two hours after the ignition was switched off, the new data will be added.
2	Total-distance-driven memory.	The memory collects the driving data of any number of single drives, depending on the model of the instrument cluster up to a total of 19 hours and 59 minutes or 99 hours and 59 minutes driving time or 1999.9 miles (kilometres) or 9999 miles (km) distance travelled. If any of these maximum values is passed, the memory will automatically clear and start again from 0.

## Possible indications

Menu	Function
Driving time	Driving time in hours (h) and minutes (min) that has elapsed after the ignition has been switched on.
Current fuel consumption	The current fuel consumption is indicated while driving in mpg (l/100 km) or with the engine running and the vehicle stopped in gallons per hour (litres per hour).
Average fuel consumption	The average fuel consumption in mpg (l/100 km) will appear after the ignition is switched on only after a distance of about 328 feet (100 metres). Until then, dashes are displayed. The displayed value is updated approx. every five seconds.
Range	Approximate driving distance in miles (km) that can be driven with the existing fuel amount in the tank using the same driving style. This is calculated based on the current fuel consumption among other factors.
Distance travelled	The distance travelled in miles (km) after the ignition has been switched on.
Average speed	The average speed is displayed after the ignition has been switched on only after a distance of about 328 feet (100 metres). Until then, dashes are displayed. The displayed value is updated approx. every five seconds.
Warning at --- mph	When exceeding a stored speed from approx. 18 mph (30 km/h), an acoustic and possibly a visual warning are issued.
Outside temperature	Display of the current outdoor temperature in °F or °C.

## Operating the menus in the instrument cluster

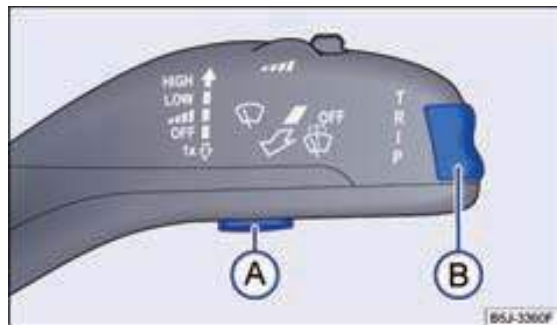


Fig. 10 Button (A) on the windscreen wiper lever to confirm a menu item, and rocker (B) to change the menus.

 First read and observe the introductory information and safety warnings  on page 23.

## Selecting memory 1 or 2

- Switch on the ignition.
- Press the **OK/RESET** button repeatedly → fig. 10 (A) until you see the desired memory.

## Manually clearing memory 1 or 2

- Switch on the ignition.
- Select the memory you wish to clear.
- Press and hold the **OK/RESET** button for approx. two seconds (A).

## Display of driving and fuel consumption data

- Switch on the ignition.
- Select memory.
- Push the rocker up or down repeatedly (B) until the desired value is displayed.

## Storing a speed for the speed warning

- Select speed warning.
- Press the **OK/RESET** button (A) to save the current speed and activate the warning.
- If necessary, within approx. five seconds set the desired speed with the rocker (B). Then press again the **OK/RESET** button or wait a few seconds. The speed is saved and the alarm is activated.
- *To deactivate, press the **OK/RESET** button. The stored speed is deleted.* ▶

**i Note**

When the vehicle is stationary (or driven at a very low speed) the temperature indicated may be slightly higher than the actual outside temperature because of heat radiated by the engine. ■

## Before driving

### Before you start

#### Driving tips

##### Introduction

This chapter contains information on the following subjects:

Driving preparations and driving safety .....	26
Motoring abroad .....	27
Driving through water on roads .....	28

Depending on where the vehicle is used, it may be recommended having an engine undershield installed. An engine undershield can reduce the risk of damage to the vehicle underside and the engine oil pan, for example, when driving over curbs, driveways or on unpaved roads. Škoda recommends a Škoda partner for the installation.

#### Additional information and warnings:



- Sitting properly and safely ⇒ page 44
- Transporting ⇒ page 81
- Starting, shifting gears, parking ⇒ page 94
- Driving in an environmentally conscious manner ⇒ page 112
- Consumer information ⇒ page 179

#### WARNING


**Driving under the influence of alcohol, drugs, medicines, and anaesthetics can cause serious accidents and fatal injuries.**

- Alcohol, drugs, medicines and anaesthetics may affect perception, reaction times and driving safety significantly, resulting in possible loss of control over the vehicle.

### Driving preparations and driving safety

 First read and observe the introductory information and safety warnings  on page 26.

#### Checklist

For your own safety, the safety of all passengers and other road users, the following points must be observed before and during each drive ⇒ :

- ✓ Check the proper function of lighting and turn signal lights.
- ✓ Check tyre pressure ⇒ page 160 and fuel level ⇒ page 123.
- ✓ Provide for clear and good visibility through all windows.
- ✓ Secure objects and luggage in the stowage compartments and in the boot.
- ✓ The pedals must be operable at any time without hindrance.
- ✓ Children in the car must be secured with a restraint system that is suitable for their body weight and body size ⇒ page 66.
- ✓ Adjust the front seat, head restraint and mirrors correctly according to your body height ⇒ page 44.
- ✓ Wear shoes that give your feet good support for the operation of the pedals.
- ✓ The floor mat in the footwell on the driver's side must leave the pedal area free and be securely fastened.
- ✓ Assume a correct seated position before starting to drive and maintain it while driving. This also applies to all passengers ⇒ page 44.

**Checklist (Continued)**

- ✓ Fasten the seat belt properly before driving and leave it on while driving. This also applies to all passengers → page 52.
- ✓ Only carry as many people as there are seats and seat belts.
- ✓ Never drive when your driving ability is impaired, for example, by medication, alcohol or drugs.
- ✓ Never let yourself be distracted from the road, for example, by adjustments and by selecting menus, by passengers or phone calls.
- ✓ Always adjust your speed and driving style to the visibility, weather, road and traffic conditions.
- ✓ Observe traffic rules and specified speeds.
- ✓ Take regular breaks on long trips – at least every two hours.
- ✓ Secure animals in the vehicle with a system that is appropriate for their weight and size.

**⚠ WARNING**

**Always follow the current traffic laws and speed limits and drive proactively. The correct assessment of the driving situation can mean the difference between the safe reach of the destination and an accident with serious injuries.**

**ℹ Note**

Regular service on the vehicle is not only for the maintenance of the vehicle, but also contributes to the operational and road safety. Therefore, have service be carried out in accordance with the requirements of the service schedule. Under difficult operating conditions, some work may become necessary already before the due date of the next service. Difficult conditions are, for example, frequent stop-and-go traffic, driving in areas with heavy dust. For more information, consult your Škoda partner or specialist garage.

**Motoring abroad**

First read and observe the introductory information and safety warnings ⚠ on page 26.

**Checklist**

In some countries there are specific safety standards and emissions-related regulations, which differ from the design of the vehicle. Škoda recommends before a trip abroad, to gather information from a Škoda partner on legal provisions and on the following points in your destination country:

- ✓ Must the vehicle be technically prepared for the trip abroad, such as masking the headlights?
- ✓ Are the necessary tools, diagnostic equipment and spare parts for service and repair available?
- ✓ Is a Škoda partner available in the destination country?
- ✓ For petrol engine models: Is lead-free petrol with sufficient octane available?
- ✓ For diesel engine models: Is low-sulphur diesel fuel available?
- ✓ Are the correct engine oil (→ page 136) and other fluids as specified by Škoda available in the destination country?
- ✓ Are special tyres required for driving in the destination country?

**NOTICE**


Škoda is not responsible for damage to the vehicle arising from poor quality fuel, poor service or lack of original parts availability.

### Driving through water on roads



First read and observe the introductory information and safety warnings  on page 26.

To avoid damage to the vehicle when driving through flooded roads, for example, note the following:

- Determine the depth of the water when driving through bodies of water. The water may **only** be enough to reach the lower edge of the body ⇒ .
- Do not travel faster than walking pace.
- Never stop, reverse or switch off the engine in water.
- Oncoming vehicles generate waves that can raise the water level for your vehicle so much that it is not safe to cross the water.

**WARNING**

After driving through water, mud, sludge, etc. the braking effect may be delayed due to wet and, in winter, icy brake discs and brake pads, extending the stopping distance.

- "Dry and free the brakes from ice" by careful braking actions. In doing so, do not endanger other motorists or ignore statutory provisions.
- Avoid abrupt and sudden braking immediately after water crossings.

**NOTICE**

- When driving through bodies of water, parts of the vehicle such as the engine, gearbox, chassis or electrics can be severely damaged.
- Never drive through salt water, as salt can cause corrosion. Rinse any vehicle parts that have come in contact with salt water immediately with fresh water.

## Technical data

### Introduction

This chapter contains information on the following subjects:

Vehicle identification data .....	29
Engine data .....	30
Dimensions .....	30
Performance .....	31

The engine that a vehicle is equipped with is indicated in the vehicle data sticker in the service schedule or the official registration documents.

The information in the official registration documents always has priority. All information in this Owner's Manual is for the basic model. By optional equipment or different model versions and for special vehicles and vehicles for other countries, the indicated values may differ.

### Additional information and warnings:

- Transporting ⇒ page 81
- Driving in an environmentally conscious manner ⇒ page 112
- Fuel ⇒ page 127
- Engine oil ⇒ page 136
- Engine coolant ⇒ page 140
- Wheels and tires ⇒ page 160
- Consumer information ⇒ page 179

**WARNING**  
 Failure to comply with or exceed the specified values for weight, payload, dimensions and maximum speed may lead to accidents and serious injuries.

### Vehicle identification data

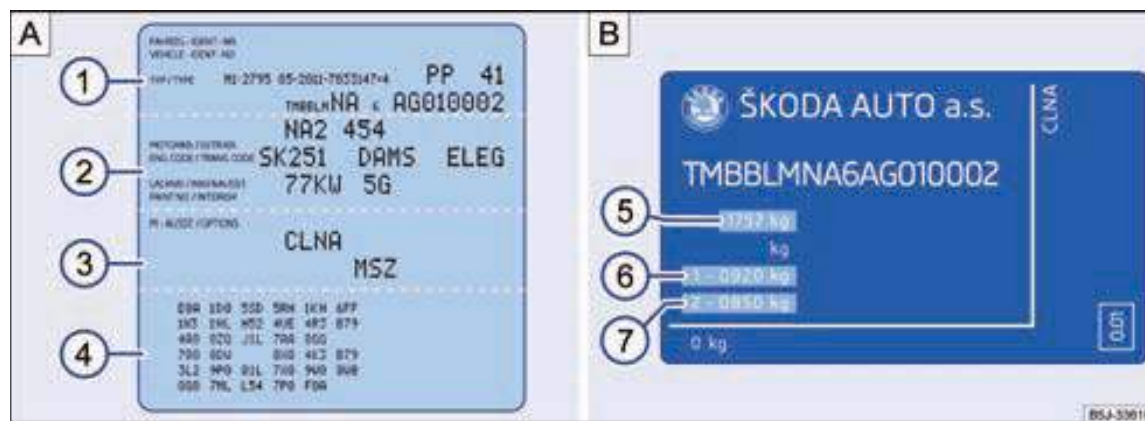



Fig. 11 A: Vehicle data sticker: in the example with engine code CBFA ③. B: Type plate:

First read and observe the introductory information and safety warnings ⚠ on page 29.

**Vehicle identification number**

The vehicle identification number can be read from the outside through a viewing window in the windscreen. The viewing window is on the side at the bottom of the windscreen. In addition, the vehicle identification number is punched in at the right water drainage channel. The water drainage channel is located between the suspension strut dome and the fender. To get to the vehicle identification number, open the bonnet  ⇒ page 131.

**Vehicle data sticker**

The vehicle data sticker ⇒ fig. 11 A is stuck in the spare wheel well in the boot and contains the following data:

- ① Vehicle identification number (chassis number)
- ② Vehicle type, engine power, transmission
- ③ Engine and gearbox code, paint number, interior equipment number. In the example, the engine code is "CLNA" ⇒ fig. 11.
- ④ Optional equipment, PR numbers

**Engine data**

 **First read and observe the introductory information and safety warnings  on page 29.**

These vehicle data are also indicated in the service schedule.

**Type plate**

The type plate ⇒ fig. 11 B can be seen at the bottom of the door frame after opening the front passenger door. Vehicles for certain export countries do not have a type plate.

Besides the vehicle identification number (chassis number) and the engine code, the type plate contains the following data:

- ⑤ Permissible gross weight
- ⑥ Permissible front axle load
- ⑦ Permitted rear axle load

**Petrol engines**

Engine power	Fuel injection	MKB	Maximum torque	Cylinders, displacement
77 kW at 5000 rpm		CLSA	153 Nm at 3800 rpm	4 cylinders, 1598 cc

**Diesel engine**

Engine power	Fuel injection	MKB	Maximum torque	Cylinders, displacement
77 kW at 4400 rpm	TDI <sup>®</sup>	CLNA	250 Nm at 1500 - 2500 rpm	4 cylinders, 1598 cc

For approval or tax related reasons, the power and performance data of some engines may differ from the specifications in other countries.

**Dimensions**

 **First read and observe the introductory information and safety warnings  on page 29.**

Length	4,386 mm
Width	1,699 mm

Height (unladen)	1,466 mm
Wheel base	2,552 mm
Minimum turning circle diameter <sup>a)</sup>	10.6 m
Track gauge <sup>a)</sup> front	1,460 mm



Track gauge <sup>a)</sup> rear	1,498 mm
Ground clearance at permissible gross weight <sup>b)</sup>	129 - 151 mm

a) Depending on the rim and tyre size, small deviations are possible.

b) Value at permissible gross weight; the specified value may differ depending on the equipment.

### NOTICE

- Drive cautiously onto parking lots with high-curb mounts or solid boundaries. Those objects protruding from the ground may damage the bumper and other vehicle parts when parking or leaving.
- Drive cautiously over driveways, ramps, curbs and other objects. Deep-seated vehicle parts such as bumpers, spoilers and parts of the chassis, engine or exhaust system can be damaged when driving over these objects.

## Performance



First read and observe the introductory information and safety warnings  on page 29.

For approval or tax related reasons, the power and performance data of some engines may differ from the specifications in other countries.

### Petrol engines

Engine power	MKB	Transmission	Maximum speed
77 kW	CLSA	SG5	188 km/h
		AG6	183 km/h

### Diesel engine

Engine power	MKB	Transmission	Maximum speed
77 kW	CLNA	SG5	186 km/h



### Note

The performance figures were determined without performance-reducing equipment such as mud flaps.

## Opening and closing

### Vehicle key set

#### Introduction

This chapter contains information on the following subjects:

Vehicle key .....	32
Indicator light in the vehicle key .....	33
Replacing the battery .....	34
Synchronising the vehicle key .....	34

#### Additional information and warnings:

- Central locking system and closing system ⇒ page 35
- Starting and stopping the engine ⇒ page 94
- Consumer information ⇒ page 179
- Emergency closing or opening ⇒ page 187

#### DANGER

If batteries with a diameter of 20 mm or other lithium batteries are swallowed, serious or even fatal injuries may result in a very short time.

- Always keep the vehicle key and key chains with batteries, spare batteries, button cells and other batteries that are larger than 20 mm out of reach of children.
- Get medical attention immediately if you assume that a battery has been swallowed.

#### WARNING

Careless or unsupervised use of the vehicle keys can cause accidents and serious injuries.

- Always take along all vehicle keys when leaving the vehicle. Children or unauthorised persons can lock the doors and boot lid, start the engine, switch on the ignition and thus operated electrical equipment, such as power windows.


#### WARNING (Continued)

- Never allow children or people requiring help alone in the vehicle. In an emergency, they are unable to leave the vehicle alone or to help themselves. For example, depending on the season, very high or low temperatures may develop in a closed vehicle, causing serious injuries and illness or death, especially in young children.
- Never remove the vehicle key from the ignition while the vehicle is in motion. The steering lock can engage and the vehicle can no longer be steered.

### Vehicle key



Fig. 12 Vehicle key.

 First read and observe the introductory information and safety warnings  on page 32.

#### Vehicle key

With the vehicle key, the vehicle can be remotely locked and unlocked.

The transmitter with the battery is housed in the vehicle key. The receiver is located in the interior of the vehicle. The effective range of the vehicle key is a few metres around the vehicle when the battery is full.

When it is not possible to open or close the vehicle with the vehicle key, the vehicle key must be re-synchronised ⇒ page 34 or the battery in the vehicle key must be replaced ⇒ page 34.

Multiple vehicle keys may be used. ▶

**Flipping the key bit out or in**

By pressing the button ⇒ fig. 12 (A), the key bit unlocks and flips out.

To *flip in* the key bit, press the button and simultaneously push the key back until it clicks into place.

**Replacement key**

To obtain a replacement key or additional vehicle keys, the chassis number of the vehicle is necessary.

Every new vehicle key must contain a microchip that is coded with the data of the vehicle's electronic immobiliser. A vehicle key does not work if it contains no microchip, or contains a microchip that is not coded. This also applies to vehicle keys that are cut correctly.

New vehicle keys or replacement keys are available from Škoda partners or professional and authorised locksmiths who are qualified to produce these vehicle keys.

New vehicle keys and replacement keys must be programmed before use ⇒ page 34.

**NOTICE**

Each vehicle key contains electronic components. Protect vehicle keys from damage, moisture and strong shocks.

**Note**

Press the buttons in the vehicle key only if the corresponding feature is actually needed. An unnecessary push of a button may inadvertently unlock the vehicle. This applies even if you think that you are out of range.

**Note**

The function of the vehicle key may be temporarily affected by interference from nearby transmitters operating in the same frequency range, for example, by radio equipment or a mobile phone.

**Note**

Obstacles between the vehicle and the vehicle key, bad weather conditions and weak batteries reduce the radio range.

**Note**

If the buttons in the vehicle key ⇒ fig. 12 or one of the central locking buttons ⇒ page 35 are pushed several times in a row within a short time, the central locking system will temporarily shut down to protect against overload. The vehicle is then unlocked. Lock the vehicle if necessary.

**Indicator light in the vehicle key**

Fig. 13 Indicator light in the vehicle key.



First read and observe the introductory information and safety warnings ⚠ on page 32.

When a button in the vehicle key is pressed shortly, the indicator light (arrow ⇒ fig. 13) will flash once briefly. By prolonged pressing of a button, it flashes several times, such as during convenience opening.

If the indicator light in the vehicle key fails to light up when a button is pressed, the battery in the vehicle key must be replaced ⇒ page 34.

## Replacing the battery

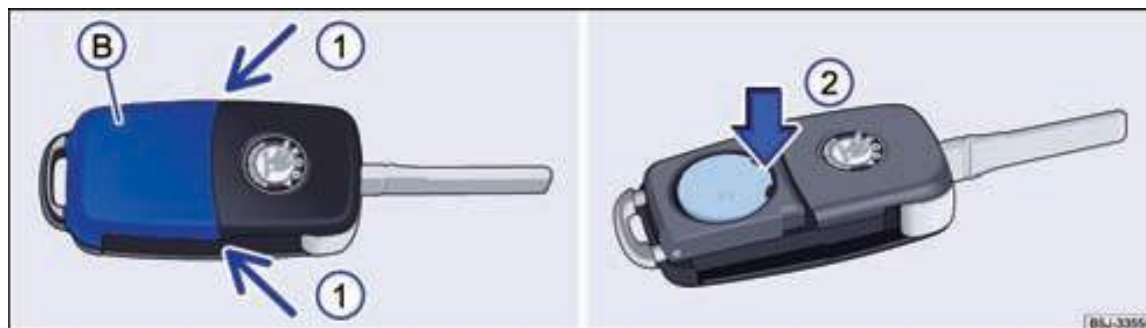


Fig. 14 Vehicle key: Open the battery compartment cover / remove the battery.

First read and observe the introductory information and safety warnings on page 32.

Škoda recommends having the battery replaced by a specialist garage. The battery is located on the rear of the vehicle key under a cover.

When replacing the battery, pay attention to the correct polarity and use the same type of battery ⇒ .

### Replacing the battery

- Flip out the key bit of the vehicle key ⇒ page 32.
- Pry off the battery cover ⇒ fig. 14 with your thumb or with a flat screwdriver at the points of the arrows and remove ⇒ .
- Press down the battery in the direction of the arrow and remove it from the key.
- Insert the new battery and push it into the battery compartment ⇒ .
- Place the battery cover on the key and press it down until it clicks into place.

### NOTICE

- An improperly performed battery replacement could damage the vehicle key.
- Improper batteries may cause damage to the vehicle key. Discharged batteries may be replaced only with new batteries of the same voltage, same size and specification.
- When installing the battery, pay attention to the correct polarity.

### For the sake of the environment

- Dispose of discharged batteries in accordance with environmental regulations. ■

## Synchronising the vehicle key

First read and observe the introductory information and safety warnings on page 32.

If the button is pressed frequently outside the effective range, it may no longer be possible to lock or unlock the vehicle with the vehicle key. In this case, the vehicle key must be re-synchronised as follows:

- Flip out the key bit of the vehicle key ⇒ page 32.
- Press the button in the vehicle key. Stand immediately close to the vehicle when doing so.
- Unlock the vehicle with the key bit flipped out within one minute.
- Switch on the ignition with the vehicle key. The synchronisation is now complete. ■

## Central locking and closing system

### Introduction

This chapter contains information on the following subjects:

Description of the central locking system .....	35
Unlocking and locking the vehicle from the outside .....	36
Unlocking and locking the vehicle from the inside .....	37

The central locking system only works properly if all the doors and the boot lid are completely closed. The vehicle can *not* be locked with the vehicle key when the driver's door is open.

Longer times of an unlocked vehicle (for example, in your own garage) can cause the vehicle battery to discharge so that the engine can no longer be started.

#### Additional information and warnings:

- Vehicle key set ⇒ page 32
- Doors ⇒ page 38
- Boot lid ⇒ page 40
- Power windows ⇒ page 42
- Emergency closing or opening ⇒ page 187

### WARNING

**Improper use of the central locking system can cause serious injury.**

- The central locking system locks all doors. Locking a vehicle from the inside may prevent undesired opening of doors and intrusion by unauthorised persons. In an emergency or in case of an accident, however, locked doors make it difficult for helpers to access the passenger compartment to help people.
- Never allow children or people requiring help alone in the vehicle. With the central locking button, all doors can be locked from the inside. This may result in trapping yourself in the vehicle. Trapped persons can be exposed to very high or very low temperatures.

### WARNING (Continued)

- Depending on the season, very high or low temperatures may develop in a closed vehicle, causing serious injuries and illness or death especially in young children.
- Never leave people in a locked vehicle. In an emergency, these persons are unable to leave the vehicle alone or to help themselves.

### Description of the central locking system

 First read and observe the introductory information and safety warnings  on page 35.

The central locking system allows you to centrally lock and unlock all door and the boot lid:


- from the outside using the vehicle key.
- from the inside using the central locking button ⇒ page 37.

Particular features of the central locking system can be enabled or disabled by a specialist garage.

The doors and the boot lid can be unlocked or locked manually if the vehicle key fails.

#### Locking the vehicle after the airbags are deployed

In the event that the airbags are deployed in an accident, the entire vehicle is unlocked. Depending on the degree of damage, the vehicle can be locked after the accident as follows.

Function	Action
Locking the vehicle from the inside:	- Switch the ignition off and on again. - Press the central locking button  .
Locking the vehicle from the outside:	- Switch the ignition off and on again.
	<b>OR:</b> Remove the vehicle key from the ignition lock. - Open a vehicle door once. - Lock the vehicle using the vehicle key.

## Unlocking and locking the vehicle from the outside



Fig. 15 Key without remote control / remote control key



First read and observe the introductory information and safety warnings ⚠ on page 35.

Function	Action with the buttons in the vehicle key ⇒ fig. 15	Action with the vehicle key in the lock cylinder or with a mechanical vehicle key ⇒ fig. 15
Unlocking the vehicle	Press the Ⓧ button. Press and hold for convenience opening.	Insert vehicle key into lock cylinder of the driver's door and turn <b>clockwise</b> . Turn and hold for convenience opening.
Locking the vehicle.	Press the Ⓛ button. Press and hold for convenience closing.	Insert vehicle key into lock cylinder of the driver's door and turn <b>counter-clockwise</b> . Turn and hold for convenience closing.
Unlocking the boot lid	Press the Ⓜ button.	Insert vehicle key into lock cylinder of the boot lid and turn <b>clockwise</b> .

The remote control key locks and unlocks the vehicle only if the batteries have sufficient power and the vehicle key is in the range of a few metres around the vehicle.

- When locking the vehicle, all turn signal lights will flash *once* for confirmation.
- When unlocking the vehicle, all turn signal lights will flash *twice* for confirmation.

If the turn signal lights do *not* flash for confirmation, at least one of the doors or the boot lid or bonnet is not locked.

The vehicle can not be locked with the vehicle key when the driver's door is open. If the vehicle is unlocked and no door or the boot lid is opened, the vehicle is locked again automatically after a few seconds. This function is intended to prevent the vehicle from being unlocked unintentionally.

### Convenience opening and closing

- See power windows - features ⇒ page 42. ■



## Unlocking and locking the vehicle from the inside



Fig. 16 In the driver's door:  
Central locking button.

 First read and observe the introductory information and safety warnings  on page 35.

Press the  **fig. 16** button:

-  Unlocking the vehicle
-  Locking the vehicle

The central locking button works both with the ignition switched on and off.

If the vehicle is locked with the central locking button, then:

- Opening the doors and the boot lid from the *outside* is not possible, for example, when stopping at traffic lights.
- Doors can be unlocked and opened from the inside by pulling the door opening lever. If necessary, the door opening lever must be pulled repeatedly.
- An open driver's door is not included in the locking operation. This prevents that the driver locks himself out. ■

## Doors

### Introduction

This chapter contains information on the following subjects:

Warning light .....	38
Child safety lock .....	39

#### Additional information and warnings:

- Exterior views ⇒ page 6
- Vehicle key set ⇒ page 32
- Central locking system and closing system ⇒ page 35
- Emergency closing or opening ⇒ page 187

#### WARNING

An improperly closed door can open suddenly while driving, causing serious injuries.


- Immediately stop and close the door.
- When closing make sure that the door locks fully into place. The closed door must be flush with the surrounding body parts.
- Open or close doors only when no one is within the swivelling range.



#### WARNING

A door held open with the door strap may close automatically in strong wind conditions and on slopes, causing injuries.


- Always hold the door handle when opening and closing any door.


### Warning light

 First read and observe the introductory information and safety warnings  on page 38.

Illuminates	Possible cause	Remedy
	At least one vehicle door is open or not closed properly.	 <b>Do not drive the vehicle!</b> Open the corresponding vehicle door and close it again.

When switching on the ignition, some warning and indicator lights illuminate briefly as a function test. They will extinguish after a few seconds.

If a door is open or not closed properly, the warning light  illuminates in the instrument cluster.

The warning light  is visible even when the ignition is switched off. ■



## Child safety lock



Fig. 17 In the rear left door:  
Child safety lock (A) is on, (B) is off.

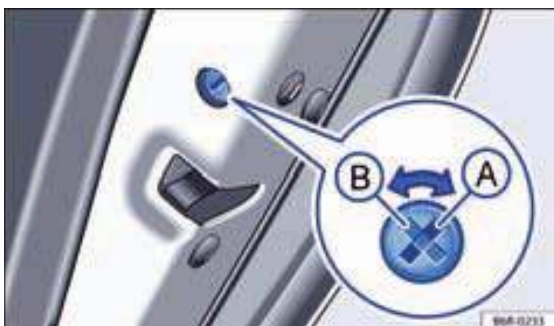


Fig. 18 In the rear right door:  
Child safety lock (A) is on, (B) is off.

 First read and observe the introductory information and safety warnings  on page 38.

The child safety lock prevents opening the rear doors from inside, so, for example, children can not accidentally open a door while the car is in motion. While the child safety lock is switched on, the door can be opened only from the outside.

### Switching the child safety lock on or off

- Unlock the vehicle and open the appropriate rear door.
- Flip out the key bit from the vehicle key.
- Use the key bit to move the slot to the desired position.

Position of the slot ⇒ fig. 17 or ⇒ fig. 18:

- (A) Child safety lock off.
- (B) Child safety lock on.

### WARNING

When the child safety lock is switched on, the respective door can not be opened from the inside.

- Never leave children or persons requiring help inside the vehicle when the doors are locked. This may cause these people to get trapped in the vehicle. In an emergency, they would not be able to leave the vehicle alone or to help themselves. Trapped persons can be exposed to very high or very low temperatures.
- Depending on the season, very high or low temperatures may develop in a closed vehicle, causing serious injuries and illness or death especially in young children.

## Boot lid

### Introduction

This chapter contains information on the following subjects:

Opening the boot lid .....	40
Closing the boot lid .....	41

#### Additional information and warnings:

- Exterior views ⇒ page 6
- Central locking system ⇒ page 35
- Transporting ⇒ page 81

### WARNING

Improper and unsupervised unlocking, opening or closing the boot lid can cause accidents and serious injuries.

- Open or close the boot lid only when no one is within the swivelling range.
- After closing the boot lid, check that it is properly closed and locked so that it can not open automatically while driving. The closed boot lid must be flush with the surrounding body parts.
- Always keep the boot lid closed while driving to prevent toxic exhaust gases from entering the interior.
- Never open the boot lid when it is loaded with cargo, for example, on a luggage rack. Likewise, the boot lid may not open if it is loaded with objects, such as bicycles. An open boot lid may lower independently by the additional weight. Where appropriate, support the boot lid or remove the load beforehand.
- Close and lock the boot lid and all doors when the vehicle is not used. Make sure that no one is left in the vehicle.
- Never let children play in and around the vehicle unattended, especially when the boot lid is open. Children may climb into the boot, close the boot lid and thus lock themselves. Depending on the season, very high or low temperatures may develop in a closed vehicle, causing serious injuries and illness or death especially in young children.
- Never allow children or people requiring help alone in the vehicle. They may lock the vehicle with the vehicle key or the central locking button, thereby locking themselves.

### NOTICE

Before opening the boot lid, check that there is sufficient space for opening and closing the boot lid, for example, in garages.

### Opening the boot lid



Fig. 19 Vehicle key with unlocking button for the boot lid.




Fig. 20 Opening the boot lid from the outside.


First read and observe the introductory information and safety warnings ⚠ on page 40.

If, for example, bicycles are mounted on a rack on the boot lid, it may not be possible to open the boot lid ⇒ ⚠. Remove the object from the rack and support the open boot lid. ▶

**Unlocking with the vehicle key**

Press and hold the  button in the vehicle key  $\Rightarrow$  fig. 19 until the boot lid unlocks and springs open slightly.

**Unlocking via the button in the driver's door**

Pull the  button in the driver's door upwards, until the boot lid unlocks and springs open slightly.

The button in the driver's door also works with the ignition switched off.

**Unlocking via the lock cylinder in the boot lid**

Insert the vehicle key into the lock cylinder of the boot lid and turn clockwise  $\Rightarrow$  fig. 20 ①, until the boot lid unlocks and springs open slightly.

**Opening the boot lid**

Lift and fully open the unlocked boot lid ②, until the boot lid is held at the stop in a holding position.

**⚠ WARNING**

Improper or unsupervised unlocking or opening the boot lid can cause serious injury.

- If a luggage rack including cargo is mounted on the boot lid, it may not always be possible to recognise that a boot lid is unlocked. An unlocked boot lid may open suddenly while driving.



First read and observe the introductory information and safety warnings  on page 40.

**Closing the boot lid**

- Reach into one of the recesses in the inner panelling of the boot lid  $\Rightarrow$  fig. 21.
- Pull down and close the boot lid.
- Check, by pulling on the boot lid, that it is securely locked.

**⚠ WARNING**

Improper or unsupervised closing of the boot lid can cause serious injury.

- Never leave your vehicle unattended or let children play in and around the vehicle, especially when the boot lid is open. Children may climb into the boot, close the boot lid and thus lock themselves. A closed vehicle can extremely heat up or cool down depending on the season, causing serious injury, illness or even death.

**i Note**

Before closing the boot lid, check that the vehicle key is not in the boot.

**i Note**

When the boot lid is in the holding position, a greater force may be necessary to close the boot lid.

**Closing the boot lid**

Fig. 21 Open boot lid: Recesses for closing.

## Power windows

### Introduction

This chapter contains information on the following subjects:

Electrically opening or closing the windows .....	42
Force limiter of the power windows .....	43

#### Additional information and warnings:

- Central locking system and closing system ⇒ page 35
- Maintaining and cleaning the vehicle exterior ⇒ page 148

#### **WARNING**

Careless or unsupervised use of the power windows can cause serious injuries.

- Open or close the power windows only when no one is in the functional range.
- Never leave children or persons requiring help inside the vehicle when the vehicle is locked. The windows may no longer open in an emergency.
- Always take along all vehicle keys when leaving the vehicle. After switching off the ignition, the windows can still be opened or closed briefly via the buttons as long as the driver's or front passenger door is not opened.
- When carrying children in the back seats, always disable the rear power windows with the safety button so that the windows can not be opened or closed.

#### **NOTICE**

When the windows are open, sudden precipitation may drench the interior of the vehicle, resulting in vehicle damage.

## Electrically opening or closing the windows

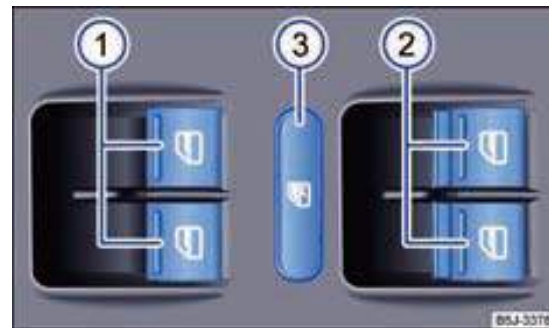


Fig. 22 In the driver's door: Buttons for the front and rear power windows.

First read and observe the introductory information and safety warnings ⚠ on page 42.

#### Buttons in the driver's door

Legend to fig. 22:

- ① For the windows in the front doors.
- ② For the windows in the rear doors.
- ③ Safety button.

#### **WARNING**


Careless or unsupervised use of the power windows can cause serious injuries.


- Open or close the power windows only when no one is in the functional range.
- Never leave children or persons requiring help inside the vehicle when the vehicle is locked. The windows may no longer open in an emergency.
- Always take along all vehicle keys when leaving the vehicle. After switching off the ignition, the windows can still be opened or closed briefly via the buttons as long as the driver's or front passenger door is not opened.
- When carrying children in the back seats, always disable the rear power windows with the safety button so that the windows can not be opened or closed.

## Force limiter of the power windows



First read and observe the introductory information and safety warnings  on page 42.

The force limiter of the power windows can reduce the risk of crush injury when closing a window  $\Rightarrow$  . If the automatic closing operation of a window is impaired by stiffness or by an obstruction, the window will immediately open again.

- Check why the window did not close.
- Try again to close the window.
- If, within 10 seconds since the first stopping and opening of the window, the window is again prevented from closing by stiffness or by an obstruction, the automatic closing operation will be suspended for about 10 seconds.
- If the window still can not be closed by stiffness or by an obstruction, the window stops at the respective point. By pressing the button once again within 10 seconds, the window will close **without any force limitation**  $\Rightarrow$  .

### Closing a window without force limitation

- Try to close again the window within approx. 10 seconds by pressing and holding the button. **The force limiter will be disabled for a small functional range of the closing operation!**
- If the closing operation takes longer than approx. 10 seconds, the force limiter will be active again. The window will then stop again when it encounters stiffness or an obstruction.
- If the window still can not be closed, consult a specialist garage.

### WARNING

Closing of the power windows without force limitation can cause serious injuries.

- Always close power windows with caution.
- No one may be present within the functional range of the power windows, especially when they are closed without force limitation.
- The force limiter does not prevent fingers and other body parts from being pressed against the window frame and getting injured.

## Sitting properly and safely

### Adjusting the seat position

#### Introduction

This chapter contains information on the following subjects:

Risk of a bad seated position .....	45
Correct seated position .....	46
Mechanical controls on the front seats .....	47
Adjusting the head restraint .....	48
Removing and installing a head restraint .....	48
Adjusting the steering wheel position .....	49
Centre armrest .....	50

#### Number of seats

The vehicle has a total of **five** seats: two seats in the front and three seats in the back. Each seat is equipped with a seat belt.

#### Additional information and warnings:

- Seat features ⇒ page 51
- Seat belts ⇒ page 52
- Airbag system ⇒ page 60
- Child seats (optional) ⇒ page 66

#### WARNING

An incorrect seated position in the vehicle in the event of sudden driving and braking manoeuvres, in a collision or accident, and when the airbags are deployed may increase the risk of serious or fatal injuries.

- All passengers must assume the correct seated position before departure and maintain it during travel. This also applies to the use of seat belts.
- Never carry more people than the number of seats with seat belts in the vehicle.

#### WARNING (Continued)

- Children should always be secured in the vehicle with an approved and appropriate restraint system according to their size and weight ⇒ page 66, ⇒ page 60.
- Always keep your feet inside the footwell during the ride. Never, for example, put your feet on the seat or on the instrument panel and never stick them out of the window. The airbag and the seat belt can otherwise develop no protective effect but can increase the risk of injuries in an accident.

#### WARNING

Before all trips, always adjust the seat, the seat belt and the head restraint properly and make sure that all passengers wear their seat belts correctly.

- Slide the front passenger seat back as far as possible.
- Adjust the driver's seat such that at least 10 inches (25 cm) are between your chest and the steering wheel centre. If this requirement can not be met due to physical characteristics, be sure to consult a specialist garage about making any special installations.
- Never drive with the seat backrest excessively inclined backward. The further the seat backrest is inclined backward, the greater the risk of injuries due to incorrect routing of the webbing of the seat belt and a bad seated position.
- Never drive with the seat backrest inclined forward. A deploying front airbag may slam the seat backrest to the rear, thereby injuring the passengers in the rear seats.
- Assume and maintain a seated position as far as possible from the steering wheel and instrument panel.
- Always sit upright with your back against the seat backrest in correctly adjusted front seats. Do not position any body part directly at or too close to the installation positions of the airbags.
- For rear seat passengers, the risk of serious injuries increases if they do not sit upright, because the seat belts are not positioned correctly.

**⚠ WARNING**

Improper adjustment of the seats can cause accidents and serious injuries.

- Adjust the seats only when the vehicle is stationary because the seats may shift unexpectedly while driving, causing you to lose control of the vehicle. In addition, a wrong seated position will be assumed during the adjustment.
- Adjust the height, inclination and forward/back direction only when no one is within the adjustment range of the seats.
- The adjustment of the front seats must not be constrained by objects.

### Risk of a bad seated position



First read and observe the introductory information and safety warnings ⚠ on page 44.

If the seat belts are not fastened or were not adjusted properly, the risk of serious or fatal injuries is increased. Seat belts offer their optimum protection only if the webbing of the seat belts is properly routed. An incorrect seated position significantly impairs the protective effect of seat belts. Serious or even fatal injuries can be the result. The risk of serious or fatal injuries is increased particularly when a deployed airbag hits an occupant who has assumed a wrong seated position. The driver is responsible for all passengers, especially for children that are carried in the vehicle.

The following list contains examples of which seated positions can be dangerous for all occupants.

#### Whenever the vehicle is in motion:

- Never stand in the vehicle.
- Never stand on the seats.
- Never knee on the seats.
- Never incline the seat backrest excessively to the back.
- Never lean against the instrument panel.
- Never lie down on the rear seat bench.
- Never only sit on the front area of the seat.
- Never sit facing to the side.
- Never lean out the window.
- Never put your feet out of the window.
- Never put your feet on the instrument panel.

- Never put your feet on the seat cushion or seat backrest.
- Never ride in the footwell.
- Never sit on the front or rear armrest.
- Never ride without seat belts on the seat.
- Never climb into the boot.

**⚠ WARNING**

Any bad seated position in the vehicle increases the risk of serious or fatal injuries in the event of accidents and sudden driving and braking manoeuvres.

- All passengers must assume the right seated position and be wearing a seat belt properly.
- By incorrect seated positions, failure to wear seat belts, or sitting too close to the airbag, occupants expose themselves to life-threatening or fatal injuries, especially if the airbags deploy, hitting an occupant who has assumed a bad seated position.

### Correct seated position

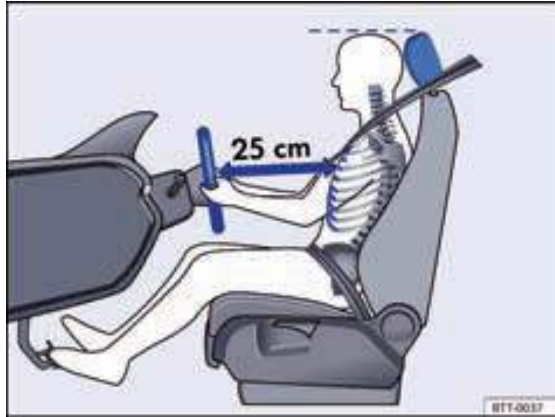



Fig. 23 The correct driver's distance from the steering wheel must be at least 10 inch (25 cm).



Fig. 24 Correct routing of the belt webbing and correct head restraint adjustment.

 First read and observe the introductory information and safety warnings  on page 44.

The following explains the correct seated positions for the driver and passengers.

Individuals who can not assume the correct seated position because of their physical characteristics should check with a specialist garage about possible special installations. Only with the correct seated position can the optimal protective effect of seat belts and airbags be obtained. Škoda recommends a Škoda partner for this purpose.

For your safety and to reduce injuries in the event of a sudden braking manoeuvre or accident, Škoda recommends the following seated positions:

#### For all vehicle occupants:

- Adjust the head restraint such that the top of the head restraint is in line with the upper part of your head if possible - but not lower than the eye level. Always position the back of your head as close as possible to the head restraint → fig. 23 and → fig. 24.
- For small persons, slide the head restraint all the way down, even when the head is then below the top edge of the head restraint.
- For tall people, pull the head restraint all the way up.
- Adjust the seat backrest to an upright position so that the back rests fully against the seat backrest.
- Keep both feet in the footwell during the ride.
- Correctly adjust and wear seat belts → page 52.

#### Additionally for the driver:

- Adjust the steering wheel such that the distance between the steering wheel and your chest is at least 10 inches (25 cm) → fig. 23 and the steering wheel can be held with both hands at the outer edge and arms slightly bent.
- The steering wheel must always point in the direction of the chest and not in the direction of the face.
- Adjust the driver's seat in the forward/back direction such that the pedals can be depressed with slightly bent legs.
- Adjust the height of the driver's seat such that the top point of the steering wheel can be reached.
- Always keep both feet in the footwell to maintain control over the vehicle at all times.

#### Additionally for the front passenger:

- Move the front passenger seat back as far as possible so that the airbag can achieve its full protective effect should it be deployed. ■



## Mechanical controls on the front seats

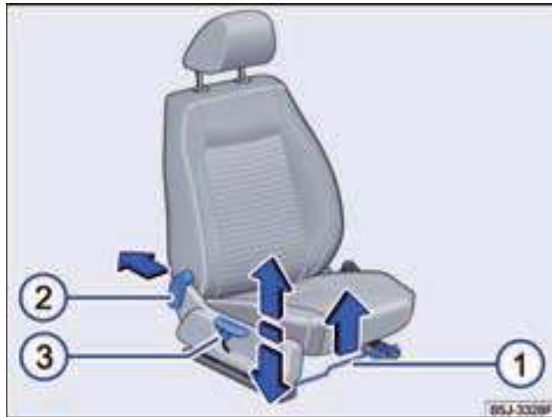




Fig. 25 Controls on the front seats.



Fig. 26 Control lever on the back of the front passenger seat

 First read and observe the introductory information and safety warnings  on page 44.

Only the driver's seat is height adjustable.

⇒ fig. 25	Function	Action
①	Moving the front seat forward or backward.	Pull the handle upward and move the front seat. The front seat must lock into place after you release the handle!
②	Adjusting the seat backrest.	Push the lever back and adjust the seat backrest. The seat backrest must lock into place after you release the lever!
③	Adjusting the height of the driver's seat.	Pull the lever several times upward or push it downward until the desired seat height is reached.

The front passenger seat can be moved in the forward/back direction also from the rear. Pull the lever ⇒ fig. 26 ① upward and move the front seat. The front seat must lock into place after you release the lever! The front passenger seat can be moved only when it is unoccupied. ■

## Adjusting the head restraint

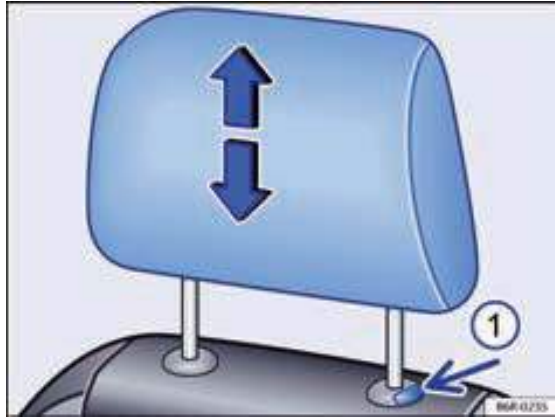



Fig. 27 Adjusting the head restraints in front.

 First read and observe the introductory information and safety warnings  on page 44.

Depending on the equipment, all the seats are equipped with head restraints. The rear middle head restraint is provided only for the middle seat in the rear seat bench. Therefore, do not install the head restraint at different positions.

The guide rods of the head restraint have notches to engage the head restraint. Only properly installed head restraints can lock into place at the notches within the adjustment range. To prevent that installed head restraints can be removed inadvertently, the adjustment range is limited at the top by a stopper.

### Adjusting the height

- Slide the head restraint upward in the direction of the arrow or press and hold the button  $\Rightarrow$  fig. 27 ① to slide it downward  $\Rightarrow$  .
- The head restraint must securely lock into place at a position.

### Proper head restraint adjustment

Adjust the head restraint such that the top of the head restraint is in line with the upper part of your head if possible – but not lower than the eye level. Position the back of your head always as close as possible to the centre of the head restraint.

### Head restraint adjustment for small people

Slide the head restraint fully down, even if the head is then below the top edge of the head restraint. In the lowest position, there may be a small gap between the head restraint and the seat backrest.

### Head restraint adjustment for tall people

Slide the head restraint fully upward.

### WARNING

Driving or riding with head restraints removed or improperly adjusted increases the risk of serious or fatal injuries in case of accidents and sudden driving and braking manoeuvres.


- Always drive with properly installed and adjusted head restraints if persons are sitting in the respective seats.
- Each occupant must have adjusted the head restraint properly according to his or her body size to reduce the risk of neck injuries in an accident. The upper edge of the head restraint should be in line with the upper part of the head – but not lower than the eye level. The back of the head should be positioned as close as possible in the centre of the head restraint.
- Never adjust the head restraint while driving.

## Removing and installing a head restraint


 First read and observe the introductory information and safety warnings  on page 44.

Depending on the equipment, all the seats are equipped with head restraints.

### Removing a head restraint

- Slide the head restraint fully upward  $\Rightarrow$  .
- Press and hold the button  $\Rightarrow$  fig. 27 ① and pull the head restraint all the way out.

### Installing a head restraint

- Position the head restraint correctly over the head restraint guides and insert it into the guides of the respective seat backrest.
- Push and hold the button ① and slide the head restraint down.
- Adjust the head restraint according to the correct seated position  $\Rightarrow$  page 48. 

**⚠ WARNING**

Driving or riding with head restraints removed or improperly adjusted increases the risk of serious or fatal injuries in case of accidents and sudden driving and braking manoeuvres.

- Always drive with properly installed and adjusted head restraints if persons are sitting in the respective seats.
- Reinstall removed head restraint as soon as possible so that the passengers can be protected properly.

**⚠ NOTICE**

When removing and installing a head restraint make sure that the head restraint does not hit against the headliner or other vehicle parts. Otherwise, damage may result.

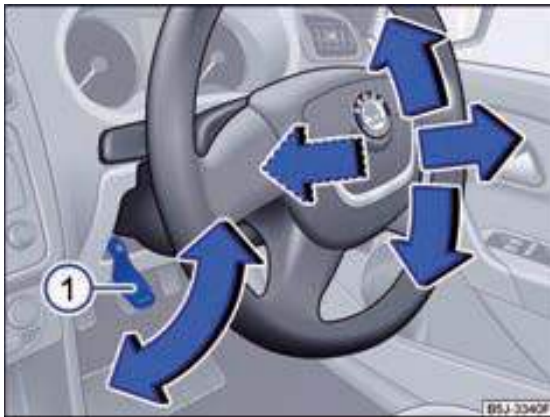
**Adjusting the steering wheel position**

Fig. 28 Mechanical adjustment of the steering wheel position.



First read and observe the introductory information and safety warnings ⚠ on page 44.

Adjust the steering wheel before driving and only when the vehicle is stationary.

- Fold the lever ⇒ fig. 28 ① down.
- Adjust the steering wheel such that you can hold it with both hands on the outer edge (9 o'clock and 3 o'clock positions) and arms slightly bent.
- Push the lever firmly upward until it is flush with the steering column ⇒ ⚠.

**⚠ WARNING**

Improper use of the steering wheel position adjustment and an incorrect adjustment of the steering wheel can cause serious or fatal injuries.

- Always firmly fold the lever ① upward after the adjustment so that the steering wheel does not unintentionally change its position while driving.
- Never adjust the steering wheel while driving. If you determine during the ride that an adjustment is necessary, stop safely and adjust the steering wheel properly.
- The adjusted steering wheel must always point toward the chest and not in the direction of the face, to prevent the protective effect of the driver's front airbag from being restricted in the event of an accident.
- While driving, always hold the side of the steering wheel with both hands at the outer edges (9 o'clock and 3 o'clock positions) to reduce injuries in the event that the driver's front airbag is deployed.
- Never hold the steering wheel in the 12 o'clock position or in any other way, for example, in the steering wheel centre. If the driver's front airbag is deployed, serious injuries to the arms, hands and head may result.

## Centre armrest



Fig. 29 Front centre armrest.



Fig. 30 Rear centre armrest.

 First read and observe the introductory information and safety warnings  on page 44.

### Front centre armrest

To raise, push the centre armrest stop by stop up in the direction of the arrow  
⇒ fig. 29.

To lower, pull the centre armrest fully up. Then lower the armrest down.

### Rear centre armrest

The backrest of the middle seat in the rear contains a fold-out centre armrest  
⇒ fig. 30.

## WARNING

The centre armrest may interfere with the movement of the arms of the driver and cause accidents and serious injuries.

- Always keep the storage compartments in the centre armrest closed while driving.
- Never carry a person or a child on the centre armrest. This bad seated position can cause serious injuries.
- Never place hot beverages or liquids in the cup holder. They may be spilled while driving and during braking and driving manoeuvres.

## Seat features

### Introduction

#### Additional information and warnings:

- Adjusting the seat position ⇒ page 44
- Seat belts ⇒ page 52
- Airbag system ⇒ page 60
- Child seats (optional) ⇒ page 66
- Exterior mirrors ⇒ page 79

#### **WARNING**

Improper use of seat features can cause serious injuries.


- Always assume the correct seated position before setting off and keep it while driving. This also applies to all passengers.
- Keep your hands, fingers and feet or other body parts away from the functional and adjustment ranges of the seats.

## Seat belts

### Introduction

This chapter contains information on the following subjects:

Frontal collision and the laws of physics .....	53
What happens to occupants not wearing seat belts? .....	54
Seat belts protect .....	55
Using the seat belts .....	55
Fastening or releasing the safety belt .....	56
Routing of the belt webbing .....	57
Seat belt height adjuster .....	59
Inertia reel .....	59

Regularly check the condition of all seat belts. In case of damage to the webbing, the belt connections, the inertia reel or the lock, have the seat belt immediately replaced by a specialist garage ⇒ . The specialist garage must use the correct replacement parts that fit the vehicle, the equipment, and the model year. Škoda recommends a Škoda partner for this purpose.

#### Additional information and warnings:

- Adjusting the seat position ⇒ page 44
- Airbag system ⇒ page 60
- Child seats (optional) ⇒ page 66
- Accessories, spare parts, repairs and modifications ⇒ page 172

### WARNING

Failure to wear seat belts or improperly adjusted seat belts increase the risk of serious or fatal injuries. Optimal protection is achieved only if the seat belts are fastened and used correctly.

- Safety belts are the most effective means to reduce the risk of serious and fatal injuries in accidents. To protect the driver and all passengers, the seat belts must always be fastened and adjusted correctly when the vehicle is moving.

### WARNING (Continued)

- Before each journey, each occupant in the vehicle must always assume the correct seated position and correctly fasten the seat belt belonging to his or her seat and keep it properly fastened during the ride. This applies to all passengers and also in city traffic.
- Secure children in the vehicle during the ride with a restraint system appropriate to their body weight and body size and properly fastened seat belts ⇒ page 66.
- Only depart when all the passengers are properly wearing their seat belt.
- Always insert the lock tongue into the belt buckle of the associated seat and let it securely snap into place. Failure to use a belt buckle belonging to the seat reduces the protective effect and can cause serious injuries.
- Never let objects and liquids enter into the slots of the belt buckles. This may impair the functions of the belt buckles and seat belts.
- Never release seat belts while driving.
- Always secure only one person with the same seat belt.
- Never carry children or babies on the lap and secure them with your seat belt.
- Do not wear bulky, loose clothing, such as a coat over a jacket, during the ride as it may impair the proper seating and the function of the seat belt.

### WARNING

Damaged seat belts pose a great danger and can cause serious or fatal injuries.

- Never damage a seat belt by getting it jammed in the door or in the seat mechanism.
- If the fabric or other parts of the seat belt are damaged, the seat belts may tear in an accident or sudden braking manoeuvre.
- Have damaged seat belts immediately replaced by seat belts that are approved by Škoda for the vehicle. Seat belts which have been subjected to stress in an accident and were therefore stretched must be replaced by a specialist garage. The renewal may be necessary even if no damage is obvious. The anchorage points for the belts should also be checked.
- Never try to repair, modify or remove the seat belts yourself. All repairs to seat belts, inertia reels and lock parts must be performed only by a specialist garage.

## Frontal collision and the laws of physics



Fig. 31 A vehicle moves towards a wall with occupants not wearing seat belts.



Fig. 32 A vehicle hits the wall with occupants not wearing seat belts.



First read and observe the introductory information and safety warnings  on page 52.

The physical principle of a frontal collision can be explained quite simply. Motion energy, so-called "kinetic energy", is produced as soon as the vehicle is moving  $\Rightarrow$  fig. 31, both for the vehicle and its occupants.

The higher the vehicle speed and the higher the weight, the more energy must be absorbed in the event of an accident.

The speed of the vehicle is, nevertheless, the more important factor. For example, if the speed of approx. 15 mph (25 km/h) doubles to approx. 30 mph (50 km/h), the kinetic energy increases four-fold!

The magnitude of the "kinetic energy" depends essentially on the speed at which the vehicle is travelling and on the weight of the vehicle and its occupants. The greater the speed and weight increase, the greater the amount of energy which has to be absorbed in the event of an accident.

The occupants of a vehicle who have not fastened their seat belt are therefore not "connected" to their vehicle. In the event of a frontal collision, these persons would therefore continue to be propelled forward at the same speed at which the vehicle was moving before the collision! In view of the fact that the occupants of the car in our example are not wearing seat belts, the entire kinetic energy of the occupants, in the event of a collision, can only be absorbed by the collision against the wall  $\Rightarrow$  fig. 32.

At a speed of approx. 18 mph (30 km/h) to approx. 30 mph (50 km/h), forces are generated acting on your body that can easily exceed one tonne (1,000 kg or 2,205 lbs). The forces acting on your body even increase further at higher speeds.

This example does not just apply to frontal collisions, but to all types of accidents and collisions. ■


### What happens to occupants not wearing seat belts?



Fig. 33 The driver not wearing a seat belt is catapulted forward.



Fig. 34 A passenger not wearing a seat belt on the rear seat is catapulted forward toward the driver wearing a seat belt.

 First read and observe the introductory information and safety warnings  on page 52.

Many people believe that you can support your body during a minor accident with your hands. This is wrong!

Even at low impact speeds, forces are acting on your body that can not be propped up with your arms and hands. In the event of a frontal collision, occupants not wearing a seat belt are catapulted forward and strike in an uncontrolled way parts of the interior of the vehicle, such as steering wheel, instrument panel and wind-screen  $\Rightarrow$  fig. 33.

The airbag system is not a substitute for the seat belt! When the airbags deploy, the airbags only offer additional protection. Airbags do not deploy in all types of accidents. Even if the vehicle is equipped with an airbag system, all occupants must be wearing seat belts properly during the ride, including the driver. This reduces the risk of serious or fatal injuries in the event of an accident – regardless of whether an airbag exists for the seat.

An airbag deploys only once. To achieve the best possible protection, the seat belts must be fastened always correctly to protect the occupants of the vehicle also in case of accidents without airbag deployment. Occupants not wearing seat belts can be catapulted out of the vehicle, thereby suffering even more serious or fatal injuries.



It is also important that rear seat passengers fasten their seat belt as they will otherwise be thrown through the vehicle in an uncontrolled manner in the event of an accident. A rear seat passenger not wearing a seat belt is a danger not only to himself but also for other persons in the vehicle  $\Rightarrow$  fig. 34. ■



## Seat belts protect



Fig. 35 Driver wearing a seat belt who is caught by the correctly fastened and adjusted seat belt in a sudden braking manoeuvre.

 First read and observe the introductory information and safety warnings  on page 52.

Correctly fastened and adjusted seat belts can make a big difference. Correctly fastened and adjusted seat belts keep occupants in the proper seated position and significantly reduce the kinetic energy in the event of an accident. Seat belts also help prevent uncontrolled movements that may lead to serious injuries. In addition, correctly fastened and adjusted seats belts reduce the risk of being catapulted out of the car  $\Rightarrow$  fig. 35.

The occupants of a vehicle who have fastened and correctly adjusted their seat belt profit to a major extent from the fact that the kinetic energy is optimally absorbed by the belts. The structure of the front end of the vehicle and other passive safety measures, such as the airbag system, also contribute to reducing the kinetic energy. The generated energy thus decreases and reduces the risk of injuries.

The examples describe frontal collisions. Of course, correctly fastened and adjusted seat belts also reduce the risk of injuries in all other types of accidents. Therefore, safety belts must be fastened before each journey, even if "only driving around the corner". Ensure that all passengers are wearing their seat belt properly.

Accident statistics have shown that the proper wearing of seat belts significantly reduces the risk of injuries and increases the chance of surviving a serious accident. Correctly fastened and adjusted seat belts also increase the optimal protective effect of deploying airbags in the event of an accident. For this reason, in most countries, the use of seat belts is required by law.

Although the vehicle is equipped with airbags, seat belts must be worn. The front airbags, for example, deploy only in some frontal collisions. The front airbags do not deploy at a low speed frontal collisions, slight side collisions, rear-end collisions, rollover, and in accidents in which the airbag deployment threshold was not exceeded in the control unit.







Therefore, always wear your seat belt and make sure that all passengers are wearing their seat belt correctly before driving!

## Using the seat belts

 First read and observe the introductory information and safety warnings  on page 52.

### Checklist

Using the seat belt  $\Rightarrow$  :

-  Regularly check the condition of all seat belts.
-  Keep the seat belts clean.
-  Always keep foreign bodies and liquids away from the webbing, the lock tongue and the slot in the belt buckle.
-  Avoid pinching or damaging the seat belt and lock tongue, e.g., when closing the door.
-  Never remove, modify or repair a seat belt and its anchorage elements yourself.
-  Always correctly fasten and adjust the seat belt before each journey leave it applied during the ride.

### Twisted seat belt

If it is difficult to pull the seat belt out from the belt guide, the seat belt may have become twisted within the side trim by returning it too quickly when releasing the belt:

- Hold the seat belt at the lock tongue and slowly and gently pull out the belt completely.
- Remove the twisting in the seat belt and return the belt slowly by hand.

If the twisting in the seat belt can not be removed, fasten the seat belt anyway. The twisting may then not be in a belt section which rests directly against the body! Immediately contact a specialist garage to have the twisting removed.

### **WARNING**

Improper use of seat belts increases the risk of serious or fatal injuries.

- Regularly check that the safety belts and related parts are in good condition.
- Always keep seat belts clean.
- Avoid pinching, damaging or chafing the webbing at sharp edges.
- Always keep the belt buckle and slot for the lock tongue free of foreign bodies and liquids.

### Fastening or releasing the safety belt



Fig. 36 Insert the lock tongue of the seat belt into the belt buckle.



Fig. 37 Release the lock tongue from the belt buckle.



First read and observe the introductory information and safety warnings ⚠ on page 52.

Properly fastened and adjusted seat belts hold the occupants in position during a sudden braking manoeuvre or an accident so that they can provide maximum protection ⇒ ⚠.

#### Fastening the seat belt

Fasten and adjust the safety belt before each ride.

- Correctly adjust the front seat and head restraint ⇒ page 44.
- Pull the webbing at the lock tongue evenly over your chest and pelvis. Do **not** twist the webbing ⇒ ⚠.
- Insert the lock tongue firmly into the belt buckle belonging to the seat ⇒ fig. 36.
- Pull on the seat belt to check that it has reliably engaged in the lock.

#### Releasing the seat belt

Release the seat belt only when the vehicle is stationary ⇒ ⚠.

- Press the red button in the belt buckle ⇒ fig. 37. The lock tongue pops out.
- Guide the belt back by hand so that the webbing rolls up easily, the seat belt is not twisted and the trim panel is not damaged. ▶

**⚠ WARNING**

Improper routing of the webbing may cause serious or fatal injuries in the event of an accident.

- Optimal protection by the seat belts can only be achieved when the seat backrest is in an upright position and the seat belt is adjusted properly according to body size.
- Releasing the seat belt during the ride may cause serious or fatal injuries in the event of an accident or sudden braking manoeuvres!

### Routing of the belt webbing

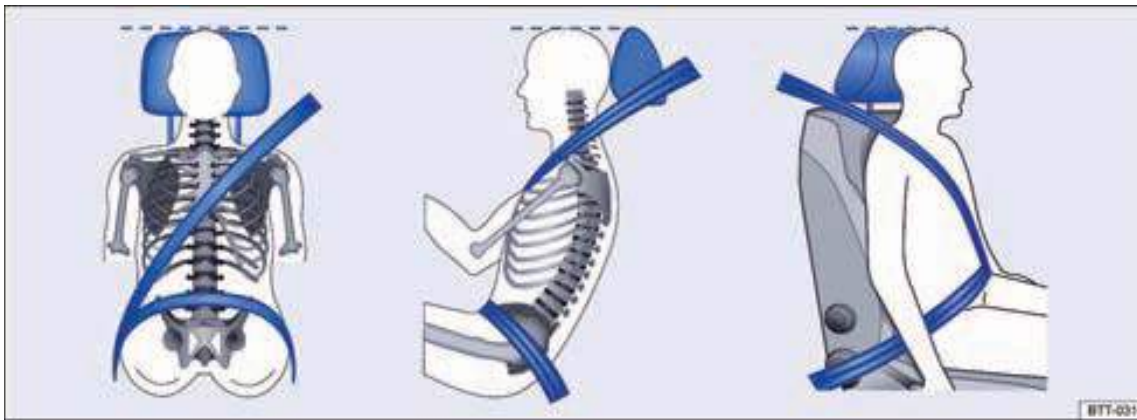


Fig. 38 Correct routing of the belt webbing and correct head restraint adjustment.



Fig. 39 Correct routing of the belt webbing for pregnant women.

 First read and observe the introductory information and safety warnings  on page 52.

Only correct routing of the webbing of fastened seat belts provide maximum protection and reduce the risk of serious or fatal injuries in an accident. In addition, correct routing of the webbing will keep the occupants in position so that a deploying airbag can provide maximum protection. Therefore, always fasten the seat belt and check for correct routing of the webbing.

A wrong seated position can cause serious or fatal injuries ⇒ page 44, Adjusting the seat position.

#### Correct routing of the belt webbing

- The shoulder part of the seat belt should always run across the middle of your shoulder and never across the neck, the arm, under the arm or behind the back.
- The lap part of the seat belt must always run in front of the pelvis and never across the belly.
- The seat belt must always be flat and fit snugly against the body. Tighten the webbing somewhat if necessary.

For **pregnant women**, the seat belt should run evenly over the chest and as low as possible and flat in front of the pelvis so that no pressure is exerted on the lower abdomen - this must be observed during the entire pregnancy ⇒ fig. 39.

#### Adjusting the routing of the webbing to the body size

The routing of the webbing can be adjusted with the following equipment features:

- Seat belt height adjusters for front seats.
- Front seats adjustable for height.

#### WARNING

Improper routing of the webbing may cause serious injuries in the event of an accident or sudden braking and driving manoeuvres.

- Optimal protection by the seat belts can only be achieved when the seat backrest is in an upright position and the seat belt is adjusted properly.
- The seat belt itself, or a loose seat belt, can cause serious injuries if the seat belt is displaced from hard body parts towards soft body parts (e.g., the belly).
- The shoulder part of the seat belt should run across the middle of the shoulder and never under the arm or across the neck.
- The seat belt should fit flat and snugly against the chest.
- The lap part of the seat belt should run in front of the pelvis and never across the belly. The seat belt should fit flat and snugly against the pelvis. Tighten the webbing somewhat if necessary.
- For pregnant women, the lap part of the seat belt should run as low as possible across the pelvis and fit flat around the "round" belly.
- Do not twist the webbing when wearing the seat belt.
- Never hold the seat belt away from the body with your hand.
- Avoid routing the webbing across solid or fragile items such as glasses, pens or keys.
- Never change the routing of the webbing by webbing clamps, eyelets or something similar.



#### Note

Individuals who can not reach the optimal routing of the webbing due to their physical characteristics should consult a specialist garage about possible special installations to obtain the optimal protective effect of seat belts and airbags. Škoda recommends a Škoda partner for this purpose. ■

## Seat belt height adjuster



Fig. 40 At the side of the front seats: Seat belt height adjusters.

 First read and observe the introductory information and safety warnings  on page 52.



The seat belt height adjusters for the front seats make it possible to adapt the routing of the seat belts in the area of the shoulder to match the body size so they can be worn correctly:

- Squeeze and hold the height adjuster in the desired direction of the arrows  $\Rightarrow$  fig. 40.
- Slide the height adjuster up or down such that the seat belt runs across the centre of the shoulder  $\Rightarrow$  page 57.
- Release the height adjuster.
- Abruptly pull on the seat belt to check that the height adjuster has correctly locked in place.

### WARNING

Never adjust the belt height while driving.

## Inertia reel

 First read and observe the introductory information and safety warnings  on page 52.

The seat belts in the vehicle are part of the vehicle safety concept  $\Rightarrow$  page 63:

## Inertia reel

The seat belts on driver's and front passenger seats and on the rear outer seats are equipped with an inertia reel on the shoulder part of the seat belt. When slowly pulling on the seat belt or in normal driving, the shoulder part of the seat belt provides full freedom of movement. During rapid pulling on the seat belt, sudden braking, driving downhill, in curves and during acceleration, however, the inertia reel blocks the seat belt.

## Airbag system

### Introduction

This chapter contains information on the following subjects:

Indicator light .....	62
Description and function of the airbags .....	62
Front airbags .....	64

The vehicle is equipped with front airbags for the driver and front passenger. The front airbags can provide additional protection for the thorax and head of the driver and the front passenger if the seats, the seat belts, head restraints, and – for the driver – the steering wheel are properly adjusted and used. Airbags are only designed for added protection. Airbags are not a substitute for seat belts, which must always be worn, even when the front seats are equipped with front airbags.

#### Additional information and warnings:

- Driving Tips ⇒ page 26
- Correct seated position ⇒ page 44
- Seat belts ⇒ page 52
- Child seats (optional) ⇒ page 66
- Maintaining and cleaning the interior ⇒ page 156
- Accessories, spare parts, repairs and modifications ⇒ page 172
- Consumer information ⇒ page 179

#### WARNING

Never rely solely on the airbag system to protect yourself.

- Even if an airbag deploys, it provides only supporting protection.
- The airbag system protects best with properly applied seat belts and reduces the risk of injury ⇒ page 52, Seat belts.
- Before each journey, each occupant must always assume the correct seated position and correctly fasten the seat belt belonging to his or her seat and keep it properly fastened during the ride. This applies to all passengers.

#### WARNING

Objects located between the occupants and the airbag deployment area increase the risk of injury when the airbags deploy. This would change the deployment area of the airbags or the objects would be thrown against the body.

- Never hold objects in your hands or take them along on your lap during the ride.
- Never carry any objects in the passenger seat. The objects may enter the deployment area of the airbags in sudden braking or driving manoeuvres and be thrown dangerously through the interior should the airbags deploy.
- No other people, pets or objects may be present between the occupants in the front seats and rear outer seats and the airbag deployment area. Make sure that this is respected also by children and passengers.

#### WARNING

The protective function of the airbag system is only sufficient to activate the airbags once. If airbags have been deployed, the system must be replaced.

- Deployed airbags and affected system parts must be immediately replaced with new parts that are approved by Škoda for the vehicle.
- Repairs and modifications to the vehicle may only be performed by a specialist garage. Specialist garages have the necessary tools, diagnostic equipment, repair information and qualified personnel.
- Never install any airbag parts in the vehicle that have been removed from old cars or have been recycled.
- Never modify any components of the airbag system.

#### WARNING

A fine dust may be produced when the airbags deploy. This is normal and is not an indication of a fire in the vehicle.

- The fine dust may irritate the skin and mucous membranes of the eyes and cause breathing difficulties, especially in people suffering or having suffered from asthma or other health effects of breathing. To reduce breathing difficulties, get out of the vehicle or open the windows or doors for fresh air to breathe.
- After contact with the dust, wash your hands and face with mild soap and water before the next meal.

**⚠ WARNING (Continued)**

- Do not let the dust get into the eyes or open wounds.
- Rinse eyes with water if dust has got into them.

**⚠ WARNING**


Solvent-based cleaning agents cause the surface of the airbag modules to become porous. In an accident with airbag deployment, plastic parts coming loose may cause serious injuries.

- Never use solvent-based cleaning agents to clean the instrument panel and the surface of the airbag modules.

## Indicator light



First read and observe the introductory information and safety warnings  on page 60.

illuminates	Location	Possible cause	Remedy
	Instrument cluster.	Airbag system disturbed.	Visit a specialist garage and have the system checked immediately.

When switching on the ignition, some warning and indicator lights illuminate briefly as a function test. They will extinguish after a few seconds.



### DANGER

If the airbag system is defective, the airbag may not deploy properly, not at all, or unexpectedly, which can cause serious or fatal injuries.

- Have the airbag system checked immediately by a specialist garage.
- Never install a child seat in the passenger seat or remove the existing child seat! The front passenger airbag could deploy in an accident despite the disturbance.



### NOTICE

Always take notice of illuminated indicator lights and corresponding descriptions and instructions to avoid vehicle damage.

## Description and function of the airbags



First read and observe the introductory information and safety warnings  on page 60.

The airbag can protect the vehicle occupants in an accident by damping the movement of the occupants in frontal collisions in the direction of impact.


Each deployed airbag is inflated by a gas generator. This break opens the respective airbag covers and the airbags deploy under high force in milliseconds in their deployment areas. When an occupant wearing a seat belt sinks into the inflated airbag, the contained gas escapes to support and decelerate the occupant. This reduces the risk of serious and fatal injuries. Other injuries such as swelling,

bruises and abrasions can not be excluded by the deployed airbag. The inflation of the deployed airbag may also generate friction heat. Airbags do not protect the arms and lower body parts.

The most important factors for deploying the airbag are the type of accident, the impact angle, the vehicle speed and the nature of the object with which the vehicle collides. Airbags therefore do not deploy in case of every visible vehicle damage.

Whether or not an airbag is deployed depends on the vehicle's deceleration rate caused by the impact, which is registered by an electronic control unit. If the value of the deceleration rate is below the reference value programmed in the control unit, the airbags are not deployed despite possible serious damage to the vehicle by an accident. The vehicle damage, repair costs or even the lack of damage to the vehicle in an accident must be no indication whether an airbag should deploy or not. Since the situations of different collisions can vary widely, it is impossible to define a range of vehicle speeds and reference values. Therefore, it is not possible to cover every conceivable kind of impact and impact angle that would lead to deploy the airbags. Important factors for deploying the airbags include the nature of the object (hard or soft) with which the vehicle collides, the impact angle and vehicle speed.


Airbags are used only as a supplement to the three-point seat belts in certain accident situations, if the deceleration of the vehicle is high enough to deploy the airbags. Airbags deploy only once and only under certain conditions. The seat belts are always there to provide protection in such situations in which airbags should not deploy or if they have already deployed. For example, if the vehicle is collided after the first collision with another vehicle or is hit by another vehicle.

The airbag system is part of the total passive vehicle safety concept. The best possible protection by the airbag system can only be achieved in conjunction with properly applied seat belts and a correct seated position  ⇒ page 44. ▶



### Components of the vehicle safety concept

The following safety equipment in the vehicle form the vehicle safety concept to reduce the risk of serious and fatal injuries. Some equipment may not be installed in the vehicle or not available in some markets.

- Optimised seat belts on all seats.
- Seat belt height adjusters for front seats.
- Front airbags for driver and front passenger.
- Airbag indicator light .
- Control units and sensors.
- Height adjustable head restraints that are optimised for rear impact.
- Adjustable steering column.

### Situations in which the front airbag does not deploy:

- If the ignition is switched off in a collision.
- If the deceleration measured by the control unit is too low for collisions at the front end.
- In rear-end collisions.
- In a rollover.
- If the impact speed is lower than the required reference value in the control unit. ■

## Front airbags



Fig. 41 Installation position and deployment area of the driver's front airbag.

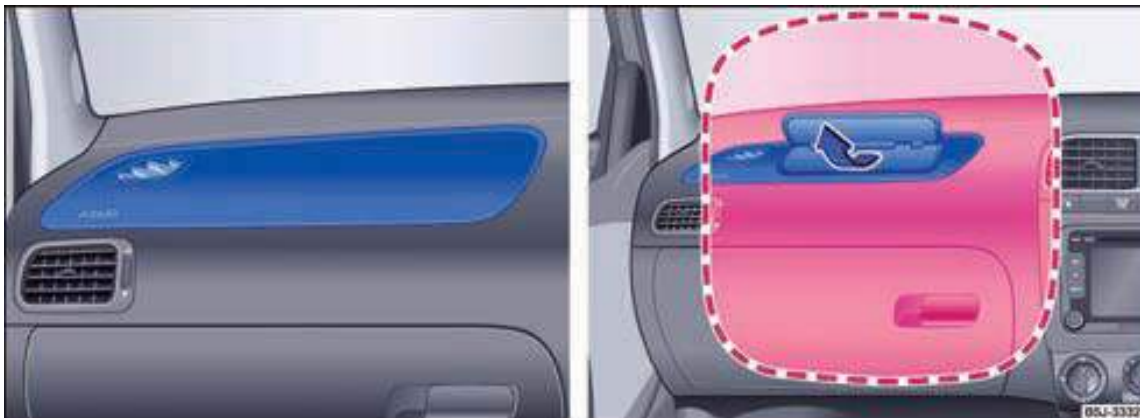



Fig. 42 Installation position and deployment area of the front passenger airbag.

 First read and observe the introductory information and safety warnings  on page 60.

The front airbag system is complementary to the three-point seat belts and offers additional protection for the head and chest area of the driver and front passenger in the event of a frontal collision with greater severity. Always maintain the

greatest possible distance to the front airbag ⇒ page 44. As a result, the front airbags are able to inflate fully in the event they are deployed, thereby providing maximum protection.

The front airbag for the driver is located in the steering wheel ⇒ fig. 41 and the front airbag for the passenger in the instrument panel ⇒ fig. 42. The airbag installation locations are indicated by the lettering "AIRBAG". ▶

The red-boxed areas ⇒ [fig. 41](#) and ⇒ [fig. 42](#) are covered by the deploying front airbags (inflation area). Therefore, objects should never be stored or secured in these areas ⇒ . The factory-mounted attachments are not reached by the deploying driver and front passenger airbags, such as the base plate for the mobile phone holder.

When the driver and front passenger airbags are inflated, the airbag covers are folded out from the steering wheel ⇒ [fig. 41](#) or the instrument panel ⇒ [fig. 42](#), respectively. The airbag covers remain attached to the steering wheel or the instrument panel.

### DANGER

The inflation of a deployed airbag occurs in a split second and at very high speed.

- Always leave the inflation areas of the front airbags free.
- Never attach any objects to the covers and in the deployment area of the airbag modules, such as cup holders or mobile phone mounts.
- There must be no other persons, pets or objects between the front seat occupants and the airbag deployment area.
- Do not attach any objects to the windscreen above the front passenger airbag.
- Do not laminate, coat or otherwise cover the padded centre of the steering wheel and foamed surface of the front airbag module in the instrument panel on the passenger side.

### WARNING

The front airbags deploy in front of the steering wheel ⇒ [fig. 41](#) and the instrument panel ⇒ [fig. 42](#).

- Always hold the outer edge of the steering wheel with both hands while driving: in the 9 o'clock and 3 o'clock positions.
- Adjust the driver's seat such that at least 10 inches (25 cm) are between your chest and the steering wheel centre. If this requirement can not be met due to physical characteristics, be sure to consult a specialist garage.
- Adjust the front passenger seat such that the maximum distance between the front passenger and the instrument panel is obtained.

## Child seats (accessories)

### Introduction

This chapter contains information on the following subjects:

General information on carrying children in the vehicle .....	66
Using a child seat in the front passenger seat .....	68
Using a child seat in the rear seats .....	69
Fastening a child seat with the seat belt .....	69

Before carrying infants and children with a child seat in the front passenger seat, it is imperative to study the information on the airbag system completely.

This information is very important for the safety of the driver and all passengers, especially of infants and young children.

Škoda recommends the use of child seats in the accessories program of Škoda. These child seats are designed and tested for use in vehicles from Škoda. Child seats with various mounting systems are available from Škoda partners.

#### Additional information and warnings:

- Airbag system ⇒ page 60

### General information on carrying children in the vehicle

 **First read and observe the introductory information and safety warnings  on page 66.**

Regulations and statutory provisions always have priority over the descriptions in this Owner's Manual. There are various standards and regulations for the use of child seats and their attachment facilities. For example, in some countries, the use of child seats on certain seats in the vehicle may be prohibited.

#### WARNING

Unsecured children and not properly secured children can suffer serious or fatal injuries during the ride.

- Never place a rearward-facing child seat in the passenger seat when the front passenger airbag is enabled.
- Children until the age of 12 should always be carried in the rear seat.
- Children should always be secured in the vehicle with an approved and appropriate restraint system according to their size and weight.
- Always verify that children wear their seat belts correctly and take a correct seated position.
- Adjust the seat backrest in an upright position, if a child seat is used on the seat.
- Pay attention to the correct routing of the belt webbing.
- Never carry children or babies on the lap or hold them in the arms during the ride.
- Only one child may be secured in a child seat.
- Read and follow the instruction manual of the child seat manufacturer.

#### WARNING

In a sudden braking or driving manoeuvre or in an accident, a loose, unused child seat may fly around inside the vehicle, causing injury.

- Always firmly secure an unused child or stow it in the boot before driving.

#### Note

After an accident, replace the affected child seat, because non-visible damage may have occurred. ■

The rules of physics, the effects on the vehicle in a collision or other type of accident also apply to children ⇒ page 52. In contrast to adults and adolescents, the muscles and bones of children, however, are not yet fully developed. Children are at a greater risk of serious injury in an accident than adults. ►

Since the bodies of children are not fully developed, restraint systems must be used for children, which are specially adapted to their size, weight and body type. Many countries have laws requiring the use of approved child seat systems for infants and toddlers.

Use only child seats that are suitable, released and approved for the vehicle. If in doubt, always contact a Škoda partner or a specialist garage.

### Checklist

Carrying children in the vehicle ⇒ :

- ✓ Follow the country-specific statutory provisions.
- ✓ Škoda recommends to carry children under 12 years always in the rear seats.
- ✓ A child should be carried in the front passenger seat in exceptional cases only ⇒ page 68. The safest place in the vehicle is on the rear seat bench behind the front passenger seat.
- ✓ Always secure a child in the vehicle in a restraint system. The restraint system must be suitable for the size, weight and body type of the child.
- ✓ Only one child may be carried in a child seat.
- ✓ Follow the instruction manual of the child seat manufacturer and always keep it in the vehicle.
- ✓ When attaching the child seat with a seat belt, route the belt through or around the child seat as described by the child seat manufacturer.
- ✓ Pay attention to the correct routing of the belt webbing and maintaining the correct seated position for the child.
- ✓ A child seat is mounted best behind the passenger seat in the rear seat, so that children can get out on the pavement side.
- ✓ Do not allow toys or other objects loosely in the child seat or the regular seat during the ride.

### Country-specific standards for child seats (selection)

The child seats must comply with the ECE-R 44<sup>1)</sup> standard. For more information, contact a Škoda partner or visit [www.skoda-auto.com](http://www.skoda-auto.com).

### Classification of the child seats according to ECE-R 44

Weight group	Weight of the child	Age
Group 0	up to 10 kg	up to approx. 9 months
Group 0+	up to 13 kg	up to approx. 18 months
Group 1	9 to 18 kg	approx. 8 months to 3 1/2 years
Group 2	15 to 25 kg	approx. 3 to 7 years
Group 3	22 to 36 kg	approx. 6 to 12 years

Not every child fits in the seat of its weight group. Similarly, not every seat fits in every vehicle. Therefore, always check whether the child fits properly in the child seat and whether the seat can be securely fastened in the vehicle.

Child seats which were tested according to the ECE-R 44 standard carry an ECE-R 44 test seal: a large E within a circle with the test number below. ►

<sup>1)</sup> ECE-R: Economic Commission for Europe Regulation.

**⚠ WARNING**

Non-compliance with the checklist, which is for your own safety, can lead to accidents and injuries.

- Follow the checklist and carry out the actions.

**⚠ WARNING**

The rear seat is, in principle, the safest place in an accident for children that are correctly secured with seat belts.

- An appropriate child seat which is properly installed and used on one of the rear seats provides, in most accident situations, the best protection for children up to age 12.

### Using a child seat in the front passenger seat



First read and observe the introductory information and safety warnings ⚠ on page 66.

Not all countries permits carrying children in the front passenger seat. And not every child seat is approved for use in the front passenger seat. Contact a Škoda partner to obtain an updated list of all licensed child seats. Use only child seats that are approved for the vehicle.

An enabled front airbag on the front passenger side poses a very high risk for a child. The front passenger seat is life-threatening for a child if the child is carried in a child seat that is facing rearward, opposite to the driving direction.

A rearward-facing child seat in the front passenger seat can be hit by the deploying front passenger airbag with such a large force that life-threatening or fatal injuries may be the result ⇒ ⚠. Therefore, **never** use a rearward-facing child opposite to the driving direction in the passenger seat with the passenger front airbag enabled!

Use a rearward-facing child seat opposite to the driving direction in the front passenger seat only if it is ensured that the front passenger airbag is disabled. **The front passenger airbag can be disabled only by a Škoda partner or a specialist garage.**

If the front passenger airbag is not disabled, it is not permitted to carry a child in the front passenger seat ⇒ ⚠.

With a child seat in the front passenger seat, be sure to observe the following points:

- For a rearward-facing child seat opposite to the driving direction, the front passenger airbag **must** be disabled ⚠ ⇒ page 60.
- The seat backrest of the front passenger seat must be adjusted in the vertical position.
- The front passenger seat must be pushed fully to the back.
- A height-adjustable front passenger seat must be placed in the top position.
- The belt height adjuster of the seat belt must be in the highest position.

#### Suitable child seats

The child seat must be approved by the manufacturer specifically for use in the passenger seat in vehicles with front airbags.

In the front passenger seat, **universal child seats** according to ECE-R 44 group 0, 0+, 1, 2 or 3 may be installed.

**⚠ DANGER**

An installed child seat in the front passenger seat increases the risk of life-threatening or fatal injuries for the child in the event of an accident. **Never use a rearward-facing child seat in the front passenger seat when the front passenger airbag is enabled. The child may be killed when the front airbag deploys, since the child seat is hit with full force by the deploying airbag and is smashed against the seat backrest.**



**⚠ DANGER**

If you need to transport a child in the front passenger seat with the back towards the driving direction, note the following:

- Have the front passenger airbag disabled.
- The child seat must be approved by the child seat manufacturer for use in the front passenger seat with a front airbag.
- Follow the installation instructions of the child seat manufacturer and observe the warnings.
- Move the front passenger seat in the forward/back direction fully back and vertically to its top position to achieve the greatest possible distance from the front airbag.
- Adjust the seat backrest in an upright position.

- ⚠ DANGER (Continued)**
- Adjust the belt height adjuster to its top position.
  - Children should always be secured in the vehicle with an approved and appropriate restraint system according to their size and weight.



### Using a child seat in the rear seats

 First read and observe the introductory information and safety warnings  on page 66.

### Fastening a child seat with the seat belt




Fig. 43 Child seat group 0/0+, group 1, group 2, and group 3

 First read and observe the introductory information and safety warnings  on page 66.

Child seats specified as **universal** on the orange label may be fastened with the seat belt in the seats that are marked with a u in the table.

Weight group	Front passenger seat	Outer seats in the rear seat bench
<b>Group 0</b> up to 10 kg	u	u
<b>Group 0+</b> up to 13 kg	u	u
<b>Group 1</b> 9 up to 18 kg	u	u

When attaching a child seat in the rear seat bench, the position of the front seat must be adapted such that the child has sufficient space. Consequently, adjust the front seat to the size of the child seat and the size of the child. Also consider the correct seated position of the front passenger  ⇒ page 44.

#### Suitable child seats

In the rear passenger seats, **universal child seats** according to ECE-R 44 group 0, 0 +, 1, 2 or 3 may be installed.

Weight group	Front passenger seat	Outer seats in the rear seat bench
<b>Group 2</b> 15 up to 25 kg	u	u
<b>Group 3</b> 22 up to 36 kg	u	u

#### Fastening a child seat with the seat belt

- When mounting in the front passenger seat.
- Read and follow the instructions of the child seat manufacturer.
- Slide the seat all the way back ⇒ page 44.
- Place the child seat in the seat according to the instructions of the child seat manufacturer.
- The belt height adjuster of the seat belt must be in the highest position.
- Apply the safety belt or route it through the child seat according to the instructions of the child seat manufacturer.

- Make sure that the seat belt is not twisted.
- Insert the lock tongue into the belt buckle belonging to the seat until it clicks into place.
- The upper webbing must fit firmly and completely against the child seat.
- Test-pull on the safety belt – it should no longer be possible to pull out the lower webbing.

#### Removing the child seat

Release the seat belt only when the vehicle is stationary ⇒ ⚠.

- Press the red button in the belt buckle. The lock tongue pops out.
- Guide the belt back by hand so that the webbing rolls up easily, the seat belt is not twisted and the trim panel is not damaged.
- Take out the child seat from the vehicle.



#### WARNING

Releasing the seat belt during the ride may cause serious or fatal injuries in the event of an accident or sudden braking and driving manoeuvre!

- Release the seat belt only when the vehicle is stationary.



## Lights and visibility

### Lights

#### Introduction

This chapter contains information on the following subjects:

Indicator lights .....	71
Turn signal and main beam lever .....	72
Switching lights on and off .....	73
Lights and visibility - parking lights .....	73
Masking the headlights .....	74
Headlight beam adjustment .....	74
Interior lighting and reading lights .....	74

Observe the country-specific statutory provisions for the use of vehicle lighting.  
The driver is always responsible for the correct headlight setting and driving light.

#### Additional information and warnings:

- Exterior views ⇒ page 6
- Bulb replacement ⇒ page 203




#### WARNING

Headlights that are set too high and improper use of the main beam can distract and dazzle other road users. This can cause accidents and serious injuries.

- Always make sure that the headlights are properly set.
- Never use the main beam or headlight flasher, if other road users can be dazzled.

#### Indicator lights

 First read and observe the introductory information and safety warnings  on page 71.

Illuminates	Possible cause	Remedy
	illuminates: Driving lights failed partially or completely.	⇒ page 203
	Turn signal, left or right. The indicator light flashes at twice its normal rate if a turn signal fails on the vehicle.	Check the lighting of the vehicle where appropriate.
	Main beam switched on or headlight flasher operated.	⇒ page 72.

When switching on the ignition, some warning and indicator lights illuminate briefly as a function test. They will extinguish after a few seconds.

#### WARNING

Ignoring illuminated warning lights and text messages may result in breaking down in traffic, accidents and serious injury.

- Never ignore illuminated warning lights and text messages.
- Stop the vehicle as soon as it is possible and safe to do so.
- Park the vehicle in a safe distance from moving traffic such that no parts of the exhaust system come in contact with highly flammable materials under the vehicle such as dry grass, fuel, oil, etc.
- A broken-down vehicle is a high accident risk to itself and other road users. If necessary, turn on the hazard warning light system and place the warning triangle on the side of the road to warn other road users.

#### NOTICE

Ignoring illuminated indicator lights and text messages may lead to vehicle damage.

## Turn signal and main beam lever

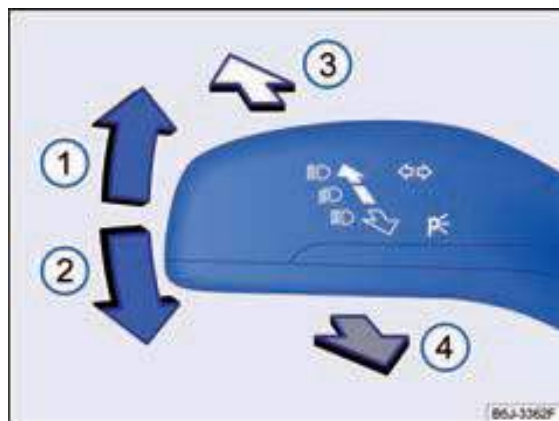


Fig. 44 Turn signal and main beam lever in basic position.

First read and observe the introductory information and safety warnings on page 71.

Move the lever to the desired position:

- ① Operate the right turn signal. With the ignition off, right parking light  $\Rightarrow$  page 73.
- ② Operate the left turn signal. With the ignition off, left parking light  $\Rightarrow$  page 73.

- ③ Main beam on  $\Rightarrow$  . The indicator light is lit in the instrument cluster.
- ④ Operate the headlight flasher. The *headlight flasher* remains on as long as the lever is pulled. The indicator light is lit.

Move the lever to its basic position to turn off the function.

### Convenience flashing

For convenience flashing, only move the lever up or down to the pressure point and release the lever. The turn signal flashes three times. This feature can be disabled by a specialist garage.

### WARNING

Incorrect use of the main beam can cause accidents and serious injuries since the main beam may distract and dazzle other road users.

### Note

The turn signal lights work only with the ignition switched on. The warning signal also works with the ignition off  $\Rightarrow$  page 185.

### Note

If a turn signal light fails on the vehicle, the indicator light flashes twice the normal rate.

### Note

The *main beam* can be turned on only when the low beam is switched on. ■

## Switching lights on and off

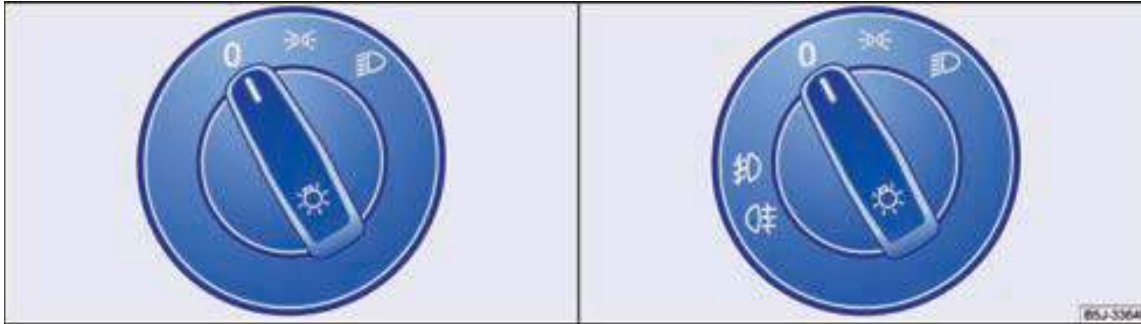


Fig. 45 Beside the steering wheel: Representation of two versions of the light switch.

First read and observe the introductory information and safety warnings on page 71.

Observe the country-specific statutory provisions for the use of vehicle lighting.

Turn the light switch to the desired position  $\Rightarrow$  fig. 45:

	with ignition off	with ignition on
0	Fog lights, low beam and side lights off.	Fog lights, low beam and side lights off
	Side lights on.	Side lights on.
	Low beam off - side lights may remain on for some time.	Low beam switched on.

### Fog lights:

The indicator lights and in the light switch additionally indicate the fog lights that are switched on.

- Switching on the fog lights: Pull out the light switch from position or .
- Switching off the fog lights: Press or turn the light switch in position 0.

### Warning signal if lights are not switched off

When the vehicle key is removed from the ignition lock and the driver's door is open, a warning signal sounds under the following conditions. This reminds you to switch off the lights.

- With the parking lights switched on.
- Light switch in position .
- Light switch in position .

### WARNING

The side lights are not bright enough to light up the road sufficiently and to be seen by other road users.

- Always switch on the low beam when it is dark, if it rains and if visibility is poor.

## Lights and visibility - parking lights

First read and observe the introductory information and safety warnings on page 71.

### Parking lights

When the parking lights (left or right turn signals) are selected, the headlight with side light and rear light on the appropriate side of the vehicle are switched on. The parking light function only operates if the ignition is switched off.

### WARNING

Accidents can be caused if the road is not sufficiently illuminated and the vehicle is not seen by or hard to see for other road users.

**Note**

In cool or wet weather conditions, the headlights as well as the taillights and turn signals may become temporarily fogged inside. This is normal and has no influence on the life of the lighting system of the vehicle.

**Masking the headlights**

First read and observe the introductory information and safety warnings  on page 71.

When driving in countries in which the traffic drives on the other side of the road than in your home country, the asymmetrical low beam may dazzle oncoming drivers. Therefore, when travelling abroad, certain areas of the headlight lenses may need to be masked with foils or converted by a specialist garage.

More information is available from a specialist garage. Škoda recommends a Škoda partner for this purpose.

**Note**

The use of foils on the headlights is permitted only if they are used for a short period of time. For a permanent conversion, see a specialist garage. Škoda recommends a Škoda partner for this purpose.


**Headlight beam adjustment**

Fig. 46 Beside the steering wheel: Control for headlight beam adjustment ①.



First read and observe the introductory information and safety warnings  on page 71.

**① Headlight beam adjustment**

With the headlight beam adjustment  $\Rightarrow$  fig. 46 ①, the driver is able to adjust the beam of the headlights continuously depending on the vehicle load. This allows the driver to obtain best visibility without dazzling oncoming traffic  $\Rightarrow$  .

The headlights can be regulated only when the low beam is switched on.

To adjust, turn control  $\Rightarrow$  fig. 46 ①:

Setting	Vehicle load <sup>a)</sup>
-	Front seats occupied, boot empty.
1	All seats occupied, boot empty.
2	All seats occupied, boot loaded until reaching the permissible rear axle load.
3	Only driver's seat occupied, boot loaded until reaching the permissible rear axle load.

a) Intermediate settings of the control are possible for differing vehicle loadings.


**WARNING**



Heavy objects in the vehicle can cause the headlights to dazzle and distract other road users. This can cause accidents and serious injuries.

- Always adjust the beam of light to the load condition of the vehicle so that other drivers are not dazzled.

**Interior lighting and reading lights**

First read and observe the introductory information and safety warnings  on page 71.

Button or position	Function
0	Interior lights off.
	Interior lights on.

Button or position	Function
	Door contact switch on (centre position). Interior lights switch on automatically when the vehicle is unlocked, opening a door or removing the vehicle key from the ignition switch. The light goes off a few seconds after you close all doors when locking the vehicle or switching on the ignition.
	Switching the reading lights on or off.

** Note**

The reading lights go off when you lock the vehicle or after a few minutes when the vehicle key has been removed from the ignition. This prevents discharge of the vehicle battery.

## Sun screen

### Introduction

This chapter contains information on the following subjects:

Sun visors ..... 76

### Sun visors

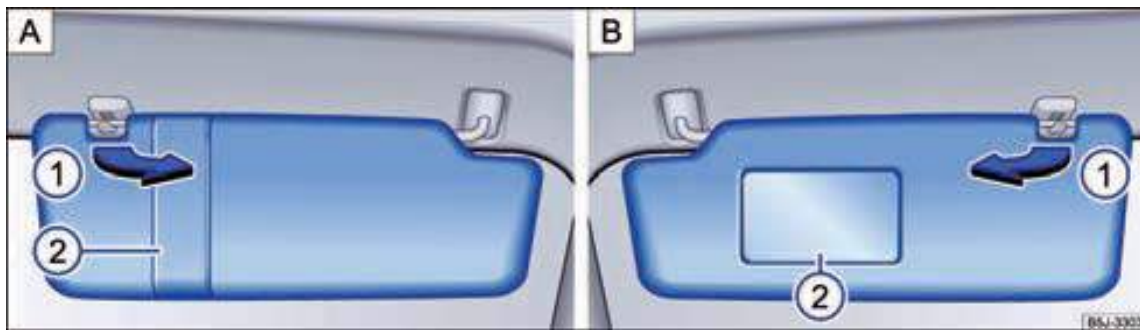


Fig. 47 Sun visors A: Driver's side, B: Passenger side.

First read and observe the introductory information and safety warnings  on page 76.

#### Adjustment options of the sun visors for the driver and front passenger:

- Fold towards the windscreen.
- Pull out of the fixture and swivel towards the doors ① ⇒ fig. 47.

#### Storage

The folded-down sun visor on the driver's side (A) includes an elastic loop (2) to store, e.g., pens and papers.

#### Vanity mirror

The folded-down sun visor on the passenger side (B) may include a vanity mirror (2).

#### WARNING

Folded-down sun visors may reduce visibility.

- Always return sun visors to their fixtures when they are no longer needed.

## Windscreen wipers and washers

### Introduction

This chapter contains information on the following subjects:

Windscreen wiper lever .....	77
Checking and replenishing the windscreen washer fluid level .....	78

#### Additional information and warnings:

- Exterior views ⇒ page 6
- Recirculated air mode of the air conditioning system ⇒ page 117
- Preparing to work in the engine compartment ⇒ page 131
- Maintaining and cleaning the vehicle exterior ⇒ page 148

#### ⚠ WARNING

Windscreen washer fluid without sufficient antifreeze protection may freeze on the windscreen and restrict the view to the front.

- Use the windscreen washer system in cold weather only with sufficient antifreeze protection.
- Never use the windscreen washer system in cold weather as long as the windscreen has not been warmed up with the ventilation system. Otherwise the antifreeze mixture may freeze on the windscreen and restrict visibility.

#### ⚠ WARNING

Worn or dirty wiper blades reduce visibility and increase the risk of accidents and serious injuries.

- Always change wiper blades whenever they are damaged or worn and not able to clean the window sufficiently.

#### ⚠ NOTICE

In frosty weather, before switching on the windscreen wipers, check that the wiper blades are not frozen to the windscreen! When the vehicle is parked in cold weather, the service position of the windscreen wipers may be helpful ⇒ page 152.

## Windscreen wiper lever

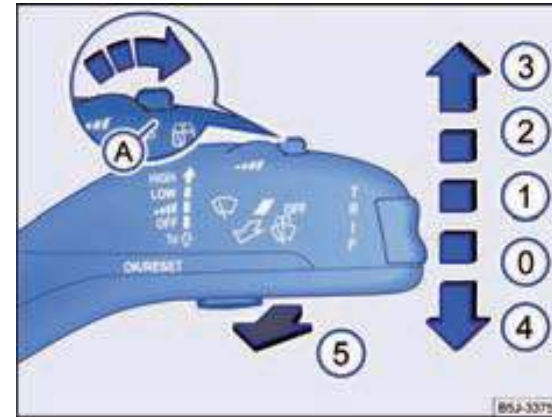


Fig. 48 Operating the windscreen wipers.

First read and observe the introductory information and safety warnings ⚠ on page 77.

Move the lever to the desired position ⇒ ⚠:

- |   |      |  |
|---|------|--|
| ① | OFF  | Windscreen wipers switched off.  |
| ① |      | Intermittent wipe. Set with the switch Ⓐ the desired break between the individual wiper strokes. |
| ② | LOW  | Slow wipe.   |
| ③ | HIGH | Fast wipe.   |
| ④ | fx   | Flick wipe - short wipe.   |
| ⑤ |      | Automatic wash-wipe to clean the windscreen while pulling the lever.                             |

#### ⚠ NOTICE

When the ignition is switched off while the windscreen wipers are on, the windscreen wipers will resume wiping in the same wiper stage when you switch on the ignition again the next time. Frost, snow and other obstructions on the windscreen may damage the windscreen wipers and the wiper motor.

**Note**

The windscreen wipers work only when the ignition is switched on and the bonnet is closed.





### Checking and replenishing the windscreen washer fluid level



Fig. 49 In the engine compartment: Cover of the windscreen washer fluid reservoir.

 First read and observe the introductory information and safety warnings  on page 77.

Regularly check the windscreen washer fluid level and replenish if necessary.

- Open the bonnet  ⇒ page 131.
- The windscreen washer fluid reservoir is indicated by the symbol  on the cover ⇒ fig. 49.
- Check that there is still sufficient windscreen washer fluid in the reservoir.
- To replenish, mix clear water with a windscreen cleaner recommended by Škoda ⇒ . Follow the mixing instructions on the packaging.
- In cold outside temperatures, add a special antifreeze agent to prevent the water from freezing ⇒ .

#### Capacities

The capacity of the windscreen washer fluid reservoir is approximately 5.4 litres.

**WARNING**

Never mix radiator antifreeze or similar unsuitable additives in the windscreen washer fluid. This would form an oily film on the windscreen which impairs visibility significantly.

- Use clean, clear water with a windscreen cleaner recommended by Škoda.
- Where appropriate, add a suitable antifreeze agent to the windscreen washer fluid.

**NOTICE**

- Never mix the cleaning agents recommended by Škoda with other cleaning agents. Otherwise, this could cause flocculation of the ingredients resulting in clogging of the windscreen washer nozzles.
- When replenishing, be sure not to mix up fluids under any circumstances! Otherwise, this could cause severe malfunctions and damage to the engine!



## Mirrors

### Introduction

This chapter contains information on the following subjects:

Interior mirror .....	79
Exterior mirrors .....	79

#### Additional information and warnings:

- Exterior views ⇒ page 6

### Interior mirror

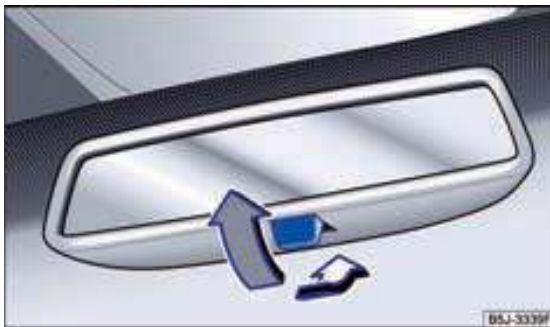


Fig. 50 Manual dimming interior mirror.

First read and observe the introductory information given on page 79.

The driver must always adjust the interior mirror such that adequate visibility to the rear through the rear window is ensured.

#### Manual dimming interior mirror

- Basic position: Lever on the bottom edge of the mirror points toward the wind-screen.
- For dimming, pull the lever back ⇒ fig. 50.

### Exterior mirrors

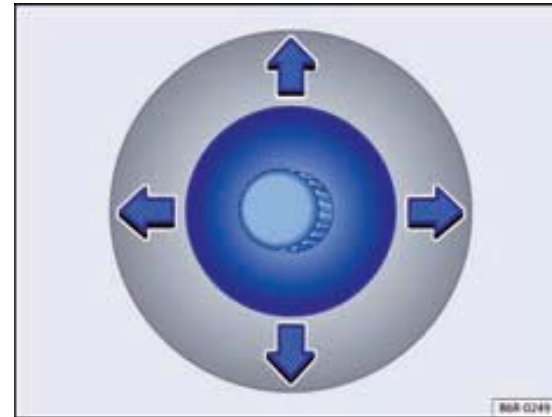


Fig. 51 In the front doors: Control knob for mechanical exterior mirror.

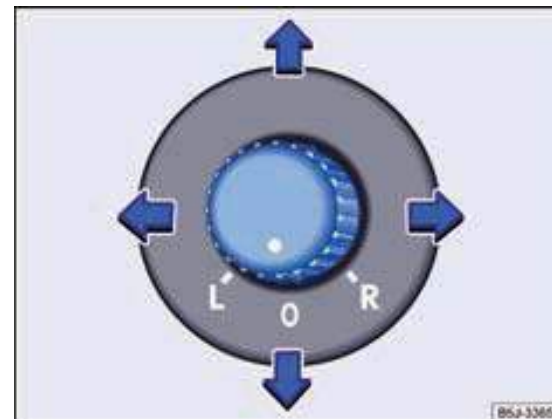


Fig. 52 In the driver's door: Rotary knob for electric exterior mirrors.

First read and observe the introductory information given on page 79.

- The exterior mirrors are adjusted by moving the control knob ⇒ fig. 51 or turning the rotary knob ⇒ fig. 52.


**Turn the rotary knob to the desired position:**

- |          |  |
|----------|--|
| <b>L</b> | Adjust the left exterior mirror by turning the rotary knob to the front, rear, right or left.  |
| <b>0</b> | Zero position. No adjustment of the external mirrors possible.                                 |
| <b>R</b> | Adjust the right exterior mirror by turning the rotary knob to the front, rear, right or left. |

**⚠ WARNING**

Inaccurately estimating the distance to vehicles behind can cause accidents and serious injuries.

- Curved mirror surfaces (convex or aspheric) increase the vision field and make objects in the mirror appear smaller and farther away.
- Using curved mirror surfaces for estimating the distance to vehicles behind when changing lanes is inaccurate and may result in accidents and serious injuries.
- If possible, use the interior mirror for accurately determining the distance to vehicles behind or other objects.
- Ensure that adequate visibility is available to the rear.

 **For the sake of the environment** **Note**

In the case of a malfunction, the electric external mirrors can be adjusted mechanically by hand by pressing on the edge of the mirror surface. ■

## Transporting

### Driving tips

#### Introduction

This chapter contains information on the following subjects:

Stowing luggage .....	82
Driving with the boot lid open .....	82
Driving with a loaded vehicle .....	83
Vehicle-specific weights .....	83

#### The roof luggage rack

The vehicle is not licensed for use of a roof luggage rack. The vehicle is **not** factory-equipped with a roof luggage rack and it can not be retrofitted with a roof luggage rack.

#### Towing a trailer

The vehicle is not approved for towing a trailer. The vehicle is **not** factory-equipped with a towing device and it can not be retrofitted with a towing device.

#### Additional information and warnings:

- Lights ⇒ page 71
- Wheels and tires ⇒ page 160

#### WARNING

Unsecured or improperly secured objects can cause serious injuries in sudden braking and driving manoeuvres and accidents. This is particularly the case when objects are hit by the deploying airbag and thrown through the interior. To reduce the risk of injury, observe the following:

- Store all items in the vehicle securely. Always stow luggage and heavy items in the boot.
- Stow items inside the vehicle in such a way that they can not get into the deployment area of the front airbags during a sudden driving and braking manoeuvre.

#### WARNING (Continued)

- Stow items inside the vehicle in such a way that they can never get into the deployment areas of the airbags.
- Always keep the storage compartments closed during the ride.
- Stowed items may never result in occupants taking a wrong seated position.
- If stowed items block a seat, this seat must never be taken and used by a person.
- Do not stow any hard, heavy or sharp items unsecured in open trays in the vehicle, on the surface behind the rear seat bench or on the instrument panel.
- Remove hard, heavy or sharp items from clothes and bags inside the vehicle and stow them securely.

#### WARNING

The handling and braking performance significantly change when transporting large and heavy items.

- Adjust your speed and driving style to the visibility, weather, road and traffic conditions.
- Use extra care and caution when accelerating.
- Avoid sudden braking and driving manoeuvres.
- Decelerate earlier than usual.

#### WARNING

When the vehicle is unused or unattended, always lock the doors and the boot lid to reduce the risk of serious or fatal injuries.

- Never leave children unattended, especially when the boot lid is open. Children could get into the boot, close the boot lid and would not be able to get out by themselves. This can cause serious or fatal injuries.
- Never allow children to play in or at the vehicle.
- Never carry people in the boot.

**⚠ WARNING**

When transporting heavy items, the handling of the vehicle changes and the stopping distance becomes longer. Heavy cargo, which was not properly stowed or secured, may result in loss of control over the vehicle, causing serious injuries.

- When transporting heavy items, the handling characteristics of the vehicle change due to the displacement of the centre of gravity.
- Always distribute the payload evenly and as low as possible in the vehicle.
- Always securely stow heavy items in the boot as far away as possible from the rear axle.

**⚠ NOTICE**

- The heating elements or the aerial in the rear window can be destroyed by abrasive objects on the stowage area.
- The aerial in the side windows can be destroyed by abrasive objects.

**Stowing luggage**

First read and observe the introductory information and safety warnings ⚠ on page 81.

**Stow all luggage items in the vehicle securely**

- Distribute loads in the vehicle as evenly as possible.
- Place heavy items as far as possible towards the front of the boot.
- Adjust the range of the headlights ⇒ page 71.
- Adjust the tyre pressure according to the load. Observe the tyre inflation pressure label ⇒ page 160.

**⚠ NOTICE**

The heating elements in the rear window can be destroyed by abrasive objects on the stowage area.

**Driving with the boot lid open**

First read and observe the introductory information and safety warnings ⚠ on page 81.

Driving with an open boot lid poses a particular danger. Secure all items and the open boot lid properly and take appropriate measures to reduce the penetration of toxic exhaust gases.

**⚠ WARNING**

Driving with an unlocked or open boot lid can cause serious injuries.

- Always drive with the boot lid closed.
- Stow all items in the vehicle securely. Loose items can fall out of the boot and hurt road users behind.
- Always drive carefully and with special foresight.
- Avoid abrupt or sudden driving and braking manoeuvres since the open tailgate may move uncontrollably.
- Make items extending from the boot visible to other road users. Observe the statutory provisions.
- If items extend from the boot, the boot lid must never be used to "clamp" or "hold" any items.
- In any case, remove any rack mounted on the boot lid, including the cargo, when driving with an open boot lid.

**⚠ WARNING**

Toxic exhaust gases may enter the interior when the boot lid is open. This can lead to unconsciousness, carbon monoxide poisoning, accidents and serious injuries.

- To prevent the penetration of toxic exhaust gases, always drive with the boot lid closed.
- If, in exceptional cases, driving with an open boot lid can not be avoided, do the following to reduce the penetration of toxic exhaust gases into the passenger compartment:
  - Switch off recirculated air mode of the air conditioning.
  - Open all air outlets in the instrument panel.
  - Set the blowers of the air conditioning to the highest blower stage.

**⚠ NOTICE**

The open boot lid changes the height of the vehicle.

## Driving with a loaded vehicle



First read and observe the introductory information and safety warnings  on page 81.

For good handling characteristics of a loaded vehicle, observe the following:

- Stow all luggage items securely  $\Rightarrow$  page 82.
- Use extra care and caution when accelerating.

## Vehicle-specific weights



First read and observe the introductory information and safety warnings  on page 81.

The information in the official registration documents always has priority. All information in this Owner's Manual is for the basic model. The engine that a vehicle is equipped with is indicated on the vehicle data sticker in the service schedule or the official registration documents.

Through optional equipment, different model versions and special vehicles, the specified values may differ.

### Petrol engines

Engine power	MKB	Transmission	Curb weight	Permissible gross weight	Permissible front axle load	Permitted rear axle load
77 kW	CLSA	SG5	1,111 - 1,135 kg	1,680 kg	850 kg	900 kg
		AG6	1,173 - 1,175 kg	1,710 kg	890 kg	900 kg

### Diesel engine


Engine power	MKB	Transmission	Curb weight	Permissible gross weight	Permissible front axle load	Permitted rear axle load
77 kW	CLNA	SG5	1,188 - 1,212 kg	1,760 kg	920 kg	900 kg

- Avoid sudden braking and driving manoeuvres.
- Decelerate earlier than usual.

### WARNING

Slipping cargo items may affect the stability and safety of the vehicle significantly, causing accidents and serious injuries.

- Secure cargo properly against slipping.

The values for the unloaded weight in the table below apply to the road-ready vehicle with a driver (75 kg / 165 lbs), fluids including 90% fuel in the tank, and with tools and spare tyres where appropriate  $\Rightarrow$  . Optional equipment and subsequent installation of accessories increase the specified unloaded weight and reduces the possible payload accordingly.

The payload consists of the following components:

- Passengers.
- Total luggage.

 **WARNING**

Exceeding the maximum permissible weights and axle loads can cause vehicle damage, accidents and serious injuries.

- The actual axle loads must never exceed the permissible axle loads.
- The payload and the distribution of the load in the vehicle have an impact on the handling and braking performance. Adjust your speed accordingly.

 **NOTICE**

Always distribute the payload evenly and as low as possible in the vehicle. When transporting heavy items in the boot, they should be placed before or above the rear axle to minimise the impact on the handling.

## Useful equipment

### Storage facilities

#### Introduction

This chapter contains information on the following subjects:

Storage compartments in the front doors .....	85
Storage compartments in the centre console .....	86
Storage compartment in the front centre armrest .....	86
Storage compartment on the front passenger side .....	87
Other storage facilities .....	87

Storage compartments are to be used only for storing light or small items.

#### Additional information and warnings:

- Maintaining and cleaning the interior ⇒ page 156
- Radio ⇒ Booklet Radio

#### WARNING

Loose objects may fly through the passenger compartment in sudden driving or braking manoeuvres. This can cause serious injuries or loss of control over the vehicle.

- Do not stow pets or hard, heavy or sharp objects in open shelves in the vehicle, on the instrument panel, on the shelf behind the rear seats, clothes and bags inside the vehicle.
- Always keep the storage compartments closed during the ride.

#### WARNING

Objects in the driver's footwell may prevent the full play of the pedals. This may lead to loss of vehicle control, increasing the risk of serious injury.

- Make sure that all the pedals can be depressed without obstruction at any time.
- Always securely fasten the floor mat in the footwell.

#### WARNING (Continued)

- Never use floor mats or other floor coverings over the built-in mat.
- Make sure that no objects can enter the footwell of the driver during the ride.
- Remove any existing objects from the footwell while the vehicle is parked.

#### NOTICE



- The heating elements in the rear window can be destroyed by abrasive objects on the stowage area.
- Do not store heat-sensitive items, food or drugs in the passenger compartment. Heat and cold can damage or render them unusable.
- Objects placed in the vehicle made of transparent materials, such as spectacles, magnifying glasses or transparent suction cups on the windows, may focus the sunlight and thus cause damage to the vehicle.

### Storage compartments in the front doors



Fig. 53 On the driver's side: Storage compartment and cup holder.

 First read and observe the introductory information and safety warnings  on page 85.

The front doors include storage compartments ⇒ fig. 53 in which a 1 l or 1.5 l bottle  and smaller items  (e.g., a safety vest) can be stowed.

### Storage compartments in the centre console



Fig. 54 In the centre console: Front storage compartment.

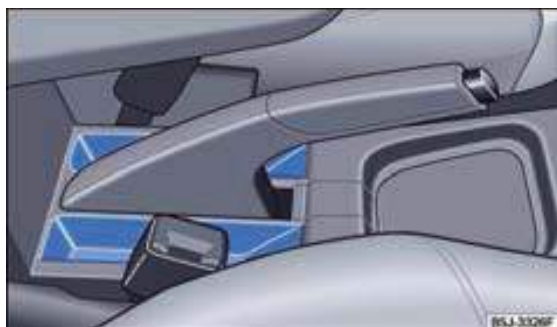


Fig. 55 In the centre console: Storage compartments at the handbrake lever.

 First read and observe the introductory information and safety warnings  on page 85.

There is an open storage compartment in the front centre console  $\Rightarrow$  fig. 54.

Two additional open storage compartments are located next to the handbrake lever  $\Rightarrow$  fig. 55.

### Storage compartment in the front centre armrest



Fig. 56 Storage compartment in the front centre console.

 First read and observe the introductory information and safety warnings  on page 85.

To *open*, press the release button in the centre armrest  $\Rightarrow$  fig. 56 (arrow) and lift the lid fully to the top.

To *close*, fold the lid down.

#### WARNING

The centre armrest may interfere with the movement of the arms of the driver and cause accidents and serious injuries.

- Always keep the storage compartments in the centre armrest closed while driving.

#### WARNING

Never carry a person or a child on the centre armrest.



## Storage compartment on the front passenger side

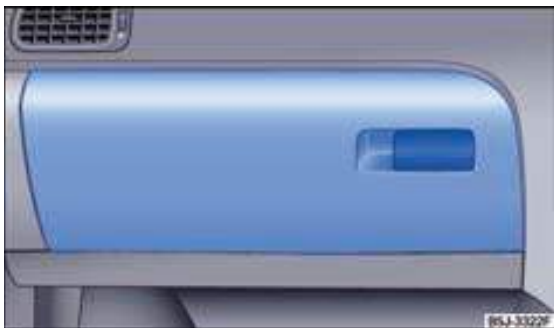


Fig. 57 Storage compartment on the front passenger side.

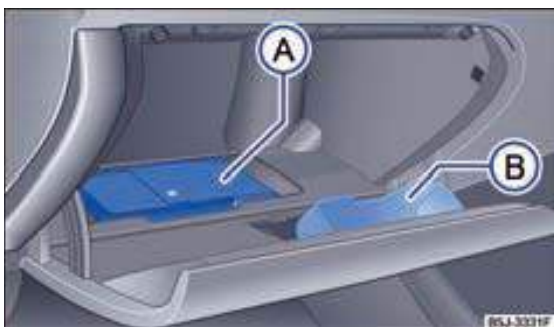



Fig. 58 Open storage compartment on the passenger side.

 First read and observe the introductory information and safety warnings  on page 85.

### Opening and closing the storage compartment

- To *open*, pull the opening lever  $\Rightarrow$  fig. 57.
- To *close*, push the cover upwards.

### Owner's Manual shelf

The Owner's Manual is located at the bottom of the storage compartment  $\Rightarrow$  fig. 58 .

### Glasses storage box

The inside flap of the storage compartment  includes a glasses storage box.

## WARNING

An open storage compartment on the passenger side may increase the risk of serious injuries in the event of an accident or sudden braking and driving manoeuvres.

- Always keep the storage compartment closed during the ride.

## Other storage facilities



Fig. 59 In the passenger side headliner: Clothes hook.

 First read and observe the introductory information and safety warnings  on page 85.

### Clothes hooks in the headliner

The centre door bars and rear grab handles in the headliner are provided with clothes hooks  $\Rightarrow$  fig. 59 (arrows).

### Other storage possibilities:

- In the rear door panels.
- In the pockets of the front seat backs.

 **WARNING**

Clothes hanging from the hooks may restrict the driver's view, thereby causing accidents and serious injuries.

- Always hang clothes on the clothes hooks such that the driver's view is not restricted.
- Always use the clothes hooks in the vehicle for hanging light clothing only. Never leave heavy, hard or sharp objects in the pockets.

## Cup holders

### Introduction

This chapter contains information on the following subjects:

Cup holders in the front centre console .....	89
Cup holders in the rear centre console .....	90

### Beverage bottle holders

Beverage bottle holders for bottles are located in the open storage compartments of the driver's and front passenger's door.

### Additional information and warnings:

- Maintaining and cleaning the interior ⇒ page 156

#### **WARNING**

Improper use of the cup holders can cause injuries.

- Never put hot beverages in a cup holder. During the ride, in a sudden braking manoeuvre or an accident, hot beverages in the cup holder may be spilled and cause scalding.
- Ensure that beverage bottles or other objects can not enter the driver's footwell, impeding the pedals while driving.
- Never place heavy cups, food or other heavy objects into the cup holder. Such heavy objects can fly through the interior causing serious injuries in the event of an accident.

#### **WARNING**

Closed beverage bottles in the vehicle may explode due to heat or burst due to frost.

- Never leave closed beverage bottles in a very hot or very cold vehicle.

#### **NOTICE**

Do not leave open beverages in the cup holder during the ride. Spilled beverages, e.g., when braking, can cause damage to the vehicle and to the electrical system.

#### **Note**

Beverage bottle holders are located in the open storage compartments of the driver's and front passenger's door.

### Cup holders in the front centre console



Fig. 60 In the front centre console: Cup holders.



Fig. 61 In the front centre console: Cup holders folded down.

First read and observe the introductory information and safety warnings ⚠ on page 89.

There are different types of cup holders in the front centre console.

#### Opening and closing the cup holders

To *open*, grab the foldable section ⇒ fig. 60 and fold it forward ⇒ fig. 61.

To *close*, fold the cup holder back to its home position ⇒ fig. 60.

### Cup holders in the rear centre console



Fig. 62 In the rear centre console: Fold out the cup holders.

 First read and observe the introductory information and safety warnings  on page 89.

#### Opening and closing the rear cup holders

- To *open*, fold down the cup holders in the direction of the arrow ⇒ fig. 62.
- To *close*, lift up the cup holders.



## Ashtrays and cigarette lighter

### Introduction

This chapter contains information on the following subjects:

Ashtrays .....	91
Cigarette lighter .....	91

#### Additional information and warnings:

- Power sockets ⇒ page 92
- Accessories, spare parts, repairs and modifications ⇒ page 172
- Consumer information ⇒ page 179

#### WARNING

Improper use of the ashtrays and cigarette lighter can cause fire, burns and other serious injuries.

- Never put paper or other objects in the ashtray, which can cause a fire.

### Ashtrays



Fig. 63 In the front centre console: Closed ashtray.

First read and observe the introductory information and safety warnings ▲ on page 91.

#### Opening and closing an ashtray

- To *open*, lift the cover of the ashtray ⇒ fig. 63.
- To *close*, push down the cover of the ashtray.

#### Emptying an ashtray

- Remove the ashtray from the cup holder from above.
- After emptying the ashtray, insert it into the cup holder from above.

### Cigarette lighter



Fig. 64 In the front centre console: Cigarette lighter.

First read and observe the introductory information and safety warnings ▲ on page 91.

- Press in the button of the cigarette lighter while the ignition is switched on ⇒ fig. 64.
- Wait until the button pops forward.
- Pull out the cigarette lighter and light the cigarette with the glowing heating coil ⇒ ▲.
- Insert the cigarette lighter back into the receptacle.

#### WARNING

Improper use of the cigarette lighter can cause fire, burns and other serious injuries.

- The cigarette lighter may be used only to light cigarettes, cigars, etc. in an appropriate manner.
- Never leave children unattended in vehicles. The cigarette lighter can be used when the ignition is switched on.

#### Note

The cigarette lighter can also be used as a 12-volt power socket ⇒ page 92.

## Power socket

### Introduction

This chapter contains information on the following subjects:

Power socket in the vehicle ..... 92

The power socket in the vehicle can be used to connect electrical accessories.

The connected devices must be in good condition and must not be faulty.

#### Additional information and warnings:

- Cigarette lighter ⇒ page 91
- Accessories, spare parts, repairs and modifications ⇒ page 172
- Consumer information ⇒ page 179

#### ⚠ WARNING

Improper use of the power socket and the electrical accessories can cause fires and other serious injuries.

- Never leave children unattended in vehicles. The power socket and the connected devices can be used when the ignition is switched on.
- If the connected electric device becomes too hot, switch it off and disconnect it from power immediately.

#### ⓘ NOTICE

- To avoid damage to the electrical system, never connect power supplying components, such as solar panels or battery chargers for charging the vehicle battery, to the 12-Volt power socket.
- Only use accessories that have been tested for electromagnetic compatibility in accordance with the applicable directives.
- To prevent damage from power fluctuations, the devices connected to the 12-Volt power socket must be switched off before you switch the ignition on or off and before starting the engine.
- Never connect electrical devices to a 12-Volt power socket that consume more than the specified watts. Exceeding the maximum power consumption may damage the electrical system of the vehicle.

#### ♻ For the sake of the environment

Do not keep the engine running while the vehicle is stationary.

#### ⓘ Note

The vehicle battery will discharge when the ignition is switched on while the engine is stopped and electrical accessories are being used.

#### ⓘ Note

Unshielded devices can cause interference to the radio and to the vehicle electronics.

#### ⓘ Note

There may be interference in the AM band of the radio if electrical devices are used near the rear window aerial.

### Power socket in the vehicle



Fig. 65 Front centre console: 12-Volt power socket.

📖 First read and observe the introductory information and safety warnings ⚠ on page 92.

#### Maximum power consumption

Power socket	Maximum power consumption
12 Volt	120 Watt

The maximum power consumption of the power socket must not be exceeded. The power consumption of devices is indicated on their type plates.

The total power consumption of all connected electrical devices when connecting multiple devices simultaneously may not exceed 190 Watt ⇒ ⓘ ▶

### 12-Volt power socket

The 12-Volt power socket will only work when ignition is switched on.

The vehicle battery will discharge when the ignition is switched on while the engine is stopped and electrical devices are being used. Therefore, use electrical consumers on the power socket only with the engine running.

Switch off the connected devices before you switch the ignition on or off and before starting the engine, to avoid damage from voltage fluctuations.

The 12-Volt power socket is located in the front centre console.

#### NOTICE

- Follow the instructions manuals of the connected devices!
- Never exceed the maximum power consumption, otherwise the entire vehicle electrical system can be damaged.
- 12-Volt power socket:
  - Only use accessories that have been tested for electromagnetic compatibility in accordance with the applicable directives.
  - Never feed power into the socket.
  - Do not pour liquids into the power socket.

## When driving

### Starting, shifting gears, parking

#### Starting and stopping the engine

##### Introduction

This chapter contains information on the following subjects:

Ignition lock .....	95
Starting the engine .....	96
Switching off the engine .....	97
Electronic immobiliser .....	97

##### Immobiliser

The engine cannot be started if the vehicle key is invalid or the immobiliser has an operational fault.

##### Push-starting

For technical reasons, the vehicle must **never** be push-started. Jump-start instead.

##### Additional information and warnings:

- Vehicle key set ⇒ page 32
- Shifting gears ⇒ page 98
- Braking, stopping and parking ⇒ page 104
- Steering ⇒ page 115
- Refuelling ⇒ page 123
- Fuel ⇒ page 127
- Emergency closing or opening ⇒ page 187
- Jump-starting ⇒ page 209
- Tow-starting and towing the vehicle ⇒ page 212

#### WARNING

Switching off the engine while driving makes it harder to stop the vehicle. This may result in the loss of vehicle control, causing accidents and serious injuries.

- The brake-assist systems, the airbag system and other safety equipment in the vehicle are only active when the engine is running.
- Switch off the engine only when the vehicle is stationary.

#### WARNING

The risk of serious injuries can be reduced when the engine is running or when starting the engine.

- Never start or run the engine in unventilated or closed rooms. The engine exhaust gases contain, among others, carbon monoxide, an odourless and colourless toxic gas. Carbon monoxide can cause unconsciousness and death.
- Never leave the vehicle unattended with the engine running. The vehicle could move suddenly, or an unexpected event may occur which may cause damage or serious injury.
- Never use a start booster. A start booster may explode and cause a sudden revving of the engine.

#### WARNING

The parts of the exhaust system become very hot. This may cause fires and serious injuries.

- Never park the vehicle such that parts of the exhaust system come in contact with highly flammable materials under the vehicle, such as underbrush, leaves, dry grass, spilled fuel, etc.
- Never use additional underbody protection or anti-corrosion agents for exhaust pipes, catalytic converters and heat shields.



## Ignition lock



Fig. 66 Positions of the vehicle key in the ignition lock.



First read and observe the introductory information and safety warnings  on page 94.

### Vehicle key $\Rightarrow$ fig. 66.

No vehicle key in the ignition lock: Steering lock active.

- ① Ignition switched off. The vehicle key can be pulled out.
- ① Ignition switched on. Diesel engine is preheated. Steering lock can be released.
- ② Starts the engine. Major electrical loads are temporarily switched off. Release the vehicle key, when the engine has started. The released vehicle key will return to position ①.

To make a theft of the vehicle more difficult, the steering should always be locked before you exit the vehicle.

### Activating the steering lock feature

- Remove the vehicle key from the ignition lock.
- Turn the steering wheel slightly until the locking bolt of the steering clicks in to place.

### Deactivating the steering lock feature

- Turn the steering wheel slightly to relieve the steering lock.
- Insert the vehicle key into the ignition lock.
- Hold the steering wheel in this position and turn the ignition key from position ① to position ②.

### Non-authorized ignition key

If a non-authorized vehicle key was inserted into the ignition lock, it can be removed as follows:


- *Automatic gearbox:* The vehicle key cannot be removed immediately from the ignition lock. Press and release the lock button in the selector lever. The vehicle key can be pulled out.
- *Manual gearbox:* Remove the vehicle key from the ignition lock.

### WARNING

Careless or unsupervised use of the vehicle keys can cause serious injuries.

- Always take along all vehicle keys when leaving the vehicle. The engine might be started and electrical equipment such as the power windows might be operated, which may lead to serious injuries.
- Never allow children or people requiring help alone in the vehicle. In an emergency, they are unable to leave the vehicle alone or to help themselves. For example, depending on the season, very high or low temperatures may develop in a closed vehicle, causing serious injuries and illness or death, especially in young children.
- Never remove the vehicle key from the ignition while the vehicle is in motion. The steering lock can engage and the vehicle can no longer be steered.

### Note

The vehicle battery discharges itself if the vehicle key is left in the ignition lock over a longer period while the engine is switched off. 

**Note**

In vehicles with automatic gearbox, the vehicle key can be removed from the ignition key only if the selector lever is in position P. If necessary, press and release the lock button in the selector lever. ■

**Starting the engine**

First read and observe the introductory information and safety warnings ⚠ on page 94.

Perform the actions in the specified order.		
Step	Vehicles with a manual gearbox.	vehicles with automatic gearbox.
1.	Depress and hold the brake pedal until after step 5.	
2.	Move the gearshift lever to the neutral position.	Move the selector lever to position P or N.
2a.	Depress and hold the clutch pedal completely until the engine is running.	
3.	<b>In addition, for the diesel engine:</b> To heat the glow plugs, turn the vehicle key in the ignition lock to position ⇒ fig. 66 ①. The indicator light  illuminates in the instrument cluster.	
4.	Turn the vehicle key in the ignition lock to position ⇒ fig. 66 ② - do not depress the accelerator pedal.	
5.	When the engine starts, release the vehicle key in the ignition lock.	
6.	If the engine does not start, interrupt the start process and repeat it after approx. 1 minute.	
7.	Release the handbrake when you want to depart ⇒ page 104.	

**WARNING**

Never leave the vehicle with the engine running. The vehicle could move suddenly, in particular if a gear is engaged or a driving stage has been selected, causing accidents and serious injuries.

**WARNING**

A start booster may explode or cause a sudden revving of the engine.

- Never use a start booster.

**NOTICE**

- The starter or the engine can be damaged if an attempt is made to start the engine while the vehicle is moving, or if the engine is started again immediately after stopping the engine.
- Avoid full throttle and high engine load on a cold engine.
- Do not push or tow the vehicle to start the engine. Unburnt fuel may damage the catalytic converter.

**For the sake of the environment**

Do not warm up the engine while the vehicle is standing, but depart as soon as you have free visibility through the windows. Through this the engine reaches its operating temperature more rapidly and the pollutant emissions are lower. ►

**i Note**

When starting the engine, major electrical loads are switched off temporarily.

**i Note**



The engine running noise may be louder for a short time after starting the cold engine. This is normal and is not an operating problem.

## Switching off the engine



First read and observe the introductory information and safety warnings  on page 94.

### Perform the actions in the specified order.

- |    |   |
|----|---|
| 1. | Bring the vehicle to a complete stop →  .                          |
| 2. | Depress and hold the brake pedal until after step 4.  |
| 3. | For an automatic gearbox, move the selector lever to position P.  |
| 4. | Apply the handbrake firmly → page 104.  |
| 5. | Turn the vehicle key in the ignition lock to position ⇒ fig. 66  . |
| 6. | For a manual gearbox, engage the 1st or reverse gear.   |

### WARNING

Never switch off the engine when the vehicle is in motion. This can cause loss of vehicle control, accidents and serious injuries.

- The airbags are disabled when the ignition is switched off.
- The brake booster will not work when the engine is switched off. More pressure on the brake pedal would be necessary to stop the vehicle.
- The power steering does not work when the engine is switched off so you need greater physical force to steer the vehicle.
- If the vehicle key is removed from the ignition lock, the steering lock may be engaged so the vehicle can no longer be controlled.

### NOTICE

If the vehicle was driven with a high engine load for longer periods of time, the engine may overheat after it has been switched off. To avoid engine damage, allow the engine to run in neutral for approx. two minutes before switching it off.

**i Note**

In vehicles with automatic gearbox, the vehicle key can be removed from the ignition lock only when the selector lever is in position P.

**i Note**

- After switching off the engine, the radiator fan in the engine compartment may continue to run a few minutes even when the ignition is switched off or the vehicle key has been removed. The radiator fan switches off automatically. ■

## Electronic immobiliser



First read and observe the introductory information and safety warnings  on page 94.

The immobiliser helps prevent the engine being started with a non-authorized vehicle key thereby moving the vehicle.

The vehicle ignition key contains a chip. The immobiliser is deactivated automatically with the aid of this chip when the key is inserted into the ignition lock.

The electronic immobiliser is deactivated automatically when the vehicle key is removed from the ignition lock.

Therefore, the engine can be started only with an original Škoda vehicle key having the matching coding. Coded vehicle keys are available from your Škoda partner ⇒ page 32.

**i Note**

Proper operation of the vehicle is ensured only with original Škoda vehicle keys. ■

## Shifting gears

### Introduction

This chapter contains information on the following subjects:


Warning and indicator lights .....	98
Pedals .....	99
Manual gearbox: Engaging a gear .....	100
Automatic gearbox: Engaging a gear .....	101
Shifting gears with the Tiptronic .....	102
Driving with automatic gearbox .....	103
Operational fault of the automatic gearbox .....	103

**When the reverse gear is engaged and the ignition is switched on, it happens the following:**

- The reversing light comes on.
- The air conditioning automatically switches to recirculated air mode during reverse driving.


**Additional information and warnings:**

- Instruments ⇒ page 19
- Braking, stopping and parking ⇒ page 104
- Air conditioning ⇒ page 117
- Engine control unit and exhaust emission control unit ⇒ page 181
- Emergency closing or opening ⇒ page 187


** WARNING**

**Rapid acceleration can cause loss of traction and spinning, especially on slippery roads. This can lead to loss of vehicle control, accidents and serious injuries.**

- Use kick-down or rapid acceleration only if permitted by visibility, weather, road and traffic conditions.

** WARNING**



**Never let the brake "slip" too often and too long or depress the brake pedal too often and too long. Continuous braking leads to overheating of the brakes. This can considerably reduce the stopping power, extend the braking distance significantly and may lead to total failure of the brake system.**

** NOTICE**

- Never let the brakes "slip" with light pressure on the pedal if braking is not really necessary. This increases the wear.
- Before driving over a longer distance with a steep gradient, slow down, shift to a lower gear or select a lower driving stage. As a result, the braking effect of the engine will be used, reducing the load on the brake. Otherwise, the brake may overheat and potentially fail. Use the brakes only when needed to slow down or stop.

### Warning and indicator lights

 First read and observe the introductory information and safety warnings  on page 98.

illuminates	Possible cause	Remedy
	Brake pedal not depressed!	To select a driving stage, depress the brake pedal.
Flashes	Possible cause	Remedy
	The lock button in the selector lever is not engaged. Prevents the vehicle from moving.	Engage the selector lever lock ⇒ page 101.

When switching on the ignition, some warning and indicator lights illuminate briefly as a function test. They will extinguish after a few seconds. ▶

**⚠ WARNING**

Ignoring illuminated warning lights and text messages may result in breaking down in traffic, accidents and serious injury.

- Never ignore illuminated warning lights and text messages.
- Stop the vehicle as soon as it is possible and safe to do so.
- If the vehicle stops due to a failure or has to be shut off for repairs, always leave the vehicle in a safe distance from the road, switch on the hazard warning light system, switch off the engine, and take other precautionary measures to warn the traffic behind.

**ⓘ NOTICE**

Ignoring illuminated indicator lights and text messages may lead to vehicle damage.

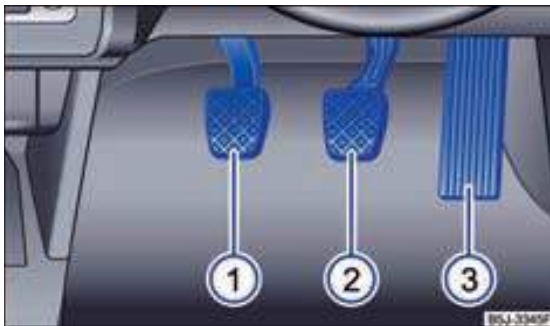
**Pedals**

Fig. 67 Pedals in vehicles with manual gearbox: ① clutch pedal, ② brake pedal, ③ accelerator pedal.

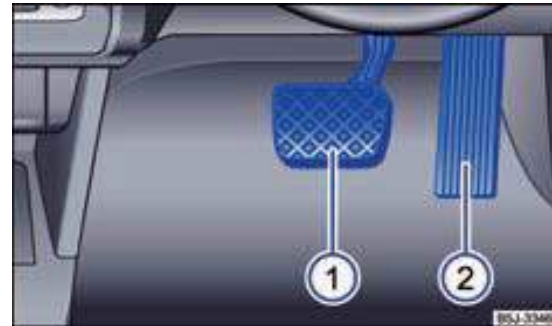


Fig. 68 Pedals in vehicles with automatic gearbox: ① brake pedal, ② accelerator pedal.



First read and observe the introductory information and safety warnings ⚠ on page 98.

The operation and movement of all pedals must never be restricted by objects or floor mats.

Use only floor mats that leave the pedal area free and which are secured against displacement in the footwell.

If one of the brake circuits fails, the brake pedal must be depressed further than normal to bring the vehicle to a stop.

**⚠ WARNING**

Objects in the driver's footwell may prevent the full play of the pedals. This may lead to loss of vehicle control, increasing the risk of serious injury.

- Make sure that all the pedals can be depressed without obstruction at any time.
- Always securely fasten the floor mats in the footwell.
- Never use floor mats or other floor coverings over the built-in mat.
- Make sure that no objects can enter the footwell of the driver during the ride.
- Remove any existing objects from the footwell while the vehicle is parked. ▶

**NOTICE**

Pedals must be operable at any time without hindrance. For example, if one of the brake circuits fails, it takes a longer brake pedal travel to bring the vehicle to a stop. The brake pedal must also be depressed further and harder than usual in this case.

**Manual gearbox: Engaging a gear**

Fig. 69 Shift pattern of the 5-speed manual gearbox.



First read and observe the introductory information and safety warnings **▲** on page 98.

The positions of the individual gears are shown on the gearshift lever → fig. 69.

- Fully depress and hold the clutch pedal.
- Move the gearshift lever to the desired position.

In some countries, the clutch pedal must be depressed all the way down to start the engine.

**Engaging the reverse gear**

- Engage the reverse gear only when the vehicle is stationary.
- Fully depress and hold the clutch pedal while the vehicle is stationary.

- Move the gearshift lever to the neutral position and press it down.
- Move the gearshift lever to the left and then forward to the reverse gear position **(R)**.

**Shifting down gears**

Shifting down should always be done one gear at a time, i.e. to the next lower gear, and not at too high engine speeds. Skipping one or more gears when shifting down at high vehicle or engine speeds can cause considerable clutch and gearbox damage, even if the clutch is not engaged.

**WARNING**

When the engine is running, the vehicle starts moving immediately after you engage a gear and release the clutch pedal. This also applies if the handbrake is firmly applied.

- Never engage the reverse gear while the vehicle is in motion.

**WARNING**

Improper downshifting to gears that are too low may result in loss of vehicle control, causing accidents and serious injuries.

**NOTICE**

Moving the gearshift lever at high vehicle or engine speeds to a gear that is too low could result in considerable clutch and gearbox damage. This applies even if you keep depressing the clutch pedal, without engaging the clutch.

**NOTICE**

Observe the following to prevent damage and premature wear:

- Do not rest your hand on the gearshift lever while driving the vehicle. The pressure of your hand is transmitted to the shift forks in the gearbox.
- Make sure that the vehicle has completely come to a stop before engaging the reverse gear.
- Always depress the clutch pedal all the way down.
- Do not hold the vehicle on slopes with a "slipping" clutch with the engine running.

## Automatic gearbox: Engaging a gear

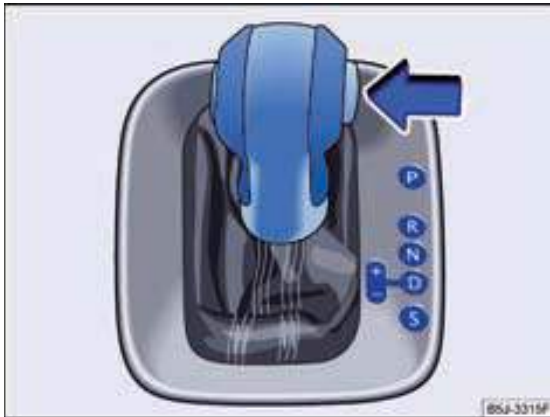





Fig. 70 Selector lever of automatic gearbox with lock button (arrow).

 First read and observe the introductory information and safety warnings  on page 98.

The selector lever is equipped with a selector lever lock. When changing a selector lever position from position **P** to a driving stage, depress the brake pedal and press the lock button in the selector lever in the direction of the arrow  $\Rightarrow$  fig. 70.


The display in the instrument cluster indicates the current selector lever position when the ignition is switched on.


Selector lever position	Designation	Meaning $\Rightarrow$ 
<b>P</b>	Parklock	The driven wheels are mechanically locked. Select only when the vehicle is <i>stationary</i> . To leave this selector lever position, depress the brake pedal and switch on the ignition.
<b>R</b>	Reverse gear	The reverse gear is engaged. Select only when the vehicle is <i>stationary</i> .
<b>N</b>	Neutral	The gearbox is in the neutral position. Power is not transmitted to the wheels and the braking effect of the engine is not available.
<b>D</b>	Position for driving forward (normal programme)	All forward gears are automatically shifted up and down. The timing of changing gears is dependent on engine load, individual driving style, and vehicle speed.
<b>S</b>	Position for driving forward (sports programme)	All forward gears are automatically shifted up <i>later</i> and down <i>earlier</i> than in the selector lever position <b>D</b> to take full advantage of the power reserves of the engine. The timing of changing gears is dependent on engine load, individual driving style, and vehicle speed.

### Selector lever lock

The selector lever lock prevents, in position **P** or **N**, any driving stage from being selected accidentally so the vehicle inadvertently starts to move.

To release the selector lever lock, depress and hold the brake pedal with the ignition switched on. Simultaneously press the lock button in the selector lever.

In a quick move across the position **N** (e.g. from **R** to **D**), the selector lever will not be locked. This allows you, for example, to "seesaw out" a stuck vehicle. The selector lever lock will engage, if the lever is in position **N** longer than approximately one second and at a speed slower than about 3 mph (5 km/h) while the brake pedal is not depressed. 

In rare cases, it may occur in vehicles with automatic gearbox that the selector lever lock fails to engage. The drive is then disabled to prevent accidental starting. The green indicator light  will flash. Proceed as follows to engage the selector lever lock:

Move the selector lever to position **P** or **N** and then select a driving stage.

### WARNING

Selecting a wrong selector lever position may lead to loss of vehicle control, an accident and serious injury.

- Never depress the accelerator pedal when selecting a driving stage.
- With the engine running and a driving stage selected, the vehicle will start moving as soon as the brake pedal is released.
- Never select the reverse gear or the Parklock while the vehicle is moving.

### WARNING

Unintended vehicle movement can cause serious injuries.

- The driver should never leave the driver's seat with the engine running and a driving stage selected. When you must leave the vehicle with the engine running, always firmly pull the handbrake and move the selector lever to position **P**.
- With the engine running and with driving stage **D**, **S**, or **R** selected, it is necessary to hold the vehicle with the foot brake. Even at idling speed, the power transmission is never completely interrupted and the vehicle "creeps".
- Never shift to driving stage **R** or **P** when the vehicle is moving.
- Never leave the vehicle with driving stage **N** selected. The vehicle will roll downhill, regardless of whether the engine is running or not.

### NOTICE

If the handbrake is not applied and the brake pedal is released in position **P** while the vehicle is stationary, the vehicle may move a few inches forward or backward.

### Note

If you accidentally shifted to **N** while driving, release the accelerator pedal. Wait for the engine speed in the neutral position before again selecting a gear stage. ■

## Shifting gears with the Tiptronic






Fig. 71 Selector lever in Tiptronic position.

 First read and observe the introductory information and safety warnings  on page 98.

The Tiptronic allows you to shift the gears up or down manually in an automatic gearbox. When switching to the Tiptronic programme, the currently engaged gear is retained. This applies until the system automatically performs a gear change due to the current driving situation.

### Operating the Tiptronic with the selector lever

- Push the selector lever in position **D** to the right into the Tiptronic shift track ⇒  in Automatic gearbox: Engaging a gear on page 102.
- Tip the selector lever forward  or backward  in order to shift gears up or down ⇒ fig. 71.


### NOTICE

- During acceleration, the gearbox shifts automatically to the next higher gear just before reaching the maximum engine speed.
- When you downshift manually, the gearbox changes gears only when over-revving of the engine is no longer possible. ■



## Driving with automatic gearbox



First read and observe the introductory information and safety warnings  on page 98.

The forward gears are shifted up or down automatically.


### Going downhill

The steeper the slope, the lower a gear must be engaged. Lower gears increase the braking effect of the engine. Never let the vehicle roll down mountains or hills in the neutral position **N**.

- Reduce speed.
- Push the selector lever from position **D** to the right into the Tiptronic shift track  $\Rightarrow$  page 102.
- Tip the selector lever backward to shift down.

### Kickdown

The kickdown function allows for maximum acceleration in the selector lever position **D**, **S** or in the Tiptronic position.

When the accelerator pedal is fully depressed, the automatic gearbox shifts to a lower gear depending on the vehicle and engine speed. Thus, the full acceleration power of the vehicle is utilised  $\Rightarrow$  .

When using kickdown, the next higher gear is selected automatically only when the predetermined maximum engine speed is reached.

### WARNING

Rapid acceleration can cause loss of traction and spinning, especially on slippery roads. This can lead to loss of vehicle control, accidents and serious injuries.

- Always adapt your driving to the traffic flow.
- Use kick-down or rapid acceleration only if permitted by visibility, weather, road and traffic conditions.
- Never endanger other road users by accelerating the vehicle and your driving style.
- Be aware that the driven wheels may spin and the vehicle may slip if TCS is switched off, especially when the road is slippery.
- After accelerating, turn TCS back on.

### NOTICE

- When stopping on hills with a driving stage selected, do not depress the accelerator pedal to prevent the vehicle from rolling away. This may overheat and damage the automatic gearbox.
- Never let the vehicle roll in driving stage **N**, especially with the engine switched off. The automatic gearbox is not lubricated and can hence be damaged.

## Operational fault of the automatic gearbox



First read and observe the introductory information and safety warnings  on page 98.


### Emergency programme

If all the selector lever positions are highlighted on the instrument cluster display with a light background, there is an operational fault in the system. The automatic gearbox runs in an emergency programme. In the emergency programme, the vehicle can still be driven, but at reduced speed and not in all gears.

In some cases, it is **not possible to drive in reverse gear**. Have the gearbox checked immediately by a specialist garage.

In any case, have the automatic gearbox checked immediately by a specialist garage.

### Overheating of the automatic gearbox

The automatic gearbox may, for example, become too hot due to frequent starting, long "creeping" or stop-and-go traffic. Stop and allow the gearbox to cool  $\Rightarrow$   in Driving with automatic gearbox on page 103.

### NOTICE

- If you see the first time that the gearbox is overheating, either park the vehicle safely or drive faster than 12 mph (20 km/h).
- If the text message and acoustic warning are repeated approximately every 10 seconds, the vehicle must immediately be parked safely and the engine switched off. Allow the gearbox to cool.
- To prevent damage to the gearbox, you should not continue driving before the acoustic warning no longer sounds. As long as the gearbox is overheated, starting to drive and driving at walking speed should be avoided.

## Braking, stopping and parking

### Introduction

This chapter contains information on the following subjects:

Warning and indicator lights .....	105
Handbrake .....	106
Parking .....	106
Information about the brakes .....	107
ABS brake assist system .....	109
Brake fluid .....	110

#### Additional information and warnings:

- Wheels and tires ⇒ page 160
- Accessories, spare parts, repairs and modifications ⇒ page 172

**⚠ WARNING**  
 Driving with worn brake pads or a faulty brake system can cause accidents and serious injuries.

**⚠ WARNING**  
 Improper parking can cause serious injuries.

- Never remove the vehicle key from the ignition while the vehicle is in motion. The steering lock can engage and the vehicle can no longer be steered or controlled.

**⚠ WARNING (Continued)**

- Never park the vehicle such that parts of the exhaust system come in contact with highly flammable materials under the vehicle, such as underbrush, leaves, dry grass, spilled fuel, etc.
- Always firmly apply the parking brake when the vehicle is stopped or parked.
- Never allow children or people requiring help alone in the vehicle. They could release the handbrake, move the selector lever or gearshift lever and thereby set the vehicle in motion. This can cause accidents and serious injuries.
- Always take along all vehicle keys when leaving the vehicle. The engine might be started and electrical equipment such as the power windows might be operated, which may lead to serious injuries.
- Never allow children or people requiring help alone in the vehicle. In an emergency, they are unable to leave the vehicle alone or to help themselves. For example, depending on the season, very high or low temperatures may develop in a closed vehicle, causing serious injuries and illness or death, especially in young children.








**ⓘ NOTICE**

- Always drive cautiously onto parking lots with high-curb mounts or solid boundaries. These objects protruding from the ground may damage the bumper and other vehicle parts when parking or leaving. To avoid damage, stop before the wheels touch the limits or curbs.
- Drive cautiously over driveways, ramps, curbs and other objects. Deep-seated vehicle parts such as bumpers, spoilers and parts of the chassis, engine or exhaust system can be damaged when driving over these objects.

## Warning and indicator lights



First read and observe the introductory information and safety warnings  on page 104.

illuminates	Possible cause $\Rightarrow$ 	Remedy
	Handbrake applied	Releasing the handbrake $\Rightarrow$ page 106.
	Brake disturbed.	 <b>Do not drive the vehicle!</b> Seek professional help immediately $\Rightarrow$ page 107.
	Brake fluid level low. Along with ABS indicator light  : ABS failed.	 <b>Do not drive the vehicle!</b> Check brake fluid level $\Rightarrow$ page 110. Visit a specialist garage. Vehicle can be slowed down gently without ABS.
	Along with warning light  : ABS failed.	Visit a specialist garage. The vehicle can be slowed down gently without ABS.
	Brake pedal not depressed!	To select a driving stage, depress the brake pedal.

When switching on the ignition, some warning and indicator lights illuminate briefly as a function test. They will extinguish after a few seconds.


### WARNING

Ignoring illuminated warning lights and text messages may result in breaking down in traffic, accidents and serious injury.




- Never ignore illuminated warning lights and text messages.
- Stop the vehicle as soon as it is possible and safe to do so.

### WARNING

Driving with bad brakes can cause accidents and serious injuries.

- If the brake system warning light  does not go off or come on while driving, either the brake fluid level in the reservoir is too low or there is a fault in the brake system. Immediately stop and seek professional help  $\Rightarrow$  page 110, Brake fluid.

### WARNING (Continued)

- If the brake system warning light  comes on along with the ABS indicator light , the control function of the ABS may have failed. In this case, the rear wheels may block relatively rapidly when braking. Blocking rear wheels can cause loss of vehicle control! If possible, reduce speed and drive carefully at low speed to the next specialist garage to have the brakes checked. Avoid sudden braking and driving manoeuvres on the way.
- If the ABS indicator light  does not go off or comes on while driving, the ABS does not work properly. The vehicle can be stopped only with the normal brakes (without ABS). The protection offered by the ABS is not available then. Visit a specialist garage as soon as possible.

### NOTICE

Ignoring illuminated indicator lights and text messages may lead to vehicle damage.

## Handbrake

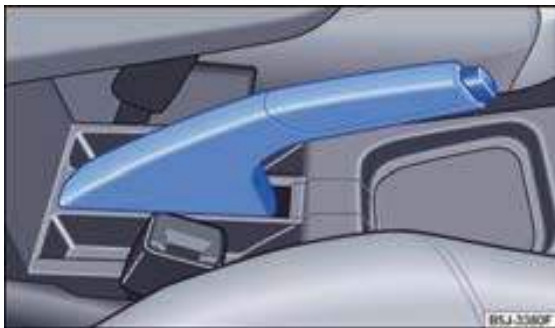



Fig. 72 Between the front seats: Handbrake.

 First read and observe the introductory information and safety warnings  on page 104.

### Applying the handbrake

- Pull the handbrake lever firmly upward.
- The hand brake is applied if the indicator light  in the instrument cluster illuminates  $\Rightarrow$  page 105 when the ignition is switched on.

### Releasing the handbrake

- Pull the handbrake lever slightly upwards and press the lock button  $\Rightarrow$  fig. 72.
- Move the handbrake lever down while pressing the lock button.

## WARNING

Improper use of the handbrake can cause accidents and serious injuries.

- Never use the handbrake to slow down the vehicle, except in an emergency. The braking distance is much longer, because only the rear wheels are braked. Always use the foot brake.
- Never drive with the handbrake slightly applied. This may overheat the brake and negatively affect the brake system. In addition, this can result in premature wear of the rear brake pads.
- Never operate the throttle from the engine compartment when a driving stage has been selected or a gear has been engaged and the engine is running. The vehicle may start to move even when the handbrake is applied.

## NOTICE

If the handbrake is not applied and the brake pedal is released in selector lever position P while the vehicle is stationary, the vehicle may move a few inches forward or backward.

## Note

When driving faster than approximately 4 mph (6 km/h) with the handbrake applied, an alarm will sound. ■


## Parking

 First read and observe the introductory information and safety warnings  on page 104.

Observe the legal provisions for parking of a vehicle.

### Parking the vehicle

Perform the actions in the specified order.

- Park the vehicle on a suitable surface  $\Rightarrow$  .
- Depress and hold the brake pedal until the engine is switched off.
- Firmly pull the handbrake.
- With an automatic gearbox, move the selector lever to position P.
- Switch off the engine and take your foot off the brake pedal.
- Remove the vehicle key from the ignition lock.
- If necessary, turn the steering wheel slightly to engage the steering lock.
- With a manual gearbox, on a flat surface and an uphill slope, shift to the 1st gear, or on a downhill slope, engage the reverse gear, and release the clutch pedal.
- Make sure that all passengers get off, especially children.
- Take all vehicle keys along when leaving the vehicle.
- Locking the vehicle

### Additionally on uphill and downhill slopes

Before switching off the engine, turn the steering wheel such that the parked vehicle will roll with the front wheels against the curb if it begins to move. ►

- On a downhill slope, turn the front wheels such that they point toward the curbs.
- On an uphill slope, turn the front wheels such that they point to the middle of the road.

### WARNING

The parts of the exhaust system become very hot. This may cause fires and serious injuries.

- Never park the vehicle such that parts of the exhaust system come in contact with highly flammable materials under the vehicle, such as underbrush, leaves, dry grass, spilled fuel.


### NOTICE

- Always drive cautiously onto parking lots with high-curb mounts or solid boundaries. These objects protruding from the ground may damage the bumper and other vehicle parts when parking or leaving. To avoid damage, stop before the wheels touch the limits or curbs.
- Drive cautiously over driveways, ramps, curbs and other objects. Deep-seated vehicle parts such as bumpers, spoilers and parts of the chassis, engine or exhaust system can be damaged when driving over these objects.
- If the handbrake is not applied and the brake pedal is released in selector lever position P while the vehicle is stationary, the vehicle may move a few inches forward or backward.


## Information about the brakes





First read and observe the introductory information and safety warnings  on page 104.

**New brake pads** have not yet attained full braking power during the first 100 to 200 miles (200 to 300 km) and must be "run in" first  $\Rightarrow$  . However, the slightly reduced braking force can be overcome by a stronger pressure on the brake pedal. **During the running-in period, the braking distance during full braking or emergency braking is longer** than with run-in brake pads. During the running-in period, avoid full braking and situations that exert high loads on the brakes, for example when driving too close to the vehicle ahead.


The **wear of the brake pads** depends very much on the operating conditions and driving style. With frequent city and short-range driving as well as using a sporty style of driving, the thickness of the brake pads needs to be checked more often than indicated in the service schedule.

When driving with **wet brakes**, such as after water crossings, heavy rain or after a car wash, the braking effect may be delayed due to moist or, in winter, icy brake discs. The brakes need to be "dried" as quickly as possible by gently braking at higher speeds. Make sure that vehicles behind and other road users are not endangered  $\Rightarrow$  .

A **layer of salt on the brake discs and brake pads** delays the braking effect and extends the braking distance. If you have not operated the brakes on salt-strewn roads for some time, the salt layer must be abraded by gentle braking operations  $\Rightarrow$  .



**Corrosion** on the brake discs and **dirt** on the brake pads occur if the vehicle has been parked for a long period and if you do not make much use of the brake system. Skoda recommends cleaning the brake discs and brake pads by firmly applying the brakes at a fairly high speed if you do not make much use of the brake system or if surface corrosion is present. Make sure that vehicles behind and other road users are not endangered  $\Rightarrow$  .

### Fault in the brake system

If you need to decelerate and the vehicle does not slow down as much as usual (sudden increase in braking distance), a brake circuit may have failed. This is indicated by the warning light  and possibly by a text message. Immediately visit the nearest authorised specialist garage to have the damage repaired. Drive there with less speed and expect much longer braking distances and increased pedal pressure.

### Brake booster

The brake booster only works when the engine is running and increases the pedal pressure exerted by the driver on the brake pedal.

If the brake booster is not working or the vehicle is towed, the brake pedal must be depressed with greater force because the braking distance increases due to the lack of braking assistance  $\Rightarrow$   

**⚠ WARNING**

New brake pads initially do not provide optimal braking performance.

- New brake pads have not yet attained full braking efficiency for up to 200 miles (320 km) and must first be "run in". Reduced braking efficiency can be increased by adding more pressure applied to the brake pedal.
- To reduce the risk of accidents, personal injury and loss of vehicle control, drive more carefully with new brake pads.
- During the running-in period of new pads, never drive too closely behind other vehicles or cause driving situations which involve a high load on the brake.

**⚠ WARNING**

Overheated brakes reduce the braking efficiency and extend the braking distance significantly.

- When driving downhill, the brakes are particularly stressed and become hot very quickly.
- Before driving over a longer distance with a steep gradient, slow down, shift to a lower gear or select a lower driving stage. As a result, the braking effect of the engine will be used, reducing the load on the brake.
- Non-standard or damaged front spoilers may impair the supply of air to the brakes and lead to overheating of the brakes.

**⚠ WARNING**

Wet brakes or frozen or salty brakes decelerate later and extend the braking distance.

- Try to brake carefully.
- Always dry the brakes and free them of ice and salt by a few careful braking operations when permitted by visibility, weather, road and traffic conditions.

**⚠ WARNING**

Driving without a brake booster can significantly lengthen the braking distance, causing accidents and serious injuries.

- Never let the vehicle roll with the engine switched off.
- If the brake booster is not working or the vehicle is towed, the brake pedal must be depressed with greater force because the braking distance increases due to the lack of braking assistance.

**ⓘ NOTICE**


- Never let the brakes "slip" with light pressure on the pedal if braking is not really necessary. Continuous pressure on the brake pedal causes overheating of the brakes. This can considerably reduce the stopping power, extend the braking distance significantly and may lead to total failure of the brake system.
- Before driving over a longer distance with a steep gradient, slow down, shift to a lower gear or select a lower driving stage. As a result, the braking effect of the engine will be used, reducing the load on the brake. Otherwise, the brake may overheat and potentially fail. Use the brakes only when needed to slow down or stop.

**ⓘ Note**

When the front brake pads are checked, the rear brake pads should be examined simultaneously. The thickness of all brake pads should regularly be checked visually by examining the brake pads through the openings of the wheels or from the underside of the vehicle. If necessary, remove the wheels to carry out a thorough inspection. ŠKODA recommends a ŠKODA partner for this purpose. ■

## ABS brake assist system



First read and observe the introductory information and safety warnings  on page 104.

The ABS brake assist system only works when the engine is running and significantly contributes to active driving safety.

### Antilock Brake System (ABS)

The ABS can prevent the wheels from locking while braking just before the vehicle is stopped and helps the driver to steer the vehicle and maintain control. This means that the vehicle tends less to skid even during full braking:

- Firmly depress and hold the brake pedal. Do not take your foot off the brake pedal or reduce the force on the brake pedal!
- Do not “pump” the brake pedal or reduce the pressure on the brake pedal!
- Steer the vehicle while continuing to firmly depress the brake pedal.
- When you release the brake pedal or reduce the force on the brake pedal, the ABS is switched off.

The control process of the ABS is noticeable by a **pulsating movement** of the brake pedal and noise. It should not be expected that the ABS shortens the braking distance under *all* circumstances. The braking distance may even be longer on gravel or on icy or slippery surfaces of fresh snow.

### WARNING

Fast driving on icy, slippery or wet roads can lead to loss of vehicle control and serious injuries for the driver and passengers.

- Adjust your speed and driving style to the visibility, weather, road and traffic conditions. The enhanced safety features through the ABS brake assist system must not mislead you to take a security risk.
- Brake assist systems can not overcome the physical limits. Slippery or wet roads remain very dangerous even with ABS.
- Driving too fast on wet roads can cause the wheels to lose contact with the ground and “float”. A vehicle can not be slowed down, steered and controlled when it has lost contact with the road.
- Brake assist systems cannot prevent an accident if, for example, you drive too closely behind the vehicle ahead or too fast for the prevailing driving situation.

### WARNING (Continued)

- Although brake assist systems are very effective in difficult situations and help control the vehicle, always remember that the driving stability depends on the grip of the tyres.
- When accelerating on slippery surfaces, e.g. on ice or snow, depress the accelerator pedal carefully. Even with brake assist systems, wheels may spin, which can lead to loss of vehicle control.

### WARNING

- Always remember that changes and modifications to the vehicle may affect the function of the ABS.
- Changes to the suspension of the vehicle or the use of unapproved wheel/tyre combinations can affect the function of the ABS and reduce its effectiveness.

### Note


Noise may be audible when the ABS operates. ■

## Brake fluid




Fig. 73 In the engine compartment: Cover of the brake fluid reservoir.

 First read and observe the introductory information and safety warnings  on page 104.

The brake fluid absorbs moisture from the surrounding air over a period of time. Excessive water content of the brake fluid causes damage to the brake system. Water reduces the boiling point of the brake fluid considerably. With an excessively high water content, vapour bubbles may form in the brake system when the brakes are used hard and during full braking manoeuvres. Vapour bubbles reduce the braking efficiency, extend the braking distance significantly and may even lead to total failure of the brake system. Your own safety and the safety of other road users depend on a brake system that is properly functioning at any time  $\Rightarrow$  .

### Brake fluid specification


For best function of the brake system, Škoda recommends brake fluid of **VW standard 501 14**. If this brake fluid is not available or a different brake fluid is used for other reasons, a brake fluid may be used that complies with the requirements of U.S. standard FMVSS 116 DOT 4 or DIN ISO 4925 CLASS 4  $\Rightarrow$  .

Brake fluids according to the VW standard 501 14 meet the requirements of the U.S. standard FMVSS 116 DOT 4 and DIN ISO 4925 CLASS 4. This does not mean that a brake fluid in accordance with the requirements of U.S. standard FMVSS 116 DOT 4 or DIN ISO 4925 CLASS 4 automatically also meets the require-

ments of the VW standard 501 14. Compare this information with the information on the packaging of the brake fluid and make sure to always use the correct brake fluid for the vehicle.

Suitable brake fluids are available from a Škoda partner.

### Brake fluid level

The fluid level must always be between the MIN and MAX markings of the brake fluid reservoir and above the MIN marking  $\Rightarrow$  .

The brake fluid level cannot be accurately checked for each model, as engine parts block the view of the fluid level in the brake fluid reservoir. If the brake fluid level cannot be read accurately, seek professional help.

The brake fluid level drops slightly during driving as the brake pads wear out and the brake automatically adjusts itself.

### Brake fluid change

The brake fluid must be changed as specified in the service schedule. Have the brake fluid changed by a specialist garage. Škoda recommends a Škoda partner for this purpose. Only replenish new brake fluid that has the required specification.

## WARNING

**Brake failure or reduced braking efficiency may be caused by a low brake fluid level or old or unsuitable brake fluid.**

- Have the brake system and brake fluid level checked regularly!
- Have the brake fluid changed regularly according to the service schedule requirements.
- Heavy use of the brakes with old brake fluid may cause forming of vapour bubbles. Vapour bubbles reduce the braking efficiency, extend the braking distance significantly and may lead to total failure of the brake system.
- Make sure that the correct brake fluid is used. Only use brake fluid that matches VW standard 501 14 or FMVSS 116 DOT 4 or DIN ISO 4925 CLASS 4. Any other brake fluid may impair the braking function and reduce the braking efficiency. Do not use the brake fluid, if VW standard 501 14, FMVSS 116 DOT 4 or DIN ISO 4925 CLASS 4 is not indicated on the brake fluid reservoir.
- The replenished brake fluid must be fresh.



**⚠ WARNING**

Brake fluid is toxic.

- To reduce the risk of poisoning, never use beverage bottles or other containers for storing brake fluid. These containers may entice people to drink from them, even if the container is labelled.
- Always store brake fluid in its sealed original container and out of the reach of children.

**ⓘ NOTICE**

Brake fluid damages the paintwork of the vehicle. Wipe off brake fluid from the vehicle paint immediately.

**For the sake of the environment**

Brake fluid may pollute the environment. Collect and properly dispose of spilled fluids.

## Driving in an environmentally conscious manner

### Introduction

This chapter contains information on the following subjects:

Economic driving style .....	112
Fuel-saving driving .....	113

Fuel consumption, pollution of the environment and wear to the engine, brakes and tyres depend essentially on three factors:

- your personal style of driving,
- operating conditions (weather, road conditions),
- technical requirements.

You can save up to 25 % fuel with a few simple measures and depending on your own driving style.

#### WARNING

Always adapt your speed and safety distance to the vehicle ahead to the visibility, weather, road and traffic conditions.

### Economic driving style

 First read and observe the introductory information and safety warnings  on page 112.

#### Shift to the next higher gear earlier

Basically: The higher gear is always the more economical gear. Rule of thumb for most vehicles: Use the 3rd gear at a speed of approx. 20 mph (30 km/h), the 4th gear at approx. 25 mph (40 km/h), and the 5th gear already from approx. 30 mph (50 km/h).

Moreover, "skipping" of gears when shifting to higher gears saves fuel, if the traffic and driving conditions permit.

Do not run out the gears to the limit. Use the 1st gear only for starting to move, and quickly shift to the 2nd gear. Avoid kickdowns for vehicles with automatic gearbox.

Vehicles with gear indicator support a fuel-efficient driving style by displaying the best time for changing the gear.

#### Let the vehicle roll

When you take your foot off the accelerator pedal, the fuel supply to the engine is interrupted and fuel consumption is reduced.

Therefore, for example, when you approach a red traffic light, let the vehicle roll without depressing the accelerator pedal. Only when the vehicle is too slow or the distance is too long, depress the clutch pedal to disengage. The engine then continues to run at idling speed.

In situations where a longer waiting time is expected, actively switch off the engine, such as at a railway crossing.

#### Look ahead when driving and "flow with the traffic"

Frequent braking and accelerating significantly increases fuel consumption. By driving with foresight and a sufficiently large distance to the vehicle ahead, you can compensate speed fluctuations merely by taking your foot off the accelerator pedal. Active braking and accelerating is then not absolutely necessary.

#### Drive smoothly and evenly

More important than speed is consistency: the more evenly you drive, the lower your fuel consumption.

On the motorway, driving at constant and moderate speed is more effective than continuously accelerating and braking. A constant driving style usually takes you to your destination just as fast.

#### Use additional electrical loads sparingly

Comfort in the vehicle is good and important, but you should be environmentally conscious.

Some electrical equipment, when switched on, increases fuel consumption (examples):

- Cooling system of air-conditioning: When the air conditioning system has to produce a very high temperature difference, it needs a lot of energy that is generated by the engine. Therefore, the temperature difference in the vehicle should not be overly large compared to the outside temperature. It may be helpful, before driving, to ventilate the vehicle and then run a short distance with the windows open. Only then switch on the air conditioning system with the windows closed. At high speeds, keep the windows closed. Open windows increase fuel consumption.
- Switch off the rear window heater when the window is free of ice and fog. ▶

**Other factors that increase fuel consumption (examples):**

- Faulty engine control.
- Driving in mountainous areas.

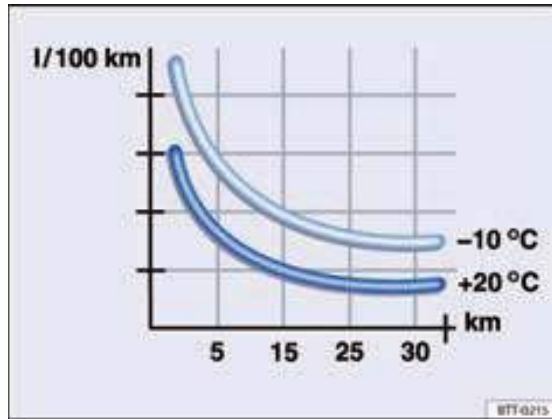
**Fuel-saving driving**

Fig. 74 Fuel consumption in l/100 km at two different ambient temperatures.



First read and observe the introductory information and safety warnings  on page 112.

By forward-looking and economical driving, fuel consumption can be easily reduced by 10 to 15 per cent.

A vehicle's highest fuel consumption occurs when it accelerates. In forward-looking driving, less braking and consequently less accelerating are required. Let your vehicle coast to a stop, for example, if this is possible, when you see that the next set of traffic lights is at red.

**Avoid short distances**

A cold engine consumes noticeably more fuel immediately after the start. Only after a few miles, the engine is warm and the fuel consumption has returned to normal.

To reduce fuel consumption and pollutant emissions effectively, the engine and the catalytic converter must have reached their optimum **operating temperature**. An important factor in this context is also the **ambient temperature**.

fig. 74 shows the different fuel consumptions for the same distance both at +68 °F (+20 °C) and +14 °F (-10 °C).

- Therefore, avoid unnecessary short distances and combine.

The vehicle consumes more fuel in winter than in summer under the same conditions.

A "warm-up" of the engine is not only prohibited by law in some countries, but also technically unnecessary and a waste of fuel.

**Adjust the tyre pressure**

The correct tyre pressure reduces the rolling resistance and, therefore, fuel consumption. In addition, a slightly higher tyre pressure (+ 0.2 bar / + 3 psi) also helps to save fuel.

If one accepts small loss of comfort, it is always possible to use the tyre pressure recommended for the full vehicle loading. This also applies if you travel alone and without baggage.

When purchasing new tyres always make sure that the tyres are optimised for road resistance.

**Use fuel-economy engine oil**

Fully synthetic engine oils with low viscosity, so-called fuel-economy engine oils, reduce fuel consumption. Fuel-economy engine oils reduce friction resistance in the engine and are distributed better and faster, in particular during cold starting of the engine. This is particularly effective in vehicles that often run short distances.

Always ensure the correct engine oil level and keep the service intervals (oil change intervals).

When purchasing engine oil, always check for the engine oil standard and approval by Škoda.

**Avoid unnecessary ballast**

The lighter the vehicle, the more economical and environmentally friendly it is. An additional weight of about 220 lbs (100 kg), for example, increases fuel consumption by up to 0.078 gal/60 miles (0.3 l/100 km).

Remove all unnecessary items and unnecessary ballast from your vehicle.

**Remove unnecessary structures and attachments**

The more aerodynamic a vehicle, the lower its fuel consumption. Structures and attachments reduce the aerodynamic advantage. ▶

Therefore, remove unnecessary attachments, especially if you plan to run at high speeds. ■

## Steering

### Introduction



This chapter contains information on the following subjects:


Warning and indicator lights .....	115
Information about the steering .....	116

The steering assist is not hydraulic but electromechanical. The advantage of this type of steering is that hydraulic hoses, hydraulic fluid, a pump, filters and other parts are not needed. The electromechanical system is more fuel-efficient. While a hydraulic system continuously requires oil pressure in the system, the electromechanical steering needs an energy supply only when steering.

The steering assist of the electromechanical steering system adjusts itself automatically depending on the speed, the steering torque and the steering angle of the wheels. The electromechanical steering system only works with the engine running.

### Warning and indicator lights

 First read and observe the introductory information and safety warnings  on page 115.

illuminates	Possible cause	Remedy
	Electromechanical steering assist is reduced. Vehicle battery was disconnected and reconnected.	Have the steering checked immediately by a specialist garage. If the yellow warning light does not illuminate again after restarting the engine and driving a short distance, you do <b>not</b> need to visit a specialist garage. Drive a short distance at approx. 9 - 12 mph (15 - 20 km/h).

When switching on the ignition, some warning and indicator lights illuminate briefly as a function test. They will extinguish after a few seconds.

#### WARNING

Ignoring illuminated warning lights and text messages may result in breaking down in traffic, accidents and serious injury.

- Never ignore illuminated warning lights and text messages.
- Stop the vehicle as soon as it is possible and safe to do so.

#### Additional information and warnings:

- Starting and stopping the engine ⇒ page 94
- Vehicle battery ⇒ page 144
- Tow-starting and towing the vehicle ⇒ page 212

#### WARNING

When the steering assist is not working, it is very difficult to turn the steering wheel, requiring greater effort to steer the vehicle.

- The steering assist only operates when the engine is running.
- Never let your vehicle roll with the engine switched off.
- Never remove the vehicle key from the ignition while the vehicle is in motion. The steering lock can engage and the vehicle can no longer be steered.

#### NOTICE

Ignoring illuminated indicator lights and text messages may lead to vehicle damage.

## Information about the steering



First read and observe the introductory information and safety warnings ⚠ on page 115.

To make a theft of the vehicle more difficult, the steering should always be locked before you exit the vehicle.

### Mechanical steering lock

Activating the steering lock feature	Deactivating the steering lock feature
Park the vehicle ⇒ page 104.	Turn the steering wheel slightly to relieve the steering lock.
Remove the vehicle key from the ignition lock.	Insert the vehicle key into the ignition lock.
Turn the steering wheel slightly until the steering lock clicks into place.	Hold the steering wheel in this position and switch on the ignition. ■

## Air conditioning

### Air conditioning system

#### Introduction

This chapter contains information on the following subjects:

Control elements .....	118
Operating information for the air conditioning system .....	120
Air outlets .....	121
Recirculated air mode .....	121

#### Additional information and warnings:

- Windscreen wipers and washers ⇒ page 77
- Maintaining and cleaning the vehicle exterior ⇒ page 148

#### WARNING

Poor visibility through all windows increases the risk of collisions and accidents, resulting in serious injury.

- Always make sure that all windows are free of ice, snow and fog, to have good visibility to the outside.
- Maximum heat output and rapid thawing of the windows can only be achieved when the engine has reached its operating temperature. Do not depart before you have good visibility conditions.
- Always make sure that the air conditioning and heated rear window are used correctly in order to have good visibility to the outside.
- Never use the recirculated air mode over a long period. When the cooling system is switched off, the windows can become fogged very quickly in recirculated air mode, greatly limiting visibility.
- Always switch off recirculated air mode when it is not required.

#### WARNING


Stale air can lead to rapid fatigue and decreased concentration of the driver, causing collisions, accidents and serious injuries.

- Never switch off the blower for a long time and never use the recirculated air mode over an extended period because no fresh air enters the interior.

#### NOTICE

- If you suspect that the air conditioning system was damaged, switch off the air conditioning. This can avoid additional damage. Have the air conditioning system checked by a specialist garage.
- Repairs on the air conditioning system require special knowledge and special tools. Škoda recommends a Škoda partner for this purpose.
- Do not smoke in vehicles equipped with air conditioning in recirculated air mode. The drawn smoke may form deposits on the evaporator of the cooling system as well as on the dust and pollen filter equipped with an activated charcoal insert, resulting in permanent odour nuisance.

#### Note

If you switch off the air conditioning, the drawn outside air is not dehumidified. To prevent fogging of the windows, Škoda recommends to have the cooling system (compressor) switched on. Press button  to do so. The indicator light in the button should illuminate.

#### Note

At high outside air humidity and high outside temperatures, **condensation** may drip off the evaporator of the cooling system and form a pool of water under the vehicle. This is quite normal and not an indication of a leak!

#### Note

To avoid that the heating or cooling performance is affected and to prevent fogging of the windows, the air inlet in front of the windscreen must be free of ice, snow or leaves.

Control elements

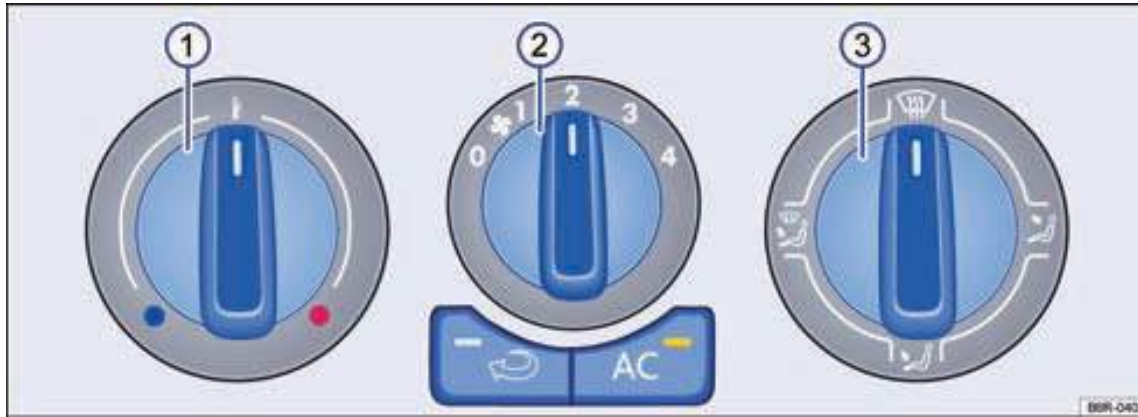


Fig. 75 In the centre console: Control elements of the manual air conditioning system.

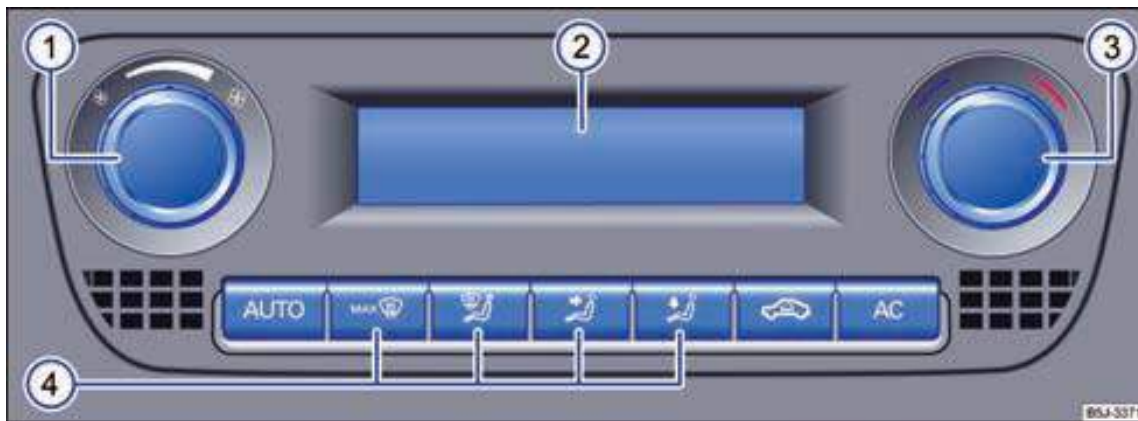













Fig. 76 In the centre console: Control elements of the Climatronic.

 First read and observe the introductory information and safety warnings  on page 117.


To switch a function on or off, press the appropriate button. When the function is switched on, an indicator light (manual air conditioning system) illuminates in the button or the activated function is shown on the display  $\Rightarrow$  fig. 76 ② (Climatronic). To switch off the function, press the button again.

Illuminating LEDs in the control elements indicate that the function is active. 



<b>Button, control</b>	<b>Additional information. Manual air conditioning system</b> ⇒ fig. 75 and <b>Climatronic</b> ⇒ fig. 76.
Temperature	<b>Manual air conditioning system</b> ①: Continuously adjustable.
	<b>Climatronic</b> ③: Continuously adjustable.
Blower	<b>Manual air conditioning system</b> ②: Level 0: Blower and manual air conditioning system switched off, level 4: Maximum blower stage.
	<b>Climatronic</b> ①: The blower power is automatically controlled. The blower can also be adjusted manually.
Air distribution	<b>Manual air conditioning system</b> ③: Continuously adjustable.
	<b>Climatronic</b> ④: Can be activated manually via buttons.
	<b>Manual air conditioning system:</b> Defrost function. Distribution of air to the windscreen. The recirculated air mode is automatically switched off or not switched on at all in this position. Manual air conditioning system: Press the button (AC) and increase the intensity of the blower to demist the windscreen as soon as possible.
	<b>Climatronic:</b> Defrost function. The drawn outside air is directed to the windscreen and the recirculated air mode is switched off automatically. To demist the windscreen as soon as possible, the air is dehumidified at temperatures above approx. +38 °F (+3 °C) and the blower is adjusted to a high blower stage.
	Distribution of air to the upper body.
	Distribution of air into the footwell.
	<b>Manual air conditioning system:</b> Distribution of air to windscreen and into the footwell.
	<b>Climatronic:</b> Distribution of air to the top
AC	<b>Manual air conditioning system, Climatronic:</b> Press the button to switch the cooling system on or off.
	<b>Manual air conditioning system:</b> Recirculated air mode ⇒ page 121.
	<b>Climatronic:</b> Recirculated air mode ⇒ page 121.
Switching off	<b>Manual air conditioning system</b> ②: Turn the blower switch to level 0.
	<b>Climatronic</b> ①: Turn the blower switch to level 0.
AUTO	<b>Climatronic:</b> Automatic control of temperature, blower and distribution of air.
Display	<b>Climatronic</b> ②: Each activated function is shown on the display.

### Rear window heater

The button for the rear window heater  is located in the top part of the centre console. The rear window heater only works when the engine is running and switches itself off after 10 minutes at the latest.

### WARNING

Never switch off the blower for an extended period, as no fresh air enters the interior.

- Stale air can lead to rapid fatigue and decreased concentration of the driver and passengers, which can cause accidents and serious injuries.

## Operating information for the air conditioning system



First read and observe the introductory information and safety warnings  on page 117.

The cooling system for the vehicle interior works only when the engine is running and the blower is switched on.


The air conditioning system works most effectively when the windows are closed. However, if the interior is strongly heated up by direct sunlight in a stationary vehicle, briefly opening of the windows can accelerate the cooling process.

To avoid that the heating or cooling performance is affected and to prevent fogging of the windows, the air inlet in front of the windscreen must be free of ice, snow or leaves.


### Adjustment for optimum traffic safety

The activated cooling system not only lowers the temperature in the vehicle interior but also the air humidity. With high outside air humidity, this increases the well-being of the occupants and prevents fogging of the windows:

#### With manual air conditioning system

- Switch off recirculated air mode  $\Rightarrow$  page 121.
- Set the blower to the desired level position.
- Adjust the temperature control to the centre position.
- Open and align all air outlets in the instrument panel  $\Rightarrow$  page 121.
- Turn the air distribution control to the desired position.
- Press the button  to switch on the cooling system. The indicator light in the button illuminates.

#### With Climatronic

- Press the button .
- Set the temperature to +72 F (+22 °C).
- Adjust the temperature control to the centre position.
- Open all air outlets in the instrument panel  $\Rightarrow$  page 121.

### Changing the temperature unit in the Climatronic

Press and hold the buttons  and  simultaneously to change the temperature display from Celsius to Fahrenheit and vice versa.

### Heating

Maximum heat output and fastest thawing of the windows can only be achieved when the engine has reached its operating temperature.

### Cooling system cannot be switched on

If the cooling system cannot be switched on, this may have the following causes:

- The engine is not running.
- The blower is switched off.
- The fuse of the air conditioning system has blown.
- The ambient temperature is colder than approx. +38 °F (+3 °C).
- The AC compressor of the cooling system was shut down temporarily due to high engine coolant temperature.
- There is another fault in the vehicle. Have the air conditioning system checked by a specialist garage.

### Particulars

At high outside air humidity and high ambient temperatures, **condensation** may drip off the evaporator of the cooling system and form a pool of water under the vehicle. This is quite normal and not an indication of a leak!

### The dust and pollen filter

The dust and pollen filter with activated charcoal reduces the ingress of outside air contaminants into the interior of the vehicle.


The dust and pollen filter must be replaced according to the intervals specified in the service schedule in order not to impair the performance of the air conditioning system.

If the efficiency of the filter drops prematurely by operating the vehicle in heavily polluted outside air, the dust and pollen filter may need to be replaced between the listed service events.

#### Note

The air conditioning system adjusts the temperature inside the vehicle as soon as possible depending on the outside temperature.

#### Note

Due to residual humidity in the air conditioning system, the windscreen may become fogged after starting the engine. Switch on the defrost function to demist the windscreen as soon as possible. 

**i Note**

The air exiting from the air outlets and flowing through the entire interior escapes from the vehicle through the air vents below the rear window. The air vents must not be covered by clothing or other objects.

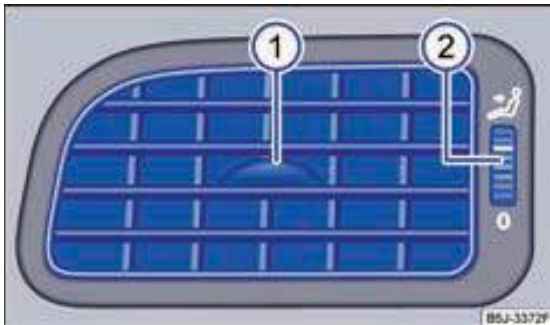
**Air outlets**

Fig. 77 In the instrument panel: Air outlet.



Fig. 78 In the rear part of the centre console: Air outlets.



First read and observe the introductory information and safety warnings  on page 117.

**Air outlets in the instrument panel**

To achieve adequate heating, cooling and ventilation inside the vehicle, never close the air outlets completely  $\Rightarrow$  fig. 77.

- To open and close the air outlets, turn the thumbwheel (2) in the desired direction.
- Use the handle in the ventilation grille (1) to adjust the outflow direction.

**Air outlets in the rear centre console**


Use the two handles  $\Rightarrow$  fig. 78 (3) in the ventilation grille to adjust the outflow direction.

Additional air outlets are in the footwells and in the rear of the vehicle interior.

**! NOTICE**



Do not place food, medication or other heat-sensitive objects in front of the air outlets. Heat- or cold-sensitive foods, medication, and objects may be damaged or rendered unusable by the escaping air.


**Recirculated air mode**

First read and observe the introductory information and safety warnings  on page 117.

**Basic information**


There are different types of recirculated air mode:



	Manual recirculated air mode (manual air conditioning system).
	Recirculated air mode (Climatronic).

Recirculated air mode  prevents the outside air from entering the passenger compartment.

At very hot or cold outside temperatures, manual recirculation mode should be selected for a short time to cool or heat the passenger compartment more quickly.

For security, recirculated air mode is switched off when the button  is pressed or the air distribution control is turned to   $\Rightarrow$  .

**Switching manual recirculated air mode on and off with manual air conditioning system **

**Switching on:** Press the appropriate button repeatedly until the indicator light illuminates above the symbol . 

*Switching off:* Press the appropriate button repeatedly until no indicator light illuminates in the button.

#### Switching manual recirculated air mode on and off with Climatronic

*Switching on:* Press the appropriate button repeatedly until the symbol illuminates on the display.

*Switching off:* Press the appropriate button repeatedly until no symbol illuminates on the display.

#### WARNING

Stale air can lead to rapid fatigue and decreased concentration of the driver, causing collisions, accidents and serious injuries.

- Never use recirculated air mode for an extended period, as no fresh air enters the interior.
- When the cooling system is switched off, the windows can become fogged very quickly in recirculated air mode, greatly limiting visibility.
- Always switch off recirculated air mode when it is not required.

#### NOTICE

Do not smoke in vehicles equipped with air conditioning in recirculated air mode. The drawn smoke may form deposits on the evaporator of the cooling system as well as on the dust and pollen filter, in Climatronic equipped with an activated charcoal insert, resulting in permanent odour nuisance.

#### Note

When the reverse gear is selected and while the automatic wash-wipe is working, the recirculated air mode is briefly activated to prevent the ingress of exhaust gasses into the vehicle. ■

## At the petrol station

### Refuelling

#### Introduction

This chapter contains information on the following subjects:

Indicator lights and fuel gauge .....	124
Filling petrol or diesel .....	125
Capacities .....	126
Checks when refuelling .....	126

The fuel filler flap is located on the rear right side of the vehicle.

#### Additional information and warnings:

- Exterior views ⇒ page 6
- Fuel ⇒ page 127
- Preparing to work in the engine compartment ⇒ page 131

#### WARNING

Improper refuelling and the improper handling of fuel can cause explosions, fire, serious burns and injuries.

- Always make sure the fuel filler cap is properly closed to prevent evaporation and spillage of fuel.
- Fuel is highly explosive and highly flammable and can cause severe burns and other injuries.
- If the engine is not switched off or the pump nozzle is not fully inserted into the fuel filler flap, fuel may spurt out and spill. This can cause fires, explosions, severe burns and injuries.
- When refuelling, the engine and the ignition must be switched off for security reasons.
- When refuelling, always switch off your mobile phone and walkie-talkie or other radio equipment. Electromagnetic radiation can cause sparks and thus trigger a fire.

#### WARNING (Continued)

- When refuelling, never get into the vehicle. If you have to get into your vehicle in exceptional cases, close the door and touch a metal surface before you touch the pump nozzle again. This will avoid electrostatic discharges, which may generate sparks. Sparks can cause a fire during refuelling.
- Never refuel or fill a spare canister near open flames, sparks or glowing objects (e.g. cigarettes).
- Avoid electrostatic discharge and electromagnetic radiation during refuelling.
- Observe the applicable safety notes of the petrol station.
- Never spill fuel in the vehicle or in the boot.

#### WARNING

For safety reasons, Škoda recommends not to carry a spare canister in the vehicle. Fuel may leak from the full or empty canister and ignite - especially in an accident. This can cause explosions, fires and injuries.

- If you want to carry fuel in a spare canister in exceptional cases, the following applies:
  - Never place the spare canister in or on the vehicle when refuelling, e.g. in the boot or on the boot lid. An electrostatic charge may build up during refuelling and ignite the fuel vapours.
  - Always place the spare canister on the floor.
  - Insert the pump nozzle as much as possible into the filler opening when filling a spare canister.
  - In metal spare canisters, the pump nozzle must always have contact with the canister while filling to avoid static charges.
  - Observe the legal requirements when using, storing and carrying a spare canister.
  - Make sure that the spare canister complies with the industry standard, for example ANSI or ASTM F852-86.

**NOTICE**

- Remove spilled fuel immediately from the vehicle paint to avoid damage to the wheel house, tyres and paint.
- Filling petrol into a vehicle with diesel engine, or diesel fuel into a vehicle with petrol engine may result in serious and expensive damage to the engine and the fuel system that is not covered by any Škoda warranty. If the vehicle was filled with the wrong fuel, in any case do not start the engine. This also

**NOTICE (Continued)**

- applies even if only a small amount of the wrong fuel has been filled in. Get professional assistance! The ingredients of these fuels can significantly damage the fuel system and the engine itself when the engine is running.
- Vehicles with diesel engines must never be fuelled and driven with petrol, kerosene, heating oil or other differing fuels that are not explicitly approved for diesel engines. Other fuels can cause serious and expensive engine damage and damage to the fuel system that are not covered by any Škoda warranty.

**For the sake of the environment**

Fuels can pollute the environment. Collect and properly dispose of spilled fluids.

**Note**

An emergency release of the fuel filler flap is not possible. Get professional assistance, if necessary.

**Indicator lights and fuel gauge**

Fig. 79 In the instrument cluster: Fuel gauge for petrol and diesel fuel.

First read and observe the introductory information and safety warnings on page 123.

**Fuel gauge for petrol and diesel fuel**

illuminates	Pointer position ⇒ fig. 79	Possible cause ⇒	Remedy
	Reserve marking (arrow)	Fuel tank is almost empty. Reserve amount is being consumed ⇒ page 126.	Refuel at the earliest opportunity ⇒ .

When switching on the ignition, some warning and indicator lights illuminate briefly as a function test. They will extinguish after a few seconds. ▶

**⚠ WARNING**

Driving with a low fuel level may result in breaking down in traffic, accidents and serious injuries.

- A low fuel level may lead to irregular fuel supply to the engine, especially when driving uphill or downhill.
- The steering, driver assist systems and brake assist systems do not work when the engine "sputters" or fails due to lack of fuel or irregular fuel supply.
- Always refuel when the fuel tank is still full to 1/4 to avoid breaking down due to lack of fuel.

**ⓘ NOTICE**

- Always take notice of illuminated indicator lights and corresponding descriptions and instructions to avoid vehicle damage.
- Never drive until the fuel tank is completely empty. Irregular fuel supply can cause misfire and unburnt fuel may enter into the exhaust system. This may damage the catalytic converter!

**ⓘ Note**

The small arrow next to the petrol pump icon on the display ⇒ [fig. 79](#) indicates on which side of the vehicle the fuel filler flap is located.

**Filling petrol or diesel**

**Fig. 80** In the rear right side panel: Open the fuel filler flap.



**Fig. 81** Open fuel filler flap with attached fuel filler cap.



First read and observe the introductory information and safety warnings ⚠ on page 123.

Always switch off the engine, ignition and mobile phone before refuelling and keep them off during the refuelling process.

**Opening the fuel filler cap**

- Press on the fuel filler flap located on the rear right of the vehicle ⇒ [fig. 80](#) (arrow). The fuel filler flap will spring forward slightly.
- Fully open the fuel filler flap.
- Unscrew the fuel filler cap counter-clockwise and hang it from above into the fuel filler flap ⇒ [fig. 81](#).

**Refuelling**

The correct type of fuel for the vehicle is indicated on a sticker on the inside of the fuel filler flap ⇒ [page 127](#).

- The fuel tank is *full* when the properly operated automatic pump shuts off the first time ⇒ ⚠.
- Do not continue refuelling after the pump has shut off! Otherwise the expansion space in the fuel tank fills up and the fuel may overflow, also by heating.

**Closing the fuel filler cap**

- Screw the fuel filler cap clockwise onto the filler tube until it clicks into place.
- Close the fuel filler flap until it clicks into place. The fuel filler flap should be flush with the body.

**⚠ WARNING**

Do not continue refuelling when the pump nozzle shuts off the first time. You could overfill the fuel tank. Fuel may spurt out and spill. This can cause fires, explosions or serious injuries.

**ⓘ NOTICE**

- Remove spilled fuel immediately from the vehicle paint to avoid damage to the wheel house, tyres and paint.

**♻ For the sake of the environment**

Spilled fuel can pollute the environment. ■

**Checks when refuelling**

First read and observe the introductory information and safety warnings ⚠ on page 123.

**Checklist**

Never work on the engine and in the engine compartment unless you are familiar with the necessary actions and the established precautions and/or proper equipment and fluids as well as adequate tools are available ⇒ page 131, Preparing to work in the engine compartment! Otherwise, have all work carried out by a specialist garage. Make sure that the following is checked on a regular basis, preferably during refuelling:

- ✓ Windscreen washer fluid level ⇒ page 77
- ✓ Engine oil level ⇒ page 136
- ✓ Engine coolant level ⇒ page 140
- ✓ Brake fluid level ⇒ page 104
- ✓ Tyre pressure ⇒ page 160
- ✓ Vehicle lighting, which is necessary for traffic safety:
  - Turn signals
  - Side lights, low beam lights and main beam lights
  - Rear lights
  - Brake lights
  - Rear fog light
  - Licence plate light

Information on bulb replacement ⇒ page 203. ■

**Capacities**

First read and observe the introductory information and safety warnings ⚠ on page 123.

	Fuel tank capacity
Petrol and diesel engines	approx. 55 litres <sup>a)</sup> , of which approx. 7.0 l reserve <sup>a)</sup> .

<sup>a)</sup> Data were not available at the time of printing. ■



## Fuel

### Introduction

This chapter contains information on the following subjects:

Fuel types .....	127
Petrol fuel .....	127
Diesel fuel .....	128
Information on fuel consumption .....	129
Fuel consumption .....	129
CO <sub>2</sub> emission .....	130

On the inside of the fuel filler flap, a sticker is attached at the factory, with the details of the correct fuel for the vehicle.

#### Additional information and warnings:

- ⇒ Booklet Service schedule
- Refuelling ⇒ page 123
- Engine control and exhaust system ⇒ page 181

#### WARNING

Improper handling of fuel can cause explosions, fire, serious burns and injuries.

- Fuel is highly explosive and flammable.
- Observe the applicable precautions and local regulations for handling fuels.

### Fuel types

 First read and observe the introductory information and safety warnings  on page 127.

The required type of fuel depends on the engine of the vehicle. On the inside of the fuel filler flap, a sticker is attached at the factory with the details of the fuel type for the vehicle.

Škoda recommends to always fill up low-sulphur or sulphur-free fuel to achieve lower fuel consumption and prevent engine damage.


Possible fuel types	Alternative names	More information
RON <sup>a)</sup> 91	Regular petrol, regular unleaded	
RON <sup>a)</sup> 95	Super petrol, premium, unleaded 95	⇒ page 127
RON <sup>a)</sup> 98	Super Plus petrol, unleaded 98	
Diesel		⇒ page 128

a)

### Petrol fuel

 First read and observe the introductory information and safety warnings  on page 127.

#### Types of petrol fuel

Vehicles with petrol engine must be operated with unleaded petrol in accordance with European Standard EN 228 ⇒ .

The petrol types vary in the octane number, such as 91, 95, 98 or 99 RON (RON = "Research Octane Number"). The vehicle may be refuelled with petrol, which has a higher octane number than the engine requires. However, this has no advantages in terms of fuel economy or engine performance.

Škoda recommends for petrol engines to use low-sulphur or sulphur-free fuel to achieve lower fuel consumption.

#### Petrol additives

The fuel quality affects the handling, performance and service life of the engine. Therefore, use high-quality petrol with additives. These additives protect against corrosion, clean the fuel system and prevent deposits from accumulating in the engine.

If high-quality petrol with additives is not available or engine problems occur, the required additive must be added while refuelling.

Not all petrol additives have proven to be effective. The use of unsuitable petrol additives can cause engine damage. Škoda recommends "Škoda original fuel additives for petrol engines". You can obtain these additives and information on how to use them from your Škoda partner. ▶

**NOTICE**


- Use only fuel according to EN 228 with a sufficient octane number. Otherwise considerable damage to the engine and fuel system may be caused. In addition, power reduction and engine failure may result.
- The use of unsuitable petrol additives can cause engine damage.
- If you have to use petrol fuel with an insufficient octane number in an emergency, the engine must be driven only at medium speeds and low load. Avoid high speeds and high engine load. Otherwise, engine damage may occur! Refuel with fuel of a sufficient octane number as soon as possible.
- Fuels which are labelled at the pump as containing metal must not be used. Also, LRP (lead replacement petrol) fuels contain metallic additives in high concentrations. Risk of engine damage!
- Even inadvertently filling the fuel tank only once with leaded petrol can cause a deterioration in the catalytic efficiency and considerable damage to the catalytic converter.

**Diesel fuel**

First read and observe the introductory information and safety warnings  on page 127.

**Diesel fuel**

Diesel fuel must meet the European standard EN 590 (in India IS 1460:2005).

For diesel fuels with higher sulphur content, shorter service intervals apply ⇒ Booklet service schedule ⇒ . Information on countries which have an increased sulphur content in diesel fuel can be obtained from a Škoda partner.

Fuel additives, so-called flow improvers, or similar products may not be added to the diesel fuel.

**Winter-grade diesel**

When using "summer-grade diesel" at temperatures below +32 °F (0 °C), operational problems may occur because the fuel becomes viscous as a result of paraffin separation. Therefore, there is in Germany for example "winter-grade diesel" available during the cold season, which is safe to use even below -4 °F (-20 °C).

It is often the case in countries with different climatic conditions that diesel fuels available have a different temperature characteristic. Your Škoda partner and petrol stations in the specific country provide information on their common diesel fuels.

It is normal that a cold diesel engine emits louder noise at cold temperatures than in warm weather. In addition, the exhaust gases during starting and in the warm-up phase may be slightly bluish. The amount of exhaust gas depends on the outside temperature.

**Filter preheating**

Diesel vehicles are equipped with a filter preheating system. This makes the fuel system – when using winter-grade diesel that is resistant to cold down to +5 °F (-15 °C) – safe to use down to approx. -11 °F (-24 °C).

However, if – at temperatures below -11 °F (-24 °C) – the fuel has become so viscous that the engine will not start, put the vehicle for some time in a heated garage or workshop to warm up.

**WARNING**

Never use a start booster. A start booster may explode or cause a sudden revving of the engine, causing serious injuries and damage to the engine.

**NOTICE**

- The vehicle is not suitable for use of biodiesel and must never be refuelled and driven with biodiesel. Otherwise, damage can occur to the fuel system and engine damage may be the result!
- Addition of biodiesel as part of EN 590 or an equivalent standard (e.g., DIN 51628 in Germany) to the diesel fuel by the diesel fuel producer is permitted and does not damage the engine or the fuel system.
- The diesel engine was designed exclusively for the use of diesel fuel. Therefore, do not use petrol, heating oil or other unsuitable fuels. The ingredients of these fuels can damage the fuel system and engine considerably.

## Information on fuel consumption



First read and observe the introductory information and safety warnings  on page 127.

The indicated fuel consumption and emission levels are not related to a specific vehicle, but are merely for purposes of comparison between different vehicle types. The fuel consumption and CO<sub>2</sub> emission of a vehicle depend not only on the efficient utilisation of fuel by the vehicle, but are also influenced by the driving style and other non-technical factors.

<b>Intra-urban</b>	The measurement of the intra-urban cycle begins with a cold start of the engine. This is followed by simulated city-driving at speeds between 0 and 30 mph (0 and 50 km/h).
<b>Extra-urban</b>	In the extra-urban driving cycle, the vehicle is accelerated and decelerated in all gears, corresponding to daily routine driving conditions. The speed varies between 0 and 74 mph (0 and 120 km/h).
<b>Combined</b>	The calculation of the combined fuel consumption considers a weighting of about 37 % for the intra-urban cycle and 63 % for the extra-urban cycle.
<b>CO<sub>2</sub> emissions combined</b>	To determine the combined carbon dioxide emissions during both cycles (intra-urban and extra-urban), the exhaust gases are collected. These exhaust gases are then evaluated and result in the CO <sub>2</sub> emission level, among other information.



### Note

The vehicle's unloaded weight may vary depending on the specific equipment. This may slightly increase the fuel consumption levels and CO<sub>2</sub> emissions.

### Determination of fuel consumption

The fuel consumption and emission levels were determined according to Directive 715/2007/EC or 80/1268/EEC in the version currently in force and apply to the specified vehicle's unloaded weight. The figures do **not** refer to a specific vehicle. To determine the fuel consumption, two measuring cycles are run on a chassis dynamometer. The following test conditions apply:



### Note

In practice, fuel consumption levels may result that are different from the levels that were determined by Directive 715/2007/EC or 80/1268/EEC.

## Fuel consumption



First read and observe the introductory information and safety warnings  on page 127.

For type approval or tax related reasons, the fuel consumption levels of some engines may differ from the specifications in other countries.

### Petrol engine

Engine power	MKB	Transmission	Fuel consumption according to Directive 715/2007/EC or 80/1268/EEC		
			Intra-urban	Extra-urban	Combined
77 kW	CLSA	SG5	— l/100 km <sup>a)</sup>	— l/100 km <sup>a)</sup>	6,6 l/100 km
		AG6	— l/100 km <sup>a)</sup>	— l/100 km <sup>a)</sup>	6,9 l/100 km

<sup>a)</sup> Data were not available at the time of printing.

**Diesel engine**

Engine power	MKB	Transmission	Fuel consumption according to Directive 715/2007/EC or 80/1268/EEC		
			Intra-urban	Extra-urban	Combined
77 kW	CLNA	SG5	– l/100 km <sup>a)</sup>	– l/100 km <sup>a)</sup>	4,9 l/100 km

<sup>a)</sup> Data were not available at the time of printing.

**CO<sub>2</sub> emission**

First read and observe the introductory information and safety warnings  on page 127.

**Petrol engine**

Engine power	MKB	Transmission	CO <sub>2</sub> emission
77 kW	CLSA	SG5	159 g/km
	CLSA	AG6	165 g/km

**Diesel engine**

Engine power	MKB	Transmission	CO <sub>2</sub> emission
77 kW	CLNA	SG5	129 g/km

# Maintenance, cleaning, servicing

## In the engine compartment


### Preparing to work in the engine compartment

#### Introduction

This chapter contains information on the following subjects:

Preparing the vehicle for work in the engine compartment .....	133
Opening and closing the bonnet .....	134

Before working in the engine compartment, be sure to park the vehicle safely on a horizontal and stable ground.

The engine compartment of a vehicle is a hazardous area. Never work on the engine and in the engine compartment if you are not familiar with the necessary actions and the established precautions and/or if proper equipment and fluids as well as adequate tools are not available ⇒ ! Otherwise, have all work carried out by a specialist garage. Serious injuries can be caused by improper work.

#### Additional information and warnings:

- Exterior views ⇒ page 6
- Windscreen wipers and washers ⇒ page 77
- Starting and stopping the engine ⇒ page 94
- Brake fluid ⇒ page 104
- Checks during refuelling ⇒ page 123
- Engine oil ⇒ page 136
- Engine coolant ⇒ page 140
- Vehicle battery ⇒ page 144
- Accessories, spare parts, repairs and modifications ⇒ page 172

#### WARNING

Unintended vehicle movement during maintenance work can cause serious injuries.

- Never work under the vehicle when it is not secured against rolling away. When working under the vehicle while the wheels touch the ground, the vehicle must be on a plane, the wheels locked and the vehicle key be removed from the ignition lock.
- If you want to work underneath the vehicle, you must additionally support the vehicle safely with axle stands. The car jack is insufficient for this purpose and can fail, causing serious injuries.

#### WARNING

The engine compartment of every vehicle is a hazardous area and may cause serious injuries!

- For all work, always be very cautious and careful and observe the common safety precautions. Never take a personal risk.
- Never carry out work on the engine and in the engine compartment if you are not familiar with the necessary actions. If you are uncertain as to steps involved, have the work done by an expert. Severe injuries can result from improperly performed work.
- Never open or close the bonnet, as long as steam or coolant escapes. Hot steam or coolant can cause severe burns. Always wait until you hear and see no more steam or coolant escape from the engine compartment.
- Always let the engine cool down before opening the bonnet.
- Hot parts of the engine or the exhaust system can burn the skin on contact.

**⚠ WARNING (Continued)**

- When the engine has cooled down, please note the following before opening the bonnet.
  - Firmly pull the handbrake and move the selector lever to position P or the gearshift lever into neutral.
  - Remove the vehicle key from the ignition lock.
  - Keep children away from the engine compartment and never leave them unattended.
- The engine cooling system is under pressure in a hot engine. Never open the lid of the engine coolant expansion reservoir on a hot engine. Coolant may spurt out and cause serious burns and injuries.
  - Turn the lid slowly and very carefully counter-clockwise while exerting light downward pressure on the lid.
  - Always protect your face, hands and arms from hot engine coolant or steam with a large, thick cloth.
- When refilling, do not spill fluids on engine parts or on the exhaust system. The spilled fluids can cause a fire.

**⚠ WARNING**

High voltage of the electrical system can cause electric shocks, burns, severe injuries and death!

- Never short-circuit the electrical system. The vehicle battery could explode.
- To reduce the risk of electric shock and serious injuries, while the engine is running or started, observe the following:
  - Never touch the electric wiring on the ignition system.

**⚠ WARNING**

The engine compartment contains rotating parts that can cause serious injuries.

- Never reach into the area or into the radiator fan. Contact with the rotor blades can cause serious injuries. The fan is temperature-controlled and can switch on independently - even when the ignition is switched off or if the vehicle key is removed from the ignition lock.

**⚠ WARNING (Continued)**

- If work needs to be done at start-up or when the engine is running, a life-threatening risk is posed by rotating parts (e.g. V-ribbed belt, alternator, radiator fan) and by the high-voltage ignition system. Always exercise extreme care.
  - Always make sure that no body parts, jewellery, ties, loose clothing and long hair can be caught in rotating engine parts. Before commencing work, always remove jewellery and ties, tie up long hair and tie loose clothing on the body to avoid that they may be caught in engine parts.
  - Always depress the accelerator pedal with extreme caution and never carelessly. The vehicle may start to move even when the handbrake is applied.
- Do not forget items such as cloths or tools in the engine compartment. Forgotten items may result in operational faults, engine damage and fire.

**⚠ WARNING**

Fluids and some materials in the engine compartment are highly flammable and can cause fires and serious injuries!

- Do not smoke.
- Never work near open flames or sparks.
- Never spill fluids on the engine. They can be ignited by hot engine parts, resulting in injuries.
- If work on the fuel system or the electrical system is required, observe the following:
  - Always disconnect the vehicle battery.
  - Never work near heaters, boilers or other open flames.
- Always have a functioning, approved fire extinguisher nearby.

**ⓘ NOTICE**

When replenishing or changing fluids, make sure that the fluids are in the correct reservoirs. Wrong fluids can cause serious operational faults and engine damage! ▶



### For the sake of the environment

Fluids leaking from the vehicle pollute the environment. Therefore, regularly check the ground under the vehicle. If you can see stains of oil or other fluids on the floor, have the vehicle checked by a specialist garage. Properly dispose of spilled or leaking fluids. ■

## Preparing the vehicle for work in the engine compartment



First read and observe the introductory information and safety warnings  on page 131.

### Checklist

Always carry out the following actions in the order given before commencing any work in the engine compartment → :

- ✓ Safely park the vehicle on a level and firm ground.
- ✓ Depress and hold the brake pedal until the engine is switched off.
- ✓ Firmly pull the handbrake.
- ✓ Move the gearshift lever or selector lever to position **P** ⇒ page 98.
- ✓ Switch off the engine and remove the ignition key from the ignition lock ⇒ page 94.
- ✓ Allow the engine to cool sufficiently.
- ✓ Always keep children and other people away from the engine compartment.
- ✓ Make sure that the vehicle cannot roll off unexpectedly.



### WARNING

Failure to observe the checklist essential for your own safety can cause serious injuries.

- Always follow the actions in the checklist and observe general safety precautions. ■

## Opening and closing the bonnet



Fig. 82 Left picture: Release lever in the footwell on the driver's side. Right picture: Release lever on the bonnet.

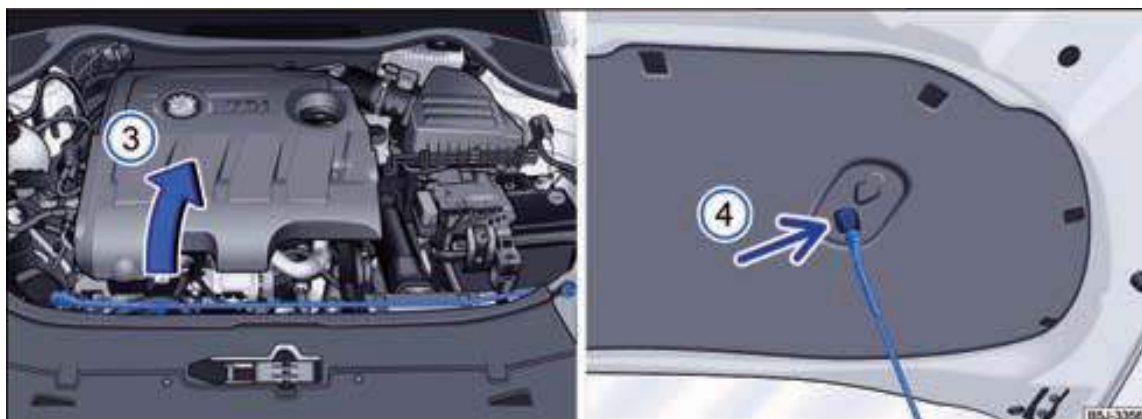








Fig. 83 Left picture: Folded bonnet support. Right picture: Attachment point of bonnet support.

 First read and observe the introductory information and safety warnings  on page 131.

### Opening the bonnet

- Before opening the bonnet, ensure that the windscreen wiper arms rest on the windscreen ⇒ .
- Open the driver's door and pull the release lever in the direction of the arrow ⇒ fig. 82 . The bonnet will jump from the locking of the lock carrier by spring force ⇒ .

- Lift the bonnet slightly while pressing the release lever in the direction of the arrow  to open the bonnet completely.
- Fold out the bonnet support from its holder in the direction of the arrow ⇒ fig. 83  and insert it into the opening .



### Closing the bonnet

- Slightly lift the bonnet and unhook the bonnet support from the opening ④  
⇒ ⚠.
- Press the bonnet support firmly into the holder ③.
- Let the bonnet drop into the lock of the lock carrier from a height of about 12 inches (30 cm) – do *not* push it in!

If the bonnet is not closed, open and close the bonnet properly again.

A properly closed bonnet should be flush with the surrounding body parts.

#### WARNING

If the bonnet is not closed properly, it could open suddenly while driving and obstruct the view ahead. This can cause accidents and serious injuries.

- After closing the bonnet, check that the bonnet has properly locked in place in the lock carrier. The bonnet must be flush with the surrounding body parts.
- If you notice while driving that the bonnet is not closed properly, immediately stop and close the bonnet.
- Open or close the bonnet only when no one is within the swivelling range.

#### NOTICE

- To avoid damage to the bonnet and the windscreen wiper arms, open the bonnet only with the windscreen wipers folded down.
- Do not forget to fold down the windscreen wiper arms before starting to drive.

## Engine oil

### Introduction

This chapter contains information on the following subjects:

Warning and indicator lights .....	136
Engine oil specification .....	136
Checking the engine oil level and replenishing engine oil .....	137
Engine oil consumption .....	138
Engine oil change .....	138

#### Additional information and warnings:

- ⇒ Booklet Service schedule
- Preparing to work in the engine compartment ⇒ page 131
- Accessories, spare parts, repairs and modifications ⇒ page 172

#### WARNING

Improper handling of engine oil can cause severe burns and injuries.



- Always wear eye protection when dealing with engine oil.
- Engine oil is toxic and must be kept out of the reach of children.
- Store engine oil only in its closed original container. This also applies to used oil until its disposal.
- Never use empty food cans, bottles or other containers for storage of used engine oil, because this may entice people to drink the contained engine oil.
- Frequent exposure to engine oil can damage the skin. Always wash skin contaminated with engine oil thoroughly with soap and water.
- Engine oil becomes extremely hot when the engine is running and can burn the skin severely. Always allow the engine to cool.

#### For the sake of the environment

Like any other fluids, leaking engine oil can pollute the environment. Collect and dispose of spilled fluids in a professional and environmentally responsible manner. ■

## Warning and indicator lights

 First read and observe the introductory information and safety warnings  on page 136.

Flashes	Possible cause	Remedy
	Engine oil pressure too low.	 <b>Do not drive the vehicle!</b> Switch off the engine. Check engine oil level. - If the warning light flashes, although the engine oil level is fine, do <i>not</i> continue to drive or keep the engine running. Engine damage may result. Get professional assistance.

When switching on the ignition, some warning and indicator lights illuminate briefly as a function test. They will extinguish after a few seconds.

#### WARNING

Ignoring illuminated warning lights and text messages may result in breaking down in traffic, accidents and serious injury.

- Never ignore illuminated warning lights and text messages.
- Stop the vehicle as soon as it is possible and safe to do so.

#### NOTICE


Ignoring illuminated indicator lights and text messages may lead to vehicle damage. ■

## Engine oil specification

 First read and observe the introductory information and safety warnings  on page 136.

The engine oil to be used must exactly meet the specifications.

The correct engine oil is important for the function and life of the engine. The factory fills in a special high-quality multigrade engine oil that can generally be used throughout the year.

If possible, use only engine oil approved by Škoda ⇒ . The listed engine oils are **multigrade fuel-economy oils**. ►

Engine oils are continuously being further developed. Škoda partners are always notified on any changes. Škoda therefore recommends to have the engine oil changed by a Škoda partner.

Engines	Engine oil specifications
77 kW petrol engine	VW 501 01, VW 502 00
77 kW diesel engine	VW 507 00

### ! NOTICE

- Only use the engine oil specification explicitly approved by Škoda. Use of other engine oils may cause engine damage!
- Do not mix additive lubricants with engine oil. Damages resulting from such additives are excluded from the warranty.

## Checking the engine oil level and replenishing engine oil

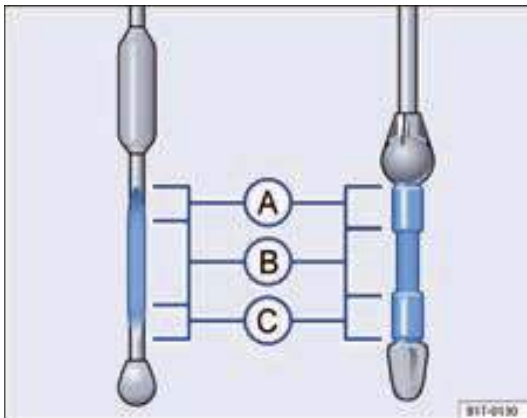





Fig. 84 Dipstick with engine oil level markings.




Fig. 85 In the engine compartment: Cap of the engine oil filler opening.

 First read and observe the introductory information and safety warnings  on page 136.


### Preparations

- Park the vehicle on a level surface to avoid reading an incorrect engine oil level.
- To check the engine oil level, make sure the engine is warm. Switch off the engine and wait a few minutes to allow the engine oil to return to the oil pan.
- Open the bonnet   $\Rightarrow$  page 131.
- The engine oil filler opening is indicated by the symbol  on the cap  $\Rightarrow$  fig. 85 and the oil dipstick by the coloured handle.

### Checking the engine oil level


- Pull out the oil dipstick from the guide tube and wipe it off with a clean cloth.
- Reinsert the dipstick into the guide tube as far as it goes. If there is a marking on the dipstick, this marking must fit into the corresponding groove at the upper end of the guide tube.
- Pull out the dipstick again and read off the engine oil level  $\Rightarrow$  table on page 138.
- After reading the engine oil level, insert the dipstick into the guide tube all the way down. 

## Engine oil level ranges

fig. 84	Necessary action depending on engine oil level:
Area A	Do not add oil ⇒  .
Area B	Oil can be added (approx. 0.5 l). The engine oil level may be in area A, but not above A.
Area C	Oil must be added (approx. 1.0 l). Make sure that the engine oil level is approximately in the middle of area B after refilling.

## Replenishing engine oil after checking the engine oil level

Replenish only small amounts of engine oil step by step.

- Unscrew the cap of the engine oil filler opening from the cylinder head ⇒ fig. 85. If it is not clear where the cap is, ask a specialist.
- Only replenish engine oil explicitly approved by Škoda in small amounts (no more than 0.5 l) ⇒ page 136.
- To avoid overfilling, wait after each refill, so the oil can flow into the oil pan up to the marking of the engine oil dipstick.
- Check the engine oil level again before adding a further small amount of oil. Never fill in too much engine oil ⇒ .
- When the engine oil level is at least in area ⇒ fig. 84 B, push the dipstick into the guide tube until it stops to prevent leakage of engine oil when the engine is running.
- After replenishing, replace and properly tighten the cap of the engine oil filler opening.

 **WARNING**

Engine oil may ignite if it spills on hot engine parts. This can cause fires, burns and other serious injuries.

- Always make sure that the cap of the engine oil filler opening is firmly tightened after replenishing. This will prevent hot engine oil from leaking on to hot engine parts when the engine is running.

 **NOTICE**

- Do not start the engine if the engine oil level is above area A. Get professional assistance. Otherwise, the catalytic converter and the engine can be damaged!
- When replenishing or changing fluids, make sure that the fluids are in the correct reservoirs. Wrong fluids can cause serious operational faults and engine damage!

 **For the sake of the environment**

The engine oil level must never be above area A. Oil may otherwise be drawn in through the crankcase ventilation and may pass through the exhaust system to the atmosphere.

**Engine oil consumption**

 **First read and observe the introductory information and safety warnings  on page 136.**

Engine oil consumption can vary from engine to engine and change during the life of the engine.

Depending on the driving style and conditions of use, the oil consumption may be up to 1 l/1200 miles (2000 km) - with new vehicles in the first 3000 miles (5000 kilometres) even more. The engine oil must therefore be checked at regular intervals - preferably while stopping for fuel and before long journeys.

For particular engine loads, the engine oil level should be in area ⇒ fig. 84 A, such as during long rides on the motorway in summer or when crossing mountain passes.

**Engine oil change**

 **First read and observe the introductory information and safety warnings  on page 136.**

The engine oil must be changed regularly according to the specification in the service schedule.

Always have the engine oil and filter change carried out by a specialist garage on the basis of the required special tools and expertise as well as the disposal of the used oil. Škoda recommends a Škoda partner for this purpose. ▶

For more information on the service intervals, please see the service schedule.

Additives in the engine oil make new engine oil appear dark after a short engine-running time. This is normal and there is no reason to change the engine oil more frequently.

### **WARNING**

If, in exceptional cases, you need to perform an engine oil change by yourself, observe the following:

- Always wear eye protection.
- Always allow the engine to cool completely in order to prevent burns.
- Keep your arms horizontal when unscrewing the oil drain plug with your fingers to prevent the exiting oil from running down your arm.
- To collect the used oil, use a suitable container that can hold at least the entire oil quantity of the engine.
- Never use empty food cans, bottles or other containers for storage of used engine oil, as people may not always recognise the contained engine oil.
- Engine oil is toxic and must be kept out of the reach of children.

### **For the sake of the environment**

Before an engine oil change, first find a place for proper disposal of used oil.

### **For the sake of the environment**


Dispose of used oil in an environmentally friendly manner. Never dispose of used oil, for example, in your garden, in forest areas, via the sewage system, on roads and trails, in rivers or bodies of water. ■

## Engine coolant

### Introduction

This chapter contains information on the following subjects:

Engine coolant temperature warning light .....	140
Engine coolant specification .....	141
Checking the engine coolant level and replenishing engine coolant .....	142

Never carry out work on the engine cooling system unless you are familiar with the necessary actions and the appropriate tools and correct equipment and fluids are available → ! Otherwise, have all work carried out by a specialist garage. Škoda recommends a Škoda partner for this purpose.


Serious injuries can be caused by improper work.

#### Additional information and warnings:

- Preparing to work in the engine compartment → page 131
- Accessories, spare parts, repairs and modifications → page 172

### Engine coolant temperature warning light

 **First read and observe the introductory information and safety warnings  on page 140.**

** WARNING**





**Engine coolant is toxic!**

- Store engine coolant only in sealed containers and in a safe place.
- Never use empty food cans, bottles or other containers for storage of engine coolant, since people could drink the contained engine coolant.
- Keep engine coolant out of the reach of children.
- Be sure to use the correct amount of coolant additive according to the lowest expected ambient temperature at which the vehicle is operated.
- At extremely low outside temperatures, the coolant may freeze and the vehicle may break down. Because the heater then stops working, passengers may freeze to death without adequate winter clothing.

#### For the sake of the environment

Coolant and coolant additives may pollute the environment. Collect and properly dispose of leaking fluids in an environmentally responsible manner. ■

When switching on the ignition, some warning and indicator lights illuminate briefly as a function test. They will extinguish after a few seconds.

illuminates	Possible cause	Remedy
	Engine coolant temperature too high.	 <b>Do not drive the vehicle!</b> Stop the vehicle as soon as it is possible and safe to do so. Switch off the engine, let the engine cool until the warning and indicator lights go off. Check the engine coolant level → page 142.
	Engine coolant system is disturbed.	 <b>Do not drive the vehicle!</b> Seek professional help!
Flashes	Possible cause	Remedy
	Engine coolant system is disturbed.	Get professional assistance! ▶

**⚠ WARNING**

Ignoring illuminated warning lights and text messages may result in breaking down in traffic, accidents and serious injury.

- Always pay attention to illuminated warning lights and text messages.
- Never ignore illuminated warning lights and text messages.
- Stop the vehicle as soon as it is possible and safe to do so.

**ⓘ NOTICE**

Ignoring illuminated indicator lights and text messages may lead to vehicle damage.

**Engine coolant specification**


First read and observe the introductory information and safety warnings  on page 140.

The engine cooling system is filled with a mixture of specially treated water and at least 40 per cent of engine coolant additive **G 12 plus-plus** (TL-VW 774 G) or **G 12 plus** (TL-VW 774 F). Both engine coolant additives are identified by their purple colour.

This mixture provides not only antifreeze protection down to -13 °F (-25 °C), but also protects the light metal parts in the engine cooling system from corrosion. The mixture also prevents calcification and increases the boiling point of the engine coolant significantly.

To protect the engine cooling system, the engine coolant additive content must *always* be at 40 %, even when no antifreeze protection is required in warm weather or warm climate.

If stronger antifreeze protection is required for climatic reasons, the proportion of the engine coolant additive may be increased. However, the proportion of the engine coolant additive must not be more than 60 %, otherwise the antifreeze protection is reduced again and the cooling effect deteriorates.

When replenishing engine coolant, a mixture of **distilled water** and at least 40 % of engine coolant additive G 12 plus-plus should be used to obtain the optimum corrosion protection ⇒ .

**⚠ WARNING**

Lack of antifreeze protection in the engine cooling system can lead to engine failure and cause serious injuries.

- Be sure to use the correct amount of coolant additive according to the lowest expected ambient temperature at which the vehicle is operated.
- At extremely low outside temperatures, the coolant may freeze and the vehicle may break down. Because the heater then stops working, passengers may freeze to death without adequate winter clothing.

**ⓘ NOTICE**

Never mix original engine coolant additives with other engine coolants that are not approved by Škoda. Mixing with third-party coolants may lead to serious damage to the engine and engine cooling system.

- The engine coolant G 12 plus-plus can be mixed with G 12 plus and G 11.
- If the fluid in the engine coolant expansion reservoir is not purple but, for example, brown, G 12 plus-plus or G 12 plus was mixed with a different engine coolant. In this case, the engine coolant must be changed immediately. Otherwise, this could cause severe malfunctions or damage to the engine!

**For the sake of the environment**

Engine coolants and engine coolant additives may pollute the environment. Collect and properly dispose of leaking fluids in an environmentally responsible manner.

## Checking the engine coolant level and replenishing engine coolant






Fig. 86 In the engine compartment: Marking on the engine coolant expansion reservoir.



Fig. 87 In the engine compartment: Cap of the engine coolant expansion reservoir.

 First read and observe the introductory information and safety warnings  on page 140.





### Preparations

- Park the vehicle on a level and solid surface.
- Allow the engine to cool  $\Rightarrow$  .
- Open the bonnet   $\Rightarrow$  page 131.
- The expansion reservoir of the engine coolant can be identified by the symbol  on the cap  $\Rightarrow$  fig. 87.

### Checking the engine coolant level

- When the engine is cold, check the engine coolant level by the marking on the side of the expansion reservoir  $\Rightarrow$  fig. 86.
- Add engine coolant, if the fluid level in the reservoir is below the minimum marking ("min"). When the engine is warm, the engine coolant level may be slightly above the upper edge of the marked range.

### Replenishing engine coolant

- Always protect your face, hands and arms from hot engine coolant or steam by placing a suitable cloth on the cap of the expansion reservoir.
- Unscrew the cap carefully  $\Rightarrow$  .
- Fill in only **new** engine coolant according to Škoda specification ( $\Rightarrow$  page 141)  $\Rightarrow$  .
- The engine coolant level should be within the markings of the expansion reservoir  $\Rightarrow$  fig. 86. **Do not replenish beyond the upper edge of the marked range**  $\Rightarrow$  .
- Replace and firmly tighten the cap.
- If engine coolant according to the required specification ( $\Rightarrow$  page 141) is not available in an emergency, do not use any other engine coolant additive! Instead, add only **distilled water** initially  $\Rightarrow$  . Then have the proper mixture ratio be restored with the specified engine coolant additive as soon as possible  $\Rightarrow$  page 141.

### WARNING

Hot steam or engine coolant can cause severe burns.

- **Never open the bonnet if you see or hear steam or engine coolant escape from the engine compartment. Always wait until you no longer see or hear steam or engine coolant escape.**
- **Always allow the engine to cool completely before carefully opening the bonnet. Hot surfaces can burn the skin on contact.**



**⚠ WARNING (Continued)**

- When the engine has cooled down, please note the following before opening the bonnet.
  - Firmly pull the handbrake and move the selector lever to position P or the gearshift lever into neutral.
  - Remove the vehicle key from the ignition lock.
  - Keep children away from the engine compartment and never leave them unattended.
- The engine cooling system is under pressure in a hot engine. Never open the lid of the engine coolant expansion reservoir on a hot engine. Coolant may spurt out and cause serious burns and injuries.
  - Turn the lid slowly and very carefully counter-clockwise while exerting light downward pressure on the lid.
  - Always protect your face, hands and arms from hot engine coolant or steam with a large, thick cloth.
- When refilling, do not spill fluids on engine parts or on the exhaust system. The spilled fluids can cause a fire. Under certain circumstances, the ethylene glycol of the engine coolant can catch fire.

**⚠ NOTICE**

- Refill only distilled water! All other types of water can cause serious corrosion in the engine due to the chemical components contained. This may also lead to engine failure. If water other than distilled water was replenished, the entire fluid in the engine cooling system should be immediately replaced by a specialist garage.
- Replenish engine coolant only up to the upper edge of the marked range ⇒ [fig. 86](#). Otherwise, excess engine coolant will be forced out of the engine cooling system when it heats up, causing damage.
- In case of larger engine coolant loss, fill in engine coolant only when the engine has *cooled down completely*. Larger loss of engine coolant indicates a leakage in the engine cooling system. Have the engine cooling system checked immediately by a specialist garage. Otherwise, engine damage may occur!
- When replenishing fluids, ensure that you fill the correct reservoirs. The use of wrong fluids can result in serious malfunctions and engine damage!


## Vehicle battery

### Introduction

This chapter contains information on the following subjects:

Warning light .....	145
Checking the electrolyte level of the vehicle battery .....	145
Charging, replacing, disconnecting or connecting the vehicle battery .....	145






The vehicle battery is part of the electrical system in the vehicle.

Never work on the electrical system if you are not familiar with the necessary actions and the established precautions and/or if proper operating material and fluids as well as adequate tools are not available ⇒ ! Otherwise, have all work carried out by a specialist garage. Škoda recommends a Škoda partner for this purpose. Serious injuries can be caused by improper work.

#### Installation position of the vehicle battery

The vehicle battery is located in the engine compartment.

#### Explanation of the warnings on the vehicle battery

Symbol	Meaning
	Always wear eye protection!
	Battery acid is highly corrosive. Always wear gloves and eye protection!
	Fire, sparks, open flames and smoking are forbidden!
	During charging of the battery, a highly explosive gas mixture is produced!
	Always keep children away from acid and the vehicle battery!

#### Additional information and warnings:

- ⇒ Booklet Service schedule
- Preparing to work in the engine compartment ⇒ page 131
- Accessories, spare parts, repairs and modifications ⇒ page 172

### WARNING

Work on the vehicle battery and the electrical system can cause severe chemical burns, fire or electric shock. Before performing any work, always read and observe the following warnings and precautions:

- Before performing any work on the vehicle battery, switch off the ignition and all electrical loads, and disconnect the negative terminal of the battery.
- Always keep children away from the battery acid and vehicle battery.
- Always wear eye protection.
- Battery acid is very aggressive. You may chemically burn the skin and cause blindness upon contact with the eyes. When handling the vehicle battery, protect especially your hands, arms and face from acid splashes.
- Do not smoke and never work near open flames or sparks.
- Avoid sparks when dealing with cables and electrical equipment, and by electrostatic discharge.
- Never short-circuit the battery terminals.
- Never use a damaged vehicle battery. It may explode. Replace a damaged vehicle battery immediately.
- Replace a damaged or frozen vehicle battery immediately. A discharged battery may start to freeze at temperatures around 0 °C (+32 °F).

### NOTICE

- Never disconnect vehicle batteries or connect them with each other with the ignition switched on or the engine running, since otherwise the electrical system or electronic components will be damaged.
- Do not expose the vehicle battery to direct sunlight for extended periods of time, because UV radiation may damage the battery housing.
- Protect the vehicle from frost during longer periods of non-use so that the vehicle battery does not "freeze" and hence will be destroyed.

### Warning light



First read and observe the introductory information and safety warnings on page 144.

Illuminates	Possible cause	Remedy
	Alternator is disturbed.	Visit a specialist garage. Have the electrical system checked. Switch off unnecessary electrical loads. Vehicle battery is not charged by the alternator while driving.

When switching on the ignition, some warning and indicator lights illuminate briefly as a function test. They will extinguish after a few seconds.

#### WARNING

Ignoring illuminated warning lights and text messages may result in breaking down in traffic, accidents and serious injury.

- Never ignore illuminated warning lights and text messages.
- Stop the vehicle as soon as it is possible and safe to do so.

#### NOTICE

Ignoring illuminated indicator lights and text messages may lead to vehicle damage.

### Checking the electrolyte level of the vehicle battery



First read and observe the introductory information and safety warnings on page 144.

Regularly check the electrolyte level of the vehicle battery at high mileage, in countries with warmer climates and with an old car battery. The vehicle battery is otherwise maintenance free.

#### Preparations

- Prepare the vehicle for work in the engine compartment  $\Rightarrow$  page 131.
- Open the bonnet  $\Rightarrow$  page 131.

### Checking the battery electrolyte level

- Provide for adequate lighting to see the colours clearly. Never use open flames or smouldering objects as lighting.
- The round window at the top of the vehicle battery changes its colour depending on the electrolyte level.

Colour display	Action
Light yellow or colourless	Electrolyte level of the vehicle battery is too low. Have the vehicle battery checked and replaced, if necessary, at a specialist garage.
Black	Electrolyte level of the vehicle battery is fine.

#### WARNING

Work on the vehicle battery may cause severe chemical burns, explosions or electric shocks.

- Always wear eye protection and gloves.
- Battery acid is very aggressive. You may chemically burn the skin and cause blindness upon contact with the eyes. When handling the vehicle battery, protect especially your hands, arms and face from acid splashes.
- Never tilt the vehicle battery. Acid could leak from the venting openings, causing chemical burns.
- Never open a vehicle battery.
- If acid splashes on skin or in the eyes, rinse the affected area immediately with cold water for several minutes. Then consult a doctor immediately.
- If acid was swallowed, seek immediate medical attention.

### Charging, replacing, disconnecting or connecting the vehicle battery



First read and observe the introductory information and safety warnings on page 144.

#### Charging the vehicle battery

Charging the vehicle battery should be carried out by a specialist garage, because the technology of the factory-installed vehicle battery requires a voltage-limited charging method  $\Rightarrow$  Škoda recommends a Škoda partner for this purpose.  $\blacktriangleright$

### Replacing the vehicle battery

The vehicle battery is designed according to the installation position and equipped with safety features. If a vehicle battery needs replacing, before purchasing a new battery, consult your Škoda partner about the electromagnetic compatibility, size, and necessary maintenance, capacity and security requirements of the new battery. Škoda recommends having the vehicle battery replaced by a Škoda partner.

Use only a maintenance-free vehicle battery according to standards TL 825 06 and VW 7 50 73. These standards should be from April 2008 or later.

### Disconnecting the vehicle battery

If the vehicle battery needs to be disconnected from the electrical system in the vehicle, observe the following:

- Switch off all electrical loads and turn off the ignition.
- First disconnect the negative cable and then disconnect the positive cable ⇒ ⚠.

### Connecting the vehicle battery

- Before reconnecting the vehicle battery, switch off all electrical loads and switch off the ignition.
- First reconnect the positive cable, then reconnect the negative cable ⇒ ⚠.

After connecting the vehicle battery and switching on the ignition, various indicator lights may illuminate. They will extinguish after driving a short distance at approx. 9 - 12 mph (15 - 20 km/h). If the indicator lights continue to illuminate, visit a specialist garage and have the vehicle checked.

If the vehicle battery has been disconnected a long time, the next due service may not be displayed or calculated correctly ⇒ page 19. Observe the maximum allowable maintenance intervals ⇒ Booklet service schedule.

### Automatic load deactivation

An intelligent vehicle power management system automatically takes various measures at high loads on the vehicle battery to prevent discharging of the battery:

- The idling speed is increased to allow the alternator to generate more electricity.
- Large consumers of electricity may be cut in their power consumption or fully switched off if necessary.
- When starting the engine, the power supply to the 12-Volt power sockets and the cigarette lighter may be briefly interrupted.

Despite the vehicle power management, the vehicle battery may be discharged. For example, when the ignition is switched on a long time with the engine turned off or the side or parking lights are turned on during longer parking.

### What will exhaust the vehicle battery?

- Long standing times, without running the engine, particularly when the ignition is switched on.
- Use of electrical loads with the engine switched off.

#### WARNING

Improper mounting and using wrong vehicle batteries can cause short circuits, fire and serious injuries.

- Use only maintenance-free and leak-proof vehicle batteries that have the same characteristics, specifications and dimensions as the factory-installed battery. The specification is indicated on the battery housing.

#### WARNING

When charging the vehicle battery, a highly explosive gas mixture is produced.

- Charge the vehicle battery only in a well-ventilated area.
- Never charge frozen or thawed vehicle batteries. A discharged battery may start to freeze at temperatures around 0 °C (+32 °F).
- Be sure to replace the vehicle battery if it has frozen once.
- Incorrectly connected wires may cause a short circuit. First connect the positive cable and then the negative cable.

#### NOTICE

- Never disconnect the vehicle battery with the ignition switched on or the engine running, since otherwise the electrical system or electronic components will be damaged.
- Never connect power-supplying accessories, such as solar panels or a battery charger for charging the vehicle battery, to the 12-Volt power sockets or the cigarette lighters. Otherwise, the electrical system of the vehicle could be damaged.

#### For the sake of the environment

Properly dispose of the vehicle battery. Vehicle batteries may contain toxic substances such as sulphuric acid and lead. ▶



**For the sake of the environment**

Battery acid may pollute the environment. Collect and properly dispose of leaking fluids. ■

## Care and maintenance of the vehicle

### Maintaining and cleaning the vehicle exterior

#### Introduction

This chapter contains information on the following subjects:

Washing the vehicle .....	149
Washing with a high-pressure cleaner .....	150
Cleaning windows and exterior mirrors .....	150
Cleaning and replacing the wiper blades .....	151
Service position of the windscreen wipers .....	152
Preserving and polishing the vehicle paintwork .....	153
Maintaining and cleaning gloss parts .....	153
Cleaning the rims .....	153
Maintaining rubber seals .....	154
De-icing the door lock cylinders .....	154
Underbody protection .....	154
Cleaning the engine compartment .....	154

Regular and proper care helps **maintain the value** of your vehicle. Proper care may be one of the conditions for recognition of warranty claims for corrosion and paint damage to the body.

Suitable care products are available from your Škoda partner.

#### Additional information and warnings:

- Power windows ⇒ page 42
- Windscreen wipers and washers ⇒ page 77
- Preparing to work in the engine compartment ⇒ page 131
- Maintaining and cleaning the interior ⇒ page 156
- Accessories, spare parts, repairs and modifications ⇒ page 172

#### WARNING

Care products can be toxic and dangerous. Improper care products and improper application of care products can cause accidents, serious injuries, burns and poisoning.

- Store care products only in their closed original containers.
- Observe the package inserts.
- Never use empty food cans, bottles or other containers for storage of care products, as people may not always recognise the contained care products.
- Keep children away from all care products.
- Harmful vapours may form during the application. Therefore, use care products only outdoors or in well-ventilated areas.
- Never use fuel, turpentine, engine oil, nail polish remover or other volatile liquids for washing, grooming or cleaning. They are toxic and highly flammable.

#### WARNING

Improper care and cleaning of vehicle parts may affect the safety equipment of the vehicle and cause serious injuries.

- Clean and treat vehicle parts only according to the manufacturer's instructions.
- Use approved or recommended cleaning agents.

#### NOTICE

Solvent-based cleaners attack the material and can damage it.

#### For the sake of the environment

Wash the vehicle only at specially designated wash areas to prevent the dirty water contaminated with oil, grease and fuel from entering the sewage system. In some regions, it is not permitted to wash your vehicle except at such specific washing bays.

#### For the sake of the environment

Preferably choose environmentally friendly products when buying care products. ►




### For the sake of the environment

Do not dispose of residues of care products in domestic waste. Observe the package inserts.


## Washing the vehicle



First read and observe the introductory information and safety warnings  on page 148.

The longer insect residues, bird droppings, tree sap, road and industrial dust, tar, soot particles, road salt and other aggressive deposits remain adhering to the paintwork of your vehicle, the more detrimental their destructive effect can be. High temperatures, such as by intense sun exposure increase the corrosive effect. Also the **underside** of the vehicle should thoroughly be washed regularly.

### Car wash plant

**Follow the information on the notice board of the car wash operator.** Take the usual precautionary measures before washing your vehicle in an automatic car wash plant, e.g., close all windows and fold in the exterior mirrors to avoid damage. If your vehicle has special attachments, such as spoilers, two-way radio aerial, consult the operator of the car wash plant ⇒ .

The paintwork of the vehicle is sufficiently resistant so that the vehicle can be washed normally in automatic car wash plants without any problem. However, the actual stress of the paintwork is strongly dependent on the design of the car wash plant. Škoda recommends washing in car wash plants without brushes.

In order to remove any existing wax residues on the windows and possibly juddering of the wiper blades, observe the following ⇒ page 150, Cleaning windows and exterior mirrors.

### Washing your vehicle by hand

When washing by hand, first soften the dirt with water and rinse off as much as possible.

Then clean the vehicle with a soft **sponge**, a **washing glove** or a **washing brush** using only slight pressure. Start on the roof and continue to work from top to bottom. Use a **shampoo** only for stubborn dirt.

Wash out the sponge or washing glove thoroughly at short intervals.

Clean wheels, door sills and similar parts last. Use a second sponge for such areas.



### WARNING

Sharp edges on the vehicle can cause injury.

- Protect your hands and arms from sharp-edged parts when you are cleaning, for example, the underfloor or the inside of the wheel housings.



### WARNING

After a car wash, the braking effect may be delayed due to wet and, in winter, icy brake discs and brake pads, extending the braking distance.

- "Dry and free the brakes from ice" by careful braking actions. In doing so, do not endanger other motorists or ignore statutory provisions.



### NOTICE

- The water should not be hotter than +140 °F (+60 °C).
- To avoid damage to the paintwork, do not wash the vehicle in the blazing sun.
- Do not use any insect sponges, rough kitchen sponges or similar cleaning products, otherwise the surface may be damaged.
- Never clean the headlights with a dry cloth or sponge, but always wet. It is best to use soapy water.
- Vehicle wash in cold weather: When spraying your vehicle down with a hose, do not aim the water jet directly at the locks or at the door or lid joints. The locks and seals might freeze!



### NOTICE


Be sure to observe the following points before driving your vehicle into a car wash plant, in order to avoid damage to the vehicle:


- Compare the track gauge of the vehicle with the distance between the guide rails of the car wash plant, to prevent damage to rims and tyres!
- Compare the height and width of the vehicle with the headroom and width of the car wash plant!
- Fold in the exterior mirrors.
- To avoid damages to the paintwork of the bonnet, fold the wiper blades against the windscreen after drying the windscreen wipers. Do not drop them!

## Washing with a high-pressure cleaner



First read and observe the introductory information and safety warnings  on page 148.

When you wash your vehicle with a high-pressure cleaner, it is essential to comply with the instructions for use of the cleaning equipment. This applies in particular to the **pressure** used and to the **spraying distance** .

Maintain a sufficiently large distance to soft materials such as rubber hoses or insulation material and to the sensors of the park distance control. The park distance control sensors are located in the rear bumper .

Never use **circular spray nozzles** or **dirt cutters** .

### WARNING

Improper use of a high-pressure cleaner can cause permanent, visible or invisible damage to tyres and other materials. This can cause accidents and serious injuries.

- Keep a sufficiently large distance between the spray nozzle and the tyres.
- Never clean the tyres with circular spray nozzles ("dirt cutters"). Damage to tyres may occur even with a relatively large spraying distance and spraying only for a very short time.

### WARNING

After a car wash, the braking effect may be delayed due to wet and, in winter, icy brake discs and brake pads, extending the braking distance.

- "Dry and free the brakes from ice" by careful braking actions. In doing so, do not endanger other motorists or ignore statutory provisions.

### NOTICE


- The water should not be hotter than +140 °F (+60 °C).
- To avoid damage to the paintwork, do not wash the vehicle in the blazing sun.

### NOTICE (Continued)

- To ensure that the park distance control works properly, the sensors in the bumper must be kept clean and free of ice. When cleaning with high-pressure cleaners or steam jets, spray the sensors directly only a short time and always at a distance greater than approx. 4 inches (10 cm).
- Do not clean icy or snow-covered windows with a high-pressure cleaner.
- Vehicle wash in cold weather: When spraying your vehicle down with a hose, do not aim the water jet directly at the locks or at the door or lid joints. The locks and seals might freeze!

## Cleaning windows and exterior mirrors




First read and observe the introductory information and safety warnings  on page 148.

### Cleaning windows and exterior mirrors


Moisten the windows and exterior mirrors with a standard alcohol-based glass cleaning agent.

Dry the glass surfaces with a clean chamois leather or a lint-free cloth. A leather cloth that was used to wipe the paintwork contains greasy residues of preservatives and could therefore contaminate the glass.

Rubber, oil, grease or silicone residue can be removed with a glass cleaner or silicone remover .

### Removing wax residues

Car wash plants and other cleaning agents leave **wax residues** on all glass surfaces. Such wax residues can be removed only with a special cleaning agent or cleaning cloths. Wax residues on the windscreen can cause juddering of the windscreen wipers. Škoda recommends that you remove the wax residues on the windscreen with a cleaning cloth.

Juddering can be eliminated by filling a windscreen cleaner with wax-dissolving properties into the windscreen washer fluid reservoir. Maintain the proper mixing ration when filling in the cleaning agent. Degreasing cleaners are not able to remove such wax residues .

### Removing snow

Remove snow from all windows and exterior mirrors with a hand broom. 



### Removing ice

Ice is best removed with a de-icing spray. When using an ice scraper, do **not** move it back and forth, but move it in one direction only. Dirt may scratch the window when you move the scraper backward.

#### **⚠ WARNING**

Dirty and fogged windows reduce visibility and increase the risk of accidents and serious injuries.

- Only drive if you have clear view through all windows.
- Remove ice, snow and fog from all windows inside and outside.

#### **ⓘ NOTICE**

- Never mix the recommended cleaning agents with other cleaning agents in the windscreen washer fluid reservoir. Otherwise, this could cause flocculation of the ingredients resulting in clogging of the windscreen washer nozzles.
- Do not remove snow or ice from windows and mirrors with warm or hot water. Otherwise the glass may crack!
- The heating elements of the rear window heater are located on the inside of the rear window. Do not paste stickers over the heating elements and never clean the inside of the rear window with caustic or acidic cleaning agents and other chemicals.
- Aerials located on the inside of the windows may be damaged by abrasive or caustic and acidic cleaning agents and other chemicals. Do not paste stickers over the window aerial and never clean the aerials with caustic or acidic cleaning agents and other chemicals.

### Cleaning and replacing the wiper blades

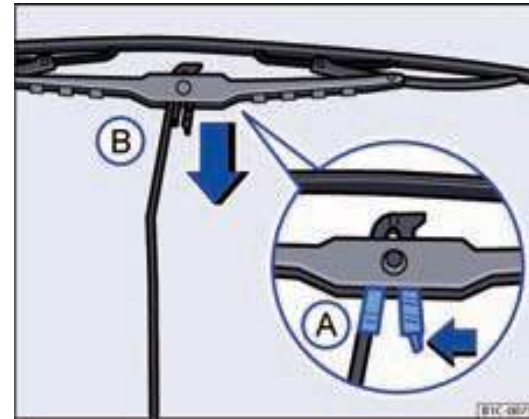


Fig. 88 Replacing the windscreen wiper blades.



First read and observe the introductory information and safety warnings **⚠** on page 148.

The factory-fitted wiper blades are coated with a graphite layer. The graphite layer ensures that the wiper blade wipes gently over the glass with low noise. A damaged graphite layer causes an increased noise level when wiping across the windscreen, among other problems.

Regularly check the condition of wiper blades. **Replace juddering wiper blades** if they are damaged or clean them if they are dirty ⇒ **ⓘ**.

Damaged wiper blades should be replaced immediately. Wiper blades are available from a specialist garage.

#### Lifting and folding the wiper arms away

Touch the wiper arms **only** in the area of the wiper arm mounting in order to lift or fold away the wipers.

Bring the wiper arms to the service position before folding them away ⇒ page 152.

#### Cleaning the wiper blades

- Lift and fold away the wiper arms.
- Remove dust and dirt from the wiper blades carefully with a soft cloth.
- Remove intensive dirt on the wiper blades gently with a sponge or cloth ⇒ **ⓘ** ▶

### Replacing windscreen wiper blades

- Lift and fold away the wiper arms.
- Press the release ⇒ fig. 88 (A) and simultaneously pull the wiper blade in the direction of the arrow (B).
- Unhook the wiper blade and remove it in the opposite direction of the arrow (B).
- Slide the new wiper blade of the **same length and type** slightly in the direction of the arrow (B) and hook it into the wiper arm.
- Pull the wiper blade in the opposite direction of the arrow (B) until it snaps into place.
- Fold the wiper arms back to the windscreen.

#### WARNING

Worn or dirty wiper blades reduce visibility and increase the risk of accidents and serious injuries.

- Always replace wiper blades whenever they are damaged or worn and not able to clean the windscreen sufficiently.

#### NOTICE


- Damaged or dirty wiper blades may scratch the glass.
- Solvent-based cleaners, harsh sponges and other sharp objects damage the graphite layer of the wiper blades during cleaning.
- Do not clean the windows with fuel, nail polish remover, paint thinner or similar liquids.

### Service position of the windscreen wipers



Fig. 89 Windscreen wiper in service position.




First read and observe the introductory information and safety warnings  on page 148.

In the service position, the wiper arms can be folded away from the windscreen ⇒ fig. 89. To bring the windscreen wipers into the service position, do the following:

- The bonnet must be closed ⇒ page 131.
- Switch on the ignition.
- Briefly push down the windscreen wiper lever ⇒ fig. 48 (4).
- When the wipers are in the highest position ⇒ fig. 89, switch off the ignition.

Fold the wiper arms back to the windscreen before starting to drive! The wiper arms will move back to their home position after you switch on the ignition.

#### Lifting the wiper blades and folding them away

- Bring the wiper arms into the service position ⇒ .
- Touch the wiper arms only in the area of the wiper blade mounting. ▶

**! NOTICE**

- To avoid damage to the bonnet and the wiper arms, fold the wiper arms forward only in the service position.
- Fold the wiper arms back to windscreen before you start to drive.

**Preserving and polishing the vehicle paintwork**

First read and observe the introductory information and safety warnings on page 148.

**Preserving the vehicle paintwork**

A good preservative protects the vehicle paintwork. At the latest when water on the *clean* paintwork no longer **pearls off**, you should protect your vehicle again with a good **hard wax preservative**.

Even though an automatic car wash plant may regularly use a **wax preservative**, Škoda recommends protecting the vehicle paintwork at least twice a year with hard wax.

**Polishing**

Polishing is only necessary if the paintwork of your vehicle has become unattractive and if it is no longer possible to achieve a gloss with wax preservatives.

If the polish does not contain any preserving elements, the paint must be treated with a preservative afterwards.

**! NOTICE**

- To prevent damage, matt-painted parts, plastic parts, headlight lenses and rear lights must not be treated with polish or hard wax.
- Do not polish the vehicle's paintwork in sandy or dusty environments or if the paint is dirty.

**Maintaining and cleaning gloss parts**

First read and observe the introductory information and safety warnings on page 148.

- Clean the surfaces with a clean, lint-free cloth dampened with water.
- For heavy dirt, use a special **solvent-free** cleaning product.
- Then polish gloss parts with a soft, dry cloth.

**! NOTICE**

To avoid damages to gloss parts:

- Do not clean nor polish gloss parts in the blazing sun.
- Do not clean or polish gloss parts in sandy or dusty environments.
- Do not use cleaning products with intense grinding action (e.g., scouring cream).
- Do not use any insect sponges, rough kitchen sponges or similar products.
- Do not polish dirty surfaces.
- Do not use any solvent-based cleaning agents.
- Do not use hard wax.

**Cleaning the rims**

First read and observe the introductory information and safety warnings on page 148.

**Cleaning steel rims**

Adhering brake dust can be removed with an industrial cleaner. Therefore, clean steel rims regularly with a separate sponge.

Remove damages to the paint of steel rims before rust can form.

**Maintaining and cleaning light alloy wheels**

Wash off road salt and brake dust approximately **every two weeks** from the light alloy wheels. Then treat the wheels with an acid-free cleaning agent. Škoda recommends thoroughly rubbing the wheels approximately **every three months** with hard wax.

The light metal will suffer if the road salt and brake dust are not be washed off regularly.

Use an acid-free cleaning agent for the light alloy wheels. Do not use paint polish or other abrasive agents to maintain the wheels.

If the protective coating layer is damaged, e.g. chip damage, the damage must be eliminated immediately.

### Maintaining rubber seals

 First read and observe the introductory information and safety warnings  on page 148.

The rubber seals on doors, windows, etc., remain smooth, seal better and last longer if the seals are treated regularly with a suitable rubber care product.

Before the treatment, remove dust and dirt from the rubber seals with a soft cloth.

### De-icing the door lock cylinders

 First read and observe the introductory information and safety warnings  on page 148.

Škoda recommends de-icing the door lock cylinders with Škoda genuine spray with regreasing and anticorrosive effect.

#### NOTICE

The use of door lock de-icing products with degreasing substances may cause rust formation in the door lock cylinders.

### Underbody protection

 First read and observe the introductory information and safety warnings  on page 148.

The underside of your vehicle is protected against chemical and mechanical influences. However, damages to the protective layer on the underside of the vehicle are possible during driving. Therefore, Škoda recommends having the protective layer on the underside of the vehicle and the chassis checked regularly and repaired if necessary.

#### CAUTION


Underbody protection and anti-corrosion agents can be ignited by the hot exhaust system or other hot engine parts.

- Do not apply underbody protection or anti-corrosion agents to exhaust pipes, catalytic converters, heat shields and other vehicle parts that become hot.

### Cleaning the engine compartment

 First read and observe the introductory information and safety warnings  on page 148.

The engine compartment of the vehicle is a hazardous area  ⇒ page 131.

Cleaning of the engine compartment should be carried out by a specialist garage. Improper cleaning may remove, among others, the corrosion protection and damage electrical components. In addition, water from the plenum chamber may enter directly into the passenger compartment ⇒ .

If the engine compartment is heavily contaminated, you should always visit a specialist garage to carry out a professional cleaning of the engine compartment. Škoda recommends a Škoda partner for this purpose.

#### Plenum chamber

The plenum chamber is located in the engine compartment between the windscreen and the engine under a perforated cover. The air conditioning system sucks outside air from the plenum chamber into the passenger compartment.

Leaves and other loose items must be regularly removed from the cover of the plenum chamber with a vacuum cleaner or by hand.

#### WARNING

Working on the engine or in the engine compartment can cause injuries, scalding, accidents and fire hazards!

- Familiarise yourself with the necessary actions and general safety precautions before commencing any work ⇒ page 131.
- Škoda recommends having the work performed by a specialist garage.

 **NOTICE**

Water introduced in the plenum chamber, e.g., with a high-pressure cleaner, can cause considerable damage to the vehicle.

**For the sake of the environment**

Wash the engine compartment only at specially designated wash areas to prevent the dirty water contaminated with oil, grease and fuel from entering the sewage system. In some regions, It is not permitted to wash engine compartment except at such specific washing bays. ■

## Maintaining and cleaning the interior

### Introduction

This chapter contains information on the following subjects:

Treating seat covers .....	157
Upholstery cloths, cloth trims and Alcantara® Cleaning .....	157
Cleaning storage compartments, cup holders and ashtrays .....	158
Maintaining and cleaning the plastic parts and instrument panel .....	159
Cleaning the seat belts .....	159

Modern clothing materials, such as dark denim, partially have no sufficient colour fastness. Especially in light seat covers (fabric or leather), staining by these clothing materials may produce clearly visible discolouration, even when used correctly. This is not a defect in the seat cover, but poor colour fastness of the clothing textiles.

#### Additional information and warnings:

- Maintaining and cleaning the vehicle exterior ⇒ page 148
- Accessories, spare parts, repairs and modifications ⇒ page 172

#### WARNING

Care products can be toxic and dangerous. Improper care products and improper application of care products can cause accidents, serious injuries, burns and poisoning.

- Store care products only in their closed original containers.

#### WARNING (Continued)

- Observe the package inserts.
- Never use empty food cans, bottles or other containers for storage of care products, as people may not always recognise the contained care products.
- Keep children away from all care products.
- Harmful vapours may form during the application. Therefore, use care products only outdoors or in well-ventilated areas.
- Never use fuel, turpentine, engine oil, nail polish remover or other volatile liquids for washing, grooming or cleaning. They are toxic and highly flammable.

#### WARNING

Improper care and cleaning of vehicle parts may affect the safety equipment of the vehicle and cause serious injuries.

- Clean and treat vehicle parts only according to the manufacturer's instructions.
- Use approved or recommended cleaning agents.

#### NOTICE

- Solvent-based cleaners attack the material and can damage it.
- Have stubborn stains removed by a specialist garage to avoid damage.

#### Note

Suitable care products are available from your Škoda partner. ■

## Treating seat covers



First read and observe the introductory information and safety warnings on page 156.

### Checklist

For treating and maintaining the seat covers, observe the following ⇒ :

- ✓ Before getting into the vehicle, close all Velcro fasteners that may get in contact with upholstery cloths or cloth trims. Open Velcro fasteners can cause damage to upholstery cloths and cloth trims.
- ✓ Avoid direct contact of sharp objects and applications to the upholstery cloths and cloth trims to prevent damage. Applications are, for example, zippers, studs and rhinestones on clothing and belts.
- ✓ Regularly remove dust and dirt particles in pores, creases and seams so that the surface of the seats will not be permanently damaged by abrasion.
- ✓ Be sure to check clothing for colourfastness to avoid stains on the seat covers. This applies especially to light seat covers.

### NOTICE

Failure to observe the checklist that is essential for the preservation of the seat covers can cause damage to or discolouration of upholstery cloths and cloth trims.

- Follow the checklist and carry out the actions.

### Note

Škoda recommends having discolourations on the seat cover removed by a specialist garage.

## Upholstery cloths, cloth trims and Alcantara® Cleaning



First read and observe the introductory information and safety warnings on page 156.

### Normal cleaning

- Read and follow the handling instructions, notes and warnings on the packaging before using the cleaning agents.
- Vacuum upholstery cloths, cloth trims, Alcantara® seat covers and the carpet with a vacuum cleaner (brush attachment).

- For general cleaning, use a soft sponge or a commercially available, lint-free microfibre cloth ⇒ .
- Clean Alcantara® surfaces with a damp cotton or wool cloth or a commercially available, lint-free microfibre cloth ⇒ .

General surface contamination of the upholstery cloths and cloth trims can be cleaned with a commercially available foam cleaner.

For cleaning of heavy general soiling of the upholstery cloths and cloth trims, it is recommended to assign a special cleaning company.

### ■ Cleaning of stains

When cleaning stains, it may be necessary to clean the stain not only selectively, but the entire area – especially if it is contaminated by general wear. Otherwise, the treated area may be lighter than the untreated surface. ▶

Type of stain	Cleaning
<i>Water-based stains</i> , such as coffee or fruit juice.	<ul style="list-style-type: none"> <li>- Apply a mild detergent solution with a sponge.</li> <li>- Dab with an absorbent dry cloth.</li> </ul>
<i>Stubborn stains</i> , such as chocolate, make-up.	<ul style="list-style-type: none"> <li>- Apply a cleaning paste<sup>a)</sup> directly on the stain and work it in.</li> <li>- Apply clear water with a damp cloth or sponge, to remove detergent residue.</li> <li>- Dab with an absorbent dry cloth.</li> </ul>
<i>Fat-based stains</i> , such as oil, lipstick.	<ul style="list-style-type: none"> <li>- Apply neutral soap or washing paste<sup>a)</sup> and work it in.</li> <li>- Dab dissolved fat or dye components with an absorbent material.</li> <li>- Rinse with clear water. Do not soak the covers.</li> </ul>

<sup>a)</sup> For example, gall soap can be used as the cleaning paste.

### ! NOTICE

Use brushes only to clean the carpet and the floor mats! Other textile surfaces may be damaged by brushing.

### ! NOTICE

Do not use steam cleaners, since the steam inserts the dirt deeper into the fabric and fixes it there.

### ! NOTICE

- Alcantara® should never be soaked.
- Alcantara® must not be treated with leather care products, solvents, floor wax, shoe polish, stain removers and similar products.
- Do not use brushes for wet cleaning since the surface of the material could be damaged.

## Cleaning storage compartments, cup holders and ashtrays



Fig. 90 In the centre console: Storage compartment and cup holders in front.



Fig. 91 Removed and opened ashtray with cigarette extinguisher.



First read and observe the introductory information and safety warnings ⚠ on page 156.

### Cleaning storage compartments and cup holders

- Clean the parts with a clean, lint-free cloth dampened with water.
- If this is not sufficient, use a special **solvent-free** plastic cleaning and care product.

### Cleaning the ashtrays


- Remove and empty the ashtrays.
- Wipe them clean with a paper towel.


To clean the cigarette extinguisher ⇒ [fig. 91](#) (arrow), for example, use a toothpick or similar item to remove the ash residues.



## Maintaining and cleaning the plastic parts and instrument panel



First read and observe the introductory information and safety warnings  on page 156.

- Clean the parts with a clean, lint-free cloth dampened with water.
- *Treat the plastic parts (inside and outside the vehicle) and the instrument panel with a special solvent-free plastic cleaning and care product which is approved by Škoda* .




### WARNING

Solvent-based cleaning agents cause the surface of the airbag modules to become porous. In an accident with airbag deployment, plastic parts coming loose may cause serious injuries.

- Never use solvent-based cleaning agents to clean the instrument panel and the surface of the airbag modules.


## Cleaning the seat belts



First read and observe the introductory information and safety warnings  on page 156.

Rough dirt on the belt webbing affects the rolling-up action of the automatic belt and thus the functioning of the seat belt.

The seat belts must never be removed for cleaning.

- Remove coarse dirt with a soft brush .
- Pull out the dirty seat belt completely and leave the webbing rolled out.
- Clean the seat belt with *mild* soapy water.
- Let the treated webbing dry completely.
- Roll up the seat belt only after it has completely dried.



### WARNING

Regularly check the condition of all seat belts. If the webbing or other parts of the seat belt are damaged, immediately have the seat belt removed and replaced by a specialist garage. Damaged seat belts pose a great danger and can cause serious or fatal injuries.

- Seat belts and their components must never be cleaned chemically or come in contact with corrosive liquids, solvents or sharp objects. This would considerably impair the strength of the webbing.
- A seat belt must be dried completely before it is rolled up, because moisture may damage the inertia reel and impair its function.
- Never let objects and liquids enter into the slots of the belt buckles. This may impair the functions of the belt buckles and seat belts.
- Never try to repair, modify or remove the seat belts yourself.
- Have damaged seat belts immediately replaced by seat belts that are approved by Škoda for the vehicle. Seat belts which have been subjected to stress in an accident and were therefore stretched must be replaced by a specialist garage. The renewal may be necessary even if no damage is obvious. The anchorage points for the belts should also be checked.

## Wheels and tyres

### Introduction

This chapter contains information on the following subjects:

Handling wheels and tyres .....	161
Rims .....	162
New tyres and replacing tyres .....	162
Tyre inflation pressure .....	163
Tread depth and wear indicator .....	164
Tyre damage .....	165
Spare wheel or emergency spare wheel .....	166
Tyre inscription .....	168
Winter tyres .....	170
Snow chains .....	171

Škoda recommends that you have any work relating to tyres or wheels carried out by a specialist garage. Your dealer has all of the necessary special tools and replacement parts available plus the required specialist knowledge and is also in a position to properly dispose of the old tyres. Škoda recommends a Škoda partner for this purpose.

#### Additional information and warnings:

- Transporting ⇒ page 81
- Braking, stopping and parking ⇒ page 104
- Maintaining and cleaning the vehicle exterior ⇒ page 148
- Consumer information ⇒ page 179
- Wheel trims ⇒ page 192
- Changing a wheel ⇒ page 194

### WARNING

**New wheels or wheels that are old, worn or damaged cannot provide the full vehicle control and braking efficiency.**

- Mishandling of wheels and tyres can reduce the driving safety and cause accidents and serious injuries.

### WARNING (Continued)

- On all four wheels, use only radial tyres of the same type, size (rolling circumference) and the same tread pattern.
- New tyres should be run in, as new wheels initially have reduced grip and braking efficiency. To avoid accidents and serious injuries, drive with appropriate caution during the first 370 miles (600 km).
- Regularly check the tyre inflation pressure and always maintain the specified tyre inflation pressure level. A tyre inflation pressure that is too low can heat up the tyre so much that it may lead to tread separation and bursting of the tyre.
- Never drive with damaged (pierces, cuts, cracks and dents) and worn tyres. Driving with such tyres can cause blowouts, accidents and serious injuries. Replace worn or damaged tyres immediately.
- Never exceed the maximum permitted speed and load for the tyres.
- The effectiveness of the driver assist systems and the brake assist systems is also dependent on the grip of the tyres.
- If you notice unusual vibrations or drawing of the vehicle towards one side while driving, stop immediately and check the wheels and tyres for damage.
- To reduce the risk of loss of vehicle control, accidents and severe injuries, never loosen the screws on rims with a screw rim.
- Do not use wheels or tyres whose history is not known. Used wheels and tyres may be damaged, even if these damages are not visible.
- Old tyres - even if they were never used - may suddenly lose air or burst and cause accidents and serious injuries, especially at high speeds. Use tyres that are older than six years only in an emergency and with extreme caution and using a careful driving style.



### Note

For technical reasons, the rims of other vehicles usually can not be used. This may also apply in certain circumstances to the rims of the same type of vehicle. Check the official registration papers and ask a Škoda partner if necessary. ■

## Handling wheels and tyres



Fig. 92 Pattern for the exchange of the wheels.


 First read and observe the introductory information and safety warnings  on page 160.

Tyres are the most stressed and under-appreciated parts of a vehicle. Tyres are very important because the narrow contact surfaces of the tyres are the only contact of the vehicle to the road.

The tyre life is dependent on tyre inflation pressure, driving style, handling and proper fitting.

Tyres and rims are important design elements. The tyres and rims approved by Škoda have been precisely matched to your particular vehicle model and thus contribute significantly to the good handling and safe driving characteristics.

### Avoiding damage to the tyres

- Drive over curbs and the like only slowly and at right angles if possible.
- Check tyres regularly for damage, such as pierces, cuts, cracks and dents.
- Remove foreign objects that are located externally in the tread of the tyre and have **not penetrated into the inside of the tyre** ⇒ page 165.
- Have damaged or worn tyres replaced immediately ⇒ page 165.
- Check tyres regularly for hidden damage ⇒ page 165.
- Never exceed the load capacity and speed of the fitted tyres ⇒ page 168.
- Protect tyres, also the spare wheel, against contact with aggressive substances including grease, oil, petrol and brake fluid ⇒ .
- Replace missing dust caps of the valves immediately.

### Unidirectional tyres

Unidirectional tyres are designed to roll in one direction only. Unidirectional tyres have arrow markings on the wall of the tyre ⇒ page 168. The so specified running direction must absolutely be complied with. Only this ensures optimal tyre performance in respect of aquaplaning, grip, noise and wear.

If a tyre is nevertheless fitted opposite to the designed running direction, be sure to drive more carefully because the tyre is no longer used as intended. This is especially important on wet roads. The tyre must be replaced or fitted in the correct running direction as soon as possible.


### Exchanging tyres

To ensure even wear of all tyres, it is recommended to exchange the wheels regularly according to the pattern ⇒ fig. 92. You will then obtain approximately the same life for all the tyres.

Škoda recommends having the wheels exchanged by a specialist garage.

### Tyres that are older than six years


Tyres age due to physical and chemical processes, so their function may be impaired. Tyres that are stored unused for long periods of time harden and become brittle sooner than tyres that are constantly in used on the vehicle.

Škoda recommended to have tyres, six years and older, replaced with new tyres. This also applies to tyres, including the spare wheel, which outwardly appear of good quality and whose tread depth has not yet reached the statutory minimum ⇒ .

The age of each tyre can be determined by the date of manufacture, which is part of the tyre identification number (TIN) ⇒ page 168.

### Storing tyres

Mark the wheels before they are removed so they can retain their current running direction when they are fitted again (left, right, front, rear). Always store wheels or tyres which have been removed in a cool, dry and, where possible, dark place. Do **not** store tyres fitted to a rim vertically.

Protect tyres without rims in appropriate bags against contamination and store them upright on their tread. 

**WARNING**

Aggressive fluids and substances can cause visible and invisible damage to the tyres, which can lead to bursting of the tyres.

- Always keep chemicals, oils, greases, fuels, brake fluids and other aggressive materials away from the tyres.

**WARNING**

Old tyres - even if they were never used - may suddenly lose air or burst and cause accidents and serious injuries, especially at high speeds.

- Use tyres that are older than six years only in an emergency and with extreme caution and using a careful driving style.

**For the sake of the environment**

Always dispose of old tyres properly and according to regulations.

**Rims**

First read and observe the introductory information and safety warnings  on page 160.

Rims and wheel bolts are matched to each other in terms of design. If you retrofit other rims, you must use matching wheel bolts of the right length and dome shape. This is essential to ensure that the wheels are tightly fitted and that the brake system operates properly ⇒ page 194.

For technical reasons, the rims of other vehicles usually can not be used. This may also apply in certain circumstances to the rims of the same type of vehicle.

The tyres and rims approved by Škoda have been precisely matched to your particular vehicle model and thus contribute significantly to the good handling and safe driving characteristics.

**Wheel bolts**


Wheel bolts must always be tightened to the correct torque ⇒ page 194.

**WARNING**



Using improper or damaged rims can impair safe driving and cause accidents and serious injuries.

- Use only rims that are approved for the vehicle.
- Regularly check rims for damage and replace if necessary.


**New tyres and replacing tyres**

First read and observe the introductory information and safety warnings  on page 160.

**New tyres**

- Drive especially carefully during the first 370 miles (600 km) with new tyres, as the tyres first need to be *run in*. Tyres that have not been run in have reduced grip ⇒  and braking efficiency ⇒ .
- On all four wheels, use only radial tyres of the same type, size (rolling circumference) and the same tread pattern.
- The tread depth of new tyres may differ because of design features and the configuration of the tread (depending on the type of tyre and the manufacturer).

**Replacing tyres**

- Do not replace tyres individually, if possible, but at least by axle (both tyres of the front axle or both tyres of the rear axle) ⇒ .
- Replace old tyres only with tyres approved by Škoda for the associated vehicle type, paying attention to size, diameter, capacity and maximum speed.
- Never use tyres whose effective size exceeds the dimensions of the tyre types approved by Škoda. Larger tyres could grind and rub on the body or other parts.

**WARNING**

New tyres should be run in, as new wheels initially have reduced grip and braking efficiency.

- To avoid accidents and serious injuries, drive with appropriate caution during the first 370 miles (600 km).

**WARNING**

Wheels must have the necessary design-related clearance. Absence of clearance may lead to frictional contact of tyres with parts of the chassis, the body and brake lines, which may result in failure of the braking system and tread separation, causing bursting of the tyres.

- The actual dimensions of the tyres may not be larger than the dimensions of the tyre types approved by Škoda and may not rub on parts of the vehicle.

**Note**

Despite the same size indicated on tyres, the actual dimensions of the various types of tyres may deviate from these nominal values or the tyre contours may differ considerably.

**Note**

For tyres that are approved by Škoda, it is ensured that the actual dimensions match the vehicle. For other types of tyres, the vendor of the tyres has to provide a certificate of the tyre manufacturer, stating that the tyre type is also suitable for the vehicle. Keep the certificate ready in the vehicle.

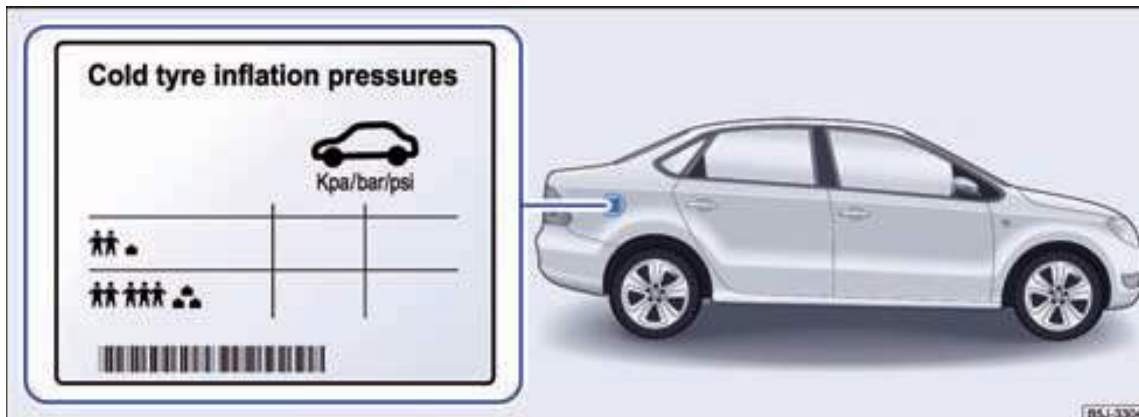


**Tyre inflation pressure**

Fig. 93 Location of the tyre inflation pressure label.

 First read and observe the introductory information and safety warnings  on page 160.

The correct tyre inflation pressure for the factory-fitted tyres is specified on a sticker - applies to summer and winter tyres. The sticker  $\Rightarrow$  fig. 93 is located on the inside of the fuel filler flap.

The working life of tyres will be shortened considerably if the tyres are insufficiently or over-inflated and this will have an adverse effect on the handling of your vehicle  $\Rightarrow$  . Particularly at **high speeds**, the correct tyre inflation pressure is especially important. A wrong tyre inflation pressure results in increased wear or even to bursting of the tyres.

The pressure should therefore be checked at least once a month and also before every long journey. 

The specified tyre inflation pressure is for **cold tyres**. The tyre inflation pressure of warm tyres is higher than of cold tyres.

Therefore, never let the air escape a warm tyre to adjust the tyre inflation pressure. In this case, the tyre inflation pressure would be too low so that it could lead to sudden bursting of the tyre.

#### Checking the tyre inflation pressure

Only check the tyre inflation pressure when the tyres were not driven more than a few miles (kilometres) at low speed in the last three hours.

- Check the tyre inflation pressure regularly and always on cold tyres. Always check all the tyres, including on the spare wheel, if available. In colder regions, the tyre inflation pressure should be checked more often, but only if the vehicle has not been previously moved. Always use an operational tyre inflation pressure gauge.
- With greater payload, adjust the tyre inflation pressure accordingly.

The **spare wheel** or **emergency spare wheel** gets the highest tyre inflation pressure that is specified for the vehicle.

#### WARNING

A tyre inflation pressure that is too high or too low can lead to the tyre suddenly losing air or bursting during driving. This can cause serious accidents and fatal injuries.

- A tyre inflation pressure that is too low can heat up the tyre so much that it may lead to tread separation and bursting of the tyre.
- Excessive speeds or overloading of the vehicle may cause overheating and sudden tyre damage including punctures and detachment of the tread and thus loss of vehicle control.
- A tyre inflation pressure that is too low or too high reduces the life of the tyres and degrades the performance of the vehicle.
- Regularly check the tyre inflation pressure, at least once a month and additionally before every long journey.
- All tyres must have the correct tyre inflation pressure in accordance with the payload.
- Never reduce the increased air pressure in warm tyres.

#### NOTICE

- When attaching the tyre inflation pressure gauge, make sure that it is not jammed with the valve stem.
- Missing, unsuitable or not properly screwed-on valve caps can cause damage to the tyre valve. Therefore, always drive with fully screwed-on valve caps that match the factory-fitted valve caps.

#### For the sake of the environment

A tyre inflation pressure that is too low increases fuel consumption. ■

#### Tread depth and wear indicator



Fig. 94 Tread: Wear indicator.

First read and observe the introductory information and safety warnings ⚠ on page 160.

#### Tread depth

Special driving situations require a tread depth as large as possible and an approximately equal tread depth of the tyres on the front and rear axle. This is especially true for driving in wintry weather and cold temperatures and in wet conditions ⇒ ⚠.

In most countries, the legally permissible minimum remaining tread depth is 1/16" (1.6 mm), measured in the tread grooves next to the wear indicators. Observe the country-specific legal regulations.

**Winter tyres** lose much of their winter performance when the tread is worn down to a depth of 5/32" (4 mm). ▶

The tread depth of new tyres may differ due to design features and profile designs, depending on model and manufacturer.

### Wear indicators on tyres

In the base of the tread of the original tyres there are wear indicators 1/16" (1.6 mm) high, installed at right angles to the running direction ⇒ [fig. 94](#). These wear indicators are evenly positioned around the surface of the tyre. Markings on the tyre walls mark the location of the wear indicators, e.g., the letters "TWI" or symbols.

The wear indicators show if a tyre is worn. At the latest when the tread is worn down to the wear indicators, the tyre must be replaced.

### WARNING


**Worn tyres are a safety risk and can lead to loss of vehicle control and serious injuries.**

- At the latest when the tyres are worn down to the wear indicators, the tyres must be replaced with new tyres.
- Worn tyres have greatly reduced grip, especially on wet roads, and the vehicle will tend to "float" (aquaplaning).
- Worn tyres reduce the possibility to control the vehicle in normal and difficult driving situations and increase the braking distance and the risk to skid.

### Tyre damage



First read and observe the introductory information and safety warnings  on page 160.

Damage to tyres and rims is frequently not visible. Unusual **vibrations** or the vehicle **pulling to one side** may be an indication of tyre damage ⇒ .

- If it is suspected that a wheel is damaged, immediately reduce speed!
- Check the tyres and rims for damage.
- If tyres are damaged, do not continue to drive and get professional assistance.
- If no external damage is evident, drive slowly and carefully to the nearest specialist garage to have the vehicle checked.

### Foreign bodies penetrated into tyres

- Leave penetrated foreign bodies in the tyres if they have reached the inside!
- Immediately get technical assistance.

### Tyre wear

Tyre wear depends on several factors (examples):

- Driving style.
- Imbalance of the wheels.
- Setup of the suspension.

*Driving style* - Fast cornering, rapid acceleration and hard braking increase the wear of the tyres. If tyre wear is heavy in spite of normal driving, have the adjustment of the suspension checked by a specialist garage.

*Imbalance of the wheels* - The wheels of a new vehicle are balanced. When driving, there are a wide range of influences which may result in an imbalance, which makes itself felt by a vibration in the steering. An imbalance also has an effect on the wear of the steering and suspension. Therefore, have the wheels rebalanced in such a case. A new tyre must be rebalanced after fitting.

*Suspension setup* - An incorrect setup of the suspension affects the driving safety and results in increased tyre wear. In case of heavy tyre wear, have the wheel alignment checked by a specialist garage.

### WARNING

**Unusual vibration or pulling to one side of the vehicle while driving may be an indication of tyre damage.**

- Immediately reduce speed and stop when traffic allows.
- Check the tyres and rims for damage.
- Never continue to drive with damaged tyres or rims. Instead get professional assistance.
- If no external damage is evident, drive slowly and carefully to the nearest specialist garage to have the vehicle checked.

## Spare wheel or emergency spare wheel



Fig. 95 In the boot: Handwheel to secure the spare wheel.



First read and observe the introductory information and safety warnings ⚠ on page 160.

### Taking out the spare wheel

- Open the boot lid and lift the floor covering.
- Remove the toolbox ⇒ page 190.
- Completely unscrew the handwheel in the centre of the spare wheel ⇒ fig. 95 counter-clockwise and take out the spare wheel.

### Stowing the replaced wheel

- Lift the floor covering.
- Put the replaced wheel with the rim facing down into the spare wheel well such that the centre hole of the wheel is aligned with the screw.
- Set the handwheel on the screw and turn clockwise until the replaced wheel is securely fixed.
- Put the tool kit back into the container in the boot.
- Fold the floor covering back to the boot floor.
- Close the boot lid.

### If the spare wheel differs from the tyres fitted to the vehicle

If the spare wheel differs in its design from the tyres fitted to the vehicle, such as winter tyres or an emergency spare wheel, the spare wheel should only be used for a short time in the event of a puncture and when adopting an appropriately cautious style of driving ⇒ ⚠.

It should be replaced as soon as possible with a normal wheel.

### Driving tips:

- Do not drive faster than 50 mph (80 km/h)!
- Avoid accelerating at full throttle, sharp braking and fast cornering!
- Do not use snow chains on the emergency spare wheel ⇒ page 171.
- After fitting the spare wheel or emergency spare wheel, check the tyre inflation pressure as soon as possible ⇒ page 164.

The tyre inflation pressure of the spare tire or emergency spare wheel should be checked together with the tyres fitted to the vehicle, at least once a month. The spare wheel gets the highest inflation pressure that is specified for the vehicle ⇒ page 163. The tyre inflation pressure for the emergency spare wheel is indicated on the sticker on the emergency spare wheel.



### WARNING

Improper handling of the spare wheel or emergency spare wheel can lead to loss of vehicle control, collisions or other accidents and injuries.

- On no account use the spare wheel or emergency spare wheel if it is damaged or worn down to the wear indicators.
- In some vehicles, the spare wheel may be smaller than the original tyres. The smaller spare wheel is identified by a sticker that says "50 mph" or "80 km/h". This marking indicates the maximum speed at which the tyre can be used.
- Never drive faster than 50 mph (80 km/h). Avoid rapid acceleration, hard braking and fast cornering.
- Never drive more than 124 miles (200 km) with a 16" emergency spare wheel if it is fitted on the drive axle.
- Replace the emergency spare wheel as quickly as possible with a normal wheel. The emergency spare wheel is intended only for short-term use.
- The emergency spare wheel must always be secured with the factory supplied wheel bolts.



**⚠ WARNING (Continued)**

- **Never drive with more than one emergency spare wheel.**
- **After fitting the emergency spare wheel, the tyre inflation pressure should be checked as soon as possible ⇒ page 163.**
- **Snow chains cannot be used on the emergency spare wheel.**

**i Note**

Where possible, securely fasten the spare wheel, emergency spare wheel or the replaced wheel in the boot. ■

### Tyre inscription

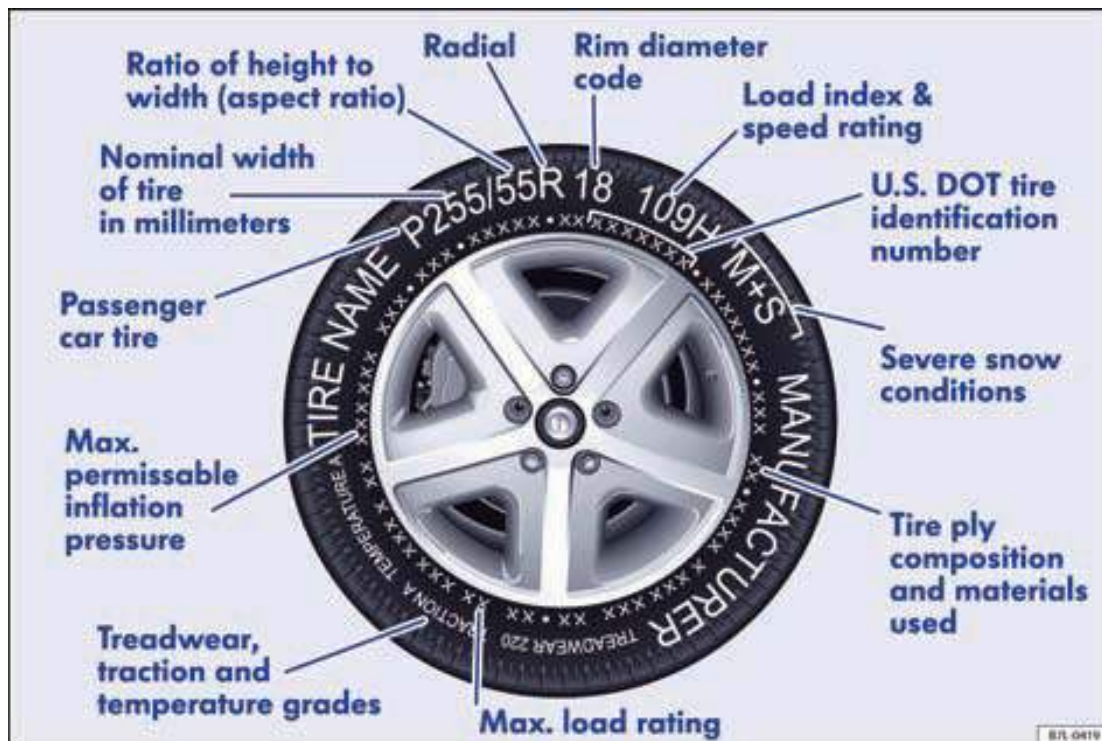



Fig. 96 International tyre inscription.

 First read and observe the introductory information and safety warnings  on page 160.

Tyre inscription (example)	Meaning
Brand name, logo	Manufacturer
Product name	Individual tyre name of the manufacturer.

Tyre inscription (example)	Meaning										
P 255 / 55 R 18	Tyre size designation: <table border="1"> <tr> <td>P</td> <td>Marking for passenger cars.</td> </tr> <tr> <td>255</td> <td>Tyre width from side wall to side wall in mm.</td> </tr> <tr> <td>55</td> <td>Height/width ratio in %.</td> </tr> <tr> <td>R</td> <td>Belt-type code letter for radial.</td> </tr> <tr> <td>18</td> <td>Rim diameter in inches.</td> </tr> </table>	P	Marking for passenger cars.	255	Tyre width from side wall to side wall in mm.	55	Height/width ratio in %.	R	Belt-type code letter for radial.	18	Rim diameter in inches.
P	Marking for passenger cars.										
255	Tyre width from side wall to side wall in mm.										
55	Height/width ratio in %.										
R	Belt-type code letter for radial.										
18	Rim diameter in inches.										
109 H	Load index ⇒ page 170 and speed code letter ⇒ page 170.										
XL	High-duty type tyre ("Reinforced").										
M + S or M/S	Marking for winter-use tyres (mud and snow tires) ⇒ page 170.										
RADIAL TUBELESS	Tubeless radial tyre.										
E4 ...	Marking according to international regulations (E) with number of the country of approval. Followed by the multi-digit approval number.										
DOT BT RA TY5 1709	Tyre identification number ( <b>TIN</b> <sup>a)</sup> – potentially only on the inside of the wheel) and date of manufacture: <table border="1"> <tr> <td>DOT</td> <td>The tyre meets the legal requirements of the U.S. Department of Transportation, responsible for tyre safety standards.</td> </tr> <tr> <td>BT</td> <td>Symbol of the manufacturing plant.</td> </tr> <tr> <td>RA</td> <td>Information of the tyre manufacturer on tyre size.</td> </tr> <tr> <td>TY5</td> <td>Tyre characteristics of the manufacturer.</td> </tr> <tr> <td>1709</td> <td>Date of manufacture: Week 17 in 2009.</td> </tr> </table>	DOT	The tyre meets the legal requirements of the U.S. Department of Transportation, responsible for tyre safety standards.	BT	Symbol of the manufacturing plant.	RA	Information of the tyre manufacturer on tyre size.	TY5	Tyre characteristics of the manufacturer.	1709	Date of manufacture: Week 17 in 2009.
DOT	The tyre meets the legal requirements of the U.S. Department of Transportation, responsible for tyre safety standards.										
BT	Symbol of the manufacturing plant.										
RA	Information of the tyre manufacturer on tyre size.										
TY5	Tyre characteristics of the manufacturer.										
1709	Date of manufacture: Week 17 in 2009.										
TWI	Marks the position of the Tread Wear Indicator ⇒ page 164.										
Made in Germany	Country of manufacture.										
MAX LOAD 615 KG (1356 LBS)	US load specification for the maximum load per wheel.										
MAX INFLATION 350 KPA (51 PSI)	U.S. limit for the maximum air pressure.										
SIDEWALL 1 PLY RAYON	Information on the components of the tyre casing: 1 ply rayon (artificial silk)										
TREAD 4 PLIES 1 RAYON + 2 STEEL + 1 NYLON	Information on the components of the tread: In the example, there are 4 plies under the tread: 1 rayon ply (artificial silk), 2 plies of steel belts, and 1 nylon ply.										
<b>Information for consumers about benchmark results on specified base tyres (standard test method):</b>											
TREADWEAR 220	Relative life expectancy of the tyre, relative to a U.S.-specific standard test.										
TRACTION A	Wet braking ability of the tyre (AA, A, B or C).										
TEMPERATURE A	Temperature strength of the tyre at higher test bench speeds (A, B or C).										
<b>Any other existing numbers are internal markings of the tyre manufacturer or country-specific labels, such as for Brazil or China.</b>											

<sup>a)</sup> TIN is the serial number of the tyre.

### Unidirectional tyres

Unidirectional tyres are designed to rotate in one direction only. Unidirectional tyres have arrow markings on the wall of the tyre. Be sure to observe the indicated running direction. This ensures optimal tyre performance in respect of aquaplaning, grip, noise and wear.

### Load capacity of tyres

The load index indicates the maximum load capacity of a single tyre in kilograms.

78	425 kg (937 lbs)
81	462 kg (1019 lbs)
83	487 kg (1074 lbs)
85	515 kg (1135 lbs)
87	545 kg (1202 lbs)

### Speed code letters

The speed code letter specifies the maximum speed at which the tyres may be driven.

P	max. 150 km/h (93 mph)
Q	max. 160 km/h (99 mph)
R	max. 170 km/h (106 mph)
S	max. 180 km/h (112 mph)
T	max. 190 km/h (118 mph)
U	max. 200 km/h (124 mph)
H	max. 210 km/h (130 mph)
V	max. 240 km/h (149 mph)
Z	more than 240 km/h (149 mph)
W	max. 270 km/h (168 mph)
Y	max. 300 km/h (186 mph)

Some tyre manufacturers use for tyres with a max. permissible speed of more than 240 km/h (149 mph) the letters "ZR".

## Winter tyres




First read and observe the introductory information and safety warnings  on page 160.

In winter road conditions, winter tyres improve the handling characteristics of the vehicle considerably. Summer tyres do not offer the same grip on ice and snow because of their construction (width, rubber blend, tread pattern). Škoda recommends winter tyres or all-season tyres on all four wheels of the vehicle, especially when winter road conditions are expected. Winter tyres also improve the braking of the vehicle and help reduce stopping distances in winter weather. At temperatures below +45 °F (7 °C), Škoda recommends fitting the vehicle with winter tyres.

Winter tyres no longer offer the same winter performance once the **tyre tread** has worn down to a depth of about 1/16 in (4 mm). Similarly, winter tyres lose much of their characteristics through **ageing** – independent of the remaining tread depth.

### The following applies to the use of winter tyres:

- Observe the country-specific legal requirements.
- Use winter tyres on all four wheels at the same time.
- Use only with winter road conditions.
- Only use the maximum winter tyre sizes permitted for the vehicle.
- Use only winter tyres of the same belt type, size (rolling circumference) and tread pattern.
- Observe the speed limit depending on the speed code letter ⇒ .

### Speed limit

Winter tyres have a speed limit depending on the speed code letter ⇒ page 170.

For some vehicle models, a speed warning can be set in the **MFD (multi-function display)** menu of the instrument cluster ⇒ page 23.



### WARNING

The improved handling characteristics under winter road conditions through winter tyres should not encourage you to take a security risk.

- Adjust your speed and driving style to the visibility, weather, road and traffic conditions.
- Never exceed the maximum permitted speed and load for the fitted winter tyres.




### For the sake of the environment

After winter, fit again the summer tyres in due time. At temperatures above +45 °F (7 °C), the handling characteristics of summer tyres are better. The tyre noise is quieter and the tyre wear and fuel consumption are lower. ▶

**Note**

Ask your Škoda partner for the permissible size of winter tyres.

**Snow chains**

First read and observe the introductory information and safety warnings  on page 160.

Observe the legal and local requirements and the permissible maximum speed when driving with snow chains.


When driving on wintry roads, snow chains improve not only traction, but also the braking performance.

Snow chains may be mounted only **on the front wheels** and **only on the following tyre and rim combinations**:

Tyre size	Rim
175/70 R 14	5 J x 14 ET 35
185/60 R 15	6 J x 15 ET 43

Škoda recommends that you check with a Škoda partner about appropriate wheel, tyre and snow chain sizes.

If possible use fine-link snow chains that do not project more than 37/64 in (15 mm) including the chain lock.

When using snow chains, remove the wheel centre trim and snow chains and wheel trim rings and trim rings before fitting ⇒ . However, the wheel bolts must then be provided with caps for safety. They are available from your Škoda partner.

**Emergency spare wheel**

The use of snow chains on the emergency spare wheel is not permitted for technical reasons ⇒ page 166.

If you have to drive with snow chains and a front tyre is punctured, fit the emergency spare wheel to the rear axle. Then fit the vacant rear wheel to the front axle replacing the damaged front wheel. Be sure to observe the running direction of the tyres. Škoda recommended to fit the snow chain already before fitting the wheel.

**WARNING**

The use of unsuitable or improper snow chains or fitting improper fitting of snow chains can cause accidents and serious injuries.

- Always use the correct snow chains.
- Follow the instructions of the snow chain manufacturer.
- Never drive faster than permitted with fitted snow chains.

**NOTICE**

- Remove the snow chains on snow-free roads. The snow chains otherwise affect the handling, damage the tyres and are quickly destroyed.
- Tyres that have direct contact with the rim can scratch or damage the rim. Škoda recommends using coated snow chains.

**Note**

Snow chains are available for a vehicle type in different sizes.

## Accessories, replacement of parts, repairs and Modifications

### Introduction

This chapter contains information on the following subjects:

Running in .....	172
Accessories and spare parts .....	173
Fluids and operating material .....	173
Repairs and technical modifications .....	174
Repairs and impairments of the airbag system .....	174
Retrofitting two-way radio equipment .....	175
Information stored in the control units .....	175
Using a mobile phone in the vehicle without connection to the external aerial .....	176
Jacking points for lifting the vehicle .....	177

#### Additional information and warnings:



- Seat belts ⇒ page 52
- Airbag system ⇒ page 60
- Ashtrays and cigarette lighter ⇒ page 91
- Power sockets ⇒ page 92
- Braking, stopping and parking ⇒ page 104
- Preparing to work in the engine compartment ⇒ page 131
- Engine oil ⇒ page 136
- Engine coolant ⇒ page 140
- Vehicle battery ⇒ page 144
- Maintaining and cleaning the vehicle exterior ⇒ page 148
- Maintaining and cleaning the interior ⇒ page 156
- Consumer information ⇒ page 179
- Radio ⇒ Booklet Radio

### WARNING

Unsuitable spare parts and accessories as well as improperly performed work, changes and repairs can cause vehicle damage, accidents and serious injuries.

- Škoda strongly recommends using only approved Škoda accessories and genuine Škoda parts. For these, Škoda has established their reliability, safety and suitability.
- Repairs and modifications to the vehicle may only be performed by a specialist garage. Specialist garages have the necessary tools, diagnostic equipment, repair information and qualified personnel.
- Install only parts on the car whose design and characteristics match those of the factory-installed parts.
- Never place, fasten or install objects such as cup holders or mobile phone mounts on or next to the covers of the airbag modules or within the deployment areas of the airbags.
- Use only rim-tyre combinations that are approved by Škoda for the type of vehicle.

### Running in

 First read and observe the introductory information and safety warnings  on page 172.

Observe the respective provisions for running in of new parts.

#### Running in the engine

A new engine must be run in during the first 1000 miles (1500 kilometres). During the first operating hours, the engine has higher internal friction than later when all of the moving parts have harmonised.

The driving style during the first 1000 miles (1500 kilometres) will also affect the engine quality. Also afterwards – especially when the engine is cold – you should drive at moderate engine speeds to reduce engine wear and increase possible mileage. Do not drive at too low engine speeds. Always downshift when the engine is no longer running “smoothly”. **Up to 600 miles (1000 km):**

- No full throttle.
- Do not use the engine at more than 2/3 of maximum speed.

**From 600 to 1000 miles (1000 to 1500 kilometres), gradually** increase to full vehicle speed and maximum engine speed. ►

### Run in new tyres and brake pads


- New tyres and tyre replacement ⇒ page 160.
- Information on the brakes ⇒ page 107.

### For the sake of the environment

If the new engine is run in gently, the life of the engine will increase while engine oil consumption will be lower. ■

## Accessories and spare parts



First read and observe the introductory information and safety warnings  on page 172.

Škoda recommends seeking advice from a Škoda partner before purchasing accessories, spare parts or operating material, for example, if the vehicle is to be retrofitted with accessories or if parts must be replaced. Your Škoda partner will inform you on legal provisions and factory recommendations for accessories, spare parts and operating material.

Škoda recommends using only approved **Škoda accessories** and **genuine Škoda parts**. For these, Škoda has established their reliability, safety and suitability. A Škoda partner is also qualified for the professional installation.

Products which are **not approved by Škoda** can not be judged by Škoda in terms of reliability, safety and suitability for the vehicle despite ongoing market monitoring. Therefore, Škoda cannot accept liability such products, even if in individual cases they may have been approved by an officially recognised technical testing and inspection organisation or a government authority.

**Retrofitted equipment** that directly affect the driver's control must wear an e mark (approval marking of European Union) and approved by Škoda for the vehicle. Such devices include, for example, a cruise control system or electronically controlled suspension systems.

**Additionally connected electrical devices** that do not serve the immediate control of the vehicle must wear a CE mark (declaration of conformity of the manufacturer in the European Union). Such devices include, for example coolers, computers or fans.

### WARNING

Improper repairs and modifications to the vehicle may affect the effectiveness of airbags and cause malfunctions, accidents and fatal injuries.

- Never place, fasten or install objects such as cup holders or mobile phone mounts on or next to the covers of the airbag modules or within the deployment areas of the airbags.
- Objects that are placed or fastened on or near the covers of the airbag modules or within the deployment areas of the airbags can cause serious or fatal injuries if the airbags deploy. ■

## Fluids and operating material



First read and observe the introductory information and safety warnings  on page 172.

All fluids and operating material are continuously being further developed, such as toothed belts, tyres, engine coolant, engine oils, spark plugs and vehicle batteries. Therefore, have all fluids and operating material changed by a specialist garage. Škoda partners are always notified on any changes.

### WARNING

Unsuitable fluids and operating material as well as their improper use can cause accidents, serious injuries, burns and poisoning.

- Store fluids only in their closed original containers.
- Never use empty food cans, bottles or other containers for storage of fluids, since people could drink the contained fluids.
- Keep children away from all fluids and operating material.
- Always read and follow the information and warnings on the packaging of fluids.
- When using products that emit harmful vapours, always work outdoors or in a well-ventilated area.
- Never use fuel, turpentine, engine oil, nail polish remover, or other types of volatile liquid for vehicle care. These substances are toxic and highly flammable. They could cause fire and explosions! ▶

**NOTICE**

- Replenish only suitable fluids. Never mix up fluids under any circumstances. Otherwise, this could cause severe malfunctions and damage to the engine!
- Accessories and other attachment parts in front of the cooling air inlet impair cooling the efficiency of the engine coolant. At high ambient temperatures and high engine load, the engine can overheat!

**For the sake of the environment**

Leaking fluids can pollute the environment. Collect and dispose of fluid leaks in suitable containers in a proper and environmentally responsible manner.

**Repairs and technical modifications**

First read and observe the introductory information and safety warnings  on page 172.

Repairs and technical modifications must comply with the guidelines by Škoda ⇒ .

Interference on the electronic components and their software can lead to operational faults. This interference can also impair not directly affected systems because of the networking of the electronic components. This means that the operating safety of your vehicle can be considerably jeopardised, a greater wear of vehicle parts can occur and finally the type approval of the vehicle may become void.

Your Škoda partner can accept no liability for damages incurred due to improper repairs and technical modifications.

The Škoda partner is not liable for damages caused by improper repairs and technical modifications, and these are not covered by the Škoda warranty.

Škoda recommends that all repairs and technical modifications be carried out by authorised Škoda partners using **genuine Škoda parts**.

**Vehicles with special fittings and attachments**

The manufacturers of fittings and attachments ensure that the fittings and attachments (conversions) comply with applicable environmental laws and regulations, in particular the EU Directive 2000/53/EC on end-of-life vehicles and the EU Directive 2003/11/EC relating to restrictions of the marketing and use of certain dangerous substances and preparations.

The installation documentation of the conversions is to be kept by the vehicle owner and to be handed over to the dismantling facility when scrapping the vehicle. This is to ensure the environmentally sound recovery, even for converted vehicles.


**WARNING**

Improperly performed repairs and modifications can cause damage and malfunction of the vehicle and reduce the effectiveness of driver assist systems. This can lead to accidents and serious injuries.

- Repairs and modifications to the vehicle should be carried out only by a specialist garage.

**Repairs and impairments of the airbag system**

First read and observe the introductory information and safety warnings  on page 172.

Repairs and technical modifications must comply with the guidelines by Škoda ⇒ .

Modifications and repairs to the front bumper, the doors, the front seats, the headliner or the body should be carried out only by a specialist garage. These vehicle parts may include system components and sensors of the airbag system.

When working on the airbag system or removing and installing system parts due to other repairs, parts of the airbag system may be damaged. This may mean that the airbags will not deploy properly or not at all in the event of an accident.

Regulations must be observed to ensure that the effectiveness of airbags is not impaired and injuries and environmental pollution are not caused by removed parts. Specialist garages are familiar with these regulations.

A modification to the suspension of the vehicle can affect the functioning of the airbag system in a collision. For example, the use of rim-tyre combinations not approved by Škoda, lowering the vehicle, changing the suspension hardness including the springs, suspension struts, shock absorbers, etc. may change the forces that are measured by the airbag sensors and transmitted to the electronic control unit. Some modifications to the suspension may, for example, increase the forces measured by the sensors and cause the airbag system to deploy in collision scenarios in which it normally would not deploy if the modifications had not been made. Other modifications may reduce the forces measured by the sensors and prevent deployment of an airbag when it should deploy.



**⚠ WARNING**

Improperly performed repairs and modifications can cause damage and malfunction of the vehicle and reduce the effectiveness of the airbag system. This can lead to accidents and serious or fatal injuries.

- Repairs and modifications to the vehicle should be carried out only by a specialist garage.
- Airbag modules can not be repaired, but must be replaced.
- Never install any airbag parts in the vehicle that have been removed from old cars or have been recycled.

**⚠ WARNING**

A modification to the suspension of the vehicle including the use of non-approved rim-tyre combinations can alter the functioning of the airbag and increase the risk of serious or fatal injuries in an accident.

- Never install components of the suspension that do not have the same properties as the original parts installed in the vehicle.
- Never use a rim-tyre combination that has not been approved by Škoda.

**Retrofitting two-way radio equipment**

First read and observe the introductory information and safety warnings ⚠ on page 172.

For the operation of two-way radio equipment in the vehicle you need an external aerial.

Retrofitting electrical or electronic equipment in the vehicle affects the type approval of the vehicle. This may void the type approval of the vehicle.

Škoda has approved the use of two-way radio equipment under the following conditions:

- Properly installed external aerial,
- Maximum transmission power 10 watts.

The optimum range of the equipment is achieved only with an external aerial.

If you want to use a two-way radio system with a power of more than 10 watts, consult a specialist garage. A specialist garage knows the technical possibilities of retrofitting. Škoda recommends a Škoda partner for this purpose.

Observe the legal rules and follow the instructions in operating manuals of the two-way radio equipment.

**⚠ WARNING**

Unsecured or incorrectly secured two-way radio equipment may be thrown through the interior of the vehicle and cause injuries in a sudden driving or braking manoeuvre or accident.

- Always securely fasten or stow the two-way radio equipment properly and outside the airbag deployment areas while driving.

**⚠ CAUTION**

If operating a two-way radio system without connecting to an external aerial, the limits for electromagnetic radiation in the vehicle may be exceeded. This also applies to an improperly installed external aerial.

- Operate two-way radio equipment in the vehicle only with a properly connected external aerial.

**Information stored in the control units**

First read and observe the introductory information and safety warnings ⚠ on page 172.

The vehicle is equipped with electronic control units in the factory that control, among others, the engine and gearbox. The control units also monitor the function of the exhaust system and airbags.

For this purpose, the electronic control units continuously evaluate vehicle-related data while driving. In case of operational faults and deviations from the nominal values, only these data are stored. Faults are usually indicated by the indicator lights in the instrument cluster.

Data stored in the control units can only be read and evaluated by special equipment.

Only by storing the relevant data is a specialist garage able to identify and rectify problems that have occurred. The stored information may include the following data:

- Engine- and gearbox-related data.
- Vehicle speed.
- Driving direction.

- Braking power.
- Seat belt query.

Under no circumstances are conversations in the vehicle recorded by the built-in control units.

In vehicles with an alarm function via mobile phone or other connected devices, the current location may be transmitted. In case of accidents in which the control units recognise the deployment of one or more airbags, the system may automatically transmit a signal. This depends on the service provider. In principle, the transmission will only work in areas with adequate mobile network coverage.

#### Event data recorder

The vehicle is **not** equipped with an event data recorder.

An event data recorder temporarily stores information on the vehicle. In an accident, this will allow a detailed understanding of how the accident happened. In vehicles with an airbag system, accident-related data such as impact velocity, seat belt buckle statuses, seat positions, and deployment times may be stored. The type of data that is recorded varies depending on the manufacturer.

The installation of such an event data recorder may be made only with the consent of the owner and is regulated by law in some countries.

#### Reprogramming of control units

Basically, all data for the control of components are stored in the control units. Some convenience functions, such as convenience flashing, single door opening, and displays, can be reprogrammed using special workshop equipment. In this case, the relevant information and descriptions in this Owner's Manual will no longer match the original functions. Škoda recommends that you have the reprogramming registered in the service schedule under "Other workshop entries".

Information on possible reprogramming options can be obtained from your Škoda partner.

#### Reading out the fault memory of the vehicle

There is a diagnostic port in the passenger compartment for reading out the fault memory. The fault memory documents the problems and deviations encountered from the nominal values of the electronic control units.

The diagnostic connector port is located behind a cover in the footwell on the driver's side next to the lever to open the bonnet.

The fault memory should be read out and reset only by a specialist garage.

### Using a mobile phone in the vehicle without connection to the external aerial



**First read and observe the introductory information and safety warnings ▲ on page 172.**

Mobiles phones transmit and receive radio waves both during a call and in standby mode. The current scientific literature reports that radio waves can be harmful to the human body if they exceed certain limits. Governmental and international committees have adopted limits and guidelines to ensure that the electromagnetic radiation emitted from mobile phones is in a range which is safe for human health. However, there is no scientifically proven evidence that wireless phones are absolutely safe.

For this reason, some experts are calling for a preventive attitude in regard to the use of mobile phones while awaiting definitive results from the current research.

When a mobile phone is used inside the vehicle, which is not connected to the phone external aerial of the vehicle, the electromagnetic radiation may be higher than if the phone is connected to an integrated or other external aerial.

If the vehicle is equipped with a suitable hands-free system, this meets the legal requirements of many countries that allow the use of a mobile phone in a vehicle only via a hands-free system.

The factory-installed hands-free system has been designed for the use of traditional mobile phones and Bluetooth-compatible mobile phones. Mobile phones must be in a suitable mobile phone mount. The mobile phone mount itself must be securely snapped into its base. Only in this way, the mobile phone is securely fastened to the instrument panel and always within the driver's reach while connected to the phone external aerial of the vehicle.

A mobile phone that is connected to a vehicle-integrated phone aerial or an external phone aerial reduces the emitted electromagnetic radiation from mobile phones which acts on the human body. Moreover, this improves the connection quality.

If a mobile phone is used inside the vehicle without this hands-free kit, it is not securely fastened in the vehicle and not connected to the phone external aerial of the vehicle. In addition, the mobile phone will not be charged by the mount. It can also be expected that existing phone connections are interrupted and the connection quality is impaired.

- Use a mobile phone in the vehicle only if it is connected to a hands-free system with an external phone aerial. ▶

**⚠ WARNING**

An unsecured or improperly secured mobile phone may be thrown through the interior of the vehicle and cause injuries in a sudden driving or braking manoeuvre or accident.

- Always securely fasten or stow the mobile phone properly and outside the airbag deployment areas while driving.

**⚠ WARNING**

If using a mobile phone or two-way radio equipment without it connecting to an external aerial, the limits for electromagnetic radiation in the vehicle may be exceeded. This also applies to an improperly installed external aerial.

- Keep at least 8 in (20 cm) distance between the aerials of the mobile phone and a pacemaker, as mobile phones can interfere with the function of pacemakers.
- Do not carry a switched-on mobile phone in your breast pocket directly over the pacemaker.
- In case of suspected interference, switch off the mobile phone immediately.

### Jacking points for lifting the vehicle

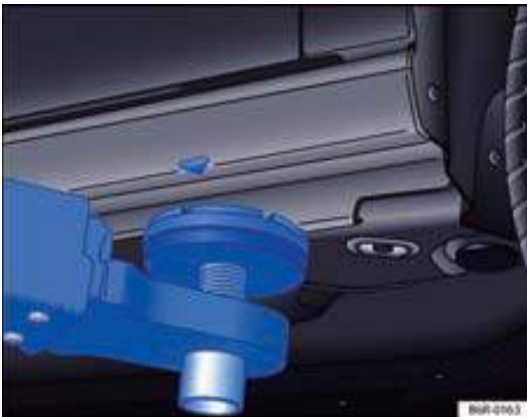


Fig. 97 Front jacking points to lift the vehicle with a lifting platform or car jack.

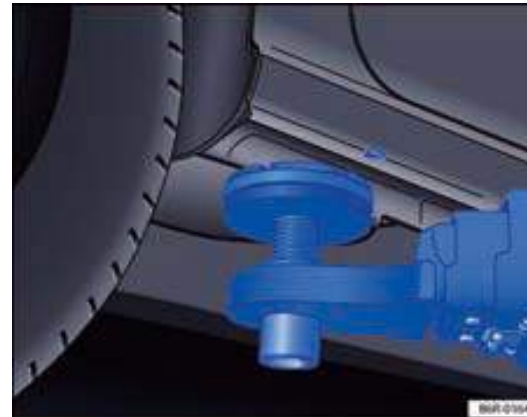





Fig. 98 Rear jacking points to lift the vehicle with a lifting platform or car jack.

 First read and observe the introductory information and safety warnings  on page 172.

The vehicle may be lifted only at the points shown in figures  $\Rightarrow$  fig. 97 and  $\Rightarrow$  fig. 98. If the vehicle is not lifted at the points shown, damage to the vehicle  $\Rightarrow$   or serious injuries may be caused  $\Rightarrow$  .

Lifting platforms with fluid cushions (acceptance platforms) may not be used to lift the vehicle.

There are many precautions that need to be observed when a vehicle is to be lifted using a lifting platform or car jack. Never lift a vehicle with a lifting platform or a jack, if you do not have the training, the knowledge and the experience necessary for a safe lifting.

Information on lifting the vehicle with the car jack  $\Rightarrow$  page 197.

**⚠ WARNING**

Improper lifting of the vehicle with a lifting platform or a car jack can cause accidents and serious injuries.

- Before lifting the vehicle, read the instruction manual of the lifting platform or car jack manufacturer and observe any legal regulations.
- No persons may be in the vehicle, when lifting the vehicle or when the vehicle is in the lifted position.

**⚠ WARNING (Continued)**

- Lift the vehicle only at the points shown in figures ⇒ [fig. 97](#) and ⇒ [fig. 98](#). If the vehicle is not lifted at the points shown, the vehicle may fall off the lifting platform, for example, when the engine and gearbox are removed.
- Jacking points of the vehicle should have a large area and should rest in the centre of the support plates of the lifting platform.
- Never start the engine while the vehicle is lifted! The vehicle may fall off the lifting platform by engine vibrations.
- If you want to work under a lifted vehicle, secure the vehicle with proper jack stands that have the appropriate carrying capacity.
- Never use the lifting platform as a ladder.
- Always make sure that the vehicle weight is not greater than the capacity of the lifting platform.

**ⓘ NOTICE**

- Never lift the vehicle at the engine oil pan, the gearbox, the rear axle or the front axle.
- When lifting the vehicle, be sure to use a rubber liner to prevent damage to the vehicle underbody. Also ensure that the lifting platform arms can be moved freely.
- The lifting platform arms must not come in contact with the side sills or other vehicle components.

## Consumer information

### Introduction

This chapter contains information on the following subjects:

Stickers and labels .....	179
Operating the vehicle in other countries and continents .....	179
Radio reception and aerial .....	180
Škoda repair information .....	180
Declaration of conformity .....	180
Return and scrapping of old vehicles .....	180

#### Additional information and warnings:

- Exterior views ⇒ page 6
- Accessories, spare parts, repairs and modifications ⇒ page 172

#### WARNING

Improper use of the vehicle increases the risk of accidents and injuries.

- Observe the statutory provisions.
- Read the Owner's Manual.

#### NOTICE

Improper use of the vehicle can cause damage to the vehicle.

- Observe the statutory provisions.
- Carry out service work in accordance with the service schedule.
- Read the Owner's Manual.

### Stickers and labels

 First read and observe the introductory information and safety warnings  on page 179.

The engine compartment and some vehicle parts contain factory-attached safety certificates, stickers and labels with important information for the operation of the vehicle, such as in the fuel filler flap, on the front passenger's sun visor, in the driver's door pillar or in the boot floor.

- Under no circumstances remove any safety certificates, stickers and labels or make them either unusable or unreadable.
- If vehicle parts provided with safety certificates, stickers and labels are replaced, identical safety certificates, stickers and labels must be affixed properly by a specialist garage in the same place on the new vehicle parts.


#### Safety certificate

A safety certificate on the door frame in the driver's door informs you that all necessary safety standards and requirements of the road safety authorities of the relevant country are satisfied at the time of production. In addition, the month and year of production and the chassis number could be listed.

#### Sticker to warn of high voltage

There is a sticker near the lock of the bonnet that warns of high voltage of the vehicle's electrical system. The ignition system of the vehicle meets, e.g., the Canadian Standard ICES-002.

### Operating the vehicle in other countries and continents

 First read and observe the introductory information and safety warnings  on page 179.

The vehicle was factory-produced for a particular country and meets its approval conditions that were valid at the time of vehicle production.

If the vehicle is sold to another country or is to be used in another country for an extended period, the applicable laws in the country must be observed.

It may be required to retrofit or remove certain equipment and disable certain functions. Similarly, service volumes and types of services may be affected. This is especially the case if the vehicle is operated for an extended period in a different climatic region.

Because of different frequency bands in other countries, the factory-delivered radio may not work in another country.

#### NOTICE

- Škoda is not responsible for damage to the vehicle arising from poor quality fuel, poor service or lack of original parts availability.
- Škoda is not responsible if the vehicle does not meet or only partially meets the relevant legal requirements in other countries and continents.

## Radio reception and aerial

 First read and observe the introductory information and safety warnings  on page 179.

With factory-installed radios, the aerial for radio reception can be installed at different locations in the vehicle:

- on the inside of the rear window along with the rear window heater,
- on the inside of the rear side windows,
- on the inside of the windscreen,
- on the roof.

Aerials on the inside of the windows are visible as thin wires.

### NOTICE

**Aerials located on the inside of the windows may be damaged by abrasive or caustic and acidic cleaning agents and other chemicals. Do not paste stickers over the window aerial and never clean the aerials with caustic or acidic cleaning agents and other chemicals.**

### Note

There may be interference in the AM band of the radio if electrical devices are used near the window aerial.

## Škoda repair information

 First read and observe the introductory information and safety warnings  on page 179.

Škoda service information and official Škoda repair information can be obtained for a fee from the following addresses:

### Customers in Europe, Asia, Australia, Africa, Central and South America

Please contact a Škoda partner or specialist garage or order appropriate literature from <https://erwin.skoda-auto.cz/>.

### WARNING

Improperly performed repairs and modifications can cause damage and operational faults of the vehicle and reduce the effectiveness of the driver assist systems and airbag system. This can lead to accidents and serious injuries.

- Repairs and modifications to the vehicle should only be performed by a specialist garage.

## Declaration of conformity

 First read and observe the introductory information and safety warnings  on page 179.

The respective manufacturer hereby declares that at the time of production of the vehicle the products listed below are in compliance with the essential requirements and other relevant regulations and laws, including FCC Part 15.19, FCC Part 15.21 and RSS-Gen Issue 1:

### Radio-based equipment

- Electronic immobiliser.
- Vehicle keys to the vehicle.

### Electrical equipment

- 12-Volt power socket.

## Return and scrapping of old vehicles

 First read and observe the introductory information and safety warnings  on page 179.

### Disposal of old vehicles

The disposal of an old vehicle must comply with the national legal requirements.

For more information on the return and recycling of old vehicles, ask your Škoda partner.

### Scrapping

If the vehicle or individual parts of the airbag system are scrapped, it is essential to observe the relevant safety precautions. Specialist garages are familiar with these regulations.

## Engine control and emission control system

### Introduction

This chapter contains information on the following subjects:

Indicator lights .....	181
Catalytic converter .....	182

#### Additional information and warnings:

- Shifting gears ⇒ page 98
- Refuelling ⇒ page 123
- Fuel ⇒ page 127



- Engine oil ⇒ page 136
- Vehicle battery ⇒ page 144
- Information stored in the control units ⇒ page 172
- Tow-starting and towing the vehicle ⇒ page 212






#### WARNING

The parts of the exhaust system become very hot. This may cause fires.

- Park the vehicle so that no parts of the exhaust system come in contact with highly flammable materials under the vehicle, such as dry grass.
- Never use additional underbody protection or anti-corrosion agents for exhaust pipes, catalytic converters or heat shields.

### Indicator lights

 First read and observe the introductory information and safety warnings  on page 181.


Illuminates	Possible cause	Remedy
	Engine control disturbed (Electronic Power Control).	Have the engine checked immediately by a specialist garage.
	Preheating of the diesel engine before starting.	⇒ page 94.
	Engine control or emission control system disturbed.	Reduce speed. Drive carefully to the nearest specialist garage. Have the engine checked.
Flashes	Possible cause	Remedy
	Engine control disturbed (diesel engine).	Have the engine checked immediately by a specialist garage.
	Misfires that can damage the emission control system.	Reduce speed. Drive carefully to the nearest specialist garage. Have the engine checked.

When switching on the ignition, some warning and indicator lights illuminate briefly as a function test. They will extinguish after a few seconds.

#### NOTICE

Always take notice of illuminated indicator lights and corresponding descriptions and instructions to avoid vehicle damage.

 **Note**

As long as the indicator lights  or **EPC** illuminate, engine problems, increased fuel consumption and reduce engine power can be expected. ■

### Catalytic converter

---



**First read and observe the introductory information and safety warnings  on page 181.**

The catalytic converter is used for exhaust gas treatment, and helps to reduce pollutant emissions in the exhaust. To ensure maximum service life of the exhaust system and the catalytic converter of the petrol engine:

- Use only unleaded petrol.
- Never run the fuel tank completely empty.
- Do not overfill with engine oil ⇒ page 136.
- Do not tow-start the vehicle but use a jump-start aid ⇒ page 209, Jump starting.

If misfiring, power loss or irregular engine running occurs while driving, reduce speed immediately and have the vehicle checked by a specialist garage. Unburnt fuel could otherwise get into the exhaust system and thus into the atmosphere. The catalytic converter may also be damaged by overheating!



### **For the sake of the environment**

Even if the emission control system is operating properly, a sulphur-like exhaust odour may be produced under certain operating conditions of the engine. This depends on the sulphur content of the fuel. ■



## Do-it-yourself

### Practical information

#### Questions and answers

If you suspect a malfunction or damage during handling of the vehicle, read and observe the following notes **before** visiting a Škoda partner or specialist garage. In addition, the index entries "Particulars" or "Checklist" may be helpful.

Particulars	Possible causes among others	Possible remedy
Engine will not start.	Vehicle battery is discharged.	- Use jump-start aid ⇒ page 209. - Charge vehicle battery ⇒ page 144.
	A wrong vehicle key is being used.	Use a valid vehicle key ⇒ page 32.
	The fuel level is low.	Fill up with fuel ⇒ page 123.
	Clutch pedal not fully depressed.	Release clutch and depress clutch pedal fully again ⇒ page 98.
Vehicle can not be unlocked or locked with the vehicle key.	- Battery in vehicle key empty. - Distance from vehicle too far. - Buttons pressed outside the effective range.	- Replace battery ⇒ page 32. - Go closer to the vehicle. - Synchronise the vehicle key ⇒ page 32. - Unlock or lock the vehicle manually ⇒ page 187.
Unusual noise.	Cold engine, brake assist systems.	See under index entry "Noise".
Strange handling characteristics.	Automatic gearbox is too hot.	Stop the vehicle immediately ⇒ page 103.
Functions are not as described in manual.	Settings have been made in the Škoda information system.	Check and, if necessary, reset to factory settings ⇒ page 23.
Road is not illuminated properly.	- Headlight has been set for left-hand or right-hand traffic.	- Convert headlight for left-hand or right-hand traffic ⇒ page 71.
	- Headlight set too high.	- Adjust headlight beam ⇒ page 71.
	- Bulbs failed.	- Replace bulbs ⇒ page 203.
	- Low beam not switched on.	- Switch on low beam ⇒ page 71.
Electrical loads do not work.	Low vehicle battery status.	Charge vehicle battery ⇒ page 144.
	Low fuel level.	Fill up fuel ⇒ page 123.
	Blown fuse.	Check fuse and replace if necessary ⇒ page 200. ▶

Particulars	Possible causes among others	Possible remedy
Fuel consumption is higher than indicated.	- Short-haul traffic - "Nervous accelerator pedal".	- Avoid short distances. - Drive with foresight. - Use the accelerator pedal smoothly.
	Electrical loads turned on.	Switch off unnecessary loads.
	Engine control disturbed.	Have disturbance resolved → page 181.
	Tyre inflation pressure too low.	Adjust the tyre inflation pressure → page 160.
	Driving in mountainous areas.	No direct remedy possible.
	Driving with high payload.	No direct remedy possible.
	Driving at high engine speed.	Select a higher gear.

## In an emergency

### Introduction

This chapter contains information on the following subjects:

Securing yourself and the vehicle .....	185
First-aid kit, warning triangle and safety vest .....	186

#### Additional information and warnings:

- Braking, stopping and parking ⇒ page 104
- Emergency closing or opening ⇒ page 187
- Tool kit ⇒ page 190
- Changing a wheel ⇒ page 194

#### **WARNING**



A broken-down vehicle is a high accident risk to itself and other road users.

- Stop the vehicle as soon as it is possible and safe to do so. Park the vehicle at a safe distance from moving traffic to securely lock all doors in an emergency. Switch on your hazard warning lights to warn other road users.
- Never leave children, disabled persons or people requiring help alone inside the vehicle when the doors are locked. Otherwise they may be trapped in the vehicle in an emergency. Trapped persons can be exposed to very high or very low temperatures.

### Securing yourself and the vehicle






Fig. 99 In the centre of the instrument panel: Switch for the hazard warning light system.

 First read and observe the introductory information and safety warnings  on page 185.

Observe the legal regulations for securing a broken-down vehicle. In many countries, for example, switching on the hazard warning light system and wearing a safety vest are required.

#### Checklist

For your own safety and the safety of the vehicle occupants, perform the following steps in the order stated ⇒ :

1. Park the vehicle at a safe distance from moving traffic and on a suitable surface ⇒ .
2. Switch on the hazard warning light system with the button  ⇒ fig. 99.
3. Apply the handbrake firmly ⇒ page 104.
4. Move the gearshift lever or selector lever to position **P** ⇒ page 98.
5. Switch off the engine and remove the ignition key from the ignition lock ⇒ page 94.
6. Have all passengers get off and move to a safe spot away from the flow of traffic, for example, behind the guard rail.
7. Take all vehicle keys along when leaving the vehicle.
8. Place the warning triangle to warn other road users of the vehicle.
9. Let the engine cool sufficiently and call for professional help if necessary.

With the hazard warning light system is activated, for example, during towing the vehicle, a change of direction or change of lanes can be indicated by operating the turn signal lever. The warning flash sign is suspended temporarily.

#### Switch on the hazard warning light system, for example:

- When the traffic ahead suddenly slows down or the end of a traffic jam is reached, in order to warn the traffic behind.
- if an emergency exists.
- If the vehicle breaks down.
- When towing.

Always observe the local regulations on the use of the hazard warning light system.

If the hazard warning light system is not operational, use other means to warn road users - in accordance with the legal provisions - of the broken-down vehicle. ►

**⚠ WARNING**

Failure to observe the checklist, which is for your own safety, can lead to accidents and serious injuries.

- Always follow the actions in the checklist and observe general safety precautions.

**⚠ WARNING**

The parts of the exhaust system become very hot. This may cause fires and serious injuries.

- Never park the vehicle such that parts of the exhaust system come in contact with highly flammable materials under the vehicle, such as dry grass, fuel.

**i Note**

The vehicle battery discharges itself if the hazard warning light system is switched on for an extended period of time – even if the ignition is switched off.

**i Note**

On some vehicles, the brake lights may flash during full braking at speed of more than approx. 50 mph (80 km/h), to warn the traffic behind. If braking continues, the hazard warning light system will switch on automatically below approx. 6 mph (10 km/h). The brake light will be lit permanently. When accelerating, the hazard warning light system automatically switches off.

### First-aid kit, warning triangle and safety vest



Fig. 100 In the boot: Storage compartment for the warning triangle.



First read and observe the introductory information and safety warnings ⚠ on page 185.

**First-aid kit**

A first-aid kit ⇒ fig. 100 ② may be stored in the storage compartment ① in the boot. To do so, open the boot lid and lift the floor covering.

The first-aid kit must satisfy legal requirements. Note the expiry date of the contents.

**Warning triangle**

A warning triangle ③ may be stored in the storage compartment ① in the boot. To do so, open the boot lid and lift the floor covering.

**Safety vest**

Some vehicle equipment includes a storage compartment for a safety vest in the driver's door ⇒ page 10.

**⚠ WARNING**

Loose objects may fly through the passenger compartment causing serious injuries during sudden driving and braking manoeuvres or an accident.

- Always securely fasten first-aid kit, safety vest and warning triangle.

## Emergency closing or opening

### Introduction

This chapter contains information on the following subjects:

Manually unlocking or locking the driver's door .....	187
Manually unlocking the front passenger door and rear doors .....	188
Emergency unlocking the selector lever lock .....	188

For example, if the radio signal from the vehicle key or the central locking system fails, it is possible to lock and partially unlock the doors and the boot lid.

#### Additional information and warnings:

- Vehicle key set ⇒ page 32
- Central locking system and closing system ⇒ page 35
- Doors ⇒ page 38
- Boot lid ⇒ page 40
- In an emergency ⇒ page 185

#### WARNING

Careless emergency closing or emergency opening can cause serious injuries.

- In a vehicle locked from the outside, it is not possible to open the doors and windows from the inside.
- Never allow children or people requiring help alone in the vehicle. In an emergency, they are unable to leave the vehicle alone or to help themselves.
- Depending on the season, very high or low temperatures may develop in a closed vehicle, causing serious injuries and illness or death especially in young children.

#### WARNING

The functional area of the doors and the boot lid is dangerous and can cause injuries.

- Open or close the doors and boot lid only when no one is within the swivelling range.

#### NOTICE

When doing an emergency closing or emergency opening, remove the parts carefully and reinstall them correctly to avoid vehicle damage.

### Manually unlocking or locking the driver's door

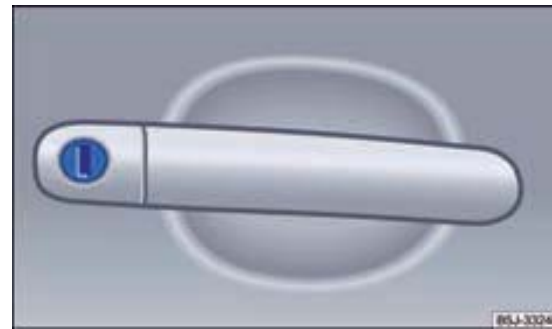


Fig. 101 Door handle on the driver's door with lock cylinder.

First read and observe the introductory information and safety warnings ⚠ on page 187.

When you lock the driver's door manually, usually all the doors are locked. When you manually unlock the driver's door, only the driver's door is unlocked ⇒ page 35.

- Flip out the key bit of the vehicle key ⇒ page 32.
- Insert the key bit into the lock cylinder ⇒ fig. 101 and unlock or lock the vehicle. ■


### Manually unlocking the front passenger door and rear doors



Fig. 102 Emergency locking the vehicle with the vehicle key (the emergency lock is covered by a rubber seal).

 First read and observe the introductory information and safety warnings  on page 187.

The passenger door and the rear doors each can be locked manually.

- Open the door.
- Remove the rubber seal in the face of the door. The seal is marked with a lock symbol  ⇒ fig. 102.
- Flip out the key bit of the vehicle key ⇒ page 32.
- Insert the flipped-out key bit into the recess and turn the vehicle key in the direction away from the vehicle ⇒ fig. 102.
- Reinstall the rubber seal and close the door completely.
- Check that the door is locked.
- Repeat for the other doors as necessary.
- Have the vehicle checked immediately by a specialist garage.

#### Note

Doors can be unlocked and opened from the inside by pulling the door opening lever. If necessary, the door opening lever must be pulled twice ⇒ page 35.

### Emergency unlocking the selector lever lock



Fig. 103 Remove the cover of the shift gate.



Fig. 104 Emergency unlock the release lever lock.

 First read and observe the introductory information and safety warnings  on page 187.


If the vehicle is to be moved or towed in case of a power supply failure, the emergency unlock lever must be used to move the selector lever to position **N**, e.g., if the battery is empty. ▶

The emergency unlock lever is located under the cover of the shift gate, on the right when looking in the driving direction.

#### Preparations

- Firmly pull the handbrake.
- Switch off the ignition.

#### Removing the cover of the shift gate

- Pull the cover around the selector lever gaiter upward ⇒ [fig. 103](#).
- Pull the cover up over the selector lever ⇒ .

#### Emergency unlocking the selector lever lock

- Push the unlock lever ⇒ [fig. 104](#) in the direction of the arrow and hold in this position.
- Push the lock button in the selector lever and move the selector lever to position **N**.

#### WARNING

Never move the selector lever from position **P** as long as the handbrake is not tight. Otherwise the vehicle may unexpectedly start to move on an uphill or downhill slope, causing accidents and serious injuries.

#### NOTICE

If the vehicle is rolling for an extended period or at fairly high speed with the engine switched off and the selector lever in position **N**, the automatic gearbox will be damaged, e.g., when towing.

## Tool kit

### Introduction


This chapter contains information on the following subjects:

Placement .....	190
Components .....	191

Observe the country-specific legal requirements when securing your vehicle in case of a breakdown.


#### Additional information and warnings:

- Preparing to work in the engine compartment ⇒ page 131
- In an emergency ⇒ page 185
- Changing a wheel ⇒ page 194

** WARNING**

In case of sudden driving or braking manoeuvres, a loose tool kit, breakdown kit, and spare wheel can be projected through the interior of the vehicle and cause severe injuries.

- Always make sure that your loose tool kit, breakdown kit, and spare wheel, or temporary spare tire, are securely stowed in the luggage compartment.

** WARNING**

An unsuitable or damaged tool kit can cause accidents and injuries.

- Never work with an unsuitable or damaged tool kit.

## Placement



Fig. 105 In the luggage compartment below the floor covering: Spare wheel and tool kit in the foam part.

 First read and observe the introductory information and safety warnings  on page 190.

The tool kit, spare wheel, or temporary spare tire are stowed in the luggage compartment below the floor covering.

Placement: in the luggage compartment	Action
In a foam part ⇒ fig. 105 below the floor covering:	- Lift the floor covering. - Open the retaining strap. - Remove the foam part.

#### Note

Wind the jack back into its original position after use to allow for secure stowing. ■



## Components

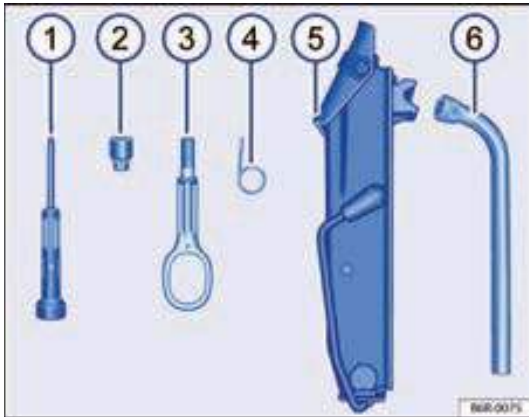



Fig. 106 Tool kit components.

 First read and observe the introductory information and safety warnings  on page 190.

The tool kit scope depends on the vehicle equipment level. The maximum scope is described in the following.

**Tool kit components** → fig. 106

- ① Screwdriver with hexagon socket in handle for loosening or tightening loosened wheel bolts. The screwdriver blade (Torx) is reversible.
- ② Adapter for anti-theft wheel bolt. Škoda recommends that you always carry the adapter for the wheel bolts with you in the vehicle. The **code number** of the wheel bolt lock is stamped on the face end of the adapter. You can use this number to procure a replacement adapter in case of loss. Note the wheel lock bolt code number and keep it separately from the vehicle.
- ③ Screw-in towing eye.
- ④ Wire clamp for removing the wheel centre cover, wheel trim, or wheel bolt covers.
- ⑤ Jack. Before you replace the jack in the foam part and/or the casing, fully retract the jack leg. Then clamp the jack handle against the side of the jack.
- ⑥ Wheel wrench.

## Wheel trims

### Introduction

This chapter contains information on the following subjects:

Wheel trim .....	192
Wheel bolt caps .....	193

#### Additional information and warnings:

- Maintaining and cleaning the vehicle exterior ⇒ page 148
- Tool kit ⇒ page 190
- Changing a wheel ⇒ page 194

#### WARNING

Unsuitable wheel trims and incorrect installation of wheel trims can cause accidents and serious injuries.

- Incorrectly installed wheel trims can come loose while driving and endanger other road users.
- Never use damaged wheel trims.
- Always make sure that the air supply to the brake cooling system is not interrupted or impaired. This also applies in case of retrofitting wheel trims. An insufficient air supply can considerably lengthen the braking distance.

#### NOTICE

Carefully remove the wheel trims and replace them correctly to avoid damage to the vehicle.

## Wheel trim



Fig. 107 Removing a push-on type wheel trim.

 First read and observe the introductory information and safety warnings  on page 192.

#### Removing and fitting push-on type wheel trims

- Remove the wheel wrench and wire clamp from the tool kit ⇒ page 190.
- Insert the wire clamp into one of the cut-outs on the wheel trim.
- Push the wheel wrench through the wire clamp ⇒ fig. 107 and lever off the wheel trim in the direction illustrated.
- When fitting a wheel trim, make sure that you push the wheel trim back onto the rim so that the valve cut-out is located above the tire valve. When fitting the wheel trim make sure that the trim latches securely into place around its complete circumference.


#### NOTICE

Wheel trims may be bolted on and must not be removed by force.

## Wheel bolt caps



Fig. 108 Pulling off the caps from the wheel bolts.

 First read and observe the introductory information and safety warnings  on page 192.

- Remove the wire clamp from the tool kit ⇒ page 190.
- Push the wire clamp through the opening in the cap ⇒ [fig. 108](#) and pull off in the direction of the arrow.

The caps serve to protect the wheel bolts and must be carefully replaced after changing a wheel.

**Anti-theft wheel bolts** have different caps. They only fit on anti-theft wheel bolts and not on standard wheel bolts. ■

## Wheel change

### Introduction

This chapter contains information on the following subjects:

Preparing to change a wheel .....	194
Wheel bolts .....	195
Lifting the vehicle with the jack .....	197
Wheel change .....	198
After a wheel change .....	199

Some vehicle types or vehicle models are factory supplied without a jack and a wheel wrench. In this case, seek professional assistance if you need to change a wheel.

Before you change a wheel yourself, make sure that the vehicle is securely parked, that you are familiar with the required actions and safety precautions, and that you have suitable tools at hand! Otherwise, seek professional assistance.

#### Additional information and warnings:

- Exterior views ⇒ page 6
- Vehicle key set ⇒ page 32
- Wheels and tires ⇒ page 160
- In an emergency ⇒ page 185
- Tool kit ⇒ page 190
- Wheel trims ⇒ page 192

### WARNING

Changing a wheel can be dangerous, especially at the roadside. To reduce the risk of serious injury, observe the following:

- Stop the vehicle as soon as it is possible and safe to do so. Park the vehicle at a safe distance to the flow of traffic to be able to change the wheel.
- All passengers, and especially children, must keep a safe distance outside of the work area at all time during a wheel change.
- Switch on your hazard warning lights to warn other road users.


### WARNING (Continued)

- Make sure that the ground is flat and firm. If necessary, set up the jack on a stable base with a large surface.
- Only change a wheel yourself if you are familiar with the required actions. Otherwise, seek professional assistance.
- Always use suitable and undamaged tools when changing a wheel.
- Always switch the engine off, apply the hand brake firmly, and set the selector lever to P position, or select a gear if you have a manual gearbox, to reduce the risk of inadvertent vehicle movement.
- After changing a wheel, always check the tightening torque of the wheel bolts with a torque wrench that is perfect working order.

### Preparing to change a wheel

 First read and observe the introductory information and safety warnings  on page 194.

#### Checklist

Always perform the following actions in the specified order as preparations for changing a wheel ⇒ :

1. In case of flat tire, always park the vehicle at a safe distance from the flow of traffic on flat and firm ground, if possible.
2. Apply the handbrake firmly ⇒ page 104.
3. Automatic gearbox: Shift the selector lever to P position ⇒ page 98.
4. Switch off the engine and remove the ignition key from the ignition lock ⇒ page 94.
5. Manual gearbox: Select a gear ⇒ page 98.
6. Make sure that all occupants leave the vehicle and seek safety, e.g. behind the crash barrier.
7. Block the wheel diagonally opposite with a stone or other suitable object.
8. If the luggage compartment is loaded: Remove the luggage.
9. Take the spare wheel or temporary spare tire from the luggage compartment.
10. Remove the wheel trim ⇒ page 192.

**WARNING**

Failure to observe the checklist, which is for your own safety, can lead to accidents and serious injuries.

- Always follow the actions in the checklist and observe general safety precautions.

**Wheel bolts**




Fig. 109 Changing a wheel: Slackening the wheel bolts.



Fig. 110 Changing a wheel: Anti-theft wheel bolt and adapter.




First read and observe the introductory information and safety warnings  on page 194.


To slacken the wheel bolts, use only the wheel wrench supplied with the vehicle. Only slacken the wheel bolts by about one turn until you have jacked up the vehicle.

If you cannot slacken a wheel bolt, carefully apply pressure to the end of the wheel wrench with your foot. Keep hold of the vehicle when doing so, and make sure you keep your footing.

**Slackening wheel bolts**

- Push the wheel wrench onto the wheel bolt up to the stop  $\Rightarrow$  fig. 109.
- Take hold of the end of the wheel wrench and turn the wheel bolt about *one* turn in anticlockwise direction  $\Rightarrow$  .

**Slackening anti-theft wheel bolts**

- Take the adapter for the anti-theft wheel bolts from the tool kit.
- Push the adapter onto the anti-theft wheel bolt up to the stop  $\Rightarrow$  fig. 110.
- Push the wheel wrench onto the adapter up to the stop.
- Take hold of the end of the wheel wrench and turn the wheel bolt about *one* turn in anticlockwise direction  $\Rightarrow$  .

**Important Information about Wheel Bolts**


Rims and wheel bolts are designed for the factory-fitted wheels. If you retrofit other rims, you must use matching wheel bolts of the right length and dome shape. This is essential to ensure that the wheels are tightly fitted and that the brake system operates properly.

Never use wheel bolts from vehicles of the same series.

**Wheel bolt tightening torque**

The prescribed tightening torque of the wheel bolts for steel and light alloy wheels is **120 Nm (88 ft lbs)**. After changing a wheel, always immediately check the tightening torque of the wheel bolts with a torque wrench that is perfect working order.

Corroded, stiff wheel bolts must be replaced **before checking** the tightening torque and the thread in the wheel hub must be cleaned.

Never grease or oil the wheel bolts and the thread in the wheel hubs. They could work loose during driving despite having the correct tightening torque. 

**⚠ WARNING**

Wheel bolts that are tightened incorrectly can work loose during driving and cause accidents, serious injuries, and loss of control over the vehicle.

- Only use the wheel bolts supplied with the rim in question.
- Never use different wheel bolts.
- Wheel bolts and the thread on the wheel hubs must be clean, easy moving, and free of oil and grease.
- Always use the wheel wrench factory-supplied with the vehicle for slackening and tightening wheel bolts.

**⚠ WARNING (Continued)**

- Only slacken the wheel bolts by about one turn until you have jacked up the vehicle.
- Never grease or oil the wheel bolts and the thread in the wheel hubs. They could work loose during driving despite having the correct tightening torque.
- Never slacken the threaded joints on rims with screw-type rim flanges.
- If the wheel bolts are tightened with a too low tightening torque, the wheel bolts and rims can work loose during driving. Excessive tightening torque can damage the wheel bolts and/or thread.

## Lifting the vehicle with the jack



Fig. 111 Jacking points for positioning the jack.

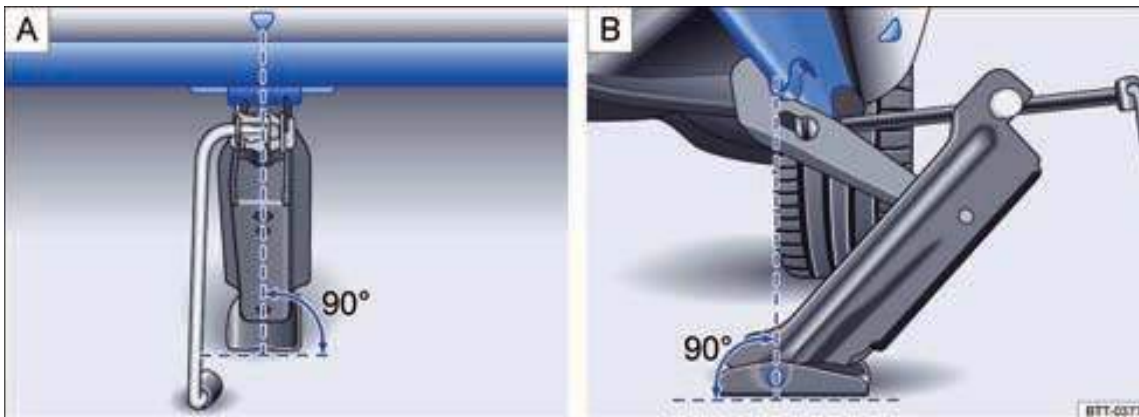





Fig. 112 Jack applied at rear left side of the vehicle.


 First read and observe the introductory information and safety warnings  on page 194.

Only apply the jack at the jacking points shown (marks on the body)  $\Rightarrow$  fig. 111. Always use the jacking point nearest to the wheel in question  $\Rightarrow$  .

The vehicle must only be jacked via the jacking points.

### Checklist

For your own safety and the safety of the vehicle occupants, perform the following steps in the order stated  $\Rightarrow$  .

1. Choose a flat and firm surface for jacking the vehicle.
2. Switch off the engine; for vehicles with a manual gearbox, select a gear, or shift the selector lever to **P** position,  $\Rightarrow$  page 98 and firmly apply the hand brake  $\Rightarrow$  page 104.
3. Slacken the wheel bolts on the wheel you will be changing  $\Rightarrow$  page 195. 

**Checklist (Continued)**

4. Look under the vehicle for the jacking point ⇒ fig. 111 nearest to the wheel you will be changing.
5. Crank up the jack to a point where you can still push it under the jacking point on the vehicle.
6. Make sure that foot of the jack is firmly seated on the ground and that the foot of the jack is precisely below the jacking point ⇒ fig. 112.
7. Align the jack and continue cranking up the jack leg until the claw fits around the strut below the vehicle ⇒ fig. 112 (arrow).
8. Continue cranking up the jack until the wheel is just about lifted off the ground.

**⚠ WARNING**

Improper use of the jack can lead to the vehicle slipping off the jack, thus causing serious injury. To reduce the risk of injury, observe the following:

- Only use jacks approved by Škoda for your vehicle. Other jacks can slip off, including jacks for other Škoda models.
- The ground must be flat and firm. Sloping or soft ground can cause the vehicle to slip off the jack. If necessary, set up the jack on a stable base with a large surface.
- In case of a slippery surface, such as a tiled floor, use an anti-slip base (e.g., a rubber mat) to prevent the jack slipping.
- Only apply the jack at the positions described. The claw on the jack must securely fit around the strut on the side member ⇒ fig. 112.
- Never put any part of your body (e.g. an arm or leg) under a vehicle that is lifted by a jack.
- If you want to work underneath the vehicle, you must additionally support the vehicle safely with axle stands.
- Never lift the vehicle if it is sloping, or the engine is running.
- Never switch on the engine while the vehicle is jacked. Vibrations from the engine can cause the vehicle to slip off the jack.

**⚠ WARNING**

Failure to observe the checklist, which is for your own safety, can lead to accidents and serious injuries.

- Always follow the actions in the checklist and observe general safety precautions.

**Wheel change**

Fig. 113 Changing a wheel: Unscrew the wheel bolts using the hexagon socket in the screwdriver handle.



First read and observe the introductory information and safety warnings ⚠ on page 194.

**Remove the wheel**

- Follow the checklist ⇒ page 194.
- Slacken the wheel bolts ⇒ page 195.
- Jack the vehicle ⇒ page 197.
- Completely remove the slackened wheel bolts using the hexagon socket in the screwdriver handle ⇒ fig. 113 and deposit on a clean base.
- Remove the wheel.

**Fit the spare wheel or temporary spare tire**

If applicable, observe the running direction of the tire ⇒ page 170, Unidirectional tyres.

- Fitting the spare wheel or temporary spare tire.
- Turn the anti-theft wheel bolt with the adapter clockwise and tighten slightly.
- Screw in all the other wheel bolts clockwise and tighten *slightly* using the hexagon socket in the screwdriver handle.
- Lower the vehicle with the jack. ▶



- Use the wheel wrench to tighten all the wheel bolts firmly in clockwise direction ⇒ ⚠. Do not work around the vehicle, but always move to a wheel bolt on the opposite side.
- If applicable, fit the caps, the hub cover, or the wheel trim ⇒ page 192.

### WARNING

Incorrect tightening torque, or improper handling of the wheel bolts, can cause loss of control over the vehicle, accidents and serious injuries.

- Always keep all wheel bolts and threads in the hubs clean, and free of oil and grease. The wheel bolts must turn easily and be tightened with the specified tightening torque.
- Only use the hexagon socket in the screwdriver handle for turning, but not for slackening or tightening the wheel bolts.

### After a wheel change



First read and observe the introductory information and safety warnings ⚠ on page 194.

- If needed, clean the tools and place them back in the foam part and/or casing in the luggage compartment ⇒ page 190.
- Safely stow the spare wheel, temporary spare tire, or the replaced wheel in the luggage compartment.
- Check the tightening torque of the wheel bolts immediately using a torque wrench ⇒ page 195.
- Replace the damaged wheel as quickly as possible.

## Fuses

### Introduction

This chapter contains information on the following subjects:

Fuses in the vehicle .....	201
Replacing blown fuses .....	202

Due to on-going development of the vehicle, equipment level dependent fuse assignments, and shared fusing of multiple power consuming devices via a single fuse, an up-to-date overview of the fuse locations for each power consuming device was not possible when this manual went to print. For information on the details of fuse assignments, please contact your Škoda Partner.

Multiple power consuming devices can share a single fuse. Conversely, multiple fuses may exist for a single power consuming device.

Only replace fuses after remedying the cause of the fault. Have the electrical system checked as quickly as possible by a specialist garage if a newly inserted fuse blows again after a short time.

#### Additional information and warnings:

- Preparing to work in the engine compartment → page 131

#### WARNING

High voltage of the electrical system can cause shocks, severe burns, and even fatal injury!

- Never touch the electric wiring on the ignition system.
- Avoid short circuiting the electrical system.

#### WARNING

The use of unsuitable fuses, repairs to fuses and short-circuiting a circuit without using a fuse can cause fire and serious injuries.

- Never fit fuses with a higher rating. Always replace fuses with fuses of the same rating (same colour and same labelling) and same size.
- Never repair fuses.
- Never replace fuses with strips of metal, paper clips, or similar.

#### NOTICE

- To avoid damage to the vehicle's electrical system, always switch off the ignition, the lights, and all power consuming devices and remove the ignition key from the ignition lock before replacing a fuse.
- If a fuse is replaced with one of a higher rating, damage can occur in other parts of the electrical system.
- Open distribution boards must be protected against dirt and moisture entering. Dirt and moisture in distribution boards can cause damage to the electrical system.

#### Note

Multiple fuses may exist for a single power consuming device.

#### Note

Multiple power consuming devices can share a single fuse. ■

## Fuses in the vehicle

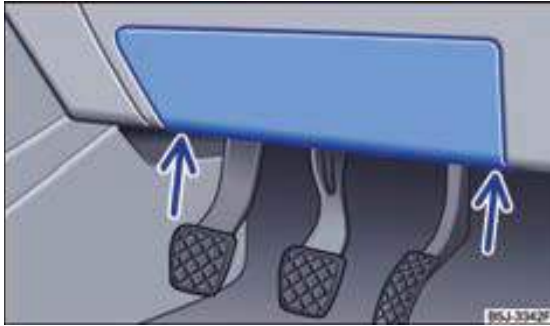


Fig. 114 On the driver's side of the dashboard: Distribution board cover.

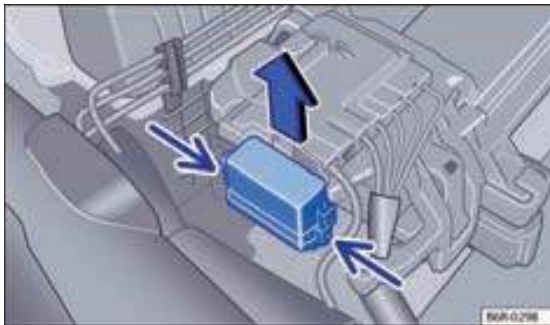


Fig. 115 Front left in the engine compartment: Distribution board cover.

First read and observe the introductory information and safety warnings on page 200.

Always replace fuses with fuses of the same rating (same colour and same labelling) and same size.

### Colour coding of fuses

Colour	Amperage
purple	3
light brown	5
brown	7,5
red	10

Colour	Amperage
blue	15
yellow	20
white or clear	25
green	30
orange	40

### Opening the distribution board on the dashboard

- Insert a flat object, e.g. a screwdriver, into the recesses  $\Rightarrow$  fig. 114 (arrows) and carefully lever off the cover.

### Opening the distribution board in the engine compartment

- Open the bonnet  $\Rightarrow$  page 131.
- Press the locking tabs together to unlock the cover on the distribution board  $\Rightarrow$  fig. 115 (arrows).
- Remove the cover in upward direction.

### NOTICE

- Remove the distribution board covers carefully and replace them correctly to avoid damage to the vehicle.
- Open distribution boards must be protected against dirt and moisture entering. Dirt and moisture in distribution boards can cause damage to the electrical system.

### Note

There are more fuses on the vehicle than described in this chapter. These fuses should only be replaced by an authorised expert.

## Replacing blown fuses

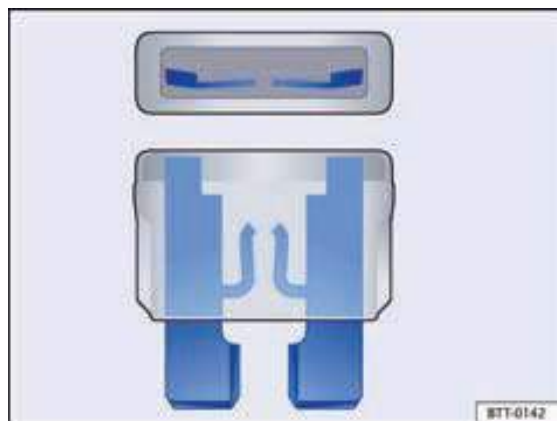


Fig. 116 Illustration of a blown fuse.

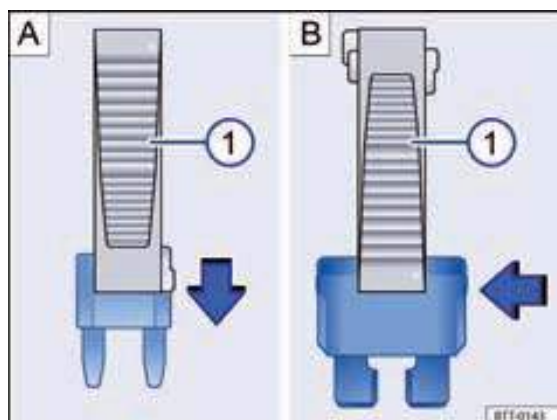


Fig. 117 Use the plastic tweezers ① to remove or insert the fuse.

 First read and observe the introductory information and safety warnings  on page 200.

### Preparations


- Switch off the ignition system, the lights and all power consuming devices.
- Open the correct distribution board  $\Rightarrow$  page 201.

### Identifying blown fuses

You can identify a blown fuses by the molten metal strip  $\Rightarrow$  fig. 116.

Shine a flashlight at the fuse. This will help you to identify the blown fuse more easily.

### Replacing fuses

- If applicable, remove the plastic tweezers  $\Rightarrow$  fig. 117 ① from the cover of the distribution board.
- In case of *small fuses*, push on the tweezers ① from the top  $\Rightarrow$  fig. 117 A.
- In case of *larger fuses*, push the tweezers ① onto the fuse from the side  $\Rightarrow$  fig. 117 B.
- Pull out the blown fuse.
- If the fuse is blown, replace the fuse with a fuse of the *same* rating (same colour and same labelling) and *same* size  $\Rightarrow$  .
- If applicable, replace the plastic tweezers in the cover.
- Replace the cover.

### NOTICE

If a fuse is replaced with one of a higher rating, damage can occur in other parts of the electrical system.

## Changing a bulb

### Introduction

This chapter contains information on the following subjects:

Information on bulb replacement .....	204
Replacing bulbs in the headlamp (Halogen H4) .....	205
Replacing the bulb in the front fog lamp .....	206
Bulb replacement in the tail light assembly .....	207
Replacing the rear license plate light bulb .....	208

Some manual skills are required to change a bulb. For this reason, Škoda recommends contacting your Škoda Partner to have the bulb changed, or seeking expert help, if you are uncertain. An expert is always needed if other parts of the vehicle need to be removed besides the bulb.

You should always keep a box with the replacement bulbs required for traffic safety in the vehicle. Replacement bulbs are available from your Škoda Partner. In some countries, you are legally required to keep replacement bulbs in the vehicle.

#### You can replace the following bulbs yourself:

- Bulbs from the halogen headlamps and/or possibly in the front bumper: low beam, main beam, parking light, front turn signal, front fog lamp.
- Bulbs in the tail light assembly: rear position lamp, rear fog lamp, brake light, rear turn signal, reversing lamp.
- If applicable, rear license plate light bulb.

All other bulbs and illuminants in the vehicle should be replaced by an expert.

#### Additional bulb specifications

Some headlamp or tail light assembly bulbs can possess factory specifications that differ from legacy bulbs. The designation is located on the light socket or the glass bulb.

#### Additional information and warnings:

- Exterior views ⇒ page 6
- Lights and visibility ⇒ page 71

- Preparing to work in the engine compartment ⇒ page 131
- Tool kit ⇒ page 190
- Fuses ⇒ page 200

#### WARNING

Accidents can be caused if the road is not sufficiently illuminated and the vehicle is not seen by or hard to see for other road users.

#### WARNING

Improper bulb replacement can cause accidents and serious injuries.

- Always read and observe the warnings before all work in the engine compartment ⇒ page 131. The engine compartment of any vehicle is a dangerous area and can cause serious injury.
- Only replace the bulb in question after it has completely cooled.
- Never replace a bulb if you are not familiar with the required actions. If you are uncertain as to steps involved, have the work done by an expert.
- Never touch the glass part of the bulb with your bare hands. Fingerprints left on the bulb evaporate in the heat when the bulb is switched on and can cause "blind spots" on the reflector.
- There are some sharp-edged parts on the headlamp housing in the engine compartment and the tail light assembly housing. Protect your hands during bulb replacement.

#### NOTICE

Failure to replace the rubber seals or plastic caps on the headlamp housing correctly after bulb replacement, can cause damage to the electrical system - due to water penetration in particular.

## Information on bulb replacement


---



First read and observe the introductory information and safety warnings  on page 203.

### Checklist

---

Always perform the following preparations for bulb replacement in the specified order :

1. Always park the vehicle at a safe distance from the flow of traffic on flat and firm ground, if possible.
2. Apply the handbrake firmly  $\Rightarrow$  page 104.
3. Turn the light switch to position **0**  $\Rightarrow$  page 71.
4. Turn the turn signal lever to neutral position  $\Rightarrow$  page 71.
5. Automatic gearbox: Shift the selector lever to **P** position  $\Rightarrow$  page 98.
6. Switch off the engine and remove the ignition key from the ignition lock  $\Rightarrow$  page 94.
7. Manual gearbox: Select a gear  $\Rightarrow$  page 98.
8. Allow the bulbs in question to cool.
9. Check if a fuse has visibly blown  $\Rightarrow$  page 200.
10. Replace the bulb in question in line with the instructions  $\Rightarrow$  page 205, Replacing bulbs in the headlamp (Halogen H4),  $\Rightarrow$  page 206, Replacing the bulb in the front fog lamp,  $\Rightarrow$  page 207, Bulb replacement in the tail light assembly,  $\Rightarrow$  page 208, Replacing the rear license plate light bulb. Only replace a bulb with a new bulb of the same type. The designation is located on the light socket or the glass bulb.
11. Never touch the glass part of the bulb with your bare hands. Your fingerprints would evaporate in the heat when the bulb is switched on causing a deposit on the reflector, thus impairing the illuminating power of the headlamp.
12. After a bulb replacement, always check the function of the bulb. If the bulb does not work, the bulb may be incorrectly fitted, or it may have dropped out, or the connecting plug may not be seated correctly.
13. After every bulb replacement on the front end of the vehicle, have the headlight beam setting checked by an expert.



### WARNING

Failure to observe the checklist, which is for your own safety, can lead to accidents and serious injuries.

- Always follow the actions in the checklist and observe general safety precautions.

## Replacing bulbs in the headlamp (Halogen H4)



Fig. 118 Rear view of the right H4 headlamp.

First read and observe the introductory information and safety warnings on page 203.

### Bulb replacement in the H4 headlamp

Perform the actions in the specified order:

	Low beam and main beam	Turn signal light (at the front)	Parking lights
1.	Follow the checklist and carry out the actions ⇒ page 204.		
2.	Open the bonnet  ⇒ page 131.		
3.	Remove the protective cover ①. Pull the connecting plug off the bulb. Fold down the bulb ③ by inserting slight pressure -arrow-. Pull the bulb ③ in backwards direction out of the bulb housing.	Turn the bulb housing ② anti-clockwise to the stop and pull out towards the back along with the bulb.	Remove the protective cover ①. Pull out the bulb housing and the bulb ④ towards the back.
4.	Replace the failed bulb with a new bulb of the same type.		
5.	Push the bulb ③ straight into the bulb housing (so that the fixing lugs slot into the recesses). Push the connecting plug onto the bulb.	Place the bulb housing ② in the headlamp and turn clockwise to the stop.	Push the bulb housing and bulb ④ into the headlamp.
6.	Replace the protective cover and check for correct seating.		

**i Note**

The illustrations show the right headlamp from the rear. The left headlamp is a mirror image of this.

### Replacing the bulb in the front fog lamp

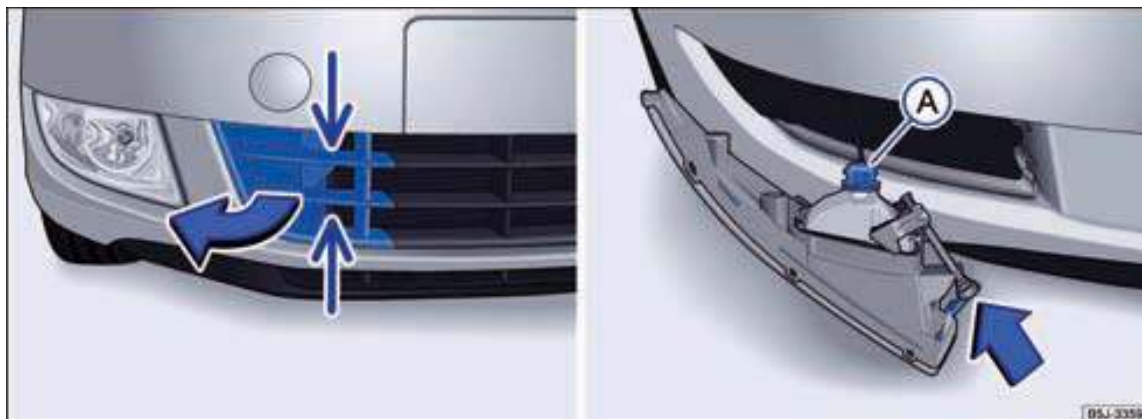



Fig. 119 In the bumper front right: Remove the fog lamp cover.

 First read and observe the introductory information and safety warnings  on page 203.

#### Perform the actions in the specified order:

1. Follow the checklist and carry out the actions ⇒ page 204.
2. Grasp the grille at the points marked with the ⇒ fig. 119 -arrows- - on the left, and remove it in the direction of the arrows.
3. Insert your hand into the opening left by the grille and press the retaining spring ⇒ fig. 119 -arrow- on the right.
4. Remove the front fog lamp.
5. Turn the bulb housing  anticlockwise to the stop and pull out towards the back along with the bulb.
6. Replace the failed bulb and bulb housing with a new bulb and bulb housing of the same type. Do not separate the bulb from the bulb housing.
7. Place the bulb housing in the headlamp and turn clockwise to the stop. Check the bulb housing for firm seating.

#### Perform the actions in the specified order:

8. Insert the front fog lamp with the lug on the side furthest from the license plate first.
9. Press in the fog lamp on the side closest to the license plate.
10. Insert the grille with the spring on the side closest to the license plate first.
11. Press in the grille on the side furthest from the license plate. Then check for correct seating.

**i Note**

The illustrations show the right-hand fog lamp. The left fog lamp is a mirror image of this.



## Bulb replacement in the tail light assembly

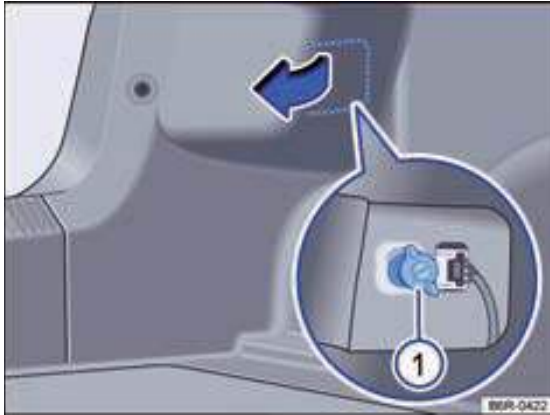


Fig. 120 At the side of the luggage compartment: Removing the tail light assembly.

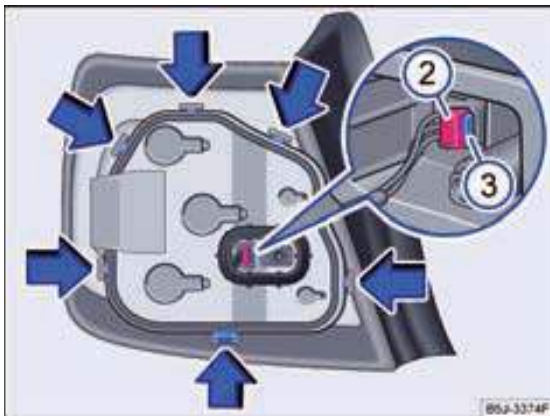


Fig. 121 Tail light assembly: Removing the bulb housing.

 First read and observe the introductory information and safety warnings  on page 203.

Perform the actions in the specified order.

### Removing the tail light assembly

1. Follow the checklist and carry out the actions → page 204.
2. Open the tailgate → page 40.
3. Reach into the opening in the side trim of the luggage compartment → fig. 120 and pull the pre-punched cover in the side trim forward.
4. Unscrew the attachment screw by hand → fig. 120 ①.
5. Carefully take the tail light assembly out of the body from the back.
6. Pull out the catch on the connecting plug → fig. 121 ②.
7. Press the lug → fig. 121 ③ and pull off the connecting plug.
8. Deposit the tail light assembly on a clean, smooth surface.

### Replacing the light bulb

9. To unlock the bulb housing, press the locking plates → fig. 121 in the direction of the arrows.
10. Remove the bulb housing from the tail light assembly.
11. Replace the failed bulb with a new bulb of the same type.
12. Place the bulb housing in the tail light assembly. All locking plates must audibly snap into place.

### Install the tail light assembly

13. Push the connecting plug onto the bulb housing. The lug ③ must audibly snap into place.
14. Snap the catch ② into place.
15. Carefully place the tail light assembly in the opening in the body. Check for correct seating in the mounts.
16. Hold the tail light assembly in installation position with one hand, and tighten the attachment screw with the other hand → fig. 120 ①.
17. Check the tail light assembly for correct installation and seating.
18. Fold back the cover in the side trim.
19. Close the tailgate → page 40.

## Replacing the rear license plate light bulb



Fig. 122 In the tailgate: Rear license plate lamp.

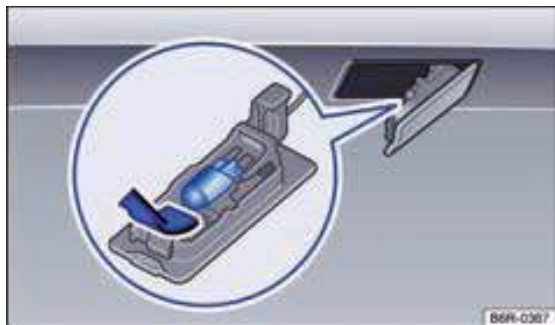


Fig. 123 Rear license plate lamp: Removing the bulb housing.

 First read and observe the introductory information and safety warnings  on page 203.

### Perform the actions in the specified order:

1. Follow the checklist and carry out the actions ⇒ page 204.
2. Push the flat blade of the screwdriver from the tool kit into the recess on the rear license plate lamp in the direction of the arrow ⇒ fig. 122.
3. Pull out the rear license plate lamp slightly.
4. Replace the failed bulb with a new bulb of the same type.

### Perform the actions in the specified order:

5. Carefully place the rear license plate lamp in the opening in the tailgate. Make sure that you install the rear license plate lamp in the right direction.
6. Press the rear license plate lamp into the tailgate until it audibly slots into place.

## Jump starting

### Introduction

This chapter contains information on the following subjects:

Performing jump starting ..... 210

If the engine fails to start because the vehicle's battery is discharged, you can use the battery on another vehicle to start. Before jump starting, check the viewing window on the vehicle battery, if applicable ⇒ page 144.

You will need suitable jump leads for jump starting, e.g. in line with DIN 72553 (see the lead manufacturer's specifications). The line diameter for petrol-engined vehicles must be at least 25 mm<sup>2</sup> (0.038 in<sup>2</sup>) and for diesel-engined vehicles at least 35 mm<sup>2</sup> (0.054 in<sup>2</sup>).

For vehicles without a battery in the engine compartment, the jump leads may only be connected to the jump start points in the engine compartment!

#### Additional information and warnings:

- Preparing to work in the engine compartment ⇒ page 131
- Vehicle battery ⇒ page 144

#### WARNING

Improper use of the jump leads, and improper performance of jump starting, can cause the vehicle's battery to explode and cause serious injuries. To reduce the risk of the vehicle's battery exploding, observe the following:

- All work on the vehicle's battery and electrical system can cause serious chemical burns, fire, or electric shocks. Before any work on the vehicle's battery, always read and observe the warnings and safety precautions ⇒ page 144, Vehicle battery.
- The vehicle battery which will provide the power must have the same voltage (12 Volt) and approximately the same capacity (see the markings on the vehicle battery) as the discharged battery.
- Never charge frozen or thawed vehicle batteries. A discharged battery may start to freeze at temperatures around 0 °C (+32 °F).
- A frozen or thawed vehicle battery must be replaced.

#### WARNING (Continued)

- Jump starting creates a highly explosive oxyhydrogen gas mixture in the vehicle's battery. Keep fire, sparks, open flames and lit cigarettes well clear of the vehicle's battery. Never use a mobile phone while you are attaching or removing the jump leads.
- Only charge the vehicle's battery in a well-ventilated space, because jump starting creates a highly explosive oxyhydrogen gas mixture in the vehicle's battery.
- Route the jump leads so that they cannot touch rotating parts in the engine compartment.
- Never confuse the positive terminal with the negative terminal or connect the jump leads incorrectly.
- Observe the jump lead manufacturer's instruction manual.

#### NOTICE

To avoid substantial damage to the vehicle's electrical system, observe the following:

- Incorrectly connected jump leads can cause a short circuit.
- There must not be any contact between the two vehicles otherwise current may flow as soon as the positive terminals are connected.

## Performing jump starting

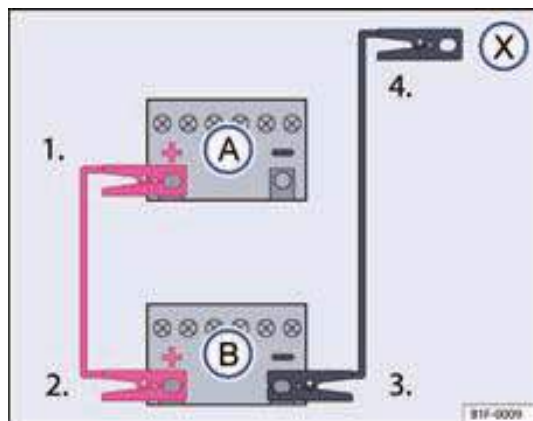


Fig. 124 Schematic for connecting the jump leads: Discharged vehicle battery (A) and vehicle battery supplying power (B).

First read and observe the introductory information and safety warnings on page 209.

- (A) Vehicle with discharged battery requiring jump start.
- (B) Vehicle with charged vehicle battery providing power for jump start.
- (X) Suitable ground connection. A solid metal part fixed to the cylinder block and crankcase, or the cylinder block and crankcase itself.

The discharged battery must be properly connected to the vehicle's electrical system.

The vehicles must not touch. Otherwise, current could start to flow when the positive terminals are connected.

Make sure that the crocodile clips have sufficient contact with metal.

If the engine does not start, interrupt the attempt after 10 seconds and wait for about 30 seconds before repeating.

Perform the actions in the specified order.

### Connecting the jump leads

- Switch off the ignition on both vehicles  $\Rightarrow$  page 94.
- Connect one end of the *red* jump lead to the positive terminal  $\Rightarrow$  fig. 124  $\oplus$  on the vehicle with the discharged battery (A)  $\Rightarrow$  .

- Connect the other end of the *red* jump lead to the positive terminal  $\oplus$  on the battery providing the power (B).
- Connect one end of the *black* jump lead to the negative terminal  $\ominus$  of the battery providing the power (B)  $\Rightarrow$  fig. 124.
- Connect the other end of the *black* jump lead  $\otimes$  to a solid metal part fixed to the cylinder block and crankcase, or the cylinder block and crankcase itself, on the vehicle with the discharged battery, taking care not to attach the jump lead in a position near the vehicle's battery (A)  $\Rightarrow$  .
- Route the jump leads so that they cannot be caught by any rotating parts in the engine compartment.

### Starting the engine

- Start the engine on the vehicle providing the power and allow it to idle.
- Start the engine on the vehicle with the discharged battery and wait for two to three minutes until the engine is "running smoothly".

### Removing the jump leads

- Before removing the jump leads, switch off the low beam, if switched on.
- In the vehicle with the discharged battery, switch on the heater fan to dissipate any peak voltages that might occur while disconnecting the leads.
- With the engine's running, disconnect the jump leads in precisely the reverse order to that one described above.

### WARNING

Incorrect jump starting can cause the vehicle battery to explode and lead to serious injuries. To reduce the risk of the vehicle's battery exploding, observe the following:

- All work on the vehicle's battery and electrical system can cause serious chemical burns, fire, or electric shocks. Before any work on the vehicle's battery, always read and observe the warnings and safety precautions  $\Rightarrow$  page 144, Vehicle battery.
- Always wear suitable protective goggles and never bend over the vehicle batteries.
- Connect the leads in the correct order - the positive cable first, then the negative cable.
- Never connect the negative cable to parts of the fuel system, or to the brake lines.

**⚠ WARNING (Continued)**

- Make sure that the non-insulated parts of the crocodile clips never touch. Additionally, make sure that the cable connected to the positive terminal of the battery never touches electrically conducting parts of the vehicle.
- Check the view window in the vehicle's battery; use a flashlight if needed. If the window is light yellow or colourless, do not attempt to jump start; instead seek expert assistance.
- Avoid electrostatic discharge in the vicinity of the vehicle's battery. Sparks could ignite the oxyhydrogen gas escaping from the battery.
- Never jump start if the battery is damaged, frozen or thawed.

## Tow-starting and towing

### Introduction

This chapter contains information on the following subjects:

Instructions for towing .....	212
Notes on towing .....	213
Fitting the front towing eye .....	213
Rear towing eye .....	214
Driving instructions for towing .....	214

Observe legal requirements for tow-starting or towing.

**A vehicle with a discharged battery must not be towed for technical reasons.**

**Additional information and warnings:**

- Exterior views ⇒ page 6
- Engine control unit and exhaust emission control unit ⇒ page 181

#### WARNING

**Never tow a vehicle without power.**

- **Never remove the ignition key from the ignition lock. Otherwise, the steering lock could suddenly engage. The vehicle cannot be steered in this case. This can cause accidents, serious injuries and loss of control over the vehicle.**

#### WARNING

**When a vehicle is towed, its driving behaviour and braking performance are substantially impaired. To reduce the risk of an accident, or serious injury, observe the following:**

- **As the driver of the towed vehicle:**
  - The pedal force required for braking is substantially higher because the brake booster is not working. Pay attention at all times to avoid running into the towing vehicle.
  - More force is required to steer the vehicle because the power steering does not work when the engine is not running.
- **As the driver of the towing vehicle:**
  - Use extra care and caution when accelerating.
  - Avoid sudden braking and driving manoeuvres.
  - Brake earlier than usual, but with less pedal pressure.

#### NOTICE

- Carefully remove and fit the cover and towing eye to avoid damage to the vehicle, e.g. to the paint.
- Unburned fuel may enter into and damage the catalytic converter during towing.

### Instructions for towing

 First read and observe the introductory information and safety warnings  on page 212.

**Vehicles should not be tow-started as a general rule. Jump start instead ⇒ page 209.**

The following vehicles must **not** be tow-started for technical reasons:

- vehicles with automatic gearbox.
- If the vehicle's battery is discharged, the engine control units may not function correctly.

**If your vehicle has to be towed (manual gearbox):**

- Select 2nd or 3rd gear.
- Keep the clutch depressed.

- Switch on the ignition system and the hazard warning lights.
- When both vehicles are moving, release the clutch.
- Once the engine has started, depress the clutch and take the vehicle out of gear to avoid running into the towing vehicle.

**! NOTICE**

Unburned fuel may enter into and damage the catalytic converter during towing.

**Notes on towing**



First read and observe the introductory information and safety warnings ▲ on page 212.

**Tow rope or tow bar**

A tow bar provides the safest approach to towing and is more gentle on the vehicles involved. You should only use a tow rope, if a tow bar is not available.

The tow rope must be elastic to protect the vehicle. Use a plastic fibre rope or one made of a similarly elastic material.

Attach the tow rope or tow bar to the eyes intended for towing only.

**Towing vehicles with automatic gearbox**

Observe the following for the towed vehicle:

- Shift the selector lever to **N** position.
- Do not tow at speeds above 50 km/h (30 mph).
- Do not tow further than 50 km (30 miles).
- A tow truck must only tow the vehicle with the vehicle's front wheels raised.

**When am I not permitted to tow the vehicle?**

You are not permitted to tow the vehicle under the following circumstances; in this case, the vehicle must be transported by a special transporter or trailer:

- If the vehicle's gearbox no longer contains any lubricant due to gearbox damage.
- If the towing distance for vehicles with automatic transmission is longer than 50 km (30 miles).

**i Note**


You can only tow the vehicle if the handbrake and steering lock have been released.

**Fitting the front towing eye**



Fig. 125 In the bumper front right: screw in the towing eye. ►




 First read and observe the introductory information and safety warnings  on page 212.

The mount for the screw-type towing eye is located front right in the bumper  [fig. 125](#).

You must always keep the towing eye in the vehicle.

Observe the instructions on towing  page 213.

#### Fitting the front towing eye

- Remove the towing eye and wheel wrench from the tool kit in the luggage compartment  page 190.
- Press the left edge of the cover -arrow- - left.
- Pull out the cover and leave it hanging on the vehicle,
- Screw the towing eye as firmly as possible, **anticlockwise** into the mount  [fig. 125](#) - right . Use the wheel wrench or another suitable object to screw the towing eye fully and firmly into the mount.
- After towing, unscrew the towing eye **clockwise** and refit the cover.
- If needed, clean the towing eye and wheel wrench and replace in the tool kit in the luggage compartment.

#### NOTICE


The towing eye must always be fully and firmly screwed into the mount. Otherwise, the towing eye might tear out of the mount during tow-starting or towing.

#### Rear towing eye



**Fig. 126** In the bumper rear right: fixed towing eye.

 First read and observe the introductory information and safety warnings  on page 212.

A fixed towing eye is located on the rear right below the bumper  [fig. 126](#). Depending on the equipment level, there may be a cover on the towing eye; you must remove this before use.

Observe the instructions on towing  page 213. ■

#### Driving instructions for towing

 First read and observe the introductory information and safety warnings  on page 212.

Towing another vehicle requires a certain amount of practice, particularly if you are using a tow rope. Both drivers should be familiar with the particular points about towing a vehicle. Inexperienced drivers should thus never tow.

While driving, take care to avoid impermissibly high tensile forces or jerky loads. If you attempt to tow a car that is not standing on a paved road there is always a risk of overstressing the towing eyes.

If the hazard warning lights and ignition system are switched on, the towed vehicle can still make a turn signal. Move the turn signal lever in the required direction. The hazard warning lights are switched off while the turn signal is given. Once the turn signal lever returns to the neutral position, the hazard warning lights automatically start flashing again.

#### Driver of the towed vehicle:

- Keep the ignition system switched on so that the steering wheel is not blocked and you can operate the turn signal lights, the horn, the windshield wipers and the window washer system.
- Because power steering does not function while the engine is off, more steering force is required.
- The pedal force required for braking is substantially higher because the brake booster is not working. Avoid running into the towing vehicle.
- More force is required to steer the vehicle because the power steering does not work when the engine is not running.
- For information and instructions also consult the manual for the towing vehicle. ▶



**Driver of the towing vehicle**

- Use extra care and caution when accelerating. Avoid sudden driving manoeuvres.
- Brake earlier than usual, but with gentle pedal pressure.
- For information and instructions also consult the manual for the towed vehicle. ■

## Index

- A**
- ABS**  
see Brake assist system ..... 109
- ABS brake assist system** ..... 109
- Accessories** ..... 172, 173
- Accident data recorder** ..... 176
- Adjusting**  
Air conditioning system ..... 120  
Correct seated position ..... 46  
Headlight beam ..... 74  
Head restraint ..... 48  
Mechanical front seats ..... 47  
Steering wheel ..... 49
- Aerial** ..... 180
- Airbag system** ..... 60  
Cleaning the instrument panel ..... 159  
Description ..... 62  
Front airbags ..... 64  
Function ..... 62  
Impairments ..... 174  
Indicator light ..... 62  
Lock vehicle after deployment ..... 35  
Repairs ..... 174  
Taking care of your vehicle ..... 159
- Air conditioning system** ..... 117  
Adjusting ..... 120  
Air outlets ..... 121  
Climatronic ..... 118  
Control elements ..... 118  
Manual air conditioning system ..... 118  
Operating information ..... 120  
Operational fault ..... 120  
Particulars ..... 120  
Recirculated air mode ..... 121
- Air outlets** ..... 121
- Alcantara** ..... 157
- Alternator** ..... 145
- Anodised surfaces** ..... 153
- Anti-theft wheel bolts** ..... 191, 194, 195
- Antifreeze agent** ..... 141
- Antilock Brake System (ABS)** ..... 109
- Arm rest** ..... 50
- Ash trays** ..... 91
- Ashtrays** ..... 91
- Assist systems**  
Antilock Brake System (ABS) ..... 109
- Automatic gearbox** ..... 98  
Driving ..... 103  
Kickdown function ..... 103  
Operational fault ..... 103  
see also Shifting gears ..... 98  
Selector lever emergency unlocking ..... 188  
Shifting gears ..... 101  
Tow-starting ..... 212  
Towing ..... 213  
Vehicle key removal lock ..... 96
- Automatic load deactivation** ..... 146
- Automatic transmission**  
see Automatic gearbox ..... 98
- Axle loads** ..... 83
- B**
- Bandaging material**  
see First-aid kit ..... 186
- Battery**  
Replacing in the vehicle key ..... 34  
see Vehicle battery ..... 144
- Battery acid** ..... 145
- Before driving to the specialist garage** ..... 183
- Biodiesel** ..... 128
- Bonnet**  
Closing ..... 134  
Opening ..... 134
- Boot lid** ..... 40  
closing ..... 41  
Driving with the lid open ..... 82  
Locking ..... 36  
Opening ..... 40  
Unlocking ..... 36, 40
- Brake** ..... 104  
ABS brake assist system ..... 109  
Brake booster ..... 107  
Brake fluid ..... 110  
Brake fluid change ..... 110  
Brake fluid level ..... 110  
Brake pads ..... 107  
Emergency braking indication in full braking .. 186  
Handbrake ..... 106  
Indicator light ..... 105  
Running in the brake system ..... 107  
Warning light ..... 105
- Brake booster** ..... 107, 109
- Brake fluid** ..... 110  
Specification ..... 110
- Brake system** ..... 109  
Fault ..... 107
- Breakdown**  
Securing the vehicle ..... 185
- Breaking down**  
Securing the vehicle ..... 185
- Bulb failure**  
see Changing a bulb ..... 203
- Bulb replacement**  
Checklist ..... 204  
Front fog lamp ..... 206  
in headlamp ..... 205  
in the tail light assembly ..... 207  
Preparations ..... 204  
Rear license plate lamp ..... 208

- C**
- Capacities**
    - Fuel tank ..... 126
    - Windscreen washer fluid reservoir ..... 78
  - Care**
    - see Vehicle care ..... 148
  - Car phone** ..... 175
  - Carrying children in the vehicle** ..... 66
    - Checklist ..... 67
  - Car wash plant** ..... 149
  - Catalytic converter** ..... 182
    - Indicator light ..... 181
    - Operational fault ..... 182
  - Cellular phone**
    - Use without an external aerial ..... 176
  - Central locking button** ..... 37
  - Central locking system** ..... 35
    - Central locking button ..... 37
    - Description ..... 35
    - Locking from the outside ..... 36
    - Unlocking and locking from the inside ..... 37
    - Unlocking from the outside ..... 36
  - Centre armrest** ..... 50
  - Centre console** ..... 14, 15
  - Changing a bulb** ..... 203
  - Changing lamps**
    - see Changing a bulb ..... 203
  - Chassis number** ..... 29
  - Checking the oil level** ..... 137
  - Checklist**
    - before working in the engine compartment ... 133
    - Breakdown ..... 185
    - Bulb replacement ..... 204
    - Carrying children in the vehicle ..... 67
    - Checks when refuelling ..... 126
    - Driving preparations ..... 26
    - Driving safety ..... 26
    - In an emergency ..... 185
    - Lifting the vehicle with the jack ..... 197
    - Motoring abroad ..... 27
    - Preparing to change a wheel ..... 194
    - Seat belts ..... 55
    - Seat covers ..... 157
  - Checks when refuelling** ..... 126
  - Child safety lock** ..... 39
  - Child seat** ..... 66
    - Carrying children in the vehicle ..... 66
    - In the front passenger seat ..... 68
    - In the rear seat bench ..... 69
    - Standards ..... 67
    - Weight groups ..... 67
  - Cigarette lighter** ..... 91
  - Cleaning**
    - see Vehicle care ..... 148
  - Cleaning chrome parts** ..... 153
  - Climatronic**
    - see Air conditioning system ..... 117
  - Clock** ..... 19
  - Closing**
    - Boot lid ..... 41
    - Doors ..... 38
    - Vehicle ..... 36, 37
    - Windows ..... 42
  - Clothes hook** ..... 87
  - CO2 emission** ..... 130
  - Cockpit** ..... 10
  - Code number** ..... 191
  - Consumer information** ..... 179
  - Control units** ..... 175
    - Reprogramming ..... 176
  - Convenience flashing** ..... 72
  - Convenience functions**
    - Reprogramming ..... 176
  - Conversions** ..... 174, 179
  - Coolant**
    - see Engine coolant ..... 140
  - Cup holders** ..... 89
    - Beverage bottles ..... 89
    - Front centre console ..... 89
    - Rear centre console ..... 90
- D**
- Daily trip counter** ..... 19
  - Data Link Connector (DLC)** ..... 176
  - Data recorder** ..... 175
  - Data recordings while driving** ..... 175
  - De-icing locks** ..... 154
  - De-icing the door lock cylinders** ..... 154
  - Declaration of conformity** ..... 180
  - Determine engine code**
    - ..... 30
  - Diagnostic connector port** ..... 176
  - Diagnostics** ..... 183
  - Diesel**
    - Fuel gauge ..... 124
  - Diesel fuel** ..... 128
    - Biodiesel ..... 128
    - Filter preheating ..... 128
    - Refuelling ..... 125
    - Winter-grade diesel ..... 128
  - Digital clock** ..... 19
  - Dimensions** ..... 30
  - Display** ..... 19, 20
    - Instrument cluster ..... 20
  - Disposal**
    - Airbag system ..... 180
    - Old vehicle ..... 180
  - Door opening lever** ..... 6, 10
  - Doors** ..... 38
    - Child safety lock ..... 39
    - Emergency closing or opening ..... 187
    - Warning light ..... 38
  - Dressing material**
    - see First-aid kit ..... 186
  - Driver's door**
    - Emergency closing or opening ..... 187
  - Driver's door**
    - Overview ..... 10

- Driving**  
 Before you start ..... 26  
 Data recordings ..... 175  
 Driving preparations ..... 26  
 Driving through water on roads ..... 28  
 Driving tips ..... 26  
 Economically ..... 112  
 Engine undershield ..... 26  
 Fuel gauge ..... 124  
 In an environmentally conscious manner ..... 112  
 Low fuel level ..... 125  
 Motoring abroad ..... 27  
 Parking on downhill slopes ..... 106  
 Parking on uphill slopes ..... 106  
 through salt water ..... 28  
 Towing ..... 214  
 With automatic gearbox ..... 103
- Driving abroad**  
 Headlights ..... 74
- Driving economically** ..... 112
- Driving in an environmentally conscious manner** ..... 112
- Driving light** ..... 73
- Driving preparations** ..... 26
- Driving safety** ..... 26
- Driving through salt water** ..... 28
- Driving through water** ..... 28
- Driving tips** ..... 26  
 Emergency spare wheel ..... 166  
 Spare wheel ..... 166  
 With loaded vehicle ..... 81
- Dust filter** ..... 120
- E**
- Electrical consumer** ..... 92
- Electrical load** ..... 186
- Electric power windows**  
 Force limiter ..... 43
- Electronic immobiliser** ..... 97
- Emergency braking indication** ..... 186
- Emergency closing or opening** ..... 187  
 Driver's door ..... 187  
 Front passenger door ..... 188  
 Rear doors ..... 188
- Emergency locking or unlocking**  
 Selector lever emergency unlocking ..... 188
- Emergency spare wheel** ..... 166  
 Driving tips ..... 166  
 Snow chains ..... 171
- Emission control system** ..... 181  
 Indicator light ..... 181  
 Operational fault ..... 182
- Emission filter** ..... 120
- Engine**  
 Noise ..... 97  
 Running in ..... 172
- Engine and ignition** ..... 94  
 12-Volt power socket ..... 92  
 Heating the glow plugs ..... 96  
 Ignition lock ..... 95  
 Immobiliser ..... 97  
 Non-authorized Ignition key ..... 95  
 Starting the engine ..... 96  
 Switching off the engine ..... 97
- Engine bonnet**  
 see Bonnet ..... 134
- Engine compartment** ..... 131  
 Cleaning ..... 154  
 Engine coolant ..... 140  
 Engine oil ..... 136  
 Plenum chamber ..... 154  
 Preparations ..... 133  
 Vehicle battery ..... 144
- Engine control** ..... 181  
 Indicator light ..... 181
- Engine coolant** ..... 140  
 Checking the coolant level ..... 142  
 Filler opening ..... 142  
 G 12 plus-plus ..... 141  
 Indicator light ..... 140  
 Replenishing ..... 142
- Specification ..... 141  
 Warning light ..... 140
- Engine data** ..... 30
- Engine oil** ..... 136  
 Change ..... 138  
 Checking the engine oil ..... 137  
 Consumption ..... 138  
 Dipstick ..... 137  
 Filler opening ..... 137  
 Indicator light ..... 136  
 Replenishing ..... 137  
 Specification ..... 136  
 Warning light ..... 136
- Engine problem** ..... 181
- Engine undershield** ..... 26
- Event data recorder** ..... 176
- Exterior mirrors** ..... 79  
 Adjusting ..... 79  
 Malfunction ..... 80  
 Vehicle care ..... 150
- Exterior views** ..... 6
- External aerial** ..... 175
- External start**  
 see Jump starting ..... 209
- F**
- Fault finding** ..... 183
- Fault memory**  
 Connector ..... 176  
 Reading out ..... 176
- Filter preheating** ..... 128
- First-aid kit** ..... 186  
 Storage ..... 186
- Fittings and attachments** ..... 174
- Floor mats** ..... 99
- Fluids** ..... 173
- Fog lights**  
 Fog headlights ..... 73  
 Rear fog light ..... 73

- Force Limiter**  
Power windows ..... 43
- Foreign countries**  
Longer stay abroad with the vehicle ..... 179  
Sale of the vehicle ..... 179
- FQAs** ..... 183
- Front airbags**  
see Airbag system ..... 64
- Front passenger airbag**  
see Airbag system ..... 60
- Fuel** ..... 127  
Diesel ..... 128  
Engine-dependent ..... 127  
Fuel types ..... 127  
Information on fuel consumption ..... 129
- Fuel consumption** ..... 129  
CO2 Emission ..... 130  
Driving economically ..... 112  
How is it determined? ..... 129  
Information ..... 129  
Technical data ..... 129  
What is the cause? ..... 182
- Fuel filler cap**  
Diesel ..... 125  
Petrol ..... 125
- Fuel gauge** ..... 124  
Indicator light ..... 124  
Petrol or diesel ..... 124
- Fuel types** ..... 127
- Full braking** ..... 186
- Fuses** ..... 200  
Colour coding ..... 201  
Distribution board ..... 201  
Identifying blown fuses ..... 202  
Preparations for replacing ..... 202  
Replacing ..... 202
- G**
- G 12 plus** ..... 141  
**G 12 plus-plus** ..... 141
- Glasses storage box** ..... 87
- Glove box**  
see Storage compartments ..... 87
- Gross weight** ..... 83
- H**
- Handbrake** ..... 106
- Hazard warning light system** ..... 185
- Headlamp beam adjustment** ..... 13
- Headlight beam adjustment** ..... 74
- Headlight flasher** ..... 72
- Headlights**  
Driving abroad ..... 74
- Head restraint** ..... 48
- Heating the glow plugs** ..... 96
- High-pressure cleaner** ..... 150
- Horn** ..... 13
- I**
- Identification number** ..... 29
- Ignition**  
see Engine and ignition ..... 94
- Ignition key**  
see Vehicle key ..... 32
- Ignition lock** ..... 95  
Non-authorized ignition key ..... 95  
Removal lock ..... 96
- Immobiliser** ..... 97  
Operational fault ..... 94
- In an emergency** ..... 185  
Bandaging material ..... 186  
Breakdown ..... 185  
Hazard warning light system ..... 185  
Securing yourself and the vehicle ..... 185  
Warning triangle ..... 186
- In case of a breakdown**  
Checklist ..... 185
- Indicator gauge**  
Indicator gauge ..... 124
- Indicator light**  
Airbag system ..... 62  
Brake system ..... 105  
Catalytic converter ..... 181  
Checking the engine oil level ..... 136  
Emission control system ..... 181  
Engine control ..... 181  
Engine coolant ..... 140  
Engine oil pressure ..... 136  
Engine oil sensor ..... 136  
Lights ..... 71  
Operating the brake ..... 105  
Overview ..... 17  
Refuelling ..... 124  
Shifting gears ..... 98  
Vehicle key ..... 33
- Inertia reel** ..... 59
- Information on fuel consumption** ..... 129
- Information stored in the control units** ..... 175
- Instrument cluster** ..... 17  
Display ..... 19, 20  
Indicator light ..... 17  
Instruments ..... 19  
Multi-function display (MFD) ..... 23  
Operate menus ..... 24  
Service interval display ..... 21  
Symbols ..... 17  
Warning lights ..... 17
- Instrument panel** ..... 10  
Airbag system ..... 60, 159  
Cleaning ..... 159
- Instruments** ..... 19
- Interference**  
Radio reception ..... 92
- Interior lighting** ..... 74
- Interior mirror** ..... 79

- J**
- Jack** ..... 194
  - Jacking the vehicle**
    - Checklist ..... 197
    - Jack ..... 197
    - with the jack ..... 197
  - Jump start**
    - Jump leads ..... 210
    - performing ..... 210
  - Jump starting** ..... 209
- K**
- Key**
    - Replacing the battery (vehicle key) ..... 34
    - see Vehicle key ..... 32
  - Keys**
    - see Vehicle keys ..... 32
  - Kickdown function** ..... 103
- L**
- Labels** ..... 179
  - Lifting platform** ..... 177
  - Lifting the vehicle**
    - Lifting platform ..... 177
    - With lifting platform ..... 177
  - Light**
    - Main beam lever ..... 72
  - Lights** ..... 71
    - Front interior lighting ..... 74
    - Headlight beam adjustment ..... 74
    - Indicator light ..... 71
    - Light switch ..... 73
    - Low beam ..... 73
    - Parking lights ..... 73
    - Reading lights ..... 74
    - Switching off ..... 73
    - Switching on ..... 73
  - Turn signal lever ..... 72
  - Warning signals ..... 73
  - Load capacity of tyres** ..... 170
  - Load deactivation** ..... 146
  - Loading**
    - Driving with the boot lid open ..... 82
    - General information ..... 81
    - Stowing luggage ..... 82
  - Load rating of tyres** ..... 169
  - Lock button** ..... 101
  - Locking**
    - after airbags are deployed ..... 35
    - Vehicle ..... 36
  - Low beam** ..... 73
- M**
- Main beam lever** ..... 72
  - Malfunction**
    - Electric exterior mirrors ..... 80
  - Manual air conditioning system**
    - see Air conditioning system ..... 117
  - Manual gearbox** ..... 98
    - see also Shifting gears ..... 98
  - Maximum speed** ..... 31
  - Mirrors** ..... 79
    - Exterior mirrors ..... 79
    - Interior mirror ..... 79
  - Mobile phone**
    - Use without an external aerial ..... 176
  - Modifications** ..... 174
  - Modifications to the vehicle** ..... 172
    - Labels ..... 179
    - Stickers ..... 179
  - Motoring abroad**
    - Checklist ..... 27
  - Multi-function display (MFD) in the instrument cluster** ..... 23
- N**
- Name plate** ..... 29
  - New engine** ..... 172
  - New tyres** ..... 162
  - Noise**
    - Brake assist systems ..... 109
    - Engine ..... 97, 128
    - Tyres ..... 170
  - Number of seats** ..... 44
- O**
- Octane number** ..... 127
  - Odometer** ..... 19
  - Oil**
    - see Engine oil ..... 136
  - Oil dipstick** ..... 137
  - Older tyres** ..... 161
  - On-Board-Diagnostic System (ODB)** ..... 176
  - Opening**
    - Bonnet ..... 134
    - Boot lid ..... 40
    - Doors ..... 38
    - Vehicle ..... 36, 37
    - Windows ..... 42
  - Operating material** ..... 193
  - Operational fault** ..... 182
    - Air conditioning system ..... 120
    - Automatic gearbox ..... 103
    - Catalytic converter ..... 182
    - Emission control system ..... 182
    - Immobiliser ..... 94
    - Radio reception ..... 180
  - Operation in winter**
    - Fuel consumption ..... 113
  - Outside temperature display** ..... 21
  - Overview**
    - Bottom part of the centre console ..... 15
    - Driver's door ..... 10
    - Driver's side ..... 12

- Front view ..... 7  
 Indicator lights ..... 17  
 Instruments ..... 19  
 Multi-function display (MFD) ..... 23  
 Passenger side ..... 16  
 Rear view ..... 8  
 Side view ..... 6  
 Top part of the centre console ..... 14  
 Turn signal and main beam lever ..... 72  
 Warning lights ..... 17  
**Owner's Manual shelf ..... 87**
- P**
- Park distance control**  
 Using a high-pressure cleaner ..... 150  
**Parking ..... 104, 106**  
**Parking lights ..... 73**  
**Particulars**  
 Car wash plant ..... 149  
 High-pressure cleaner ..... 150  
 Longer periods of non-use ..... 35  
 parking ..... 31  
 Parking ..... 104, 107  
 Push-starting ..... 94  
 Radio reception ..... 180  
 Removing the vehicle key ..... 96  
 Smoke ..... 128  
 Vehicle wash ..... 149  
 Water under the vehicle ..... 120  
**Pedals ..... 46, 99**  
**Performance ..... 31**  
**Petrol ..... 127**  
 Additives ..... 127  
 Fuel ..... 127  
 Fuel gauge ..... 124  
 Petrol ..... 127  
 Refuelling ..... 125  
 Types ..... 127  
**Physical principle of a frontal collision ..... 53**  
**Plenum chamber ..... 154**
- Polishing ..... 153**  
**Pollen filter ..... 120**  
**Power socket ..... 92**  
 12 Volt ..... 92  
**Power windows ..... 42**  
 Buttons ..... 42  
 Closing ..... 42  
 Opening ..... 42  
**Preparations**  
 before each drive ..... 26  
 Bulb replacement ..... 204  
 Checking the engine coolant level ..... 142  
 Checking the engine oil level ..... 137  
 Replenishing engine coolant ..... 142  
 Replenishing engine oil ..... 137  
 Vehicle battery ..... 145  
 Working in the engine compartment ..... 133  
**Preparatory actions**  
 Wheel change ..... 194  
**Preserving the paintwork ..... 153**  
**Push-starting ..... 94**
- Q**
- Questions and answers ..... 183**
- R**
- Radio reception**  
 Aerial ..... 180  
 Interference ..... 92  
 Operational fault ..... 180  
**Reading light ..... 74**  
**Rear mirror ..... 79**  
**Rear window heater ..... 119**  
**Recirculated air mode ..... 121**  
 Operating principle ..... 121  
 Switching off ..... 121  
 Switching off temporarily ..... 121  
**Refuelling ..... 123**  
 At the petrol station ..... 123  
 Checks when refuelling ..... 126  
 Diesel ..... 125  
 Fuel filler flap ..... 125  
 Fuel gauge ..... 124  
 Incorrect refuelling ..... 124  
 Indicator light ..... 124  
 Petrol ..... 125  
**Remote control key**  
 see Vehicle key ..... 32  
**Removing ice ..... 151**  
**Removing snow ..... 150**  
**Removing wax residues ..... 150**  
**Repairs ..... 172, 174**  
 Airbag system ..... 174  
 Labels ..... 179  
 Lifting platform ..... 177  
 Stickers ..... 179  
**Replacement key**  
 see Vehicle key ..... 32  
**Replacement of parts ..... 172, 173**  
**Reprogramming of control units ..... 176**  
**Retrieving service message ..... 22**  
**Retrofitting**  
 Car phone ..... 175  
 Two-way radio equipment ..... 175  
**Return of old vehicles ..... 180**  
**Revolutions counter ..... 19**  
**Rims ..... 162**  
 Cleaning ..... 153  
**Rocker switches**  
 Tiptronic ..... 102  
**Roof luggage rack ..... 81**  
**Routing of the belt webbing ..... 57**  
**Rubber seals ..... 154**  
**Running in**  
 Brake pads ..... 107  
 Engine ..... 172

- The first miles ..... 172  
 Tyres ..... 162
- Running in brake pads**  
 see also Brake ..... 107
- S**
- Safety belts**  
 Fastening ..... 56  
 Releasing ..... 56
- Safety equipment** ..... 63
- Safety vest** ..... 186
- Sale of the vehicle**  
 To other countries/continents ..... 179
- Scrapping** ..... 180
- Seat belt**  
 Fastening with the seat belt ..... 69  
 Twisted belt ..... 55
- Seat belt height adjuster** ..... 59
- Seat belts** ..... 52  
 Checklist ..... 55  
 Cleaning ..... 159  
 Not fastened ..... 54  
 Routing of the belt webbing ..... 57  
 Seat belt height adjuster ..... 59  
 Using ..... 55
- Seat belts protect** ..... 55
- Seat covers** ..... 156  
 Checklist ..... 157  
 Cleaning Alcantara ..... 157  
 Cleaning cloth trims ..... 157  
 Cleaning upholstery cloth ..... 157  
 Treating seat covers ..... 157  
 Treatment ..... 157
- Seated position**  
 Bad seated position ..... 45
- Seat features** ..... 51
- Seats** ..... 44  
 Mechanical front seats ..... 47
- Selector lever lock** ..... 101
- Selling the vehicle** ..... 3
- Service interval display** ..... 21
- Service position of the windscreen wipers** ..... 152
- Shifting gears** ..... 98  
 Automatic gearbox ..... 101  
 Engaging a gear (automatic gearbox) ..... 101  
 Engaging a gear (manual gearbox) ..... 100  
 Manual gearbox ..... 100  
 Selector lever emergency unlocking ..... 188  
 Warning and indicator lights ..... 98  
 With the Tiptronic ..... 102
- Sitting** ..... 44  
 Adjusting the head restraint ..... 48  
 Adjusting the steering wheel position ..... 49  
 Correct seated position ..... 46  
 Installing a head restraint ..... 48  
 Number of seats ..... 44  
 Removing a head restraint ..... 48
- Snow chains** ..... 171
- Snow wheel**  
 Emergency spare wheel ..... 171
- Spare canister** ..... 123
- Spare parts** ..... 173
- Spare tyre**  
 Emergency spare wheel ..... 166
- Spare wheel** ..... 166  
 Driving tips ..... 166  
 Taking out ..... 166
- Specifics**  
 Towing ..... 212, 213
- Speed code letters** ..... 170
- Steering** ..... 115  
 Indicator light ..... 115  
 Locking ..... 95  
 Pulling to one side ..... 165  
 Steering lock ..... 116  
 Vibrating ..... 165  
 Warning light ..... 115
- Steering wheel**  
 Adjusting ..... 49  
 Rocker switches (Tiptronic) ..... 102
- Steering wheel lock** ..... 95
- Stickers** ..... 179
- Storage compartment**  
 Handbrake lever ..... 86  
 See Storage facilities ..... 85
- Storage compartments**  
 Front centre compartment ..... 86  
 Front centre console ..... 86  
 Front doors ..... 85  
 Front passenger side ..... 87  
 Glove box ..... 87  
 Owner's Manual ..... 87
- Storage facilities** ..... 85  
 Other storage facilities ..... 87
- Stowing luggage** ..... 82
- Sun screen** ..... 76
- Sun visors** ..... 76
- Suspected problem** ..... 183
- Symbols**  
 see Indicator light ..... 17  
 see Warning light ..... 17
- Systems**  
 ABS ..... 109  
 Antilock Brake System (ABS) ..... 109
- T**
- Tailgate**  
 see Boot lid ..... 36, 40
- Technical data** ..... 29  
 Axle loads ..... 83  
 Capacities ..... 78, 126  
 CO2 emission ..... 130  
 Dimensions ..... 30  
 Displacement ..... 30  
 Engine data ..... 30  
 Engine oil specification ..... 136  
 Fuel consumption ..... 129  
 Fuel type ..... 127  
 Gross weight ..... 83  
 Maximum speed ..... 31  
 Name plate ..... 29



- Performance ..... 31  
 Power ..... 30  
 Type plate ..... 29  
 Tyre inflation pressure ..... 163  
 Unloaded weight ..... 83  
 Vehicle data sticker ..... 29  
 Weights ..... 83
- Technical modifications** ..... 174  
 Labels ..... 179  
 Lifting platform ..... 177  
 Stickers ..... 179
- Temperature display**  
 Outside temperature ..... 21
- Tightening torque**  
 Wheel bolts ..... 195
- Time clock** ..... 19
- TIN** ..... 169
- Tiptronic** ..... 102
- Tool kit** ..... 190  
 Components ..... 191  
 Placement ..... 190
- Tools**  
 see Tool kit ..... 190
- Tow-starting**  
 Specifics ..... 212  
 Tow-starting prohibition ..... 212
- Towing** ..... 212  
 Automatic gearbox ..... 212, 213  
 Driving instructions ..... 214  
 Front towing eye ..... 213  
 Rear towing eye ..... 214  
 Specifics ..... 212, 213  
 Tow bar ..... 213  
 Towing prohibition ..... 213  
 Tow rope ..... 213
- Towing a trailer** ..... 81
- Towing device** ..... 81
- Traction** ..... 169
- Trailer** ..... 81
- Trailer coupling** ..... 81
- Transporting** ..... 81  
 Driving tips ..... 83  
 Driving with the boot lid open ..... 82  
 Stowing luggage ..... 82
- Tread depth** ..... 164
- Treadwear** ..... 169
- Trip counter** ..... 19
- Troubleshooting** ..... 183
- Turn signal lever** ..... 72
- Two-way radio equipment** ..... 175
- Type plate** ..... 29
- Tyre damage** ..... 165
- Tyre inflation pressure** ..... 163  
 Checking ..... 164  
 Emergency spare wheel ..... 164  
 Spare wheel ..... 164
- Tyres**  
 see Wheels and tyres ..... 160
- Tyre wear** ..... 165
- U**
- Underbody protection** ..... 154
- Unidirectional tyres** ..... 170
- Unloaded weight** ..... 83
- Unlocking**  
 Vehicle ..... 36
- V**
- Valve caps** ..... 164
- Vanity mirror** ..... 76
- Vehicle**  
 Loading ..... 81  
 Locking from the outside ..... 36  
 Parking on downhill slopes ..... 106  
 Parking on uphill slopes ..... 106  
 Recycling ..... 180  
 Return ..... 180  
 Securing ..... 185
- Unlocking and locking from the inside ..... 37  
 Unlocking from the outside ..... 36
- Vehicle battery** ..... 144  
 Automatic load deactivation ..... 146  
 Battery acid ..... 145  
 Charging ..... 145  
 Checking the electrolyte level ..... 145  
 Connecting ..... 145  
 discharges itself ..... 95, 146  
 Discharges itself ..... 186  
 Discharging ..... 35  
 Disconnecting ..... 145  
 Explanation of symbols ..... 144  
 Installation position ..... 144  
 Jump start ..... 210  
 Preparations ..... 145  
 Replacing ..... 145  
 Warning light ..... 145
- Vehicle care**  
 Airbag modules (instrument panel) ..... 159  
 Alcantara ..... 157  
 Anodised surfaces ..... 153  
 Car wash plant ..... 149  
 Chrome parts ..... 153  
 Cleaning storage shelves ..... 158  
 Cleaning the rims ..... 153  
 Cleaning the seat belts ..... 159  
 Cleaning the wiper blades ..... 151  
 Cloth trims ..... 157  
 De-icing the door lock cylinders ..... 154  
 Engine compartment ..... 154  
 Exterior ..... 148  
 Exterior mirrors ..... 150  
 High-pressure cleaner ..... 150  
 Instrument panel ..... 159  
 Interior ..... 156  
 Particulars ..... 149, 150  
 Plastic parts ..... 159  
 Replacing the wiper blades ..... 151  
 Rubber seals ..... 154  
 Service position ..... 152  
 Treating seat covers ..... 157

- Underbody protection ..... 154
  - Upholstery cloths ..... 157
  - Vehicle paintwork ..... 153
  - Washing by hand ..... 149
  - Washing the vehicle ..... 149
  - Window aerial ..... 180
  - Windows ..... 150
  - Vehicle data sticker ..... 29**
  - Vehicle identification data ..... 29**
  - Vehicle identification number ..... 29**
  - Vehicle key**
    - Assigning ..... 32
    - Indicator light ..... 33
    - Remote control key ..... 32
    - Replacement key ..... 32
    - Synchronising ..... 34
  - Vehicle key set ..... 32**
  - Vehicle overview**
    - Front view ..... 7
    - Rear view ..... 8
    - Side view ..... 6
- W**
- Warning light**
    - Alternator ..... 145
    - Brake system ..... 105
    - Doors ..... 38
    - Engine coolant ..... 140
    - Operating the brake ..... 105
    - Overview ..... 17
    - Shifting gears ..... 98
    - Vehicle battery ..... 145
  - Warning signals**
    - Lights ..... 73
    - Warning and indicator lights ..... 17
  - Warning triangle ..... 186**
  - Washing ..... 148**
    - By hand ..... 149
    - With a high-pressure cleaner ..... 150
  - Washing the vehicle**
    - Particulars ..... 149
  - Washing your vehicle ..... 149**
  - Wear indicators ..... 165**
  - Weights ..... 83**
  - What happens to occupants not wearing seat belts? ..... 54**
  - What if? ..... 183**
  - Wheel bolts ..... 194, 195**
    - Caps ..... 193
    - Tightening torque ..... 195
  - Wheel change ..... 194**
    - After a wheel change ..... 199
    - Jacking the vehicle ..... 197
    - Preparatory actions ..... 194
    - Wheel bolts ..... 195
    - Wheel change ..... 198
  - Wheel covers**
    - Wheel trim ..... 192
  - Wheels**
    - Winter tyres ..... 170
  - Wheels and tires**
    - Wheel change ..... 194
  - Wheels and tyres ..... 160**
    - Avoiding damage ..... 161
    - Balancing wheels ..... 165
    - Exchanging tyres ..... 161
    - Handling wheels and tyres ..... 161
    - Imbalance ..... 165
    - Load capacity of tyres ..... 170
    - Marking ..... 168
    - New tyres ..... 162
    - Older tyres ..... 161
    - Penetrated foreign bodies ..... 165
    - Replacing tyres ..... 162
    - Rims ..... 162
    - Running in ..... 162
    - Serial number ..... 169
    - Snow chains ..... 171
    - Spare wheel ..... 166
    - Speed code letter ..... 169
  - Speed code letters ..... 170
  - Storing tyres ..... 161
  - Stowing the replaced wheel ..... 166
  - Technical data ..... 168
  - Tread depth ..... 164
  - Tyre damage ..... 165
  - Tyre identification number (TIN) ..... 169
  - Tyre inflation pressure ..... 163
  - Tyre inscription ..... 168
  - Unidirectional tyres ..... 161, 170
  - Valve caps ..... 164
  - Wear indicators ..... 165
  - Wheel alignment errors ..... 165
- Wheels and Tyres**
- Tyre wear ..... 165
- Wheel trims ..... 192**
- Caps on wheel bolts ..... 193
- Window aerial ..... 180**
- Windows**
- see Power windows ..... 42
- Windscreen washer fluid**
- Checking ..... 78
  - replenishing ..... 78
- Windscreen washers ..... 77**
- Windscreen wipers ..... 77**
- Folding away the wiper blade ..... 152
  - Lifting the wiper blade ..... 152
  - Service position ..... 152
  - Windscreen wiper lever ..... 77
- Winter-grade diesel ..... 128**
- Winter operation**
- Filter preheating ..... 128
  - Snow chains ..... 171
  - Tread depth ..... 164
  - Tyre inflation pressure ..... 163
  - Winter-grade diesel ..... 128
  - Winter tyres ..... 170
- Winter tyres ..... 170**
- Speed limit ..... 170

**Wiper blades**

- Cleaning ..... 151
  - Replacing ..... 151
- Wrench symbol ..... 21**

**Other Characters**

- Škoda information system ..... 23**
- Multi-function display (MFD) ..... 23



Vehicle overview

Before driving

When driving

Maintenance, cleaning, servicing

Do-it-yourself

Škoda Auto pursues a policy of constant product and model development. We trust that you will understand that changes to models in terms of shape, equipment and engineering, may be introduced at any time. The information about scope of delivery, appearance, performances, dimensions, weight, fuel consumption, standards and functions of the vehicle is only correct at the time of publication. Certain items of equipment listed may not become available until a later date (contact your Škoda Partner for details), or may only be available on particular markets. It is therefore not possible for legal claims to be made based on the data, illustrations and descriptions contained in this Owner's Manual.

Reprinting, reproduction or translation, either in whole or in part, is not permitted without the written consent of Škoda Auto.

Škoda Auto expressly reserves all rights relating to copyright laws. Subject to change.

Produced in the Czech Republic.

© 2011 Škoda Auto



**For the sake of the environment**

This paper was bleached without the use of chlorine.