

TATA MOTORS



Owner's Manual
& Service Book

Safari
STORME THE REAL SUV

VEHICLE IDENTIFICATION AND RECORD

OWNER'S NAME _____

ADDRESS _____

SELLING DEALER CODE _____

DATE OF DELIVERY _____

DATE OF REGISTRATION _____

REGISTRATION NO. _____

CHASSIS NO. _____

ENGINE NO. _____

GEAR BOX NO. _____

REAR AXLE NO. _____

BATTERY MAKE _____

BATTERY SR. NO. _____

BATTERY CODE _____

DEALER'S SIGNATURE AND STAMP

Following items are provided with your TATA SAFARI STORME:

1. Owner's Manual & Service Book
2. First Aid Kit
3. Advance Warning Triangle
4. Jack & Handle
5. Spare Headlamps Bulbs – 2 Nos.
6. Spare Fuses (Provided in fuse box)
7. Tool Kit
8. Music System Manual (if fitted)

THE WARRANTY ON THIS VEHICLE IS VALID ONLY IF THE DETAILS ARE FILLED, SIGNED AND STAMPED BY THE SELLING DEALER.





TATA SAFARI STORME

OWNER'S MANUAL & SERVICE BOOK

This owner's manual is advised to be kept in the vehicle at all the times.

TATA MOTORS

Passenger Car Business Unit
● Mumbai ● Pune ●

- Should any question or query exist regarding any aspect of your vehicle, please contact the nearest **TATA MOTORS** dealer, who will be pleased to assist you.
- The recommended routine maintenance servicing along with any running repairs that may be required, should be entrusted to **TATA MOTORS** dealership or to **TATA Authorised Service Centres (TASCs)** or **TATA Authorised Service Points (TASPs)** to ensure that only latest methods and genuine **TATA MOTORS** replacement parts are used for the continued reliability, safety and performance of the vehicle.
- Some of the items / accessories / features shown / given in this book may not be fitted on your vehicle, but they are applicable for other variants of **TATA SAFARI STORME**.
- Copyright 2013 **TATA MOTORS**
- All rights reserved. The material in this manual may not be reproduced or copied, in whole or in part, in any form without written permission from **TATA MOTORS**.
- In the event of the vehicle being sold, please ensure that this manual is left in the vehicle for the reference of the new owner.

This owner's manual & service book includes information on the operation and maintenance of various equipment installed on the different variants of **TATA SAFARI STORME**. Please note that this manual applies to all the models and explains all equipment including options not installed on your vehicle.

Safari STORME



Dear Customer,

Thank you for choosing **TATA SAFARI STORME**.

For enhanced safety of occupants, the **TATA SAFARI STORME** has **SRS** (Air bag) and **ABS** (Anti lock Braking System), in addition to having disc brakes on all its four wheels.

Advanced electronics are employed in the **TATA SAFARI STORME** to control its various functions. **Music System** provides entertainment to the passengers.

Reverse Guide System helps in directing the vehicle safely. The interiors of this vehicle are luxury personified with the soft touch dashboard having matching trim colour. Powering this vehicle is **TATA MOTORS** proven **TATA 140 VariCOR Engine** that aids drivability, especially while tackling rough hard-hitting roads.

This book gives you all the information necessary for making your drive a wonderful experience.

We wish you a safe and wonderful driving experience.



Contents.....



INTRODUCTION

VALUE ADDED SERVICE 1

1	24X7 On Road Assistance	2
2	Extended Warranty	6
3	Anti-rust, Sound Deadening & Engine Waxing	8
4	Exterior & Interior Enrichment Program	10

ENVIRONMENT PROTECTION 13

WARRANTY-TERMS & CONDITIONS 15

GETTING STARTED 17

1	E-Key and Remote Keyless Entry	17
2	Door Locking / Unlocking	18
3	Steering Lock cum Ignition Switch	20
4	Seat & Seat Adjustments	21
5	Head Restraint	26
6	Seat Belt	27
7	Rear View Mirrors - Inner & Outer	31
8	Steering Wheel Position Adjustment	33
9	Transference Electric Shift Switch	33
9	Master Light Switch	34
10	Power Windows	36
11	Dashboard	38

DRIVING CONTROLS

1	Gear Shift Lever & Shifting Pattern	39
2	Parking Brake	39
3	Combi-Switch	40
4	Instrument Cluster- Gauges & Indicators	43
5	Hazard Warning Switch	53
6	Heating, Ventilation & Air Conditioning	54

INTERIORS

1	Sunvisors, Vanity Mirror & Grab Handles	60
2	Cup Holders	61
3	Utility Pockets on Door Trims	62
4	Glove Box	63
5	Power Socket	63
6	Cigarette Lighter	64
7	Interior Lights - Roof Lamps	65
8	Music System	66

EXTERIORS

1	Head lamp	68
2	Fog Lamp	68
3	Tail Lamp	68
4	Registration Number Plate Lamp	69
5	High Mounted Stop Lamp	69

6	Puddle Lamp / Door Lamp	69
7	Reflex Reflectors	70
8	Fuel Flap Opening / Closing by Switch	70
9	Manual Fuel Flap Opening	70
9	Bonnet Opening / Closing	71

SPECIAL FEATURES

1	Immobilizer	72
2	Air Bags (SRS)	74
3	Anti-lock Braking System (ABS)	78
4	Reverse Guide System	80

DRIVING

1	Safety Checks Before Driving	84
2	Driving Safety	85
3	Tips To Improve Fuel Economy	86
4	Proper Driving Practices	86
4	Running-In Instructions	86
5	Starting / Stopping & Parking	87
6	Preparing To Drive	87
7	Gear Shifting Speeds	88
7	Brakes & Braking	89
8	4 X 4 Operation	90
8	Driving In Adverse Condition	91

IN CASE OF EMERGENCY

1	Emergency Parking Of The Vehicle	95
2	Emergency Aids	96
3	Emergency Towing	97
4	Inertia Switch	98
4	Starting The Engine With Jump Leads	99
5	If You Have Flat Tyre	100
6	Jacking Points	101
7	Fuses & Relay Box	102
7	Bulb Specification	107
9	Head Lamp Bulb Replacement	108
8	Tail Lamp Bulb Replacement	110
9	Preliminary Trouble Shooting	111
MAINTENANCE & VEHICLE CARE		
1	Engine Compartment	119
2	Air Filter	120
3	Engine Oil Level	120
4	Engine Coolant Level	121
5	Brake Fluid Level	121
6	Power Steering Fluid Level	120
7	Windshield Washer Fluid Level	122
8	Fuel Filter	122

9	Water drain from fuel pre-filter cum sedimenter	122
10	Turbocharger	124
11	Intercooler	124
12	Catalytic Converter	124
13	Wheels & Tyres	125
14	Battery	127
15	Vehicle Care	129

TECHNICAL INFORMATION

1	General Precautions	132
2	Fuel	132
3	Lubricants & Coolant	133
4	Co-Branded Lubricants & Coolant	134
5	Technical Specification	135
6	Vehicle Dimensions	138
7	Chassis & Aggregate Numbering Locations	139

VEHICLE SERVICE

1	Service Instructions	140
2	Service Schedule	141
3	Vehicle Record	146
4	Record of Warranty Repairs Carried Out	147
5	Record of Service Performed	148
6	Service Coupons	

SAFETY AND VEHICLE DAMAGE WARNINGS

In this manual, you will see **CAUTION**, **NOTE** and **WARNING**.

CAUTION

This is a warning. May cause injury to people if the warning is ignored. You are informed what you must or must not do in order to avoid or reduce the risk to yourself and other people.

NOTE

This is a warning. May cause damage to the vehicle or its equipment if the warning is ignored. You are informed what you must or must not do in order to avoid or reduce the risk of damage to your vehicle and its equipment.

WARNING

Indicates a strong possibility of severe personal injury or death if the instructions are not followed.

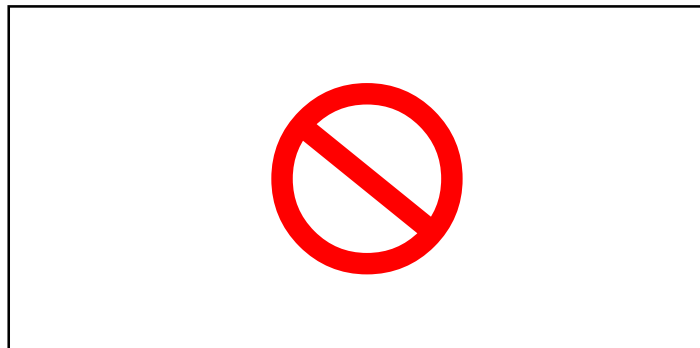
SAFETY SYMBOL

In this manual, you will also see a circle with a slash. This means "Do not", "Do not do this", or "Do not let this happen".

Dear Customer,

It is our never ending responsibility and endeavor to ensure that our customer's expectations are fulfilled comprehensively. To fulfill your vehicle service needs, we recommend the following :

- 1) 24X7 On Road Assistance*
- 2) Extended Warranty*
- 3) Anti Rust / Sound Deadening / Engine waxing treatment*
- 4) Vehicle detailing programming : Exterior Enrichment and Interior Enrichment Program*

These products shall help maintain optimum vehicle performance and shall enhance vehicle life.

We have tied up with best in the Class companies, who would bring you the above world class products at affordable prices. The above products are available with all our Dealers, TASCs and TASPs.

Our Dealer Service marketing executive shall explain to you the benefits of the above mentioned products.





Dear Customer,

It is our responsibility and our endeavour to ensure that you have our complete service backup if ever, wherever and whenever you need the same. When you have a road network that spans 33.80 kms, the probability of a breakdown happening within hailing distance of a **TATA MOTORS** Authorized Workshop is very low. It is Precisely for this reason, we have tied up with MyTVS, who will provide breakdown assistance including towing to the nearest **TATA MOTORS** Authorized Workshop through their Authorized Service Providers (ASP)

The **24X7 On Road Assistance** Program shall be automatically available to your vehicle for the duration of Warranty period. The program shall also be available for Extended Warranty period if you avail the same at the time of buying of your vehicle.

Response Time ** for the On Road Assistance Program

Within City Limits	60 minutes
On State or National Highways	90 minutes
Ghat Roads and other places	120 minutes +/-

** (The response time will depend on the location, terrain, traffic density and the time of the day.)

Standard procedure when calling for On Road Assistance in case of a breakdown:

- Dial the toll free help line number – **1 800 209 7979**
- Identify your vehicle with the Vehicle chassis number that is available in the Owners Service manual.
- Explain your exact location with landmarks and tell us about the problem you face with the vehicle.
- Park your vehicle on the edge of the road, open the bonnet and put on the hazard warning signal.
- Place the advance warning triangle supplied with the vehicle approx. 3 m from the vehicle in the direction of on coming traffic.

COVERAGE UNDER THE 24 X 7 ON ROAD ASSISTANCE PROGRAM

- I. The **24x7 On Road Assistance** Program Service covers the following services on your vehicle during warranty period.
- Wheel change through spare wheel.
 - Arrangement of fuel. (Fuel cost will be chargeable at actual cost)
 - Re-opening the vehicle in cases of key lock out.
 - Rectification of electrical problems related to battery, fuses etc.
 - On spot repairs for complaints repairable at site. ^
 - Vehicle to vehicle towing or winching & towing for non accident cases free during warranty period to the nearest **TATA MOTORS** authorized workshop. Towing charges at actual cost beyond the same to be paid to the ASP in cash. (Any ferry or toll charges levied in relation to the vehicle being towed to be paid by the customers in actuals in cash).

For accident cases, towing charges to be borne by the customer.

- II. The **24x7 On Road Assistance** Program as indicated above covers **TATA MOTORS** Assured vehicles during the extended warranty period up to a maximum of 3 events.

EXCLUSIONS

24x7 On Road Assistance Program does not apply to

- Cost of parts consumables and labour for such repairs not covered under warranty*. These charges are to be settled with ASP in cash.
- Toll or ferry charges paid by ASP in reaching to the breakdown site to be settled with ASP in actuals in cash.
- Cases involving accident, fire, theft, vandalism, riots, lightning, earthquake, windstorm, hail, tsunami, unusual weather conditions, other acts of God, flood, etc.
- Vehicles that are unattended, un-registered, impounded or abandoned.
- Breakdown/defects caused by misuse, abuse, negligence, alterations or modifications made to the vehicle.
- Lack of maintenance as per the maintenance schedule as detailed in the owner's manual.
- Cases involving racing, rallies, vehicle testing or practice for such events..

Disclaimer

- The service is not available in the states of J&K and in Union Territories of Andaman & Nicobar Islands and Lakshwadeep.
- **The reach time is indicative & the actual reach time will be conveyed by the call centre at the time of breakdown call.
- The reach time can vary depending on the traffic density & time of the day.
- The reach time indicated does not account for delays due to but not limited to acts of God, laws, rules & regulations for time being in force, orders of statutory or Govt. authorities, industrial disputes, inclement weather, heavy down pour, floods, storms, natural calamities, road blocks due to accidents, general strife and law & order conditions viz. fire, arson, riots, strikes, terrorist attacks, war etc.
- ^ On spot repairs at breakdown site shall depend on nature of complaints & will be as per the discretion of the ASP.
- *The decision for free of charge repairs will be as per the warranty policy & procedures of **TATA MOTORS LTD.** and as per the interpretation of the same by ASP. You will be duly informed by the ASP & call centre for the change applicable if any.

- All charges wherever applicable need to be settled directly with the ASP.

EXCLUSION OF LIABILITIES :

- It is understood that **TATA MOTORS** shall be under no liability whatsoever in respect of any loss or damage arising directly or indirectly out of any delay in or non delivery of, defect/deficiency in service/parts provided by ASP.
- In case vehicle cannot be repaired on-site, customers are advised to use the towing facility for taking their vehicle to the nearest **TATA MOTORS** authorized workshop only. In no condition will the vehicle be towed to any unauthorized workshop. **TATA MOTORS** will not be responsible for any repairs carried out in such unauthorized workshop.
- Customer are advised to take acknowledgment from the ASP for the list of accessories/extra fittings and other belongings in the vehicle as well as the current condition related to dents/scratches breakages of parts/fitments of the vehicle at the time of ASP taking possession of the vehicle & to verify these items when delivery is taken back by them, Claim for loss of or damage to items, if any should be taken up with ASP directly. **TATA MOTORS**

shall not be responsible for any such claims, damages/ loss or any deficiency of service of the ASP.

- Vehicles will be handled, repaired & towed as per the customer's risk & **TATA MOTORS** shall not be liable for any damages / claims as a result of the same.
- Services entitled to the customers can be refused or cancelled on account of abusive behaviour, fraudulent representation, malicious intent and refusal to pay the charges for any charges related services and spare parts during service or on previous occasion on part of the customer.
- On site repairs may be temporary in nature. The completion of repairs does not certify the road worthiness of the vehicle. The customer is advised to ensure temporary repairs carried out onsite is followed by permanent repairs at **TATA MOTORS** Authorized Workshop at the earliest.
- Terms and conditions and service coverage, exclusions etc. are subject to change without notice.

TATA MOTORS recommends the purchase of Extended Warranty.

Coverage : Mechanical + Electrical + Emission

Benefits :

- Insures you against unforeseen break down repair bills.
- Documentation is simple and hassle free.
- Near cashless & speedy claim settlement.
- Can avail benefits in any **TATA MOTORS** Dealer Network.

Term:

Original warranty: 3 years / 100000 kms whichever occurs earlier

Extended Warranty: Additional 1 year / 50000 kms on expiry of Original Warranty

EMISSION WARRANTY : Emission warranty is limited to the period of the **Extended Warranty**

Extended Warranty available in the dealership from where you have purchased your vehicle. We strongly recommend purchase of Extended Warranty at time of purchase of your vehicle. Surcharge shall be applicable on purchase of Extended Warranty after 90 days of purchase of vehicle.

Extended Warranty can be availed till 730 days from date of purchase of vehicle. The Dealer Service Marketing Executive shall explain to you the Terms and conditions, Coverage and Owner's responsibility.

Extended Warranty Booklet & Cover Note:

The Extended Warranty booklet is provided to you. The Customer to retain this booklet and the same to be produced to the dealer while claiming benefits under Extended Warranty.

NOTE :

- The extended warranty comes into force once the manufacturer's warranty expires.

What is covered ?

- Mechanical / Emission / Electrical break down as defined in this warranty and confirmed by the dealer within the stipulated terms and conditions.
- **TATA MOTORS** dealer shall either repair or replace any part found to be defective with a new part or an equivalent at no cost to the owner for parts or labour.
- Such defective parts which have been replaced will become property of **TATA MOTORS LTD.**
- Comprehensive list of parts covered is mentioned in the Extended Warranty Booklet.

What is not covered ?

Refer the Extended Warranty Booklet for the exclusion list.

Owner's Responsibility :

- Proper use, maintenance and care of the vehicle in accordance with the instructions contained in the Owner's Manual and Service Booklet. The records of the same to be ensured in Owner's Manual.
- Retention of maintenance service bills.
- Always produce extended warranty booklet while servicing & claiming the Extended Warranty benefits.

I / We have been explained the Terms and conditions, Coverage and Owner's responsibility by the Dealer Service Marketing Executive.

I wish to avail / Do not wish to avail extended warranty policy.

Customer's Sign

Dealer's Sign

Why are Corrosion Protection Waxes necessary?

Corrosion is caused by:

Water / salt water acid rain & atmospheric fallouts.

Critical areas are:

Cavities: joints, crevices, spot welds, underbody

- Corrosion is the most important factor when we talk about the vehicle life. If you treat your vehicle you can prolong the life.
- It is very dangerous to drive around in a corroded vehicle.
- The corrosion creeps onto the vehicle from the inside and from the outside. The most dangerous kind of corrosion is often not discovered until it is too late.

Benefits of Anti -Rust treatment :

- A professionally applied range of world class products offering real value to the new and used vehicle customer.
- The treatment has been developed to withstand the harshest environmental and climatic conditions (rst. Pollutants, stone and gravel impact, etc)
- Insulate cabin space from external noises.
- Expensive tin work and Denting / Painting avoided.
- Higher resale value for the vehicle.
- Higher safety – uncorroded vehicle
- Upto 60 months warranty & 10 free checkups available



Engine Wax Treatment :

Engine Wax is a beige coloured transparent lacquer coating on the engine compartment.

- Corrosion Prevention for the Engine compartment
- Neat, clean and New Look to Engine compartment
- No effect on MPFI vehicles
- Engine wax can withstand upto 200 degrees temp
- No need of cleaning the engine compartment with diesel once engine wax is sprayed
- Life of over a year

Sound Deadening System :

Door vibration deadeners - These pads when stuck on the insides of the sheet metal increase sheet metal rigidity, reduce vibrations and increase riding comfort.

- Used for reducing the sheet metal vibration in a vehicle.
- Product to be used once in the life of the vehicle - Life Time Warranty
- Effect is Life long i.e. until & unless pads are physically removed.
- Negligible increase in Weight & hence no effect on fuel consumption.
- Areas covered - four doors, rear quarter panels & dicky. In case of diesel vehicles, can be used in the bonnet.

TATA MOTORS has tied up with **M/s Wuerth** , **M/s STS Chemicals (Dinitrol)**, **M/s 3M India Ltd & M/s Opulent (Waxoyl Brand)** for these world class treatment at affordable prices. These treatments are available in all authorized workshops. The Dealer Service Marketing Executive will explain to you the benefits and terms and conditions of this treatment.

I / We have been explained the Benefits, Terms and conditions and the prices of these treatments by the Dealer Service Marketing Executive

I wish to avail / Do not wish to avail these treatment

Customer Signature

Dealer Signature

Vehicle Exterior Enrichment :

Why vehicles are painted?

- For Corrosion protection of the metal surfaces.
- Ease of application from other corrosion protection treatments.
- Cheaper than other corrosion protection methods eg.galvanizing, anodizing.
- For decoration and identification.



Various Environmental Hazards affecting paints :

- Environmental hazards: destroy your vehicle's finish.
- Even as your new vehicle rolls off the assembly line, the paint is not protected.



The enemy :

Ultraviolet Rays, Pollution, Tree Sap, Bird Droppings, Car Wash Chemicals, Road Salt, Acid Rain.

Benefits: Vehicle Exterior Enrichment

- Removal of medium scratches, orange peel, oxidation , dust nibs etc & swirl marks from painted surface.
- Restoration of original gloss levels UV protection after gloss is restored.
- Cleaning & dressing of tyres, Bumpers & all exterior plastic moldings/trims.

TATA MOTORS has tied up with **M/s Opulent (Waxoyl brand) M/s 3M & M/s Wuerth** for this world class treatment at affordable prices. This treatment is available in all authorized workshops. The Dealer Service Marketing Executive will explain to you the benefits and terms and conditions of this treatment.

Vehicle Interior Enrichment***Why protect your new vehicle's fabric interior ?***

- Someone will soil your vehicle's fabric carpet or seats.
- A significant detractor from your vehicle's resale value.
- A permanent stain on your vehicle's interior fabric.

The enemy :

Drink Spills - Food Stains - Mud - Ultraviolet Rays Pets - Traffic

Benefits: Vehicle Interior Enrichment

- Removal of medium stains and dirt from all interior parts of the vehicle, i.e carpet, upholstery and roof lining.
- Cleaning of windshield and all windows (inside and outside)
- Dressing of all internal plastics (eg: door pad trims)and rubber parts.
- The treatment involves cleaning and dressing of all parts of the exposed interiors.
- Specialised protection for seat fabric from liquid spills.

TATA MOTORS has tied up with **M/s Opulent (Waxoyl brand and M/s 3M** for this world class treatment at affordable prices. This treatment is available in all authorized workshops. The Dealer Service Marketing Executive will explain to you the benefits and terms and conditions of this treatment.

I / We have been explained the Terms and conditions,Coverage and Owner's responsibility by the Dealer Service Marketing Executive.

I wish to avail / Do not wish to avail extended warranty

Customer's Sign

Dealer's Sign

VALUE ADDED SERVICES

TATA MOTORS is committed to produce the vehicles using environmentally sustainable technology. A number of features have been incorporated in Tata Motors passenger vehicles which have been designed to ensure environmental compatibility throughout the life cycle of the vehicle. We would like to inform you that your vehicle meets emission norms and this is being regularly validated at the manufacturing stages.

As a user you too can protect the environment by operating your vehicle in a proactive manner. A lot depends on your driving style and the way you maintain your vehicle. We have given a few tips below for your guidance.

DRIVING

- Avoid frequent and violent accelerations.
- Do not carry any unnecessary weight on the vehicle as it overloads the engine.

- Avoid using devices requiring high power consumption during slow city traffic condition.
- Monitor the vehicle's fuel consumption regularly and if showing rising trend get the vehicle immediately attended at the Company's Authorised Service Outlets.
- Switch off the engine during long stops at traffic jams or signals. If you need to keep the engine running, avoid unnecessary revving it up or stopping and starting.
- It is not necessary to rev up the engine before turning it off as it unnecessarily burns the fuel.
- Shift to higher gears as soon as it is possible. Use each gear upto 2/3rd of it's maximum engine speed. A chart indicating gear shifting speeds is given in this book.

MAINTENANCE

- Ensure that recommended maintenance is carried out on the vehicle regularly at the Authorised Service Outlets.
- As soon as you see any leakages of oil or fuel in the vehicle we recommend to get it attended immediately.
- Use only recommended grades and quantity of lubricants and clean/uncontaminated and correct fuels.
- Get your vehicle checked for emission periodically by authorised dealer.
- Ensure that fuel filter, oil filter and breather are checked periodically and replaced, if required, as recommended by **TATA MOTORS**.
- Do not pour the used oils or coolants into the sewage drains, garden soil or open streams. Dispose the used filters and batteries in compliance with the current legislation.

ENVIRONMENTAL PROTECTION

- Do not allow unauthorised person to tamper with engine settings or to carry modifications on the vehicle.
- Never allow the vehicle to run out of fuel.
- Parts like brake liners, clutch disc should be vacuum cleaned. Do not use the compressed air for cleaning these parts which may spread the dust in the atmosphere.

While carrying out the servicing or repairs of your vehicle you should pay keen attention to some of the important engine aggregates and wiring harness which greatly affect emission. These components are :

1. Fuel injection equipments : pump, rail, Injectors, Nozzles and high pressure pipes.
2. Air Intake & Exhaust system especially for leakages.
3. Cylinder head for valve leakage.
4. All filters such as air, oil & fuel filters (check periodically).

5. Turbocharger & Vacuum Modulator OR it's vacuum hoses.
6. EGR System & components.
7. Electrical connections
8. 'Service' lamp continuously glows, please take the vehicle to Service Station.
9. Catalytic Convertor
10. EMS wiring harness i.e. electrical connections to all sensors and actuators.

This Owner's Manual & Service Book contains further information on driving precautions and maintenance care leading to environment protection. Please familiarise yourself with these aspects before driving.

We **WARRANT** each **TATA SAFARI Storme** vehicle & parts thereof manufactured by us to be free from defect in material and workmanship, subject to the following terms & conditions :

1. This warranty shall be for **36 months OR 1,00,000 kms**, whichever is earlier from the date of sale of the vehicle.
2. Our obligation under this warranty shall be limited to repairing or replacing, free of charge, such parts of the vehicle which, in our opinion, are defective, on the vehicle being brought to us or to our dealers within the warranty period. The parts so repaired or replaced shall also be warranted for quality and workmanship but such warranty shall be co-terminus with this original warranty.
3. Any part which is found to be defective and is replaced by us under the warranty shall be our property.
4. As for such parts as tyres, batteries, infotainment system, electrical equipment and fuel injection equipment, not manufactured by us but supplied by other parties, this warranty shall not apply. However buyers of the vehicle shall be entitled to, so far as permissible by law, all such rights as we may have against such parties under their warranties in respect of such parts. Our Dealers/TASC's will assist the purchaser in taking up the complaint with the respective manufacturers and their decision on the warranty will be final.
5. This warranty shall not apply if the vehicle or any part thereof is repaired or altered otherwise than in accordance with our standard repair procedure, or by any person other than our sales or service establishments, our authorised dealers or service centres or service points in any way so as, in our judgement which shall be final and binding, to effect its reliability, nor shall it apply if, in our opinion which shall be final and binding the vehicle is subjected to misuse, negligence, improper or inadequate maintenance or accident or loading in excess of such carrying capacity as certified by us, or such services as prescribed in our Owner's Manual and Service Book are not carried out by the buyer through our sales or service establishments, our authorised dealers or service centres or service points.
6. This warranty shall not cover normal wear and tear or any inherent normal deterioration of the vehicle or any of its parts arising from the actual use of the vehicle or any damage due to negligent or improper operation or storage of the vehicle. This warranty shall not apply to normal maintenance services viz. oils & fluid changes, head lamps focussing, fastener retightening, wheel balancing, tyre rotation, adjustment of valve clearance, fuel timing, ignition timing and consumables like bulbs, fuel filters and oil filters etc. This warranty shall not apply to any damage or deterioration caused by environmental pollution or bird droppings. This warranty shall not

WARRANTY - TERMS & CONDITIONS

- apply to V-belts, rubber parts, hoses and gas leaks in case of air conditioned vehicle. Slight irregularities not recognised as affecting the function or quality of the vehicle or parts such as slight noise or vibration and defects appearing only under particular or irregular operations or items considered characteristic of the vehicle.
7. This warranty shall be null and void if the vehicle is subjected to abnormal use such as rallying, racing or participation in any other competitive sports. This warranty shall not apply to any repairs or replacement as a result of accident or collision.
 8. This warranty is expressly in lieu of all warranties, whether by law or otherwise, expressed or implied, and all other obligations or liabilities on our part and we neither assume nor authorise any person to assume on our behalf, any other liability arising from the sale of the vehicle or any agreement in relation thereto.
 9. The buyer shall have no other rights except those set out above and have, particular, no right to repudiate the sale, or any agreement or to claim any reduction in the purchase price of the vehicle, or to demand any damages or compensation for losses, incidental or indirect, or inconvenience or consequential damages, loss of vehicle, or loss of time, otherwise, incurred or accrued.
 10. Any claim arising from this warranty shall be recognised only if it is notified in writing to us or to our concerned dealer without any delay soon after such defect as observed and ascertained under this warranty.
 11. This warranty shall stand terminated if the vehicle is transferred or otherwise alienated by the buyer without our prior written consent.
 12. We reserve our rights to make any change or modification in the design of the vehicle or its parts or to introduce any improvement therein or to incorporate in the vehicle any additional part or accessory at any time without incurring any obligation to incorporate the same in the vehicles previously sold.

TATA MOTORS

REMOTE KEYLESS ENTRY (RKE) :

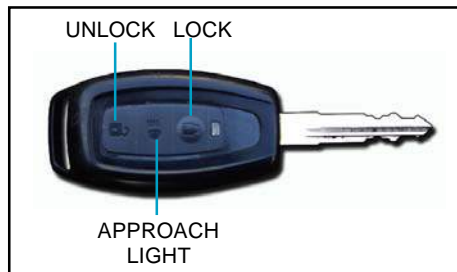

Your vehicle is equipped with a Remote Keyless Entry (RKE) function.

The three buttons on ignition key are:

- 1) Unlock (To unlock the vehicle)
- 2) Approach / vehicle search Light
- 3) Lock (To lock the vehicle)

NOTE

- Do not leave your key inside the vehicle while leaving / coming out of it.
- The LED on the transmitter will flash to show that the E-Key is working.
- The operating of the E-Key's transmitter will vary due to environmental conditions.

Unlock :

Press once to unlock driver door. To open all doors including tailgate, press twice.

Lock :

Press once to lock all doors including tailgate.

Approach light :

When you want to search your vehicle, press approach light button on the key. The dip / Low beam, parking lamp of your vehicle will be switched ON.

To switch 'OFF' these lights, press the approach button again or these will switch 'OFF' if the IGN is switched 'ON' immediately.

If the approach lights are not turned 'OFF', they will go 'OFF' after approximately 30 seconds.

NOTE

If any of the E-Keys are lost, contact an authorised **TATA** dealer as soon as possible to de-activate the lost key.

Please note that spare original E-Key is required when making an additional E-Key.
If both the E-Keys are lost, please contact an authorised **TATA** dealer.

Changing E-key battery :



E- key after opening up of back screw

Low Battery Voltage status can be observed by User:

- a) Considerable reduction in the range of Remote
- b) LED on the Remote start to blink at faster rate when a button is pressed.

DOORS LOCKING AND UNLOCKING:**Front Doors (Driver and Co-driver):**

Locking / unlocking doors with key from outside:

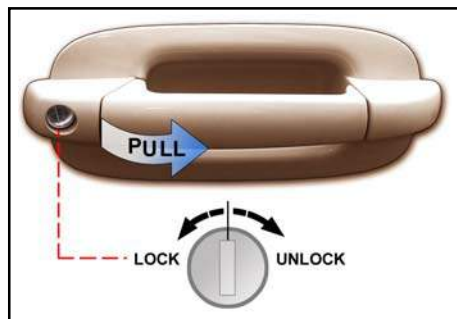

Both front doors (drivers and co-driver) have separate locking facility. Front doors can be locked or unlocked from outside using the E-key.

Insert the E-key and turn it anti-clockwise to unlock or clockwise to lock the door. Pull the door handle to open an unlocked door.

Locking / Unlocking without a key from inside:



1. Locking knob 2. Door opening lever

All the doors can also be locked or unlocked independently from inside by pressing or pulling the knob (1). **Press** to lock and **Pull** to unlock.

To open the door, pull the door opening lever (2) outward.

⚠ CAUTION

Do not leave the key inside the vehicle, when locking the doors this way.

Child lock:

Your vehicle has child safety locking facility for rear doors and tail gate. This prevents rear seat passengers from opening the doors from inside both during transit and while the vehicle is stationary.

Engage the child lock via sliding the lever downwards, which is on the edge of the door and is only accessible when the door is open.

When the child lock is engaged, the inner handle is deactivated. In this case, passenger are not able to open the door

from inside and are effectively 'locked in'. It can be opened only from the outside.

! CAUTION

Deactivate the child lock when not required.

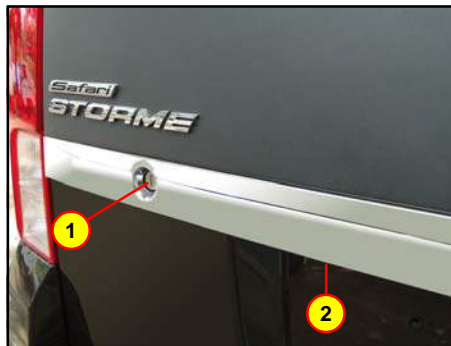
Tailgate locking / unlocking:

1. Location of tailgate lock
2. Location of door handle

The tailgate can be opened from outside once the vehicle is unlocked. To unlock the tailgate, press the "UNLOCK" button twice on the RKE (Remote Keyless Entry) key twice.

Once the vehicle is unlocked, pull the tailgate outer handle (2) below the chrome garnish on the tailgate. For locking the tail gate, press the "LOCK" button on the RKE key.

The tailgate assembly has a separate lock (1); this can be locked / unlocked manually by E-key.

NOTE

Arrow shaped emboss mark is given on chrome garnish to show the location of tailgate outer handle.

STEERING LOCK CUM IGNITION SWITCH :

Steering lock cum ignition switch is located on the right hand side of the steering column.

The key of ignition switch is common for door lock, steering lock and glove box lock. It has four positions. Turn the key clockwise to operate the below functions:

- LOCK** - Steering Locked
- ACC** - Accessories 'ON'
- ON** - All electricals 'ON'
- START** - Engine crank

Illuminated key ring

To assist you to locate your vehicle's ignition switch in the dark, the steering lock cum ignition switch comes with an illuminated key ring. When you open the driver's door, the illuminated key ring comes 'ON' for 60 seconds.

NOTE

- After inserting the key in the ignition switch, this ring remains 'ON' for 60 seconds.
- When the key is removed from ignition lock then all the doors will get unlocked.
- When engine is started and vehicle is reached to speed of 15 kmph then all the doors will lock automatically.

LOCK:

You can insert or remove the key only in this position. The steering column is locked when the key is removed.

WARNING

Do not remove the key while driving. It will lock the steering and can cause loss of control. Remove the key only when the vehicle is parked.

ACC (Accessories 'ON'):

When ignition key is turned to 'ACC' position, accessories like music system are switched 'ON'.

The engine can be turned 'OFF' without locking steering wheel by turning to 'ACC' position from 'ON' position.

ON:

In this position, all the electricals and accessories comes 'ON'.

START :

Turn the key further clockwise to the 'START' position (spring loaded) to start the engine. As soon as the engine starts, release the ignition key. While cranking, some of the accessories will be momentarily 'OFF'.

NOTE

- Do not crank the engine for more than 10 seconds continuously. If the engine does not start, wait for approximately 30 seconds before cranking it again.
- Release the key immediately after starting the engine or else, it may damage the starter motor / flywheel components, if the key is not released.

SEATS & SEAT ADJUSTMENTS :**Front seats:**

1. *Lumbar support (Only on front seats)*
2. *Seat back recliner lever*
3. *Seat height adjustment lever (Only on Driver's seat)*
4. *Lever for forward and backward movement*

Bucket type seats are provided with multiple adjustments.

WARNING

- Do not adjust the seat when driving. Any sudden or unexpected movement of the seat could cause

you to lose control of the vehicle resulting in an accident. Adjust the seat only when the vehicle is stationary.

- After adjusting the seat, always check that it is securely locked into its place by attempting to move the seat forward or backward without using the lock release lever.

1. Lumbar support (if fitted):



Lumbar support is provided on Driver and Co-driver's seats to give you comfort while driving. It is adjusted by the lever provided on the side of the seat backrest.

2. Seat back recliner:



To change the seat back angle, lean forward slightly and raise the smaller lever. Keeping lever in raised position, lean back to the position you want and release the lever. Make sure that lever returns to it's original position.

3. Seat height adjustment (Only for driver's seat):



Driver's seat height can be adjusted by a lever located on the seat base on the right hand side, just ahead of the seat back recliner lever. You can raise the seat height by pumping / pulling the lever upwards until appropriate seat height is reached and lower it by pumping / pushing the lever downwards.

4. Moving the seat forward and backward:



To adjust the seat position, lift the lever under the seat cushion front, slide the seat to the desired position and release the lever. Once the desired position is achieved, release the lever to lock the seat. Make sure the seat is locked firmly in position.

Front seat armrest (if fitted):

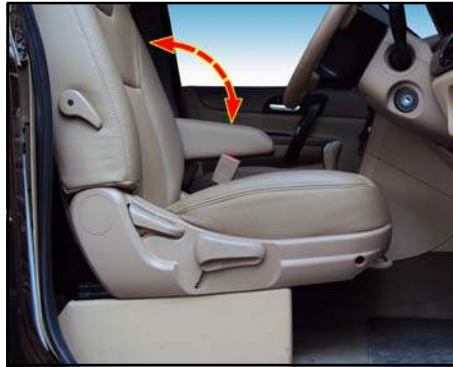

Front seats are provided with armrest. For folding the armrest, lift the armrest upward.

NOTE

If you feel inconvenience while driving, always keep the armrest in foldable position.

Second row seat :



Second row seat is split in 2 parts (60:40). Space for two occupants is provided at RH side and space for single occupant is provided at the LH side.

Foldable armrest cum cup holder (if provided) :



1. *Foldable armrest* 2. *Knob*

A foldable armrest cum cup holder is provided at the centre of middle passenger seat backrest.

To use as an armrest - Pull out the strap at the top end and rest it on the seat in horizontal position.

To open cup holder - Press the knob to open the arm rest lid and swing out the cup holders.



Cup holder

Place back the cup holder into the arm rest box and close the lid, when it is not in use.

NOTE

- Never use armrest as a support.
- Never allow children to sit on armrest.

Second row seat somersault :

The second row seats can be independently folded as and when required for carrying long objects. The seat base is provided with folding arrangement so that you can fold the rear seat forward.

To somersault the second row seat, following steps to be carried out :

To fold the rear seat, first delatch seat back by pulling lever (1) and rest on the seat base.



1. Lever for folding seat backrest

After rear seat backs are folded pull the lever (2) provided at the seat base sides and take the respective seat base up so that it is vertical.



2. Lever for folding seat from base.

To keep seat base horizontal, simply push back the seat base.

This folding feature gives additional space for keeping luggage.

Side facing third row seat :

The side facing seats are provided at the rear of the vehicle behind second row seat. These can be folded independently to get extra luggage space.



To fold the seat, lift the seat base upward and buckle the clamp to lock the seat. To release the seat, unbuckle the clamp and push the seat base / cushion downwards.



Luggage space after folding the rear jump seats



Luggage space after folding the second row seats and rear jump seats

HEAD RESTRAINT :

Head restraints in your vehicle are ergonomically designed for providing better neck support to the occupants. Whether for a long distance or short distance journey, head restraint provides comfort to the head and shoulder and acts as a safety device in the vehicle. The head restraint restrict the head movement during a rear impact collision, they reduce the chance of neck and shoulder injury.

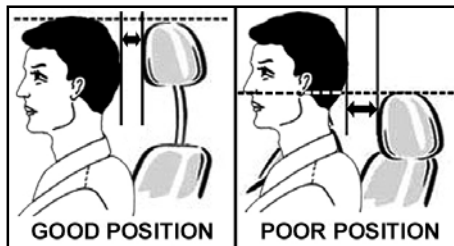

Every time you get in your vehicle, buckle up and make sure your head restraint is raised high enough to cushion the back of your head. For best protection, adjust the top of the head restraint as shown in the figure above.

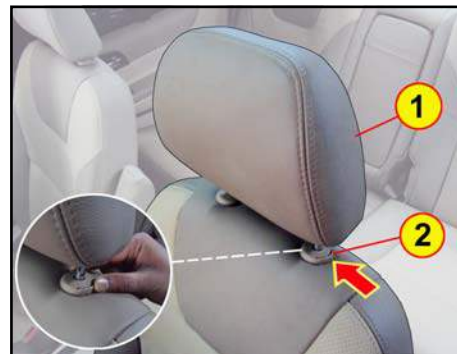

1. Head restraint 2. Notch button

To increase the height, lift up and leave at desired click position. To reduce the height press the notch button and push the head restraint downwards.

WARNING

Do not set it lower than your ears. If your head restraint is too low, you could get serious injuries in a rear end collision, even at slower speed.

Do not attempt to adjust the head restraint, while driving the vehicle.

SEAT BELTS :**Occupants safety is utmost important**

Your vehicle is equipped with seat belts, for front and rear seats as a part of occupant restraint system.

Wearing seat belts properly can protect you from being thrown against the insides of the vehicle or against other occupants in case of an accident or sudden braking. It will reduce the chances of severe injury.

This vehicle has three point inertia reel type front and rear seat belts in the out board positions and a lap belt for middle passenger on second row rear seat. In normal driving, the belt lets you move freely in your seat. In case of an accident or sudden braking, inertia reel automatically tightens the belt to help restrain your body.

The anchor end of the shoulder belt is adjustable to suit the height of the passenger wearing it. The lap belt has one manually adjusted belt that fits across the hip bone. Make sure that your

seat is adjusted to a good driving position and the back of the seat is upright.

Seat belt height adjustment :

The anchor end of the shoulder belt is adjustable to suit the height of the passenger wearing it. Make sure that your seat is adjusted to a good driving position and the back of the seat is upright.

For adjusting the seat belt height, press the button on the upper anchor of the belt and slide it upwards or downwards to suitable height.

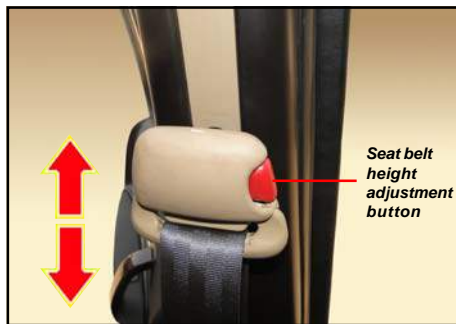

Seat belt height adjustment button

NOTE

- Adjust the shoulder belt height when you sit well back in the seat.
- When adjusting the shoulder belt height, grip the height adjuster button securely and slide the height adjuster up or down.

WARNING

- Verify the shoulder belt anchor is locked into position at the appropriate height. Never position the shoulder belt across your neck or face. Improperly positioned seat belts can cause serious injuries in an accident.
- Failure to replace seat belts after an accident could leave you with damaged seat belts that will not provide protection in the event of another collision leading to personal injury or death. Replace your seat belts after being in an accident as soon as possible.

Retractor pre - tensioner load limiter belts (RPLL) :

The main function of RPLL belt is to remove slack from the belt in the event of an accident to restrict forward movement of the occupant. The RPLL belts are triggered in situations where the front or side airbags deploy. **Do not disconnect RPLL belts electrical connection.**

NOTE

RPLL seat belts are fitted only on the vehicle which has air bags.

How to use shoulder / lapbelts :



1. Seat Belt
2. Tongue

3. Lock Buckle
4. Lap Belt

- Enter the vehicle and close the door. Sit back and adjust the front seat. Make sure that your seat is adjusted to a good driving position and the back of the seat is upright.
- The tongue is located above the back of your seat. Grasp the tongue and pull out the belt over the shoulder and across the chest. When the belt is long enough to fit, insert the tongue into the lock buckle until you hear a “CLICK” which indicates that the belt is securely locked.

- Position the lap belt across your thighs, below your abdomen. To remove slack in the lap belt portion, pull up a bit on the shoulder belt. To loosen the lap belt if it is too tight, tilt the tongue and pull on the lap belt. A snug belt reduces the risk of sliding under the belt in a collision.
- To release the belt, push the red button on the lock buckle. The belt will automatically retract to its stowed position. If necessary, slide the tongue down the webbing to allow the belt to retract fully.

Seat belt safety :

WARNING

- Wearing a seat belt incorrectly is dangerous. Seat belts are designed to bear upon the bony structure of the body and should be worn low across the front of the pelvis, or the pelvis, chest and shoulders, as applicable. Wearing the lap section of the belt across the abdominal area must be avoided.

- Each belt assembly must only be used by one occupant. It is dangerous to put a belt around a child being carried on the occupant's lap.
- A belt that is buckled into the wrong buckle will not protect you properly. Always buckle your belt into the buckle nearest you.
- A belt that is too loose will not protect you as well. In a sudden stop, you could move too far forward, increasing the possibility of injury.
- A belt that is worn under your arm is very dangerous. Your body could strike the inside surfaces of the vehicle in a collision. Wear the belt over your shoulder.
- Be sure the belt is straight. If you can't straighten a belt, take it to your nearest **TATA** authorized dealer.
- A frayed or torn belt could rip apart in a collision and leave you with no protection. Inspect the belt system

periodically, checking for cuts, frays, or loose parts. Do not disassemble or modify the system.

- If possible, use the seat belts to secure heavy luggage that are to be carried on the seats.
- Do not wear seat belts over hard, sharp or fragile items in clothing, such as pens, keys, spectacles etc.
- Care should be taken to avoid contamination of the webbing with polishes, oils and chemicals especially battery acid. Cleaning may safely be carried out using mild soap and water.

Seat belt warning indicator :



Seat belt warning indicator switches 'ON' for 3 seconds followed by blinking with buzzer for 6 seconds, when ignition is turned 'ON'.

Further if you have not worn seat belt and vehicle speed exceeds above 16 kmph, the lamp will continue to flash with intermittent audio alarm. After fastening the seat belt, the buzzer and warning indicator goes 'OFF'.

Use of seatbelts for expectant mother:



TATA MOTORS recommended the use of a seat belt. Expectant mother must wear a correctly positioned seat belt. It is safer for mother as well as unborn child. Doctor's advice is recommended.

Expectant mother should wear the lap part of the belt across the thighs and as snug across the hips as possible. Keep the belt low so that it does not come across the abdomen. That way the strong bones of the hips will take the force if there is a collision.

Child restraints:



For optimum safety, children should travel in the rear of the vehicle at all times. However, if it is essential that a child travels in front, set the front passenger seat fully backward.

Use only approved child restrained system which meets safety standards. Only fit a child seat that has been approved for use in your vehicle and ensure that the manufacture's fitting instructions are followed correctly.

WARNING

- Never install any rearward facing child seat or restraint in the front seat if the vehicle is fitted with Passenger Air Bag (PAB), as serious injury or death may result from the force of inflation of Passenger Air Bag (PAB).
- Child restraint systems are available at **TATA MOTORS** authorised dealerships. **TATA MOTORS** recommended the use of a type, which suits to the age of your child. Before installation always read its manufacturer's instructions.

Injured person :

TATA MOTORS recommends the use of a seat belt for injured person. Depending on the injury, consult your doctor for specific recommendations.

Care of seat belts :

Never disassemble or modify the seat belt systems. Take care to assure that seat hinges, doors or other abuse does not damage seat belts and belt hardware.

WARNING

In case of rear seats, when you return the seat back to its upright position after it was folded down, be careful not to damage the seat belt webbing or buckle. Be sure that the webbing or buckle does not get caught or pinched in the rear seat. A seat belt with damaged webbing or buckle will not be as strong and could possibly fail during a collision or sudden stop, resulting in serious injury.

Periodic Inspection :

Periodically inspect the seat belts for damage of any kind. Replace the damaged parts as early as possible.

Keep belts clean and dry :

Keep the seat belts clean and dry. If belts become dirty, clean them by using a mild soap solution and warm water.

CAUTION

Do not use bleach, dye, strong detergents or because they may damage and weaken the fabric.

When to replace seat belts :

Replace the entire in use seat belt assembly or assemblies if the vehicle has been involved in an accident. Do this even if no damage is visible.

REAR VIEW MIRRORS :**Inner rear view mirror (IRVM):**

1. Inner rear view mirror
2. Anti-glare knob (If fitted)

Inner rear view mirror is mounted inside the cabin near the front cabin lamp. It has two positions:

- a. Normal position
- b. Antiglare position (For normal IRVM only)

NOTE

Use Antiglare position only when necessary, as it reduces rear view clarity.

Inner rear view mirror with anti-glare feature & LCD display (if fitted):



1. Inner rear view mirror
2. LCD display (If provided)

The inner rear view mirror with LCD display is fitted only on the vehicle, which has the reverse guiding system. This IRVM has the integrated anti-glare feature.

Power fold & motorised outer rear view mirror (if fitted):



Your vehicle has motorised rear view mirrors on front doors. You can adjust the mirror to the desired position with the help of a switch provided on the driver door.

Motorised Rear View Mirrors allow the driver to adjust the mirrors without lowering the glasses and without moving from his position.

- Rotate the main switch to left for adjusting left side rear view mirror and to right to adjust the right side rear view mirror.



ORVM Adjusting Main Switch

- Now use the main switch knob like a joystick to adjust the selected rear view mirrors to required position.

Folding outer rear view mirror :

You can fold both ORVM using the main switch. This allows you to park your vehicle in the limited parking space. For folding the ORVM assembly, bring the main switch to centre position and slide the knob downwards this will fold / close the ORVM assembly inwards. Slide the knob downwards again to open / unfold the ORVM assembly.

STEERING WHEEL POSITION ADJUSTMENT:



1. Lock Position 2. Unlock Position

You can adjust the steering wheel position to suit your convenience.

Adjust the steering wheel position as follows before you start driving.

1. Adjust the seat to the comfortable position.
2. The lever to tilt the steering wheel is under steering column. Push the lever down to unlock the steering column.

3. Move the steering wheel up or down to the desired position. Position the wheel such a way that all the instrument panel gauges and warning lights are visible.
4. Pull the lever upward to lock the steering column once steering column position is fixed. Make sure that steering wheel is securely locked by moving up and down.

⚠ CAUTION

Steering wheel should be adjusted only when the vehicle is stationary.

TRANSFER CASE ELECTRIC SHIFT SWITCH (Only for 4X4 vehicle) :



Your vehicle has the transfer case selector switch on the floor console near the gear shift lever. This is electrically operated switch, it helps in shifting from 4X2 to 4X4 mode or vice-versa.

This switch has three selector positions :

- 2H** - Only two rear wheels are driven.
- 4H** - All four wheels are driven.
- 4L** - All four wheels are driven (vehicle runs at a speed reduction ratio to deliver higher torque)

NOTE

- Use 4L mode to negotiate sharp gradients or when driving through loose soil / sand.
- For more details, refer driving section of this book.

MASTER LIGHT SWITCH:



Location of master light switch

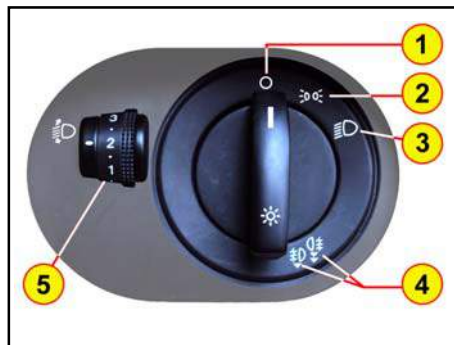

Master light switch

The Master Light Switch is located on the right of the steering wheel on the dashboard.

Knob functions :

- 1. OFF :** In this position, all functions are 'OFF'.
- 2. Parking :** In this position, only Parking lamps are switched 'ON'.
- 3. Headlamp :** In this position, Head lamps and Parking lamp are switched 'ON'.
- 4. Fog Lamp :** For switching 'ON' the Fog lamps, either the Head Lamp or Parking lamp must be 'ON'. Therefore turn the knob to position 2 or 3.

The knob can be pulled / pushed in two positions to turn 'ON' / turn 'OFF' the fog lamps. First pull will turn 'ON' the front fog lamps and second pull switches 'ON' the rear fog lamps. Similarly the first push will switch 'OFF' the rear fog lamps and next push will switch 'OFF' front fog lamps.

NOTE

Use fog lamps in foggy / misty conditions to improve visibility.

5. Headlamp leveling :

The master light switch also has head lamp leveling function. You can adjust the headlamp beam depending on load (passengers / goods) in your vehicle.

This can be operated by a scroll type switch located near the master light switch knob.

NOTE

Adjust the headlamp beam as per occupants, when vehicle is stationary.

Loading Condition	Switch Position
Unladen	0
One Person in the driver's seat	
One Person in the driver's seat + One in the front passenger seat	1
One Person in the driver's seat + One in the front passenger seat + Two people in the rear most seat	
All seats occupied (7 People)	2
All Seats occupied + Luggage area filled to permissible axle load	3
One Person in the driver's seat + Luggage area filled to permissible axle load	

POWER WINDOWS :

Main window winding switch location (on driver's door)

You can operate all the four window glasses using the switches on driver's door. They work only when the key is in the 'ACC' position. In addition, other doors have a separate switch for its glass on the door.

Glasses are wound up by pulling up the switch and lowered by pressing it down.

Your vehicle also has the 'EXPRESS DOWN' feature by which if you prefer to

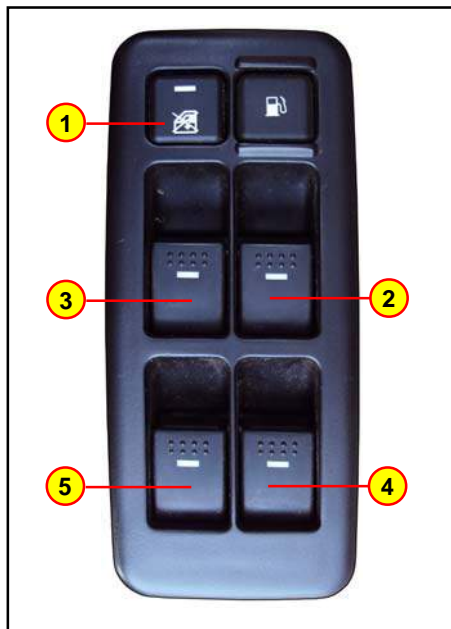

- | |
|--|
| 1. Rear power window lock / unlock button |
| 2. RH front window winding switch |
| 3. LH front window winding switch |
| 4. RH rear window winding switch |
| 5. LH rear window winding switch |



Window winding switch on rear doors

have the glass at its lower most position, press the switch down a little longer and the glass glides down automatically.

Lock / unlock switch :

You can deactivate the power window switches at the rear doors by using the lock / unlock switch on the driver's door. It has two positions :

1. Rear power window lock / unlock switch pressed
2. Rear power window lock / unlock switch released.

Lock / unlock switch pressed:

To activate the power window switch at rear doors, the driver has to press the lock / unlock switch once. The red indicator on the lock / unlock switch will turn 'ON'. In this condition, the driver and the rear passengers can independently control the opening and closing of rear windows.

Lock / unlock switch released:

To deactivate the power window switch at rear doors, again press the safety switch this will bring the safety switch in release condition and the red indicator on the lock / unlock switch will go 'OFF'. In this condition, only driver can control the opening and closing of rear windows.

WARNING

- Deactivate the rear door power window switches when carrying children on the rear seat.
- Take care not to trap your fingers / hands between the glass and the frame, while raising the glass.

DASHBOARD

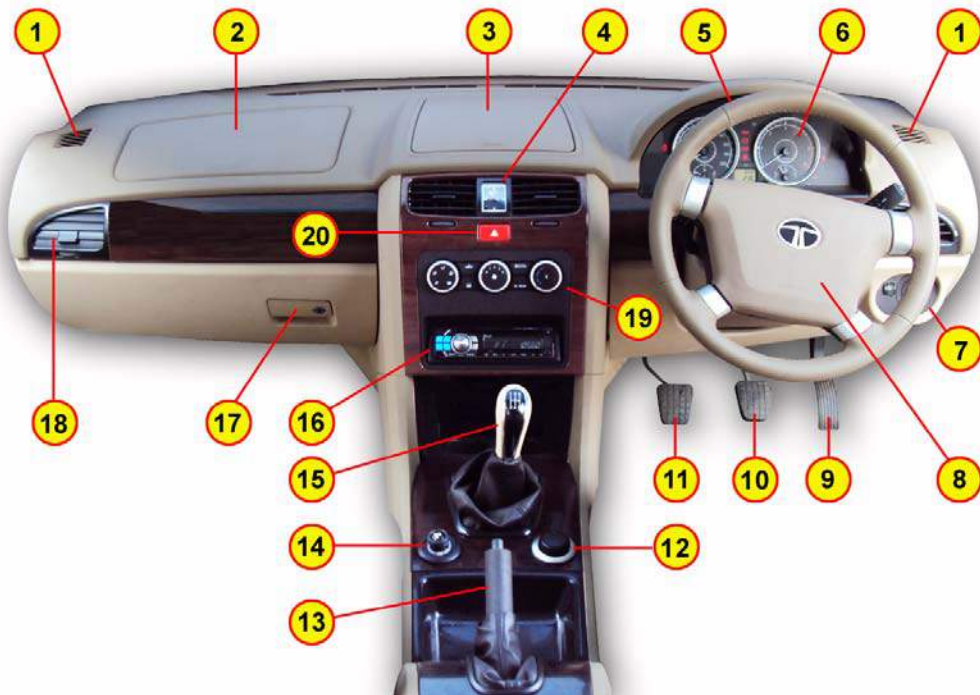

01.	A.C. Vents
02.	Passenger Air Bag (PAB)- if fitted
03.	Top Utility Bin (if provided)
04.	Analog Clock
05.	Steering Wheel
06.	Instrument Cluster
07.	Head Light Switches
08.	Horn Pad
09.	Accelerator Pedal
10.	Brake Pedal
11.	Clutch Pedal
12.	4X4 Selector Switch
13.	Parking Brake
14.	Cigar Lighter / Plug Socket
15.	Gear Shift Lever
16.	Music System (if provided)
17.	Glow Box
18.	A.C. Vents
19.	AC / HVAC Controls
20.	Hazard Warning Switch

GEARSHIFT LEVER & SHIFTING PATTERN:

The gearshift lever is mounted on the central console between front seats. The gear shift pattern is shown on the gear lever knob.

⚠ CAUTION

The reverse gear should be engaged only when the vehicle is stationary. Wait for 5 seconds after declutching to ensure smooth engagement of the reverse gear.

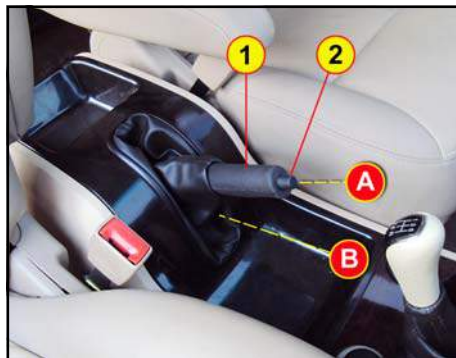
PARKING BRAKE:

1. Parking brake lever 2. Release button
A. Parking brake applied position
B. Parking brake released position

A mechanical parking brake acting only on the rear wheel is provided on your vehicle. The parking brake lever is located behind the gearshift lever. To apply the parking brake, pull the lever up fully. The indicator light (Ⓢ) (Ⓢ) on the instrument panel will come 'ON'.

To release it, pull the lever up slightly, press the release button and push the lever down. The parking brake indicator

(Ⓢ) (Ⓢ) on the instrument panel will go 'OFF' when the parking brake lever is fully released. When parking on level ground, place the gear lever in the 'Neutral' position. When parking on a downhill gradient, place the gear lever in 'Reverse' position. When parking on uphill gradient, place the gear lever in the '1st' position.

⚠ CAUTION

Apply the parking brake properly before leaving the vehicle & release it before moving. Use the parking brake for holding the vehicle on a gradient.

NOTE

After the vehicle has come to stop, first apply the parking brake and then additionally engage a gear.

COMBI-SWITCH : LH STALK :

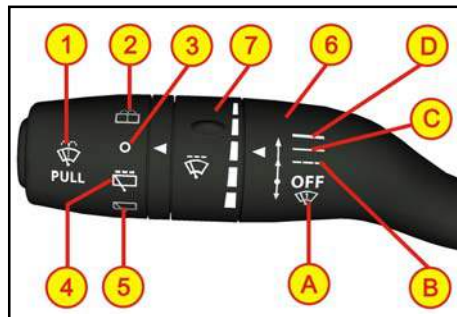

1. Front windshield wash & wipe
2. Rear windshield wash & wipe (if applicable)
3. OFF position
4. Rear intermittent wipe (if applicable)
5. Rear wiper continuous 'ON' (if applicable)
6. Front windshield wipe & wash
7. Intermittent wipe rotary switch

1. Front windshield wash and wipe :

To spray the washer fluid on the windshield.

1. When you pull the lever little longer, washer fluid will be sprayed on the windshield.
2. The windshield wipers operate for three cycles after the lever is released and one more cycle after five seconds.
3. When you crank the engine, the supply to washer motor is momentarily cut off.

! CAUTION

If you operate wash and wipe function for more than 30 seconds the controller cuts off the supply to washer motors to avoid overheating.

2. Rear windshield wash and wipe :

Turn and hold the rotary knob to operate rear windshield wash and wipe. It will return to 'OFF' position as soon as released.

3. OFF position

Wiper does not work in this position.

4. Rear intermittent wipe :

Turn the rotary knob and align position with arrow mark to operate rear intermittent wiper. Rear wiper will start wiping intermittently.

5. Rear wiper continuous 'ON' :

Turn the rotary knob and align position with arrow mark to operate rear continuous wiper. Rear wiper will start wiping continuously.

6. Front windshield wipe and wash :

A) Flick / Mist : To operate front windshield wiper in case of light-rain or mist, move the lever downward slightly and release the wiper stalk. It will return to 'OFF' position. The wiper will operate once.

B) Intermittent wipe : To operate intermittent wipe, lift the lever to position 'B'.

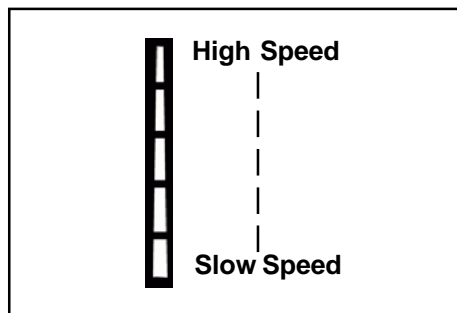

By rotating rotary switch, you can select desired wiper speed.

C) Slow wipe : To select 'SLOW' continuous wipe, lift the lever to position 'C'.

D) Fast wipe : To select 'FAST' continuous wipe, lift the lever to position 'D'.

NOTE

Turn the ignition switch to 'ON' position, to operate all wash and wipe functions.

All functions pauses temporarily, when the engine is being cranked and resumes it's function once cranking is complete.

CAUTION

- Do not operate the windshield wipers, when the windshield is dry or obstructed.
- Always check and top up the windshield washer fluid in the container.

Get the front and rear washer nozzles cleaned periodically.

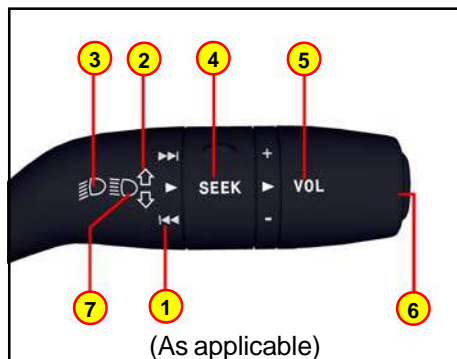
RH STALK :

1. Right turn signal
2. Left turn signal
3. Flash function
4. SEEK mode (if applicable)
5. VOLUME mode (if applicable)
6. Mode switch (if applicable)
7. High beam

1. Right turn signal :

Right indicator lamps and instrument cluster tell tale will come 'ON' if ignition is 'ON' and indicator stalk is moved downward. For changing lanes, lightly

flip the stalk downwards; indicator lamps will blink three times and then turn 'OFF'.

2. Left turn signal :

Left indicator lamps and instrument cluster tell tale will come 'ON' if ignition is 'ON' and indicator stalk is moved upward. For changing lanes, lightly flip the stalk upwards; indicator lamps will blink three times and then turn 'OFF'.

3. Flash function :

Pull the lever towards steering wheel to flash the hi-beam head lamps and it will remain 'ON' till lever is in pulled position. The lever will return to it's original position after releasing the lever.

4. SEEK mode (if applicable) :

'SEEK' mode is used to change the running band to next band in FM and songs in music system. Operate the 'SEEK' mode by rotating the 'SEEK' mode switch.

5. VOLUME mode (if applicable) :

You can increase or decrease the volume level, by rotating the VOLUME switch.

6. Mode Switch (if applicable) :

MODE is used to change the running mode of music system, by this you can shift from (FM) Turner to Disc or to USB or AUX.

7. Hi-Beam :

To switch over head lamps to hi-beam :

- Master light switch to head lamp position.
- Push the lever towards instrument cluster.
- Hi-beam headlamps and instrument cluster tell tale will come 'ON'.

To switch over from high beam to low beam, pull the lever back.

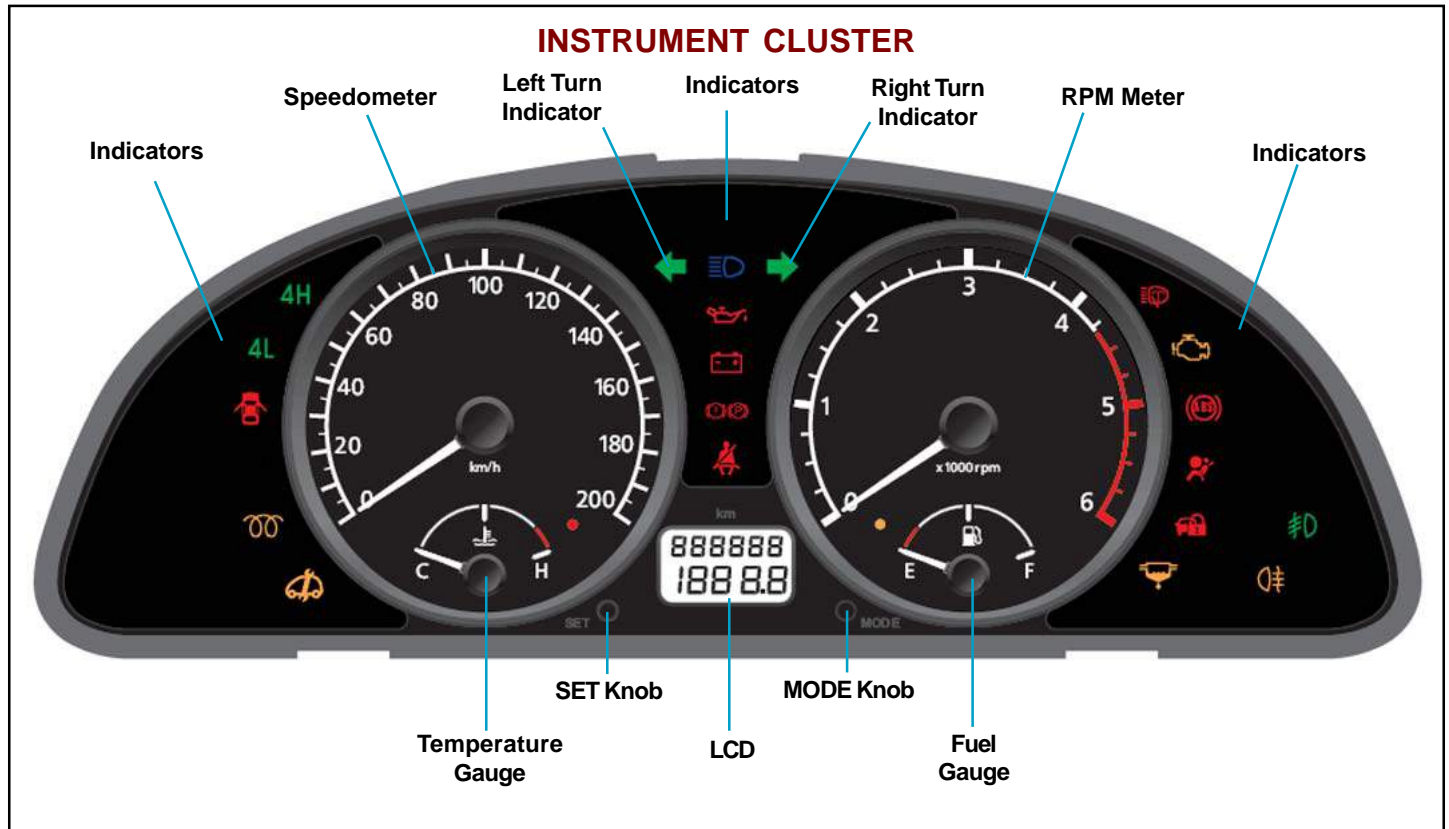











The Instrument Cluster has following features :

- **Analogue Gauge** : Speedometer, Tachometer / RPM meter, Fuel gauge and Temperature Gauge
- **LCD display** : Odometer, Trip meter (A & B), Dimming, Digital Clock, Ambient Temperature Display
- **Tell Tales**
- **MODE & SET Knobs**

SR. NO.	FEATURES	DESCRIPTION
1	Speedometer	Vehicle Speed (in km/h)
2	Tachometer / RPM Meter	Engine Speed (in rpm)
3	Fuel Gauge	Fuel Level (Empty to Full)
4	Temperature Gauge	Engine Temperature
5	Odometer	Total Distance Covered
6	Trip 'A' & 'B'	Distance travelled on each trip or between fuel fillings
7	Dimmer for cluster & LCD backlighting	4 Levels (25%,50%,75% & 100%)
8	Digital Clock	24 Hours Clock
9	Ambient Temperature	Temperature of surrounding

INSTRUMENT CLUSTER - Tell tales

TELL TALES	LEGEND	COLOUR
Turn Left		Green
Turn Right		Green
High Beam		Blue
Battery Charging		Red
Park Brake Applied and Brake Fluid Oil level low		Red
Glow plug indicator		Amber
Malfunction Indication Lamp		Amber
Low Engine Oil Pressure		Red
Water in Fuel		Amber
ABS		Amber

TELL TALES	LEGEND	COLOUR
Air Bag		Red
Seat Belt		Red
Immobilizer		Red
Front Fog		Green
Rear Fog		Amber
Door Open		Red
4H Indicator		Green
4L Indicator		Green

TELL TALES DESCRIPTION

Turn signal:



One of these symbol comes 'ON' when the turn indicators is switched 'ON'. Turn signal lamps can be operated only when the ignition supply is 'ON' and by using the turn indicator switch on the combi-switch. The direction indicator arrow (LHS) and (RHS) on the instrument cluster flashes along with external indicator lights as selected.

If one of the external indicator bulbs gets fused, it is indicated by high frequency flashing of the bulb of the same side.

High beam:



This symbol comes 'ON' when the headlamp high beam is switched 'ON'.

Battery charging:



This symbol lights up when the 'IGN' is turned 'ON' and should go 'OFF' after the engine starts.

NOTE

If it remains 'ON' while the engine is running, it indicates that the battery is not getting charged. Switch off all unnecessary electrical equipment and get the problem attended to at **TATA** Authorised Service outlet.

Park brake / brake fluid oil level indicator:



This indicator comes 'ON' for approximately 3 seconds when ignition is turned 'ON' and goes 'OFF'. If it remains 'ON', it may indicate :

1. Brake fluid level is low.
2. Parking brake is applied. It will go 'OFF' when it is released.
3. Fault in ABS/EBD system

Diesel pre-heat indicator / Glow plug indicator:



This symbol comes 'ON' when the ignition key is in the 'ON' position.

NOTE

Engine should be started only after this indicator goes 'OFF'.

Low engine oil pressure indicator:



When the ignition is turned 'ON', this symbol lights up and goes 'OFF' as soon as the required engine oil pressure is developed after starting the engine.

WARNING

If the low oil pressure indicator does not glow or remains 'ON' with the 'IGN' 'ON' and engine is running, it indicates a fault in the electrical circuit / lubrication system. Take your vehicle to a **TATA** Authorised Service centre.

Water in fuel indicator:



This symbol indicates excess water accumulation in the fuel pre-filter cum sedimenter. It will come 'ON' when ignition is turned 'ON' and will go 'OFF' in approx. 3 seconds. When this lamp remains 'ON' and a buzzer is sounded, water needs to be drained from fuel pre-filter cum sedimenter immediately.

CAUTION

If water is not drained from the sedimenter, it can cause serious damage to the fuel injection system.

ABS indicator:

When ignition is turned 'ON', this symbol comes 'ON' for few seconds and goes 'OFF'.

This symbol will continue to remain 'ON' or will come 'ON' after Ignition 'ON' precheck if there is a problem in the ABS system.

Airbag indicator:

The air bag warning symbol comes on for approximately 3 seconds when the ignition is turned 'ON' and goes 'OFF'.

WARNING

If it remain 'ON' or blinks, take your vehicle to the nearest **TATA** Authorised Service Centre.

Seat belt indicator:

Seat belt warning indicator comes 'ON' for 3 seconds followed by blinking with buzzer for 6 seconds, when ignition is turned 'ON'.

If seat belt is not fastened, the lamp will be 'ON' continuously without audio alarm till vehicle speed reaches 16 km/h.

When vehicle speed exceeds above 16 km/h, the lamp will continue to flash with intermittent audio alarm.

Once the seat belt is fastened, the buzzer and warning indicator will go 'OFF'.

Immobilizer warning indicator :

This symbol is of a system that disables engine starting if you do not use the original key. The user has to use original key for authentication and unlocking the vehicle. Refer to Immobilizer section for details.

Lamp Blink: Vehicle is in immobilized condition when key is not inserted.

Lamp OFF: Normal condition (Authenticated user) and engine will start.

Lamp ON: Problem with key/system. Take your vehicle to **TATA** Authorised service centre.

Front fog lamp :

This symbol comes ON when the Front Fog lamp is 'ON'.

Rear fog lamp :

This symbol comes 'ON' when the Rear Fog lamp is 'ON'.

Door open warning indicator :

If any of the door is open or not properly closed, this symbol turns 'ON' once the ignition key is inserted. Please ensure all the doors are properly closed before you start driving.

Service Indicator Lamp:



This symbol indicates the car's engine condition.

1. It comes "ON" when ignition is switched "ON" and once engine is cranked, it goes "OFF".
2. It remains "ON" if there is a problem in any of the EMS related/ engine components.

NOTICE

If the Service indicator lamp remains "ON" when the engine is running, the engine's performance deteriorates marginally & sometimes significantly. Take your car to a TATA Authorized service centre.

Malfunction Indication Lamp (MIL):



This symbol comes ON when the ignition is turned "ON" and goes "OFF" once the engine is cranked.

NOTICE

This symbol will remain "ON" for any engine related fault, which may cause increase in emission levels of the car beyond the regulatory limit. Take your car to a TATA Authorized service centre.

On Board Diagnostic (OBD) System:

On board Diagnostics or OBD is an automotive term referring to a vehicle's self Diagnostic and reporting capability. The OBD system allows continuous diagnosis of the components of the vehicle correlated with emissions. This system warns the driver, by turning "ON" the Malfunction Indication lamp (MIL) on the instrument cluster, when a fault causes emission levels to increase.

The OBD system also has a diagnostic connector that can be interfaced with appropriate diagnostic tools, which makes it possible to read the fault codes stored in the Electronic Control Unit, together with a series of specific parameters for Engine operation and Diagnosis. This check can also be carried out by the traffic police.

To access the diagnostic connector (**Fig. 1**), near the fuse box (**Fig. 2**) which is located on the cockpit at right side of the steering wheel as shown in the below images.

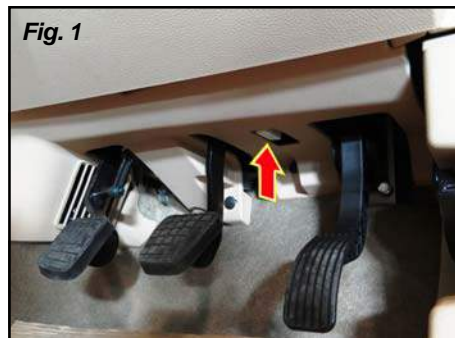

Fig. 1

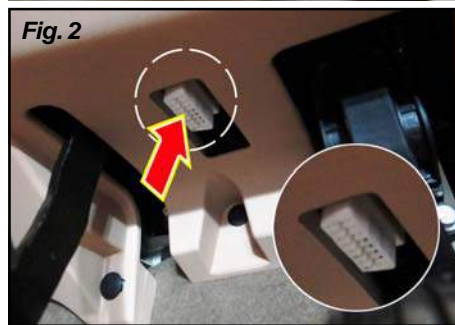

Fig. 2

NOTICE

In case the fault occurs and MIL comes ON, contact nearest **TATA MOTORS** authorized service center. After eliminating the inconvenience, to check the system completely, **TATA MOTORS** authorized service centers are obliged to run a bench test and if necessary, road tests which may also call for a long journey. The functioning of MIL lamp may also be checked by the traffic police using specific devices.

4H & 4L indicator :
(Only on 4WD vehicle)



With ignition 'ON' and transfer case switch in 2H mode both 4H and 4L indicator lamps on instrument cluster should glow for a few seconds only and go 'OFF'.

Continuous illumination indicates an electrical fault. Do not run the vehicle if both 4H and 4L lamps are ON.

The 4H and 4L lamps will glow only when the transfer case is either in 4H or 4L mode.

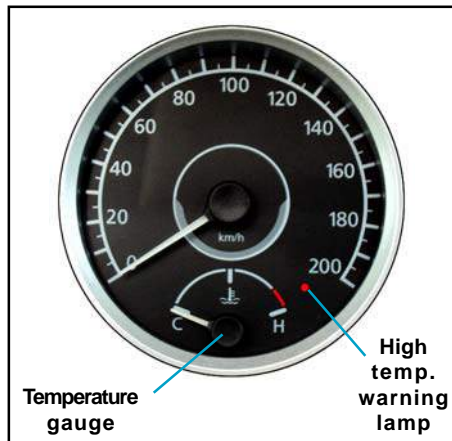
Speedometer :

The speedometer indicates the vehicle speed in km/hr. Driving your vehicle as per the recommended speeds will help you get optimum fuel economy and enhanced engine life.

Engine coolant temperature gauge:

The engine coolant temperature gauge indicates the approximate coolant temperature. If the coolant temperature

reading is very high or if the high coolant temperature indicator comes ON, reduce the vehicle's speed and switch OFF the AC. Take the vehicle to an authorised service station at the earliest.

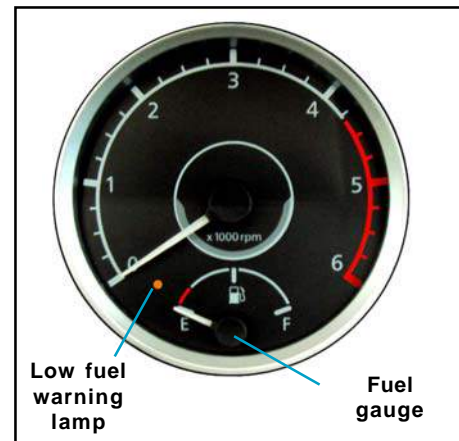
RPM meter / Tachometer :

This meter indicates the engine rpm. Change the gears at appropriate engine rpm and speed to get good fuel economy and driving pleasure.

Do not increase the engine rpm unnecessarily.

Fuel gauge :

The fuel gauge indicates the approximate fuel level in the tank.

Refill the fuel tank before the needle touches the coloured band on the gauge. At this point, fuel level in tank is low and it is advised to get fuel filled immediately.

Multifunctional LCD, Odometer, Dimmer and Trip meter (A and B), Digital clock, ambient temperature:

ODO & TRIP A DISPLAY

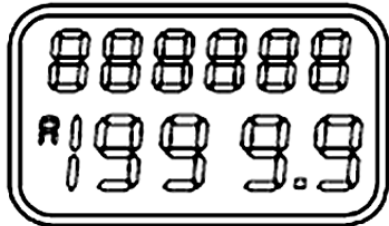

ODO & TRIP B DISPLAY

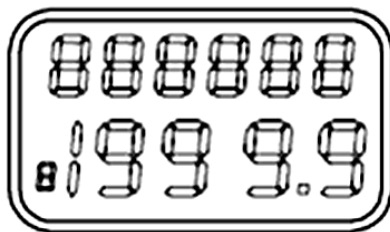

LCD has two line displays. The first line displays the Odometer count. The second line displays either of Trip meter A, Trip meter B, Dimmer and Intensity level of panel illumination, Ambient temperature and Digital clock display.

The selection and control of functions are done through 'MODE' and 'SET' push buttons (knobs) provided on either side of the LCD.

The 'MODE' knob is used to select one of Trip meter A, Trip meter B, Ambient temperature, Digital clock display and Intensity level of panel illumination.

Odometer and trip meter (on LCD):

The odometer record the total distance the vehicle has been driven. The trip meter can be used to measure the distance travelled on each trip or between fuel fillings. Keep track of the odometer reading and follow the maintenance schedule regularly for meeting service requirements.

Ambient temperature :

Ambient Temperature is measured and displayed in the units °C or °F, which you can select by pressing the **MODE** and **SET** switch.

You can select required function on LCD by using **MODE** and **SET** knobs available on cluster, as indicated in the table further.

Please note that each knob has to be pressed and released to change the function.

SR.NO.	DISPLAY	WITH MODE KNOB PRESSED	WITH SET KNOB PRESSED
1	Main odometer	Display changes to Trip A	-----
2	Trip A	To change the display to trip B	Knob to reset trip A
3	Trip B	To change the display to dimmer	Knob to reset trip B
4	Dimmer	To change the display to ambient temperature	Adjust illumination brightness 25%,50%,75%,100%,75%,50%,25%
5	Ambient temperature	To change the display to clock	Toggle between °C to °F conversion
6	Clock	To change the display to trip A	To set the clock (hrs. & secs.)

Trip odometer count can be reset by pressing 'SET' knob for over 10 secs when display indicates Trip 'A' or Trip 'B'.

LCD FEATURES:

A. Multifunction LCD

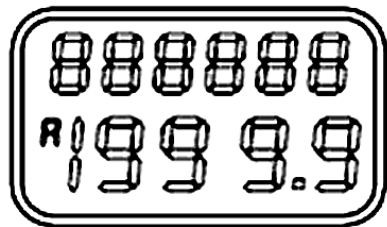

Colour: Black Text with background.

B. Trip meter (A and B)

Type: 7 Segments, indication by 4 digits and 1 decimal

Range: 0.0 to 1999.9

Resolution: 0.1 km or miles

Trip meter reading shall over flow to "0.0" after it crosses 1999.9 km.

TRIP - A (as applicable)

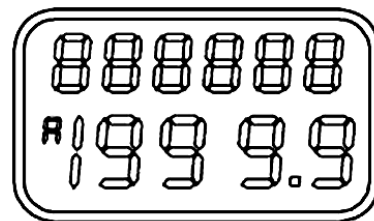

TRIP- B (as applicable)

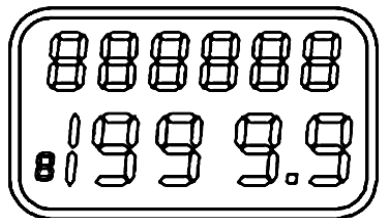
**Trip meter reset**

Trip meter (A and B) can be reset by pressing the "SET" knob slightly longer when particular Trip meter is selected.

C. Dimmer for cluster, LCD and Instrument panel illumination (as applicable)

You can adjust the LCD brightness that is best suited to you and it is shown by the number of Dashes on the display,

- A. 2 Dashes => 25 %
- B. 4 Dashes => 50 %
- C. 6 Dashes => 75 %
- D. 8 Dashes => 100 %

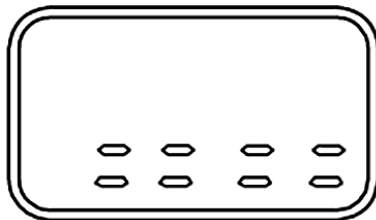

After selecting the dimming level, the display will show the next information (e.g. Main Odometer) after 20 secs. Press the "MODE" knob earlier to see the next information.

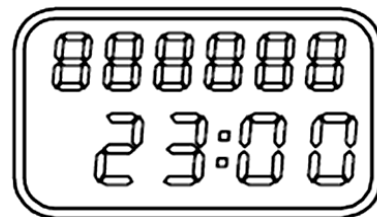
Digital clock :

Type: 7 segments, 4 digits

Range: 00:00 hrs.

Resolution: 24 hours clock

This feature has 24 hour display format, which can be user selected through "MODE" & "SET" knobs provided.

Procedure for digital clock setting:

1. The clock can be set using both the 'SET' and 'MODE' keys.
2. Pressing the 'SET' knob for 5 secs. will cause the displayed time to flash i.e. clock setting mode.
3. At entry into clock setting mode, Hours digit will flash first.

4. While the Hours data is flashing, pressing and releasing the SET key will toggle between minutes and hours.
5. While the numbers flashing, pressing the MODE the key will advance the displayed number.
6. While the numbers are flashing, if no keys are pressed for 5 secs. Then the current value displayed are stored and the display stops flashing.

Ambient temperature:

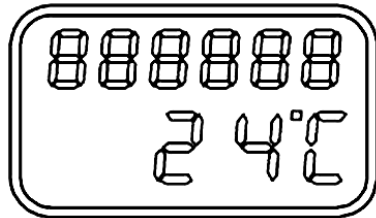

Type: 7 segments, 2 digits

Range: -10°C to +60 °C or +14 °F to +140 °F

Ambient Temperature can be seen with °C or °F unit, which can be selected by

user by using “MODE” and “SET” knobs.

E. Odometer (as applicable)

Type: 7 segments, 6 digits. Range: 0 to 999999

Resolution: 1 km

The Odometer reading will not overflow to “0.0” when the maximum value is accumulated, the display will freeze to maximum value.

HAZARD WARNING SWITCH :



When hazard warning switch is pressed, the right and left direction indicators along with tell tales on the

instrument cluster and hazard warning LED start flashing simultaneously. To switch off the function, press the Hazard warning switch again.

When pressed, the Hazard function overrides the turn indicator (right, left) function.

NOTE

Hazard warning function remains ‘ON’ even though key is taken out.

HEATING, VENTILATION & AIR CONDITIONING - AIR FLOW PATTERN & VENTS

Towards windscreen (Defrost)



A.C. air vents on central Console for front seat



A.C. air vents on floor Console for second row seat



Suction grill for Rear A.C. Unit



A.C. air vents on roof for Second and Third row seats

HEATING, VENTILATION & AIR CONDITIONING :

Your vehicle is fitted with heating and air conditioning system. HVAC system controls temperature, humidity and air flow to enhance comfort level inside the vehicle. It also helps to keep windscreen and window glasses clear for better visibility.

The engine must be running for the heater and air conditioning to generate hot and cold air.

The system is also equipped with front heating system for clearing the front windscreen, side glasses of fog or frost and to heat the cabin in cold weather.

The system has a separate rear cooling system along with adjustable vents on roof.

Vent controls:

The direction of air flow from the vents can be adjusted manually by revolving thumb wheels / knobs.

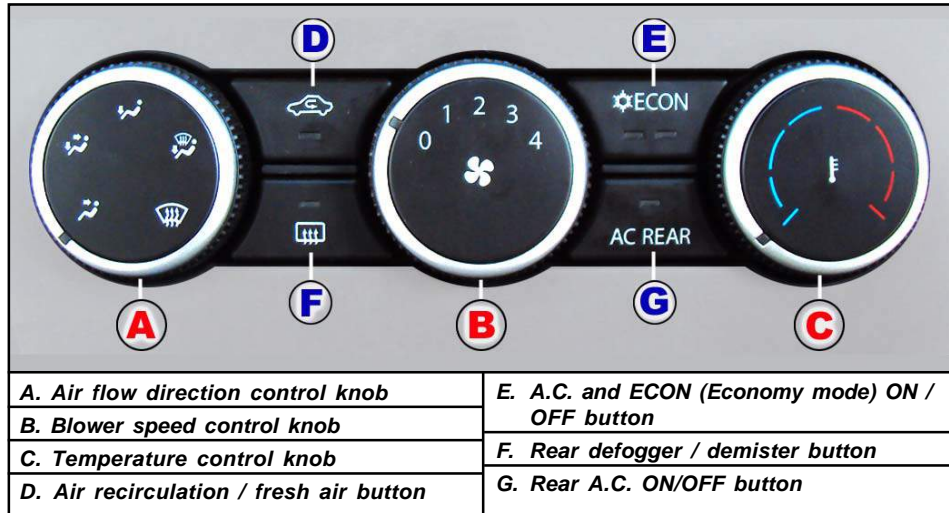

A. Air flow direction control knob:



The air flow can be changed by turning the air direction control knob (A) to the desired direction.

MODE	DESCRIPTION
	Towards face
	Towards face and feet
	Towards feet
	Towards feet and windshield (Recommended for clearing mist on windshield)
	Air demist/defrost windshield (Recommended for clearing heavy fog or snow.)

B. Blower speed control knob



The HVAC system has a four speed blower. The blower speeds can be regulated by operating the blower knob (B) at the centre of the control panel.

C. Temperature control knob

The temperature of the cabin can be controlled by operating the temperature control knob (C). The temperature can be increased by rotating the knob towards the red segment (clockwise) and decreased by rotating it towards the blue segment (anti-clockwise).

D. Air recirculation / fresh air button

When the recirculation indicator is 'ON', the air within the cabin recirculates.

When the indicator is 'OFF', air is being used in from outside of the vehicle (Fresh air mode).

NOTE

Continuous operation in Recirculation mode depletes the oxygen inside cabin and user may feel dizzy. Whenever discomfort is felt switch to fresh air circulation mode.

The outside air intakes for the heating and cooling system are at the base of

the windscreen. Keep this area clear of leaves and other debris.

The system should be used with recirculation air mode for faster heat up and cool down, however keeping the system in recirculation mode, particularly with A/C 'OFF', can cause the windows fog up.

Always switch to recirculation mode when driving through dusty or smoky conditions.

E. A.C. And Econ (Economy mode) ON/OFF button



First Press: A.C. 'ON'. (Blue indicator ON)

Second Press: ECON mode turns 'ON' (Green indicator ON)

Third Press: Both A.C. and ECON functions are switched 'OFF'.

Econ A.C.:

During ECON A.C. operation the system automatically cuts off at a higher temperature than normal A.C. The operation can be used during mild weather conditions for better fuel

efficiency. Comfort level may be compromised during this operation.

F. Rear defogger / demister button



Press the button (F) to turn ON the rear windshield and outside rear view mirror demister. This clears the fog / mist formation on the rear windshield and outside rear view mirror.

The indicator on the button turns ON when the rear demister is ON. The demister turns OFF automatically after 15 minutes.

NOTE

Keep the engine ON, while using rear windshield and ORVM demister.

Roof A.C. (IF FITTED) :

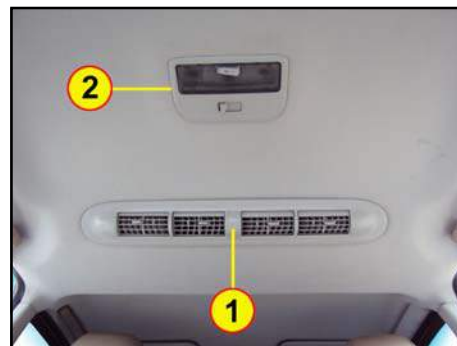

1. Rear A.C. air vents 2. Rear A.C. blower Speed control switch



Rear A.C. blower speed control switch

Roof AC is provided for second and third row seats passengers.

Roof AC blower control switch is provided on roof for second row passengers. It has four positions to control the blower speed.

The sliding movement of the knob is provided to select minimum to maximum air delivery.

The roof AC can only be switched on if the front AC is 'ON'. However the blower of the roof unit can be operated independently. Roof AC unit ON/OFF button is provided with the AC control panel. The indicator on the button turns 'ON' when the rear AC is 'ON'.



Rear A.C. ON / OFF switch

SUNVISORS :



Sunvisors

Two sunvisors are provided inside the cab above the windshield to prevent sun glare. Lower the sun visors to protect the eyes from bright sunlight. The sun visors can also be moved sideways towards the door.

NOTE

When not in use, keep the sunvisors in their original position or else, they may block driver's vision.

VANITY MIRROR (if applicable):



1. Sunvisor (Co-driver side) 2. Vanity mirror

The vanity mirror is provided in the co-driver side sunvisor. It has a cover flap for protection.

NOTE

When not in use, keep the vanity mirror cover in closed condition.

GRAB HANDLES :

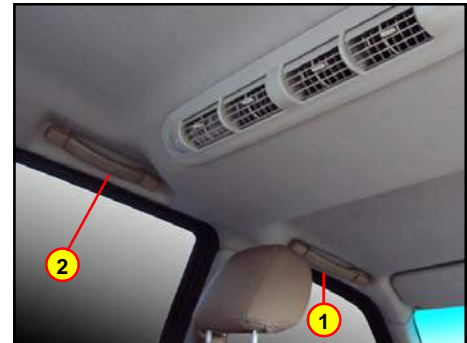

*1. Grab handle for front passenger
2. Grab handle for middle passenger*

For comfortable positioning of passengers during journey, grab handles are provided in the vehicle at various locations.

A coat hook is also provided along with the grab handle for second row passengers.

NOTE

Avoid hanging of heavy goods on to the coat hook.



Grab handle for third row seat

CUP HOLDERS :

For front seat occupants, two cup holders are provided on the dashboard and can be seen behind gear shift lever.

The other cup holders are provided in the second row seat armrest for rear seat passengers.

Pull out the strap at the top end and rest it on the seat in horizontal position. To open cup holder, press the knob to open the arm rest lid and swing out the cup holders.



*Cup holders for second row seat occupants
(Provided in the armrest)*



*Cup holders for front seat occupants
(Provided in the central console)*

UTILITY POCKETS ON DOOR TRIMS:

Utility pockets are provided on all door trims as well as tailgate door trim. This gives you extra space to keep magazines / papers / drinking water bottles etc.



Utility pocket on front door trim



Utility pocket on rear door trim



Utility pocket on tailgate door trim

Top Utility Bin (if fitted) :

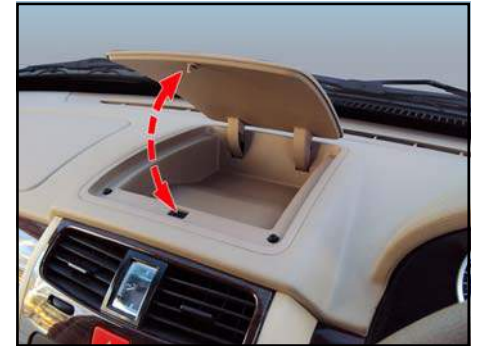

To keep small things such as coins, papers etc, a top utility bin is provided on the upper side of the dashboard centre . To open the bin, just press the upper lid once, then it comes out slowly. To close the bin lid, press it again to its original position. It gets locked automatically.

NOTE

After its use, keep it closed.

GLOVE BOX :

Glove box is located on the dashboard (In front of co-driver's seat). The glove box can be locked by the key, which is also common for ignition and door.

The lamp is provided in the glove box for illumination. This lamp will remain 'ON' till glove box cover is open.

POWER SOCKETS :

Two power sockets and a cigarette lighter are provided in the vehicle.

These all three sockets can be used to tap 12V supply (10A Max.) for operating external gadgets such as cigarette lighter, Car fridge, Vacuum cleaner etc.

1. Power socket on the floor console for middle passengers :

This power socket is located on the floor console below AC vents for middle passengers.

2. Power socket for rear passenger near jump seat (LHS) :

Third power socket is located behind LHS rear jump seat.

Push the cover gently and pull out the socket cover to open and access the power socket.

3. CIGARETTE LIGHTER (On the floor console for front passengers) :



A cigarette lighter is provided on the floor console near gear shifting lever for front row occupants.

Press the cigarette lighter fully in. When heated to specified temperature it pops out. Take the lighter out and light your cigarette. After use place the lighter in its position.

CAUTION

Do not insert any other part or accessory in cigarette lighter . It may get damage.

WARNING

Do not attempt to touch the hot coil. It may cause scalding.

INTERIOR LIGHTS - ROOF LAMPS :

The Interior roof lamps are mounted in the roof liner at the following three different locations :

1. Front roof lamp with spot / reading lamp :



Near Inner rear view mirror

The middle switch has three positions - **ON**, **OFF** and **DOOR**.

ON : In this position, the lamp remains continuously ON irrespective of whether the doors are opened or closed.

OFF : In this position, the lamp remains continuously OFF irrespective of whether the doors are opened or closed.

DOOR : In this position, the lamp comes ON when any of the doors are opened and dims out when the door/s are closed.

Spot lamp / reading lamp :

The front row interior lamp has two separate switches to operate the spot / reading lamps on either side.

These lamps are not provided in the second and third roof lamps.

NOTE

Function of roof lamp and its switches are same as front roof lamp.

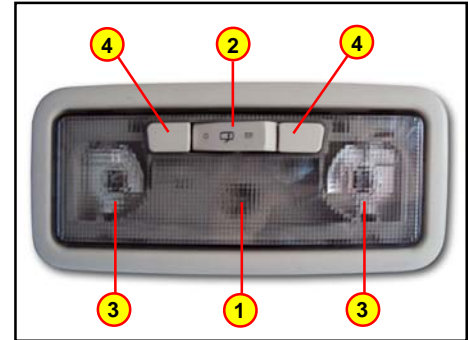

- 1. Roof lamp
- 2. Roof lamp switch
- 3. Spot / reading lamp
- 4. Spot / reading lamp switch





**Roof lamp for second row seat passengers
(Mounted above 2nd row seat)**



**Roof lamp for rear seat passengers
(Mounted above tailgate)**

MUSIC SYSTEM : (If provided)



A music system is provided in your vehicle in the centre finisher.

Tweeters are fitted in the inner cover of ORVM on both the front doors and speakers are provided on all the doors excluding tailgate.

A separate operator's manual of the music system is provided along with the Owner's Manual of this vehicle.



1. Speaker on front door trim 2. Tweeter in the inner cover of ORVM



Speaker located on rear door trim

USB / AUX ports :**1. USB port 2. AUX port**

The music system also has the USB and AUX ports.

1. USB Port : You can attach external memory device like memory sticks/ pen drives, I-pods for playing music tracks stored in this devices through the vehicle music system.

2. Aux Port : The AUX port is provided to connect Audio input devices for playing music tracks stored in the devices through vehicle speakers.

MIC (if fitted) :**MIC**

The MIC can be used, for communication once the occupant pair his mobile along with the music system. For pairing refer music system manual.

Antenna :**Antenna located on the roof**

The antenna is mounted on the roof above front windshield glass.

HEAD LAMPS :

1. High beam
2. Side indicator
3. Low beam
4. Parking

Your vehicle has clear lens type head lamps with multi focal reflector and halogen bulb. This gives better illumination on the road for long distances. Low / Dip beam illuminates the road immediately ahead for short distance visibility. It also contains side indicator lamp and parking lamp.

FOG LAMPS :

Front and rear fog lamps are provided for your convenience and they can be operated via master light switch located on the dashboard near steering column (RH side).

These are provided for additional illumination and to be used during rainy or foggy conditions.

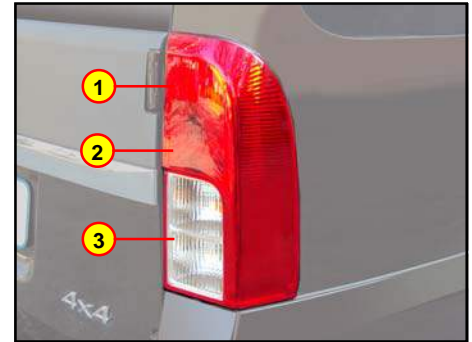
**TAIL LAMPS :**

1. Stop & rear position lamp
2. Turn Indicator
3. Reverse lamp

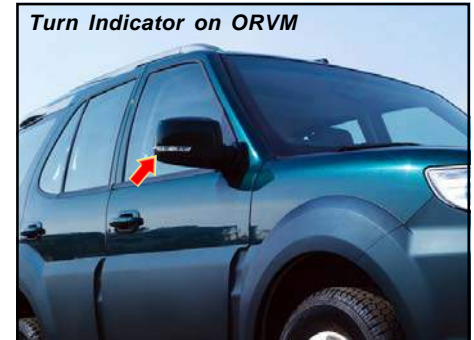

REGISTRATION NUMBER PLATE LAMPS :



- 1.Registration / Number plate lamps
2. High mounted stop lamp

Two concealed lamps are provided for illumination of the rear registration / number plate, which turns 'ON' along with the parking lamp.

HIGH MOUNTED STOP LAMP :

High mounted stop lamp is provided on the tailgate, and it glows whenever the brakes are applied.

PUDDLE / DOOR LAMPS :



Puddle lamp on front door trim bottom



Puddle lamp on rear door trim bottom

Puddle / door lamps are provided on all four door trim at the bottom. It has two parts, one is white at bottom and other is red on the side.

It illuminates as you open the door. The white light at the bottom helps you to visualize the ground clearly. This assist the user for easy entry and exit during night.

The red light on the side helps others to recognize that your door is open and it also warns the traffic coming from the rear that door is open.

REFLEX REFLECTORS :

Two reflex reflectors are provided at the both corners of the rear bumper. They glow by light of the vehicle coming from behind, which helps to recognize presence of your vehicle on the road.

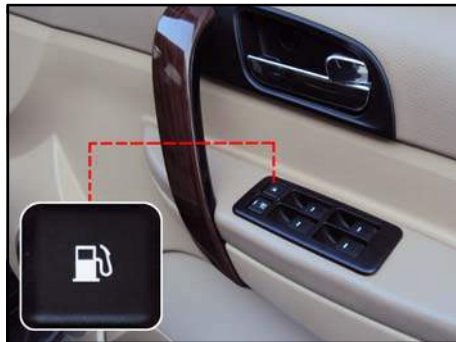
FUEL FLAP OPENING / CLOSING BY SWITCH :**Opening :**

- **“UNLOCK”** your vehicle, using the central locking system (by switching “OFF” the ignition or unlocking the driver’s door or using the Remote).
- Now by gently pushing, open the fuel flap (fitted at left hand side of the vehicle).

Closing :

- Push the fuel flap back to it’s position till it gets locked.

MANUAL FUEL FLAP OPENING :

You can open your vehicle’s fuel flap manually, if there is a problem in the fuel flap switch. For this just follow the below steps;

- Open the tailgate
- Open the trim cover fitted to the left hand side near third row seat.
- Once this cover is opened, you will find a cable with a knob.
- Slightly pull this knob to open the fuel flap.

NOTE

The emergency fuel flap opening cable should be used only in case of emergency / failure of electrical system.

WARNING

Fuel vapour is extremely hazardous. Always stop the engine before refueling. Never refill near sparks or open flames.

Do not use your cell phones when you are at filling station.

BONNET OPENING AND CLOSING :**Opening:**

1. Ensure that the vehicle is in neutral gear with the parking brake applied.
2. Pull the bonnet release lever located under the right hand corner of the dashboard. The bonnet will pop up slightly.
3. Raise the bonnet slightly and with your finger lift the secondary lock lever located under the bonnet centre.
4. Lift the bonnet up. Balancers will hold the bonnet.

Closing:

1. To close the bonnet, hold the bonnet and push down it slowly.
2. Drop it from a short height to shut. It will lock automatically. Ensure that the bonnet is locked properly.

⚠ CAUTION

Ensure that the bonnet is properly locked before driving. Do not press the bonnet onto the bonnet lock.



Location of bonnet release lever



Bonnet release lock

IMMOBILIZER (Theft Deterrent System) :

Immobilizer system is designed to prevent vehicle theft by electronically disabling the engine starting system. The engine can be started only with vehicle's original Immobilizer ignition key which has an electronic identification programmed code.

Immobilizer system consists of following components,

- 1) Immobilizer unit (ICU) – Add-on part on the ignition switch fitted on steering column.
- 2) Two electronic keys (E-key) - To start the vehicle.

CAUTION

- 1) E-key of other vehicles will not start the engine.
- 2) *Customer should,*
 - a. *Use only one E-key .*
 - b. *The other E-key should be kept at safe location.*

c. Note down “key Tag no.” information (and keep it safe) which is required while getting new / spare keys. Please note that It is not possible to prepare new/spare keys without “key Tag no.”

d. Take precaution about E-keys, as without it vehicle cannot be started.

E-Keys :

Unlocking principle :

The E-keys are learned for a specific immobilizer and are unique to the vehicle. The transponder inbuilt into the ignition E-key carries a unique identification code. The Engine management system (EMS) and Immobilizer has common secret code. Both these codes are used while unlocking the vehicle.

When key is inserted and the ignition is switched “ON”, all the codes are communicated within concerned

components (E-key, Immobilizer and EMS). The engine starts only if all codes match. In case of a mismatch of the codes, system prevents the engine from starting.

Loss of E- key :

If any of the E-key is lost, **contact TATA dealer as soon as possible** to have the lost key deactivated and to have the new E-key. Please note that Second original E-key is required for making additional E-keys.

If both the E-keys are lost, contact the authorized **TATA** dealer

NOTE

Do's and Don'ts of immobilizer system

1. Do not turn ON ignition switch by using electronic key with any type of metal wound around its grip or in contact with it. This may be detected as abnormal condition by immobilizer and prevent engine from starting.

2. Do not leave electronic key in areas of high temperature. The transponder in E-Key will behave abnormally when reused.
3. Do not try to start the vehicle when the Immobilizer indicator lamp on the instrument cluster is glowing. In this condition the vehicle will not start and the vehicle's battery will also be drained due to frequent cranking.

Immobilizer system brief :

The behavior of Immobilizer and vehicle under "Ignition OFF and ON" conditions, is explained in table below with immobilizer status lamp ("lock" symbol on the instrument cluster)

VEHICLE CONDITION	STATUS LAMP	VEHICLE STATE	MEANING/ FUNCTION OF THE STATE
Ignition 'OFF'	Blinking	Locked	Vehicle immobilized and waiting electronic key
Ignition 'ON'	OFF	Unlocked	Normal condition ready to start the vehicle
	ON	Locked	<ul style="list-style-type: none"> - Problem with key (Wrong E-key used to start vehicle) - Problem with Immobilizer system contact TATA dealer to inspect the system

AIRBAG (SRS) : (If fitted)

The vehicle has front airbags for both the driver and front passenger as a supplement to the seat belt restraint systems. The driver's airbag is mounted in the center of the steering wheel. The front passenger's airbag is located in front of front passenger seat inside the dashboard, above the glove box.

The vehicle fitted with the airbags has suitable indications on steering wheel and on dash board. The word 'AIR BAG' is embossed on the airbag covers.

Provided that the occupants are correctly seated with seat belts properly worn, front airbags will provide additional protection to the chest and facial area of the front seat occupants in the event of severe frontal collision.

WARNING

- The airbag is a supplementary restraint system that provides ADDITIONAL protection in a severe



collision only. It does NOT replace the need to wear a seat belt. Relying on the airbags alone could lead to severe injuries in a collision. The airbags work with your seat belt to restrain you properly. Always wear your seat belts even though you have airbags.

- To ensure correct deployment of the airbags, it is essential that

obstructions are not allowed to intervene between airbag and the occupant. Do not put anything on or around the front airbag covers or attempt to open them. Occupants may damage the airbags and they could be injured because the airbags are no longer functional. These protective covers for the airbag cushions are designed to open only when the airbags are inflating.

- Seating position plays an important role in minimizing the risk of accidental injury. In addition to properly worn seat belts, both driver and front passenger should adjust their seat to provide the maximum practical distance from the front airbags. Airbags need room to inflate. Being too close to the steering wheel or dashboard during airbag deployment could cause serious injury.

Airbag warning label:



Airbag warning information is printed on the co-driver's sun visors.

Airbag SRS warning indicator:



The air bag warning symbol comes on for approximately 3 seconds when the ignition is turned 'ON' and goes 'OFF'.

WARNING

If it remain 'ON' or blinks, take your vehicle to the nearest TATA Authorised Service Centre.

Airbag SRS system components:

The airbag 'SRS' system consists of the following:

- Airbag 'SRS' ECU (Electronic Control Unit)
- 'SRS' Indicator
- Driver Airbag
- Front Passenger Airbag
- Front Impact Sensors
- Driver and Front Passenger Seat Belt Pretensioners with load limiters
- Electrical Wiring Harness

Airbag 'SRS' working:

In the event of a collision, airbag SRS ECU monitors the rate of deceleration induced by the collision, through impact sensors, to determine whether the airbags should be deployed.

NOTE

The airbag 'SRS' is not designed to operate as a result of roll - over, rear collisions, minor frontal or side impacts nor will it operate as a result of heavy braking or driving over bumps and pot holes.

Airbag inflation is virtually instantaneous and occurs with considerable force, accompanied by loud noise. The inflated airbag, together with seat belts restraint system, limit the movement of an occupant, thereby reducing the risk of injury.

When an airbag inflates, you may see some smoke-like particles. The particles are a normal by-product of the process that generates the nontoxic gas used for airbag inflation. These airborne particles may irritate the skin, eyes, nose, or throat. If you have skin or eye irritation, rinse the area with cool water. For nose or throat irritation, move to fresh air. If the irritation continues, see

your doctor. Also sometimes the smoke can cause breathing problems for people with a history of asthma or other breathing trouble. In such cases get fresh air promptly.

After inflation airbags deflate immediately thus providing a gradual cushioning effect for the occupant. It is not advisable to drive your vehicle after the airbags have been deployed. If you are involved in another collision, the airbags will not be in place to protect you.

WARNING

After inflation, some airbag components are hot. DO NOT touch them.

WARNING

Airbag SRS fitted in your vehicle does not require any regular maintenance, however ALWAYS contact your TATA authorised dealer if:

- The warning indicator fails to illuminate for 3 seconds when ignition switch is turned ON.
- The warning indicator remains ON beyond 3 seconds after ignition switch is turned ON.
- The warning indicator illuminates after the engine is started or while the vehicle is running.
- An airbag inflates
- The front or side of the vehicle is damaged, even if airbag has not inflated.
- Any part of airbag module cover shows sign of cracking or damage.

WARNING

- **Do not fit any bull bars or other after market accessories at front side of the vehicle. This may affect the proper deployment of the airbag.**
- Never place any loose object on the dashboard in front of co-driver seat. It may result an injury from the object when it is forced towards you by the inflating airbag.
- Do not cover the steering wheel or dashboard with an object, which may prevent the proper deployment of the airbag.
- Never try to repair any component or part of the SRS yourself. Any interference in the system could cause malfunction and serious injury. All work on SRS should be performed by **TATA** authorised dealership.

ANTI-LOCK BRAKING SYSTEM (ABS) (if equipped):

In addition to the conventional hydraulic brake system, an Anti-lock Braking System (ABS) incorporating Electronic Brake Distribution (EBD) is provided on this vehicle (ABS version).

During normal braking the Electronic Brake Distribution (EBD) limits the level of braking force transmitted to the rear wheels. 'EBD' moderates the braking forces at the rear axle depending upon the load condition and available traction at the rear wheels.

During emergency braking the Anti-lock Braking System (ABS) regulates the braking force for each individual wheel. In doing so the system optimizes the level of braking being achieved while maintaining a stable, controllable vehicle. Where 'EBD' only acts on the rear wheels the ABS is able to control each wheel individually. Both the 'EBD' and the 'ABS' functions work by continuously monitoring and comparing

the four individual wheel speeds and reacts when a wheel is detected as losing traction with the road surface, which happens when a wheel tends to lock during braking.

To avoid the wheels from locking and prevent the vehicle from skidding ABS is provided. It prevents the wheels from locking and maintains the steerability of the vehicle thereby helping the driver to maintain stability of the vehicle while bringing it to a stop in the safest possible way.

NOTE

During cranking ABS, EBD warning lamps might glow for a few seconds. In order to obtain the maximum benefit from your 'ABS' system in an emergency situation, do not attempt to modulate the brake pressure by pumping the brake pedal. Press brake pedal continuously as hard as possible or as the situation demands. When ABS intervention is necessary

the warning lamp will not illuminate but the driver will feel the brake pedal pulsating and may hear an audible sound from the modulator indicating that ABS control is taking place.

ABS and EBD warning lights:



The ABS and EBD warning lamps will illuminate for a system check for approximately few seconds, when the ignition is switched 'ON'. Both lamps will then go 'OFF' to indicate the system is healthy. As the EBD lamp is shared with the park brake lamp & brake fluid level warning, so this will not go 'OFF' until the park brake is released and fluid level in reservoir is approximately at MAX. level.

CAUTION

In case of an 'ABS' or 'EBD' failure the warning lamp will illuminate in instrument cluster. In that case please pullover the vehicle to the side of road and switch off the ignition and restart.

If the fault persists, your brake system may not be working properly, hence it is dangerous to drive the vehicle. However if you feel and judge that it is safe to drive, then take the vehicle carefully to the nearest **TATA** authorised service station for repair. Otherwise get your vehicle towed as driving the vehicle with this fault could be dangerous.

WARNING

- 'ABS' is an aid to retain steering control and stability while braking.
- 'ABS' will not prevent accidents resulting from excessive cornering speeds, following another vehicle too closely or aquaplaning, i.e. where a layer of water prevents adequate contact between tire and road surface
- 'ABS' will not improve braking performance or stopping distance beyond that which is physically

possible which is constrained by the road conditions, vehicle's tyres and brakes.

- The additional control provided by, 'ABS' must never be exploited in a dangerous or reckless manner which could jeopardise the safety of driver, other road users or pedestrians.

REVERSE GUIDE SYSTEM (if fitted) :

Ultrasonic sensors based reverse guiding system is designed to aid safety while reversing the vehicle. The system alerts and shows you the distance from obstacles while reversing the vehicle at low speed. It includes four sensors and controller, buzzer and a display screen on IRVM. The system is also designed to give you both audio and visual signals, when the rear bumper of the vehicle comes closer to an object.

The system is automatically activated, when the reverse gear is engaged.

Operating instructions :

Switch 'ON' the ignition, IRVM blinks VFD display once with a beep sound for 2 sec. indicating the system is working in a good condition. On engaging the reverse gear, system will get activated automatically. When the obstacle comes in the sensing zone, then system gives an audio warning and IRVM display





shows the distance of obstacle in meter from the rear bumper of your vehicle.

NOTE

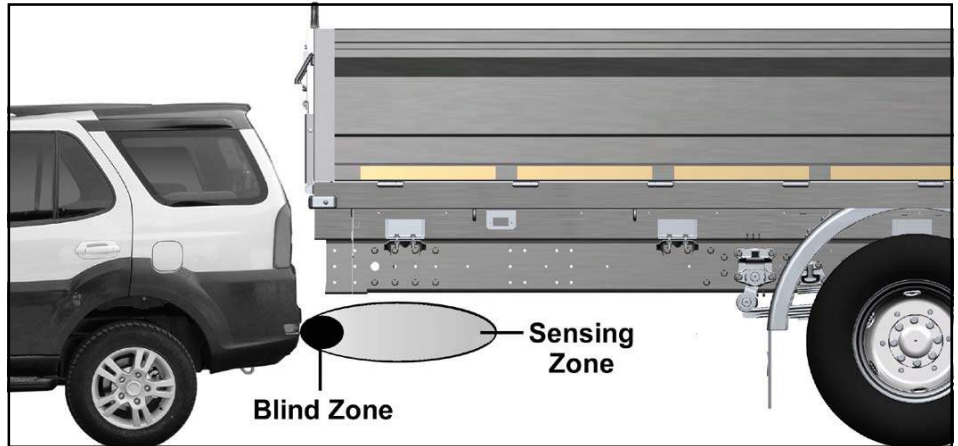
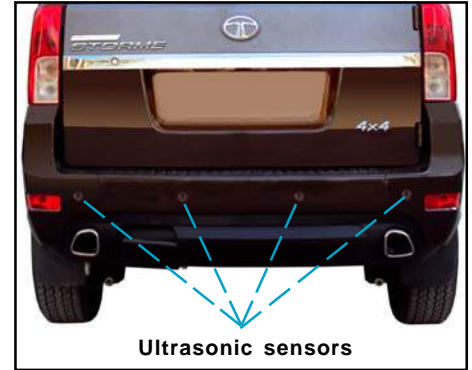
Please note objects less than one meter in height and 20 mm width / diameter may not be detected by the reverse guide system.

Obstacle cannot be detected, if it is too high.



ZONE	DISTANCE BETWEEN OBSTACLE AND REAR BUMPER	BAND	BUZZER BEEP FREQUENCY	DISPLAY CONTENTS
1	> 1.2 Meter	-	NO DETECTON	-----
2	1.2 Meter to 1.0 Meter	GREEN	LOW FREQUENCY	
3	0.9 Meter to 0.7 Meter	AMBER	HIGH FREQUENCY	
4	0.6 Meter to 0.5 Meter	RED	CONTINUOUS BEEP	
5	≤0.4 Meter	RED	CONTINUOUS BEEP WITH STOP MESSAGE	

 **CAUTION****1. System cannot sense**

- a) Wire mesh, handrail, small objects & some obstacle which are coming too much below or too much above the bumper level.
- b) Obstacles like cotton, wool, foam, textile or spongy surface which will absorb ultrasonic waves easily.
- c) Pot holes or the trenches or drainages which are below the ground level.

2. System may give wrong signal on reversing :

- a) When the vehicle on grasslands & bumpy roads.
- b) While vehicle moving from plain ground to slope like backing up downhill or vice versa.
- c) When the bumper is tilted more than the normal position or when the vehicle is heavily overloaded.

d) When the temperature of the obstacle is high as hot surfaces reflect fewer sound waves less than cold surfaces.

e) If there is an excessive increase in humidity as it increases the sound speed (max. by 2%) as compared to dry air.

f) When the vehicle is equipped with high power radio antenna on rear side.

g) If sensor is at extreme temperatures: below -30°Celsius or above 80°Celsius.

3. System may give false alarm during the heavy rain conditions, during the snow conditions or heavy wind conditions.**WARNING**

1. This system is strictly a driver assistance device. It is not a substitute of driver's responsibility while driving. Under no circumstances will the manufacturer accept any responsibility or can be held liable for any direct or indirect, incidental or consequential damage caused by negligent use of this system.
2. Clean the sensors properly and keep them free from ice, dust, mud, water, chewing gum etc. for proper working of the system.
3. Please practice reverse parking using different obstacles to grasp the system performance.
4. Pressing the sensor on active region may damage the sensors & may hamper its sensing range causing the system to malfunction.

5. Always STOP your vehicle when a continuous beep is heard. As it indicates an object at dangerous distance not more than 1.2 M from the rear bumper.
6. Never use high pressure water to clean the sensors and also never use hammer on it.

SAFETY CHECKS BEFORE DRIVING:**Check :**

1. Tyre pressure and condition of tyres.
2. Coolant level.
3. Engine oil level.
4. Brake fluid level.
5. Water in windshield washer reservoir.
6. Power steering oil level.
7. Battery electrolyte level.
8. Ensure sufficient Fuel.

Adjust:

1. Adjust your seat position.
2. Check adjustment of all rear view mirrors.
3. Check and adjust steering height.

Ensure:

1. Bonnet is properly closed and locked.
2. All doors are properly closed and locked.
3. Check that the items you may be carrying inside with you are stored properly or fastened securely.

4. Seat belts are fastened.
5. All mirrors, windows and outside lights are clean and unobstructed. Remove dust, frost, snow or ice if any, on these.
6. All switches and lamps are working
7. All the gauges and indicators in the instrument cluster are working.
8. Gear shift lever is in neutral position.
9. Parking brake is released.

Windshield/wiper/windshield washer:

Always keep windshield glass clean to avoid any distortion in visibility. Ensure proper working of wipers and condition of wiper blade. Ensure that windshield washer reservoir is full. Do not operate wiper alone when the windshield glass is dry, this may damage the windshield.

Headlights:

Keep headlight lenses clean. Check for operation of headlamps in both high/low beam condition. Check for correct focusing of headlamps. Use only

recommended type of bulbs. Do not use the high beam unless it is inevitable, as its dazzle may glare the driver of an oncoming vehicle, thus causing an accident.

Side indicators / Hazard warning:

Ensure that all side indicators/ hazard warning lights are in working condition and they are used when required.

Horn:

Ensure the horn is working properly. Horn provides safety to other road users by alerting your presence.

Brakes:

Ensure brakes are working properly. Do not drive the vehicle when brake warning lamp is 'ON'.

Tyres:

Check the condition of tyres for any abnormalities. Maintain correct tyre pressure. Do not use worn or bald tyres, especially on the front wheels.

First aid kit:

A first aid kit is provided in your vehicle. This is for use in case of minor injuries. It should be regularly checked and updated.

Documents:

Always carry vehicle registration papers, insurance, valid PUC certificate and driving license with you.

DRIVING SAFETY :**Seat belt:**

Seat-belts are life saving equipment. Use of seat-belt reduces the chance of injury and severity of injury in case of an accident. It is strongly recommended that all the vehicle occupants always wear seat-belts when vehicle is in motion.

Influence of alcohol / drugs:

Avoid driving under the influence of alcohol or drugs. Alcohol and drugs will severely affect your reflex actions. This will impair your control of the vehicle and

increase the risk of injury to yourself and others.

Mobile phones:

Avoid using mobile phones while driving a vehicle. This could divert your attention from the road and result in an accident.

Fatigue 'Rest revive survive':

Do not attempt driving when you feel tired, sleepy. Long distance driving can tire you very much and fatigue can dull your reflexes and judgment. Take rest and get refreshed at regular intervals.

Parking on slopes:

While parking, if your vehicle facing uphill, it is advisable to switch off the engine and engage lower forward gear.



While parking, if your vehicle facing down hill, it is advisable to switch off the engine and engage reverse gear.

TIPS TO IMPROVE FUEL ECONOMY:

Your vehicle's fuel economy is mainly dependent on your style of driving. To operate your vehicle as economically as possible, use the following driving suggestions.

Avoid excessive Idling :

Switch off the engine, if you have to stop for more than a minute.

Avoid fast starts and unnecessary stops :

Start off slowly from traffic lights or stop signs to prevent increased fuel consumption and shortening of engine life. Avoid unnecessary deceleration (stopping or slowing down) and then acceleration which uses more fuel.

Always maintain clean air-cleaner :

The amount of air supplied will reduce due to clogged air-cleaner, resulting in waste of fuel due to incomplete combustion.

Replace the air filter element as per the servicing instructions label on air filter body. We do not recommend to clean

the air filter element before the replacement period, however if filter element is to be cleaned (in case of vehicle operation in dusty condition) procedure indicated on servicing label to be followed. Get the air filter element replaced / cleaned at a TATA MOTORS Authorised Service Center.

Avoid incorrect tyre pressures :

Ensure proper tyre inflation. If your vehicle tyres are under-inflated, it results in increased rolling resistance of the tyres, leading to wastage of fuel. Check tyre pressure and inflate the tyres accordingly once a week.

PROPER DRIVING PRACTICES :

Keep a safe distance from other vehicles to avoid braking suddenly. Anticipate stops and avoid abrupt stops, this will decrease fuel consumption and increase the life of vehicle's brake and tyres.

Do not rest your foot on the clutch pedal. It does not allow full engine power to be transmitted to the vehicle and reduces clutch life.

RUNNING-IN INSTRUCTIONS :

During running-in period i.e. first 1500-1800 km. follow the running-in instructions given below :

1. After starting the engine do not rev it up. Warm up gradually at idling speed.
2. Avoid sudden acceleration and full throttle.
3. It is always preferred not to rev up a cold engine lest engine bearings get affected.
4. Recommended speeds during the running in period is given below :

Gear	Running-in speeds (Kmph)		Fuel Economy speeds (Kmph)	
	2H / 4H	4L	4X4	4X2
1st	20	8	-	-
2nd	40	16	30	30
3rd	65	-	40	40
4th	90	-	50	50
5th	110	-	60	60

STARTING THE ENGINE :

1. On a horizontal surface apply parking brake.
2. Ensure gear lever is in neutral.
3. Insert the key in steering cum ignition lock and turn it to 'ON' position.
4. Press the clutch pedal fully.
5. Now crank the engine.
6. If the engine does not start turn the key to off position and try after 30 seconds.

NOTE

After starting, run the engine in idle speed for at least 30 seconds. Do not press accelerator pedal while starting the engine to avoid damage to turbocharger.

STOPPING THE ENGINE :

Before switching OFF the engine, run the engine in idle condition for atleast 30 seconds and then switch OFF. This will allow the engine oil to lubricate the turbocharger, till its speed is fully reduced and also allow the unit to cool down.

The above precautions will ensure satisfactory life and performance from the turbocharger.

PREPARING TO DRIVE :

The following checks and adjustments should be done before you start driving the vehicle.

- Before you enter the vehicle, check and clear any obstructions that may not be visible from the driver's seat.
- Ensure all mirrors, windows and outside lights are clean and unobstructed. Remove dust, frost, snow or ice if any, on these.
- Ensure bonnet is fully closed.
- Check that any items you may be carrying inside with you are stored properly or fastened down securely.
- Check adjustment of seat. If required adjust to your convenience.
- Check adjustment of all rear view mirrors.
- Check adjustment of steering wheel.
- If the doors are not properly closed you will get a audio warning/indicator light as soon as you insert the

ignition key in the switch. Make sure all doors are properly closed and locked.

- If the seat belts of driver & co-driver are not fastened you will get an audio warning as soon as you turn the key to ignition position. Fasten your seat belt, ensure co-driver seat passenger has also fastened the seat belt (see Your Safety).
- Check and ensure that all the gauges and indicator lights in the instrument panel are working.
- Release the parking brake.
- Before moving the vehicle, check the oncoming traffic through the rear view mirrors. While getting into main stream of traffic, proper signal should be given by using side indicator.

PARKING :

- Park the vehicle in a safe place.
- Apply the parking brake.

- Ensure that all window glasses are closed and all lamps are turned OFF.
- At night, put 'ON' the parking lights if required.
- Remove the key from the ignition switch.
- Place wheel chocks at the wheels if parked your vehicle on a slope.

CAUTION

- Do not leave the key inside the vehicle.
- Do not leave children unsupervised inside the vehicle.
- When parking on a level ground, you may place the gear lever in "Neutral" position. When parking on a downhill gradient, place the gear lever in 'Reverse' position. When parking on uphill gradient, place the gear lever in the '1st' position.

GEAR SHIFTING SPEEDS :

Gear	Vehicle Speeds During Up shifts	
	2H / 4H	4L
1st - 2nd	20	10
2nd - 3rd	45	18
3rd - 4th	70	-
4th - 5th	90	-

Gear	Vehicle Speeds During down shifts	
	2H / 4H	4L
2nd - 1st	15	6
3rd - 2nd	25	-
4th - 3rd	45	-
5th - 4th	60	-

NOTE

While driving at higher gears, if the engine speed suddenly drops, the engine may stall and will be switched 'OFF'. This is done to safe guard the transmission system.

BRAKES AND BRAKING :

The brake system on your vehicle is an advanced dual circuit, vertical split vacuum assisted hydraulic brake system.

It is equipped with:

- Brake booster: This assists the driver in braking with an ergonomic pedal force on brake pedal.
- Tandem Master Cylinder, for fail safe braking.
- Twin pot calipers in front and single pot callipers in rear, for efficient energy absorption.

If one circuit fails then the pedal effort will be lesser, pedal travel will be longer and stopping distance will be more. At the same time, brake indication light would glow on dashboard.

If you observe any abnormality in brake system, contact your nearest **TATA** Authorized Service Centre. In case of failure of vacuum supply to the brake booster the vehicle can still be stopped with a higher pedal effort. In case of vacuum failure or brake circuit failure, slow down the vehicle by shifting to lower gear and lifting your foot from the accelerator pedal. Pull to the side of the road as soon as it is safe. Put your foot on brake pedal to apply brake. Do not ride with brakes applied as they may overheat and the performance may be impaired. The brake lights may confuse the other road users behind you. Use engine to assist the brakes by shifting to a lower gear and lifting your foot from accelerator pedal.

Constant application of brakes while going down the hill builds heat and reduces braking efficiency.

Check your brakes after driving through deep water. Apply the brakes moderately to feel that they are normal. If not, apply

them gently and frequently until they do. With wet brakes you should be extra cautious and alert while driving.

WARNING

Brake system failure is hazardous and needs immediate attention. In the event of brake system failure,

- a) Have your vehicle towed OR
- b) Be extremely cautious in case you have to drive the vehicle.

4 X 4 OPERATION : (If applicable)

On four wheel drive vehicles transfer case is fitted after the gear box for driving front live axle along with rear axle.

The electrical switch is provided on the floor console to select the mode.



The following three selector positions are provided on the knob :

2H - Only two rear wheels are driven and transfer case operates at 1:1 ratio.

4H - All four wheels are driven and transfer case operates at 1:1 ratio.

4L - All four wheels are driven and transfer case operates at 2.48:1 speed reduction ratio.

Four wheel drive operation :

In 2-H mode, engine powers the rear two wheels of the vehicle and front wheels are merely pushed. It will provide optimal smoothness and fuel economy at high speeds.

In four wheel drive mode (4H or 4L) the rear as well as the front axles get geared to the engine through transfer case and transmit the engine power to all four wheels. This provides increased traction to the vehicle.

In 4H mode, the transmitted engine torque and vehicle speed remain the same as in 2H.

However, when you shift to 4L mode engine torque is multiplied and vehicle moves at low speed in the same gears with increased traction. 4L mode is provided for negotiating sharp gradients or driving through loose soil / sand.

Mode Selection :**2H Mode :**

For driving in 2H mode shift the transfer case switch shifter knob to 2H switch position.

4H Mode :

For driving in 4H mode, shift the selector switch to 4H position.

The 4H indicator on the instrument cluster will blink for some second and will remain illuminated after successful shifting to 4H mode.

4L Mode :

For driving in 4L mode, shift the selector switch to 4L position.

The 4L indicator on the instrument cluster will blink for some second and will remain illuminated after successful shifting to 4H mode.

Shifting to various modes :

From 2H to 4H : Turn the selector knob from 2H to 4H position. 4H indicator on instrument panel will light up. Changing from 2H to 4H can be done up to 80kmph.

No pressing of clutch pedal is required.

From 4H to 2H : Turn the selector knob from 4H to 2H position. 4H indicator on instrument panel will go off. Changing from 4H to 2H can be done at 80 kmph. No pressing of clutch pedal is required.

From 4H to 4L

Stop the vehicle. Press clutch pedal. Turn the selector knob from 4H to 4L position. 4L indicator light on instrument panel will blink few times and remain on.

From 4L to 4H : Stop the vehicle. Press clutch pedal. Turn the selector knob from 4L to 4H position. 4H indicator light on instrument panel will blink few times and will remain on.

NOTICE

Do not engage four wheel drive mode (4H or 4L) continuously on dry and hard road surface. It can cause extensive damage to the vehicle transmission and the tyres.

Four wheel drive facility is a powerful tool which enables the vehicle to traverse terrain which is otherwise inaccessible to two wheel drive vehicles. However, it must be used judiciously and carefully. Do not take unnecessary risks and attempt the impossible. Familiarise yourself thoroughly with the vehicle and its abilities before attempting serious off road driving.

With ignition 'ON' 4H & 4L indicator lamp on panel should glow for a few seconds only & then go off. Continuous illumination of 4L & 4H lamps indicates electrical fault.

DRIVING IN ADVERSE CONDITION :**Driving Through Water :**

Never venture to drive through water when it flows over stone guard on a bridge.

Your vehicle's engine may get seriously damaged if attempted to drive through deep water.

If at all the situation demands that you have to drive through water then;

- Keep engine in fast idling and crawl the vehicle in low gear.

- After driving through water apply brakes several times to dry liners and to regain original braking.

Do not attempt to start the engine if vehicle gets flooded due to water. Tow the vehicle to a safe place.

Take the vehicle to nearest **TATA** authorised workshop to check entry of water in cylinders.

If water has entered the engine or gear box, transfercase etc., replace the lubricant.

Get the starter and alternator checked.

Driving on a rainy day :



Check brakes, steering and windows. Check tyres for wear and tyre pressure.

Check wiper blades for proper functioning.

Avoid harsh braking and sharp turns. It may cause loss of control and lead to a skid.

For slowing down, shift to lower gears and brake gently.

Keep head lights ON if visibility is poor.

Night driving :



Refer to some important instructions given below which are important from road safety point of view especially for night driving.

Given instructions are related to the use of head lights for night driving.

Because of decreased vision at night and the glare of oncoming headlights, night driving is more demanding and requires greater concentration than daytime driving. Unfamiliar roads and unexpected situations are more likely to cause hazardous driving conditions.

Ensure safe driving in several ways :

- Keep the windshield clean.
- Make sure the headlights are working properly and the lenses are kept clean.
- Check regularly for correct aim/alignment.
- Maintain a speed such that you can stop within illuminated distance of head lamps.
- Slow down when oncoming traffic approaches or when vehicle is close to a curve. Dip the head lamp for oncoming traffic during night driving.
- If visibility is greatly reduced, use the edge line as a guide to maintain the lane of travel. If there is no edge line, use the centerline to guide the vehicle.
- Use head lamp main/dip beam to alert other road users on turns/cross roads etc.
- Use side indicators for lane change or turning. Put 'ON' hazard warning

switch in case of hazardous parking or if your vehicle is disabled to warn the passing traffic.

1. Headlights

Switch 'ON' the headlights when driving between sunset and sunrise or any other time when there is not enough daylight to see a person wearing dark clothing at a distance of 100 meters. Do not drive with head lamp 'ON' during the day.

2. High Beam

High-beam headlights are stronger and have to be used in dark areas which require more lighting.

One can use high beam lights on any road, even if there are streetlights. **High beam headlights are only designed to be used when other vehicles are not around. Always dim the high beam headlights to low beam for oncoming vehicles as well overtaking vehicles.**

Dim the headlights to low beam when vehicles approach within 200

meters and while driving 200 meters or less behind other vehicles.

3. Fog Lights

Front fog lights are designed to illuminate the road in fog, snowfall, rainstorms, or dust clouds. They can be identified by the narrow pattern of light emitted, which shines low and wide to see the road close to vehicle in fog.

The rear fog lights help to alert the vehicles behind.

Drivers must not use front or rear fog lights unless driving in fog or other hazardous weather conditions causing reduced visibility. Switch 'OFF' the fog lights once visibility is clear as they can blind other drivers.

4. Extreme Conditions

In extreme conditions, such as heavy rain, fog etc. put the headlights to low beam. High beam in fog will reflect the light, making it difficult to see. In poor visibility, turn 'ON' the hazard lights to alert other vehicles on road.

Climbing sharp gradients on loose surfaces:



Start off smoothly in any suitable gear. Apply power smoothly so that there is no loss of traction by over-revving of the engine.

Choose as smooth a slope as possible and select the appropriate gear so that gear changing in the middle of the climb is not required.

Changing gears in the middle of the climb can cause loss of momentum and engine stalling. Shifting to a lower gear

has to be done cautiously to avoid loss of traction.

Never move the vehicle diagonally across a hill. The danger is in loss of traction and sideways slippage, possibly resulting in tipping over. If unavoidable, choose as mild an angle as possible and keep the vehicle moving.

If the wheels start to slip within few feet of the end of the climb, motion can be maintained by swinging the steered wheels left and right, thereby providing increased grip.

If the vehicle stalls or losses headway while climbing a steep hill, make a quick shift to reverse and allow the vehicle to move back with the control of engine compression.

Descending sharp gradients :



Depending on the severity of the gradient, shift into appropriate gear. Use engine braking judiciously without over-revving the engine.

Brake application under such situations should be done very smoothly to avoid loss of control. Select appropriate gear so that gear changing or clutch disengagement is not involved while descending the gradient.

EMERGENCY PARKING OF THE VEHICLE ON THE ROAD :

In case of emergency, if you want to park your vehicle on the road for long a time, follow the instructions given below :

1. Try to park your vehicle at the extreme left side of the road and switch 'ON' the hazard warning lights.
2. Place wheel chocks at the wheels if your vehicle is parked on a slope, otherwise engage the parking brake.
3. Place the advance warning triangle on the road (50 meters behind your vehicle where it is stranded) in the same lane of traffic.

The advance warning triangle, first aid kit, scissor jack, foldable jack handle and tool kit are provided with your vehicle, which are kept below the second row seat and easily accessible.

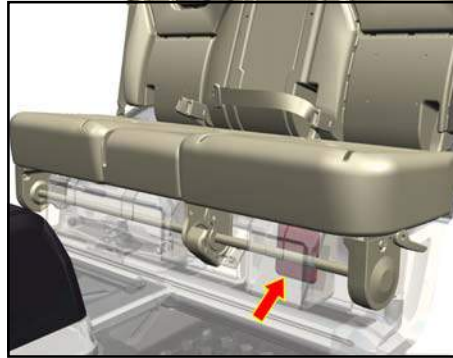

Location of First Aid Kit

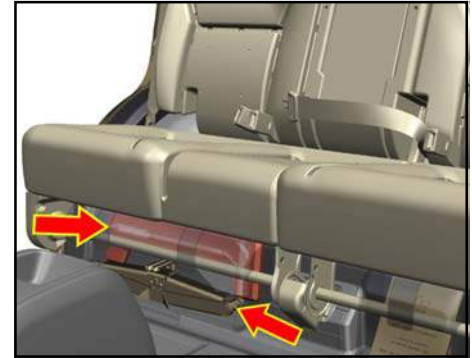

Location of Tool Kit & Jack

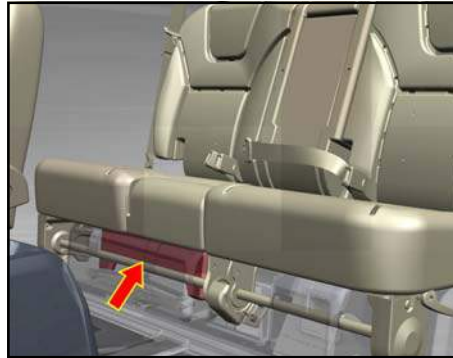

Location of Advance Warning Triangle

EMERGENCY AIDS

First Aid Kit :



First aid kit is provide with your vehicle and kept below the second row seat, which is easily accessible and can be used in case of emergency.

While using the first aid kit, always use it as per the instructions given in the instruction sheet. Please check for contents and it's expiry date.

Advance Warning Triangle :



A foldable advance warning triangle is kept in the pocket below the second row seat.

After using an advance warning triangle, fold the same and keep it in its original place, so that it will be easily available in the case of emergency.

Jack & Tool Kit :

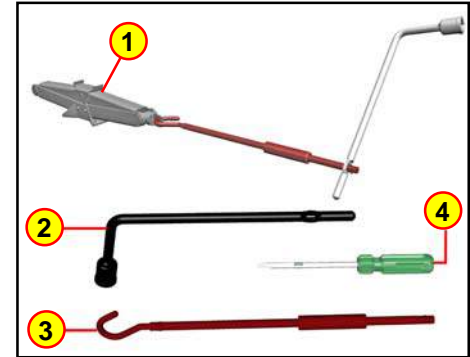

1. Scissor Jack
2. Wheel Spanner
3. Jack Handle
4. Screw Driver

A scissor type jack, foldable handle and tool kit are provided with your vehicle.

A pocket is provided at the RH side of the second row seat base to keep all these material.

Always keep all these material to its original place, when it is not in use.

EMERGENCY TOWING :

In case of emergency, where there is a need to tow the vehicle, follow the instructions given below :

- Instead of using rope, chain or belt, always use a wrecker or rigid tow bar for towing a vehicle.
- Avoid using a flexible cable or rope as your vehicle might get damaged, when any of the vehicle stops suddenly.
- Switch 'ON' the hazard warning lights of both the vehicles to warn other road users.
- Where possible, keep the engine idling so that power steering assistance and brake vacuum are available.
- Limit the speed to 20-30 kmph.
- In case of brake failure, use the parking brake to control the vehicle.

NOTE

- If the vehicle needs to be towed, call professional towing service
- If it is not possible to shift the gear to neutral, then disconnect the propeller shaft and remove it before towing.
- If it is not possible to shift the transmission or start the engine or if the wheels are jammed, the vehicle must be transported on flat bed truck, where the vehicle is loaded into the back of a truck.

⚠ CAUTION

Trying to lift or tow the vehicle by bumpers will cause serious damage. The bumpers are not designed to support the vehicle's weight.

Location of Tow Hooks:



Tow Hook Attachment Location at Front



Tow Hook Attachment Location at Rear

INERTIA SWITCH :

Your **TATA SAFARI STORME** is fitted with an inertia switch. This switch will trigger if the vehicle is brought to an abrupt halt, normally during a collision. Normal driving and even sudden braking will not trigger the inertia switch.

When the inertia switch is triggered the following will happen :

- All doors will be unlocked.
- All turn indicators will flash (both left and right side).
- All roof lamps will be turned ON.

To undo the above affects, you have to reset the inertia switch.

WARNING

After resetting the switch and before resuming driving, check for any damage to the body or check if any part is hanging loose. Also after turning ON the ignition, ensure that no faults are displayed in the instrument cluster.

Resetting the inertia switch :

- Open the co-driver door and remove the trim cover below the glove box.



- Access the inertia switch and press the switch to reset.



STARTING THE ENGINE WITH JUMP LEADS :

The engine with a discharged battery can be started by transferring electrical power from the battery of another vehicle.

This may be dangerous as any deviation from the following instructions could lead to personal injury resulting from any battery explosion, as well as damage to the electrical systems in both vehicles.

WARNING

Do not allow battery electrolyte to come in contact with eyes, skin, fabrics or painted surfaces. The fluid contains sulphuric acid which can cause injury and severe damage. Wear rubber gloves, to avoid risk of contact.

- Wear eye protection when working near any battery.
- Make sure that the battery providing the jump start has the same voltage as the battery in your vehicle (12V).

The voltage and capacity are given on the batteries.

- Do not disconnect the discharged battery from the vehicle.
- Switch off all unnecessary electrical loads.
- Do not lean over the battery during jump starting.
- Do not allow the terminals of one lead to touch those of the other lead.
- Apply hand brake. Keep the gear shift lever in neutral.
- Do not connect the lead to the negative terminal of the discharged battery.
- The connection of the -ve lead point should be as far away from the discharged battery as possible and close to the starter motor.
- Route the leads so that they do not get caught by the rotating parts in the engine compartment.

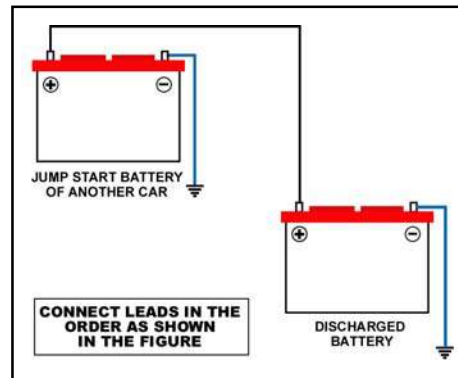
Connect leads in the order as shown in the sketch

Attempts to start the engine of the vehicle with the discharged battery should be made at intervals of one minute and should not last more than 15 seconds. After starting, allow both engines to idle for approximately 3 minutes with the leads still connected.

⚠ CAUTION

Do not push start the vehicle, this may damage flywheel.

IF YOU HAVE A FLAT TYRE

If a tyre goes flat while you are driving, reduce vehicle speed gradually keeping your vehicle in a straight line. Move cautiously off the road to safe place and away from traffic, where you can park your vehicle on a levelled and firm ground.

While jacking the vehicle, following precautions are to be taken :

1. Park the vehicle on a firm, leveled and non-slippery surface.
2. Turn ON hazard warning switch.
3. Apply parking brake and engage 1st gear.
4. Keep advance-warning triangle at least 50 meters behind the vehicle as an indication of breakdown.
5. Ensure that the all passengers get down from the vehicle.
4. Block the wheel which diagonally opposite to the flat tyre by using chocks.

Procedure for replacing flat tyre :

1. Open the tailgate and remove the plastic cap by pressing on its edge. The spanner can be inserted through this hole.

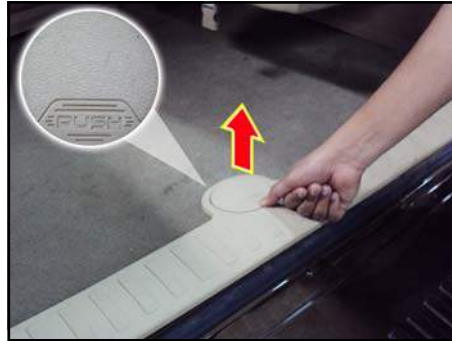

2. Rotate the spanner anti-clockwise to lower the spare wheel till it rests on the ground.



3. Remove the holding bracket from the spare wheel and get it separated.



4. Loosen the wheels nuts slightly before lifting up the vehicle.

5. Place the jack below the jacking points and lift the vehicle slowly. These points are located approx. 920 mm behind the front wheel and 700 mm ahead of the rear wheel.
6. Remove wheel mounting nuts, which were loosened earlier and take out the flat tyre.
7. Roll the spare wheel into position and align the holes of the wheel rim with studs fixed on hub.
8. Reinstall the wheel nuts (tapper end inward) and tighten all the nuts properly by hand.
9. Lower the jack completely , so that tyre rests on the ground and retighten the nuts by using wheel spanner.
10. Press fit the wheel cover back (if fitted)
11. Fix the flat tyre in the place of spare wheel by following reverse steps of removing the spare wheel .
11. Keep all the tools and jack to its original place.

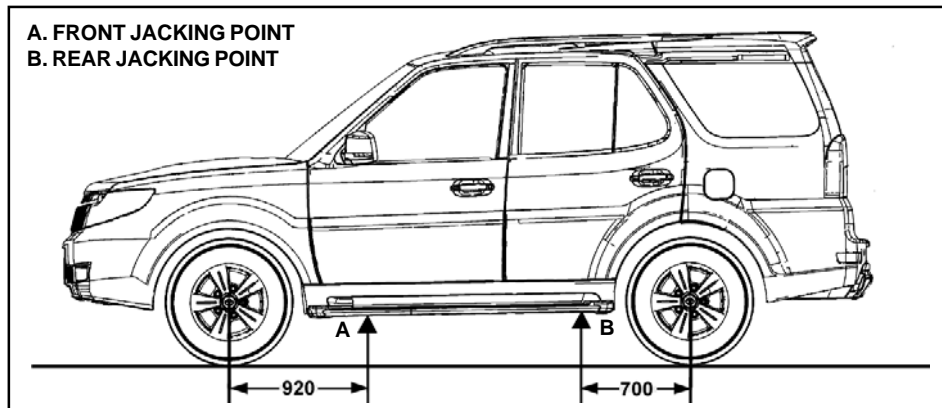
JACKING POINTS :

Jacking Point - Front



Jacking Point - Rear

FUSE AND RELAY BOX :

The fuses & relays are located in three fuse boxes:

1. Battery mounted fuse box is mounted in the battery in the engine compartment.
2. Engine compartment fuse box and relay box is located in engine compartment.
3. Cabin wiring harness fuse and relay box is located under the dashboard on driver's side.

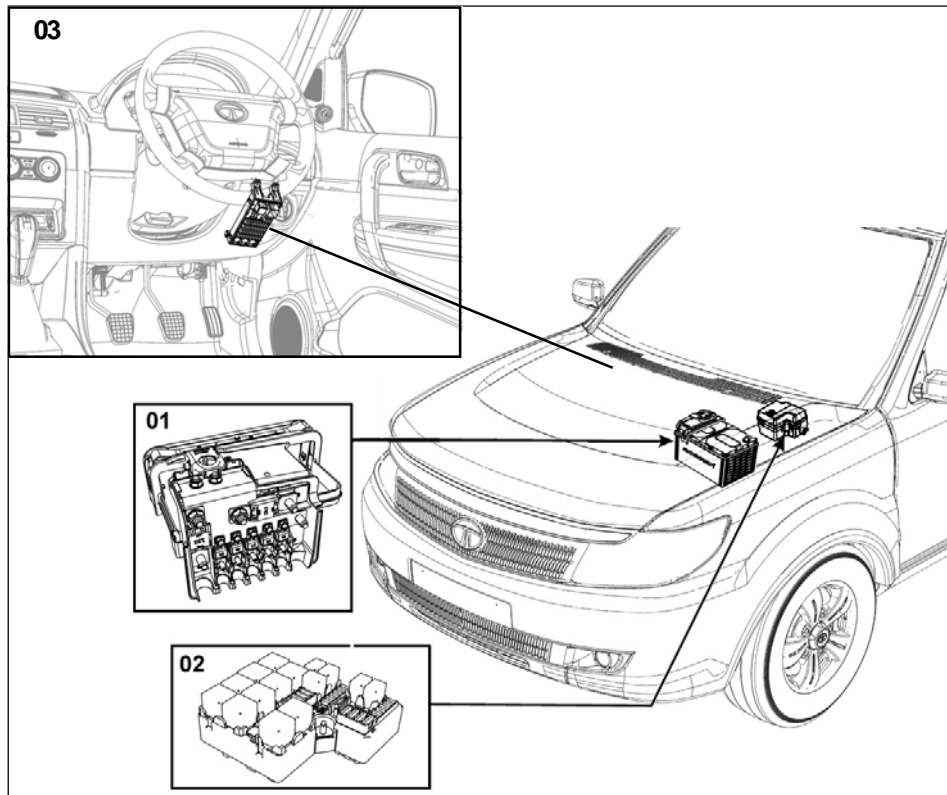
Location of the three fuse boxes in your vehicle :

1. ENGINE COMPARTMENT FUSE AND RELAY BOX

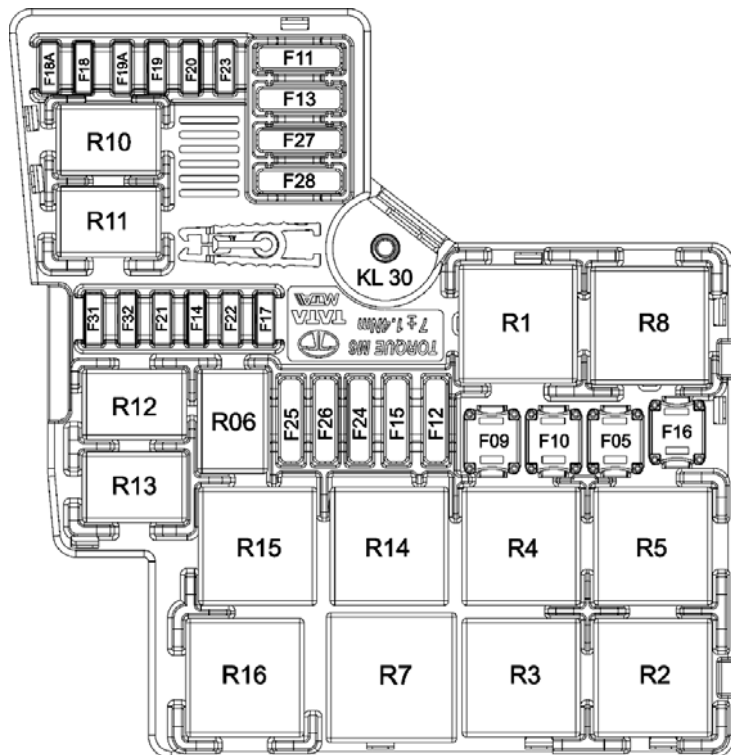

NO	RATING	POWER CONSUMER
F5	60	ACCESSORIES
F9	40	ENG COOLING FAN-2
F10	30	DEFOGGER
F11		SPARE
F12	40	HVAC
F13	25	ABS BATT 2
F14	15	AC CLUTCH
F15	30	EMS
F16	40	STARTER MOTOR
F17	15	SPARE
F18	10	HEAD LAMP LOW RH
F18A	10	HEAD LAMP LOW LH
F19	10	HEAD LAMP HIGH RH
F19A	10	HEAD LAMP HIGH LH
F20		SPARE
F21	10	HORN
F22		SPARE
F23	15	RR WIPER MOTOR
F24	40	GLOW PLUG FUSE 1
F25	15	FRONT FOG
F26	40	GLOW PLUG FUSE 2
F27	30	BCM
F28	25	CONDENSER FAN
F31	15	TOW BAR

NO	RATING	POWER CONSUMER
F32		SPARE
R1		ACCESSORIES
R2		COOLING FAN
R3		COOLING FAN
R4		COOLING FAN
R5		HEATED RR WINDOW
R6		AIR CON
R7		EMS
R8		STARTER
R10		DIP BEAM
R11		HIGH BEAM
R12		HORN
R13		FRONT WIPER
R14		GLOW PLUG 1
R15		FRONT FOG LAMP
R16		GLOW PLUG 2

2. BATTERY MOUNTED FUSE AND RELAY BOX

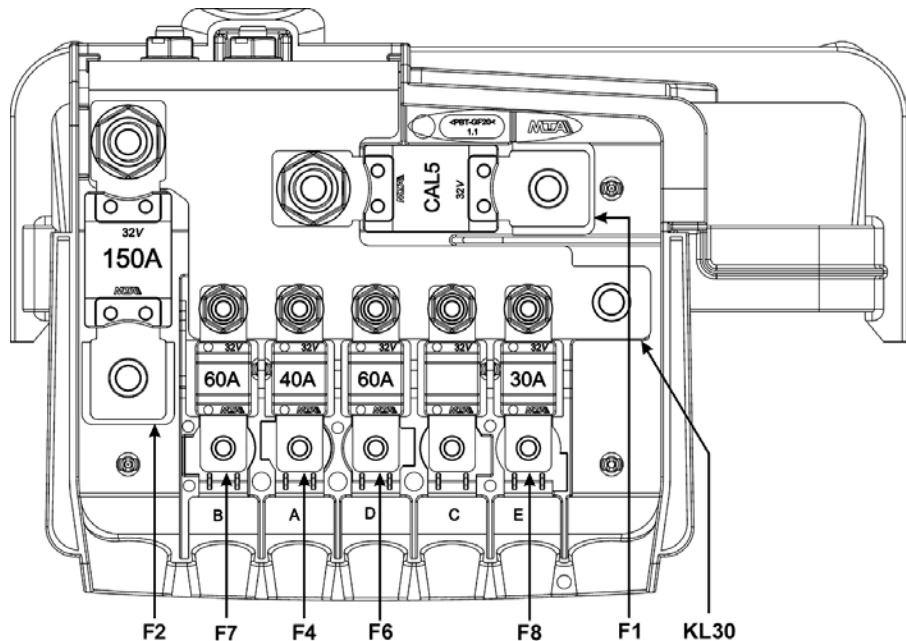

NO	RATING	POWER CONSUMER	NO	RATING	POWER CONSUMER
F1	POWERVAL CAL5	STARTER MOTOR	F6	MIDIVAL 60	IGNITION
F2	MEGAVAL 150	ALTERNATOR	F7	MIDIVAL 60	PCFB
F4	MIDIVAL 40	ABS	F8	MIDIVAL 30	ENGINE COOLING FAN1

3. CABIN WIRING HARNESS FUSE & RELAY BOX UNDER THE DASHBOARD ON DRIVER SIDE (RIGHT SIDE)
 This fuse box is part of main wiring harness.

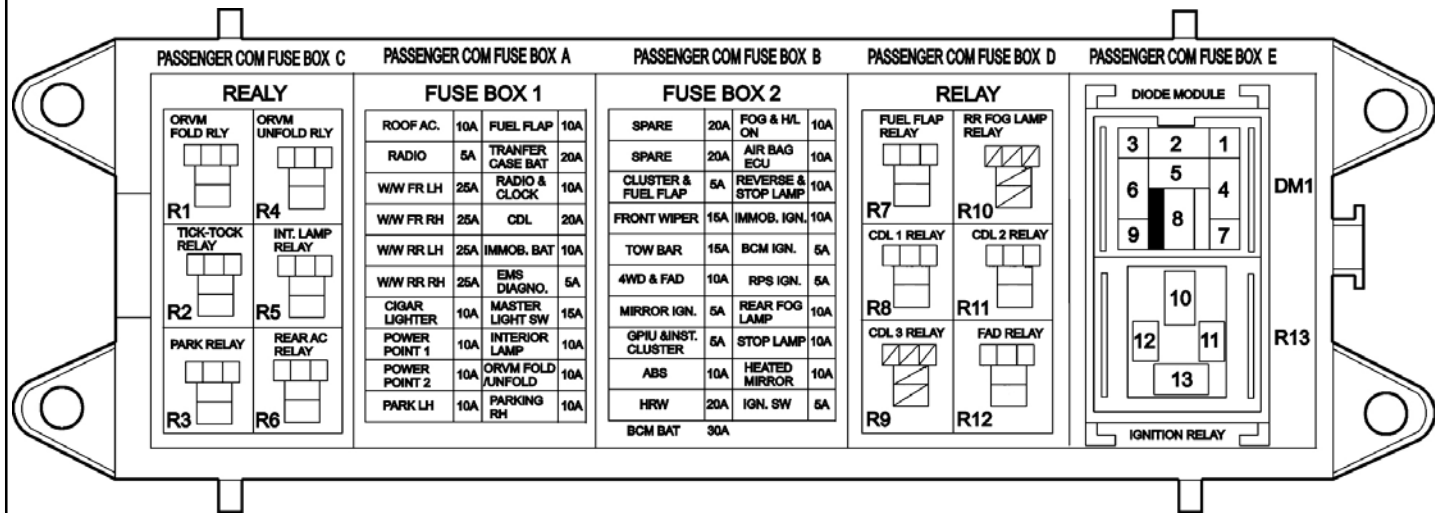

NO	RATING	POWER CONSUMER
F1	10	ROOF AC
F2	5	RADIO
F3	25	WW FR LH
F4	25	WW FR RH
F5	25	WW RR LH
F6	25	WW RR RH
F7	10	CIGAR LIGHTER
F8	10	POWER POINT 1
F9	10	POWER POINT2
F10	10	PARK RH
F11	10	FUEL FLAP
F12	20	TRANSFER CASE
F13	10	RADIO & CLOCK
F14	20	CDL
F15	10	IMMOBILIZER
F16	5	EMS DIAGNOSTIC
F17	15	MASTER LIGHT SWITCH
F18	10	INTERIOR LAMP
F19	10	ORVM FOLD / UNFOLD
F20	10	PARK LH
F21	20	SPARE
F22	20	SPARE
F23	5	CLUSTER & FUEL FLAP
F24	15	FR WIPER
F25	15	TOW BAR
F26	10	4WD & FAD

NO	RATING	POWER CONSUMER
F27	5	MIRROR IGN.
F28	5	GPIU & CLUSTER
F29	10	ABS
F30	20	HRW
F31	10	FOG & HEAD LAMPS ON
F32	10	AIRBAG
F33	10	REVERSE LAMP
F34	10	IMMOBILIZER
F35	5	BCM
F36	5	RPS IGN.
F37	10	RR FOG LAMP
F38	10	STOP LAMP
F39	10	HEATED MIRROR
F40	5	IGNITION SWITCH
R1		ORVM FOLD
R2		TICK TOCK
R3		PARK LAMPS
R4		ORVM UNFOLD
R5		INTERIOR LAMPS
R6		REAR AC
R7		FUEL FLAP
R8		CENTRAL DOOR LOCKING 1
R9		CENTRAL DOOR LOCKING 3
R10		REAR FOG LAMP
R11		CENTRAL DOOR LOCKING 2
R12		FAD RELAY
R13		IGNITION RELAY

BULB SPECIFICATION :

SR.NO	DESCRIPTION	CAP TYPE	SPECIFICATION	QUANTITY
1	Head Lamp - High Beam		H7 12 V 55W	2
2	Head Lamp - Low Beam		H7 12 V 55W	2
3	Head Lamp - Turn Indicator	PY 24 W	12V 24W	2
4	Head Lamp - Position Lamp	W5W	12 V 5W	2
5	Tail Lamp - Stop/Tail	P 21 / 5W	12 V 21/5W	2
6	Tail Lamp - Turn Indicator	PY 21 W	12 V 21W	2
7	Tail Lamp - Reverse	PY 21 W	12 V 21W	2
8	Front Fog Lamp		H3 12V 55W	2
9	Rear Fog Lamp	P 21 W	12 V 21W	2
10	High Mounted - Stop Lamp		LED	1
11	Registration Plate Lamp	W5W	12 V 5W	2
12	Roof Lamp - First	W5W	12 V 5W	3
13	Roof Lamp - Second & Third	W5W	12 V 5W	6
14	Puddle Lamps	W5W	12 V 5W	4
15	ORVM Indicator		LED	2
16	Glove Box Lamp	W 5 W	12V 5W	1

HEAD LAMP BULB REPLACEMENT :

Procedure:

WARNING

- Bulbs can be very hot. You should therefore allow them to cool down before you change them.
- Keep bulbs out of reach of children.
- Never use a bulb which has been dropped. Such a bulb may explode and injure you.
- Do not touch or handle bulbs with bare hand

Before you change the bulb :

- Only fit bulbs of the same type and wattage.
- Switch the lights OFF before changing a bulb to prevent short circuit.
- Always hold the bulb with a clean, lint free cloth.
- Do not work with wet or greasy fingers.
- If the new bulb does not come ON, contact the nearest **TATA** authorized service centre.

- Handle the bulb only at metal part and not at glass portion.

High beam bulb replacement :

1. Open the bonnet.
2. Remove the rubber cap / socket cover on the backside of the headlamp.



3. Disconnect the electrical connector by pulling it out firmly.
4. Loosen the screw to release the bulb retainer spring, which holds the bulb. Release bulb by pressing and moving it upward.



5. Remove the defective headlamp bulb carefully.



6. Fit the bulb by following the above steps in reverse order.

HEAD LAMP BULB REPLACEMENT

Low beam bulb replacement :

1. Open the bonnet.
2. Remove the rubber cap / socket cover on the backside of the headlamp.



2. Disconnect the electrical connector by pulling it out firmly.



3. Release the bulb retainer spring, which holds the bulb. Release bulb by pressing and moving it upward.



IN CASE OF EMERGENCY

4. Remove the defective headlamp bulb carefully.



Fitment procedure:

1. Place the bulb properly by matching the rectangular notch in the bulb housing and the bulb seat.
2. Lock the headlamp bulb in place, by using the retainer spring. Confirm if the bulb is seated properly by looking through the front lens in case of high beam only.
3. Fix the connector.
4. Put back the socket cover.

TAIL LAMP BULB REPLACEMENT :

1. Open the tailgate.
2. Remove the bulb access cut out.
3. Disconnect the connector by pulling it out firmly.
4. You can now replace any of the damaged / fused bulb from the tail lamp cluster.



5. Rotate the bulb holder in anticlockwise direction and remove the bulb from the holder.



6. Replace the bulb with new one.
7. Rotate the bulb holder in clockwise direction for fitment and connect the connector.
8. Fit the bulb access cut out.

NOTE

Same procedure is applicable for all the bulbs of tail lamp.

WARNING

- Allow bulbs to cool down before you change them.
- Keep bulbs out of reach of children.
- Never use a bulb, which has been dropped. Such a bulb may explode and injure you.

PRELIMINARY TROUBLESHOOTING

(These tips are given for your guidance and preliminary jobs to be done in an emergency situation. In normal case, the problems should be attended in an Authorised Workshop by following the repair procedures given in Workshop Manual)

SR. NO.	PROBLEM OBSERVED	CAUSE	ACTION TO BE TAKEN
ENGINE			
1.	Engine not cranking	Dead battery, loose, dirty connections	Charge / change the battery
		Battery not getting charged from the alternator connections	Clean and tighten battery and alternator
		Starter motor relay damaged	Check battery to alternator connections
		Starter motor fuse blown off	Loose starter motor connections
2.	Engine cranks but does not fire	Air in the fuel system	Prime the fuel system using priming pump
		MIL glowing	Check and rectify the fault code
		Incorrect Immobilizer pairing	Do immobilizer pairing
		Unlearnt vehicle Key	Do immobilizer learning
		Damaged vehicle Key	Use new key
		Loose cam sensor connections	Rectify the connections
		Loose crank sensor connections	Rectify the connections
		Loose rail pressure connector	Rectify the connections
		Loose EMS ECU connector	Rectify the connections
3.	Engine Overheat	Coolant level low	Top up the coolant
		Coolant leakage from radiator cap	Retighten radiator cap
		Coolant leakage from the circuit	Rectify the leakage
		Coolant hose punctured	Replace the hose
		Radiator fans not working	Check the fan connector, loose or disconnected

SR. NO.	PROBLEM OBSERVED	CAUSE	ACTION TO BE TAKEN
		Brakes binding	Get defect rectified
		High delivery pressure in AC circuit	Get defect rectified
		Radiator fins clogged	Get defect rectified
		Radiator coolant passage blocked	Get defect rectified
		Thermostat defective	Get defect rectified
4.	Battery charging indicator glowing continuously	Loose battery to alternator connections	Retighten the connections
		Loose battery connections	Retighten the connections
		Defective alternator	Replace the alternator
5.	Poor pick up	MIL ON	Check for fault code and get it rectified
		Air filter element choked	Clean air filter as per recommendations
		Fuel filter choked	Replace the fuel filter
		Low tyre pressure	Properly inflate the tyres
		Brake binding	Re-set the brakes
		Engine overheat	Top up coolant
		'Water in fuel' lamp glowing	Drain water from fuel pre-filter cum sedimenter
		'ABS' lamp ON	Rectify the ABS unit
		Check for Diesel leakage	Rectify the leakage
6.	Low engine oil pressure indicator ON	Low engine oil level	Top up engine oil
		Faulty pressure switch	Rectify the pressure switch
			Faulty inst. cluster lamp connections
			Rectify the instrument cluster
7.	Raised engine idle speed	Water in fuel lamp ON	Drain water from fuel pre-filter cum sedimenter
		Accelerator pedal connections loose	Get it rectified
		Engine Overheat	Top up coolant and refer Point no.3

SR. NO.	PROBLEM OBSERVED	CAUSE	ACTION TO BE TAKEN
8.	Radiator fans running continuously even with AC in OFF condition	Defective refrigerant pressure switch	Rectify the refrigerant pressure switch
		MIL ON	Check for the fault code and get it rectified
		Defective coolant temperature sensor	Rectify coolant temperature sensor
		Engine running hotter than normal	Refer point no. 3
		Faulty fan relay	Get the relay rectified
		Faulty EMS ECU	Get defect rectified
9.	Accessory belt noise	Low belt tensions	Re-tension the belts
10.	Water in fuel lamp 'ON'	Water accumulated in water sedmenter	Drain water from fuel pre-filter cum sedimenter
CLUTCH			
1.	Clutch does not get disengaged	Less clutch pedal height	Set clutch pedal height inline with brake pedal
		Air in the hydraulic system	Bleed the system
		Less fluid in the master cylinder	Get clutch fluid filled
2.	Clutch pedal goes too low	Less clutch pedal height	Set clutch pedal height inline with brake pedal
		Air in the hydraulic system	Bleed the system
		Less fluid in the master cylinder	Get clutch fluid filled
3.	Clutch pedal return sluggish	Less clutch pedal height	Set clutch pedal height inline with brake pedal
		Blocking of vent in brake fluid	Open the cap from the bottle and clean bottle the breather hole, if clogged
GEAR BOX			
1.	Gears slipping out of mesh	Worn/damaged grooves on shifter shaft	Replace
		Worn shift fork or synchroniser sleeve	Replace
		Weak or damaged detent springs	Replace
		Worn bearings on input shaft or layshaft	Replace
		Worn dog teeth on sleeve and gear	Replace sleeve and gear

SR. NO.	PROBLEM OBSERVED	CAUSE	ACTION TO BE TAKEN
2.	Hard shifting	Inadequate lubricant	Replenish
		Inadequate clutch pedal travel	Adjust
		Distorted or broken clutch disc	Replace
		Damaged clutch pressure plate	Replace clutch cover/disc
		Worn synchrocones	Replace
		Worn dog teeth on sleeve or gear	Replace sleeve or gear
		Distorted shift shaft/linkages	Replace
3.	Noise	Inadequate or insufficient lubricant	Replenish
		Damaged or worn bearing(s)	Replace
		Damaged or worn gear(s)	Replace
		Damaged or worn synchroniser parts	Replace
BRAKES			
1.	Poor brakes	Insufficient brake fluid.	Get the brake fluid filled
		Air in the system	Bleed the system
		Vacuum leakage	Rectify the leakage
		Brake fluid contamination	Replace the brake fluid
		Brake fluid, grease, oil or water on pad /drum	Replace the leaking line, bleed the system. Clean pad / lining,replace seals if leaking
		Worn brake lining/pad	Get the liners/pad replaced
		Soft or weak hose	Check and replace
2.	Spongy pedal	Air in the system	Bleed the system

SR. NO.	PROBLEM OBSERVED	CAUSE	ACTION TO BE TAKEN
3.	Brake pulling to one side	Oil on the lining/pad	Clean the pad lining
		One side shoe (pad) worn	Get the shoe pad replaced
		Wheel adjustment disturbed	Adjust
		Unequal tyre pressure	Adjust
		One side brake pipe clogged	Get the brake line cleaned and bleed the system
4.	Brake grab	Improperly adjusted parking brake	Get correctly adjusted
		Brake fluid container breather hole clogged	Clean the hole on the container
		No brake pedal free play/brake pedal not returning fully	Adjust brake pedal Check clevis pin
		Defective tandem master cylinder	Replace/rectify tandem master cylinder.
		Brake light switch over tightened	Set brake light switch.
5.	Brake Squeal	Defective brake lining/pad	Replace
		Glazed lining/pad	Clean or replace lining/pad
		Wrong lining/pad	Install correct lining/pad
		Front pads /Antisqueal shims rubbing on the disc	Get corrected
STEERING			
1.	Hard steering	For power steering - Less fluid in the power steering reservoir.	Get the recommended fluid topped up to correct level
		Air in the system	Get the air removed by bleeding the system
		Loose pump belt	Get the belt correctly adjusted

SR. NO.	PROBLEM OBSERVED	CAUSE	ACTION TO BE TAKEN
SUSPENSION			
1.	Abnormal or excessive tyre wear	Tyre out of balance	Check balance and/or adjust if required.
		Steering geometry disturbed	Adjust steering geometry
		Tyres not adequately inflated	Adjust tyre pressure
		Wobbly wheel or tyre	Replace wheel or tyre
		Defective tyre	Replace tyre
		Brake grabbing	Check and rectify
		Excessive braking	Modify driving habit
2.	Abnormal noise from front end	Worn, sticky or loose tie rod ends, lower ball joints, tie rod in any of its joint	Replace tie rod end, suspension arm, tie rod or drive shaft joints
		Warning noise for pad wear	Replace pad
		Damaged struts or mounting	Repair mounting or replace struts
		Worn suspension arm bushings	Replace
		Loose wheel nuts	Tighten wheel nuts
		Loose suspension bolts or nuts	Tighten suspension bolts or nuts
		Broken or damaged wheel bearing	Replace
		Poorly lubricated or worn strut bearings	Lubricate or replace strut bearings
		Loose caliper housing bolts	Check & tighten
3.	Ride too soft / bumpy	Faulty struts	Replace strut
4.	Suspension bottoms	Over loaded	Check loading
		Faulty struts	Replace struts

SR. NO.	PROBLEM OBSERVED	CAUSE	ACTION TO BE TAKEN
ELECTRICAL			
1.	No lights on the dash board after turning on the ignition key	Battery terminal disconnected	Get the battery properly connected
		Battery completely dead	Get the battery charged
			Get the alternator and charging circuit checked
			Check for parking lamp fuse
2.	Non functioning elect. accessories such as power windows, head lamps, fuel tank flap, wiper and washer etc.	Blown fuse in the circuit	Replace the fuse if blown
		Loose connectors	Get the connection properly tightened
		Circuit relay loose	Tighten the relay correctly
		Defective components	Get the defective component replaced from Authorised Workshop
3.	All turn indicator lights are flashing continuously, roof lamps are turned 'ON' & door are unlocked	Inertia switch triggered	Reset inertia switch. Refer the procedure 'Resetting the inertia switch'
AIR CONDITIONING			
1.	Fan motor does not operate	Blown fuse	Replace fuse and correct any wiring short
		Faulty connection	Properly connect poor connections
		Faulty motor	Replace motor if no conductance
		Faulty blower control module	Replace blower control module
		Faulty fan switch	Replace switch
2.	Motor operates but air flow is minimum	Obstruction at evaporator inlet	Clean evaporator
		Air leak	Correctly seal
		Faulty thermostat	Adjust or replace thermostat

SR. NO.	PROBLEM OBSERVED	CAUSE	ACTION TO BE TAKEN
3.	Insufficient cooling, Air flow normal and compressor operating	Incorrect refrigerant quantity or defect in system aggregates	Get the defect rectified at nearest authorised service centre
WIPERS			
1.	Narrow streaks are left on the wind shield making it hard to see.	Foreign matter has attached to the blade or blade edge of the blade is worn out	Clean the edge of the blade. If streaks still appear replace it.
2.	The wiper blade jumps across the windshield & makes a lot of noise across the surface.	No proper contact of wiper blade with wind shield glass and wiper blade does not move smoothly	Clean the wind shield. If jumping persists replace the blade.
3.	The wipe leaves large un-wiped spots.	Rubber deformed	Replace the blade
4.	The blade does not contact with the windshield surface evenly, leaving a large un-wiped surface.	Deformed wiper blade / arm	Replace wiper blade / arm

ENGINE COMPARTMENT

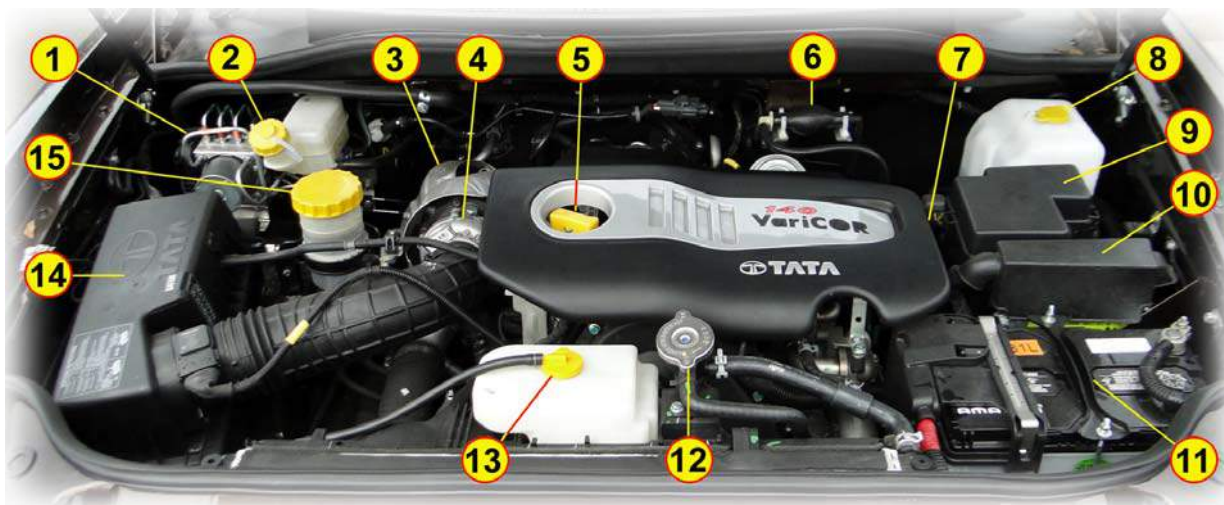

01. ABS ECU/HCU

02. Brake Fluid Reservoir

03. Catcon with heat shield

04. Turbocharger

05. Engine Oil Filling Cap

06. Priming Pump

07. Engine Oil Dip Stick

08. Windshield Washer Fluid Reservoir

09. Fuse & Relay Box

10. Condenser Fan Relay

11. Battery

12. Radiator Cap

13. Auxiliary Tank

14. Air Filter

15. Power Steering Fluid Container

AIR FILTER:



1. Air Filter 2. Service Indicator

Replace air filter element as per the servicing instructions label on air filter body. We do not recommend to clean the air filter element before the replacement period, however if filter element is to be cleaned (in case of vehicle operation in dusty condition) procedure indicated on servicing label to be followed. Get the air filter element replaced at a **TATA MOTORS** Authorised Service Center.

Always use a genuine air filter element.

NOTE

- When a vehicle is driven under dusty conditions, frequent cleaning and replacement of the air-cleaner element is necessary.
- Clogged air-cleaners lead to increased resistance to air intake which increases fuel consumption. Using low pressure compressed air, blow off dust on the air cleaner element. If the air cleaner element appears to be choked, replace it with a new one.

ENGINE OIL LEVEL :



1. Engine Oil Filling Cap 2. Dip Stick

Warm up the engine to normal operating temperature.

Turn it off and wait for at least 30 minutes for the oil to return to the oil pan.

Be sure the vehicle is on a level surface.

Pull out the dipstick, wipe it clean, and reinsert if fully.

Pull it out again and examine the oil level. It should be between 'Min' and 'Max' level. If not, top up with recommended engine oil.

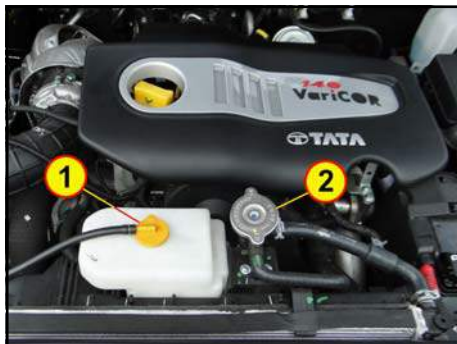
ENGINE COOLANT LEVEL:

1. Engine Coolant Tank 2. Radiator Cap

WARNING

- Do not remove radiator cap when the engine is hot. The coolant is under pressure, it may erupt through the opening if the cap is removed. You may suffer with serious burning. Do not open the radiator cap until the radiator is cool to touch.
- Check the coolant level in the radiator auxiliary tank. It should be in between MAX and MIN level.

NOTE

If auxiliary tank is empty, fill it up to the 'MAX' level.

CAUTION

Engine coolant can damage the finish of your vehicle. If engine coolant spills on the vehicle, wash it off thoroughly with clean water.

BRAKE FLUID LEVEL :

The level of the brake fluid must be between the MIN. and MAX. marks on the side of the brake fluid container. If

the level falls below the min. mark, add recommended brake fluid. (Refer section - Fuels, coolants and lubricants)

In case of spongy or hard pedal or low brake efficiency, please contact the nearest **TATA** authorised Service outlet.

CAUTION

- Do not allow brake fluid to make contact with the skin or eyes. In case of accidental contact, wash eyes with cool water immediately and consult a doctor.
- Do not allow brake fluid to splash or spill on the paint surface as it will damage the paint. In case of spillage, wipe it off immediately.

POWER STEERING RESERVOIR FLUID :



The level of the power steering fluid must be between the MIN. and MAX. marks on the side of the power steering fluid container. If the level falls below the MIN. mark, add recommended fluid. (Refer section - Fuels, coolants and lubricants) In case of leakage or hard steering, please contact the nearest **TATA** Authorised Service outlet.

⚠ CAUTION

- Do not start the engine without oil in the power steering system.
- Do not allow dirt into power steering fluid reservoir during refilling or top up.

WINDSHIELD WASHER FLUID :



Windshield washer fluid container filler neck is provided on the left hand side behind the fuse box in the engine compartment.

NOTE

Do not add detergent or any solvent in the windshield washing water.

FUEL FILTER :

Fuel filter separates dust particles from the fuel and allows clean fuel in to the fuel injection system. It also separates and stores water.

Get it replaced with genuine fuel filter and at specified intervals.

WATER DRAINING FROM FUEL PRE-FILTER CUM SEDIMENTER :

1. Fuel pre-filter cum sedimenter
2. Fuel pre-filter cum sedimenter sensor with pigtail

1. Stop the engine and wait until pressure stabilize.
2. Disconnect the sensor pigtail and also disconnect one of the fuel lines, either inlet or outlet.
3. Keep a suitable container to collect the drained water.
4. Rotate the fuel pre-filter cum

sedimenter sensor in the anti-clockwise direction for about 2 turns and allow approximately 120cc of contaminated diesel (diesel + water) to drain. As soon as the flow is free of water, tighten the sensor.

5. Connect the fuel line and refill the fuel line using hand-priming pump.

**Priming Pump****NOTE**

Whenever water draining from from fuel pre-filter is done ;it should be carried out for main filter also.

TURBOCHARGER:

Your vehicle has a variable nozzle turbocharger (VNT) and is connected to the exhaust manifold. Turbocharger is used to increase the volumetric efficiency of the engine.

Lubrication of Turbocharger:

Idle the engine for a while (one minute) after starting the engine and before stopping the engine to ensure adequate lubricating oil supply to the turbocharger.

If you suspect any malfunction of the turbocharger, take the vehicle to the nearest **TATA** authorised dealership.

INTERCOOLER :

Intercooler cools the hot air coming from the turbocharger before entering the intake manifold. It does not require any maintenance, however it can be cleaned externally by blowing compressed air

CAUTION

While cleaning, ensure that intercooler fins are not damaged. If the fins get damaged, it could lead to loss of performance and subsequent failure.

CATALYTIC CONVERTER :

The catalytic converter is fitted on your vehicle to reduce exhaust pollution. The catalytic converter will quickly heat up after starting to ensure that it operates correctly during the warm up phase of the engine.

The catalytic converter does not require any special maintenance however, following precaution should be taken for the effective functioning of the converter and to avoid damage to the converter.

- 1 It is mandatory to use diesel fuel with low sulphur content (Refer recommended fuels). Use of any other diesel fuel can increase the pollutants.

- 2 Avoid parking the vehicle over inflammable materials, such as dry leaves, grass, etc., as the exhaust system is hot enough to initiate "FIRE".

Maintenance of Catalytic Converter

Flush the Catalytic Converter by giving full throttle (4 to 5 times) in standing condition of vehicle on daily basis.

In addition to this it is recommended to run the vehicle at high speed (80 to 100 kmph) for few km as this will help to flush the carbon soot deposits from exhaust system and catalytic converter. High speed running of the vehicle may be done periodically to avoid chocking of catalytic converter.

CAUTION

- Avoid push start or tow-starting the vehicle. (Use jump leads).
- Avoid long (not more than ten sec.) repeat (not more than three times) starting of the Vehicle.

- Avoid long idling (to warm-up). If the engine is running rough, after a cold start.
- Avoid pre-coating / painting of catalytic converter.

WHEELS & TYRES :

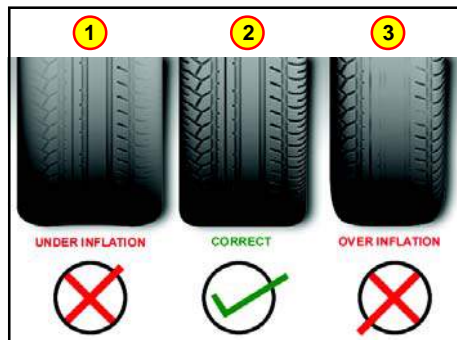

1.	Under inflation	Excessive Side Tread Wear
2.	Correct Tyre Pressure	Uniform Tyre Wear
3.	Over inflation	Excessive Centre Tread Wear

Recommended Tyre Pressures

	LADEN	UNLADEN
FRONT	34 psi (2.2 bar)	32 psi (2.1 bar)
REAR	34 psi (2.2 bar)	32 psi (2.1 bar)

Check for inflation and condition of your vehicle tyres periodically.

Inflation:



TYRE PRESSURE		
	LADEN	UNLADEN
FRONT	34 psi (2.2 bar)	32 psi (2.1 bar)
REAR	34 psi (2.2 bar)	32 psi (2.1 bar)

Check the pressure in the tyres when they are cold.

Proper inflation of tyres gives you the best combination of riding comfort handling, tyre life and better fuel efficiency.

Over inflation of tyres makes the vehicle ride bumpy and harsh. Tyres are more prone to uneven wear and damage from road hazards.

Under inflated tyres reduce your comfort in vehicle handling and are prone to failures due to high temperature. They also cause uneven wear and more fuel consumption.

NOTE

Tyre pressure should be checked in "cold" condition. Hot tyres tend to show a slightly higher value.

CAUTION

1. Every time you check inflation pressure, you should also examine tyres for damage, trapping of foreign objects in the treads and wear.
2. If you notice bumps or bulges in the tread or the side of the tyre, replace the tyre.
3. If there are cuts, splits or cracks in the side of the tyre, replace the tyre.

4. Replace tyre if excessive tread wear or non uniform tyre wear is noticed.

For Tyre Size and Rim Size , please refer Technical Information Chapter.

Repairing a Tyre:

Mark the tyre position suitably (if original colour dot mark is not visible) with respect to valve stem hole to ensure that the tyre is refitted in the original location on the wheel rim.

Ensure that balancing weights are not disturbed during removal of tyres.

Check the balance weight prior to the removal of the tyre. If found loose, mark its location on the rim and refit properly.

Balance the wheel after every dismantling and assembly of tyre on the wheel rim.

Tyre Rotation:

To equalize wear on each tyre, rotate them periodically as shown in the figure. Regular tyre rotation will also prevent abnormal wear.

Tyre rotation must be carried out at specified intervals as per service schedule.

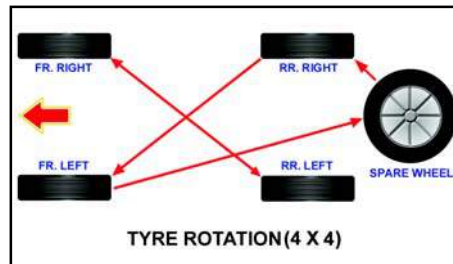
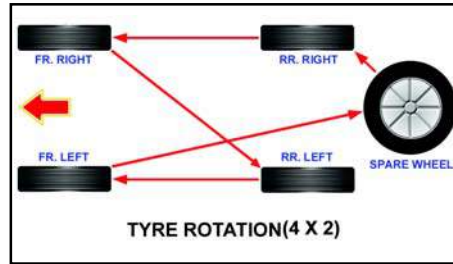

Wheel alignment:

Incorrect wheel alignment causes excessive and uneven tyre wear. Check wheel alignment at specified intervals. Wheel alignment values are given below:

	Front	Rear
Caster	3° ± 30'	-
Camber	0° ± 30'	-
Toe Out	-	-
Toe In	2 - 5 mm	-

Wheel Balancing :

Wheels of your vehicle are balanced for better ride comfort and longer tyre life. It is recommended to balance the wheel, whenever tyre is removed from the rim.

Radial tubeless tyres :

Radial tubeless tyres have following advantages over conventional tube tyres:

- Lesser heat generation.
- Improves dynamic stability.
- Lower rolling resistance and lesser weight, which improves fuel efficiency.
- Better safety

Special care for tubeless tyres :

- Tubeless tyres are coated with impermeable layer of rubber from inside which holds the air inside the tyre. Do not scratch inside of tubeless tyre with metallic or sharp object. This may cause gradual loss of air.
- If wheel rim gets damaged in the service, get the wheel rim repaired/ replaced immediately. Running the vehicle with damaged rim may cause deflation of tyre and subsequent dislodging of tyre from rim.
- Maintain recommended tyre pressure. Over inflated tyre may cause puncture or bursting of tyre.

NOTE

Life and wear pattern of tyres depends on various parameters like tyre pressure, wheel alignment, wheel balancing, tyre rotation, etc. It also largely depends on vehicle speed, load carried, usage, driving habits, road conditions, etc.

BATTERY :

Check the battery for proper electrolyte level and corrosion on the terminals.

1. Check the battery for electrolyte level against the marking on the battery outer case.
2. Check the battery terminals for corrosion (a white or yellowish powder). To remove it, cover the terminals with a solution of baking soda. It will bubble up and turn brown.
3. When this stops, wash it off with plain water. Dry off the battery with a cloth or paper towel.

4. Coat the terminals with petroleum jelly to prevent future corrosion.
5. Use a proper wrench to loosen and remove cables from the terminals.

Always disconnect the negative (-ve) cable first and reconnect it last.

Clean the battery terminals with a terminal cleaning tool or wire brush.

Reconnect and tighten the cables, coat the terminals with petroleum jelly.

Ensure that the battery securely mounted.

If you need to connect the battery to a charger, disconnect the battery negative cable to prevent damage to your vehicle's electrical system.

WARNING

- During normal operation, the battery generates gas which is explosive in nature. A spark or open flame can cause the battery to explode causing very serious injuries.

- Keep all sparks and open flames and smoking materials away from the battery.
- Getting electrolyte in your eyes or on the skin can cause severe burns. Wear protective clothing and a face shield or have a skilled technician to do the battery maintenance.
- The battery contains sulphuric acid (electrolyte) which is poisonous and highly corrosive in nature.

VEHICLE CARE :

Your vehicle is subjected to many external influences such as climate, road conditions, industrial pollution and humidity. These conditions demand regular care of the vehicle body. Dirt, insects, bird droppings, oil, grease, fuel and stone chippings should be removed as soon as possible.

Washing your vehicle :

Following tips while washing your vehicle :

HAND WASH:

1. Always wash your vehicle in shade and where the surface is at room temperature.
2. Wash with mild car wash soap like 'Car Shampoo' and use a soft 100% cotton cloth to avoid scratches.
3. To avoid scratches, please wear soft gloves . Remove finger rings, nails, wrist watch while washing.

4. To remove stubborn stains and contaminants like tar, use turpentine or cleaners like 'Stain remover' which are safe for paint surfaces.
5. Avoid substances like petrol, diesel, kerosene, benzene or other solvents that cause damage to paint.
6. Dry your vehicle thoroughly to prevent any damp spots.
7. Rinse all surfaces thoroughly to prevent any traces of soap and other cleaners as this may lead to the formation of stains on the painted surface later.

NOTE

Do not direct high pressure washer fluid/ water jets at electrical devices and their connectors during washing. This is to prevent malfunction / failure of electrical system due to water ingress.

Waxing :

Waxing and polishing is recommended to maintain the gloss and wet-look appearance of your paint finish.

1. Use a good quality polish and wax for your vehicle.
2. Re-wax your vehicle when the water does not slip off the surface and collects over the surface in patches.

Tips for the care of your new vehicle finish :

If your vehicle is washed in an automatic car wash, please remember that the paint can be scratched by type of brushes, unfiltered washing water or the washing process itself. Scratching reduces paint durability and gloss, especially on darker colours. It is suggested to wash the vehicle by hand with cool and clean water using a soft cloth or sponge. Please do not use soap but a car shampoo recommended by your dealer.

Precautions :

1. Always wash your vehicle in shade, avoiding direct exposure to sunlight during washing.
2. Dry wiping your vehicle may lead to the formation of scratches. Always use a soft cloth and clean water while wiping your vehicle.
3. Always keep your vehicle parked in a well ventilated shade. Exposure to heat with entrapped moisture promotes corrosion.
4. Avoid driving on gravel roads, as the possibility of paint chip off due to the impact of stones is high. Also avoid driving on freshly tarred road.
5. External contamination in the form of sap or industrial fall-out may spoil or develop spots on a new finish. Hence avoid parking your vehicle near trees, which are known to drop sap, or near factories.
6. Bird droppings may damage the paint

finish, hence bird dropping must be immediately washed off.

7. The paint finish is susceptible to damage in case petrol, brake fluid, liquid from vehicle battery, oil, antifreeze, transmission fluid or windshield solvent spills onto the painted surface. In case of such a spillage immediately rinse the affected area with water. Avoid wiping the area as far as possible. If wiping is required, wipe the area gently with soft cotton cloth.
8. Avoid using sharp objects to scrap off tar / mud from a painted surface.

Various environmental hazards affecting paints :**The enemy :**

Ultraviolet Rays, Pollution, Tree Sap, Bird Droppings, Car Wash Chemicals, Road Salt, Acid Rain.

Benefits of external enrichment :

- Removal of medium scratches, orange peel, oxidation, dust nibs etc

and swirl marks from painted surface.

- Restoration of original gloss levels UV protection after gloss is restored.
- Cleaning and dressing of tyres, Bumpers and all exterior plastic moldings / trims.

Cleaning of carpets :

Vacuum clean the carpet regularly to remove dirt. Dirt will make the carpet wear out faster. Periodically shampoo the carpet to keep it looking new.

Use carpet cleaners (preferably foam type). Follow the instructions that come with the cleaner. Apply it with a sponge or soft brush. Keep the carpeting as dry as possible by not adding water to the foam.

NOTE

Avoid wiping of painted surface in dry condition as it may leave scratches on the painted surface.

Cleaning of window glasses :

Clean the windows inside and outside with commercially available glass cleaners.

This will remove the haze that builds up on the inside of windows. Use a soft cloth or paper towels to clean all glass and plastic surfaces.

Cleaning of rear windshield glass (With printed circuit) :

While cleaning rear windshield glass, avoid to wipe the glass from inside. If



required, always wipe it with soft cotton cloth and inline with printed circuit.

NOTE

Do not rub the glass with a dry cloth across the printed circuit, this may damage the printed circuit.

RFID TAG

RFID TAG is pasted on front windshield from inside. It enables Electronic toll collection.



DO NOT TRY TO PEEL OFF RFID TAG

TML PART NO. 2816 5420 99 05

NOTICE

Do not attempt to rip or tamper the tag. It will disable the functionality of the tag.

Wiper care :

Wiper blade attack angle on windshield glass should be 90° i.e. perpendicular.

Remove wiper blade and root wiper arm on windshield glass in the centre position. Check the gap between arm strip and glass.

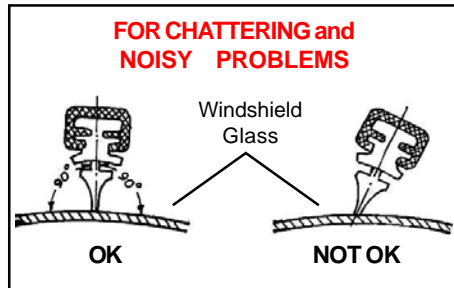
**Parking vehicle for long duration (Non-use maintenance) :**

- Park the vehicle in covered, dry and well ventilated premises. Engage gear.
- Remove the battery terminal cables (First remove the cable from the negative terminal)
- Make sure the hand brake is engaged.
- Clean and protect the painted parts using protective wax.
- Clean and protect the shiny metal parts using commercially available special compounds.
- Sprinkle talcum powder on the rubber of windscreen wiper and lift them off the glass.
- Cover the vehicle with a cloth or perforated plastic sheet. Do not use sheets of imperforated plastic as they do not allow moisture on the vehicle body to evaporate.
- Do not drain the engine cooling system.

FUEL :

High speed diesel conforming to IS1460 or EN 590 or equivalent is recommended to be used as fuel.

At very low temperature, fluidity of diesel may become insufficient due to paraffin separation. It is therefore necessary to mix supplementary fuel with summer or winter grade diesel. The supplementary fuel to be used is kerosene or aviation turbine fuel.

Ratio for mixing of supplementary fuel and diesel are shown in the table.

Outside Ambient temp. upto Deg.C	Percentage	
	Summer Grade Diesel	Supplimentary Fuel
Upto 0°C	100	0
0°C to -10°C	70	30
-10°C to -15°C	50	50

Care should be taken that diesel and supplementary fuel are thoroughly mixed before filling.

Outside Ambient temp. upto Deg.C	Percentage	
	Winter Grade Diesel	Supplimentary Fuel
Upto -15°C	100	0
-15°C to -20°C	70	30
-20°C & Above	50	50

WARNING

Do not mix gasoline or alcohol with diesel. This mixture can cause explosion.

NOTE

Where oxidation catalytic converter is fitted, it is mandatory to use diesel fuel with sulphur contents less than 0.005 % (BS-IV). Use of any other diesel fuel can increase the pollutants.

LUBRICANTS AND COOLANTS:**Lubricants :**

Engine oil : Recommended grade of engine oil conforming to API-CH4+MB228.3 or higher grade engine oil to be used. Specification and range of ambient temperature at which these can be used are given in the table below :

Ambient temp. in deg.C	Engine oil grade
-5 and above	SAE 15W40
-20 to 0	SAE 5W30

Gearbox:

75W90 GL 4 Synthetic.

Brake fluid :

SAE J 1703, DOT 4

Rear Axle & Front Live Axle :

85W140API-GL-5

Power Steering :

ATF - Dextron III-D

Coolants :

Presence of dirt in coolant chokes up passages in radiator, cylinder head and crankcase, thereby causing overheating of engine.

To prevent rust formation and freezing of coolant inside the passages of radiator, crankcase and cylinder head use premixed coolant as recommended.

It is recommended that the entire cooling system should be drained and filled with fresh premixed coolant.

Windscreen Washer Antifrost

Concentration - 1:5 For 0°C
 1:1 For 10°C
 2: 5 For 16°C
 1: 0 For 37°C

NOTE

We strongly recommend to refill your vehicle's engine coolant only at a **TATA** Authorised service centre.

CO-BRANDED LUBRICANTS AND COOLANTS

ITEM	SPECIFICATION	COMPANY	BRAND	QUANTITY
ENGINE OIL	API-CH4+MB228.3 (15W40)	CASTROL HPCL EXXON MOBIL	GTX (Diesel) Milcy No.1 Mobil Super 1000 TM	7.5 Litres
COOLANT	50:50 ratio premixed	S-CCI HPCL CASTROL	Golden Cruiser Premium 1400M Thanda Raja P TGO Radicool	Approx. 9 Litres
GEARBOX (G-76)	75W90 GL4 SYNTHETIC	CASTROL HPCL EXXON MOBIL	Castrol Syntro 75W90 GL4 HP Gear EP 75W90(T) Castrol Syntro	2.2 Litres
TRANSFERCASE	ATF Type-A	SHELL	Donax TG	1.2 - 1.4 Litres
POWER STEERING OIL	ATF-DEXRON	CASTROL HPCL EXXON MOBIL	Castrol TQ Dextron II D Dexron II D Mobil Multipurpose ATF	1.6 Litres
REAR AXLE (Limited Slip Differential)	85W140 API-GL5 Anglomol 6043	HPCL CASTROL	HP Gear Oil XP 85W140 T2 Castrol Long Drain Rear Axle Oil 85W140	1.68 Litres and 0.09 Litres (For friction modifier)
REAR AXLE (Standard Differential)	85W140 API-GL5 Anglomol 6043	HPCL CASTROL	HP Gear Oil XP 85W140 T2 Castrol Long Drain Rear Axle Oil 85W140	1.68 Litres
LIVE FRONT AXLE	85W140 API-GL5 Anglomol 6043	HPCL CASTROL	HP Gear Oil XP 85W140 T2 Castrol Long Drain Rear Axle Oil 85W140	1.50 Litres
BRAKE / CLUTCH FLUID	SAE J 1703, DOT 4	S-CCI CASTROL	Golden Cruiser Tata Genuine Brake Fluid (DOT4) Universal Brake Fluid	As Required
GREASE (Where Applicable)		HPCL CASTROL	Multipurpose Grease-2 Castrol AP2	As Required

ENGINE	
Model	TATA 140 VariCOR
Type	Direct injection, Common rail, Turbocharged, Intercooled Diesel Engine
No. Of Cylinders	4 inline
Bore / Stroke	85 mm x 96 mm
Capacity	2179 cc
Max. Engine Output	103 kW (140PS) @ 4000 rpm as per CMVR / 115 - (9) 1996
Max. Torque	320 Nm @ 1700 - 2700 rpm as per CMVR 115 - (9) 1996
Compression Ratio	17.2 : 1
Firing Order	1-3-4-2
Engine Oil Capacity	Max. 7.5 litres. / Min. 5.5 litres.
CLUTCH	
Type	Single plate dry friction diaphragm type
Outside diameter of clutch lining	240 mm
Friction Area	451 cm ² (Approx)

GEAR BOX	
Model	GBS-76-5/4.1,MK-II with overdrive
Type	Synchromesh on all gears
No. of gears	5 Forward & 1 Reverse
Gear Ratios	1st - 4.10 2nd - 2.22 3rd - 1.37 4th - 1.00 5th - 0.73 Rev - 4.22
TRANSFER CASE	
Type	LH Drop transfercase, ECU control Electrical shifting arrangement mounted on the gear box (For 4X4)
Drive Options	4X2 High Ratio 1:1 4X4 High Ratio 1:1 4X4 Low Ratio 1:2.48
REAR AXLE	
Type	Singal reduction Banjo type rear axle with hypoid gears & semi-floating axle shafts with limited slip differential for 4X4 & Without limited slip differential for 4X2
Ratio	4.1

FRONT AXLE	
For 4 X 4	Independently suspended with Axle Disconnect. Ratio:4.1
For 4 X 2	Independently suspended
STEERING	
Type	Rack and Pinion steering with power assistance. (Hydraulic)
Ratio	17.5:1
Steering Wheel	380 mm dia. with Low pivot tilt mechanism for adjusting height & collapsible column
BRAKES	
Service Brake	Vacuum assisted independent hydraulic brakes on front & rear through tandem master cylinder. Vacuum pump camshaft driven
Front Brakes	Ventilated disc brakes Disc dia. 302 (4X4) / 298 (4X2) Disc thickness : 26 C48 X 48 twin pot caliper with 8"+9" tandem booster with dia. 26.99, TMC pedal ratio : 4.2
Rear Brake	C48 X 48 single pot caliper with DIH (Drum in hat, drum dia. 206 Disc dia. 316)

Load conscious pressure reducing Valve	Load sensing pressure valve (LSPV) provided for non-ABS version
Parking Brake	Lever type, Console mounted, cable operated mechanical linkage acting on rear wheels through DIH.
Anti-lock Braking System (ABS)	4 channel , 4 sensors (For ABS)
FRAME	
Type	Ladder type cranked frame with boxed section members & welded cross members. Tow hook at the front and rear.
Depth	152 mm (Max)
Width	80 mm (Max)
SUSPENSION	
Front	Double wishbone type with coil springs over shock absorber.
Rear	Coil spring type 5 link rigid axle suspension
Shock Absorber	Hydraulic double acting telescopic at Front & Rear
Anti-roll Bar	At both front & rear

WHEELS & TYRES	
Tyres	PSR 235/70 R16 Passenger Radial Tubeless
Wheel Rims	1) 6.5J X 16 Stylised Wheel Rims 2) 6.5J X 16 Alloy Wheel Rims- Optional
No. of Wheels	Front : 2 Rear : 2 Spare :1
FUEL TANK	
Capacity	55 Litres
ELECTRICAL STSTEM	
System Voltage	12 Volts (-ve earth)
Alternator Capacity	120 amps
Battery	12 V, MF 80 A/h
PERFORMANCE	
Max. Speed with two occupants	160 kmph
Grade Restartability at rated GVW	4 X 4 : 75% @ 1000 rpm 4 X 2 : 29% @ 1000 rpm
Max. Gradeability at rated GVW	4 X 4 : 78% 4 X 2 : 55%
PASSENGER CAPACITY	
Passenger Capacity 7 Seater (6+Driver)	Front Seat : Driver + 1, Middle Seat : 3, Rear Seat : 2 (Side Facing)

WEIGHTS (kg)		
	4X4	4X2
Complete Vehicle kerb weight (With Spare Wheel & tools)	2095	2000
Gross Vehicle Weight	2650	2555
Max. permissible FAW	1280	1200
Max. permissible RAW	1470	1470
Kerb weight	Front	1170
	Rear	925
		1090
LUGGAGE SPACE		
Net inside loading space	~ 1000 mm wide x ~ 800 mm long (with 4 passengers + Driver)	
MAIN CHASSIS DIMENSION AS PER ISO:612 in MM		
Wheel Base	2650	
Track Front	1580	
Track Rear	1550	
Front Overhang	950	
Rear Overhang	1055 - Over rear bumper	
Overall Length	4655 - Over rear bumper	
Maximum Width	1965 - With footstep	
Overall Height	1922 (Unladen /Laden)	
Min. Turning Circle dia.	10.8 m	
Min. Turning Clearance Circle dia.	11.8 m	
Ground Clearance	200 mm	

VEHICLE DIMENSIONS

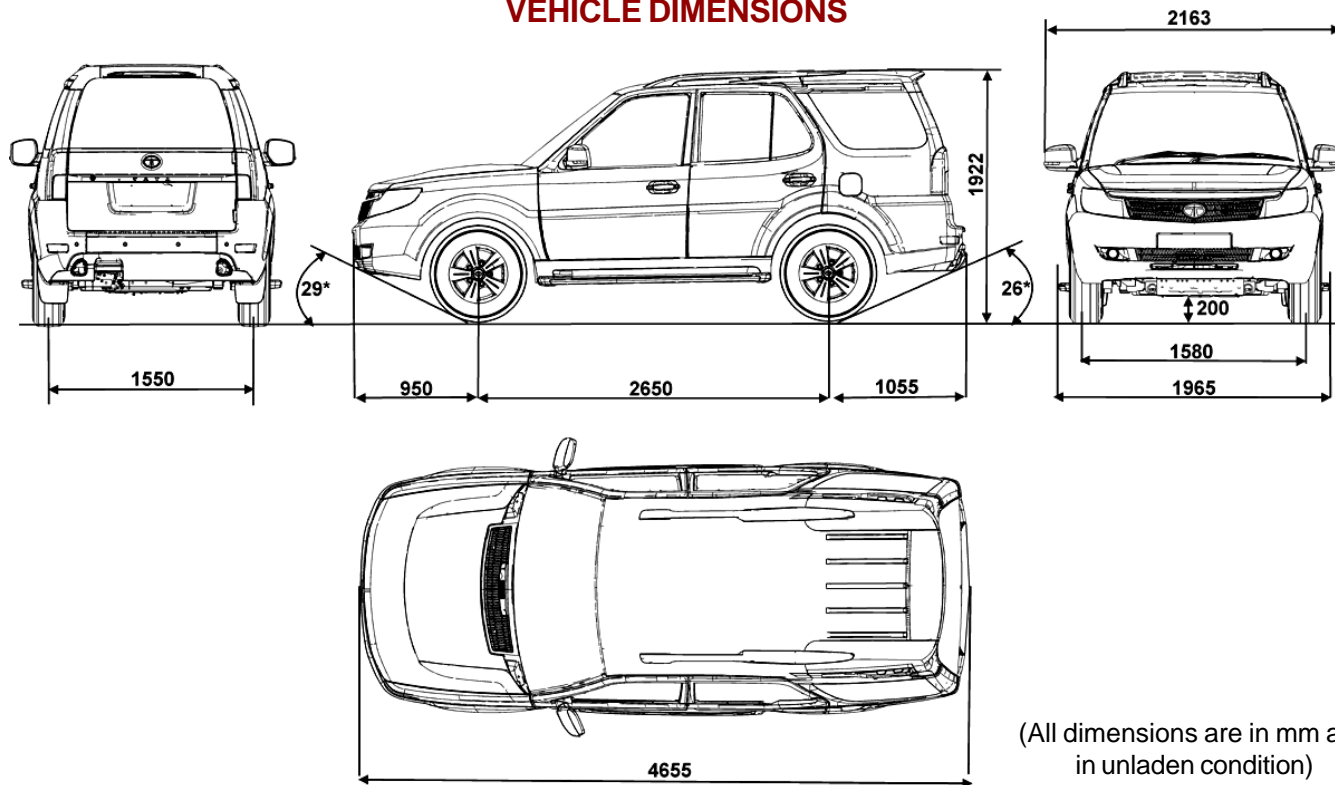

(All dimensions are in mm and in unladen condition)

CHASSIS & AGGREGATE NUMBERING LOCATIONS



Chassis No. - Punched on RH Long member



VIN Number Plate



Engine Number Plate



Gear Box Number - Punched

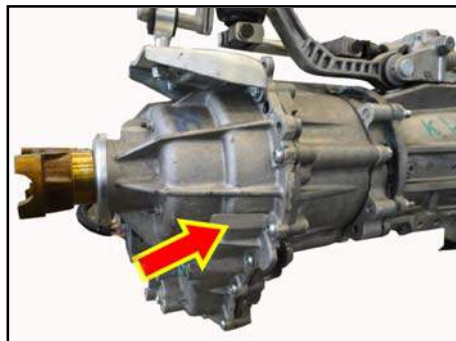

Transfercase Number Plate



Rear Axle Number - Punched

SERVICE INSTRUCTIONS :

To achieve economical and trouble free performance, please follow the instructions as stated.

YOUR VEHICLE IS ENTITLED TO FOUR FREE SERVICES (LABOUR ONLY). PLEASE PRESENT THESE COUPONS TO THE SERVICING DEALER WHILE AVAILING FREE SERVICES.

- 1st free service** - At 1000-1500 km. **OR** 1 month whichever is earlier
- 2nd free service** - At 4500-5500 km. **OR** 6 months whichever is earlier
- 3rd free service** - At 14500-15500 km. **OR** 12 months whichever is earlier
- 4th free service** - At 29500-30500 km. **OR** 24 months whichever is earlier

All services other than free services are chargeable.

Servicing of your vehicle can be done only at **TATA MOTORS** Authorised Dealership Workshop. The details of their locations are given in this manual.

Warranty claims can be settled by any **TATA MOTORS** Authorised Dealer for all failures, while all warranty claims excluding the consideration on the replacement of major aggregates, can be settled by any TASC which is authorised for handling warranty claims. TASCs will not handle warranty repairs.

SERVICE SCHEDULE

SL. NO.	OPERATION	FREQUENCY (in KM)	PDI	1000-1500	5000-5500	15000-15500	30000-30500	45000-45500	60000-60500	75000-75500	90000-90500	105000-105500
GENERAL												
1.	Wash the vehicle & clean the condenser with compressed air	Every Service	x	x	x	x	x	x	x	x	x	x
2.	Check & Top up Fluids if required: Coolant, Brake / Clutch Fluid, Battery Electrolyte, Power Steering Oil, Gear Box Oil, Transercase & Front Axle (4X4), Rear Axle oil	Every Service	x	x	x	x	x	x	x	x	x	x
3.	Drain water accumulated in fuel pre-filter cum sedimenter (OR whenever the warning lamp glows)	Every Service	x	x	x	x	x	x	x	x	x	x
4.	Check engine compartment for loose fasteners, low pressure fuel lines, Coolant hoses, Air hoses, Vacuum hoses, Hydraulic line connections for leakages if any. Attend if necessary.	Every Service	x	x	x	x	x	x	x	x	x	x
5.	Check Underbody for loose fasteners, hydraulic line connections, exhaust system / fuel Pipes for Damages or leakages if any. Attend if necessary.	Every Service	x	x	x	x	x	x	x	x	x	x
6.	Apply grease on door latches, door lock, door check stop, striker, bonnet opening lever & lock plate, tailgate hinges & v door lock inner ratchet.	Every Service		x	x	x	x	x	x	x	x	x
7.	Check & ensure normal working of your vehicle using diagnostic equipment.	Every Service	x	x	x	x	x	x	x	x	x	x
140 VariCOR ENGINE												
1.	* Replace Engine oil and oil filter	Every 15000 km OR 1 Year, whichever is earlier				x	x	x	x	x	x	x
2.	Replace fuel filter	Every 30000 km OR 2 Year, whichever is earlier					x		x		x	

SL. NO.	OPERATION	FREQUENCY (in KM)	PDI	1000-1500	5000-5500	15000-15500	30000-30500	45000-45500	60000-60500	75000-75500	90000-90500	105000-105500
3.	* Clean air filter element.	Every Service			x	x	x	x	x	x	x	x
4.	* Replace air filter element	Every 45,000						x			x	
5.	Check All accessory Drive belts, adjust tension if required, change if damaged	Every 15000 km OR 1 Year, whichever is earlier				x	x	x	x	x	x	x
6.	Check timing belt and if found damaged replace alongwith tensioner	First at 45000 km & thereafter every 30000 km						x		x		
7.	Replace timing belt & timing belt tensioner	Every 105000 km OR 5 Years, whichever is earlier										x
8.	Replace Engine Coolant	Every 60000 km OR 2 Years, whichever is earlier							x			
9.	Replace vacuum hoses for vacuum modulator, turbocharger, EGR valve & throttle valve	Every 60000 km OR 4 Years, whichever is earlier							x			
10.	Replace fuel pre-filter cum sedimenter	Every 15000 km OR 1 Year, whichever is earlier				x	x	x	x	x	x	x

SL. NO.	OPERATION	FREQUENCY (in KM)	PDI	1000-1500	5000-5500	15000-15500	30000-30500	45000-45500	60000-60500	75000-75500	90000-90500	105000-105500
GEAR BOX												
1.	* Replace gear box oil & clean breather	First at 45000 km & thereafter every 90000 km						x				
2.	Replace transercase oil & clean breather (In 4X4 vehicle)	45,000						x				
PROPELLER SHAFT												
1.	Grease propeller shaft with grease gun (at slip joint - splines end) & Check Centre bracket mounting bolts for looseness. Tighten if necessary.	Every Service		x	x	x	x	x	x	x	x	x
2.	Check for rubber cracks on Torsional Vibration Damper (TVD), replace if necessary	Every Service		x	x	x	x	x	x	x	x	x
FRONT AXLE (FOR 4X4) / REAR AXLE												
1.	* Replace axle oil & clean breather	First at 15000 km & thereafter every 75000 km				x					x	
SUSPENSION & STEERING												
1.	Check wheel alignment/Steering wheel spoke alignment/ balancing & adjust if necessary	Every Service				x	x	x	x	x	x	x
2.	Check shock absorber, bushes ,replace if necessary	First at 30000 km & thereafter every service					x	x	x	x	x	x

SL. NO.	OPERATION	FREQUENCY (in KM)	PDI	1000-1500	5000-5500	15000-15500	30000-30500	45000-45500	60000-60500	75000-75500	90000-90500	105000-105500
3.	Check condition of rubber bushes in Top & Lower wishbone, Anti roll bars, Rear links, Panhard rod, rubber boots / dust cover/ bellow in rack & pinion, Steering ball joints and column. Replace if necessary.	Every 30,000					X		X		X	
4.	Replace power steering oil & filter element	1,05,000										X
CLUTCH & BRAKE												
1.	Check parking brakes, adjust if necessary	Every Service		X	X	X	X	X	X	X	X	X
2.	Check front brake pads & rear brake, re-grease DIH liner resting points. Replace if necessary.	Every Service		X	X	X	X	X	X	X	X	X
3.	Replace Brake & Clutch Fluid	Every 45000 km OR 2 Year, whichever is earlier						X			X	
ELECTRICALS												
1.	Check headlamp low beam aiming & functioning of other electrical equip.	Every Service		X	X	X	X	X	X	X	X	X
2.	Check for looseness of +ve terminal on alternator and starter motor	Every 30,000					X		X		X	
HVAC												
1.	Check the HVAC System for satisfactory performance, attend if required	Every Service		X	X	X	X	X	X	X	X	X
WHEELS & TYRES												
1.	Tyre rotation	Every Service		X	X	X	X	X	X	X	X	X

* Under severe driving conditions, additional maintenance is required. Please Refer to “Additional Maintenance Schedule under severe driving conditions”:

Precautions to be taken while cleaning engine compartment : It is recommended to use dry low pressure air. Do not use pressurised water.

ADDITIONAL MAINTENANCE SCHEDULE UNDER SEVERE DRIVING CONDITIONS :

- A Driving in conditions such as Patrolling, Taxi, Pickup Van, Vehicle Towing, with Trailer Towing
- B Driving on Dusty / Sandy roads
- C More than 50% (in terms of kms) driving in heavy city traffic
- D Frequently operating in mountainous area

SL	ITEM	INTERVAL	CONDITION			
			A	B	C	D
1.	Engine oil & oil filter	Change every 7500kms	●	●	●	●
2.	Air filter element	Clean at every 7500kms & replace at 30,000kms		●	●	
3.	Front (for 4x4) & rear axle oil change	Change first at 15000kms & thereafter at 45000 kms	●	●		●

Km. reading	Fuel filled	Fuel consumption	Remarks / complaints

CHASSIS NO.....

Date	Odometer	Repair reading (km)	Particulars of Repair Order No.	Servicing Dealer's Signature & Stamp

CHASSIS NO.....

Recommended Service	Date	Odometer Reading	Repair Order No.	Servicing Dealer's Signature and Stamp
At km.				
PDI				
1,500				
5,000				
15,000				
30,000				
45,000				
60,000				
75,000				
90,000				
1,05,000				
1,20,000				
1,35,000				

Chassis No.

Engine No.

Gear Box No.

At **5,000-5,500 km** OR **6 months** whichever is earlier

please bring your vehicle for this service

as per details given in the **SERVICE SCHEDULE**.

2

**FREE
LABOUR**

TATA MOTORS
WORK DONE TO MY SATISFACTION

Sign. of Customer

Speedo Reading Km. seal O.K. / Broken

R.O. No. Date

Dealer's / Authorised Service Centre's

Stamp & Signature

At the time of delivery of vehicle, please ensure that
pre-delivery inspection has been carried out as per details
given in the **SERVICE SCHEDULE**.

Chassis No.

Engine No.

Gear Box No.

PDI

**FREE
LABOUR**

TATA MOTORS
WORK DONE TO MY SATISFACTION

Sign. of Customer

Speedo Reading Km. seal O.K. / Broken

R.O. No. Date

Dealer's / Authorised Service Centre's

Stamp & Signature

Chassis No.

Engine No.

At **15,000-15,500 km** OR **12 months** whichever is earlier

please bring your vehicle for this service

as per details given in the **SERVICE SCHEDULE**.

3

**FREE
LABOUR**

TATA MOTORS
WORK DONE TO MY SATISFACTION

Sign. of Customer

Speedo Reading Km. seal O.K. / Broken

R.O. No. Date

Dealer's / Authorised Service Centre's

Stamp & Signature

Chassis No.

Engine No.

At **1,000-1,500 km** OR **1 month** whichever is earlier

please bring your vehicle for this service

as per details given in the **SERVICE SCHEDULE**.

1

**FREE
LABOUR**

TATA MOTORS
WORK DONE TO MY SATISFACTION

Sign. of Customer

Speedo Reading Km. seal O.K. / Broken

R.O. No. Date

Dealer's / Authorised Service Centre's

Stamp & Signature

Chassis No.

4

Engine No.

At **30,000-30,500 km** OR **24 months** whichever is earlier
please bring your vehicle for this service
as per details given in the **SERVICE SCHEDULE**.

**FREE
LABOUR**

TATA MOTORS
WORK DONE TO MY SATISFACTION

Sign. of Customer

Speedo Reading Km. seal O.K. / Broken

R.O. No. Date

Dealer's / Authorised Service Centre's

Stamp & Signature



TATA MOTORS
SERVICE EDGE
Responsiveness • Reliability • Value

TATA MOTORS ORIGINAL PARTS



Value for money... assured.



Rely on us... always.

Call Us: 1 800 209 7979

Mail Us: customercare@tatamotors.com

Visit Us: www.customercare.tatamotors.com



www.facebook.com/tatasafari
www.tatasuv.com



www.twitter.com/tata_safari



5407 5840 99 01

TATA MOTORS | www.safaristorme.com