



MODEL S
OWNER'S MANUAL



DOCUMENT APPLICABILITY

This document describes the features available at time of printing for:

MODEL S SOFTWARE Version: 5.0

Features released in subsequent versions of software are not described in this document. However, you can display information about the newest features by viewing the Release Notes on the Model S touchscreen. These Release Notes are displayed on the touchscreen after a software update, and can be displayed at any time by touching the Tesla "T" at the top center of the touchscreen, then touching the Release Notes link (see page 5.24). If information provided in this document conflicts with information in the Release Notes, the Release Notes take precedence.

ILLUSTRATIONS

The illustrations provided in this document are for demonstration purposes only. Depending on vehicle options, software version and market region, the information displayed on the touchscreen in your Model S may appear slightly different.

PRODUCT SPECIFICATIONS

All specifications and descriptions contained in this document are verified to be accurate at the time of printing. However, because continuous improvement is a goal at Tesla, we reserve the right to make product modifications at any time.

ERROR OR OMISSIONS

To communicate any inaccuracies or omissions in this manual, please send an email to: ownersmanualfeedback@teslamotors.com.

©2012-2013 TESLA MOTORS, INC. All rights reserved.

All information in this document and all MODEL S® software is subject to copyright and other intellectual property rights of Tesla Motors, Inc. and its licensors. This material may not be modified, reproduced or copied, in whole or in part, without the prior written permission of Tesla Motors, Inc. and its licensors. Additional information is available upon request. The following are trademarks or registered trademarks of Tesla Motors, Inc. in the United States and other countries:

TESLA

TESLA MOTORS

TESLA
ROADSTER

TESLA



MODEL S

HOMELINK® and the HOMELINK® house icon are registered trademarks of Johnson Controls, Inc. Bluetooth® is a registered trademark of Bluetooth SIG, Inc. iPhone® is a registered trademark of Apple, Inc. Android™ and Google Maps™ are trademarks of Google, Inc. Sirius, XM and all related marks and logos are trademarks of Sirius XM Radio Inc. Pandora is a registered trademark of Pandora Media, Inc. Spotify is a registered trademark of the Spotify Group. All other trademarks contained in this document are the property of their respective owners and their use herein does not imply sponsorship or endorsement of their products or services. The unauthorized use of any trademark displayed in this document or on the vehicle is strictly prohibited.

OVERVIEW

Interior Overview.....	1.2
Exterior Overview.....	1.3

OPENING AND CLOSING

Doors.....	2.2
Windows.....	2.7
Rear Trunk.....	2.8
Front Trunk.....	2.10
Sunroof.....	2.12
Glove Box.....	2.13
Cup Holders.....	2.14

SEATING AND SAFETY

RESTRAINTS

Front and Rear Seats.....	3.2
Seat Belts.....	3.4
Child Safety Seats.....	3.7
Tesla Built In Rear Facing Child Seats.....	3.11
Airbags.....	3.15

DRIVING

Driver Profiles.....	4.2
Steering Wheel.....	4.3
Mirrors.....	4.5
Starting and Powering Off.....	4.6
Gears.....	4.7
Instrument Panel.....	4.8
Lights.....	4.11
Wipers and Washers.....	4.15
Park Assist.....	4.16
Trip Information.....	4.18
Energy Usage.....	4.19
Brakes.....	4.20
Traction Control.....	4.22
Cruise Control.....	4.23
Rear View Camera.....	4.24

USING THE TOUCHSCREEN

Touchscreen Overview.....	5.2
Touchscreen - Controls.....	5.4
Touchscreen - Settings.....	5.6
Climate Controls.....	5.8
Active Air Suspension.....	5.11
Media and Audio.....	5.12
Phone.....	5.17

Maps.....	5.19
Navigation.....	5.20
Security Settings.....	5.22
HomeLink® Universal Transceiver.....	5.23
Software Updates.....	5.24
Mobile App.....	5.25

CHARGING

Electric Vehicle Components.....	6.2
Battery Information.....	6.4
Charging Model S.....	6.5

MAINTENANCE

Maintenance Schedule.....	7.2
Tire Care and Maintenance.....	7.3
Temporary Tire Repair.....	7.8
Cleaning.....	7.12
Wiper Blades and Washer Jets.....	7.15
Fluid Reservoirs.....	7.16
Fuses.....	7.19
Jacking and Lifting.....	7.23
Parts and Accessories.....	7.24

SPECIFICATIONS

Identification Labels.....	8.2
Vehicle Loading.....	8.3
Dimensions and Weights.....	8.5
Subsystems.....	8.6
Wheels and Tires.....	8.8

ROADSIDE ASSISTANCE

About Roadside Assistance.....	9.2
Instructions for Transporters.....	9.3

CONSUMER INFORMATION

Disclaimers.....	10.2
Reporting Concerns.....	10.3



Interior Overview.....	1.2
Exterior Overview	1.3



1. Interior doors (page 2.4)
2. High beams (page 4.13)
Turn signals (page 4.14)
Wipers and washers (page 4.15)
3. Cruise control (page 4.23)
4. Steering wheel buttons - left (page 4.3)
5. Instrument panel (page 4.8)
6. Steering wheel buttons - right (page 4.4)
7. Gear selector (page 4.7)
8. Touchscreen (page 5.2)
NOTE: Touch **Controls** in the bottom left corner of the touchscreen to control Model S features such as doors, locks, and lights.
9. Glove box button (page 2.13)
10. Power window switches (page 2.7)
11. Exterior mirror adjustment switches (page 4.5)
12. Seats (page 3.2)
13. Steering column adjuster (page 4.3)
14. Horn (page 4.4)
15. Brakes (page 4.20)
16. Hazard warning lights (page 4.14)
17. Cabin climate control (page 5.8)
18. Cup holders (page 2.11)



1. Exterior lights (page 4.11)
2. Door handles (page 2.4)
3. Sunroof (page 2.12)
4. Charge port (page 6.5)
5. Exterior mirrors (page 4.5)

6. Front trunk (page 2.10)
7. Wheels and tires (page 8.8)
8. Rear view camera (page 4.24)
9. Rear trunk/liftgate (page 2.8)
10. Parking sensors - optional (page 4.16)



Doors

Keyless Locking and Unlocking	2.2
Using the Key	2.2
Using Exterior Door Handles	2.4
Using Interior Door Handles	2.4
Interior Locking and Unlocking	2.4
Child-protection Locks	2.5
Drive-away Locking	2.5
Walk-away Locking	2.5
Unlocking with a Dead Key Battery	2.5
Opening Interior Doors with No Power ...	2.6

Windows

Opening from the Exterior	2.7
Opening and Closing from the Interior	2.7
Locking Rear Windows	2.7

Rear Trunk

Opening	2.8
Closing	2.8
Adjusting the Opening Height	2.8
Interior Release	2.9
Opening with No Power	2.9

Front Trunk

Opening	2.10
Closing	2.10
Interior Emergency Release	2.11
Opening with No Power	2.11

Sunroof

Opening and Closing	2.12
---------------------------	------

Glove Box

Opening and Closing	2.13
---------------------------	------

Cup Holders

Opening and Closing	2.14
---------------------------	------



Keyless Locking and Unlocking

Model S has sensors that can recognize the presence of a key. The sensors are located at each end of the dash panel and behind the rear bumper, and have a range of approximately three feet (one meter).

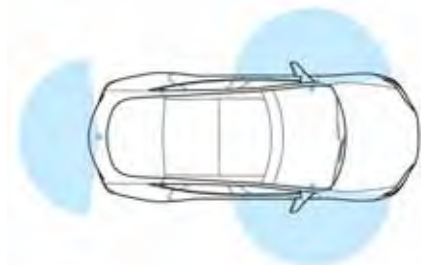

If Model S is equipped with the optional tech package, walking up to Model S when you have your key with you automatically unlocks the doors. Similarly, open the trunk by just walking up to Model S with your key with you and press the switch located under the trunk's exterior handle.

Press a door handle, and it extends. Or, if the AUTO-PRESENT HANDLES setting is turned on (see page 2.4), door handles extend automatically when Model S unlocks.

If you turn on the walk-away locking setting using the touchscreen, Model S locks when you walk away carrying your key with you (see page 2.5).

Using the Key

To quickly familiarize yourself with the key, think of the key as a miniature version of Model S, with the Tesla badge representing the front. The key has three buttons that feel like softer areas on the surface.



1. Trunk

- Double-click to open the rear trunk.
- If Model S is equipped with a powered liftgate, double-click to close the rear trunk. You can also single-click to stop the liftgate when it is moving.

2. Lock/Unlock All

- Double-click to unlock doors and the rear trunk. Hazard warning lights flash twice and door handles extend.
- Single-click to lock doors and trunks (all doors and trunks must be closed). Hazard warning lights flash once and door handles retract.
- Press and hold to lower all windows.

3. Front trunk (also called the “frunk”)

- Double-click to open the front trunk.

You do not need to point the key at Model S, but you must be within operating range (which varies depending on the strength of the key's battery). If Model S is unable to detect the key, the touchscreen displays a message indicating that a key is not inside. Place the key where Model S can best detect it, which is below the 12V power socket (see page 4.6).

Radio equipment on a similar frequency can affect the key. If this happens, move the key at least 30 cm away from other electronic devices (phone, laptop, etc).



If the key does not work, you may need to change its battery. If the key's battery is discharged, you can open Model S by following the unlocking procedure described on page 2.5.



CAUTION: Remember to bring the key with you when you drive. Although you can drive Model S away from its key, you will be unable to power it back on after it powers off.



CAUTION: Protect the key from impact, water damage and high temperatures. Avoid contact with solvents, waxes and abrasive cleaners.

Replacing the Key Battery

The key's battery lasts for approximately a year. When the battery is low, a message displays on the instrument panel. Follow these steps to replace it:

1. Place the key, button side down, on a soft surface.



2. Release the battery cover using a small flat bladed tool.



3. Remove the battery by pushing it toward the center of the key to release it from the front retaining clips.

4. Insert the new battery (type CR2032) with the '+' side facing up. Avoid touching the flat surfaces of the battery, and wipe the battery clean before fitting. Finger marks can reduce battery life.
5. Align the battery, then press the key and battery together until they snap into place.



Used batteries contain harmful substances. Seek advice on disposal from Tesla or your local authority.

Getting More Keys

If you lose a key or require an additional one, contact Tesla. Model S can recognize up to three keys.

When ordering a new key for Model S, take all available keys with you for reprogramming.



Using Exterior Door Handles

A light press on a door handle extends it, provided Model S detects a valid key nearby.

If Model S is equipped with the optional tech package, you can set the door handles to extend automatically whenever you approach the driver's side carrying the key. On the touchscreen, touch **Controls > Settings > Auto-Present Handles > On**.

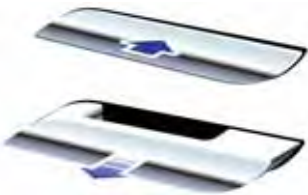

Insert your hand into the handle and pull to open the door.

Door handles retract if you do not use them within one minute after they extend. Just press a handle to extend it again. Door handles also retract a minute after the last door closes, when Model S begins moving, and when you lock Model S.

NOTE: To preserve battery life, Model is designed to temporarily disable the Auto-Present Handles feature when:

- The key has been out of range for more than 24 hours.
- The key remains within range for five minutes after all doors have been closed.

In these cases, extend the handles by touching the driver's door handle or pressing the unlock button on the key. There is no need to reset the setting. The next time you approach Model S, provided the above conditions do not apply, handles automatically extend.



Whenever a door is open, the Door Open indicator displays on the instrument panel. The image of the Model S on the touchscreen Controls window also shows which door or trunk is open.

Using Interior Door Handles

Pull the interior door handle toward you to open the door.



NOTE: To prevent children from opening rear doors using the interior handles, use the touchscreen (**Controls > Settings > Child Protection Locks**) to turn on the child-protection locks (see page 2.5).

Interior Locking and Unlocking

From inside Model S, you can use the touchscreen to lock or unlock doors and trunks, provided a valid key is inside the vehicle. Touch **Controls > Lock/Unlock**. The current lock status displays on the bottom left of the instrument panel.

NOTE: If a door or trunk is still open when you lock Model S, it locks when you close it.



Child-protection Locks

Model S has child-protection locks on the rear doors and liftgate to prevent them from being opened using interior handles. Use the touchscreen to turn child protection locks on or off. Touch **Controls > Settings > Child Protection Locks**.

NOTE: It is recommended that you turn child-protection locks on whenever children are seated in the rear seats.

Drive-away Locking

Model S can automatically lock all doors (including the trunks) whenever your driving speed exceeds 8 km/h. To turn this feature on or off, touch **Controls > Settings > Drive-Away Door Lock**.

Walk-away Locking

If Model S is equipped with the optional tech package, Model S doors and trunks can automatically lock whenever you walk away carrying the key.

To turn this feature on or off, touch **Controls > Settings > Walk-Away Door Lock**.

NOTE: If all doors are closed and you double-click the key to unlock Model S, walk-away locking is temporarily suspended until the next time you use the key to lock Model S. This allows you to keep Model S unlocked in your garage.

Unlocking with a Dead Key Battery

If Model S does not unlock when you walk up to it, or when you press the unlock button on your key, the key's battery may be dead. If this is the case, you can still unlock and drive Model S.

To unlock Model S (and disable the security alarm), position the key near the base of the passenger side windshield wiper, as shown.

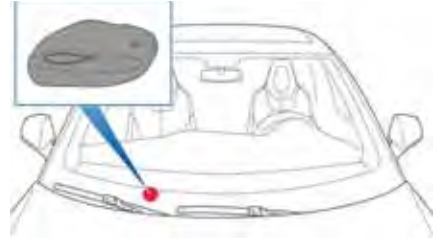

To drive Model S, place the key against the center console, immediately below the 12V power outlet, then press the brake pedal to turn Model S on.

For instructions on how to replace the key's battery, see page 2.3.

NOTE: Unlocking Model S using this method disables walk-away locking. You must manually re-enable walk-away locking after replacing the key's battery.



Opening Interior Doors with No Power

If Model S has no electrical power, front doors open as usual using the interior door handles. To open the rear doors, fold back the edge of the carpet below the rear seats to expose the mechanical release cable. Pull the mechanical release cable toward the center.

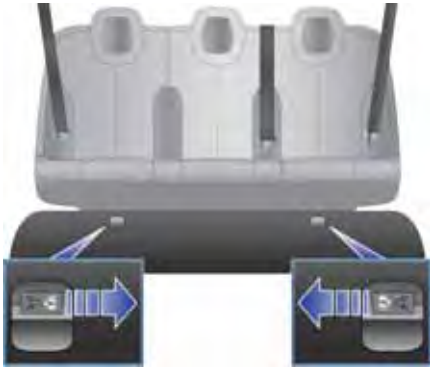



Opening from the Exterior

To open windows from outside Model S, press and hold the unlock button on the key.



Opening and Closing from the Interior

Press down on a switch to lower the associated window all the way down. Window switches operate at two levels. To lower a window partially, hold the switch and release when the window is at the desired position.



Similarly, pull a switch to raise the associated window. This also operates at two levels—when raising, hold the switch and release when the window is at the desired position.

⚠ WARNING: Before closing a power window, it is the driver's responsibility to ensure that all occupants, especially children, do not have any body parts extended through the window's opening. Failure to do so can cause serious injury.

⚠ WARNING: When leaving Model S, always take your key with you. Leaving the key in Model S allows all doors, windows, and controls

to be fully operational and can cause hazardous, unauthorized or unintentional use of Model S.

Locking Rear Windows

To prevent passengers from using the rear window switches, press the rear window lock switch. The switch light turns on. To unlock rear windows, press the switch again.



⚠ WARNING: To ensure safety, it is recommended that you lock the rear windows whenever children are seated in the rear seats.

⚠ WARNING: Never leave children unattended in Model S.



Opening

To open the rear trunk, do one of the following:

- Touch **Controls > Trunk** on the touchscreen.
- Double-click the Trunk button on the key.
- Press the switch located under the exterior handle (if not equipped with the optional tech package, you must first unlock Model S).



 When the liftgate is open, the instrument panel displays the Door Open indicator light. The image of the Model S on the touchscreen Controls window also displays the open trunk.

To stop a powered liftgate while it is moving, single-click the Trunk button on the key. Then, when you double-click the Trunk button, it moves again, but in the opposite direction (provided it was not almost entirely open or closed when you stopped it). For example, if you single-click to stop the liftgate while it is opening, when you double-click, it closes.

To open the trunk in the unlikely situation in which Model S has no electrical power, see page 2.9.

Closing

To close the trunk, pull down on the liftgate and push firmly, ensuring it is fully closed.

If Model S is equipped with the optional tech package, you can close the powered liftgate by:

- Double-clicking the trunk button on the key.
- Touching **Controls > Trunk** on the touchscreen.
- Pressing the switch located on the underside of the liftgate (see page 2.8).

If a powered liftgate senses an obstruction when closing, it automatically opens and sounds two chimes. Remove the obstruction and try closing it again. If it cannot close the second time, powered operation is temporarily disabled. Manually closing it restores powered operation.

NOTE: The power closing feature is also temporarily disabled if you leave the powered liftgate open for more than an hour.

Adjusting the Opening Height

If Model S is equipped with a powered liftgate, you can adjust its opening height to make it easier to reach:

1. Open the liftgate, then lower it to the desired opening height.



2. Press and hold the button on the underside of the liftgate for 2 seconds until you hear a confirmation beep.
3. Confirm that you have set it to the desired height by closing the liftgate, then reopening it.



Interior Release

To open the trunk from inside Model S, press the interior release switch and push the liftgate up.



If Model S is equipped with the optional tech package, you do not need to push it up. When you press the release switch, it opens, and when you pull the switch, it closes.

NOTE: The interior release switch is disabled if the child-protection locks are turned on (see page 2.5), or if Model S is moving.

Opening with No Power

If Model S has no electrical power, you can open the rear trunk from inside. Use the mechanical release cable located on the underside of the liftgate, next to the interior light.



1. Remove the cover by pulling its lower edge very firmly toward you.
2. Pull the cable to release the latch.
3. Push the liftgate open.



Opening

To open the front trunk:

- Touch **Controls > Front Trunk** on the touchscreen, or double-click the front trunk button on the key.
- Pull the hood up.



The door open indicator displays on the instrument panel when the front trunk is open. The image of the Model S on the touchscreen Controls window also displays the open trunk.

To open the front trunk in the unlikely situations where Model S has no electrical power, see page 2.11.

Closing

Lower the hood, then place both hands on the front of the hood as shown. Press down firmly with both hands to engage the latches. Lift the front edge of the hood to ensure it is fully closed.



 **WARNING:** Slamming or dropping the hood can cause damage, and does not ensure that it is properly closed.

 **WARNING:** Do not drive with the hood secured by the secondary catch alone.



Interior Emergency Release

An interior release button inside the front trunk allows a person locked inside to get out. This release button is active whenever Model S is stationary.



Press the interior release button to open the front trunk, then push up on the hood.

NOTE: The button glows for several hours after a brief exposure to ambient light.

Opening with No Power

If Model S has no electrical power, or if you are unable to open the front trunk using the touchscreen or key, pull the mechanical release lever located below the glove box. This releases the primary catch.



Then push down on the secondary catch lever and lift the hood. You may need to push the hood down slightly to release the pressure against the secondary catch.





Opening and Closing

If your Model S is equipped with a sunroof, touch **Controls > Sunroof** on the touchscreen to operate it. Drag, or tap on, the sunroof slider bar, or touch the image of the sunroof and drag it. The sunroof moves to the selected position.



Touch **OPEN** once to open the sunroof to its comfort position (80% open to minimize wind noise). Or, move the sunroof to the comfort position by dragging the slider bar to the indent position. If you find wind noise (which varies depending on driving speed) excessive, even with the sunroof in the comfort position, open a window slightly.

Touch **OPEN** twice to open the sunroof fully.

Touch **CLOSE** to fully close the sunroof.

If the sunroof's safety mechanism detects any obstruction, it does not close. If, after removing the obstruction, it still does not close, touch and hold **CLOSE** to override the sunroof's anti-trap mechanism.

Touch **VENT** to open the sunroof slightly.

To stop the sunroof from moving at any time, touch the image of the sunroof.

 **WARNING:** Do not allow occupants to extend any part of their body through the sunroof. Doing so can cause serious injury from flying debris, tree branches, or other obstructions.

 **WARNING:** Before closing the sunroof, ensure that occupants, especially children, do not have any body part extended through the sunroof opening. Failure to do so can cause serious injury.

 **CAUTION:** Remove snow and ice before opening the sunroof. Opening a sunroof covered in snow and ice can cause damage.

 **CAUTION:** Do not carry objects in Model S that protrude through the sunroof. Doing so can damage the sunroof's seals and anti-trap mechanism.



Opening and Closing

To open the glove box, press the switch located to the right of the touchscreen. If you leave the glove box open for five minutes, its light automatically turns off.

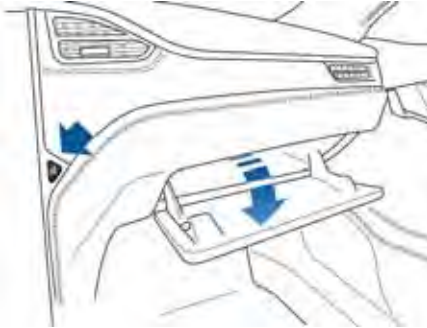

NOTE: The glove box locks whenever Model S is locked externally, using the key or walk-away locking. It does not lock when Model S is locked using the touchscreen.



WARNING: When driving, keep the glove box closed to prevent injury to a passenger if a collision or sudden stop occurs.



Opening and Closing

To expose a cup holder, slide back the armrest.





Front and Rear Seats

Correct Driving Position	3.2
Adjusting the Driver's Seat.....	3.2
Folding Rear Seats.....	3.3
Raising Rear Seats	3.3
Head Supports.....	3.3
Seat Covers.....	3.3

Seat Belts

Wearing Seat Belts	3.4
Wearing Seat Belts When Pregnant	3.4
Seat Belt Pre-tensioners.....	3.5
Testing Seat Belts	3.5
Seat Belt Warnings.....	3.6

Child Safety Seats

Guidelines for Seating Children	3.7
Choosing a Child Safety Seat	3.7
Seating Larger Children.....	3.8
Installing Child Safety Seats.....	3.8
Installing Seat Belt Retained Child Seats	3.8
Installing ISOFIX Child Seats.....	3.9
Attaching Upper Tether Straps	3.10
Testing a Child Safety Seat	3.10
Warnings - Child Safety Seats.....	3.10

Tesla Built In Rear Facing Child Seats

Usage Restrictions	3.11
Opening.....	3.11
Folding.....	3.12
Seating a Child	3.13
Warnings - Tesla Child Seats	3.14

Airbags

Location of Airbags.....	3.15
How the Airbags Work.....	3.16
Types of Airbags	3.16
Disabling the Front Passenger Airbag... ..	3.17
Inflation Effects	3.18
Airbag Warning Indicator	3.18
Airbag Warnings.....	3.18



Correct Driving Position

The seat, head support, seat belt and airbags work together to maximize your safety. Using these correctly ensures greater protection.



Position the seat so you can wear the seat belt correctly, while being as far away from the front airbag as possible:

1. Sit upright with both feet on the floor and the seat back reclined no more than 30 degrees.
2. Make sure you can easily reach the pedals and that your arms are slightly bent when holding the steering wheel. Your chest should be at least 25 cm from the center of the airbag cover.
3. Place the shoulder section of the seat belt mid-way between your neck and your shoulder. Fit the lap section of the belt tightly across your hips, not across your stomach.

Model S seats include integrated head supports that cannot be adjusted or removed.

Adjusting the Driver's Seat



1. Adjust lumbar support.
2. Adjust backrest.
3. Move seat forward/backward.
4. Adjust the seat's height and tilt angle.

! **WARNING:** Do not adjust seats while driving. Doing so increases the risk of a collision.

! **WARNING:** Riding in a moving vehicle with the seat back reclined can result in serious injuries in a collision, as you could slide under the lap belt or be propelled into the seat belt. Ensure your seat back is reclined no more than 30 degrees when the vehicle is moving.



Folding Rear Seats

Model S has a split rear seat that can fold forward.

Before folding, remove items from the seats and the rear foot well. To allow the rear seat backs to fold completely flat, you may need to move the front seats forward.

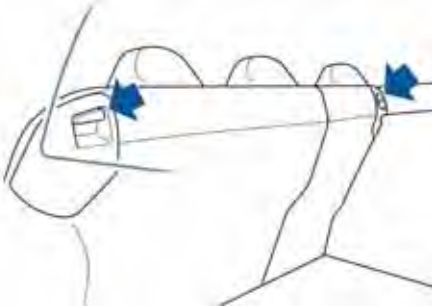

To fold a rear seat, press the corresponding lever and fold the seat forward.



Raising Rear Seats

Before raising a rear seat, make sure that the seat belts are not trapped behind the backrest.

Pull the seat back upward until it locks into place.

To confirm that the seat back is locked in the upright position, try pulling it forward.

⚠ WARNING: Always ensure the seat backs are locked in their upright position. Failure to do so increases the risk of injury.

Head Supports

Seats include integrated head supports that cannot be adjusted or removed.

Seat Covers

Do not use seat covers on Model S. Doing so could restrict deployment of the side air bags if an accident occurs. It can also reduce the accuracy of the occupant detection system.



Wearing Seat Belts

Using seat belts and child safety seats is the most effective way to protect occupants if a collision occurs. Therefore, wearing a seat belt is required by law in most jurisdictions.

Both the driver and passenger seats are equipped with three-point inertia reel seat belts. Inertia reel belts are automatically tensioned to allow occupants to move comfortably during normal driving conditions.

The seat belt reel automatically locks to prevent movement of occupants if Model S experiences a force associated with hard acceleration, braking, cornering, or an impact in a collision.



The seat belt reminder on the instrument panel alerts you if a seat belt for an occupied seat is not fastened. If the belt remains unfastened, the reminder flashes and an intermittent chime sounds. If all occupants are buckled up and the reminder stays on, re-fasten seat belts to ensure they are correctly latched. Also remove any heavy object (such as a briefcase) from an unoccupied seat. If the reminder light continues to stay on, contact Tesla.

To Fasten a Belt

1. Ensure correct positioning of the seat (for correct driving position, see page 3.2).



2. Draw the belt out smoothly, ensuring the belt lays flat across the pelvis, chest and mid-point of your collar bone, between the neck and shoulder.
3. Insert the latch plate into the buckle and press together until you hear a “click” indicating it is locked in place.

4. Pull the belt to check that it is securely fastened.
5. Pull the diagonal part of the belt toward the reel to remove excess slack.

To Release a Belt

Hold the belt near the buckle to prevent the belt from retracting too quickly, then press the button on the buckle. The belt retracts automatically. Ensure there is no obstruction that prevents the belt from fully retracting. The belt should not hang loose. If a seat belt does not fully retract, contact Tesla.

Wearing Seat Belts When Pregnant

Do not put the lap or shoulder sections of the seat belt over the abdominal area. Wear the lap section of the belt as low as possible across the hips, not the waist. Position the shoulder portion of the belt between the breasts and to the side of the abdomen. Consult your doctor for specific guidance.



WARNING: Never place anything between you and the seat belt to cushion the impact in the event of an accident.



Seat Belt Pre-tensioners

The front seat belts are equipped with pre-tensioners that work in conjunction with the airbags in a severe frontal collision. The pre-tensioners automatically retract both the seat belt anchor and the seat belt webbing, reducing slack in both the lap and diagonal portions of the belts, resulting in reduced forward movement of the occupant.



If the pre-tensioners and airbags did not activate in an impact, this does not mean they malfunctioned. It usually means that the strength or type of force needed to activate them was not present.

⚠ WARNING: Once the seat belt pre-tensioners have been activated, they must be replaced. After any accident, have the airbags, seat belt pre-tensioners and any associated components checked and, if necessary, replaced.

Testing Seat Belts

To confirm that seat belts are operating correctly, perform these three simple checks on each seat belt.

1. With the seat belt fastened, give the webbing nearest the buckle a quick pull. The buckle should remain securely locked.
2. With the belt unfastened, unreel the webbing to its limit. Check that unreeling is free from snags, and visually check the webbing for wear. Allow the webbing to retract, checking that retraction is smooth and complete.
3. With the webbing half unreeled, hold the tongue plate and pull forward quickly. The mechanism should lock automatically and prevent further unreeling.

If a seat belt fails any of these tests, contact Tesla immediately.

For information about cleaning seat belts, see page 7.13.





Seat Belt Warnings

 **WARNING:** Seat belts should be worn by all occupants for every journey no matter how short. Failure to do so increases the risk of injury or death if an accident occurs.

 **WARNING:** Secure small children in a suitable child safety seat (see page 3.7). Always follow the child safety seat manufacturer's instructions when installing.

 **WARNING:** Ensure that all seat belts are worn correctly. An improperly worn seat belt increases the risk of injury or death if an accident occurs (see page 3.4).

 **WARNING:** Do not wear seat belts over hard, fragile or sharp items in clothing, such as pens, keys, eyeglasses, etc. The pressure from the seat belt on such items can cause injury.

 **WARNING:** Seat belts should not be worn with any part of the strap twisted.

 **WARNING:** Each seat belt assembly must be used by one occupant only. It is dangerous to put a seat belt around a child being carried on an occupant's lap.

 **WARNING:** Seat belts that have been worn in an accident must be inspected or replaced by Tesla, even if damage to the assembly is not obvious.

 **WARNING:** Seat belts that show signs of wear (such as fraying) or have been cut or damaged in any way, must be replaced by Tesla.

 **WARNING:** Avoid contaminating a seat belt's components with any chemicals, liquids, grit, dirt or cleaning products. If a seat belt fails to retract or latch into the buckle, it must be replaced immediately. Contact Tesla.

 **WARNING:** Do not make modifications or additions that can prevent a seat belt mechanism from taking up slack, or that can prevent a seat belt from being adjusted to remove slack. A slack belt greatly reduces occupant protection.

 **WARNING:** Do not make modifications that can interfere with the operation of a seat belt, or that can cause a seat belt to become inoperable.

 **WARNING:** When seat belts are not in use, they should be fully retracted and not hanging loose. If a seat belt does not fully retract, contact Tesla.



Guidelines for Seating Children

You must restrain infants and small children using a child safety seat appropriate for the child's age, weight, and size. Carefully follow the instructions provided by the manufacturer of the child safety seat. Never use child safety seats in the front row passenger seat.

If your Model S is equipped with Tesla built in rear facing child seats, these seats are child safety seats and are designed only for children within a specific height and weight range (see page 3.11).

Refer to the tables below for guidelines on the type of seatbelt installed and ISOFIX installed child restraint you should use based on the weight of the child.

Seatbelt Installed Child Restraints

Mass Group		Front Passenger	Rear Outboard	Rear Centre
Group 0	up to 10 kg	L	U	U
Group 0+	up to 13 kg	L	U	U
Group 1	9 - 18 kg	UF*	U, UF	U, UF
Group II	15 - 25 kg	UF*	U, UF	U, UF
Group III	22 - 36 kg	UF*	U, UF	U, UF

U: Universal rear facing child restraint
 UF: Universal forward facing child restraint
 L: Suitable for these particular child restraints - Maxi-Cosi Cabrio/Cabriofix E4 04443517 or Takata Mini E4 04443717
 *: Seat must be placed in rearmost highest position

ISOFIX Installed Child Restraints

Mass Group			Vehicle ISOFIX Position		
			Size Class	Fixture	Rear Outboard
Group 0	up to 10 kg	E	R1	IL	IL
		E	R1	IL	IL
Group 0+	up to 13 kg	D	R2	IL	IL
		C	R3	IL	IL
		D	R2	U, UF	IL
Group 1	9 - 18 kg	C	R3	U, UF	IL
		B	F2	IUF	IUF
		B1	F2x	IUF	IUF
		A	F3	IUF	IUF
		A	F3	IUF	IUF

IL: Suitable for any semi-universal child restraint (any rear or forward facing restraint with support leg)
 IUF: Suitable for any universal child restraint (forward facing with tether)

NOTE: If the combined weight of the child and the child safety seat is over 29 kg, Tesla recommends attaching the safety seat using the seat belt and upper tether strap. In addition to safety, this has the added benefit of ensuring the seat belt reminder does not stay lit. Always follow the seat belt manufacturer's instructions when installing child safety seats.



Seating Larger Children

If a child is too large to fit into a child safety seat, but too small to safely fit into the standard seat belts, use a booster seat appropriate for the child's age and size. Carefully follow the manufacturer's instructions to secure the booster seat using the seat belts. Do not use the ISOFIX system to secure booster seats, even in situations where the booster seat is equipped with the ISOFIX system.

Installing Child Safety Seats

There are two general methods used to install child safety seats:

- Seat belt retained - these seats are secured using the vehicle's seat belts (see page 3.8).
- ISOFIX* retained - these seats can attach to anchor bars built into the vehicle's rear seats (see page 3.9).

Check the child safety seat manufacturer's instructions and the table on page 3.7 to determine which installation method to use. Some child safety seats can be installed using either method. Always follow the child safety seat manufacturer's instructions.

Installing Seat Belt Retained Child Seats

First, make sure that the child falls into the correct weight range for the seat.

Avoid dressing the child in bulky clothing and do not place any objects between the child and the restraint system.

Adjust harnesses for every child, every trip.

Always follow the detailed instructions provided by the child safety seat manufacturer. General guidelines are provided below.

1. Place the child safety seat in Model S, route the seat belt, and secure the buckle in accordance with the child safety seat manufacturer's instructions.



2. Allow the seat belt to retract, and remove all slack in the seat belt while firmly pushing the child safety seat into the Model S seat.
3. If the seat belt retained child safety seat has an upper tether, attach it to the back of the seat (see page 3.10).



Installing ISOFIX Child Seats

Lower ISOFIX anchor points are provided at all three second row seating positions and are located between the seat back rest and rear cushion. The exact location of each anchor point is indicated by the child safety seat identification tab on the seat.



Although ISOFIX anchor points are provided at all three rear seating positions, you can only use two at the same time. To seat three children, use a non-ISOFIX retained seat in the middle. When installing two ISOFIX retained child safety seats, you cannot install them adjacent to each other with one in the middle and the other on the left (driver's side).



To install a ISOFIX retained child safety seat, slide the safety seat latches onto the anchor bars until they click into place. Carefully read and follow the instructions provided by the child safety seat manufacturer.



Once installed, test the security of the installation before seating a child. Attempt to twist the child safety seat from side to side and try to pull it away from the seat, then check that the anchors are still securely in place.



Attaching Upper Tether Straps

If an upper tether strap is provided, attach its hook to the anchor point located on the back of the rear seats. Always position the strap so that it runs over the center of the Model S head support, except in cases where you are installing a ISOFIX retained child safety seat in the center position—in this case, run the strap over the left hand side of the head support, as shown. Tighten according to the child safety seat manufacturer's instructions.



RUN THE TETHER STRAP OVER THE CENTER OF THE HEAD SUPPORT EXCEPT WHEN INSTALLING A LATCH-RETAINED (ISOFIX-RETAINED) CHILD SAFETY SEAT IN THE CENTER

NOTE: To prevent the strap from moving from side to side, the top of the head support deforms.

Testing a Child Safety Seat

Before seating a child, always make sure the child safety seat is not loose:

1. Hold the child safety seat by the belt path and try to slide the safety seat from side to side and front to back.
2. If the seat moves more than 2.5 cm, it is too loose. Tighten the belt or reconnect the ISOFIX retained child safety seat.
3. If you are unable to reduce slack, try a different seat location or try another child safety seat.

Warnings - Child Safety Seats

! **WARNING:** Do not allow a baby or infant to be held on a lap. All children should be restrained in an appropriate child safety seat at all times.

! **WARNING:** To ensure children are safely seated, follow all instructions provided in this document and by the manufacturer of the child safety seat.

! **WARNING:** Children should ride in a rear facing child safety seat using the seat's integrated 5 point harness for as long as possible.

! **WARNING:** When seating larger children, make sure the child's head is supported and the child's seat belt is properly adjusted and fastened. The shoulder portion of the belt must be away from the face and neck, and the lap portion must not be over the stomach.

! **WARNING:** Never attach two child safety seats to one anchor point. In a collision, one anchor point may not be strong enough to secure both seats.

! **WARNING:** Child safety seat anchors can withstand loads resulting only from correctly fitted child safety seats. Do not use these anchors for any other purpose.

! **WARNING:** Always check harnesses and tether straps for damage and wear.

! **WARNING:** Never leave a child unattended in Model S, even if the child is secured in a child safety seat.

! **WARNING:** Never use a child safety seat that has been involved in an accident. Have the seat inspected or replaced as a described in the child safety seat manufacturer's instructions.



Usage Restrictions

The Tesla built in rear facing child seats are child restraint systems and are approved to United Nations ECE Regulation R44.04 standards for use by children in Mass Groups II and III, weighing 15 - 36 kg. These seats must only be used for children who are between 3 and 12 years old, and 98 - 135 cm tall.

Always ensure the top of the child's head cannot contact the vehicle and that the child is seated comfortably with the seat belts positioned and latched correctly. The child's pelvis must be held securely in place by the lap belt. Follow all instructions provided and **do not use supplemental child safety seats in these seats.**

NOTE: To draw more air into the rear seating areas, it is recommended that whenever a child is seated in the Tesla built in rear facing child seats, you set the climate control system to draw outside air into Model S, instead of recirculating the air. See page 5.9.

Opening

1. Remove the cover from the trunk floor and pull the strap to lift the seat assembly upward:

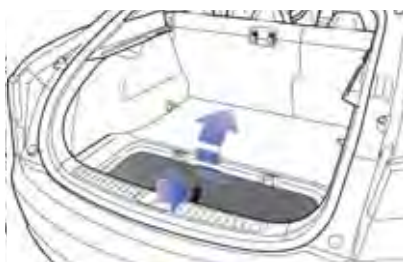

2. Push the seat assembly into position:



3. Undo the Velcro strap:

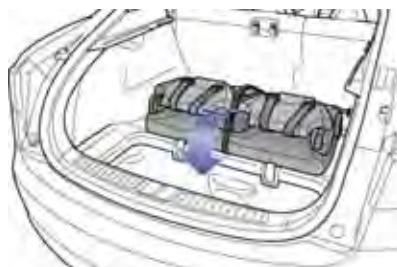

4. Pull the handle to release the head supports from the seat back, then pull the head supports toward you to unfold them:

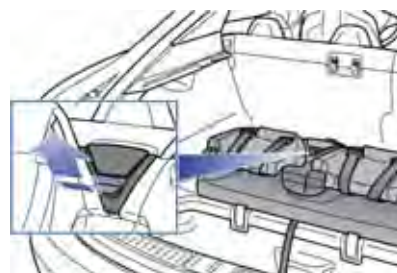

5. Raise the seat back to the upright position and push until it locks into position. Visually check to ensure that the retaining catches are engaged:

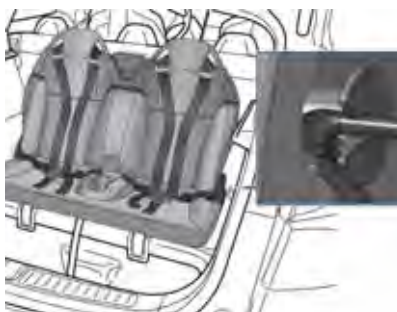

6. Check that the seat back and seat base are securely retained in the upright position by trying to pull the seat back toward you.



Folding



CAUTION: Before folding the seats, fasten the seat belts to prevent them from getting trapped in the seat mechanism and being damaged.

1. Pull the handle to release the seat back and pull the seat back fully forward:

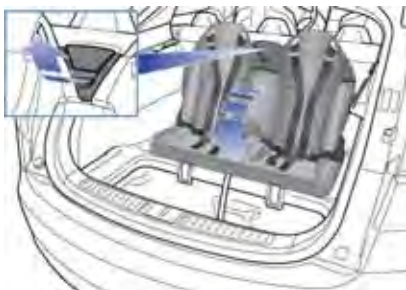

2. Push the lever to release the head supports from the seat back, then fold back onto the seat:

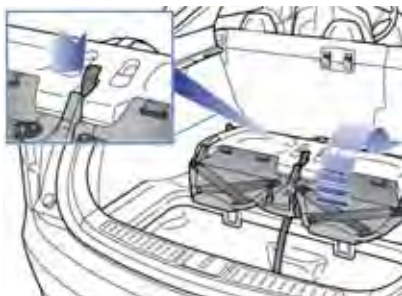

3. Secure the Velcro strap:

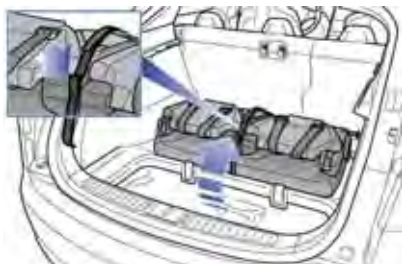

4. Pull the strap at the rear of the seat to fold the seat assembly into the trunk floor:

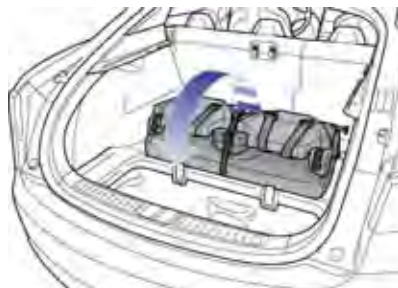

5. Replace the cover on the trunk floor:

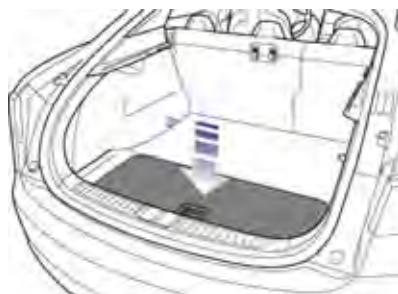



Seating a Child

The Tesla built in rear facing child seats are child restraint systems and are approved to United Nations ECE Regulation R44.04 standards for use by children in Mass Groups II and III, weighing 15 - 36 kg. These seats must only be used for children who are between 3 and 12 years old, and 98 - 135 cm tall.

Always ensure the top of the child's head cannot contact the vehicle and that the child is seated comfortably with the seat belts positioned and latched correctly. Follow all instructions provided and do not use supplemental child safety seats in these seats.

NOTE: To draw more air into the rear seating areas, it is recommended that whenever a child is seated in the Tesla built in rear facing child seats, you set the climate control system to draw outside air into Model S, instead of recirculating the air. See page 5.9.

1. Position the child in the seat with arms through the loops of the seat belts.
2. Connect the two halves of the seat belt tongue.
3. Insert the seat belt tongue latch into the buckle and ensure it is securely fastened.

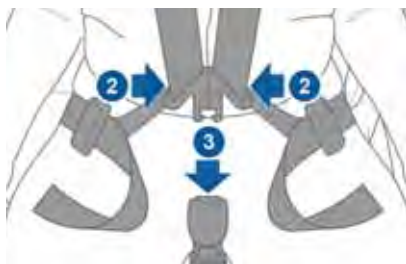

4. Adjust the shoulder belts so they run over the top of the child's shoulders and away from the face.
5. Adjust the length of the buckle to ensure the lower straps sit low on the child's pelvis. The child's pelvis must be held firmly in place.
6. Pull the lower straps until the child is securely held in the seat.

7. Slide the shoulder clips into place to ensure the upper portion of the belts remain positioned over the child's shoulders.





To release, press the button on the buckle, and separate the two halves of the seat restraint.





Warnings - Tesla Child Seats

 **WARNING:** The Tesla built in rear facing seats are child restraint systems and are approved to United Nations ECE Regulation R44.04 standards for use by children in Mass Groups II and III, weighing 15 - 36 kg. These seats must only be used for children who are between 3 and 12 years old, and 98 - 135 cm tall, provided the top of the child's head cannot contact the interior.

 **WARNING:** Do not use supplemental child restraint systems, including booster seats, in the Tesla built in rear facing child seats.

 **WARNING:** Always ensure that the top of the child's head cannot touch the headliner and that the child is seated comfortably with the seat belts correctly fastened.

 **WARNING:** Follow all instructions and heed all warnings related to the Tesla built in rear facing child seats. Failure to do so can compromise occupant safety.

 **WARNING:** Read all safety warnings and labels attached to the seats.

 **WARNING:** Do not leave children unattended in Model S, even if the child is secured in a child safety seat or a Tesla built in rear facing child seat. In hot weather, the interior temperature can reach dangerous levels that can result in dehydration, serious injury or death.

 **WARNING:** Do not remove or replace the fabric on a Tesla built in rear facing child seat. The covers are an integral part of the restraint's performance and should not be removed or replaced with any other type than those supplied by Tesla.

 **WARNING:** If the Tesla built in rear facing child seats have been worn in an accident, they must be inspected or replaced by Tesla, even if damage is not obvious.

 **WARNING:** Before allowing a child to ride in the Tesla built in rear facing child seats, check that the seat is securely held in the upright position by trying to pull the seat back toward you.

 **WARNING:** Do not remove the built in rear facing child seats for any reason, including cleaning. To ensure safety of occupants, removal and installation must be performed by qualified Tesla service technicians.

 **WARNING:** Do not make modifications or additions that can interfere with the operation of the Tesla built in rear facing child seats.

 **WARNING:** To prevent injury, ensure all loose items (bags, luggage, etc) are secured. In an accident, or during hard braking and sharp turns, loose items could cause injury.



Location of Airbags

Airbags are located in the approximate areas shown here. Airbag warning information is printed on the sun visors.

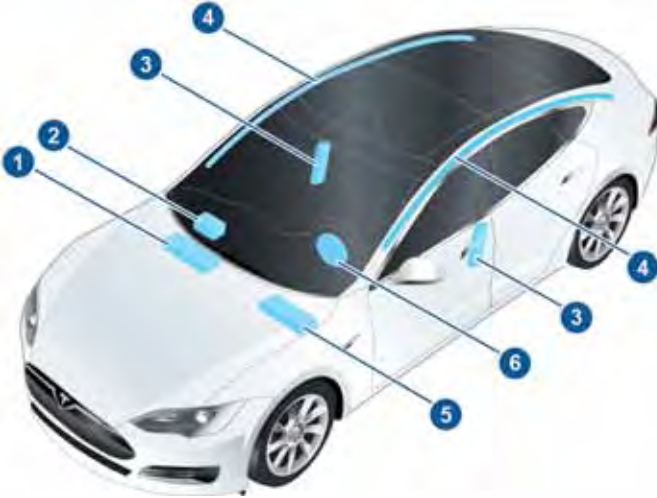

1. Passenger knee airbag
2. Passenger front airbag
3. Side airbags
4. Curtain airbags
5. Driver's knee airbag
6. Driver's front airbag



How the Airbags Work

Inflation of airbags depends on the rate at which the vehicle's cabin changes speed in a collision. The rate of deceleration determines whether airbags inflate.

Airbags inflate instantly with considerable force accompanied by a loud noise. The inflated bag, together with the seat belts, limits movement of occupants to reduce the risk of injury.

Front airbags are not ordinarily designed to inflate in rear collisions, rollovers, minor front or side collisions, heavy braking, or driving over bumps and potholes. Therefore, significant superficial damage can occur to the vehicle without the airbags inflating or, conversely, a relatively small amount of structural damage can cause airbags to inflate.

If you are planning to modify your vehicle for a person with disabilities in a way that may affect the airbag system, contact Tesla.

Types of Airbags

Advanced front airbags	The front airbags are advanced airbags designed to reduce airbag related injuries to children or small adults who ride in front. On the driver's side, the front airbag works with a seat position sensor that adjusts the inflation level based on the seating position of the occupant. For safety of infants and small children, the front passenger airbag can be disabled as described on page 3.17.
Knee airbags	Knee airbags and the front airbags work together. The knee airbags limit the forward motion of the front seat occupants by restricting leg movement, thereby positioning the occupants so that the front airbags work more effectively.
Side airbags	Side airbags protect the thorax region of the torso and the pelvis and inflate only if a severe side impact occurs. Airbags on the non-impacted side do not inflate.
Curtain airbags	Curtain airbags help protect the head and ordinarily inflate only if a severe side impact occurs or if the vehicle rolls over. The airbags on the non-impacted side do not inflate.



Disabling the Front Passenger Airbag

When a child is seated in the front passenger seat (even though the child is seated in a child safety seat or booster seat), you must ensure the front passenger airbag is turned off. This prevents the airbag from injuring the child if a collision occurs.

NOTE: Rear seats are the preferred location for seating children in child safety seats.

To turn the passenger airbag on or off, touch **Controls > Settings > Safety & Security > Passenger Airbag**.



The ON/OFF status of the front passenger airbag displays in the upper right corner of the touchscreen.



You can also turn the passenger airbag on or off by touching the status indicator, shown above.

If the status shows the airbag as on, even if you have turned it off (or vice versa), contact Tesla immediately.

NOTE: Model S has a capacitive touchscreen and may not respond to your touch if you are wearing standard gloves. If the touchscreen is not responding, remove gloves or wear gloves with conductive fingertips for use with capacitive touchscreens.

WARNING: If the control for the passenger airbag does not appear to be functioning, do not seat any passenger in the front seat. Contact Tesla immediately to have the vehicle inspected and if necessary, repaired.

WARNING: Never seat a child in a child safety seat or a booster seat on the front passenger seat when the airbag is activated. Doing so can cause serious injury or death.

WARNING: Do not use seat covers on Model S. Doing so could restrict deployment of the side air bags if an accident occurs. It can also reduce the accuracy of the occupant detection system.



Inflation Effects

When airbags inflate, a fine powder is released. This powder can irritate the skin and should be thoroughly flushed from the eyes and from any cuts or abrasions.

After inflation, the airbags deflate to provide a gradual cushioning effect for the occupants and to ensure the driver's forward vision is not obscured.

If airbags have inflated, or if your vehicle has been in an accident, always have the airbags, seat belt pre-tensioners and any associated components checked and, if necessary, replaced by Tesla.

In a collision, in addition to the airbags inflating:

- Doors unlock and the door handles extend.
- Hazard warning lights turn on.
- Interior lights turn on.
- High voltage is disabled.

To restore Battery power, use the touchscreen to manually power off Model S (see page 4.6), then press the brake to power it back on again.

Airbag Warning Indicator



The airbag indicator on the instrument panel remains lit if the airbag system is malfunctioning. The only time this indicator should light up is briefly when Model S first starts up, in which case it turns off within a few seconds. If it remains lit, contact Tesla immediately and do not drive.

Airbag Warnings



All occupants, including the driver, should always wear their seat belts whether or not an airbag is also provided at their seating position to minimize the risk of severe injury or death in the event of a crash.



Front seat occupants should not place their arms over the airbag module, as an inflating bag can cause fractures or other injuries.



WARNING: Do not use seat covers on Model S. Doing so could restrict deployment of the side air bags if an accident occurs. It can also reduce the accuracy of the occupant detection system.



WARNING: Airbags inflate with considerable speed and force, which can cause injury. To limit injuries, ensure that occupants are wearing seat belts and are correctly seated, with the seat positioned as far back as possible.



WARNING: Do not use a child safety seat or seat young children on a seat with an operational airbag in front of it. Doing so can cause injury or death if the airbag inflates.



WARNING: To ensure correct inflation of the side airbags, maintain an unobstructed gap between an occupant's torso and the side of Model S.



WARNING: Passengers should not lean their heads against the doors. Doing so can cause injury if a curtain airbag inflates.



WARNING: Do not allow passengers to obstruct the operation of an airbag by placing feet, knees or any other part of the body on or near an airbag.



WARNING: Do not attach or place objects on or near the front airbags, the side of the front seats, the headliner at the side of the vehicle, or any other airbag cover that could interfere with inflation of an airbag. Objects can cause serious injury if the vehicle is in a crash severe enough to cause the airbag to inflate.



WARNING: Following inflation, some airbag components are hot. Do not touch until they have cooled.



Driver Profiles

Creating a Driver Profile	4.2
Restoring a Driver's Profile	4.2
Saved Driver Settings	4.2

Steering Wheel

Adjusting Position	4.3
Adjusting Sensitivity	4.3
Using Left Steering Wheel Buttons	4.3
Using Right Steering Wheel Buttons	4.4
Horn	4.4

Mirrors

Adjusting Exterior Side Mirrors	4.5
Rear View Mirror	4.5

Starting and Powering Off

Starting Model S	4.6
Powering Off	4.6

Gears

Shifting Gears	4.7
Leaving Model S in Neutral (Tow Mode)	4.7

Instrument Panel

Instrument Panel Overview	4.8
Indicator Lights	4.9

Lights

Controlling Lights	4.11
Headlight High Beams	4.12
Headlights After Exit	4.13
Cornering Lights	4.13
Turn Signals	4.14
Hazard Warning Flashers	4.14

Wipers and Washers

Wipers	4.15
Washers	4.15

Park Assist

How Park Assist Works	4.16
Visual and Audio Feedback	4.16
Controlling Audible Feedback	4.17
Limitations and False Warnings	4.17
Other Parking Aids	4.17

Trip Information

Displaying Trip Information	4.18
-----------------------------------	------

Energy Usage

Displaying Energy Usage	4.19
Driving Tips to Maximize Range	4.19

Brakes

Braking Systems	4.20
Brake Wear	4.20
Regenerative Braking	4.21
Parking Brake	4.21

Traction Control

How It Works	4.22
--------------------	------

Cruise Control

Operating Cruise Control	4.23
Changing the Cruising Speed	4.23
Canceling and Resuming	4.23

Rear View Camera

Camera Location	4.24
-----------------------	------



Creating a Driver Profile

If Model S is equipped with the optional tech package, you only need to adjust Model S once. When you first adjust the driver's seat, steering wheel, or driver's side mirror, the touchscreen prompts you to create a driver profile. Your profile saves the position of the seat, steering wheel, and driver's side mirror, as well as several other preferences you make using the touchscreen's Settings window (**Controls > Settings**).

You can also add a driver profile by touching **Controls > Settings > Driver Profiles**. Then enter the name of the driver and touch **Create Profile**.

If you change the position of the steering wheel, driver's seat, or driver's side mirror after you have saved a profile, the touchscreen prompts you to save the new position or restore the previously saved position (other preferences are automatically saved). To use a setting without saving or restoring, just ignore the prompt.

Restoring a Driver's Profile



To adjust Model S based on a driver's profile, touch the driver profile icon, located to the left side of the Tesla "T" on the touchscreen's status bar. Then choose the driver and the saved adjustments are automatically made.

Saved Driver Settings

To see what settings are associated with your driver profile, touch **Controls > Settings > Driver Profiles**. Then touch the **See what's saved** link. A popup window displays the settings that are associated with a driver profile. These settings vary depending on the version of software currently running in Model S.



Adjusting Position

Adjust the steering wheel to the desired driving position by moving the control on the left side of the steering column.



⚠ WARNING: Do not make adjustments while driving. Doing so increases the likelihood of a collision.

Adjusting Sensitivity

You can adjust the feel and sensitivity of the steering system to suit your personal preference:

1. On the touchscreen, touch Controls.
2. Choose a steering option:
 - Comfort - reduces the effort required to turn the wheel. In town, Model S feels easier to drive and park.
 - Standard - Tesla believes that this setting offers the best handling and response in all conditions.
 - Sport - Increases the effort required to turn the wheel. When driving at higher speeds, Model S feels more responsive.

The only way to really know which option you like best is to try them.

Using Left Steering Wheel Buttons

Use the buttons on the left side of the steering wheel to change radio stations, control the media player's volume, and control what displays on the left side of the instrument panel whenever the Navigation app is not displaying instructions.

NOTE: The volume control on the steering wheel does not adjust spoken navigation instructions. To control the volume of navigation instructions, use the navigation window on the touchscreen (see page 5.19).

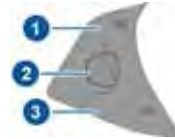

1. Next

If you are listening to local radio and you have defined more than one radio preset, (see page 5.12) press to play the next preset in the radio band that is currently playing. If you have not defined more than one preset, press to go to the next available frequency.

If you are listening to Internet radio, or to an audio file on a connected Bluetooth or USB device, press to skip to the next song or station.

2. Scroll Wheel

- To adjust the media volume, roll up or down.
- To mute the media volume, or to pause/play an audio file, tap the wheel.
- To choose what displays on the left side of the instrument panel, press the scroll wheel to display the available options. Then roll the scroll wheel to browse through the options. Tap the scroll wheel when the option you want is selected.

3. Previous

Same as described above for Next, except it skips to the previous song or station.

NOTE: Regardless of how you customize the left side of the instrument panel, it automatically changes to display navigation instructions (if applicable), or to let you know if a door or trunk is open when Model S is in a driving gear.



Using Right Steering Wheel Buttons

Use the buttons on the right side of the steering wheel to control the phone and some Model S features, use voice commands, and customize what Model S feature the right scroll wheel can control.

NOTE: Regardless of how you customize the right side of the instrument panel, it automatically displays the phone menu when someone is calling you on a Bluetooth connected phone.

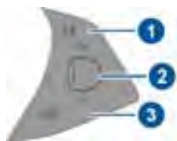

1. Phone Menu

During a phone call, press to display the phone menu, which gives you the option to mute, hold, or end the call.

2. Scroll Wheel

- Roll the wheel up or down to choose an option from a menu. When the option you want is highlighted, press the wheel to select it.
- Tap the wheel to select the function you have customized for it (see item 3).
- To choose what displays on the right side of the instrument panel, press the wheel to display the available options. Then roll the wheel to browse through the options. Tap the scroll wheel when the option you want is selected.

3. Customize the Scroll Wheel/Exit a Menu

Press and select Phone to browse through and select contacts and recent calls.

Press and select Customize to associate the scroll wheel with a specific function. You can choose from:

- All - roll the wheel to choose from all available functions (listed next).
- Climate Temps - roll the wheel to change the temperature, or press the wheel to turn the climate control system on and off.

- Fan Speed - roll the wheel to adjust the speed of the fan used to cool or heat the cabin.
- Display Brightness - roll the wheel to change the brightness level of the displays, or press the wheel to restore default settings.
- Media Source Picker - roll the wheel to control what Media Player is playing, or press the wheel to add/remove the currently playing station or audio track as a Favorite.
- Sunroof (if equipped) - roll the wheel to adjust the position of the sunroof.

Press the lower right button at any time to either exit a menu, or go back one level in the menu structure.

Horn

To sound the horn, press the center pad on the steering wheel.





Adjusting Exterior Side Mirrors

Press the button associated with the mirror you want to adjust (left or right), then press the dial to move the mirror to the desired position. Repeat for the other side mirror. Touch **SAVE** on the touchscreen to save the mirror adjustment in your driver profile.



To fold an exterior mirror, place your hand on the back of it and push it toward the door.

If Model S is equipped with the optional tech package, the driver's side mirror automatically dims in proportion to the level of glare from the headlights of a vehicle behind you (except when in Reverse gear). Also, both exterior side mirrors have heaters that turn on and off with the rear window heater.

Mirror Auto-tilt When Reversing

If Model S is equipped with the optional tech package, both exterior mirrors can automatically tilt downward when backing up. To adjust the auto-tilt position, shift into Reverse, then adjust the mirrors as described above (press the button associated with the mirror you want to adjust, then press the dial to move the mirror to the desired position). Touch **SAVE** on the touchscreen to save the mirror adjustment in your driver profile.

When you shift back into Drive, the mirrors tilt back to their normal (upward) position. But now that you have adjusted them for backing up, they automatically tilt to the selected downward position whenever you shift into Reverse.

You can turn the auto-tilt feature on or off using the touchscreen, Touch **Controls > Settings > Mirror Auto-Tilt**.

Rear View Mirror

Except when in Reverse gear, the rear view mirror automatically dims in proportion to the level of glare from the headlights of a vehicle behind you.





Starting Model S

When you open a door, Model S powers on the instrument panel and touchscreen. The center circle on the instrument panel displays the status of doors and the charge level, and you can operate all controls.

To drive:

- **PRESS THE BRAKE** - the center circle on the instrument panel changes to display the speedometer, power meter, charge level, and selected gear (**P, R, N, or D**)
- **SELECT A GEAR** - all the way down for Drive and all the way up for Reverse,

Everything you need to know when driving Model S displays on the instrument panel.

Key Not Inside

If Model S does not detect a key when you press the brake, the instrument panel displays a message telling you that a key was not detected.

Place the key in the center console cup holder where Model S can best detect it.



If Model S still does not detect the key, try holding it against the center console, immediately below the 12V power socket (see page 5.16). Or try using another key. If another key does not work, contact Tesla.

A number of factors can affect whether Model S can detect the key. These include a low battery in the key, interference from other devices using radio signals, and objects between the key and receiver.

Always keep the key with you. After driving, you need it to restart Model S after it powers off. And when you leave Model S, you must bring it with you to lock Model S, either manually or automatically (see page 2.5).

Powering Off

When you finish driving, shift into Park by pressing the button on the end of the gear selector. The parking brake automatically engages and all systems keep operating. When you leave Model S with the key, it powers off automatically, turning off the touchscreen and instrument panel.

Model S also powers off automatically after being in Park for 15 minutes, even if you are sitting in the driver's seat.

To power off Model S while you are still sitting in the driver's seat, touch **Controls > E-Brake & Power Off > Power Off**. Model S automatically powers back on again if you press the brake or touch anywhere on the touchscreen.

NOTE: Model S automatically shifts into Park whenever you finish driving and exit, even if you shift into Neutral before exiting. To keep Model S in Neutral, see page 4.7.



Shifting Gears

When Model S is in Park, you must press the brake to shift to another gear.

Move the lever up or down to change gears.



If you try to shift into a gear that the current driving speed prohibits, you hear a chime and the gear does not change.

Reverse

Push the lever all the way up and release. You can only shift into Reverse when Model S is stopped or moving less than 8 km/h. If moving less than 1.6 km/h, you must press the brake.

Neutral

Push the lever up or down to the first position and release to shift into Neutral. Neutral allows Model S to roll freely.

If Model S is in Park and you use the touchscreen to release the parking brake (Controls > E-Brake & Power Off), Model S shifts into Neutral (see page 4.21).

Model S automatically shifts into Park when you exit. To leave Model S in Neutral, use the touchscreen to engage Tow mode (see page 4.7).

Drive

Push the lever all the way down and release. You can shift into Drive when Model S is stopped or moving less than 8 km/h in Reverse. If Model S is moving less than 1.6 km/h, you must press the brake to shift into Drive.

Park

With Model S stopped, press the end of the gear selector. Whenever Model S is in Park, the parking brake is applied.



Model S automatically shifts into Park whenever you:

- Open the driver's door and exit.
- Connect a charge cable.

Leaving Model S in Neutral (Tow Mode)

Model S automatically shifts into Park whenever you finish driving and exit Model S. To keep Model S in Neutral when you exit, allowing it to roll freely (for example, pulling onto a transporter, etc.), activate Tow mode:

1. Shift into Park.
2. Press the brake pedal.
3. Touch **Controls > E-Brake & Power Off > Tow Mode**.

Model S beeps, shifts into Neutral, and releases the parking brake (if engaged).



When Tow mode is active, Model S displays this indicator light on the instrument panel, along with a message telling you that Model S will remain free rolling.

NOTE: In Tow mode, Model S does not shift into a driving gear. To cancel Tow mode, shift into Park or touch Tow mode again. Tow mode also cancels if you use the touchscreen to apply the parking brake (**Controls > E-Brake & Power Off > Parking Brake**).



Instrument Panel Overview

NOTE: The following illustration is provided for demonstration purposes only. Depending on vehicle options, software version, and market region, the information displayed may be slightly different.



1. The center display changes depending on whether Model S is off or ready to drive. If Model S is off, the center display shows remaining estimated range and status of doors. Pressing the brake powers Model S on—the indicator lights flash on for a second and the center display shows speed, power, charge level, estimated range (see item 9), and active gear. When Model S is plugged in, the instrument panel displays charging status (see page 6.8).
2. Use the left steering wheel buttons to operate the audio system. You can also press and roll the scroll wheel to change what displays on the left side of the instrument panel (see page 4.3).
3. Pay attention to important status messages that display here.
4. All indicator lights flash on briefly when you press the brake to prepare to drive. They should then turn off, unless the light applies to a current situation (see page 4.9).
5. Use the right steering wheel buttons to handle telephone calls, and to control some features of Model S. You can customize what features the scroll wheel can control (see page 4.4).
6. Door lock status
7. Odometer
8. Outside temperature
9. Range estimate
 - The estimated range based on the amount of energy remaining in the Battery. You can specify how you want to display range by touching Controls > Settings > Language & Units and choosing:
 - Rated - based on ECE R101 testing.
 - Ideal - assumes ideal driving conditions based on driving at a steady speed of 89 km/h on a flat road, and using no additional energy (seat heaters, air conditioning, etc).
 - NOTE: When anticipating when you need to charge, use range estimates as a general guideline only.
10. Pay attention to alert messages that appear at the bottom center of the instrument panel. If any alerts are in effect, you can view information about them by touching the alert icon (exclamation mark) on the touchscreen's status bar (the topmost area of the touchscreen).
11. Currently selected gear Park, Reverse, Neutral, or Drive.
12. Date and time









Indicator Lights

Indicator lights flash on briefly when you press the brake pedal to prepare for driving. Unless an indicator light applies to a current situation, they should turn off. If an indicator light fails to turn on or off, contact Tesla.

In addition to indicator lights, alerts display on the top or bottom center of the instrument panel. If alerts are in effect, an alert icon (exclamation mark) displays on the top of the touchscreen. Touch this icon to display a description of the alert.

Indicator	Description
	Airbag safety. If this indicator does not flash on briefly when Model S prepares to drive, or if it remains on, contact Tesla immediately. See page 3.18.
	A seat belt is not fastened. See page 3.4.
	The front passenger's air bag has been turned off using the touchscreen. See page 3.17.
	Rear fog lights. See page 4.11.
	Parking lights (side marker lights, tail lights, and license plate lights) are on.
	Headlight low beams are on.
	Headlight high beams are on. See page 4.13.
	Electronic stability control systems are applying the brake to the relevant wheel to prevent slippage (light flashes).
	The traction control system has been disabled. See page 4.22.
	An Active Air Suspension fault is detected. Contact Tesla. See page 5.11.
	Active Air Suspension's automatic self-leveling is disabled. In other words, Model S is in Jack mode and is ready to be lifted or pulled onto a transporter. Jack mode cancels when Model S is driven over 7 km/h. See page 5.11.
	The parking brake is manually applied. See page 4.21.
	A parking brake fault is detected. Contact Tesla. See page 4.21.



Indicator	Description
	An ABS (Anti-lock Braking System) fault is detected. See page 4.20. Contact Tesla immediately.
	A brake system fault is detected or the brake fluid level is low. See page 4.20. Contact Tesla immediately.
	Tire pressure warning. The pressure of a tire is out of range. If a fault with the Tire Pressure Monitoring System (TPMS) is detected, the indicator flashes. For a TPMS fault, contact Tesla. See page 7.3.
	A door or trunk is open. See page 2.4.
	Flashes green when the left turn signal is operating. Both turn signal indicators flash green when the hazard warning flashers are operating.
	Flashes green when the right turn signal is operating. Both turn signal indicators flash green when the hazard warning flashers are operating.
	Model S is in Tow mode and can roll freely. It does not automatically shift into Park when you exit. See page 9.3.



Controlling Lights

Touch **Controls** on the bottom left corner of the touchscreen to control most of the lights. In addition to the lights that you can control from the touchscreen, Model S has convenience lights that turn on and off automatically based on what you are doing. For example, you will notice interior lights, marker lights, tail lights, door handle lights, and puddle lights that turn on when you unlock Model S, when you open a door, and when you shift into Park. They turn off automatically after a minute or two or when you shift into a driving gear or lock Model S.

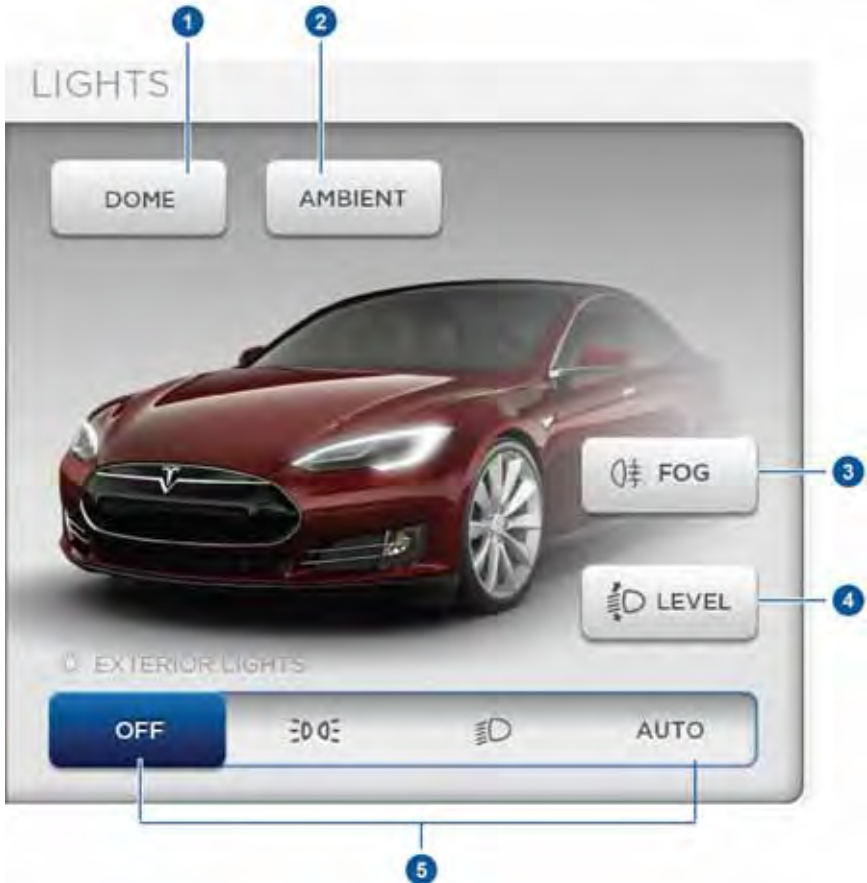



1. If **DOME** lights are set to AUTO, interior dome (map) lights turn on when you unlock Model S, open a door upon exiting, or shift into Park. They turn off after 60 seconds, when you lock Model S, or when you shift into a driving gear.

You can also turn an individual dome light on or off by pressing its lens. If you manually turn a dome light on, it turns off when Model S powers off. If Model S was already powered off when you manually turned the light on, it turns off after 60 minutes.



2. If you turn on **AMBIENT** lights, the lights on the door armrests turn on whenever the headlights are on.
3. Touch **FOG** to turn the rear fog lights on or off.



The Rear Fog indicator displays on the instrument panel whenever rear fog lights are on.

The fog lights operate only when the headlights are on. Whenever headlights are turned off, fog lights also turn off.

4. If your Model S is equipped with a coil suspension system, you can adjust the angle of the headlights to accommodate the load you are carrying. You may need to lower the angle of the headlights to avoid blinding oncoming drivers in situations when you are carrying a significant amount of weight in the rear trunk. After touching LEVEL, drag the slider to the desired position:

0	Headlights are not lowered. No change is needed when all front and rear seats are occupied and only the front trunk is laden.
1	Headlights are lowered one or two levels. Suitable when the front and rear seats are occupied and the rear trunk is laden. For more details on vehicle loading, see page 8.3.
2	

NOTE: Headlight adjustments are not available if Model S is equipped with Active Air Suspension because Model S levels automatically.

5. Exterior lights are set to AUTO each time you start Model S.

AUTO All exterior lights (headlights, tail lights, position lights, and license plate lights) automatically turn on when driving in low lighting conditions. These lights always revert to AUTO on your next drive, regardless of any other setting that you selected when it was previously driven.

NOTE: When set to AUTO, headlights operate based on lighting conditions, particularly at dawn and dusk. A blue sky, with the sun located low on the horizon, can cause the lights to switch on.

Touch one of these options to temporarily change the exterior light setting:

OFF Headlights, tail lights, and license plate lights turn off until you manually turn them back on or until the next time you drive Model S. Only the daytime running lights (front) are on.



The daytime running lights, the rear position lights, and the license plate lights are on.



All exterior lights (headlights, tail lights, position lights, and license plate lights) turn on.



Headlight High Beams

Push the left-hand steering column lever away from you. To cancel, pull the lever toward you.



The high beam indicator displays on the instrument panel whenever high beams are on.

To flash the headlight high beams, pull the lever fully toward you and release.

Headlights After Exit

When you stop driving and park Model S in low lighting conditions, the exterior lights automatically turn on. They automatically turn off after two minutes or when you lock Model S.

You can turn this feature on and off using the touchscreen. Touch **Controls > Settings > Vehicle > Headlights After Exit**.

Cornering Lights

If Model S is equipped with the optional tech package, LED cornering lights broaden the beam of the headlights whenever you drive through a corner at 40 km/h or slower.

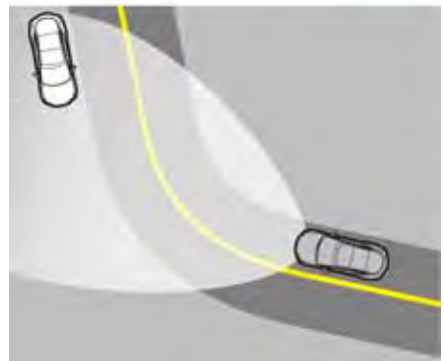
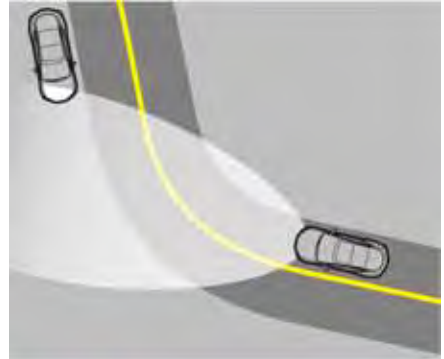



Turn Signals

Move the left-hand steering column lever up (before turning right) or down (before turning left).



The turn signals stop operating when canceled by the steering wheel, or when you return the lever to the central position.



The corresponding turn signal indicator displays on the instrument panel when a turn signal is operating. You also hear a clicking sound.

Lane Change Flash

To indicate a lane change, quickly press the lever up or down against the spring pressure, then release. The corresponding turn signal flashes three times.

Hazard Warning Flashers

Press the switch located to the left of the touchscreen to turn on the hazard warning flashers. All turn signals flash. Press again to turn off.



NOTE: Hazard warning flashers operate even without a recognized key nearby.



Wipers

To wipe the windshield, rotate the end of the left-hand steering column lever away from you. You can choose from four levels:

- 1st: Auto with low rain sensitivity.*
- 2nd: Auto with high rain sensitivity.*
- 3rd: Continuous, slow.
- 4th: Continuous, high.



For a single wipe, press and release the end of the lever.

If the wipers are set to Auto and the sensor detects no water, the wipers do not wipe.

When you operate the wipers, headlights automatically turn on (if they are not on already).

*Model S has a rain sensor located on the inside of the windshield at the base of the interior mirror. When wipers are set to Auto, the frequency at which they wipe depends on how much water the sensor detects. When wipers are set to the 2nd level, the sensor is more sensitive.

To extend the life of wiper blades, remove ice from the windshield before turning wipers on. Ice has sharp edges that can damage the rubber on the blades.

Periodically check and clean the edge of the wiper blade. If damaged, replace the blade immediately. For details on checking replacing wiper blades, see page 7.15.



CAUTION: In harsh climates, ensure that the wiper blades are not frozen or adhered to the windshield.

De-icing Wipers

If Model S is equipped with the cold weather option, you can de-ice wipers by touching **Controls > Cold Weather > Heated Wipers**.

This control heats the wipers for 15 minutes and then automatically turns off.

Washers

Press and hold the button on the end of the left-hand steering column lever to spray washer fluid onto the windshield. The wipers turn on.



When you release, the wipers turn off after wiping the windshield a couple more times.

Periodically top up washer fluid (see page 7.18).

De-icing Washer Nozzles

If Model S is equipped with the cold weather option, washer nozzles have de-icers that turn on whenever the ambient temperature nears freezing, or when you turn on the heated wipers (**Controls > Cold Weather > Heated Wipers**). The washer de-icers turn off when the heated wipers turn off (after 15 minutes), provided the temperature is warm enough to prevent freezing.



How Park Assist Works

If Model S is equipped with the Park Assist option, both the front and rear bumpers include four sensors. When moving slowly in Drive or Reverse, the sensors alert you if an object is detected close to the front or rear bumper, respectively.



When driving less than 4.8 km/h, the sensors are activated.

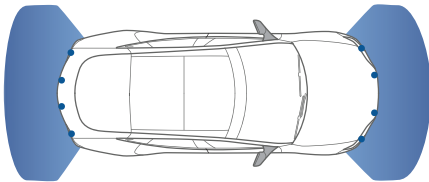

⚠ WARNING: Never depend on Park Assist to inform you if an area you are approaching is free of objects and/or people. Several external factors can reduce the performance of Park Assist, causing either no readings or false readings (see page 4.17). Therefore, depending on Park Assist to determine if Model S is approaching an obstruction can result in damage to the vehicle and/or objects, and can cause serious injury to people. Always inspect the area with your own eyes. When reversing, perform shoulder checks and use all mirrors. Park assist does not detect children, pedestrians, bicyclists, animals, or objects that are moving, protruding, located

too far above or below the sensors, or too close or too far from the sensors. Park Assist is for guidance purposes only and is not intended to replace your own direct visual checks for obstructions or objects. It is not a substitute for careful driving.

Visual and Audio Feedback

Whenever Model S is moving slowly in Reverse or Drive at a speed of less than 4.8 km/h, the left side of the instrument panel provides feedback to alert you if an object is detected near the corresponding back or front bumper. When reversing, visual feedback also displays on the touchscreen, immediately below the camera view (see page 4.24).

If chimes are turned on (see page 4.17), an audible beep sounds as you approach an object. You can temporarily mute the chime by pressing the scroll wheel on the left side of the steering wheel.

Model S detects an object within about 120 cm in Drive, and about 160 cm of the rear bumper in Reverse. The chime starts to beep (if enabled).



As Model S moves closer to the object, the yellow zone and the approximate distance from the object displays.

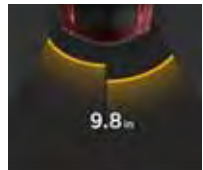

When Model S detects the object within about 40 cm of the front bumper in Drive, and about 30 cm of the rear bumper in Reverse, the red zone and a stop advisory displays. The chime's beep changes to a higher pitch.

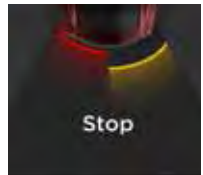

If a sensor is unable to provide feedback, the instrument panel displays an alert message.



CAUTION: Keep sensors clean from dirt, debris, snow, and ice. Avoid using a high pressure power washer on the sensors and do not clean a sensor with a sharp or abrasive object that can scratch or damage its surface.



CAUTION: Do not install accessories or stickers on or near the parking sensors.

Controlling Audible Feedback

You can use Park Assist with or without audible feedback. To turn chimes on or off, touch

Controls > Settings > Safety & Security > Park Assist Chimes.

You can also mute the chimes temporarily by pressing the scroll wheel on the left side of the steering wheel. The chimes are muted until you shift into a different gear or drive over 4.8 km/h.

Limitations and False Warnings

The parking sensors may not function correctly in these situations:

- One or more of the parking sensors is damaged, dirty, or covered (such as mud, ice, or snow).
- Object is located below approximately 20 cm (such as a curb or low barrier).
- Weather conditions (heavy rain, snow, or fog) are interfering with sensor operation.
- Object is thin (such as a sign post).
- A sensor's operating range has been exceeded.
- Object is sound-absorbing or soft (such as powder snow).
- Object is sloped (such as a sloped embankment).
- Model S has been parked in, or is being driven in, extremely hot or cold temperatures.
- The sensors are affected by other electrical equipment or devices that generate ultrasonic waves.
- Object is located too close to the bumper.
- A bumper is misaligned or damaged.
- An object that is mounted to Model S is interfering with and/or obstructing the sensor (such as a bike rack or a bumper sticker).

Other Parking Aids

In addition to Park Assist, when shifted into Reverse gear, the backup camera displays a view of the area behind Model S. See page 4.24.



Displaying Trip Information

Trip information displays on the touchscreen when you touch **Controls > Trips**. There are two trip meters available, A and B. To reset a particular trip meter, touch its associated RESET.

NOTE: You can also display range and trip information on the instrument panel (see page 4.3).



Displaying Energy Usage



Touch the Energy app on the top of the touchscreen to display a graph showing how much energy Model S has been using.

The graph visually shows energy consumption and projected range. The projected range is based on consumption over the last tenth of a mile.



Heavy acceleration and high speed driving cause peaks on the graph as Model S uses more energy. Slowing down causes dips. Points at which more energy was gained than used (causing surplus energy to be regenerated and fed back to the battery) are shown in green.

To change the graph's scale, use standard touchscreen finger gestures to pinch or expand the display. You can show the energy used over the past 10, 25, or 50 km. You can also change the graph's scale by touching **Controls > Settings > Apps > Energy**.

NOTE: You can also display this graph on the instrument panel by using the scroll button on the steering wheel (see page 4.3).

Driving Tips to Maximize Range

Maximizing your driving range uses the same driving habits that you use to conserve fuel in a gasoline-powered vehicle.

Energy consumption depends on driving habits and environmental conditions (such as cold weather and hilly roads). To get the maximum mileage from a charge, you should:

- Keep in mind that driving at high speeds (such as on a freeway) decreases range.
- Avoid frequent and rapid acceleration.
- Instead of using the brake to slow down, move your foot off the accelerator. Whenever Model S is moving and your foot is off the accelerator, regenerative braking slows down Model S and feeds surplus energy back to the Battery (see page 4.21).
- Keep tires at the recommended inflation pressures (see page 7.3).
- Lighten your load by removing any unnecessary cargo.
- Limit the use of resources such as heating and air conditioning. Using seat heaters to keep warm is more efficient than heating the cabin.

The power meter on the instrument panel and the Energy app (see page 4.19) provide feedback on energy usage. With this feedback, you will soon become familiar with how driving habits and environmental conditions impact how much energy Model S is using.



Braking Systems

Model S has an anti-lock braking system (ABS) that prevents the wheels from locking when you apply maximum brake pressure. This improves steering control during heavy braking in most road conditions.

During emergency braking conditions, the ABS constantly monitors the speed of each wheel and varies the brake pressure according to the grip available.

The alteration of brake pressure can be felt as a pulsing sensation through the brake pedal. This demonstrates that ABS is operating and is not a cause for concern. Keep firm and steady pressure on the brake pedal while experiencing the pulsing.



The ABS indicator flashes briefly on the instrument panel when you first start Model S. If this indicator displays at any other time, an ABS fault has occurred and ABS is not operating. Contact Tesla. The braking system remains fully operational and is not affected by an ABS failure. However, braking distances may increase.



If the instrument panel displays this indicator at any time other than displaying briefly when you first start Model S, a brake system fault is detected or the brake fluid level is low. Contact Tesla immediately.

Emergency Braking

In an emergency, fully press the brake pedal and maintain firm pressure, even on low traction surfaces. ABS varies the braking pressure to each wheel according to the amount of traction available. This prevents wheels from locking and ensures that you stop as safely as possible.



WARNING: Do not pump the brake pedal. Doing so interrupts operation of the ABS and can increase braking distance.



WARNING: Always maintain a safe distance from the vehicle in front of you and be aware of hazardous driving conditions. While ABS can improve stopping distance, it cannot overcome the laws of physics. It also does not prevent the danger of hydroplaning (where a layer of water prevents direct contact between the tires and the road).

Brake Wear

Model S brake pads are equipped with wear indicators. A wear indicator is a thin metal strip attached to the brake pad that squeals as it rubs against the rotor when the pad wears down. This squealing sound indicates that the brake pads have reached the end of their service life and require replacement. To stop the squealing, contact Tesla Service.

Brakes must be periodically inspected visually by removing the tire and wheel. For detailed specifications and service limits for rotors and brake pads, see page 8.6.



WARNING: Neglecting to replace worn brake pads will result in damage to the braking system and can create a braking hazard.



Regenerative Braking

Whenever Model S is moving and your foot is off the accelerator, regenerative braking slows down Model S and feeds any surplus energy back to the Battery.

By anticipating your stops and simply removing your foot from the accelerator to slow down, you can take advantage of regenerative braking to increase driving range. Of course, this is no substitute for regular braking when needed for safety.

NOTE: If regenerative braking is aggressively slowing Model S, such as on a steep descent, brake lights turn on to alert other road users that you are slowing down.

The power meter on the instrument panel displays real-time feedback on the amount of energy being gained by regenerative braking.

The amount of energy fed back to the Battery using regenerative braking can depend on the current state of the Battery and the charge level setting that you are using. If regenerative braking is limited, a dashed yellow line displays on the power meter. For example, regenerative braking may be limited if the Battery is extremely hot or cold because the surplus energy is used to cool or heat the Battery. Regenerative braking is also limited if the Battery is already fully charged.

To Set the Regenerative Braking Level

You can use the touchscreen to change the level of regenerative braking:

1. Touch Controls.
2. Choose from two levels:
 - Standard - provides the maximum amount of regenerative braking. When you release the accelerator, Model S slows down faster, reducing the need to use the brakes.
 - Low - limits the amount of regenerative braking. When you release the accelerator, Model S takes longer to slow down and coasts further.

NOTE: Regenerative braking resets to Standard each time you start Model S.

Parking Brake

The parking brake automatically engages whenever you shift Model S into Park, and releases whenever you shift into any other gear.



NOTE: The parking brake operates on the rear wheels only, and is independent of the foot-operated brake system.

Use the touchscreen to manually release the parking brake (which also shifts Model S into Neutral):

1. Touch **Controls > E-Brake & Power Off**.
2. Press the brake pedal, then touch **Parking Brake**. If Model S was previously in Park, it shifts into Neutral.



The parking brake indicator displays on the instrument panel whenever you use the touchscreen to manually apply the parking brake.



If an electrical issue occurs with the parking brake, an amber parking brake fault message displays at the top center of the touchscreen.



CAUTION: In the unlikely event that Model S loses electrical power, you cannot release the parking brake.



How It Works

The traction control system constantly monitors the difference in speed between the front and rear wheels. If Model S experiences a loss of traction, the traction control system minimizes wheel spin by controlling brake pressure and motor power.



The electronic stability control indicator displays on the instrument panel whenever the traction control system is actively controlling brake pressure and motor power.



WARNING: Traction control does not prevent accidents caused by driving dangerously or turning too sharply at high speeds.

Turning Off

Under normal conditions, you should leave traction control on. Turn it off only in circumstances where you deliberately want the wheels to spin, such as:

- Starting on a loose surface, such as gravel or snow.
- Driving in deep snow, sand or mud.
- Rocking out of a hole or deep rut.

To turn traction control off, touch **Controls > Driving > Traction Control > Off**.



The Traction Control Off indicator displays at the top center of the touchscreen whenever the traction control system is turned off.

Although traction control turns on again automatically the next time you start Model S, turn it on using the touchscreen as soon as the circumstances that required you to turn it off have passed.



Operating Cruise Control

Cruise control makes it easy for you to maintain a consistent speed without holding your foot on the accelerator. This is useful when driving at the same speed over a long distance.

You must be driving over 32 km/h to operate cruise control.

⚠️ WARNING: Do not use cruise control on winding or slippery road surfaces, or when traffic conditions make it unsafe to drive at a consistent speed.

To operate cruise control:

1. When driving over 32 km/h, touch the end of the cruise control lever. The light on the lever turns on.



2. Accelerate until you reach your desired cruising speed.
3. Move the cruise control lever up or down, then release.



The instrument panel displays the Cruise On message above the speedometer and a white arrow on the speedometer shows your set speed.



You can accelerate at any time when driving at a set speed in cruise control. But when you release the accelerator, your speed returns to the set speed.

⚠️ WARNING: Driving downhill can increase driving speed, causing Model S to exceed your set speed.

Changing the Cruising Speed

Move the cruise control lever up (increase) or down (decrease).



- Push the lever up/down to the first position and release to increase/decrease speed by 1 mph.
- Push the lever up/down to the second position and release to increase/decrease speed by 8 km/h.
- Hold the lever up or down to increase/decrease the speed in 3 km/h increments until your desired speed is reached.

NOTE: It may take a few seconds for Model S to reach the new cruising speed. If you decrease the set speed to less than 32 km/h, cruise control cancels and the set speed clears.

Canceling and Resuming

Cruise control cancels automatically if you:

- Press the brake.
- Drive below 32 km/h.
- Shift out of Drive.

To cancel cruise control manually, briefly push the cruise control lever away from you. The message on the instrument panel turns off, but the set speed remains displayed until Model S powers off.

To resume cruising at the previously set speed, briefly pull the cruise control lever toward you. Cruise control resumes only if driving over 32 km/h.





Camera Location

Model S is equipped with a rear view camera located above the rear license plate.



Whenever you shift into Reverse, the touchscreen displays the view from the camera.



NOTE: If Model S is equipped with the optional Park Assist feature, visual feedback from the parking sensors displays below the camera image. See page 4.16.

 **WARNING:** The camera may not detect overhanging objects or barriers that can potentially cause damage or injury.

Cleaning the Camera

To ensure a clear picture, keep the camera lens clean and free of obstructions. Remove any buildup of dirt by occasionally wiping the camera lens with a soft damp cloth.



CAUTION: Do not use chemical-based or abrasive cleaners that can scour the surface of the camera lens.



Touchscreen Overview

The Big Picture 5.2

Touchscreen - Controls

Controlling Model S Features 5.4

Touchscreen - Settings

Customizing Model S 5.6

Climate Controls

Overview of Climate Controls 5.8

Customizing Climate Control 5.9

Ventilation 5.10

Climate Control Operating Tips 5.10

Active Air Suspension

Automatic Height Adjustments 5.11

Manual Height Adjustments 5.11

Jack Mode 5.11

Media and Audio

Overview 5.12

AM and FM Radio Services 5.13

DAB Radio Services 5.13

Internet Radio 5.14

Media Settings 5.14

Favorites 5.15

My Music & Devices 5.15

USB Connections 5.16

12V Power Socket 5.16

Phone

Bluetooth® Compatibility 5.17

Pairing a Bluetooth Phone 5.17

Importing Contacts 5.17

Unpairing a Bluetooth Phone 5.17

Connecting to a Paired Phone 5.18

Making a Phone Call 5.18

Receiving a Phone Call 5.18

In Call Options 5.18

Maps

Using Maps 5.19

Navigation

Navigation Overview 5.20

Starting Navigation 5.20

During Navigation 5.21

Security Settings

About the Security System 5.22

HomeLink® Universal Transceiver

About HomeLink® 5.23

Programming HomeLink 5.23

Software Updates

Loading New Software 5.24

Viewing Release Notes 5.24

Mobile App

Model S Mobile App 5.25



The Big Picture

The main components of the touchscreen are shown here. To manually control the brightness and contrast, touch **Controls > Displays**. When set to Auto, the touchscreen changes between Day and Night brightness depending on ambient lighting conditions.

NOTE: The following illustration is provided for demonstration purposes only. Depending on vehicle options, software version and market region, your touchscreen may appear slightly different.





1. Status bar





The top line displays status symbols and provides shortcuts to Charging, HomeLink, Driver Profiles, vehicle information (the Tesla “T”), software update notifications, Bluetooth® and the passenger airbag setting. The status symbols show current temperature, network signal strength, Bluetooth, passenger airbag status, and time. If an alert icon (exclamation mark) is displayed, touch it to see warning messages that are in effect.

NOTE: Time is automatically set over the mobile network. To change the units used to display temperature (C° or F°) and time (12- or 24- hour format), touch **Controls > Settings > Language & Units**.

2. Apps

There are several ways to display an app in the main viewing area:

- Tap the app’s icon to display it in the top viewing area. If the app is already displayed, a second tap displays it in full-screen view (only some apps have a full-screen mode).
- Drag the app’s icon directly onto the top or bottom viewing area.
- Touch and hold the app’s icon to display a popup that lets you choose whether to display the app in the top or bottom of the main viewing area.

	Media. See page 5.12.
	Nav. See page 5.20.
	Energy. See page 4.19.
	Web. Access the Internet using the web browser.
	Camera. Display the area behind Model S. This area also displays automatically whenever you shift into Reverse. See page 4.24.
	Phone. See page 5.18.

3. Main viewing area

The main viewing area changes depending on the app you have chosen (in the example, the Nav and Media apps are displayed). For some apps (such as Nav and Web), you can zoom in and out using standard touchscreen finger gestures.

4. Maximize/minimize app

Touch the small rectangle to expand the associated app to fill the entire main viewing area (some apps are not expandable). Touch again to display two apps in half-screen view.

5. Controls

Touch to access all Model S controls and settings (doors, locks, lights, etc).

6. Climate controls (see page 5.9).

7. Volume control

Touch the up and down arrows to increase or decrease the volume of the speakers. You can also adjust the volume using the scroll wheel on the left side of the steering wheel.

NOTE: When you open a door to enter Model S, Media Player begins playing whatever was playing when you exited. The volume is low until you sit down and close the driver’s door, at which point, the volume ramps up to the previously set level. Then again, when you open the door to exit, the volume lowers. When the last door is closed, Media Player stops playing.

8. Reverse the position of the two currently displayed apps.

 **WARNING:** Do not read the touchscreen while driving. Doing so increases the likelihood of a collision. Everything you need to know when driving is displayed on the instrument panel.



Controlling Model S Features

Touch **Controls** on the bottom left corner of the touchscreen to control and customize all main features of Model S.

NOTE: The following illustration is provided for demonstration purposes only. Depending on vehicle options, software version and market region, your touchscreen may appear slightly different.





1. Close

Touch the circled X in the top left of a window to close it. You can also touch anywhere outside the window to close it.

2. Sunroof

If Model S is equipped with a sunroof, touch to adjust its position (see page 2.12).

3. Driving

• Suspension

If Model S is equipped with Active Air Suspension, touch to manually raise or lower Model S (see page 5.11). You must press the brake pedal before you can change suspension settings. Active Air Suspension causes Model S to self-level, even when powered off. Therefore, when lifting or towing, you must disable self-leveling (see pages 7.23 and 9.3).

• Steering mode

Adjust the amount of effort required to turn the steering wheel. Sport feels more responsive whereas Comfort feels easier to drive and park (see page 4.3).

• Regenerative braking

When you release the accelerator when driving, regenerative braking slows Model S and feeds any surplus energy back to the Battery. If set to Low, Model S does not slow down as quickly, but you may experience less range (see page 4.21).

NOTE: Regardless of the setting, the energy gained by regenerative braking is reduced if the Battery is full, or if it is extremely cold or hot (the surplus energy is used to heat or cool the Battery).

• Traction Control

If you turn off Traction Control, a warning message displays on the instrument panel. The off setting stays in effect for the current drive only (see page 4.22).

• Creep

When on, Model S slowly moves forward when in Drive and backward in Reverse when you release the brake (similar to a conventional vehicle with an automatic transmission). You can only adjust this setting when Model S is in Park.

4. Cold Weather

If Model S is equipped with the cold weather option, you can control all seat heaters and the heated wipers. Note that you can also control the front driver and passenger seats using the main climate control panel located on the bottom of the touchscreen (see page 5.8).

5. Trips

View and reset the trip meters that summarize how far you have driven (see page 4.18).

6. Displays

Manually control the touchscreen's brightness and control its day (light background) or night (dark background) setting. When set to Auto, the touchscreen automatically changes between Day and Night brightness depending on the ambient lighting conditions.

7. E-Brake & Power Off

You can manually:

- Apply and release the parking brake (page 4.20).
- Power off (see page 4.6).
- Keep Model S in Neutral by activating Tow Mode (see page 9.3).

8. Doors & locks (see page 2.4)

9. Control lights (see page 4.11)

 **WARNING:** Do not read the touchscreen while driving. Doing so increases the likelihood of a collision. Everything you need to know when driving is displayed on the instrument panel.



Customizing Model S

Touch the Settings tab on the Controls window to adjust Model S to suit your preferences.

NOTE: The following illustration is provided for demonstration purposes only. Depending on vehicle options, software version, and market region, the information displayed may be slightly different. For example, on U.S. vehicles, the "Language & Units" tab is called "Units & Format."





1. Adjust settings associated with installed apps (applications). Apps that have no settings that you can adjust at this time are grayed out.
2. Create driver profiles (see page 4.2)
3. Language & Units

Adjust how Model S displays:

- Language: Set the language used when Model S displays alerts, notification messages, and navigation instructions (if equipped).

NOTE: When you change the language, you experience a brief delay as Model S shuts down and restarts the touchscreen.

- Region: Choose a region to define the formatting convention used to display dates (mm dd yy/dd-mm-yy, etc) and decimal separators (5.123, 5,123, etc).
- Distance: Miles or kms can be shown on the range display, speedometer, energy chart, trip meters, Google map searches and navigation routes.
- Time: 12 or 24 hour format.
- Temperature: °F or °C.
- Charging Units: Display energy (kWh) or distance (miles/kms).
- Range: Rated range (based on ECE R101 testing), or Ideal range (based on the assumption of driving in ideal conditions at a steady speed of 89 km/h on a flat road, and using no additional energy (seat heaters, air conditioning, etc)).

4. Vehicle

- Drive-away Door Lock: If on, all doors automatically lock whenever you drive Model S over 8 km/h (see page 2.5).
- Walk-away Door Lock: If on, all doors automatically lock when you walk away from Model S, carrying the key with you (see page 2.5). Available only if Model S is equipped with the optional tech package.
- Child-Protection Locks: If on, safety locks prevent the rear doors and the liftgate from being opened from inside Model S.
- Auto-Present Handles: If on, door handles extend automatically whenever you approach Model S carrying a key, whether locked or unlocked (see page 2.4).

- Mirror Auto-Tilt: If on, exterior mirrors tilt downward when reversing (see page 4.5). Available only if Model S is equipped with the optional tech package.
- Headlights After Exit: If on, headlights stay on for two minutes after you exit, or until you lock Model S (see page 4.13).
- Range Mode: If on, Model S conserves energy by limiting the power of the climate control system. Cabin heating and cooling may be less effective.

5. Safety & Security

Turn various safety and security features on and off:

- Passenger Airbag (see page 3.17).
- Alarm, and security options Model S is equipped with (see page 5.22).
- Remote access by Tesla's mobile applications (see page 5.25).

6. HomeLink

Use HomeLink to control RF-enabled garage doors, lights, or security systems (see page 5.23).



WARNING: Do not read the touchscreen while driving. Doing so increases the likelihood of a collision. Everything you need to know when driving is displayed on the instrument panel.



Overview of Climate Controls

The climate controls are always available at the bottom of the touchscreen. By default, climate control is set to Auto On, which maintains optimum comfort in all but the most severe weather conditions. When you adjust the temperature, the system automatically adjusts the heating, air conditioning, air distribution, air circulation, and fan speed to maintain your selected temperature. To override these settings, touch Auto On (see page 5.9).

The fan, heating, and air conditioning systems are powered by the Battery. Therefore, prolonged use decreases driving range.

NOTE: The following illustration is provided for demonstration purposes only. Depending on vehicle options, software version, and settings, the information displayed may be slightly different.



1. The front seats are equipped with heating pads that operate at three levels from 3 (highest) to 1 (lowest).

When operating, the indicator turns red and displays the setting number.

NOTE: If Model S is equipped with the cold weather option, the three rear seats also have seat heaters and all seat heaters can be controlled by touching Controls > Cold Weather.

NOTE: Seat heaters use less Battery energy than the climate control system.

2. Touch the up or down arrow to set the cabin temperature (from LO, 17° C to HI, 32° C). To apply a temperature setting to both the driver and passenger side at the same time, touch SYNC TEMP on the temperature popup that appears when you touch an arrow.

NOTE: You can display temperature in either °F or °C (Controls > Settings > Language & Units).

3. Automatic/Manual climate control (see page 5.9).

4. The windshield defroster distributes air flow to the windshield and operates the heating and fan at their maximum level. Touch once for Normal Defrost (icon turns blue). Touch twice for Max Defrost (icon turns red). When on, touch again to turn off and restore the air distribution, heating, and fan to their previous settings.

5. Turn climate control system on/off.

6. The rear window defroster warms up the rear window* for 15 minutes, then automatically shuts off.

*If Model S is equipped with the optional tech package, exterior side mirrors are also heated.



WARNING: To avoid burns resulting from prolonged use, individuals who have peripheral neuropathy, or whose capacity to feel pain is limited because of diabetes, age, neurological injury, or some other condition, should exercise caution when using the climate control system and seat heaters.



Customizing Climate Control

The climate control system is designed to automatically provide optimum comfort in most situations. All you need to do is set the desired temperature, and the air conditioning, air recirculation, air distribution, and fan speed automatically maintain your selected temperature.

To override the automatic setting, touch Auto On to view the individual settings. Then touch the setting you want to change. When you change a setting, the Auto On icon turns from blue to gray and Reset Auto is displayed instead.



1. Touch Reset Auto to change all settings back to their default values.
2. Touch A/C On or A/C off to turn the air conditioning on and off, respectively. Turning it off reduces cooling, and also reduces the power used by the Battery. Because Model S runs much quieter than a gasoline-powered vehicle, you may notice the sound of the compressor as it is operating. To minimize noise, reduce the fan speed or recirculate the air.
NOTE: Turning off air conditioning can cause the windows to fog in some climate conditions.

3. Touch one of these icons to specify how air is drawn into Model S:

 Outside air is drawn into Model S (see page 5.10). Although less efficient than recirculating the air in very hot or low climate conditions, this setting draws more air into the rear seating areas, and is recommended when occupants are seated in the Tesla built-in rear-facing child seats.

 Air inside Model S is recirculated. This prevents outside air (traffic fumes) from entering but reduces dehumidifying and cooling performance. Recirculating the air is the most efficient way to cool the front cabin area but it is also the loudest. To prevent the windshield from fogging in some conditions, briefly change the setting every hour to draw in outside air.

4. Touch one of these icons to select where air flows. You can choose more than one location:

 Foot-level vents

 Face-level vents

 Windshield vents

5. Touch and drag the slider to set the speed of the fan.

NOTE: In high temperatures, it is more efficient to operate the fan at a higher speed. Doing so reduces the amount of power needed by the air conditioning system.



Ventilation

Outside air is drawn into Model S through the grill in front of the windshield. Keep the grill clear of obstructions such as leaves and snow.

To direct the flow of air inside Model S, move the interior vents up, down, or from side to side.

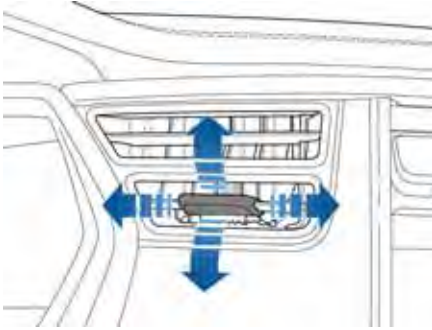

NOTE: You can direct the outer face level vents toward the side windows to help defrost or defog them.

Cabin Air Filter

Model S has an air filter that prevents pollen, industrial fallout, road dust and other particles from entering through the vents.

Tesla replaces the air filter every 40,000 km.

Climate Control Operating Tips

- If the climate control system operates more loudly than you prefer, reduce the fan speed or adjust the air flow to draw in outside air (instead of recirculating).
- In addition to cooling the interior, the air conditioning system also cools the Battery. Therefore, in hot weather, the air conditioning system can turn on even if you turned it off. This is normal because the system's priority is to cool the Battery to ensure it stays within an optimum temperature range to support long life and optimum performance.
- To ensure the climate control system operates efficiently, close all windows and ensure that the exterior grill in front of the windshield is free of ice, snow, leaves, and other debris.
- To reduce the time it takes to reach a comfortable temperature in hot weather, drive with the windows slightly open for a few minutes when you first start driving.
- In very humid conditions, it is normal for the windshield to fog slightly when you first turn on the air conditioning. This fog clears within a few seconds.
- It is normal for a small pool of water to form under Model S when parked. Extra water produced by the dehumidifying process is drained underneath.



Automatic Height Adjustments

If Model S is equipped with Active Air Suspension, the system adjusts the height based on driving speed. It also maintains a level height between the front and rear when carrying loads.

NOTE: When Model S starts, you might hear the sound of a compressor as the system's reservoir fills with air.

If Model S is moving, Active Air Suspension adjusts height as follows:

- Whenever you drive between 90 and 115 km/h, the suspension lowers to Low to improve aerodynamics and handling. When your driving slows to less than 65 km/h, the suspension raises back to Standard.
- Whenever you drive over 115 km/h, the suspension immediately lowers to Low.
- Whenever you drive at a speed less than 40 km/h, the suspension immediately raises to Standard.
- If you set the suspension to Low, then drive over 7 km/h, the suspension reverts to Standard.
- If you set the suspension to Low, then drive over 15 km/h, the suspension lowers to High.
- If you set the suspension to High, then drive over 30 km/h, the suspension lowers to Standard.

After driving, the height of the suspension periodically levels, even when Model S is powered off.



If a fault is detected with the air suspension system, a yellow indicator displays on the instrument panel. If the problem persists, contact Tesla.

Manual Height Adjustments



CAUTION: Before adjusting the suspension height, ensure Model S is clear of all obstacles above and below.

Use the touchscreen to manually change the height of Model S. Press the brake pedal and touch Controls. Then choose from:

- Very High - The suspension raises 33 mm above its normal height. Useful for extra ground clearance (ramps, speed bumps, etc).

- High - The suspension raises 23 mm above its normal height. Useful for extra ground clearance (ramps, speed bumps, etc).
- Standard - The default height. This setting ensures optimum comfort and handling under all loading conditions.
- Low - The suspension lowers 20 mm below its normal height. Useful for loading or unloading cargo and passengers.



NOTE: Available settings depend on your driving speed and other conditions. For example, the suspension does not lower if a door is open.

Jack Mode

Before jacking or lifting, set the suspension to Jack mode to prevent the self-leveling that occurs even when Model S is powered off.

Press the brake pedal, then touch **Controls > Jack**.



When Model S is in Jack mode, a red air suspension indicator displays on the instrument panel.

To deactivate, touch **Jack** again.

NOTE: Jack mode automatically cancels when you drive over 7 km/h.



Overview

 Touch the Media icon to listen to the radio or play audio files. The touchscreen displays the Media Player. Use the Browse tab to select what you want to play and use the Now Playing tab to view and control what is currently playing. You can play AM, FM radio, and DAB radio (if Model S is equipped with the optional sound package). You can also play Internet radio, and audio files from a connected Bluetooth or USB device.



1. Favorites

Display the list of your favorite stations or media files.

2. Recently Played

Display the list of stations or music files you have recently listened to.

3. Browse

Display media sources or browse audio files.

4. Audio Settings

5. Source Picker

Choose a different media source.

6. Station Information

Depending on the frequency being received, information about the currently selected station or radio service may be displayed.

7. Add/Delete Favorite

Add the currently playing station to your Favorites list. A blue icon indicates the station has already been added and touching it again removes it.

NOTE: If an empty preset is available (see item 14), adding a station to your Favorites also assigns it to a preset.

8. Signal Strength Indicator

9. DAB Controls

When listening to a DAB radio channel, touching the service name displays a popup that allows you to choose from a list of services that are available within the currently selected DAB channel. Or touch the left (back) and right (forward) arrows to scroll through the service list.

10. Station Frequency/Channel Selector

Drag the selector bar left or right to manually select a channel.

11. Seek Previous

12. Seek Next

13. Presets

Touch and hold to assign the currently playing radio station to the associated preset. When assigned, the preset displays the station or channel name. You can store up to six presets for each radio source.



AM and FM Radio Services

Model S provides AM and FM radio services. These can be selected from the Browse tab or using the Source Picker, located in the upper right corner of the Media Player window.

You can manually tune the radio to any frequency by touching and dragging the channel selector bar on the Now Playing screen. The channel selector bar allows you to move from one available radio station to the next.

For FM radio, you can also tune the radio to a specific channel by selecting the FM radio service on the Browse window, touching the Direct Tune option, then entering the channel using the number pad.



DAB Radio Services

If Model S is equipped with the sound studio package, you can also select DAB radio from the Browse tab or using the Source Picker, located in the upper right corner of the Media Player window.

You can manually tune the radio to any DAB station by touching and dragging the selector bar on the Now Playing screen.

When listening to a DAB radio channel, the Browse tab includes the name of the currently selected service. You can touch the service name to choose from a popup that lists all services available within the current DAB channel, as shown below. You can also touch the left (back) and right (forward) arrows beside the service list to scroll through the list.

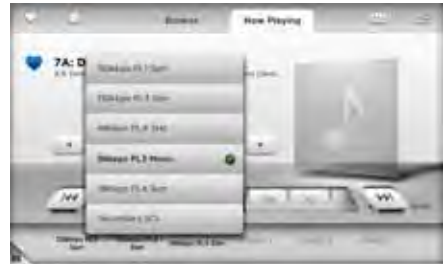

If you are listening to a DAB frequency that can no longer receive an adequate signal, the radio automatically switches to the equivalent FM broadcast. You can disable this automatic switching by turning off the Use Strongest Frequency setting on the media settings screen.



Internet Radio

Internet radio services are accessed over a data connection. To use Internet radio, touch **Media** > **Browse** > **Internet**.



Choose the Internet radio service you want to use (for example, TuneIn), then browse through the available categories and/or stations. When you select a specific station or episode, Media Player starts playing it and displays the Now Playing screen.

To play the next station or episode in the selected category, touch the previous or next arrows on the Now Playing screen, or use the arrow buttons on the left side of the steering wheel (see page 4.3).

Internet Radio Account Registration

Model S provides you with one or more Internet radio services. To enter your registration details, touch **Controls** > **Settings** > **Apps** > **Media**. Enter your username and password, then touch Log In.

TuneIn

TuneIn does not require an account for it to work. But if you have a TuneIn account (go to www.tunein.com), you can log in as described above.

Media Settings

To adjust settings for your FM and DAB radio stations, and to log into your TuneIn account, touch **Controls** > **Settings** > **Apps** > **Media**.



1. DAB Radio

- Use Strongest Frequency - if on, the radio automatically switches to the equivalent broadcast on a different frequency in situations where the signal is weak.
- Traffic Alerts - if on, radio broadcasting can be interrupted at any time with traffic alerts.

NOTE: You can disable traffic alerts only. Emergency broadcasts cannot be disabled.

2. FM Radio

- Use Strongest Frequency - described above.
- Traffic Alerts - described above.
- Use Regional Content - if on, the FM radio automatically switches to provide regional content, when available.

3. TuneIn Account

Enter login information for your TuneIn Internet radio account (see page 5.14).



Favorites

To add a currently playing radio station or audio file to your Favorites list, touch the Favorites icon on the Now Playing screen. The icon turns blue to show that it is a favorite. To remove a favorite, touch the icon again.



NOTE: Adding a radio station to your Favorites list also assigns it to one of the six presets, if an empty preset is available.

To select a favorite radio station or audio file, you can browse your list of Favorites by touching **Browse > Favorites**. The Favorites are sorted by their source. Drag to scroll up or down the list, then touch to play.

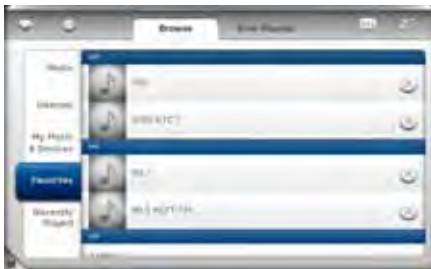

You can also scroll through your Favorites list using the left steering wheel buttons (see page 4.3),

To remove a favorite from the list, touch the associated X.

NOTE: If you remove a favorite radio station or channel that is assigned to a preset, it is also removed from the preset.

My Music & Devices

To play audio files from a portable device, touch **Media > Browse > My Music & Devices**. The name of the device will be displayed. Touch the song, album, or playlist you want to play and Media Player starts playing and displays the Now Playing screen.

To play the next song in the selected playlist or album, touch the previous or next arrows on the touchscreen, or use the left steering wheel buttons (see page 4.3).

USB Connected Devices

Connect a portable audio device or flash drive to one of the USB connections (see USB Connections). Touch **Media > Browse > My Music & Devices**, then touch the name of the device and the song you want to play.

Bluetooth® Connected Devices

If you have a Bluetooth-capable device such as a phone, that is paired and connected to Model S (see page 5.17), you can play audio files stored on it. Touch **Media > Browse > My Music & Devices**, then touch the name of your Bluetooth connected device.

The first audio file found on your Bluetooth begins playing and the touchscreen displays the Now Playing screen.

To change the track playing, touch the previous or next icons on the touchscreen, or use the left steering wheel buttons.

NOTE: To play media from a Bluetooth connected device, ensure that access to the device's media is turned on. See page 5.17.



USB Connections

Your Model S has two USB connections located on the front of the center console. Use these connections to connect USB flash drives and portable audio devices to the touchscreen. You can also use these connections to charge USB devices.



To play audio files stored on a connected device, see page 5.15.

NOTE: Do not connect multiple devices using a USB hub. This can prevent connected devices from charging or from being recognized by the touchscreen.

12V Power Socket

Your Model S has a power socket located on the front of the center console. Power from the socket is available whenever the instrument panel and touchscreen are on.

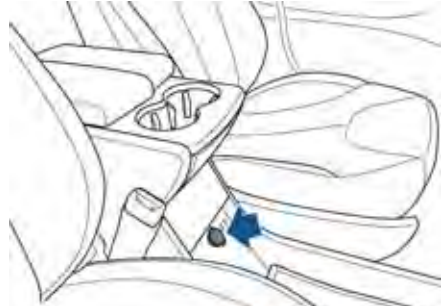

The 12V power socket is suitable for accessories requiring up to 15A or a maximum of 180 watts.

NOTE: In situations where Model S is unable to detect the key (low battery, interference, etc), place it immediately below the 12V power socket where Model S can best detect it.



WARNING: The power socket and an accessory's connector can become hot.



Bluetooth® Compatibility

You can use your Bluetooth-capable phone hands-free in Model S provided your phone is within operating range. Although Bluetooth typically supports wireless communication over distances of up to approximately 9 metres, performance can vary based on the phone's software and age.

Before using your phone with Model S, you must pair it. Pairing sets up Model S to work with your Bluetooth-capable phone.

You can pair up to ten Bluetooth phones. Model S always automatically connects to the last phone that was used (provided it is within range). If you want to connect to a different phone, see Connecting to a Paired Phone, page 5.18.

NOTE: On many phones, Bluetooth turns off if the phone's battery is low.

In addition to phones, you can also pair Bluetooth-enabled devices with Model S. For example, you can pair an iPod Touch or an iPad or Android tablet to stream music.

Pairing a Bluetooth Phone

Pairing sets up Model S to work with your Bluetooth-capable phone. Once a phone is paired, Model S can connect to it whenever the phone is within range.

To pair a phone, follow these steps while sitting inside Model S:

1. Ensure both the touchscreen and the phone are powered on.
2. On the touchscreen's status bar, touch  (the **Bluetooth** icon).
3. On your phone, enable Bluetooth and set it to discoverable.
4. On the Model S touchscreen, touch **Start Search**. The touchscreen searches then displays the list of all available Bluetooth devices within operating distance.
5. On the Model S touchscreen, touch the phone with which you want to pair. Within a few seconds, the touchscreen displays a randomly generated number, and your phone should display the same number.

6. Check that the number displayed on your phone matches the number displayed on the touchscreen. Then, on your phone, confirm that you want to pair.

When paired, Model S connects to the phone and the touchscreen displays the Bluetooth symbol next to the phone's name to show that the connection is active.

Importing Contacts

Once paired, you can use the Bluetooth settings screen to specify whether you want to allow access to your phone's contacts and recent calls.

If access is turned on, you can see your list of contacts on the Model S touchscreen. Touch **Phone > Contacts**. You can then touch a contact to dial its phone number or navigate to its address.

NOTE: Before contacts can be imported, you may need to either set your phone to allow syncing, or respond to a popup on your phone to confirm that it is OK to sync contacts. This varies depending on the type of phone you are using. For details, refer to the owner documentation provided with your phone.

If access is turned on, imported information is displayed when you touch the contacts tab on the Phone app.

Unpairing a Bluetooth Phone

If you want to disconnect your phone and use it again later, simply touch **Disconnect** on the Bluetooth settings screen. If you do not want to use your phone with Model S again, touch **Forget This Device**. Once you forget a device, you need to pair it again if you want to use it with Model S (see Pairing a Bluetooth phone).

NOTE: Your phone automatically disconnects whenever you leave Model S.



Connecting to a Paired Phone

Model S automatically connects with the last phone to which it was connected, provided it is within operating range and has Bluetooth turned on.

To connect to a different phone:

1. On the Model S touchscreen's status bar, touch  (the **Bluetooth** icon).
2. The Model S touchscreen displays the list of paired phones. If the phone is not on the list, follow the instructions on page 5.17 to pair it.
3. Choose the phone you want to connect to from the list of paired phones, then touch **Connect**.

When connected, the Model S touchscreen displays the Bluetooth symbol next to the phone name to show that the connection is active.

Making a Phone Call

You can make a phone call by using the Model S on-screen dialer, or by choosing a contact from your contact list, and then touching the contact's number you want to call.

To make a phone call using the on-screen dialer:

1. Touch the **Phone** app on the touchscreen, then touch **Dialer**.
NOTE: If a phone is not currently connected, the touchscreen displays the Connect Phone message.
2. Enter the phone number on the dialer.
3. Touch **Call**. The touchscreen displays the call screen and the number you are calling.

To make a phone call by choosing a contact:

1. Touch the **Phone** app on the touchscreen, then touch **Contacts**.
NOTE: Ensure that access to the phone's contacts is turned on. See page 5.17.
2. Touch the name of the contact you want to call to display details about the contact.
3. Touch the number you want to dial (there may be more than one). The touchscreen displays the call screen and the name of the contact you are calling.

NOTE: If it is safe and legal to do so, you can also initiate a call by dialing the number or selecting the contact directly from your phone.

Receiving a Phone Call

When your connected phone receives an incoming call, both the instrument panel and the touchscreen display the caller's number or name (if the caller is in your phone's contact list and Model S has access to your contacts, as described on page 5.17).

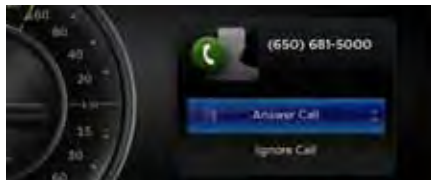

Touch one of the options on the touchscreen, or use the scroll wheel on the right side of the steering wheel to Answer or Ignore the call (see page 4.4).

In Call Options

When a call is in progress, you can display the call menu on the instrument panel by pressing the top button on the right side of the steering wheel. Then use the scroll wheel to scroll through and choose an option (see page 4.4).





Using Maps



Touch the Map icon to view and search for a location on Google Maps™. If Model S is equipped with the navigation option, the icon is labeled Nav and you can also navigate to a specified location as described on the next page. If Model S is not equipped with the navigation option, onboard maps are not available and you need a data connection to search and display locations.

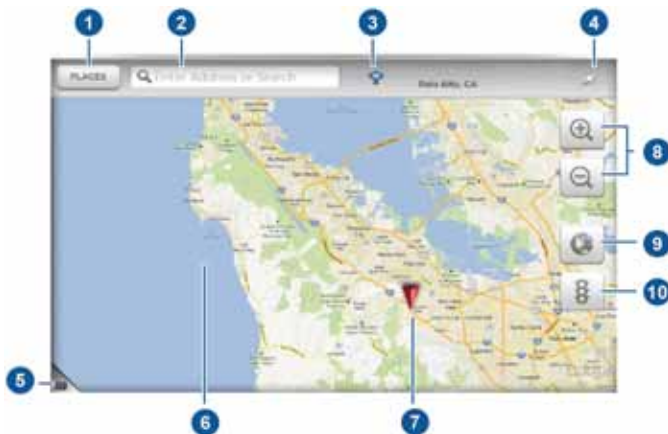

1. Display a list of recent searches. If Model S is equipped with the navigation option, you can also display recent places you have navigated to, and locations where you have previously charged.
2. Touch to enter search information. You can enter an address, landmark, business, etc.
3. Touch to center the map on your car and have the map track your position as you drive. The icon is blue when the map is tracking your position and by touching the icon, you can change the orientation of the map:



North Up - North is always at the top of the screen.



Heading Up - The direction you are heading is always at the top of the screen. The map rotates when you change direction.

You can rotate the map in any direction. When you rotate the map you'll notice the icon turn gray, indicating the map is no longer tracking your position. Touch the icon again to track your position.



Whenever the map is not showing North at the top, a compass appears on the map. The compass arrow points North and the text indicates the direction you are driving.

4. Display Previous Charging locations on the map.
5. Expand the navigation window to fill the touchscreen's entire viewing area.
6. Drag the map to change the geographic area that is visible in the window.
7. The red arrow marks your current location.
8. Zoom in and out. You can also zoom using standard touchscreen finger gestures.
9. Toggle between map and satellite views.
10. Toggle between showing traffic and hiding traffic.

NOTE: To change the size of the font used to display the map's labels, touch **Controls > Settings > Apps > Maps**.



Navigation Overview



With the navigation option, onboard maps allow you to navigate to any location, even in areas where a data connection is not available. When you specify a location, the touchscreen displays the route and provides turn-by-turn instructions.

NOTE: If Model S is not equipped with the optional navigation feature, the app's icon is labeled Maps (see previous page).

Starting Navigation

1. Touch the **Nav** icon to display the map. For a description of the map's features, see the previous page.
2. Touch the search bar to enter the destination. You can enter complete address information, then touch GO. If you have a data connection, you can start entering the destination, then choose one of the auto-complete entries that appear. For example, you can enter just the street, business name, or category (such as hotels, coffee, etc.). A list of matching destinations and their corresponding pushpins appear on the map and you can then touch any list item or its pushpin to start navigation. If you don't have a data connection, you must enter complete and exact location information.

NOTE: You can also touch PLACES and choose a location from the list of Recent Places, Recent Searches, or Visited Chargers.

When you enter or choose a destination, a destination popup appears on the map, displaying information about your selected destination. Navigation starts automatically if you do not touch Cancel within 5 seconds.

If you press Cancel before Navigation starts, the popup remains and you can choose to navigate when ready, or you can specify a different destination. The popup will include the destination's phone number (if available) and you can touch Call to dial the number from a Bluetooth-connected phone.

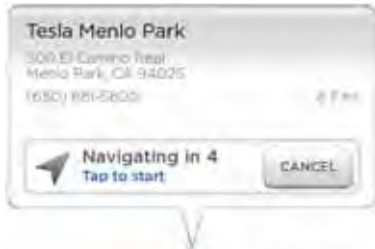



During Navigation

During navigation, the touchscreen displays the navigation route and the turn-by-turn direction list. Depending on the map's zoom level, you might not be able to see the entire route. But as you drive, the map shows your location on the map.

During navigation, the instrument panel also displays directions to your destination and you hear spoken instructions.



1. The turn-by-turn direction list summarizes the navigation route. You can scroll the list to review the turn-by-turn directions.
2. Touching any route segment in the list centers the map on it. Touching again resumes the map to its previous state.
3. Control the volume of the spoken instructions.
4. Estimated duration, mileage and arrival time.
5. Exit navigation.
6. The checked flag marks your destination on the map.
7. The red arrow marks your current location.
8. See page 5.19.
9. Center the map on your destination and display the destination popup, which provides details about the destination and a shortcut you can use to automatically call the destination from a Bluetooth connected phone (if a number is available).



About the Security System

If Model S does not detect a key nearby and a locked door or trunk is opened, the horn beeps and headlights and turn signals flash. To deactivate the alarm, press any button on the key.

You can manually enable or disable the alarm system by touching **Controls > Settings > Safety & Security > Alarm**. When set to on, Model S activates its alarm one minute after the doors lock and a recognized key is no longer detected nearby.

If Model S is equipped with the optional security package, it includes a battery-backed siren. If the Tilt/Intrusion setting is on, this siren sounds when Model S detects motion inside the cabin or if it is raised (for example, with a tow truck or jack) when doors are locked and a recognized key is not detected. To turn the tilt and intrusion detection system on or off, touch **Controls > Settings > Safety & Security > Tilt/Intrusion**.



NOTE: If you plan to leave something that moves, such as a dog, inside your locked Model S, remember to turn off the tilt/intrusion system. Any type of motion detected inside Model S activates the siren.



About HomeLink®

 If Model S is equipped with the optional tech package, you can program the HomeLink® Universal Transceiver to operate up to three garage doors, gates, lights, and security systems that can transmit Radio Frequency (RF) signals.

Programming HomeLink

1. Park in front of the device you want to program, and have the device's remote control ready.
2. Touch **Controls > Settings > HomeLink** on the touchscreen.
3. Touch **Enter Name**, then use the onscreen keyboard to enter a name for your HomeLink device.
4. Touch **Create HomeLink**.
5. Follow the onscreen instructions.

Once programmed, you can operate the device by touching its corresponding HomeLink icon on the touchscreen's status bar. HomeLink remembers the location of your programmed devices. When you approach a known location, the HomeLink control on the touchscreen automatically drops down. When you drive away, it disappears.

NOTE: For security reasons, erase your HomeLink settings if you sell Model S.



WARNING: Your device might open or close during programming. Before programming, make sure that the device is clear of any people or objects.



WARNING: Do not use the HomeLink Universal Transceiver with a garage door that does not meet federal safety standards. A garage door opener that cannot detect an object in its path and then automatically stop and reverse, does not meet these standards. Using a garage door opener without these features increases the risk of injury or death.



Loading New Software

Model S updates its software wirelessly, providing new features throughout your term of ownership. The first time you enter Model S after an update is made available, a scheduling window displays on the touchscreen.

NOTE: A software update can take up to two hours to complete (an estimated time is provided). Model S must be in Park when the new software is being installed.

When a software update is available, a yellow clock icon appears on the touchscreen's status bar.



1. Touch the up and down arrows to change the installation time (if necessary). Then touch **Set For This Time** to schedule the installation. Once scheduled, the yellow clock icon on the touchscreen's status bar becomes white.
2. Touch **Install Now** to immediately start the installation process.

You can reschedule the installation any time before it begins. To do so, touch the clock icon on the touchscreen's status bar to display the update window.

If Model S is charging when the software update begins, charging stops. Charging resumes automatically when the update is complete. If you are driving Model S at the scheduled update time, the update is canceled and you need to reschedule.

If the touchscreen displays a message indicating that a software update was not successfully completed, contact Tesla.

Viewing Release Notes

When a software update is complete, learn about the new features by displaying the release notes. To display release notes at any time touch the **Tesla "T"** at the top center of the touchscreen, then touch **Release Notes**.



Model S Mobile App

The Tesla Model S mobile app allows you to communicate with Model S remotely using your iPhone® or Android™ phone. With this app, you can check charging progress, start and stop charging, heat or cool Model S, locate Model S or track its movement, flash lights, honk the horn, lock and unlock, and more.

Simply download the app to your phone and enter your login credentials. You must also ensure that Model S is ready to communicate with the mobile app by turning on its remote access setting. Touch **Controls > Settings > Safety & Security > Remote Access > On**.



Electric Vehicle Components

High Voltage Components	6.2
Mobile Charging Equipment	6.3
High Power Wall Connector.....	6.3

Battery Information

About the Battery	6.4
Battery Care	6.4

Charging Model S

Opening the Charge Port	6.5
Plugging In.....	6.5
During Charging.....	6.5
Stopping Charging.....	6.5
Charge Port Light.....	6.6
Changing Charge Settings.....	6.7
Charging Status	6.8



High Voltage Components

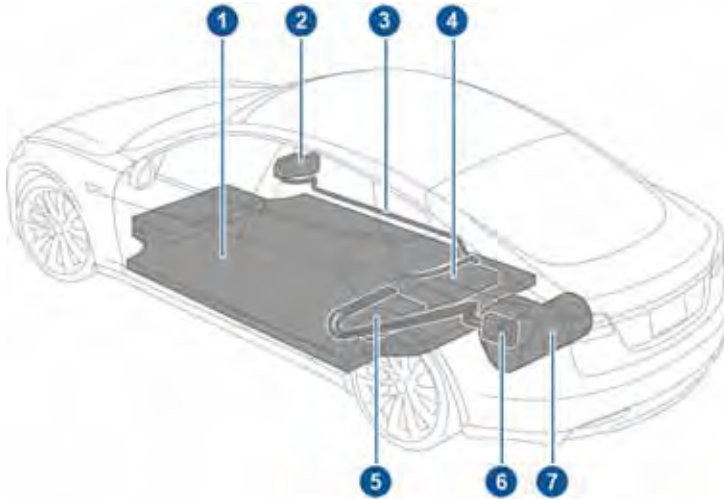

1. Battery
2. DC-DC converter
3. High voltage cabling (colored orange)
4. 10 kW on-board master charger
5. OPTIONAL: 10 kW on-board charger
6. Charge port
7. Drive unit

⚠ WARNING: The high voltage system has no user serviceable parts. Do not disassemble, remove or replace high voltage components, cables or connectors. High voltage cables are colored orange for easy identification.

⚠ WARNING: Read and follow all instructions provided on the labels that are attached to Model S. These labels are there for your safety.

⚠ WARNING: In the unlikely event that a fire occurs, immediately contact your local fire emergency responders.



Mobile Charging Equipment

Model S is equipped with a Mobile Connector and the adapter(s) you need to plug into commonly used power outlets.

When using the Mobile Connector, first plug the Mobile Connector into the power outlet, then plug in Model S. For more information about your Mobile Connector, see the Mobile Connector Owner's Manual.

NOTE: Additional adapters can be purchased from Tesla.

High Power Wall Connector

A High Power Wall Connector is also available from Tesla. This connector is the fastest way to charge Model S at home and installs in your garage. For more information, go to www.teslamotors.com.





About the Battery

Model S has one of the most sophisticated battery systems in the world. The most important way to preserve the Battery is to **LEAVE YOUR MODEL S PLUGGED IN** when you are not using it. This is particularly important if you are not planning to drive Model S for several weeks. When plugged in, Model S wakes up when needed to automatically maintain a charge level that maximizes the lifetime of the Battery.

There is no advantage to waiting until the Battery's level is low before charging. In fact, the Battery performs best when charged regularly.

Battery Care

Never allow the Battery to fully discharge. Even when Model S is not being driven, its Battery discharges very slowly to power the onboard electronics. On average, the Battery discharges at a rate of 1% per day. Situations can arise in which you must leave Model S unplugged for an extended period of time (for example, at an airport when traveling). In these situations, keep the 1% in mind to ensure that you leave the Battery with a sufficient charge level. For example, over a two week period (14 days), the Battery discharges by approximately 14%.

Discharging the Battery to 0% may permanently damage the Battery. To protect against a complete discharge, Model S enters a low-power consumption mode when the charge level drops to 5%. In this mode, the Battery stops supporting the onboard electronics to slow the discharge rate to approximately 4% per month. Once this low-power consumption mode is active, it is important to plug in Model S within two months to avoid Battery damage.

NOTE: When the low-power consumption mode is active, the auxiliary 12V battery is no longer being charged and can completely discharge within 12 hours. In the unlikely event that this occurs, you may need to jump start or replace the 12V battery before you can charge. In this situation, contact Tesla.

Temperature Limits

Do not expose Model S to ambient temperatures above 60° C or below -30° C for more than 24 hours at a time.

Battery Warnings and Cautions



WARNING: The Battery has no parts that an owner or a non-Tesla authorized service technician can service. Under no circumstances should you open or tamper with the Battery. Always contact Tesla to arrange for Battery servicing.



CAUTION: If the Battery's charge level falls to 0%, you must plug it in. If you leave it unplugged for an extended period, it may not be possible to charge Model S or use the vehicle without jump starting or replacing the 12V battery. Leaving Model S unplugged for an extended period can also result in permanent Battery damage. If you are unable to charge Model S, contact Tesla immediately.



CAUTION: The Battery requires no owner maintenance. Do not remove the filler cap and do not add fluid. If the instrument panel warns you that the fluid level is low, contact Tesla immediately.



At the end of its service life, the Battery should be recycled. Contact Tesla for recycling arrangements.



Opening the Charge Port

The charge port is located on the driver's side of Model S, behind a door that is part of the rear tail light assembly.

Park Model S so that the charge cable easily reaches the charge port.

With Model S unlocked, or a recognized key nearby, press and hold the button on a Tesla charging cable.



If the cable you are using does not have this button, touch **Controls > Charge Port**. Or, you can touch the battery icon at the top of the touchscreen, then from the Charging screen, touch **Open Charge Port**.

To charge at a public charging station, attach an adapter to the station's charging connector. The most commonly used adapter(s) for each market region are supplied with Model S.

The charge port lights up white when you open the charge port door. If you do not connect a charging cable, the light eventually turns off.

NOTE: If you do not insert the charge cable into the charge port within a few minutes after opening the charge port door, the latch closes. If this happens, use the touchscreen to open the charge port door.



CAUTION: The connector end of the charge cable can damage the paint if dropped onto Model S.



CAUTION: Do not attempt to force the charge port door open. Doing so can damage the latch. A damaged latch cannot hold the door closed.

Plugging In

If desired, use the touchscreen to change the charge limit and the charging current (see page 6.7).

If you are using the Mobile Connector, plug it into the power outlet before plugging it into Model S.

Align the connector to the charge port and insert fully.

When the connector is properly inserted, charging begins after Model S:

- Engages a latch that holds the connector in place.
- Shifts into Park (if it was in any other gear).
- Heats or cools the Battery, if needed. If the Battery requires heating or cooling, you may notice a delay before charging begins.

NOTE: Whenever Model S is plugged in but not actively charging, it draws energy from the wall instead of using energy stored in the Battery. For example, if you are sitting in Model S and using the touchscreen while it is parked and plugged in, the energy being used is drawn from the power outlet instead of the Battery.

During Charging

During charging, the charge port pulses green and charging status displays on the instrument panel (see page 6.8). The frequency at which the charge port's light pulses slows down as the charge level approaches full. When charging is complete, the light stops pulsing and is solid green.

NOTE: If Model S is locked, the light around the charge port does not light up.

If the light around the charge port lights up red while charging, a fault is detected. Check the instrument panel or touchscreen for a message describing the fault. A fault can occur due to something as common as a power outage. If a power outage occurs, charging resumes automatically when power is restored.

NOTE: When charging, particularly at high currents, the refrigerant compressor and the fan operate as needed to keep the Battery cool. Therefore, it is normal to hear sounds during charging.

Stopping Charging

You can stop charging at any time by disconnecting the charge cable or touching Stop Charging on the touchscreen.

To disconnect the charge cable:

1. Press the button on a Tesla connector to release the latch.
2. Pull the connector from the charge port.
3. Push the charge port door closed.



To prevent unauthorized unplugging of the charging cable, Model S must be unlocked or able to recognize a key before you can disconnect the charging cable.

NOTE: Model S stops charging whenever you double-click the key. If you do not unplug within 60 seconds, charging resumes.



CAUTION: Tesla strongly recommends leaving Model S plugged in when not in use. This maintains the Battery at the optimum level of charge.

Charge Port Light

White	The charge port door is open and charge mode is initiated.
Green - pulsing	Charging is in progress.
Green - solid	Charging is complete.
Red - flashing	A fault was detected and charging has stopped. Check the instrument panel or touchscreen for a message describing the fault.



Changing Charge Settings

The charge settings screen displays on the touchscreen whenever the charge port door is open.

To display charge settings at any time, touch the **Battery** icon on the top of the touchscreen, or touch **Controls > Charging** (located in the upper right portion of the Controls screen).

The following illustration is provided for demonstration purposes only and may vary slightly depending on the software version and market region of your Model S.



1. Charge status messages (such as Charging Scheduled, Charging In Progress) display here.
2. Adjust the charge limit based on your anticipated driving needs. Touch **Set Charge Limit**, then drag the slider bar to the desired charge level. You can charge to any level from 50% to 100%. For daily driving, charge between 50% and 90% to improve battery longevity. Charge above 90% for trips requiring maximum range. The setting you choose applies to both immediate and scheduled charging sessions.



3. Location-specific schedule

With Model S in Park, set a specific time when you want Model S to begin charging at the current location. If, at the scheduled time, Model S is not plugged in at the location, it will start charging as soon as you plug it in as long as you are plugging it in within six hours of the scheduled time. If you plug in after six hours, Model S does not start charging until the scheduled time on the next day. To override this setting, touch **Start Charging** or **Stop Charging** (see item 4). When you set a scheduled charging time, Model S displays the set time on the instrument panel and the touchscreen.

4. Touch to open the charge port door or to start (or stop) charging.

5. The current automatically sets to the maximum current available from the attached charging cable, unless it was previously reduced to a lower level.

- 3 For 3-phase charging, the available current represents the current per phase (up to 32 amps). During charging, the right status flag displays the 3-phase symbol in front of the displayed current.

If needed, touch the up/down arrows to change the current (for example, you may want to reduce the current if you are concerned about overloading a domestic wiring circuit shared by other equipment). It is not possible to set the charging current to a level that exceeds the maximum available from the attached charge cable.

When you change the current, Model S remembers the location. So if you subsequently charge at the same location, you do not need to change it again.

NOTE: Reducing the current increases charging time.



Charging Status

The following illustration is provided for demonstration purposes only and may vary slightly depending on the software version and market region of your Model S.



1. Charging rate per hour.
2. Total estimated driving distance (or energy) available. Instead of driving distance as shown here, you can change settings to display the amount of energy available instead. To do so, touch **Controls > Settings > Language & Units**.
3. Current being supplied/Total current available from the connected power supply (see page 6.7).
 - 3 If connected to a 3-phase power supply, the available current represents the current per phase and the 3-phase symbol is displayed.
4. Estimated increase in driving distance (or energy) achieved so far in this charging session. Instead of driving distance as shown here, you can change settings to display the amount of energy achieved instead. To do so, touch **Controls > Settings > Language & Units**.
5. Charging status information displays here. For example, if Model S is charging, it displays the time remaining until fully charged at the currently selected charge level. When scheduled charging is set for a location, it displays when charging will start.
6. Voltage being supplied by the charging cable.



Maintenance Schedule

Service Intervals.....	7.2
Daily and Monthly Checks.....	7.2
High Voltage Safety	7.2

Tire Care and Maintenance

Maintaining Tire Pressures.....	7.3
Inspecting and Maintaining Tires	7.4
Replacing Tires and Wheels.....	7.5
Using Tire Chains.....	7.6
Tire Pressure Monitoring	7.6

Temporary Tire Repair

Tire Repair Kit.....	7.8
Inflating with Sealant and Air	7.9
Inflating with Air Only.....	7.10
Replacing the Sealant Canister.....	7.11

Cleaning

Cleaning the Exterior	7.12
Cleaning the Interior	7.13
Polishing, Touch Up, and Body Repair..	7.14
Using a Car Cover	7.14
Floor Mats	7.14

Wiper Blades and Washer Jets

Checking and Replacing Wiper Blades..	7.15
Cleaning Washer Jets	7.15

Fluid Reservoirs

Removing the Maintenance Panel	7.16
Checking Battery Coolant.....	7.16
Checking Brake Fluid.....	7.17
Topping Up Washer Fluid.....	7.18

Fuses

Fuse Box Locations	7.19
Replacing a Fuse	7.19
Fuse Box 1	7.20
Fuse Box 2.....	7.21
Fuse Box 3	7.22
Fuse Box 4	7.22

Jacking and Lifting

Jacking Procedure	7.23
-------------------------	------

Parts and Accessories

Parts, Accessories, and Modifications ...	7.24
Body Repairs	7.24



Service Intervals

Regular maintenance is the key to ensuring the continued reliability and efficiency of your Model S.

Take Model S to Tesla at the regularly scheduled maintenance intervals of every 12 months, or every 20,000 kms, whichever comes first.

Model S must be serviced by Tesla-certified technicians. Damages or failures caused by maintenance or repairs performed by non-Tesla certified technicians are not covered by the warranty.

Fluid Replacement

Do not change or top up Battery coolant and brake fluid yourself. Tesla service technicians replace fluids at the regularly scheduled service intervals:

- Brake fluid - every 2 years or 40,000 kms, whichever comes first.
- Battery coolant - every 4 years or 80,000 kms, whichever comes first.

NOTE: Any damage from opening the Battery coolant reservoir is excluded from the warranty.

Daily and Monthly Checks

In addition to the regularly scheduled maintenance performed by Tesla, you should carry out a few simple checks more frequently.

Daily Checks

- Check the Battery's charge level, displayed on the instrument panel.
- Check that all exterior lights, horn, turn signals, and wipers and washers are working.
- Check the operation of the brakes, including the parking brake.
- Check the operation of the seat belts (see page 3.5).
- Look for fluid deposits underneath Model S that might indicate a leak. It is normal for a small pool of water to form (caused by the air conditioning system's dehumidifying process).

Monthly Checks

- Check the condition and pressure of each tire (see page 7.3).
- Check washer fluid level and top up if necessary (see page 7.18).
- Check that the air conditioning system is operating (see page 5.9).



CAUTION: Contact Tesla immediately if you notice any significant or sudden drop in fluid levels or uneven tire wear.

High Voltage Safety

Your Model S has been designed and built with safety as a priority. However, be aware of these precautions to protect yourself from the risk of injury inherent in all high-voltage systems:

- Read and follow all instructions provided on the labels that are attached to Model S. These labels are there for your safety.
- The high voltage system has no user-serviceable parts. Do not disassemble, remove or replace high voltage components, cables or connectors. High voltage cables are colored orange for easy identification.
- If an accident occurs, do not touch any high voltage wiring, connectors, or components connected to the wiring.
- In the unlikely event that a fire occurs, immediately contact your local fire emergency responders.



WARNING: Always disconnect the charge cable before working underneath Model S, even if charging is not in progress.



WARNING: Keep your hands and clothing away from cooling fans. Some fans operate even when Model S is powered off.



WARNING: Some fluids (battery acid, Battery coolant, brake fluid, windshield washer additives, etc.) used in motor vehicles are poisonous and should not be inhaled, swallowed, or brought into contact with open wounds. For your safety, always read and follow instructions printed on fluid containers.



Dispose of used fluids and other chemicals at authorized waste disposal sites. It is illegal to pollute drains, waterways or soil.



Maintaining Tire Pressures

Keep tires inflated to the pressures shown on the Tire and Loading Information label located on the driver's door pillar (even if it differs from the pressure printed on the tire itself).



The Tire Pressure indicator light on the instrument panel alerts you if one or more tires is under- or over-inflated.

The Tire Pressure indicator light does not immediately turn off when you adjust tire pressure. After inflating the tire to the recommended pressure, you must drive over 40 km/h for more than 10 minutes to activate the Tire Pressure Monitoring System (TPMS), which turns off the Tire Pressure indicator light.

If the indicator light flashes for one minute whenever you power on Model S, a fault with the Tire Pressure Monitoring System (TPMS) is detected (see page 7.6).

Checking and Adjusting Tire Pressures

Follow these steps when tires are cold and Model S has been stationary for over three hours:

1. Remove the valve cap.
2. Firmly press an accurate tire pressure gauge onto the valve to measure pressure.
3. If required, add air to reach the recommended pressure.
4. Re-check pressure by removing and re-attaching the tire gauge.
5. If you added too much air, release air by pressing the metal stem in the center of the valve.
6. Recheck the pressure with the tire gauge and adjust if necessary.
7. Replace the valve cap to prevent dirt from entering. Periodically check the valve for damage and leaks.

⚠ WARNING: Under-inflation is the most common cause of tire failures. It can cause a tire to overheat, resulting in severe tire cracking, tread separation, or blowout, which causes unexpected loss of vehicle control and increased risk of injury. Under-inflation also reduces Battery range and tire tread life.

⚠ WARNING: Check tire pressures using an accurate pressure gauge when tires are cold. It takes only one mile of driving to warm up the tires sufficiently to affect tire pressures. Parking the vehicle in direct sunlight or in hot weather can also affect tire pressures. If you must check warm tires, expect increased pressures. Do not let air out of warm tires in an attempt to match recommended cold tire pressures. A hot tire at or below the recommended cold tire inflation pressure is dangerously under-inflated.

⚠ WARNING: Do not use any tire sealant other than the type provided in a Tesla tire repair kit. Other types can cause tire pressure sensors to malfunction. If your Model S did not include a tire repair kit, you can purchase one from Tesla Motors.



Inspecting and Maintaining Tires

Regularly inspect the tread and side walls for any sign of distortion (bulges), cuts or wear.

! **WARNING:** Do not drive Model S if a tire is damaged, excessively worn, or inflated to an incorrect pressure. Check tires regularly for wear, and ensure there are no cuts, bulges or exposure of the ply/cord structure.

Tire Wear

Model S is originally fitted with tires that have wear indicators molded into the tread pattern. When the tread has been worn down to 1.6 mm, the indicators start to appear at the surface of the tread pattern, producing the effect of a continuous band of rubber across the width of the tire.

Replace a tire as soon as an indicator band becomes visible or the tread depth reaches the minimum permitted by law.

Tire Rotation, Balance, and Wheel Alignment

Tesla recommends rotating the tires every 8000 kms. After rotating, always check and adjust tire pressures.

NOTE: Do not rotate tires on the Performance Plus models.



Unbalanced wheels (sometimes noticeable as vibration through the steering wheel) affect vehicle handling and tire life. Even with regular use, wheels can get out of balance. Therefore, they should be balanced as required.

If tire wear is uneven (on one side of the tire only) or becomes abnormally excessive, check the alignment of wheels.

Punctured Tires

A puncture eventually causes the tire to lose pressure, which is why it is important to check tire pressures frequently. Permanently repair or replace punctured or damaged tires as soon as possible. Do not drive with a punctured tire, even if the puncture has not caused the tire to deflate. A punctured tire can deflate suddenly at any time.

Your tubeless tires may not leak when penetrated, provided the object remains in the tire. If, however, you feel a sudden vibration or ride disturbance while driving, or you suspect a tire is damaged, immediately reduce your speed. Drive slowly, while avoiding heavy braking or sharp steering and, when safe to do so, stop the vehicle. Arrange to have Model S transported to Tesla or to a nearby tire repair center.

In some cases, you can temporarily repair small tire punctures (under 6 mm) using an optional tire repair kit available from Tesla. This allows you to slowly drive Model S to Tesla or to a nearby tire repair facility (see page 7.8).

! **WARNING:** Do not drive Model S with a punctured tire. Even if the punctured tire has not deflated, it can suddenly deflate at any time.

Flat Spots

If Model S is stationary for a long period in high temperatures, tires can form flat spots. When Model S is driven, these flat spots cause a vibration which gradually disappears as the tires get warm and regain their original shape.

To minimize the flat spots during storage, inflate tires to the maximum pressure indicated on the tire wall, then, before driving, release air to adjust tire pressure to the recommended levels.

Driving in Low Ambient Temperatures

Tire performance reduces in low ambient temperatures, resulting in reduced grip and an increased susceptibility to damage from impacts. Performance tires can temporarily harden when cold, causing you to hear rotational noise for the first few miles until the tires warm up. Contact Tesla for winter tire recommendations.



Improving Tire Mileage

To improve the mileage you get from your tires, maintain tires at the recommended tire pressures (see page 7.3), observe speed limits and advisory speeds, and avoid:

- Pulling away quickly, or hard acceleration.
- Fast turns and heavy braking.
- Potholes and objects in the road.
- Hitting curbs when parking.
- Contaminating tires with fluids that can cause damage.

Replacing Tires and Wheels

Tires degrade over time due to the effects of ultraviolet light, extreme temperatures, high loads, and environmental conditions. It is recommended that tires are replaced every six years, or sooner if required.

Wheel rims and tires are matched to suit the handling characteristics of the vehicle. Replacement tires must comply with the original specification. If tires other than those specified are used, ensure that the load and speed ratings marked on the tire (see page 8.10) equal or exceed those of the original specification.

Ideally, you should replace all four tires at the same time. If this is not possible, replace the tires in pairs (both front or both rear). When replacing tires, always re-balance and check the alignment of wheels.

For the specification of the original wheels and tires installed on Model S, see page 8.8.

 **WARNING:** For your safety, use only tires and wheels that match the original specification. Tires that do not match the original specification can affect the operation of the Tire Pressure Monitoring System (TPMS).

Asymmetric Tires

Model S tires are asymmetric and must be mounted on the wheel with the correct sidewall facing outward. The sidewall of the tire is marked with the word **OUTSIDE**. When new tires are installed, make sure that the tires are correctly mounted on the wheels.



 **WARNING:** Road holding is seriously impaired if the tires are incorrectly installed on the wheels.

Winter Tires

In snowy and icy conditions, consider installing winter tires. Winter tires must be the same size, brand, construction and tread pattern on all four wheels. For recommendations on winter tires, contact Tesla.

 **WARNING:** On dry roads, winter tires could have less traction than the originally installed tires.



Using Tire Chains

Tesla has tested and approved Security Chain Company (SCC) Model Z-563 chains for use on the rear wheels. These chains must only be used if your Model S has 245/45R19 rear tires installed. Do not use chains on 21" tires.

When installing tire chains, follow the instructions provided by the tire chain manufacturer. Mount them as tightly as possible.

When using tire chains:

- Drive slowly—do not exceed 48 km/h.
- Avoid heavily loading Model S (heavy loads can reduce the clearance between the tires and the body).
- Remove the tire chains as soon as conditions allow.

NOTE: Tire chains are prohibited in some jurisdictions. Check local laws before installing tire chains.



CAUTION: Using non-recommended tire chains, or using tire chains on other sized tires, can damage the suspension, body, wheels, and/or brake lines. Damage caused by using non-recommended tire chains is not covered by the warranty.



CAUTION: Ensure that tire chains cannot touch suspension components or brake lines. If you hear the chains making unusual noises that would indicate contact with Model S, stop and investigate immediately.

Tire Pressure Monitoring

Each tire should be checked monthly when cold and inflated to the recommended pressures that are printed on the Tire and Loading Information label located on the driver's door pillar (see page 7.3). If your vehicle has tires of a different size than the size indicated on the vehicle placard or tire inflation pressure label, determine the proper tire inflation pressure for those tires.

As an added safety feature, your vehicle has been equipped with a tire pressure monitoring system (TPMS) that displays a low tire pressure telltale (Tire Pressure Warning) on the instrument panel when one or more of your tires is significantly under-inflated. Accordingly, when the Tire Pressure indicator light displays on the instrument panel alerting you of low tire

pressure, stop and check your tires as soon as possible, and inflate them to the proper pressure (see page 7.3). Driving on a significantly under-inflated tire causes the tire to overheat and can lead to tire failure. Under-inflation also reduces fuel efficiency and tire tread life, and may affect the vehicle's handling and stopping ability.



If Model S detects a fault with the Tire Pressure Monitoring System (TPMS), this indicator flashes for one minute whenever you power on Model S.

NOTE: Installing accessories that are not approved by Tesla can interfere with the TPMS system.



WARNING: The TPMS is not a substitute for proper tire maintenance, including manually checking tire pressures and regularly inspecting the condition of tires. It is the driver's responsibility to maintain correct tire pressure, even if under-inflation has not reached the level for the TPMS to trigger the Tire Pressure Warning on the instrument panel.

TPMS Malfunction

Model S has also been equipped with a TPMS malfunction indicator to indicate when the system is not operating properly.

The TPMS malfunction indicator is combined with the low tire pressure indicator light. When the system detects a malfunction, the indicator light flashes for approximately one minute after Model S powers on, and then remains continuously lit. This sequence continues upon subsequent vehicle start-ups as long as the malfunction exists.

When the TPMS malfunction indicator is on, the system might not be able to detect or signal low tire pressure as intended. TPMS malfunctions can occur for a variety of reasons, including installing replacement or alternate tires or wheels on the vehicle that prevent the TPMS from functioning properly. Always check the TPMS malfunction indicator light after replacing one or more tires or wheels on your vehicle to ensure that the replacement or alternate tires and wheels allow the TPMS to continue to function properly.

NOTE: If a tire has been replaced or repaired using a different tire sealant than the one available from Tesla, and a low tire pressure is



detected, it is possible that the tire sensor has been damaged. Contact Tesla to have the fault repaired as soon as possible.

Replacing a Tire Sensor

If the Tire Pressure warning indicator displays frequently, contact Tesla to determine if a tire sensor needs to be replaced. Tire sensors must be replaced by a Tesla service technician who can perform a brief setup procedure. If a non-Tesla service center repairs or replaces a tire, the tire sensor will not work until Tesla performs the setup procedure.



Tire Repair Kit

Your Model S has no spare tire. Depending on the legislations that apply to the region in which you purchased Model S, a tire repair kit may or may not be included. If a tire repair kit was not provided in Model S upon delivery, you can purchase one from Tesla.

The tire repair kit consists of a compressor and a canister of tire sealant (enough to repair one tire). When injected into a tire, the sealant can penetrate a small puncture up to 6 mm to form a temporary repair.



NOTE: For punctures larger than 6 mm, severe tread damage, a damaged sidewall, ripped tires or tires that have come off the rim, call Roadside Assistance.

WARNING: The tire repair kit is a temporary repair only. You must repair or replace a damaged tire as soon as possible.

WARNING: Do not exceed 48 km/h when driving with a tire that has been temporarily repaired with sealant.

WARNING: Follow all directions and warnings on the tire repair kit before starting a repair.

CAUTION: Do not drive on a deflated tire as this can cause serious damage.

Tire Sealant Canister

The tire sealant provided in the Tesla tire repair kit is approved for use with Model S and is designed not to damage the TPMS (Tire Pressure Monitoring System) sensors.

Therefore, you must replace it only with one of the same type and capacity (see page 7.11). Tire sealant canisters can be purchased from Tesla.

The tire sealant has an expiration date printed on the outside of the canister. If the expiration date has passed, the sealant might not work as expected. Always replace an expired tire sealant canister.

WARNING: Do not use any tire sealant other than the one available from Tesla. Doing so could cause tire pressure sensors to malfunction.

WARNING: Always read and follow the safety and handling instructions printed on the sealant canister.

WARNING: Keep tire sealant out of the reach of children.

WARNING: Tire sealant can be harmful if it contacts the eyes or if swallowed or inhaled. If the sealant comes into contact with your eyes, immediately flush with water and seek medical attention if irritation persists. If swallowed, do not induce vomiting and seek medical assistance immediately. If inhaled, breathe fresh air. Inhalation can cause drowsiness and dizziness. If breathing is affected, seek medical assistance immediately.



Inflating with Sealant and Air

If you have a Tesla tire repair kit as described on page 7.8, follow these steps to temporarily repair a small tire puncture (less than 6 mm).

1. Stop Model S in a safe place away from traffic and ask passengers to wait in a safe area.
2. Turn on the hazard warning flashers to alert other road users.
3. If possible, position the wheel with the puncture at the bottom.



4. Detach the power supply connector from the back of the compressor and plug it into the 12V power socket located on the front of the center console.
5. Release the clear plastic hose from the tire compressor.

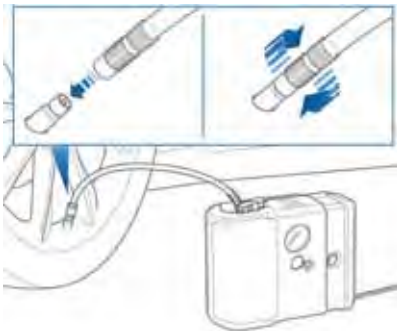

6. Remove the red cap and screw the end of the hose onto the tire's valve.

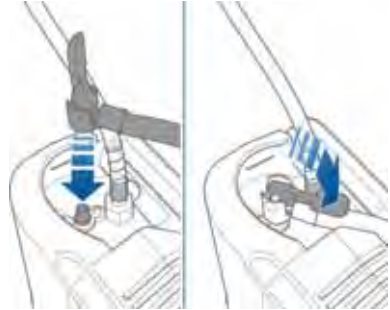

7. Attach the sealant kit's black air hose to the sealant valve and press the lever down to secure it in place.
8. Ensure the compressor is lying on a level surface with the pressure gauge facing to the side as shown above.
9. Turn on the compressor.

NOTE: The pressure gauge initially shows a high pressure while the compressor pushes the sealant into the tire. Once the sealant is completely dispersed into the tire, the pressure quickly drops and starts to rise again as the tire inflates with air only.

10. Inflate the tire to the recommended pressure.



CAUTION: If you cannot reach the required pressure within 8 minutes, stop! The tire is too severely damaged to be temporarily repaired using sealant. Do not drive. Call Roadside Assistance to have Model S transported.

11. Turn off the compressor and disconnect the hose from the tire's valve. Wipe any excess sealant from the tire valve and wheel rim.
12. Immediately drive for 8 km to distribute the sealant around the tire. Do not exceed 48 km/h.
13. Stop and check the tire's pressure. If necessary, inflate using the black air hose.
14. Have the tire repaired or replaced as soon as possible.
15. Replace the tire repair sealant canister (see page 7.11).



Inflating with Air Only

If you have a Tesla tire repair kit as described in page 7.8, follow these steps to inflate a tire with air:

1. Detach the power supply connector from the rear of the compressor and plug it into the 12V power socket located in Model S on the front of center console.



2. Release the black air hose from the compressor.
3. Attach the air hose to the valve and press the lever down to secure it in place.



4. Ensure the compressor is lying on a level surface with the pressure gauge facing to the side where you can read it.
5. To add air, turn on the compressor and inflate until the desired pressure is reached.
6. To release air, turn off the compressor, then press and hold the red button until the desired pressure is reached.

NOTE: For your convenience, the tire repair kit includes a selection of adapters that allow you to inflate other items. These adapters are located in a compartment on the back of the compressor.

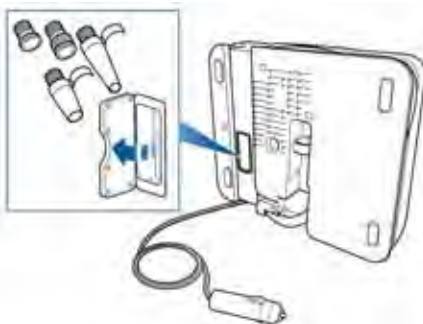

CAUTION: To avoid overheating, do not use the compressor continuously for more than eight minutes. Allow the compressor to cool for 15 minutes between uses.



CAUTION: The compressor runs slowly when overheated from excessive use. Turn it off and allow it to cool.



Replacing the Sealant Canister

If you have a Tesla tire repair kit as described in page 7.8, you can purchase additional or replacement canisters of tire sealant from Tesla.

Follow these steps to replace the canister in your Tesla tire repair kit:

1. Unwrap the clear hose from the compressor. This hose is included with the tire repair sealant canister.
2. Remove the canister cover by sliding it upward to release it from the compressor.



3. Remove the canister.

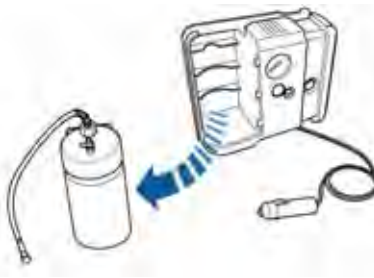

4. Insert the new canister and replace the cover.



Cleaning the Exterior

To prevent damage to the paint, immediately remove corrosive substances (bird droppings, tree resin, dead insects, tar spots, road salt, industrial fallout, etc). Do not wait until Model S is due for a complete wash. If necessary, use denatured alcohol to remove tar spots and stubborn grease stains, then immediately wash the area with water and a mild, non-detergent soap to remove the alcohol.

Follow these steps when washing the exterior of Model S:

1. Rinse Thoroughly

Before washing, flush grime and grit from the bodywork using a hose. Flush away accumulations of mud in areas where debris easily collects (such as wheel arches and panel seams). If salt has been used on the highways (such as during winter months), thoroughly rinse all traces of road salt from the underside of the vehicle.

2. Hand Wash

Hand wash Model S using a soft cloth and cold or lukewarm water containing a mild, good quality car shampoo.

3. Rinse with Clean Water

After washing, rinse with clean water to prevent soap from drying on the surfaces.

4. Dry Thoroughly and Clean Exterior Glass

After washing and rinsing, dry thoroughly with a chamois.

Clean windows and mirrors using an automotive glass cleaner. Do not scrape, or use any abrasive cleaning fluid on glass or mirrored surfaces.

Cautions for Exterior Cleaning



CAUTION: Do not use hot water and detergents.



CAUTION: In hot weather, do not wash in direct sunlight.



CAUTION: If using a pressure washer, maintain a distance of at least 30 cm between the nozzle and the surface of Model S. Keep the nozzle moving and do not concentrate the water jet on any one area.



CAUTION: Do not aim water hoses directly at window, door or hood seals, or through wheel apertures onto brake components.



CAUTION: Avoid using tight-napped or rough cloths, such as washing mitts.



CAUTION: If washing in an automatic car wash, use Touchless car washes only. These car washes have no parts (brushes, etc.) that touch the surfaces of Model S. Using any other type of car wash could cause damage that is not covered by the warranty.



CAUTION: Do not use chemical based wheel cleaners. These can damage the finish on the wheels.



CAUTION: Avoid using a high pressure power washer on the rear view camera or parking sensors (if equipped) and do not clean a sensor or camera lens with a sharp or abrasive object that can scratch or damage its surface.



Some cleaning products contain chemicals that are hazardous to the environment. Always take precautions to prevent spilling. It is illegal to pollute drains, rivers and waterways. Used toxic chemicals must be disposed of at authorized waste disposal sites only.



Cleaning the Interior

Frequently inspect and clean the interior to maintain its appearance and to prevent premature wear. If possible, immediately wipe up spills and remove marks. For general cleaning, wipe interior surfaces using a soft cloth (such as micro fiber) dampened with a mixture of warm water and mild non-detergent cleaner (test all cleaners on a concealed area before use). To avoid streaks, dry immediately with a soft lint-free cloth.

Interior Glass

Do not scrape, or use any abrasive cleaning fluid on glass or mirrored surfaces. This can damage the reflective surface of the mirror and the heating elements in the rear window.

Airbags

Do not allow any substance to enter an airbag cover. This could affect correct operation.

Dashboard and Plastic Surfaces

Do not polish the upper surfaces of the dashboard. Polished surfaces are reflective and could interfere with your driving view.

Leather Seats

Leather is prone to dye-transfer which can cause discoloration, particularly on light colored leather. White and tan leather is coated with an anti-soiling treatment. Wipe spills as soon as possible using a soft cloth moistened with warm water and non-detergent soap. Wipe gently in a circular motion. Then wipe dry using a soft, lint-free cloth. Using detergents or commercially available leather cleaners and conditioners is not recommended because they can discolor or dry out the leather.

Cloth Seats

Wipe spills as soon as possible using a soft cloth moistened with warm water and non-detergent soap. Wipe gently in a circular motion. Then wipe dry using a soft, lint-free cloth. Vacuum the seats as needed to remove any loose dirt.

Carpets

Avoid over-wetting carpets. For heavily soiled areas, use a diluted upholstery cleaner.

Seat Belts

Extend the belts to wipe. Do not use any type of detergent or chemical cleaning agent. Allow the belts to dry naturally while extended, preferably away from direct sunlight.

Tesla Built In Rear Facing Child Seats

Vacuum the seats to remove any loose dirt. Wipe the seats with a soft cloth dampened with warm water. You can also use an upholstery cleaner designed for automotive use. Extend the belts to wipe. Allow the belts to dry naturally, preferably away from direct sunlight.

Touchscreen and Instrument Panel

Clean the touchscreen and instrument panel using a soft lint-free cloth specifically designed to clean monitors and displays. Do not use cleaners (such as a glass cleaner) and do not use a wet wipe or a dry statically-charged cloth (such as a recently washed microfiber).

Chrome and Metal Surfaces

Polish, abrasive cleaners or hard cloths can damage the finish on chrome and metal surfaces.

Cautions for Interior Cleaning

 **WARNING:** If you notice any damage on an airbag or seat belt, contact Tesla immediately.

 **WARNING:** Do not allow any water, cleaners, or fabric to enter a seat belt mechanism.

 **CAUTION:** Using solvents (including alcohol), bleach, citrus, naphtha, or silicone based products or additives on interior components can cause damage.



Polishing, Touch Up, and Body Repair

To preserve the cosmetic appearance of the body, you can occasionally treat the paint surfaces with an approved polish containing:

- Very mild abrasive to remove surface contamination without removing or damaging the paint.
- Filling compounds that fill scratches and reduce their visibility.
- Wax to provide a protective coating between the paint and environmental elements.

Regularly inspect the exterior paint for damage. Treat minor chips and scratches using a paint touch up pen (available for purchase from Tesla). Use the touch-up pen after washing but before polishing or waxing.

Repair rock chips, fractures or scratches. Body repairs should be performed only by a Tesla approved body repair facility. Contact Tesla for a list of approved facilities.



CAUTION: Do not use cutting pastes, color restoration compounds, or polishes containing harsh abrasives. These can scour the surface and permanently damage the paint.



CAUTION: Do not use chrome polish or other abrasive cleaners.

Using a Car Cover

To preserve the cosmetic appearance of the body when Model S is not being used, use a genuine Tesla car cover. Car covers can be purchased from Tesla.



CAUTION: Never use a non-Tesla car cover when Model S is plugged in. Doing so can prevent the Battery from being adequately cooled during charging.

Floor Mats

To extend the life of your carpet and make them easier to clean, use genuine Tesla floor mats. Maintain mats by cleaning them regularly and replacing them if they become excessively worn.



WARNING: To avoid potential interference with a foot pedal, ensure that the driver's floor mat is securely fastened, and never place an additional floor mat on top of it.



Checking and Replacing Wiper Blades

Periodically check and clean the edge of the wiper blade and check the rubber for cracks, splits and roughness. If damaged, replace the blade immediately to prevent damage to the glass.

Contaminants on the windshield, or on the wiper blades, can reduce the effectiveness of the wiper blades. Contaminants include ice, wax spray from car washes, washer fluid with bug and/or water repellent, bird droppings, tree sap, and other organic substances.

Follow these guidelines for cleaning:

- Clean the windshield using non-abrasive glass cleaner.
- Wipe the blades clean using isopropyl (rubbing) alcohol or washer fluid.

If the wipers remain ineffective after cleaning, replace the wiper blades.

For optimum performance, wiper blades should be replaced at least once a year.

To replace wiper blades:

1. Lift the wiper arm away from the windshield.
2. Press the locking tab while sliding the blade down the arm.
3. To install the new blade, align the new blade on the wiper arm and slide it toward the hooked end of the arm until it locks into place.
4. Place the wiper arms with the blades against the windshield.



If the problem persists with new blades, clean the windshield and wiper blades using a soft cloth or sponge and warm water with

non-detergent soap. Then, rinse the windshield and wiper blades with clean water. The windshield is clean when water beads do not form.



CAUTION: Only use cleaning products approved for use on automotive glass and rubber. Inappropriate products can cause damage or smears, and create glare on the windshield.



CAUTION: Only install replacement blades that are identical to the original blades. Using inappropriate blades can damage the wiper system and affect the operation of the rain sensor.

Cleaning Washer Jets

The position of the windshield washers is set at the factory and should never need adjusting.

If a windshield washer becomes blocked, use a thin strand of wire to clear any blockages from the nozzle.

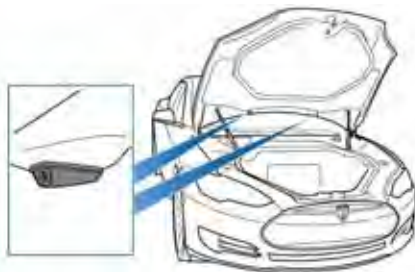

WARNING: Do not operate the washers while cleaning Model S. Windshield washer fluid can irritate eyes and skin. Read and observe the washer fluid manufacturer's instructions.



Removing the Maintenance Panel

To access fuses and check fluid levels, remove the maintenance panel:

1. Pull the rear edge of the maintenance panel upward to release the five clips that hold the panel in place.
2. Maneuver the maintenance panel toward the windshield to remove.



CAUTION: The maintenance panel protects the front trunk from water. When re-attaching, make sure it is fully seated.

Checking Battery Coolant

If the quantity of fluid in the cooling system drops below the recommended level, the instrument panel displays a warning message. Stop Model S as soon as safety permits and call Roadside Assistance to have Model S transported to Tesla.

Fluid Level Check

Tesla checks the Battery coolant level at the regularly scheduled maintenance intervals. To check it yourself, park Model S on level ground. When Model S is cool, remove the maintenance panel (see page 7.16).

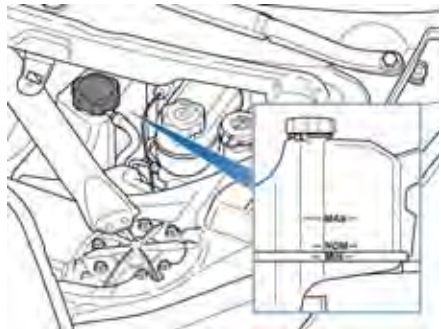

Check the fluid level visually by looking at the outside marks on the side of the reservoir. **DO NOT REMOVE THE FILLER CAP AND DO NOT ADD FLUID.** Doing so can result in damage not covered by the warranty.

The fluid level should be between the **MIN** and the **MAX** marks. If you notice that the fluid level has dropped significantly, contact Tesla before using Model S.

Topping Up the Battery Coolant

Under no circumstances should you add coolant. If the instrument panel warns you that the fluid level is low, contact Tesla immediately.

To maximize the performance and life of the Battery, the cooling system uses a specific type of G-48 ethylene-glycol coolant (HOAT). Contact Tesla for more specific information about the coolant.



Checking Brake Fluid

! **WARNING:** Contact Tesla immediately if you notice increased movement of the brake pedal or a significant loss of brake fluid. Driving under these conditions can result in extended stopping distances or complete brake failure.



The Brake indicator on the instrument panel alerts you if the quantity of fluid in the brake reservoir drops below the recommended level. If it displays while driving, stop as soon as safety permits by gently applying the brakes. Do not continue driving. Contact Tesla immediately for assistance.

Fluid Level Check

Tesla checks the brake fluid level at the regularly scheduled maintenance intervals. To check it yourself, park Model S on level ground. When Model S is cool, remove the maintenance panel (see page 7.16).



Check the fluid level visually by looking at the outside marks on the side of the reservoir without removing the filler cap.

The brake fluid level should be between the **MIN** and the **MAX** marks.

NOTE: The brake fluid level drops slightly during normal use, as a result of brake pad wear, but should not be allowed to drop below the MIN mark.

Topping Up the Brake Fluid

Do not top up your brake fluid. Tesla service does this when you bring Model S in for regular servicing. The following instructions are provided for information purposes and future reference only:

1. Clean the filler cap before removing to prevent dirt from entering the reservoir.
2. Unscrew the cap and remove.
3. Top up the reservoir to the **MAX** mark using brake fluid meeting DOT3 or DOT4 specifications.
4. Replace the filler cap.

! **WARNING:** Only use new fluid from a sealed air-tight container. Never use previously used fluid or fluid from a previously opened container—fluid absorbs moisture which decreases braking performance.

! **WARNING:** Brake fluid is highly toxic. Keep containers sealed and out of the reach of children. In the event of accidental consumption, seek medical attention immediately.



CAUTION: Brake fluid damages painted surfaces. Immediately soak up any spills with an absorbent cloth and wash the area with a mixture of car shampoo and water.



Topping Up Washer Fluid

Model S has only one reservoir into which you can add fluid. This is the washer fluid reservoir under the front trunk. When the level is low, a message displays on the instrument panel. Fill until the fluid level is visible just below the filler neck.

Do not use formulated washer fluids that contain water repellent or bug wash. These fluids can cause streaking, smearing, and squeaking, or other noises.

Operate the washers periodically to check that the nozzles are clear and properly directed.

To top up washer fluid:

1. Clean the filler cap before opening to prevent dirt from entering the reservoir.
2. Open the filler cap.

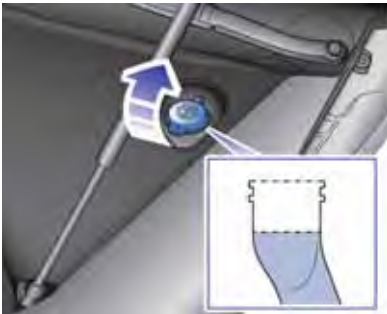

3. Fill the reservoir until the fluid is visible just below the filler neck.
4. Replace the filler cap.

NOTE: Some national or local regulations restrict the use of Volatile Organic Compounds (VOCs). VOCs are commonly used as antifreeze in washer fluid. Use a washer fluid with limited VOC content only if it provides adequate freeze resistance for all climates in which you drive Model S.



CAUTION: Under no circumstances do you need to inspect or top up other fluid reservoirs. Two additional fluid reservoirs are located next to the washer fluid, but underneath the maintenance panel. In the unlikely event that you see a message on the instrument panel that one of these fluid levels is low, stop Model S as soon as safety permits, and contact Tesla.



CAUTION: Do not spill washer fluid on body panels. Doing so can cause damage. Wipe up spills immediately and wash the affected area with water.



WARNING: In temperatures below 4°C, use a washer fluid with antifreeze. In cold weather, using a washer fluid without antifreeze can impair visibility through the windshield.



Fuse Box Locations

Three fuse boxes are located under the maintenance panel, located in the front trunk. For instructions on how to remove this panel, see page 7.16.

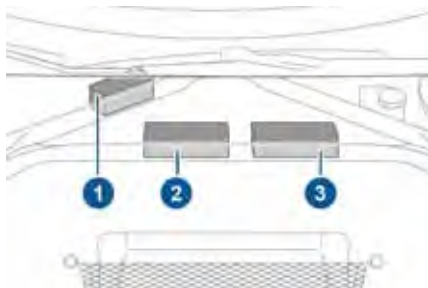

1. Fuse box 1 (see page 7.20). **DO NOT** replace these fuses. If one of them fails, contact Tesla.
2. Fuse box 2. (see page 7.21).
3. Fuse box 3 (see page 7.22).

If Model S is equipped with the cold weather option, an additional fuse box (4) is located under the driver's side trim panel.

Replacing a Fuse

To remove a fuse box cover, press the plastic tabs on either side.

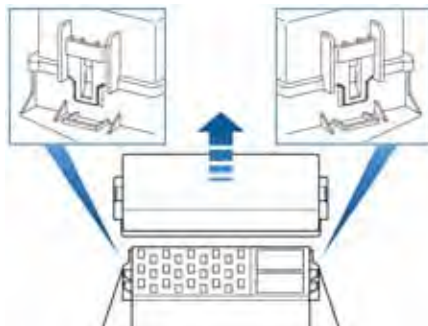



Identify the fuse protecting the affected circuit. Refer to the label on the inside of the fuse box cover or the fuse tables provided in this section.

Pull the fuse to remove it. A break in the wire inside the fuse indicates that the fuse has blown.

NOTE: Do not replace fuses in fuse boxes 1 and 4, and do not remove or replace any relays. If one of these fails, contact Tesla.

 **WARNING:** Always manually power Model S off before replacing a fuse (see page 4.6).

 **CAUTION:** Only use Tesla approved replacement fuses of the same rating and specification. Using an incorrect fuse can damage the electrical system and result in a fire.

 **CAUTION:** If a replacement fuse blows after installation, contact Tesla to have the electrical system checked.



Fuse Box 1

Access to fuse box 1 requires removal of components that must be performed by a Tesla service technician. The following fuse list is provided only to assist you in determining if a fuse in this box needs to be replaced. Contact Tesla Service if one of these fuses needs to be replaced.

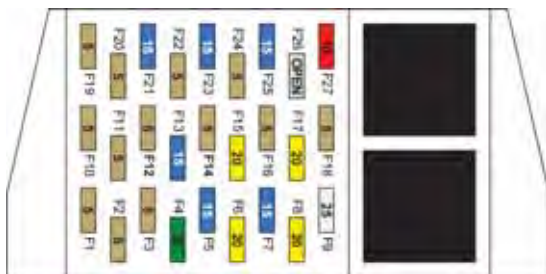

Fuse	Rating	Circuit Protected
NOTE: THESE FUSES MUST BE REPLACED BY A TESLA SERVICE TECHNICIAN		
1	5 A	Accessory sensor, radio, USB hub
2	5 A	Headlight leveling system (EU/China Coil Suspension vehicles only)
3	5 A	Vanity lights, rear view mirror
4	30 A	Outboard rear seat heaters (cold weather option)
5	15 A	Seat heater (driver's seat)
6	20 A	Base audio amplifier
7	15 A	Seat heater (front passenger seat)
8	20 A	Premium audio amplifier
9	25 A	Sunroof
10	5 A	Passive safety restraints
11	5 A	Steering column controls
12	5 A	Sensor for Drive mode and Yaw Rate (Stability/Traction Control)
13	15 A	Wiper park
14	5 A	Drive inverter
15	20 A	Electric parking brake
16	5 A	Parking/blind spot sensors
17	20 A	Electric parking brake
18	5 A	Not used
19	5 A	In-vehicle HVAC sensor
20	5 A	Cabin air heater logic
21	15 A	Battery coolant pump 1
22	5 A	Inlet actuators
23	15 A	Powertrain coolant pump
24	5 A	Cabin climate control
25	15 A	Battery coolant pump 2
26	-	Not used
27	10 A	Thermal controller



Fuse Box 2

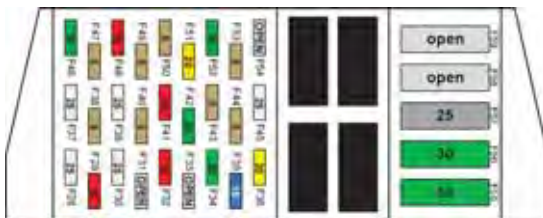

Fuse	Rating	Circuit Protected
28	25 A	Window lift motor (right rear)
29	10 A	Contactator power
30	25 A	Window lift motor (right front)
31	-	Not used
32	10 A	Door controls (right side)
33	-	Not used
34	30 A	Rear center seat heaters, washer/wiper de-ice (cold weather option)
35	15 A	12V power socket
36	25 A	Air suspension
37	25 A	Window lift motor (left rear)
38	5 A	Driver's seat memory
39	25 A	Window lift motor (left front)
40	5 A	Rear door handles
41	10 A	Door controls (left side)
42	30 A	Powered liftgate
43	5 A	Perm. power sensor, brake switch
44	5 A	Charger (charge port)
45	20 A	Passive entry (horns)
46	30 A	Body controls (group 2)
47	5 A	Glove box light
48	10 A	Body controls (group 1)
49	5 A	Instrument panel
50	5 A	Siren, intrusion/tilt sensor (Europe only)
51	20 A	Touchscreen
52	30 A	Heated rear window
53	5 A	Battery management system
54	-	Not used
55	30 A	Left front electric seat
56	30 A	Right front electric seat
57	25 A	Cabin fan
58	-	Not used
59	-	Not used



Fuse Box 3

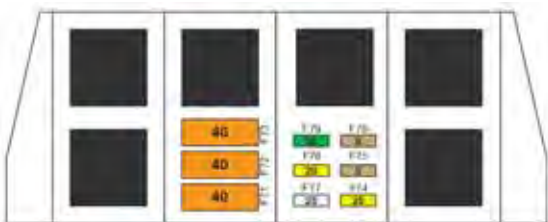

Fuse	Rating	Circuit Protected
71	40 A	Condenser fan (left)
72	40 A	Condenser fan (right)
73	40 A	Vacuum pump
74	20 A	12V drive rail (cabin)
75	5 A	Power steering
76	5 A	ABS
77	25 A	Stability control
78	20 A	Headlights - high/low beam
79	30 A	Light - exterior/interior

Fuse Box 4

If Model S is equipped with the cold weather option, an additional fuse box (4) is located under the driver's side trim panel. Access to fuse box 4 requires removal of several components that must be performed by a Tesla service technician. The following fuse list is provided only to assist you in determining if a fuse in this box needs to be replaced. Contact Tesla Service if one of these fuses needs to be replaced.



Fuse	Rating	Circuit Protected
NOTE: THESE FUSES MUST BE REPLACED BY A TESLA SERVICE TECHNICIAN		
101	15 A	Left rear seat heater
102	15 A	Right rear seat heater
103	15 A	Middle rear seat heater control
104	15 A	Middle rear seat heater
105	15 A	Wiper de-icer
106	-	Not used



Jacking Procedure

Follow the steps below to lift Model S. Ensure that any non-Tesla repair facility is aware of these lifting points.

1. Position Model S centrally between the lift posts.
2. If your Model S is equipped with Active Air Suspension, it automatically self-levels, even when power is off. Use the touchscreen to set the suspension as follows:
 - Touch **Controls**.
 - Press the brake pedal, then touch **Very High** to maximize the height of the suspension.
 - Touch **Jack** to disable self-leveling.



When Jack mode is active, Model S displays this indicator light on the instrument panel, along with a message telling you that active suspension is disabled.

NOTE: Jack mode cancels automatically when Model S is driven over 7 km/h.

3. Position the lift arm pads under the body rails at the locations illustrated. **DO NOT** position the lift arm pads under the Battery.
4. Adjust the height and position of the lift arm pads to ensure they are correctly located.
5. With assistance, raise the lift, ensuring the lift arm pads remain in their correct positions.

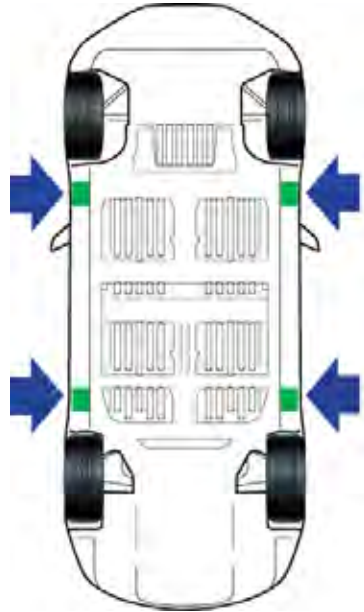

WARNING: If your Model S is equipped with Active Air Suspension, it automatically self-levels, even when power is off. You **MUST** disable this system by engaging Jack mode before lifting or jacking. If you do not disable Active Air Suspension, Model S can attempt to self-level, causing serious damage, bodily injury, or death.

WARNING: Never raise Model S when the charging cable is connected, even if charging is not in progress.

WARNING: Do not work on an incorrectly supported vehicle. Doing so can cause serious damage, bodily injury, or death.

CAUTION: **DO NOT** lift from under the Battery. Place the lift arm pads under the body rails only. The locations illustrated are the only approved lifting points for Model S. Lifting at any other points can cause damage. Damage caused by lifting Model S is not covered by the warranty.



Parts, Accessories, and Modifications

Use only genuine Tesla parts and accessories. Tesla performs rigorous testing on parts to ensure their suitability, safety, and reliability. Purchase these parts from Tesla, where they are professionally installed and where you can receive expert advice about modifications to Model S.

Tesla is unable to assess parts manufactured by other distributors and therefore accepts no responsibility if you use non-Tesla parts on Model S.

 **WARNING:** Installing non-approved parts and accessories, or performing non-approved modifications, can affect the performance of Model S and the safety of its occupants. Any damage caused by using or installing non-approved parts, or by performing non-approved modifications, is not covered by the warranty.

 **WARNING:** Tesla does not accept liability for death, personal injury or damage that occurs if you use or install non-approved accessories or make non-approved modifications.

Body Repairs

If Model S is in a collision, contact Tesla to ensure that it is repaired with genuine Tesla parts. Tesla has selected collision repair centers that meet strict requirements for training, equipment, quality, and customer satisfaction.

Some repair shops and insurance companies might suggest using non-original equipment or salvaged parts to save money. However, these parts do not meet Tesla's high standards for quality, fit and corrosion resistance. In addition, non-original equipment and salvaged parts (and any damage or failures they might cause) are not covered by the warranty.



Identification Labels

Vehicle Identification Number.....	8.2
------------------------------------	-----

Vehicle Loading

Load Capacity Labeling.....	8.3
Calculating Load Limits.....	8.4
Towing a Trailer.....	8.4

Dimensions and Weights

Exterior Dimensions.....	8.5
Weights.....	8.5

Subsystems

Motor.....	8.6
Transmission.....	8.6
Steering.....	8.6
Brakes.....	8.6
Suspension.....	8.7
Battery - 12V.....	8.7
Battery - High Voltage.....	8.7

Wheels and Tires

Wheel Specifications.....	8.8
Wheel Alignment Values.....	8.8
Tire Specifications.....	8.8
Understanding Tire Markings.....	8.10



Vehicle Identification Number

You can find the VIN at the following locations:

- The top of the dashboard, stamped on a plate that can be seen by looking through the windshield.



- Stamped on the chassis. Can be seen by removing the maintenance panel (see page 7.16).



- Printed on the Statutory Plate, located on the driver's side door pillar. Visible when the driver's door is open.





Load Capacity Labeling

It is important to understand how much weight your Model S can safely carry. This weight is called the vehicle capacity weight and includes the weight of all occupants, cargo and any additional equipment added to your Model S since it was manufactured.

There are two labels attached to Model S that state how much weight it can safely carry. These labels are located on the center door post and are visible when the driver's door is open:

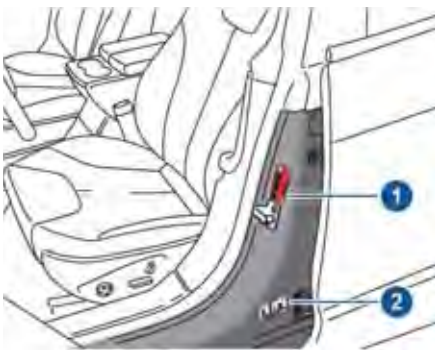

1. Tire and Loading Information label
2. Statutory Plate

WARNING: Overloading Model S has an adverse effect on braking and handling, which can compromise your safety or damage Model S.

CAUTION: Never load more than 136 kg in the front trunk. Doing so can cause damage.

CAUTION: Never store large amounts of liquid in Model S. Significant liquid spills can cause electrical components to malfunction.

Tire and Loading Information Label

The Tire and Loading Information label provides:

- The maximum number of occupant seating positions.
- The maximum vehicle capacity weight.
- The size of the original tires.
- The cold inflation pressures for the original front and rear tires. These pressures are recommended to optimize ride and handling characteristics.



NOTE: Never change this label, even if you use different tires in the future.

If Model S is loaded to its full capacity, double check all tires to ensure they are inflated to their recommended pressure levels.



Statutory Plate

In addition to the VIN, the Statutory Plate provides:

- GVWR - Gross Vehicle Weight Rating. The maximum allowable total mass of Model S. This is calculated as the weight of Model S, all passengers, fluids, and cargo.
- GAWR - Gross Axle Weight Rating for the front and rear axles. The GAWR is the maximum distributed weight that each axle can support.

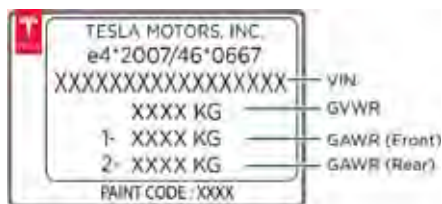

 CAUTION: To prevent damage, never load Model S so that it is heavier than the GVWR or exceeds the individual GAWR weights.

Calculating Load Limits

1. Locate the statement “The combined weight of occupants and cargo should never exceed XXX kg or XXX lbs” on your vehicle’s “Tire and Loading Information” label.
2. Determine the combined weight of the driver and passengers that will be riding in the vehicle.
3. Subtract the combined weight of the driver and passengers from XXX kg or XXX lbs (see Step 1).
4. The resulting figure equals the available amount of cargo and luggage load capacity. For example, if the “XXX” amount equals 635 kg, and there will be five 68 kg passengers in the vehicle, the amount of available cargo and luggage capacity is 294 kg (635 - 340 (5 x 68) = 294 kg).
5. Determine the combined weight of cargo and luggage being loaded on the vehicle. That weight must not exceed the available cargo and luggage load capacity calculated in Step 4.

 **WARNING:** The front and rear trunks are the preferred places to carry objects. In an accident, or during hard braking and sharp turns, loose items in the cabin could injure occupants.

Example Load Limit Calculations

How much cargo you can carry in Model S depends on the number and weight of passengers. The following are typical examples of calculated load limits. These examples assume passengers weighing 68 kg. If the passengers weigh more or less, the available cargo and luggage load capacity decreases or increases respectively.

Example 1: Driver and one passenger

Description	Total
Vehicle capacity weight	433 kg
Subtract occupant weight (2 x 68 kg)	136 kg
Available cargo weight	297 kg

Example 2: Driver and four passengers

Description	Total
Vehicle capacity weight	433 kg
Subtract occupant weight (5 x 68 kg)	340 kg
Available cargo weight	93 kg

The available cargo or luggage weight should then be distributed between the front and rear trunks.

 CAUTION: Do not exceed the maximum front trunk load weight of 136 kg.

Towing a Trailer

 **WARNING:** Do not tow a trailer. Model S does not support a trailer hitch. Installing one could damage Model S and increase the risk of an accident.



Exterior Dimensions



A	Overall Length	196 in	4,970 mm
B	Overall Width (including mirrors)	86.2 in	2,189 mm
C	Overall Height	57 in	1,445 mm
D	Wheel Base	116.5 in	2,960 mm
E	Overhang - Front	37 in	929 mm
F	Overhang - Rear	42.5 in	1080 mm
G	Ground Clearance (air suspension)	5.35 in	136 mm
H	Track - Front	65.4 in	1,662 mm
	Track - Rear	66.9 in	1,700 mm

Weights

Curb Weight* (assuming the 85 kWh Battery)	4,630 lbs	2,100 kg
Gross Vehicle Weight Rating	Printed on the Statutory Plate. See page 8.4.	
Gross Axle Weight Rating - Front		
Gross Axle Weight Rating - Rear		
Trailer Towing	Not permissible	
*Curb Weight = weight of the vehicle with correct fluid levels, no occupants and no cargo		



Motor

Type	AC induction motor, liquid-cooled, with variable frequency drive
Rating	375 Volts
Maximum Speed	16000 rpm

Transmission

Type	Single speed fixed gear
Overall Final Drive Ratio	9.73:1
Reverse Gear	Reverse direction of motor, limited to 24 km/h

Steering

Type	Rack and pinion with electronic power steering Variable ratio and speed sensitive
Number of turns lock to lock	2.45
Turning Circle (curb to curb)	11.3 metres

Brakes

Type	4-wheel anti-lock braking system (ABS) with Electronic Brake Force Distribution, Integrated Advanced Stability Control and Electronic Accelerator pedal actuated regenerative braking system
Calipers	Four piston fixed
Rotor Diameters (ventilated)	Front: 13.98"/355 mm Rear: 14.37"/365 mm
Front Rotor thickness	New: 1.26"/32 mm Service limit: 1.18"/30 mm
Rear Rotor thickness	New: 1.10"/28 mm Service limit: 1.02"/26 mm
Front Brake Pad Thickness (excluding back plate)	New: 0.354"/9.0 mm Service limit: 0.078"/2 mm
Rear Brake Pad Thickness (excluding back plate)	New: 0.315"/8.0 mm Service limit: 0.078"/2 mm
Electronic Parking Brake (EPB) Pad Thickness (excluding back plate). Electronic calipers self-adjust for pad wear.	New: 0.216"/5.5 mm Service limit: 0.039"/1 mm
Parking brake	Electrically actuated parking brake calipers



Suspension

Front	Independent, double wishbone Air spring or coil spring/telescopic damper Sway bar
Rear	Independent Multi-link Air spring or coil spring/telescopic damper Sway bar (air suspension vehicles only)
For alignment values, see page 8.8.	

Battery - 12V

Type	EXIDE U1R370XPW Maintenance free, sealed for life
Rating	35 amp-hr Cold Cranking Amps (CCA): 320 A
Voltage and Polarity	12V negative (-)

Battery - High Voltage

Type	Liquid-cooled Lithium ion (Li-ion)
Rating	60 or 85 kWh (at beginning of life)
Voltage and Polarity	366V DC Negative (-) ground
Temperature Range	Do not expose the High Voltage Battery to ambient temperatures above 60° C or below -30° C for more than 24 hours at a time.



Wheel Specifications

Wheel Type	Location	Size	Offset
19"	Front	8.0J x 19	40 mm
	Rear	8.0J x 19	40 mm
21" - Silver (standard)	Front	8.5J x 21	40 mm
21" - Grey (standard)	Rear	8.5J x 21	40 mm
21" - Silver and Grey (optional) Performance Plus vehicles	Rear	9.0J x 21	40 mm

Road Wheel Nut Torque	129 lb.ft
Requirements for dynamic wheel balance	14 grams
NOTE: For instructions on how to jack/lift Model S, see page 7.23.	

Wheel Alignment Values

Location	Air Suspension		Coil Suspension	
	Front	Rear	Front	Rear
Camber	-0.75° +/- 0.35°	-1.75° +/- 0.35°	-.53° +/- 0.35°	-1.55° +/- 0.35°
Camber Split	-0.00° +/- 0.20°	-0.00° +/- 0.50°	-0.00° +/- 0.20°	-0.00° +/- 0.50°
Caster	4.00° +/- 0.50°	n/a	3.70° +/- 0.50°	n/a
Caster Split	0.00° +/- 0.20°	n/a	0.00° +/- 0.20°	n/a
Single Wheel Toe	OUT 0.05° IN 0.15° 0.05°	IN 0.20° +/- 0.05°	IN 0.02° OUT 0.08° IN 0.12°	IN 0.185° +/- 0.05°
Thrust Angle	n/a	0.00° +/- 0.30°	n/a	0.00° +/- 0.30°
Suspension Bolt Height (at design)	213.5 +/- 5 mm	Standard models: 144 +/- 5 mm Performance Plus: 151 +/- 5 mm	230 mm (nominal)	158 mm (nominal)



Tire Specifications

Tire Type	Location	Size
19" wheels: Goodyear Eagle RS-A2	All	P245/45R19 98V
21" wheels on standard vehicles: Michelin Pilot Sport	All	P245/35R21 96Y
21" wheels on Performance Plus vehicles: Michelin	Front Rear	P245/35R21 96Y P265/35R21 101Y
Tire pressures vary depending on the type of tires fitted on Model S. Refer to the tire pressures printed on the Tire and Loading Information label. This label is located on the driver's door pillar and is visible when the driver's door is open (see page 7.3).		
Winter tires (Pirelli Sottozero or Nokian Studded - P245/45R19) can be purchased from a Tesla store.		



Understanding Tire Markings

Laws require tire manufacturers to place standardized information on the sidewall of all tires. This information identifies and describes the fundamental characteristics of the tire.





1	Tire category. P indicates that the tire is for passenger vehicles.
2	Tire width. This 3-digit number is the width (in millimeters) of the tire from sidewall edge to sidewall edge.
3	Aspect ratio. This 2-digit number is the sidewall height as a percentage of the tread width. So, if the tread width is 205 mm, and the aspect ratio is 50, the sidewall height is 102 mm.
4	Tire construction. R indicates that the tire is of Radial ply construction.
5	Wheel diameter. This 2-digit number is the diameter of the wheel rim in inches.
6	Load index. This 2 or 3-digit number is the weight each tire can support. This number is not always shown.
7	Speed rating. When stated, indicates the maximum speed (in mph) at which the tire can be used for extended periods. Q 99 T 118 V 149 R 106 U 124 W 168 S 112 H 130 Y 186
8	Tire composition and materials. The number of plies in both the tread area and the sidewall area indicates how many layers of rubber coated material make up the structure of the tire. Information is also provided on the type of materials used.
9	Maximum tire load. The maximum load which can be carried by the tire.
10	Maximum permissible inflation pressure. This pressure should not be used for normal driving.
11	U.S. DOT Tire Identification Number (TIN). Begins with the letters DOT and indicates that the tire meets all federal standards. The next 2 digits/letters represent the plant code where it was manufactured, and the last 4 digits represent the week and year of manufacture. For example, the number 1712 is used to represent the 17th week of 2012. The other numbers are marketing codes used at the manufacturer's discretion. This information can be used to contact consumers if a tire defect requires a recall.
12	Treadwear grade. This number indicates the tire's wear rate. The higher the treadwear number is, the longer it should take for the tread to wear down. A tire rated at 400, for example, lasts twice as long as a tire rated at 200.
13	Traction grade. Indicates a tire's ability to stop on wet roads. A higher graded tire should allow you to stop your vehicle in a shorter distance than a tire with a lower grade. Traction is graded from highest to lowest as AA, A, B, and C.
14	Temperature grade. The tire's resistance to heat is grade A, B, or C, with A indicating the greatest resistance. This grading is provided for a correctly inflated tire, which is being used within its speed and loading limits.



About Roadside Assistance

Contacting Roadside Assistance.....	9.2
Regional Roadside Assistance Numbers.	9.2

Instructions for Transporters

Use a Flatbed Only	9.3
Disable Self-Leveling (air suspension vehicles only)	9.3
Activate Tow Mode	9.3
Connect the Tow Chain	9.3
Pull Onto the Trailer and Secure the Wheels.....	9.4



Contacting Roadside Assistance

Tesla Roadside Assistance is available to you, 24 hours a day, 365 days a year for the duration of your warranty period.

To contact Roadside Assistance, call the number for your region, listed on this page.

Advise the representative of the vehicle identification number (VIN), license plate number, mileage, your location, and the nature of the problem. The VIN is on the upper dashboard on the driver's side of your vehicle and is visible through the windshield.

For a complete description of the terms and conditions of the Tesla Roadside Assistance Program, refer to the policy that was provided to you by Tesla when you purchased Model S.

It is your responsibility to provide vehicle transporters with instructions on how to transport Model S (see page 9.3).

Regional Roadside Assistance Numbers

A toll free number is available in most European regions. If a toll free number is not listed below, go to www.teslamotors.com to check if a toll free number has become available in your area.

Andorra (Toll)	+ 31 (0)13 799 9501
Andorra (Toll Free)	+ 0800 914 590
Austria (Toll)	+ 31 (0)13 799 9502
Austria (Toll Free)	+ 0800 88 0992
Belgium (Toll)	+ 31 (0)13 799 9503
Belgium (Toll Free)	+ 0800 29 027
Bulgaria (Toll)	+ 31 (0)13 799 9504
Croatia (Toll)	+ 31 (0)13 799 9505
Cyprus (Toll)	+ 31 (0)13 799 9506
Czech Republic (Toll)	+ 31 (0)13 799 9507
Denmark (Toll)	+ 31 (0)13 799 9508
Denmark (Toll Free)	+ 800 71 1024
Estonia (Toll)	+ 31 (0)13 799 9509
Finland (Toll)	+ 31 (0)13 799 9510
France (Toll)	+ 31 (0)13 799 9511
France (Toll Free)	+ 0800 94 1029
Germany (Toll)	+ 31 (0)13 799 9512
Germany (Toll Free)	+ 0800 5893542
Gibraltar	+ 31 (0)13 799 9513
Greece (Toll)	+ 31 (0)13 799 9514

Greece (Toll Free)	+ 0800 1809 205 0645
Hungary (Toll)	+ 31 (0)13 799 9515
Iceland (Toll)	+ 31 (0)13 799 9516
Ireland (Toll)	+ 31 (0)13 799 9517
Italy (Toll)	+ 31 (0)13 799 9518
Italy (Toll Free)	+ 800 122 709
Latvia	+ 31 (0)13 799 9519
Liechtenstein (Toll)	+ 31 (0)13 799 9520
Liechtenstein (Toll Free)	+ 0800 558 847
Lithuania (Toll)	+ 31 (0)13 799 9521
Luxembourg (Toll)	+ 31 (0)13 799 9522
Luxembourg (Toll Free)	+ 0800 8002 2538
Malta (Toll)	+ 31 (0)13 799 9523
Monaco (Toll)	+ 31 (0)13 799 9524
Monaco (Toll Free)	+ 0800 94 1029
Netherlands (Toll)	+ 31 (0)13 799 9525
Netherlands (Toll Free)	+ 0800 0200160
Norway (Toll)	+ 31 (0)13 799 9527
Norway (Toll Free)	+ 800 11 093
Poland (Toll)	+ 31 (0)13 799 9528
Poland (Toll Free)	+ 800 141 01492
Portugal (Toll)	+ 31 (0)13 799 9529
Romania (Toll)	+ 31 (0)13 799 9530
San Marino (Toll)	+ 31 (0)13 799 9531
Slovakia (Toll)	+ 31 (0)13 799 9532
Slovenia (Toll)	+ 31 (0)13 799 9533
Spain (Toll)	+ 31 (0)13 799 9534
Sweden (Toll)	+ 31 (0)13 799 9535
Switzerland (Toll)	+ 31 (0)13 799 9536
Switzerland (Toll Free)	+ 0800 83 7521
United Kingdom (Toll)	+ 31 (0)13 799 9537
United Kingdom (Toll Free)	+ 0800 358 5774



Use a Flatbed Only

Use a flatbed trailer only, unless otherwise specified by Tesla. Do not transport Model S with the tires directly on the ground.



 **CAUTION:** Damage caused by transporting is not covered by the warranty.

To transport Model S, follow the instructions exactly as described next.

Disable Self-Leveling (air suspension vehicles only)

If Model S is equipped with Active Air Suspension, it automatically self-levels, even when power is off. To prevent damage, you must activate JACK mode to disable self-leveling:

1. Touch **CONTROLS** on the bottom left of the touchscreen.
2. Press the brake pedal, then touch **Controls > Very High** to maximize height.
3. Touch **Jack**.



When Jack mode is active, Model S displays this indicator light on the instrument panel, along with a message telling you that active suspension is disabled.

NOTE: Jack mode cancels when Model S is driven over 7 km/h.

 **CAUTION:** Failure to activate Jack mode can cause Model S to become loose while being transported, resulting in significant damage.

Activate Tow Mode

Model S automatically shifts into Park whenever you open the door to exit, even if you shifted into Neutral. To keep Model S in Neutral (which disengages the parking brake), you must activate tow mode:

1. Shift into Park.

2. Press the brake pedal, then on the touchscreen, touch **Controls > E-Brake & Power Off > Tow Mode**.



When Tow mode is active, Model S displays this indicator light on the instrument panel, along with a message telling you that Model S is free rolling.

NOTE: Tow mode cancels when Model S is shifted into Park.



CAUTION: If the electrical system is not working, and you therefore cannot release the electric parking brake, attempt to quick start the 12V battery. For instructions, call the number noted on the previous page. If a situation occurs where you cannot disengage the parking brake, use tire skids or transport Model S for the shortest possible distance using wheeled dollies. Before doing so, always check the dolly manufacturer's specifications and recommended load capacity.

Connect the Tow Chain

1. Remove the nose cone.

Insert a plastic pry tool into the top right corner, and gently pry the nose cone towards you. When the clip releases, pull the nose cone towards you, without twisting or bending it, to release the three remaining clips.



CAUTION: Do not use a metal object (such as a screwdriver). Doing so can damage the nose cone and the surrounding area.



2. Insert the towing eye.

Fully insert the towing eye (found in the front trunk) into the opening on the right side, then turn counter-clockwise until securely fastened.



3. Attach the tow chain to the towing eye.



CAUTION: Before pulling, make sure the towing eye is securely tightened.

Pull Onto the Trailer and Secure the Wheels

Secure wheels using chocks and tie-down straps:

- Ensure any metal parts on the tie-down straps do not contact painted surfaces or the face of the wheels.



- Do not place straps over body panels or through the wheels.



CAUTION: Attaching straps to the chassis, suspension or other parts of the body can cause damage.



CAUTION: To prevent damage, do not transport Model S with the tires directly on the ground.



Disclaimers

Vehicle Telematics/Data Recorders	10.2
Quality Control	10.2

Reporting Concerns

Contacting Tesla	10.3
------------------------	------



Vehicle Telematics/Data Recorders

This vehicle is equipped with electronic modules that monitor and record data from various vehicle systems, including the motor, Battery, braking and electrical systems. The electronic modules record information about various driving and vehicle conditions, including braking, acceleration, trip and other related information regarding your vehicle. These modules also record information about the vehicle's features such as charging events and status, the enabling/disabling of various systems, diagnostic trouble codes, VIN, speed, direction and location.

The data is stored by the vehicle and may be accessed, used and stored by Tesla service technicians during vehicle servicing or periodically transmitted to Tesla wirelessly through the vehicle's telematics system. This data may be used by Tesla for various purposes, including, but not limited to: providing you with Tesla telematics services; troubleshooting; evaluation of your vehicle's quality, functionality and performance; analysis and research by Tesla and its partners for the improvement and design of our vehicles and systems; and as otherwise may be required by law. In servicing your vehicle, we can potentially resolve issues remotely simply by reviewing your vehicle's data log.

Tesla's telematics system wirelessly transmits vehicle information to Tesla on a periodic basis. The data is used as described above and helps ensure the proper maintenance of your vehicle. Additional Model S features may use your vehicle's telematics system and the information provided, including features such as charging reminders, software updates, and remote access to, and control of, various systems of your vehicle.

Tesla does not disclose the data recorded in your vehicle to any third party except when:

- An agreement or consent from the vehicle's owner (or the leasing company for a leased vehicle) is obtained.
- Officially requested by the police or other authorities.
- Used as a defense for Tesla in a lawsuit.
- Ordered by a court of law.

- Used for research purposes without disclosing details of the vehicle owner or identification information.
- Disclosed to a Tesla affiliated company, including their successors or assigns, or our information systems and data management providers.

In addition, Tesla does not disclose the data recorded to an owner unless it pertains to a non-warranty repair service and in this case, will disclose only the data that is related to the repair.

Quality Control

You might notice a few kms on the odometer when you take delivery of your Model S. This is a result of a comprehensive testing process that ensures the quality of your Model S.

The testing process includes extensive inspections during and after production. The final inspection takes place at Tesla Motors and includes a road test conducted by a Tesla technician.



Contacting Tesla

For detailed information about your Model S, go to www.teslamotors.com, click the MYTESLA link, then enter your login credentials (or sign up to get these credentials).

If you have any questions or concerns about your Model S, call Tesla. To find the number for your region, go to www.teslamotors.com, select your region at the bottom of the page, then view contact information.

A

ABS (Anti-lock Braking System)	4-20
access panel, removing	7-16
accessories, installing	7-24
accessories, plugging into power socket	5-16
air circulation	5-9
air conditioning	
operating tips	5-10
overview	5-8
air distribution	5-9
air filter	5-10
air suspension	
automatic adjustments	5-11
indicator lights	5-11
Jack mode	5-11
manual settings	5-11
air vents	5-10
airbags	
after a collision	3-18
front passenger, disabling	3-17
how they work	3-16
indicator lights	3-18
inflation effects	3-18
location of	3-15
safety information	3-18
types of	3-16
alarm	5-22
antifreeze	7-16
anti-lock braking (ABS)	4-20
audio	
devices, connecting	5-16
devices, playing from	5-15
playing files	5-15
steering wheel buttons	4-3
automatic car washes	7-12

B

backup camera	4-24
battery (12V)	
going flat	6-4
specifications	8-7
Battery (high voltage)	
care of	6-4
coolant	7-16
discharge, impact of	6-4
fluid check	7-16
general information	6-4
specifications	8-7
temperature limits	6-4
battery (key), replacing	2-3
Bluetooth	
audio devices, connecting	5-15
general information	5-17
phone, connecting	5-18
phone, contacts and media	5-17
phone, disconnecting	5-17
phone, pairing	5-17
phone, unpairing	5-17

body repairs	7-24
body touch up	7-14
brake fluid replacement	7-2
brakes	
anti-lock (ABS)	4-20
emergency braking	4-20
fluid level	7-17
inspecting	4-20
regenerative braking	4-21
specifications	8-6
wear	4-20

C

cabin temperature control	5-8
camera (rear view)	4-24
capacity weight	8-3
car cover	7-14
car washes	7-12
carpets, cleaning	7-13
chains	7-6
charge cable	
connecting	6-5
disconnecting	6-5
charge current	6-7
charge levels	6-7
charge port	6-5
charge port light	6-6
charging	
adapters	6-3
charge port	6-5
connecting the charge cable	6-5
current setting	6-7
disconnecting the charge cable	6-5
equipment summary	6-3
High Power Wall Connector	6-3
instructions	6-5
light	6-6
mobile equipment for	6-3
public charging stations	6-3
set charge limit	6-7
settings	6-7
status	6-8
stopping	6-5
charging schedule, setting	6-7
child protection	
disabling liftgate	2-5
disabling rear door handles	2-5
locking rear windows	2-7
child seats	
choosing	3-7
general guidelines	3-7
installation methods	3-8
installing multiple	3-9
ISOFIX type, installing	3-9
larger children	3-8
rear facing, opening	3-11
rear facing, restrictions	3-11
rear facing, safety	3-14
rear facing, seating a child	3-13

INDEX

safety information	3-10
seat belt retained, installing	3-8
testing	3-10
upper tether straps	3-10
cleaning	
exterior	7-12
interior	7-13
climate control	
operating tips	5-10
overview	5-8
cold weather option	4-15
console	
armrests	2-14
cup holders	2-14
power socket	5-16
USB ports	5-16
contact information	
Tesla	10-3
coolant	
Battery (high voltage)	7-16
replacement of	7-2
cornering lights	4-13
cruise control	4-23
cup holders	2-14
current, charging	6-7
customizing Model S	5-6
D	
DAB radio	5-13
dashboard overview	1-2
data recording	10-2
de-icing	4-15
delivery mileage	10-2
devices	
Bluetooth, playing audio files	5-15
connecting	5-16
playing audio files from	5-15
dimensions	8-5
dome (map) lights	4-11
door handles	
exterior	2-4
interior	2-4
door labels	8-3
doors	
child protection locks	2-5
drive-away locking	2-5
interior rear, opening with no power	2-6
locking and unlocking, key	2-2
locking and unlocking, touchscreen	2-4
opening exterior, no power	2-5
opening, exterior handles	2-4
opening, interior handles	2-4
unlocking when key does not work	2-5
walk-away locking	2-5
drive gear	4-7
drive-away locking	2-5

driver	
profiles, creating	4-2
seat adjustment	3-2
seating position	3-2
driving	
energy gains	4-21
seating position	3-2
starting Model S	4-6
tips to maximize range	4-19

E

electric parking brake	4-21
emergency flashers	4-14
emergency rear door opening	2-6
energy	
app	4-19
displaying usage of	4-19
gained from regenerative braking	4-21
graph	4-19
range information	4-8
tips to minimize usage of	4-19
event data recording	10-2
exterior	
car cover	7-14
cleaning	7-12
dimensions	8-5
overview	1-3
polishing, touch up, & repair	7-14
specifications	8-5
exterior lights, controlling	4-11

F

fan speed, interior	5-9
favorites, adding and removing	5-15
features, downloading new	5-24
flash drives	
connecting	5-16
playing audio from	5-15
flashers, warning	4-14
flat tire repair	7-8
floor mats	7-14
fluids	
Battery (high voltage)	7-16
brake	7-17
replacement of	7-2
windshield washer	7-18
fog lights	4-11
free rolling	4-7
front passenger detection	3-17
front suspension specifications	8-7
front trunk	
closing	2-10
opening	2-10

- fuses
 - accessing7-16
 - fuse box 17-20
 - fuse box 27-21
 - fuse box 37-22
 - fuse box locations7-19
 - replacing7-19

- G**
- garage doors, opening5-23
- gates, opening5-23
- GAWR8-4
- gears, shifting4-7
- glove box2-13
- Gross Axle Weight Rating8-4
- Gross Vehicle Weight Rating8-4
- ground clearance8-5
- GVWR8-4

- H**
- hazard warning flashers4-14
- head supports3-3
- headlights4-11
 - after exit4-13
 - cornering lights4-13
- headlights, when cornering4-13
- heated wipers4-15
- heating
 - operating tips5-10
 - overview5-8
- height adjustments (suspension)
 - automatic5-11
 - Jack mode5-11
 - manual settings5-11
- high voltage
 - Battery specifications8-7
 - components, overview of6-2
 - safety6-2, 7-2
- hitches8-4
- HomeLink
 - programming5-23
 - using5-23
- hood
 - closing2-10
 - opening2-10
- horn4-4

- I**
- Ideal range4-8
- identification number (VIN)8-2
- indicator lights
 - ABS4-20
 - air suspension5-11
 - airbag3-18
 - Jack mode5-11
 - summary of4-9
- tire pressure7-3
- traction control4-22
- instrument panel
 - charging status6-8
 - cleaning7-13
 - indicator lights4-9
 - overview4-8
 - power meter4-21
 - when car is off4-8
 - when driving4-8
- interior cleaning7-13
- interior lights, controlling4-11
- interior overview1-2
- interior temperature control5-8
- Internet radio5-14
- intrusion detection5-22
- ISOFIX child seats, installing3-9

- J**
- J17726-3
- Jack mode5-11
- jacking Model S7-23

- K**
- key
 - how to use2-2
 - key not inside4-6
 - not detected2-5
 - ordering extras2-3
 - replacing battery2-3
- keyless entry2-2

- L**
- label
 - Statutory Plate8-4
 - Tire and Loading Information8-3
- lane change flash4-14
- leather care7-13
- liftgate
 - adjust opening height2-8
 - closing2-8
 - disabling interior handle2-5
 - interior release2-9
 - opening2-8
 - opening, no power2-9
- lifting Model S7-23
- lights
 - convenience lights4-11
 - cornering lights4-13
 - exterior4-11
 - fog lights4-11
 - hazard warning4-14
 - headlights4-11
 - headlights after exit4-13
 - interior4-11
 - turn signals4-14

INDEX

loading	
determining load limit	8-4
general information	8-3
information label for	8-3
lock/unlock status	2-4, 4-8
locking	
drive-away	2-5
using the touchscreen	2-4
walk-away	2-5
with key	2-2
lumbar support	3-2

M

maintenance	
brake fluid	7-17
daily checks	7-2
exterior cleaning	7-12
fluid replacement	7-2
fuse replacement	7-19
inspecting tires	7-4
interior cleaning	7-13
monthly checks	7-2
removing access panel	7-16
replacing wiper blades	7-15
service intervals	7-2
tire pressures	7-3
washer fluid	7-18
windshield washer jets	7-15
mats	7-14
media	
DAB radio	5-13
favorites	5-15
Internet radio	5-14
playing audio files	5-15
radio	5-12
Tuneln radio	5-14
volume	4-3
mileage upon delivery	10-2
mirrors	
adjusting	4-5
automatic dimming	4-5
auto-tilt	4-5
rear view	4-5
when reversing	4-5
mobile app	5-25
Mobile Connector	
components	6-3
connecting	6-5
disconnecting	6-5
modifications	7-24
motor specifications	8-6

N

navigation	
entering a destination	5-20
overview	5-19, 5-20
Neutral gear, maintaining	4-7

O

odometer	
on instrument panel	4-8
on touchscreen	4-18

P

Park Assist	
how it works	4-16
limitations and false warnings	4-17
turning chimes on and off	4-17
visual and audio feedback	4-16
park gear	4-7
parking brake	4-21
parts replacement	7-24
passive unlocking	2-2
phone	
Bluetooth, general information	5-17
call menu	5-18
connecting	5-18
importing contacts and media	5-17
instrument panel menu	5-18
making a call	5-18
pairing	5-17
receiving a call	5-18
steering wheel buttons	4-4
unpairing or disconnecting	5-17
power meter	4-21
power on	4-6
power socket	5-16
power windows	2-7
powering off Model S	4-6
powering on Model S	4-6
preferences, setting	5-6
public charging stations	6-3

R

radio	
DAB	5-13
Direct Tune	5-13
favorite stations	5-15
Internet radio	5-14
overview	5-12
traffic alerts	5-14
Tuneln	5-14
rain sensor	4-15

- range
 - displayed on instrument panel4-8
 - driving tips to maximize4-19
 - regenerative braking4-21
 - Rated range4-8
 - rear facing child seats
 - folding3-12
 - opening3-11
 - safety information3-14
 - seating a child3-13
 - usage restrictions3-11
 - rear seats
 - folding3-3
 - raising3-3
 - rear view camera4-24
 - rear window switches, disabling2-7
 - regenerative braking4-21
 - release notes5-24
 - remote window opening2-7
 - reverse gear4-7
 - roadside assistance9-2
- S**
- safety information
 - airbags3-18
 - child seats3-10
 - rear facing child seats3-14
 - seat belts3-6
 - seat belts
 - cleaning7-13
 - fastening3-4
 - in a collision3-5
 - overview3-4
 - pre-tensioners3-5
 - safety instructions3-6
 - testing3-5
 - wearing3-4
 - wearing when pregnant3-4
 - seat covers3-3
 - seat heaters5-8
 - seating capacity8-3
 - seating position, driver3-2
 - seats
 - adjusting3-2
 - heaters5-8
 - rear facing, folding3-12
 - rear facing, opening3-11, 3-12
 - rear facing, safety information3-14
 - rear facing, seating a child3-13
 - rear facing, usage restrictions3-11
 - security settings5-22
 - service data recording10-2
 - service intervals7-2
 - Settings5-6
 - shifting gears4-7
 - software updates5-24
 - specifications
 - 12V battery8-7
 - brakes8-6
 - dimensions8-5
 - exterior8-5
 - high voltage Battery8-7
 - motor8-6
 - steering8-6
 - suspension8-7
 - tires8-8
 - transmission8-6
 - weights8-5
 - wheels8-8
 - stability control4-22
 - starting Model S4-6
 - Statutory Plate8-4
 - steering specifications8-6
 - steering wheel
 - adjusting position4-3
 - adjusting sensitivity4-3
 - controls, left4-3
 - controls, right4-4
 - sunroof2-12
 - suspension
 - automatic adjustments5-11
 - indicator lights5-11
 - Jack mode5-11
 - manual settings5-11
- T**
- telematics10-2
 - telephone
 - answering a call4-4
 - Bluetooth, general information5-17
 - call menu5-18
 - connecting5-18
 - displaying call menu4-4
 - instrument panel menu5-18
 - making a call5-18
 - receiving a call5-18
 - steering wheel buttons4-4
 - temperature
 - Battery (high voltage), limits6-4
 - cabin, controls for5-8
 - cabin, operating tips5-10
 - outside4-8
 - tie-down straps9-4
 - tilt detection5-22
 - Tire Pressure Monitoring System
 - malfunction7-6
 - overview7-6
 - replacing a tire sensor7-7
 - tire pressure, checking7-3
 - tire repair kit7-8
 - inflating with air only7-10
 - inflating with sealant7-9
 - replacing the sealant canister7-11

tires	
asymmetric	7-5
balancing	7-4
chains	7-6
flat spots	7-4
inspecting	7-4, 7-5
installing new	7-5
pressure monitoring	7-6
pressures, how to check	7-3
punctures	7-4
replacing	7-5
replacing a tire sensor	7-7
replacing tire sealant	7-11
rotation of	7-4
specification	8-8
tire sealant	7-8
understanding tire markings	8-10
wear patterns	7-4
winter	7-5
touch up body	7-14
touchscreen	
brightness	5-2
cleaning	7-13
Controls	5-4
overview	5-2
Settings	5-6
software updates	5-24
tow chain, connecting	9-3
Tow mode	9-3
towing	
connecting the tow chain	9-3
Jack mode	9-3
keeping Model S in Neutral	9-3
securing the wheels	9-4
towing a trailer	8-4
towing instructions	9-3
TPMS	
malfunction	7-6
overview	7-6
replacing a tire sensor	7-7
traction control	4-22
traffic alerts	5-14
trailer hitches	8-4
transmission specifications	8-6
transporting	
connecting the tow chain	9-3
Jack mode	9-3
keeping Model S in Neutral	9-3
securing the wheels	9-4
trip information	4-18
trunk, front	
closing	2-10
inside emergency release	2-11
opening	2-10
opening, no power	2-11
trunk, rear	
adjust opening height	2-8
child protection locks	2-5
closing	2-8
disabling interior handle	2-5
interior release	2-9
opening	2-8
opening, no power	2-9
Tire and Loading Information label	8-3
TuneIn	5-14
turn signals	4-14
U	
Units & Format	5-6
unlocking	
passive	2-2
trunk, front	2-10
trunk, rear	2-8
using the touchscreen	2-4
when key does not work	2-5
with key	2-2
USB devices	
connecting	5-16
playing audio files from	5-15
USB ports	5-16
V	
Vehicle Identification Number (VIN)	8-2
vehicle loading	
determining load limit	8-4
general information	8-3
information label	8-3
load calculation examples	8-4
vent, sunroof	2-12
ventilation	5-9, 5-10
VIN (Vehicle Identification Number)	8-2
volume control	4-3, 5-2
W	
walk-away locking	2-5
warning flashers	4-14
warning lights	
ABS	4-20
air suspension	5-11
airbag	3-18
Jack mode	5-11
summary of	4-9
tire pressure	7-3
traction control	4-22
washer fluid, topping up	7-18
washer jets, cleaning	7-15
washers	4-15
weight specifications	8-5

wheel chocks	9-4
wheels	
alignment of	7-4
replacing	7-5
specifications	8-8
windows	
opening and closing	2-7
opening from outside	2-7
rear, child protection	2-7
rear, locking	2-7
using key to open	2-7
using the switch	2-7
windshield washer fluid, topping up	7-18
windshield washer jets	7-15
windshield washers	4-15
windshield wiper blades, replacing	7-15
windshield wipers, using	4-15
winter tires	7-5
wiper blades, replacing	7-15
wipers	4-15

TESLA

Tesla Motors Netherlands B.V.
Atlasstraat 7-9, 5047 RG
Tilburg, Netherlands