

**2015
Avalon
Quick Reference Guide**

2015 Avalon

This *Quick Reference Guide* is a summary of basic vehicle operations. It contains brief descriptions of fundamental operations so you can locate and use the vehicle's main equipment quickly and easily.

The *Quick Reference Guide* is not intended as a substitute for the *Owner's Manual* located in your vehicle's glove box. We strongly encourage you to review the *Owner's Manual* and supplementary manuals so you will have a better understanding of your vehicle's capabilities and limitations.

Your dealership and the entire staff of Toyota Motor Sales, U.S.A., Inc. wish you many years of satisfied driving in your new Avalon.

A word about safe vehicle operations

This *Quick Reference Guide* is not a full description of Avalon operations. Every Avalon owner should review the *Owner's Manual* that accompanies this vehicle.

Pay special attention to the boxed information highlighted in color throughout the *Owner's Manual*. Each box contains safe operating instructions to help you avoid injury or equipment malfunction.

All information in this *Quick Reference Guide* is current at the time of printing. Toyota reserves the right to make changes at any time without notice.

INDEX

OVERVIEW

Engine maintenance	9
Fuel tank door release and cap	8
Hood release	9
Indicator symbols	4-5
Instrument cluster	4
Instrument panel	2-3
Keyless entry^{1,2}	6
Light control-Instrument panel	8
Smart Key system^{1,2}	6-7

FEATURES/OPERATIONS

Air Conditioning/Heating	18-19
Audio	20
Auto lock/unlock²	10
Automatic Transmission	10
Bluetooth® Device Pairing Section	29-38
BSM (Blind Spot Monitor)	21
Clock	20
Cruise control	16
Cup holders	22
Driving mode select	11
Dynamic radar cruise control	17
Garage door opener (HomeLink®) ³	16
iPod®/USB/AUX port	21
Lights¹ & turn signals	15
Moonroof	12
Multi-Information Display	13
Parking brake	10
Power outlets-12V DC	14
Seat adjustments-Front	13
Seat ventilators/Heaters	19
Seats-Head restraints	12
Steering lock release	11
Steering wheel switches	20
Tilt and telescopic steering wheel	11
Windows-Power	12
Windshield wipers & washers	14
Wireless charger	22

SAFETY AND EMERGENCY FEATURES

Door locks	23
Doors-Child safety locks	23
Floor mat installation	27
Seat belts	23
Seat belts-Shoulder belt anchor	24
Spare tire & tools	25
Star Safety System™	26-27
Tire Pressure Monitoring (warning) System	24
Trunk-Internal release	25

¹ Visit your Toyota dealer for information on customizing this feature.

² Programmable by customer. Refer to the *Owner's Manual* for instructions and more information.

³ HomeLink® is a registered trademark of Gentex Corporation.

OVERVIEW

Instrument panel

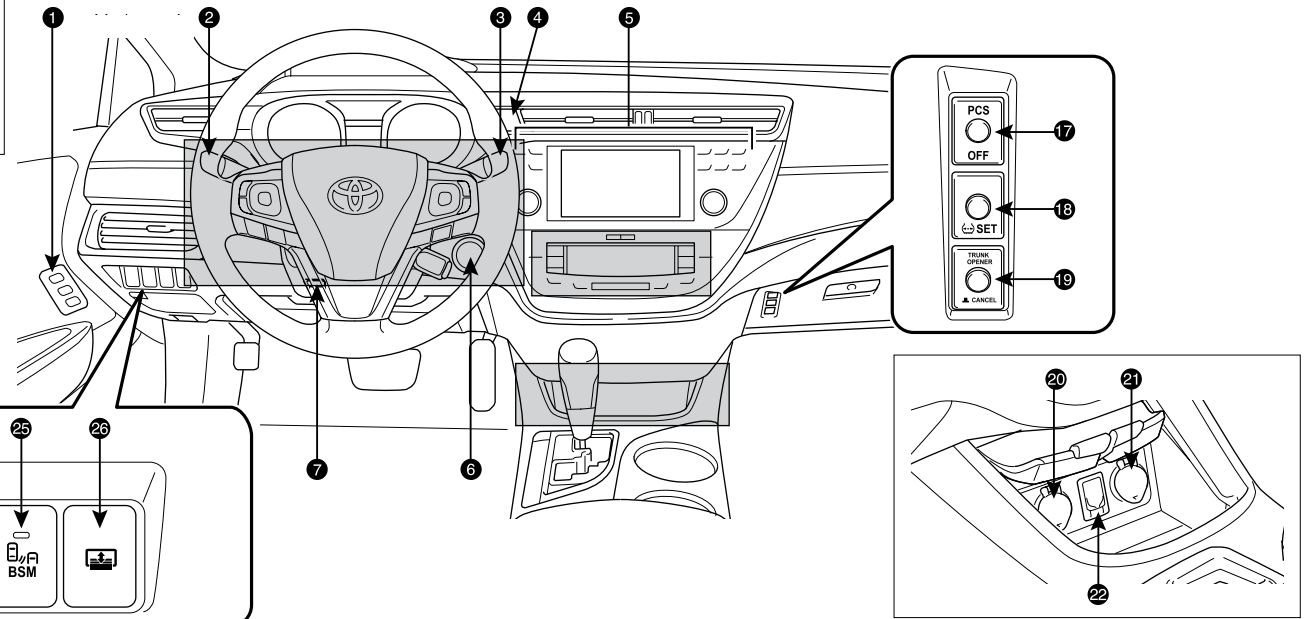
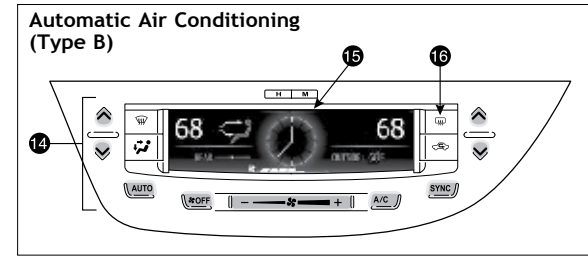
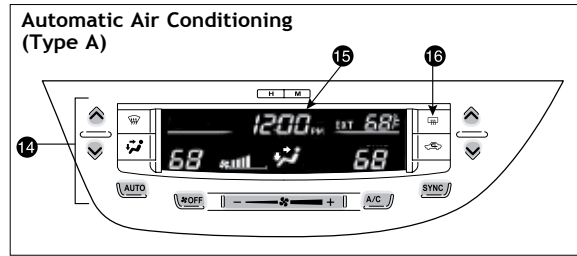
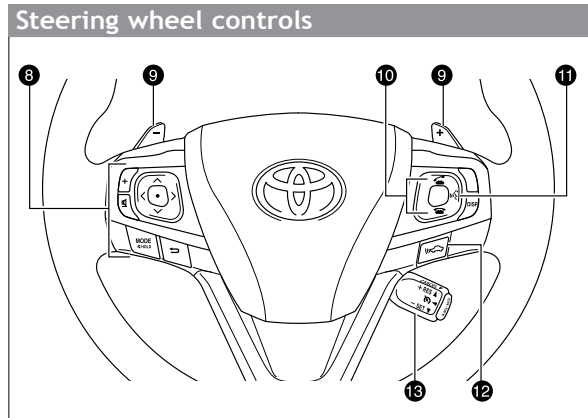

- 1 Driving position memory switches¹
- 2 Headlight and turn signal controls/Headlight, turn signal and front fog light¹ controls
- 3 Wiper and washer controls
- 4 Emergency flasher button
- 5 Navigation system^{1,2}/Display audio system^{1,3}
- 6 “ENGINE START STOP” button
- 7 Tilt and telescopic steering lock release
- 8 Steering wheel audio controls^{2,3}
- 9 Paddle shift switches
- 10 Telephone controls^{2,3}
- 11 Voice command button^{2,3}
- 12 Vehicle-to-vehicle distance button¹
- 13 Cruise control/Dynamic radar cruise control¹
- 14 Air Conditioning controls
- 15 Clock
- 16 Outside rearview mirror/Rear window defogger button

- 17 “PCS” off switch¹
- 18 Tire Pressure Monitoring (warning) System reset
- 19 Trunk opener main switch
- 20 12V DC power outlet
- 21 12V DC power outlet/Wireless charger switch¹
- 22 USB/AUX port
- 23 Trunk opener
- 24 TRAC/VSC OFF switch
- 25 BSM (Blind Spot Monitor) main switch¹
- 26 Rear sunshade switch¹

¹ If equipped

² For details, refer to the “Navigation System Owner’s Manual.”

³ For details, refer to the “Display Audio System Owner’s Manual.”

NOTE: For additional information regarding the Entune (TM) Audio System, please consult the “Navigation System With Entune Quick Reference Guide” or www.toyota.com/entune.

Instrument cluster

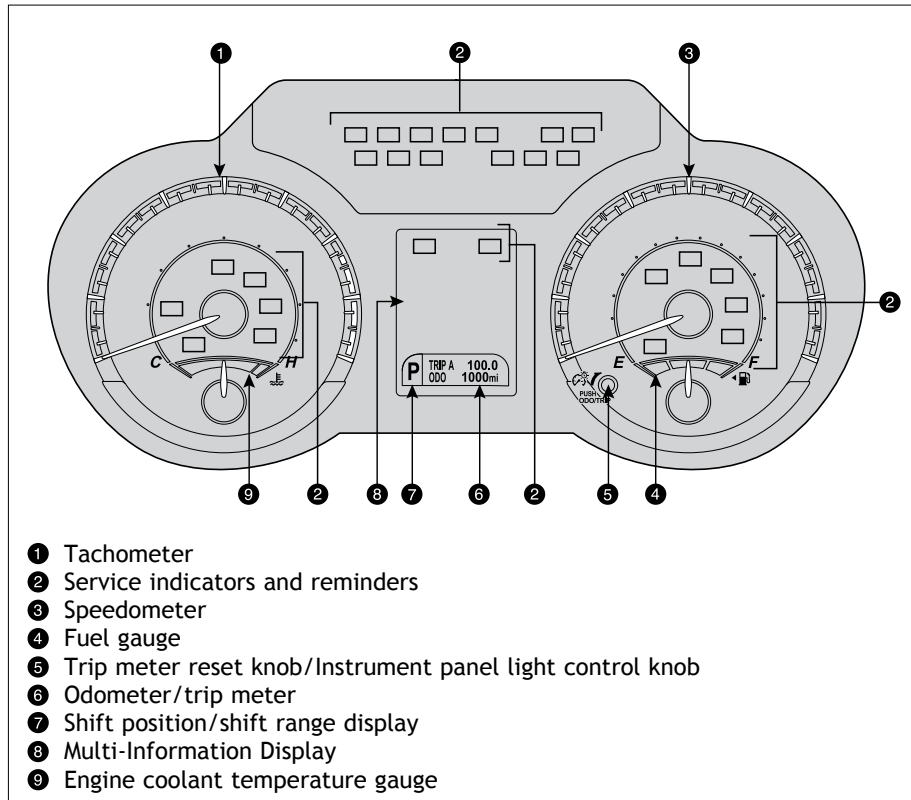

Indicator symbols

For details, refer to “Indicators and warning lights,” Section 2, 2015 Owner’s Manual.

- BRAKE Brake system warning¹
- Driver/Front passenger seat belt reminder (alarm will sound if speed is over 12 mph)
- Electric power steering system warning¹
- Charging system warning¹
- SRS AIR BAG ON/OFF indicator
- Master warning light¹

- Low engine oil pressure warning¹
- Malfunction/Check Engine indicator¹
- Low fuel level warning
- Open door warning
- Airbag SRS warning¹
- Low Tire Pressure Warning¹
- Theft deterrent/Engine immobilizer system indicator
- Headlight low/high beam indicator
- Automatic high beam indicator⁴
- Turn signal indicator
- Front fog light indicator
- Slip indicator¹
- Vehicle Stability Control OFF indicator¹
- Traction Control OFF indicator¹
- SET Cruise control indicator²/Cruise control SET indicator²
- Radar cruise control indicator^{3,4}
- Pre-Collision System indicator^{1,5}
- Anti-lock Brake System warning¹
- ECO drive mode indicator
- SPORT mode indicator
- Eco Driving Indicator Light¹

¹ If indicator does not turn off within a few seconds of starting engine, there may be a malfunction. Have vehicle inspected by your Toyota dealer.





² If this light flashes, refer to “Cruise control,” Section 4-5, 2015 Owner’s Manual.



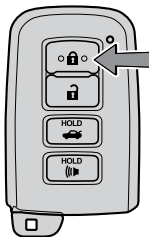

³ If this light flashes, refer to “Dynamic radar cruise control,” Section 4-5, 2015 Owner’s Manual.

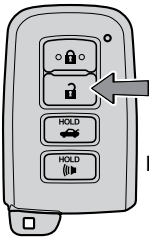
⁴ The indicator flashes to indicate a malfunction.

⁵ The indicator flashes faster than usual to indicate that the system is operating.

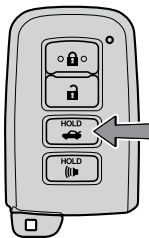
Keyless entry



<p>Locking operation</p>  <p>Push </p>	<p>Unlocking operation</p>  <p>Push ONCE: Driver door TWICE: All doors </p> <p>NOTE: If a door is not opened within 60 seconds of unlocking, all doors will relock for safety.</p>
---	--

<p>Trunk lid</p>  <p>Push and hold </p>	<p>Panic button</p>  <p>Push and hold </p>
--	---

Smart Key system

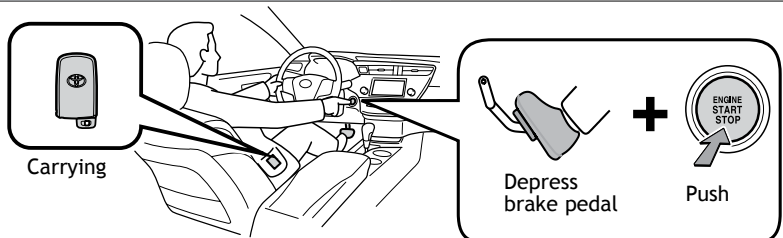
Start function



Carrying  +  +  Push

NOTE: Gear shift lever must be in Park and brake pedal depressed.

Power (without starting engine)

Without depressing the brake pedal, pressing the “ENGINE START STOP” switch will change the operation mode in succession from:

ACCESSORY Accessories such as the radio will operate.

ON Power ON; the engine not running.

OFF All systems OFF.

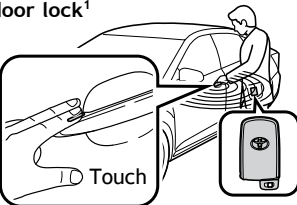
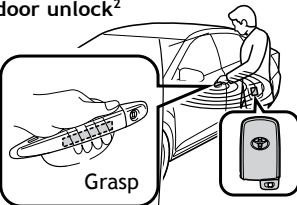
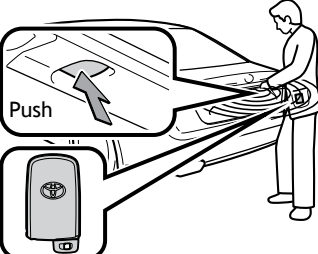
<p>Locking operation</p> <p>Front door lock¹</p>  <p>Carry remote to lock</p>	<p>Unlocking operation</p> <p>Front door unlock²</p>  <p>Carry remote to unlock</p>
<p>Trunk unlock</p>  <p>Carry remote to unlock</p>	

¹ The Smart Key system is only available on driver side door and trunk for the XLE Avalon. All other models will have the Smart Key system on the front doors and trunk.

² Driver door unlocking function can be programmed to unlock driver door only, or all doors. In some models, grasping front passenger door handle will unlock all doors. Please refer to the *Owner's Manual* for more details on how to program the doors.

NOTE: Doors may also be locked/unlocked using remote.

Fuel tank door release and cap

The fuel tank door locks/unlocks with the vehicle's doors.

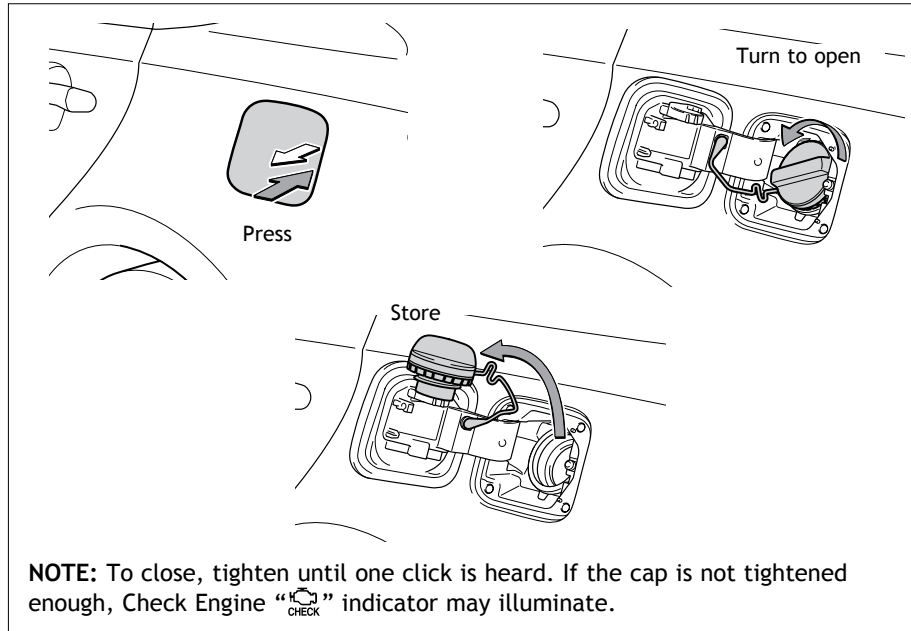

Light control-Instrument panel

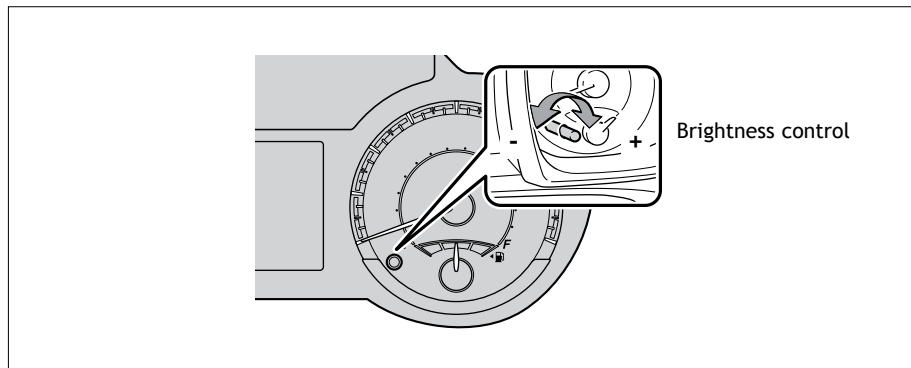

Hood release

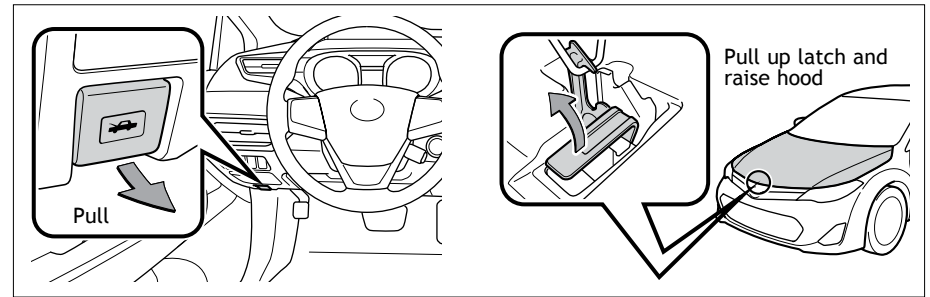

Engine maintenance

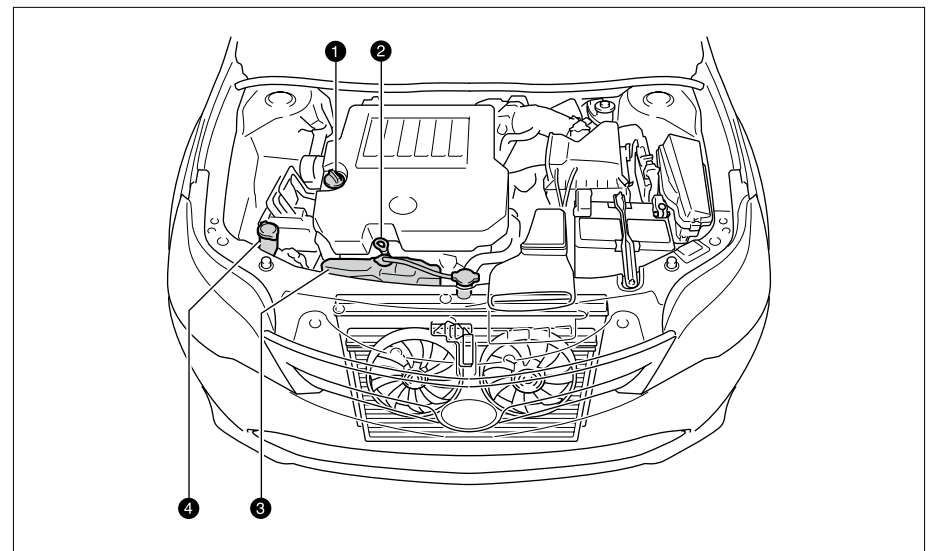

- ❶ Engine oil filler cap
- ❷ Engine oil level dipstick
- ❸ Engine coolant reservoir
- ❹ Windshield washer fluid tank

NOTE: Regularly scheduled maintenance, including oil changes, will help extend the life of your vehicle and maintain performance. Please refer to the “Warranty & Maintenance Guide.”

FEATURES/OPERATIONS

Auto lock/unlock

Automatic door locks can be programmed to operate in four different modes, or turned OFF.

- Doors lock when shifting from Park.
- Doors lock when the vehicle speed goes above approximately 12 mph.
- Doors unlock when shifting into Park.
- Doors unlock when the “ENGINE START STOP” switch is set to OFF and driver’s door is opened.

Refer to the *Owner’s Manual* for more details.

Automatic Transmission

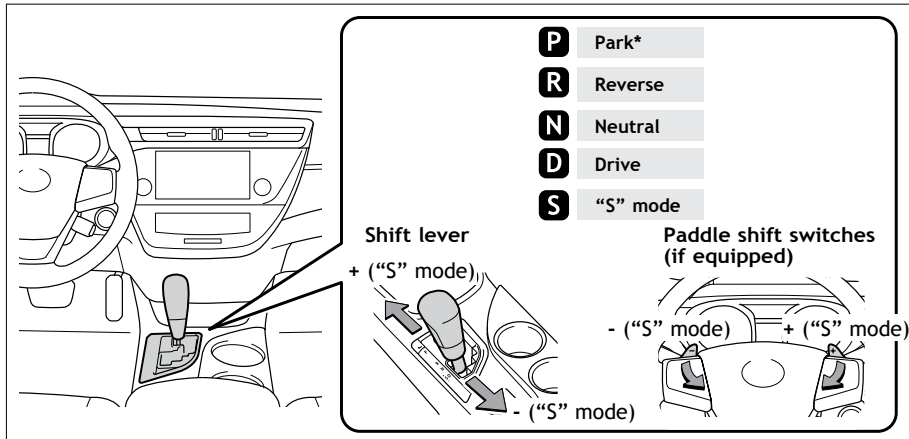

* The “ENGINE START STOP” switch must be IGNITION ON mode and the brake pedal depressed to shift from Park.

“S” (Sequential) mode

Shift the shift lever to “S” position from “D” position.

- +: Upshifting
- : Downshifting

Downshifting increases power going uphill, or provides engine braking downhill. For best fuel economy during normal driving conditions, always drive with the shift lever in the “D” position.

Parking brake

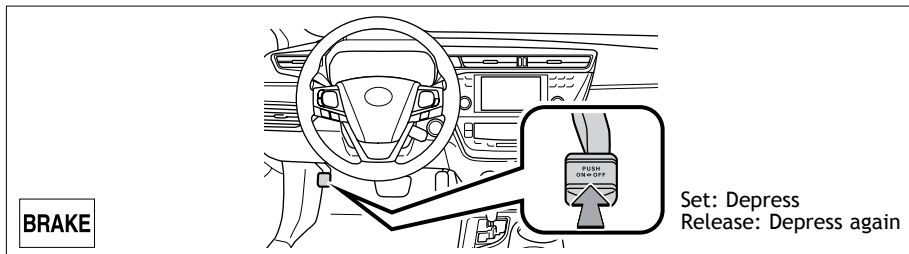

Driving mode select

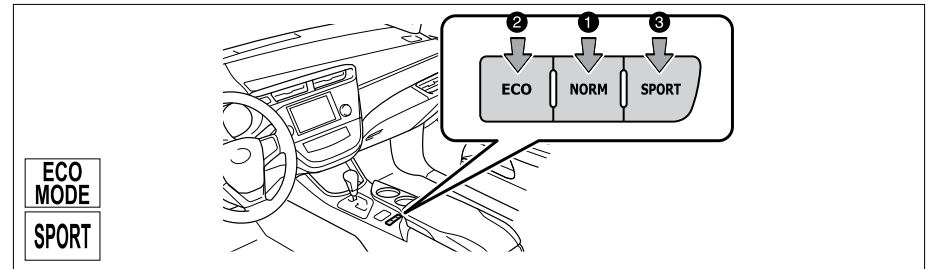

- 1 Normal mode**
Use for normal driving.
- 2 ECO drive mode**
Use ECO drive mode to help achieve low fuel consumption during trips that involve frequent accelerating.
- 3 SPORT mode**
Use SPORT mode when increased acceleration response and precise handling is desired, such as when driving on mountain roads.

Steering lock release

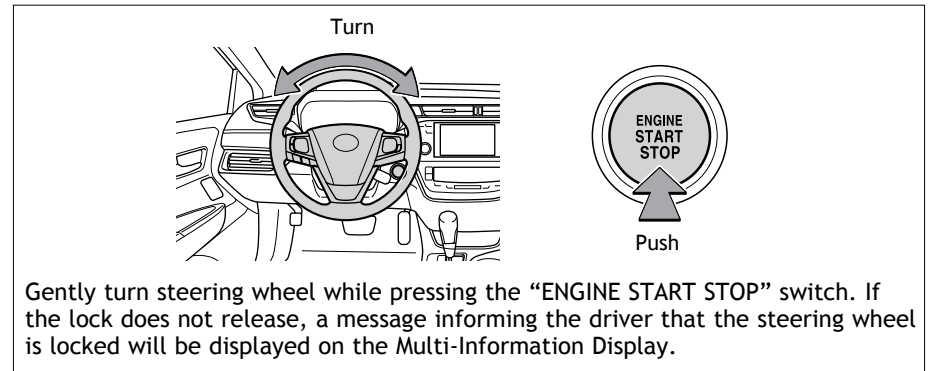

Tilt and telescopic steering wheel

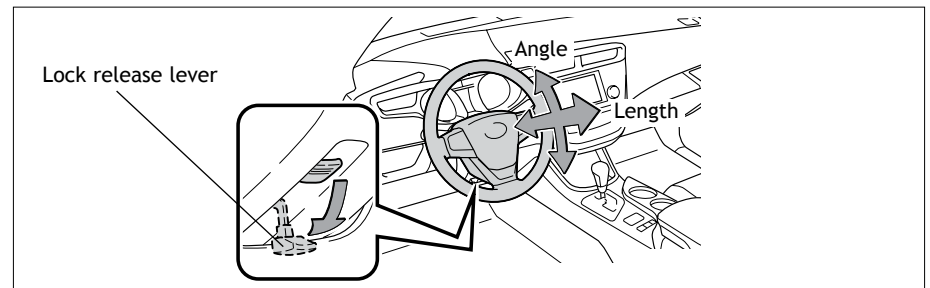

NOTE: Do not attempt to adjust while the vehicle is in motion.

Windows-Power

Driver side

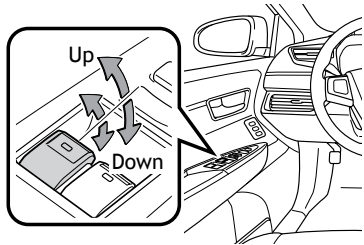

Window lock switch

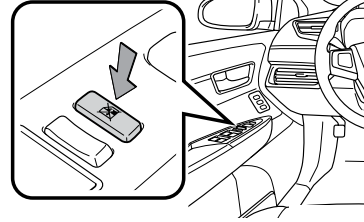

Automatic operation Push the switch completely down or pull it completely up and release to fully open or close. To stop the window partway, operate the switch in the opposite direction.

Window lock switch Deactivates all passenger windows. Driver remains able to operate all windows.

Moonroof (if equipped)

Sliding operation

Push once to open partway; again to open completely.

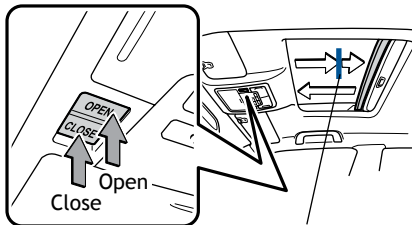

Recommended driving position to minimize wind noise.

Tilting operation

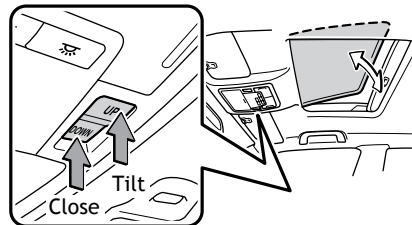

Push once to open; moonroof will automatically stop at the recommended position. Push again to open completely.

Seats-Head restraints

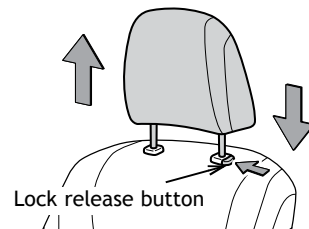

Seat adjustments-Front

Driver's seat

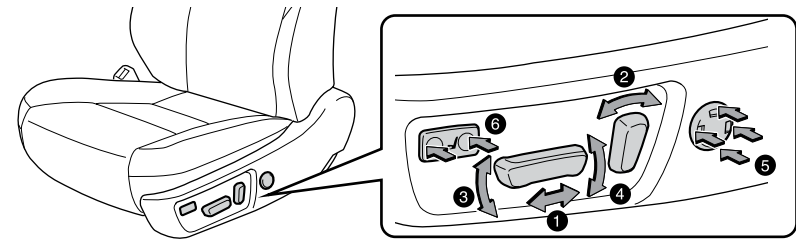

Passenger's seat

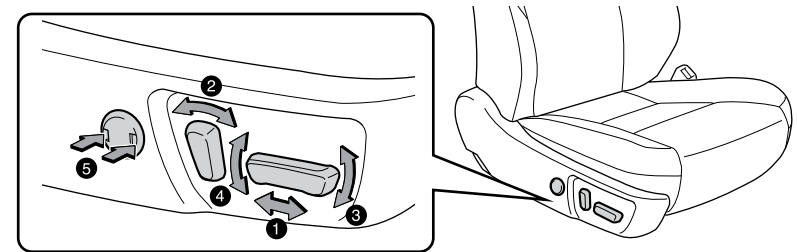

- 1 Seat position (forward/backward)
- 2 Seatback angle
- 3 Seat cushion angle (if equipped)
- 4 Seat height (if equipped)
- 5 Lumbar support (if equipped)
- 6 Seat cushion length (if equipped)

Multi-Information Display

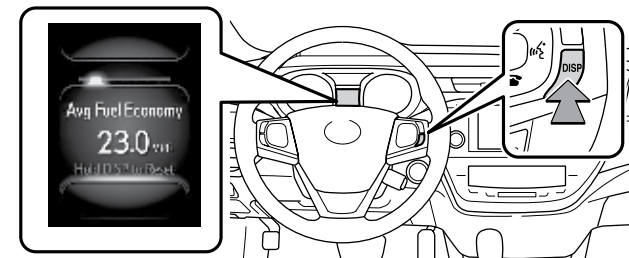

Push "DISP" to scroll through the following information screens:

- (1) Distance to empty
- (2) Average fuel economy
- (3) Current fuel economy
- (4) ECO Drive Level
- (5) Digital speedometer
- (6) Settings

Windshield wipers & washers

With intermittent wiper

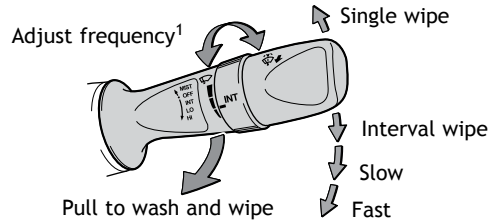

With AUTO rain-sensing wiper (if equipped)

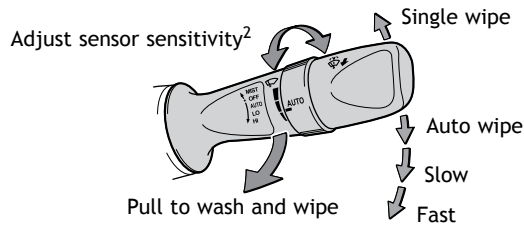

¹ Intermittent windshield wiper frequency adjustment
Rotate to increase/decrease wipe frequency.

² Rain-sensing windshield wiper Rotate to increase/decrease sensor sensitivity.

Power outlets-12V DC

Front console

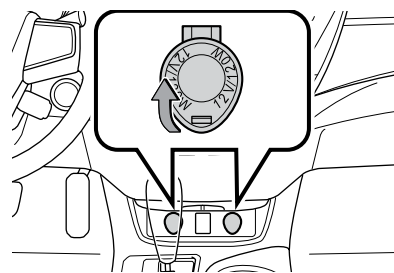

Center console

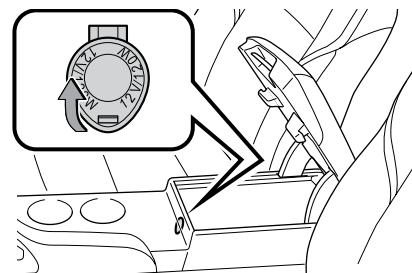

The “ENGINE START STOP” switch must be in the ACCESSORY or IGNITION ON mode for use.

Lights & turn signals

Headlights

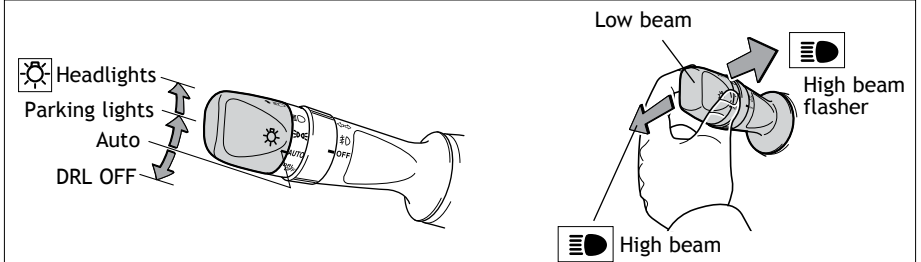

-**Daytime Running Light system (DRL)** Automatically turns on the headlights to make vehicle more visible to other drivers. Not for use at night.
 -**Automatic light cut off system** When the headlights are on: Automatically turns lights off after 30-second delay, or lock switch on remote may be pushed after locking.
 When the tail lights are on: Automatically turns lights off when driver’s door is opened.

Automatic high beam (if equipped)

Activate*

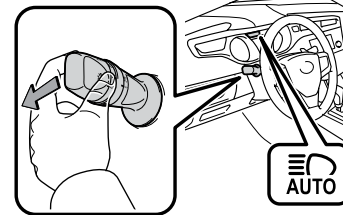

Deactivate

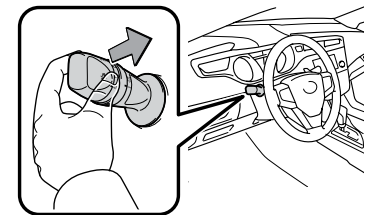

* Refer to the *Owner’s Manual* for details on activating the automatic high beams.

Front fog lights (if equipped)

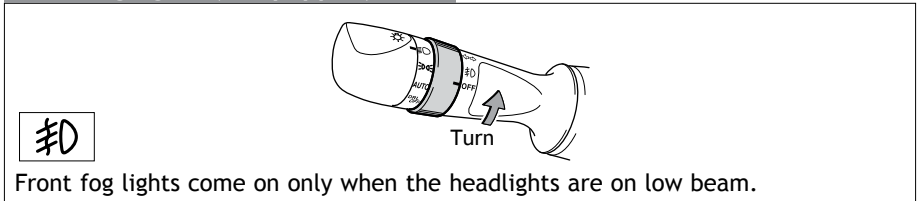

Front fog lights come on only when the headlights are on low beam.

Turn signals

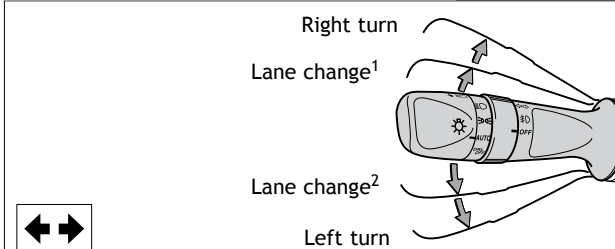

¹ The right hand signals will flash three times.

² The left hand signals will flash three times.

**Garage door opener (HomeLink®)*
(if equipped)**



Garage door openers manufactured under license from HomeLink®* can be programmed to operate garage doors, estate gates, security lighting, etc.

Refer to “Garage door opener,” Section 5-5 in the *Owner’s Manual* for more details.

For programming assistance, contact HomeLink® at 1-800-355-3515, or visit <http://www.homelink.com>.

* HomeLink® is a registered trademark of Gentex Corporation.

Cruise control

Turning system ON/OFF

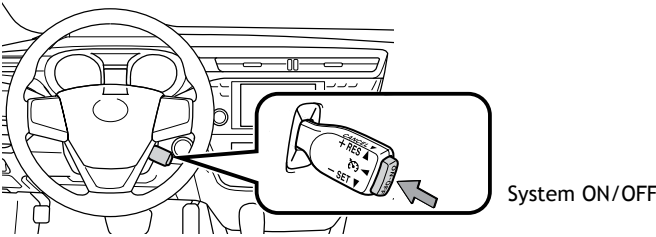

System ON/OFF

Functions

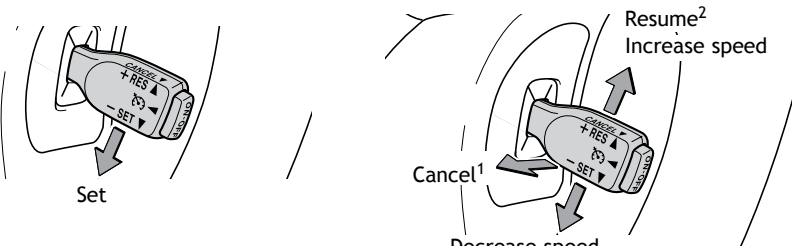

Set

Cancel¹

Resume²

Increase speed

Decrease speed

SET

¹ The set speed may also be cancelled by depressing the brake pedal.
² The set speed may be resumed once vehicle speed exceeds 25 mph.

**Dynamic radar cruise control
(if equipped)**

Refer to the *Owner’s Manual* for more details and complete safety precautions before attempting to use “Dynamic radar cruise control.”

Fixed speed mode

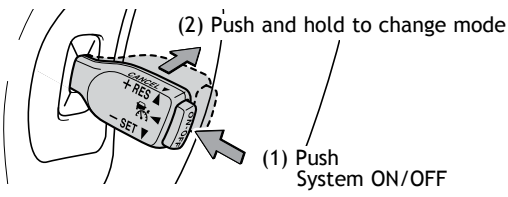

(1) Push System ON/OFF

(2) Push and hold to change mode

To set, cancel and resume a speed Refer to “Functions” in the *Cruise Control* section, and to the *Owner’s Manual* for more details.

Distance control mode

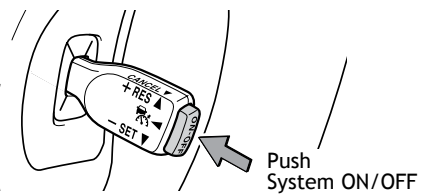

Push System ON/OFF

The distance control mode will cruise at a set speed, decelerate to maintain a selected distance from a slower vehicle traveling in front of you, and accelerate back up to the selected speed if the vehicle in front changes lanes or speeds up.

To set, cancel and resume a speed Refer to “Functions” in the *Cruise Control* section, and your *Owner’s Manual* for more details.

NOTE: Once vehicle speed is set, pushing lever up toward “+ RES” will increase speed by 1 mph, or in 5 mph increments if held. Pushing lever down toward “- SET” will reduce speed in the same way.

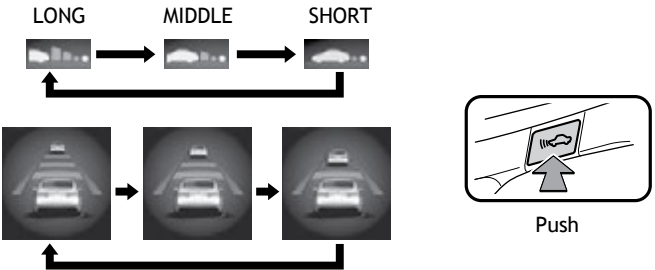

LONG MIDDLE SHORT

Push

To change the vehicle-to-vehicle distance

Push the distance button to cycle through the settings, which will change progressively from LONG to MIDDLE to SHORT.

Air Conditioning/Heating

Front control panel

Type A

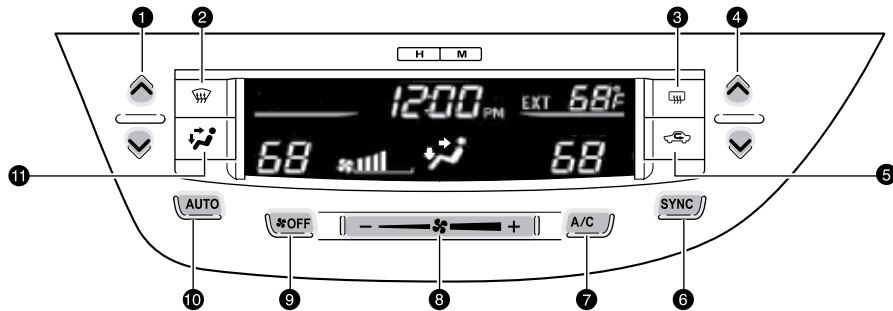

Type B

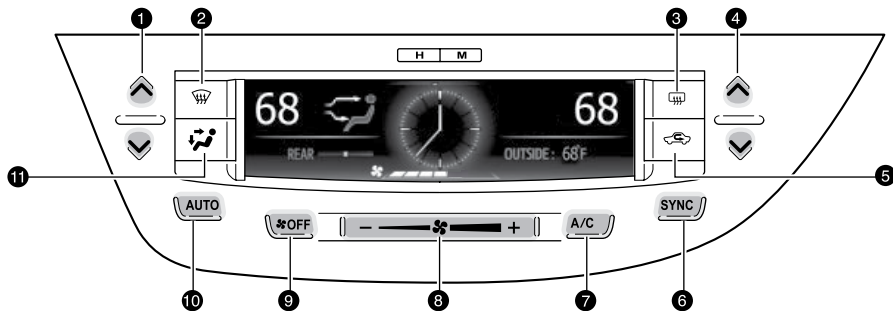

- ❶ Temperature selector (driver side)
 - ❷ Windshield airflow/defogger
 - ❸ Outside rearview mirror/Rear defogger
 - ❹ Temperature selector (passenger side)
 - ❺ Recirculate cabin air (fresh air when OFF)
 - ❻ “SYNC” button
- Indicator ON:** Synchronized temperature settings for driver, passengers and rear seat (if equipped).
- Indicator OFF:** Separate temperature settings for driver and passengers.
- ❼ Air Conditioning ON/OFF
 - ❽ Fan speed
 - ❾ Climate control OFF
 - ❿ Automatic climate control ON
- Adjusting the temperature setting will cause the airflow vents, air intake and fan to adjust automatically.
- ⓫ Airflow vent
- In “/” mode, use fresh air (“” indicator ON) to reduce window fogging.

Rear control panel (if equipped)

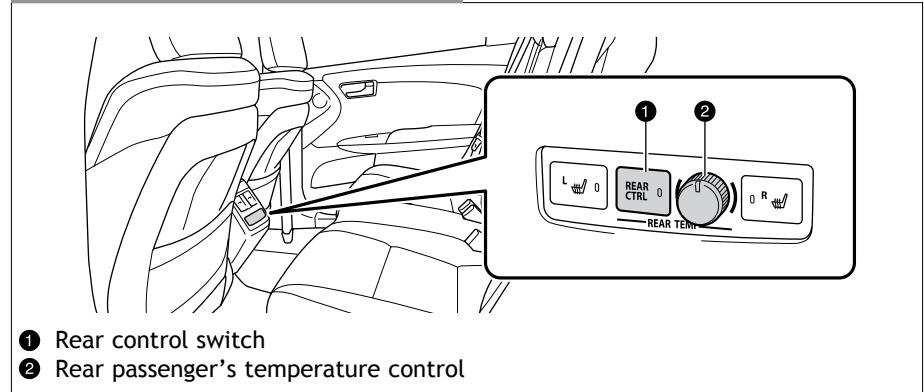

- ❶ Rear control switch
- ❷ Rear passenger's temperature control

Seat ventilators/Heaters (if equipped)

With ventilator

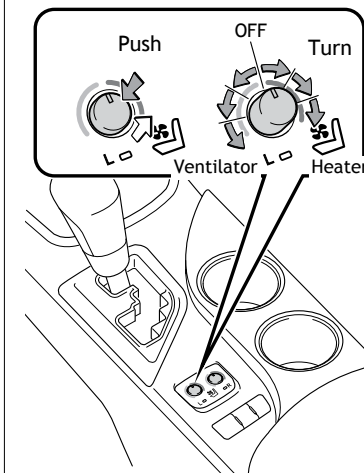

Heater only

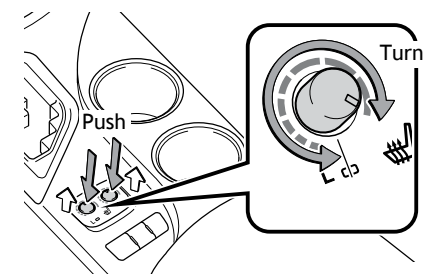

Push knob to pop the controller out.
Turn clockwise for heater, counter-clockwise for ventilator.

Audio*1

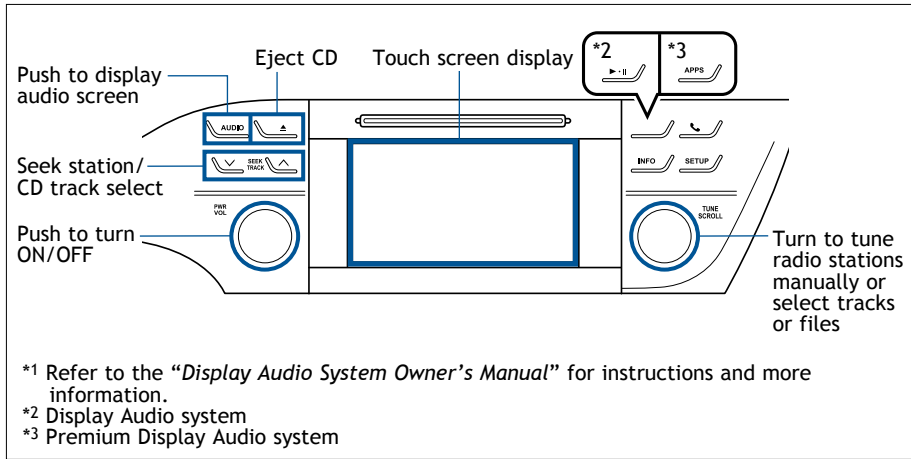

Steering wheel switches

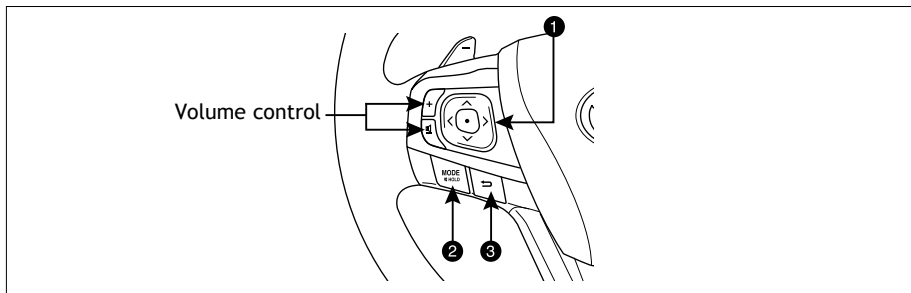

- 1 "V A < >"
Use to search within a selected audio medium (radio, CD, iPod, etc.), or to perform certain telephone operations.
- 2 "MODE"
Push to turn audio ON and select an audio mode. Push and hold to turn the audio system OFF.
- 3 Back switch
Returns to the previous screen.

Clock

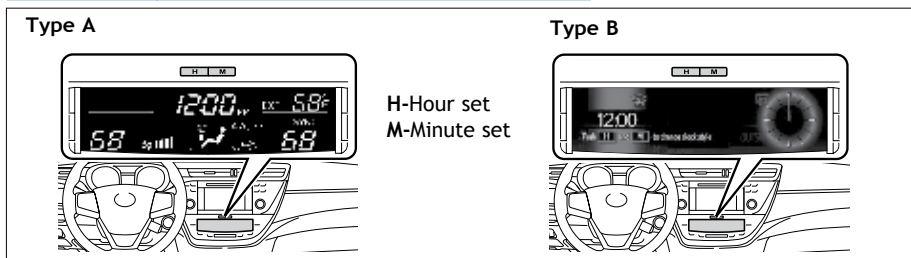

iPod®/USB/AUX port

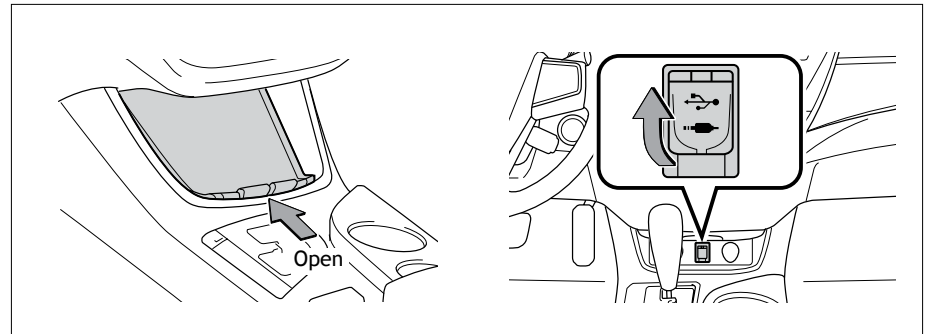

iPod®/USB port

By connecting a USB-compatible portable audio device or USB memory to the USB port, you can listen to music from the portable audio device or USB memory through the vehicle's speaker system.

AUX port

By inserting a mini plug into the AUX port, you can listen to music from a portable audio device through the vehicle's speaker system while in AUX mode.

BSM (Blind Spot Monitor)(if equipped)

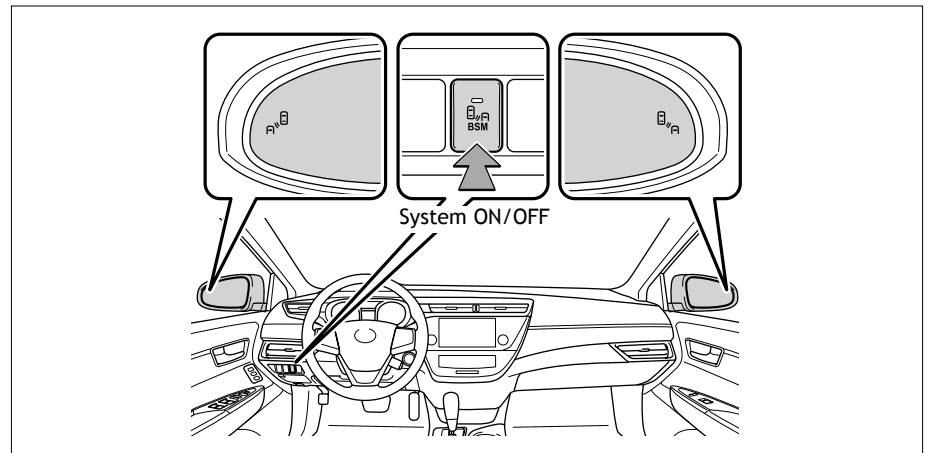

The Blind Spot Monitor is a system that has two functions:

- The Blind Spot Monitor function (assists the driver in making the decision when changing lanes)
- The Rear Cross Traffic Alert function (assists the driver when backing up)

The system uses radar sensors to detect vehicles that are traveling in the area that is not reflected in the outside rearview mirror (the blind spot), and advises the driver of the vehicles' existence via the outside rearview mirror indicator.

Refer to the *Owner's Manual* for more details on this system before attempting to use it.

Wireless charger (if equipped)

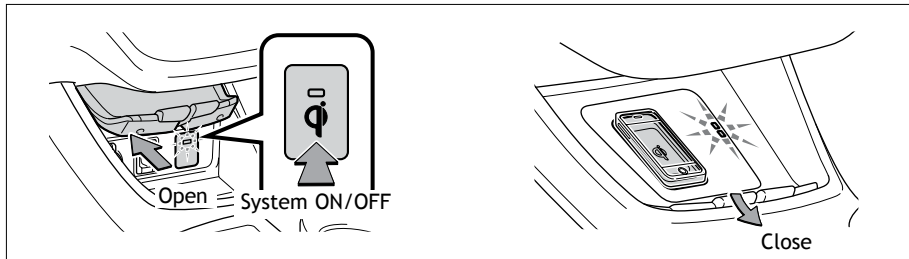

A mobile device with the “ Q ” logo can be charged wirelessly. Charging can only be performed with the “ENGINE START STOP” switch in ACCESSORY or IGNITION ON mode. Place a mobile device on the tray. One LED indicator is illuminated while charging and two LED indicators are illuminated when the charging is complete.

Cup holders

Front

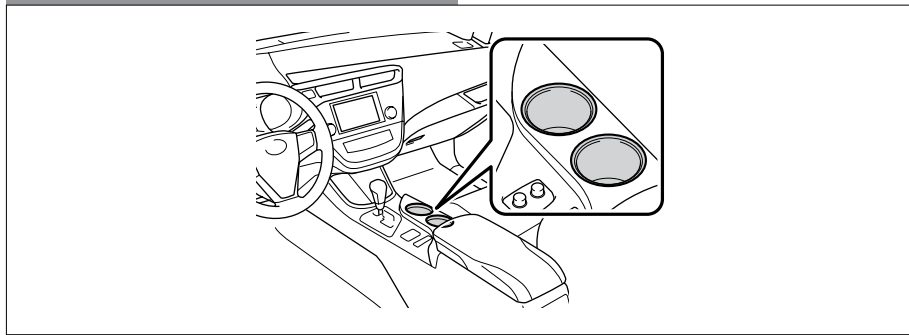

Rear

Type A

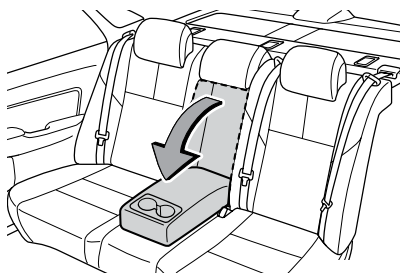

Type B

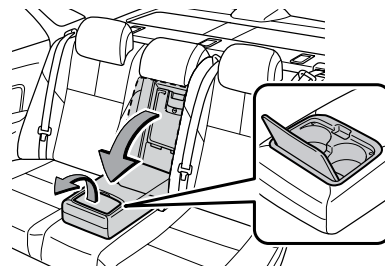

Door locks

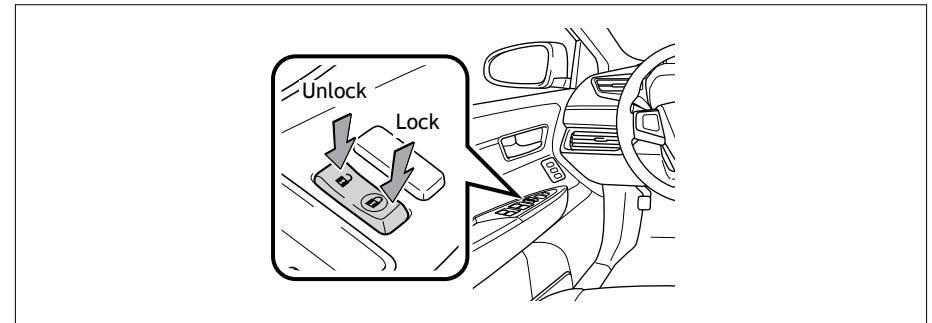

Doors-Child safety locks

Rear door

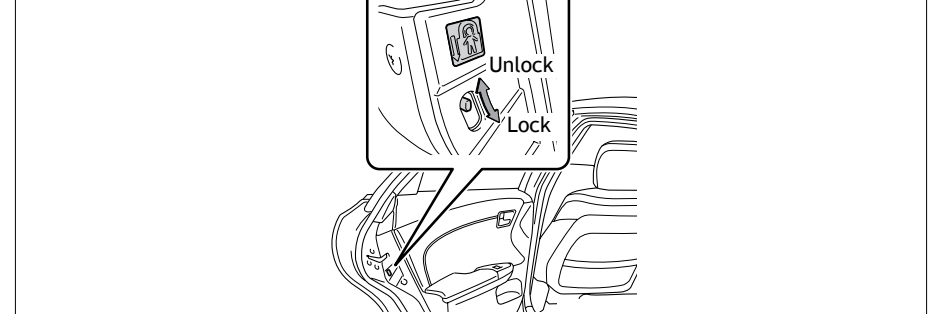

Moving the lever to the lock position will allow the door to be opened only from the outside.

Seat belts

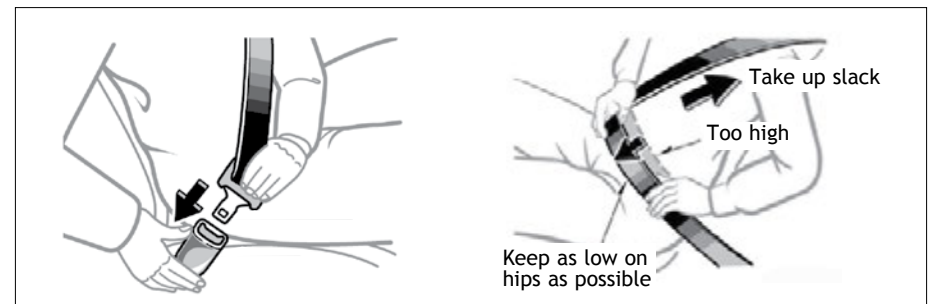

If belt is fully extended, then retracted even slightly, it cannot be re-extended beyond that point, unless fully retracted again. This feature is used to help hold child restraint systems securely.

To find more information about seat belts, and how to install a child restraint system, refer to the *Owner's Manual*.

Seat belts-Shoulder belt anchor

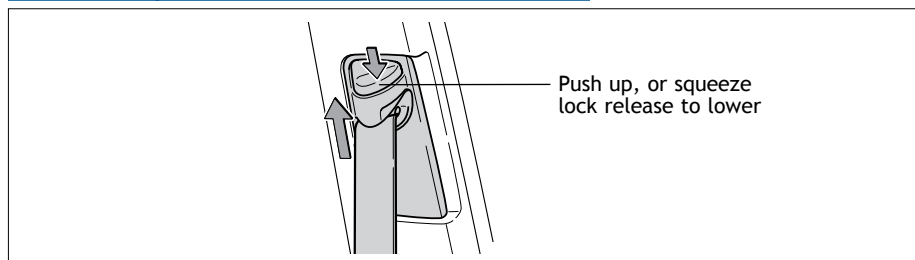

Tire Pressure Monitoring (warning) System

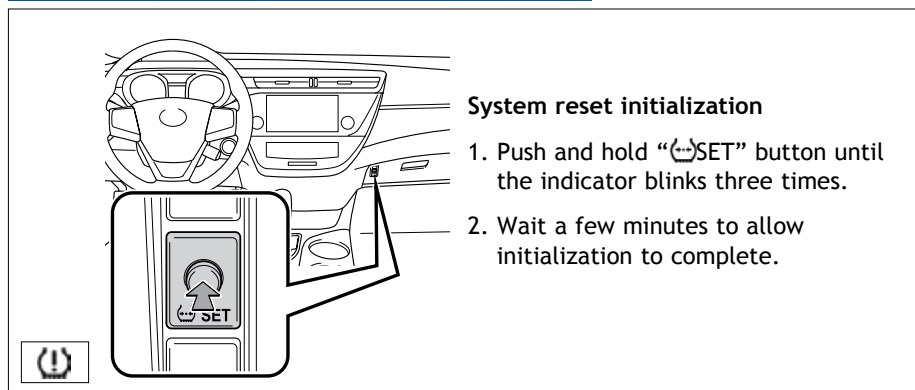

System reset initialization

1. Push and hold “SET” button until the indicator blinks three times.
2. Wait a few minutes to allow initialization to complete.

After adjusting tire pressures, or after tires have been rotated or replaced, turn the “ENGINE START STOP” switch to IGNITION ON mode and press and hold the “SET” button until indicator blinks three times. Let the vehicle sit for a few minutes to allow initialization to complete.

Refer to the load label on the door jamb or the *Owner's Manual* for tire inflation specifications.

If the tire pressure indicator flashes for more than 60 seconds and then remains on, take the vehicle to your local Toyota dealer.

NOTE: The warning light may come on due to temperature changes or changes in tire pressure from natural air leakage. If the system has not been initialized recently, setting the tire pressures to factory specifications should turn off the light.

Spare tire & tools

Tool location

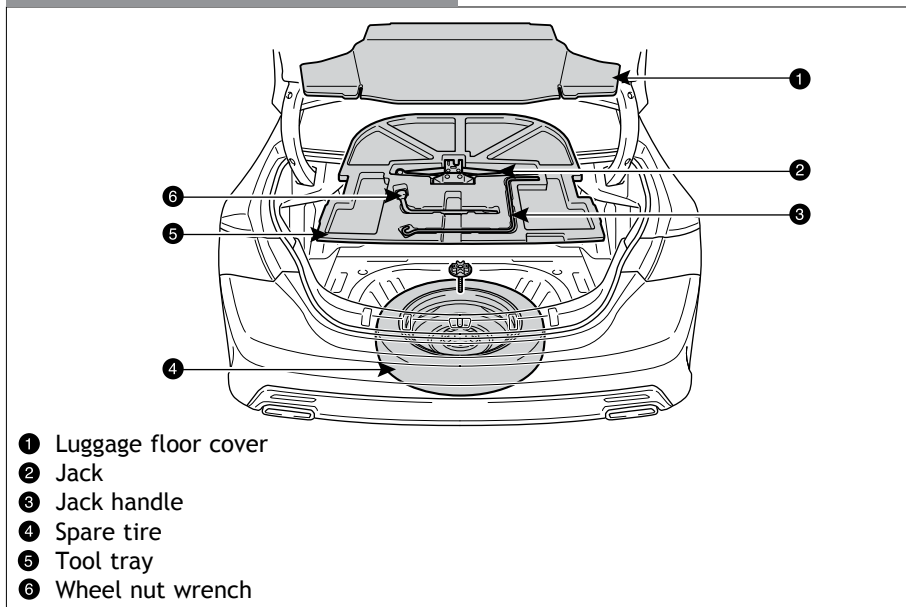

- 1 Luggage floor cover
- 2 Jack
- 3 Jack handle
- 4 Spare tire
- 5 Tool tray
- 6 Wheel nut wrench

Removing the spare tire

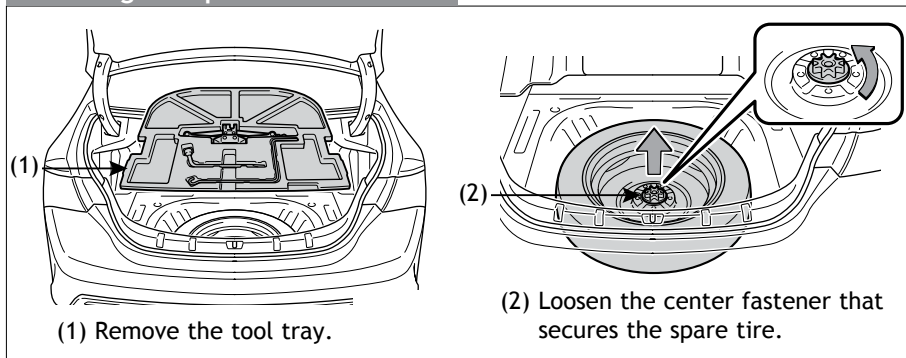

Refer to the *Owner's Manual* for tire changing and jack positioning procedures.

Trunk-Internal release

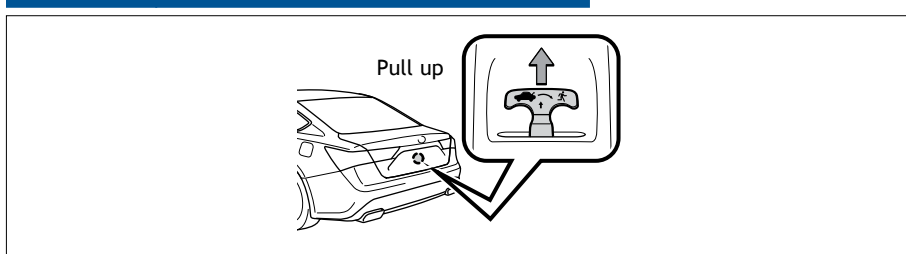

Star Safety System™

All new Toyota vehicles come standard with the Star Safety System™, which combines Vehicle Stability Control (VSC), Traction Control (TRAC), Anti-lock Braking System (ABS), Electronic Brake-force Distribution (EBD), Brake Assist (BA) and Smart Stop Technology (SST).

Vehicle Stability Control (VSC)

VSC helps prevent loss of traction during cornering by reducing engine power and applying brake force to selected wheels.

Toyota's VSC monitors steering angle and the direction your vehicle is traveling. When it senses that the front or rear wheels begin to lose traction, VSC reduces engine power and applies braking to selected wheels. This helps restore traction and vehicle control.

Traction Control (TRAC)

VSC helps prevent loss of traction during cornering by reducing engine power, and Traction Control helps maintain traction on loose gravel and wet, icy, or uneven surfaces by applying brake force to the spinning wheel(s).

Toyota's TRAC sensors are activated when one of the drive wheels starts to slip. TRAC limits engine output and applies the brakes to the spinning wheel. This transfers power to the wheels that still have traction to help keep you on track.

Anti-Lock Brake System (ABS)

ABS helps prevent brakes from locking up by “pulsing” brake pressure to each wheel. This limits brake lockup and helps provide directional control for the current road conditions.

Toyota's ABS sensors detect which wheels are locking up and limits wheel lockup by “pulsing” each wheel's brakes independently. Pulsing releases brake pressure repeatedly for fractions of a second. This helps the tires attain the traction that current road conditions will allow, helping you to stay in directional control.

Electronic Brake Force Distribution (EBD)

Toyota's ABS technology has Electronic Brake-force Distribution (EBD) to help maintain control and balance when braking. Abrupt stops can cause a vehicle to tilt forward, reducing the braking power of the rear wheels. EBD responds to sudden stops by redistributing brake force to enhance the braking effectiveness of all four wheels.

Brake Assist (BA)

Brake Assist is designed to detect sudden or “panic” braking, and then add braking pressure to help decrease the vehicle's stopping distance. When there's only a split second to react, Brake Assist can add additional brake pressure more quickly than just the driver alone can.

Smart Stop Technology (SST)

Smart Stop Technology automatically reduces driving torque when the accelerator and brake pedals are pressed simultaneously under certain conditions.

SST engages when the accelerator is depressed first and the brakes are applied firmly for longer than one-half second at speeds greater than five miles per hour.

SST doesn't engage if the brake pedal is depressed before the accelerator pedal, allowing vehicles to start on a steep hill and safely accelerate without rolling backward.

Floor mat installation

There are two types of Toyota floor mats: carpeted and all-weather. Each vehicle has model-specific floor mats. Installation is easy.

To keep your floor mat properly positioned, follow these steps:

- Only use floor mats designed for your specific model.
- Use only one floor mat at a time, using the retaining hooks to keep the mat in place.
- Install floor mats right side up.

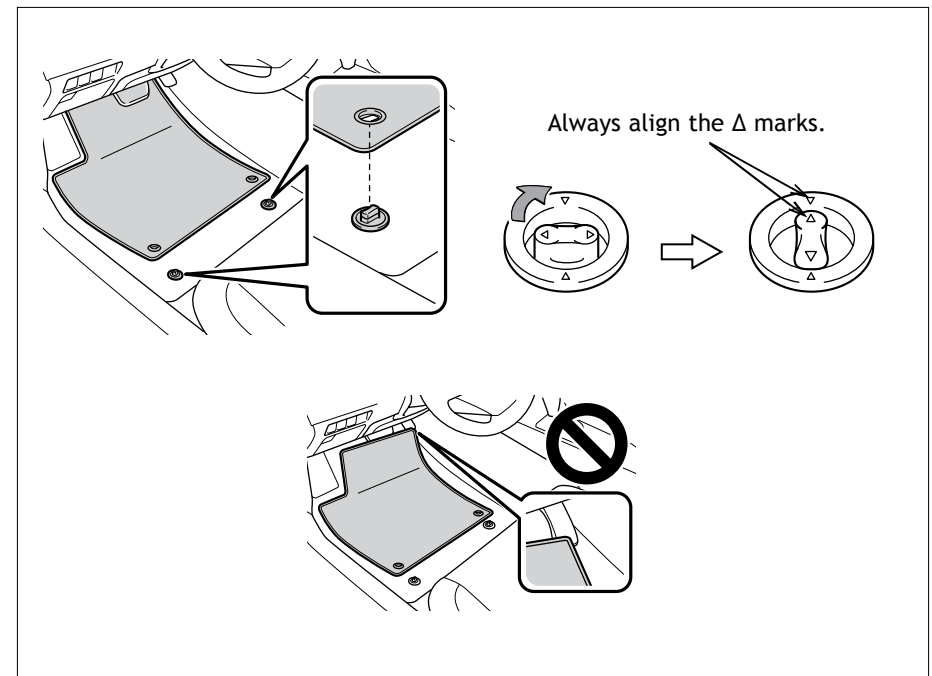

BLUETOOTH® DEVICE PAIRING SECTION

To begin the Bluetooth® Pairing process, press the HOME button on the faceplate of your Toyota Vehicle Entune™ Multimedia Head Unit.

Bluetooth® Pairing for Android® phone and Entune™ touch screen system

Pairing your phone is the first step in connecting with your Toyota for hands-free calling and for audio streaming via Bluetooth. This pairing process is quick and easy: all Android mobile digital devices have Bluetooth integrated; all you have to do is setup the phone and multimedia system to “talk” to each other and form a connection.¹

Initiate Bluetooth® on your Android®

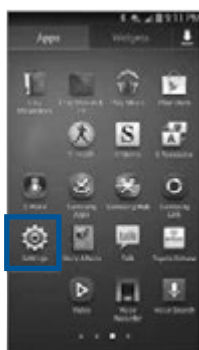

STEP 1
From your APPS SCREEN, select SETTINGS

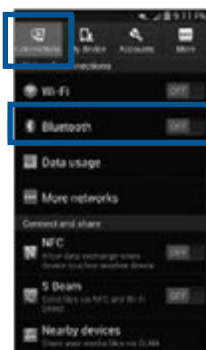

STEP 2
Select CONNECTIONS and select BLUETOOTH



STEP 3
Ensure BLUETOOTH is ON

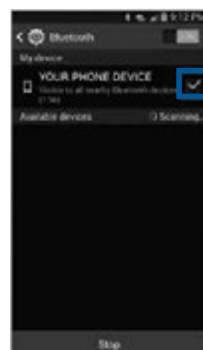

STEP 4
Select YOUR PHONE DEVICE to make it discoverable.

Phone will seek out Bluetooth devices while remaining discoverable.



STEP 5
While your Android device is seeking out Bluetooth devices, proceed to your Entune Multimedia Head Unit on your Toyota vehicle.

Initiate Bluetooth® on your Entune™ Multimedia Head Unit

Once you have Bluetooth enabled on your phone and ready to pair, you will need to initiate Bluetooth on your Entune head unit. Please follow the instructions below to pair your Bluetooth enabled phone to your Entune system.



STEP 6
On your Toyota Vehicle Entune Multimedia Head Unit, Select SETUP BUTTON on the Home Screen.



STEP 7
Select BLUETOOTH

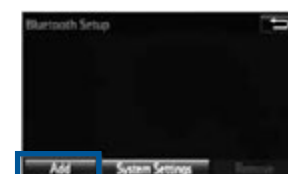

STEP 8
Select ADD, to add your phone device

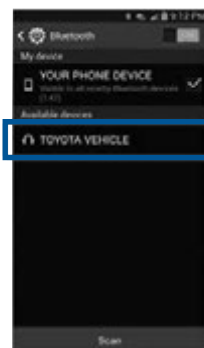

STEP 9
Back on your smartphone, you can now select your TOYOTA VEHICLE in Bluetooth Settings.

You may need to enter the provided Bluetooth PIN on your phone.



STEP 10
Your smartphone is now paired with Entune.

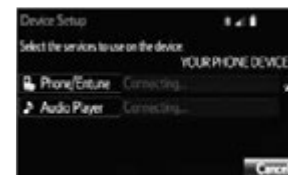

STEP 11
Once paired, Entune will attempt to connect audio and contacts on your phone.

¹ Some Android devices may have slightly different SETTINGS screen layout depending on manufacturer of device and Android OS version.

Initiate Bluetooth® on your Entune™ Multimedia Head Unit (continued)

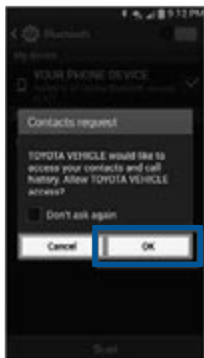

STEP 12

Using your smartphone, you will need to allow Entune access to your messaging and contacts

It is recommended to check the "Don't ask again" box, so as not to have to press OK every time the phone makes a Bluetooth connection with your Toyota

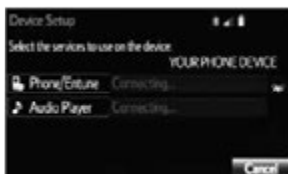

STEP 13

A confirmation will appear once your phone has been paired and connected.

Additional Resources

If you're having trouble pairing your phone, Toyota has you covered. You can get more information from the following sources:

Online Pairing Guide:
www.toyota.com/connect

Your Toyota Owner's Manual
Located in the vehicle glovebox

Toyota Customer Experience Center
(800) 331-4331

- Disclosures
- This brochure is accurate at the time of print; content subject to change based on periodic multimedia software updates.
1. Concentrating on the road should always be your first priority while driving. Do not use the hands-free phone system if it will distract you.
 2. The Bluetooth word mark and logos are registered trademarks owned by Bluetooth SIG, Inc. and any use of such marks by Toyota is under license. A compatible Bluetooth enabled phone must first be paired. Phone performance depends on software, coverage & carrier.
 3. Android is a trademark of Google, Inc. All rights reserved. Google is not a participant in or sponsor of this promotion.
 4. Apps/services vary by phone/carrier; functionality depends on many factors. Select apps use large amounts of data; you are responsible for charges. Apps & services subject to change. See Toyota.com/entune for details.
 5. Bluetooth Pairing Guide for select 2015 models.

Bluetooth® Pairing for iPhone® and Entune™ touch screen system

Pairing your phone is the first step in connecting with your Toyota for hands-free calling and for audio streaming via Bluetooth. This pairing process is quick and easy: all iPhone mobile digital devices have Bluetooth integrated; all you have to do is setup the phone and multimedia system to "talk" to each other and form a connection. Bluetooth Pairing Guide for select 2015 models.

Initiate Bluetooth® on your iPhone®



STEP 1

From the HOME SCREEN, select SETTINGS

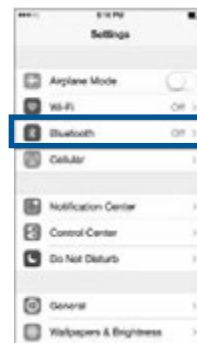

STEP 2

Select BLUETOOTH



STEP 3

Ensure BLUETOOTH is ON



STEP 4

Your iPhone will seek out Bluetooth devices while remaining discoverable



STEP 5

While your iPhone device is seeking out Bluetooth devices, proceed to your Entune Multimedia Head Unit on your Toyota vehicle.

CONTINUE ON THE NEXT PAGE...

Initiate Bluetooth® on your Entune™ Multimedia Head Unit

Once you have Bluetooth enabled on your phone and ready to pair, you will need to initiate Bluetooth on your Entune head unit. Please follow the instructions below to pair your Bluetooth enabled phone to your Entune system.



STEP 6
Select **SETUP** BUTTON on the Home Screen.



STEP 7
Select **BLUETOOTH**

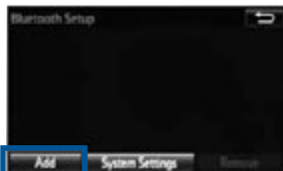

STEP 8
Select **ADD**, to add your phone device



STEP 9
Back on your smartphone, you can now select your **TOYOTA VEHICLE** in Bluetooth Settings.

You may need to enter the provided Bluetooth PIN on your phone.



STEP 10
Your smartphone is now paired with Entune.

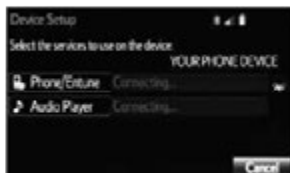

STEP 11
Once paired, Entune will attempt to connect audio and contacts on your phone.

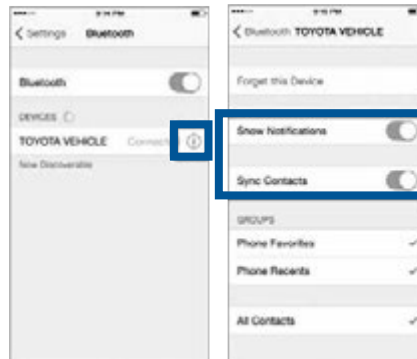

STEP 12
Using your smartphone, you may need to allow Entune access to your messaging and contacts
Only current iPhone text messages can be viewed on the head unit. iPhone does not allow text message reply.

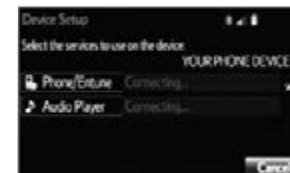

STEP 13
A confirmation will appear once your phone has been paired and connected.

Additional Resources

If you're having trouble pairing your phone, Toyota has you covered. You can get more information from the following sources:

Online Pairing Guide:
www.toyota.com/connect

Your Toyota Owner's Manual
Located in the vehicle glovebox

Toyota Customer Experience Center
(800) 331-4331

Disclosures

This brochure is accurate at the time of print; content subject to change based on periodic multimedia software updates.

1. Concentrating on the road should always be your first priority while driving. Do not use the hands-free phone system if it will distract you.
2. The Bluetooth word mark and logos are registered trademarks owned by Bluetooth SIG, Inc. and any use of such marks by Toyota is under license. A compatible Bluetooth enabled phone must first be paired. Phone performance depends on software, coverage & carrier.
3. Android is a trademark of Google, Inc. All rights reserved. Google is not a participant in or sponsor of this promotion.
4. Apps/services vary by phone/carrier; functionality depends on many factors. Select apps use large amounts of data; you are responsible for charges. Apps & services subject to change. See Toyota.com/entune for details.
5. Bluetooth Pairing Guide for select 2015 models.

Bluetooth® Pairing for Windows Phone® and Entune™ touch screen system

Pairing your phone is the first step in connecting with your Toyota for hands-free calling and for audio streaming via Bluetooth. This pairing process is quick and easy: all Windows Phone mobile digital devices have Bluetooth integrated; all you have to do is setup the phone and multimedia system to “talk” to each other and form a connection. Bluetooth Pairing Guide for select 2015 models.

Initiate Bluetooth® on your Windows Phone®

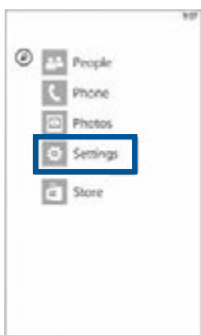

STEP 1
From your APP LIST, select **SETTINGS**

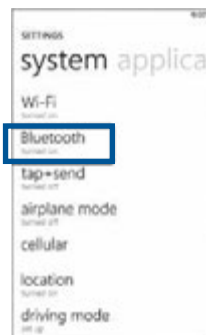

STEP 2
Select **BLUETOOTH**



STEP 3
Ensure **BLUETOOTH** is **ON**



STEP 4
Phone will seek out Bluetooth devices while remaining discoverable



STEP 5
While your iPhone device is seeking out Bluetooth devices, proceed to your Entune Multimedia Head Unit on your Toyota vehicle.
CONTINUE ON THE NEXT PAGE...

Initiate Bluetooth® on your Entune™ Multimedia Head Unit

Once you have Bluetooth® enabled on your phone and ready to pair, you will need to initiate Bluetooth® on your Entune head unit. Please follow the instructions below to pair your Bluetooth enabled phone to your Entune system.



STEP 6
On your Toyota Vehicle Entune Multimedia Head Unit, Select **SETUP BUTTON** on the Home Screen.



STEP 7
Select **BLUETOOTH**

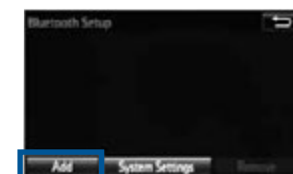

STEP 8
Select **ADD**, to add your phone device

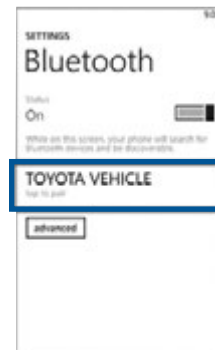

STEP 9
Back on your smartphone, you can now select your **TOYOTA VEHICLE** in Bluetooth Settings.
You may need to enter the provided Bluetooth PIN on your phone.



STEP 10
Your smartphone is now paired with Entune.

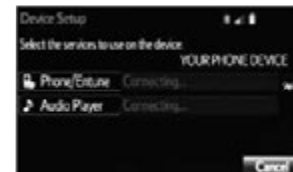

STEP 11
Once paired, Entune will attempt to connect audio and contacts on your phone.

Initiate Bluetooth® on your Entune™ Multimedia Head Unit (continued)



STEP 12

Using your smartphone, you may need to allow Entune access to your contacts



STEP 13

A confirmation will appear that your phone has been paired and connected.

Additional Resources

If you're having trouble pairing your phone, Toyota has you covered. You can get more information from the following sources:

Online Pairing Guide:
www.toyota.com/connect

Your Toyota Owner's Manual
 Located in the vehicle glovebox

Toyota Customer Experience Center
 (800) 331-4331

- Disclosures
- This brochure is accurate at the time of print; content subject to change based on periodic multimedia software updates.
1. Concentrating on the road should always be your first priority while driving. Do not use the hands-free phone system if it will distract you.
 2. The Bluetooth word mark and logos are registered trademarks owned by Bluetooth SIG, Inc. and any use of such marks by Toyota is under license. A compatible Bluetooth enabled phone must first be paired. Phone performance depends on software, coverage & carrier.
 3. Android is a trademark of Google, Inc. All rights reserved. Google is not a participant in or sponsor of this promotion.
 4. Apps/services vary by phone/carrier; functionality depends on many factors. Select apps use large amounts of data; you are responsible for charges. Apps & services subject to change. See Toyota.com/entune for details.
 5. Bluetooth Pairing Guide for select 2015 models.

