

	Pictorial index	Search by illustration	
1	For safety and security	Make sure to read through them	
2	Instrument cluster	How to read the gauges and meters, the variety of warning lights and indicators, etc.	
3	Operation of each component	Opening and closing the doors and windows, adjustment before driving, etc.	
4	Driving	Operations and advices which are necessary for driving	
5	Interior features	Usage of the interior features, etc.	
6	Maintenance and care	Caring for your vehicle and maintenance procedures	
7	When trouble arises	What to do in case of malfunction or emergency	
8	Vehicle specifications	Vehicle specifications, customizable features, etc.	
9	For owners	Reporting safety defects for U.S. owners, and seat belt and SRS airbag instructions for Canadian owners	
	Index	Search by symptom	
		Search alphabetically	

For your information.....	8
Reading this manual.....	12
How to search.....	13
Pictorial index	14

1 For safety and security

1-1. For safe use

Before driving	24
For safety drive	26
Seat belts	28
SRS airbags	34
Front passenger occupant classification system	44
Safety information for children	50
Child restraint systems.....	51
Installing child restraints	55
Exhaust gas precautions	65

1-2. Theft deterrent system

Engine immobilizer system.....	66
Alarm.....	68
Theft prevention labels (U.S.A.)	70

2 Instrument cluster

2. Instrument cluster

Warning lights and indicators.....	72
Gauges and meters.....	77
Multi-information display	80
Fuel consumption information	86

3 Operation of each component

3-1. Key information

Keys.....	90
-----------	----

3-2. Opening, closing and locking the doors

Smart key system	93
Wireless remote control.....	108
Doors	111
Trunk	114

3-3. Adjusting the seats

Front seats.....	118
Driving position memory	120
Head restraints	125

3-4. Adjusting the steering wheel and mirrors

Steering wheel.....	128
Inside rear view mirror	129
Outside rear view mirrors	131

3-5. Opening, closing the windows and moon roof

Power windows.....	134
Moon roof	137

4 Driving

4-1. Before driving

Driving the vehicle	142
Cargo and luggage.....	153
Vehicle load limits	156
Trailer towing.....	157
Dinghy towing.....	158

4-2. Driving procedures

Engine (ignition) switch	159
Automatic transmission	165
Turn signal lever.....	169
Parking brake	170
Horn	171

4-3. Operating the lights and wipers

Headlight switch	172
Automatic High Beam	176
Fog light switch	181
Windshield wipers and washer	183

4-4. Refueling

Opening the fuel tank cap	189
------------------------------------	-----

4-5. Using the driving support systems

Cruise control	194
Dynamic radar cruise control.....	198
Driving mode select switches.....	213
Driving assist systems	215
PCS (Pre-Collision System)	220
BSM (Blind Spot Monitor).....	227

4-6. Driving tips

Winter driving tips	236
---------------------------	-----

5 Interior features

5-1. Using the air conditioning system and defogger

Automatic air conditioning system.....	242
Rear window and outside rear view mirror defoggers	252

5-2. Using the interior lights

Interior lights list	253
• Personal/interior light main switch	254
• Personal/interior lights	254
• Ambient lights	255

5-3. Using the storage features

List of storage features	256
• Glove box.....	257
• Console box.....	258
• Cup holders	259
• Auxiliary boxes.....	260
Trunk features	265

5-4. Other interior features

Sun visors and vanity mirrors	267
Clock.....	268
Outside temperature display	270
Power outlets.....	271
Seat heaters/seat ventilators	274
Armrest.....	277
Rear sunshade	278
Trunk storage extension	280
Coat hooks	281
Assist grips	282
Garage door opener	283
Safety Connect.....	290
Compass	296

6 Maintenance and care

- 6-1. Maintenance and care**
- Cleaning and protecting the vehicle exterior 302
 - Cleaning and protecting the vehicle interior 306
- 6-2. Maintenance**
- Maintenance requirements 309
 - General maintenance 311
 - Emission inspection and maintenance (I/M) programs 315
- 6-3. Do-it-yourself maintenance**
- Do-it-yourself service precautions 316
 - Hood 319
 - Positioning a floor jack 320
 - Engine compartment 322
 - Tires 334
 - Tire inflation pressure 342
 - Wheels 345
 - Air conditioning filter 348
 - Electronic key battery 350
 - Checking and replacing fuses 352
 - Light bulbs 361

7 When trouble arises

- 7-1. Essential information**
- Emergency flashers 380
 - If your vehicle has to be stopped in an emergency 381
- 7-2. Steps to take in an emergency**
- If your vehicle needs to be towed 382
 - If you think something is wrong 386
 - Fuel pump shut off system 387
 - If a warning light turns on or a warning buzzer sounds 388
 - If a warning message is displayed 399
 - If you have a flat tire 400
 - If the engine will not start 413
 - If the shift lever cannot be shifted from P 415
 - If the electronic key does not operate properly 416
 - If the vehicle battery is discharged 419
 - If your vehicle overheats 423
 - If the vehicle becomes stuck 426

8 Vehicle specifications**8-1. Specifications**

Maintenance data (fuel, oil level, etc.)	430
Fuel information	439
Tire information	442

8-2. Customization

Customizable features	455
-----------------------------	-----

8-3. Items to initialize

Items to initialize.....	461
--------------------------	-----

9 For owners

Reporting safety defects for U.S. owners.....	464
Seat belt instructions for Canadian owners (in French)	465
SRS airbag instructions for Canadian owners (in French)	467

Index

What to do if... (Troubleshooting).....	478
Alphabetical index.....	484

For vehicles with a audio/navigation system, refer to the “NAVIGATION AND MULTIMEDIA SYSTEM OWNER’S MANUAL” for information regarding the audio/navigation system.

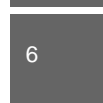
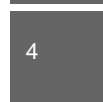

For your information

Main Owner's Manual

Please note that this manual applies to all models and explains all equipment, including options. Therefore, you may find some explanations for equipment not installed on your vehicle.

All specifications provided in this manual are current at the time of printing. However, because of the Toyota policy of continual product improvement, we reserve the right to make changes at any time without notice.

Depending on specifications, the vehicle shown in the illustrations may differ from your vehicle in terms of color and equipment.

Noise from under vehicle after turning off the engine

Approximately five hours after the engine is turned off, you may hear sound coming from under the vehicle for several minutes. This is the sound of a fuel evaporation leakage check and, it does not indicate a malfunction.

Accessories, spare parts and modification of your Toyota

A wide variety of non-genuine spare parts and accessories for Toyota vehicles are currently available in the market. You should know that Toyota does not warrant these products and is not responsible for their performance, repair, or replacement, or for any damage they may cause to, or adverse effect they may have on, your Toyota vehicle.

This vehicle should not be modified with non-genuine Toyota products. Modification with non-genuine Toyota products could affect its performance, safety or durability, and may even violate governmental regulations. In addition, damage or performance problems resulting from the modification may not be covered under warranty.

Installation of a mobile two-way radio system

The installation of a mobile two-way radio system in your vehicle could affect electronic systems such as:

- Multiport fuel injection system/sequential multiport fuel injection system
- Dynamic radar cruise control system
- Cruise control system
- Anti-lock brake system
- SRS airbag system
- Seat belt pretensioner system

Be sure to check with your Toyota dealer for precautionary measures or special instructions regarding installation of a mobile two-way radio system.

Vehicle data recordings

Your Toyota is equipped with several sophisticated computers that will record certain data, such as:

- Engine speed
- Accelerator status
- Brake status
- Vehicle speed
- Shift position

The recorded data varies according to the vehicle grade level and options with which it is equipped. Furthermore, these computers do not record conversations, sounds or pictures.

- Data usage

Toyota may use the data recorded in these computers to diagnose malfunctions, conduct research and development, and improve quality.

Toyota will not disclose the recorded data to a third party except:

- With the consent of the vehicle owner or with the consent of the lessee if the vehicle is leased
- In response to an official request by the police, a court of law or a government agency
- For use by Toyota in a law suit
- For research purposes where the data is not tied to a specific vehicle or vehicle owner

- Usage of data collected through Safety Connect (U.S. mainland only)

If your Toyota has Safety Connect and if you have subscribed to those services, please refer to the Safety Connect Telematics Subscription Service Agreement for information on data collected and its usage.

Event data recorder

This vehicle is equipped with an event data recorder (EDR). The main purpose of an EDR is to record, in certain crash or near crash-like situations, such as an air bag deployment or hitting a road obstacle, data that will assist in understanding how a vehicle's systems performed. The EDR is designed to record data related to vehicle dynamics and safety systems for a short period of time, typically 30 seconds or less.

The EDR in this vehicle is designed to record such data as:

- How various systems in your vehicle were operating;
- Whether or not the driver and passenger safety belts were buckled/fastened;
- How far (if at all) the driver was depressing the accelerator and/or brake pedal; and,
- How fast the vehicle was traveling.

These data can help provide a better understanding of the circumstances in which crashes and injuries occur.

NOTE: EDR data are recorded by your vehicle only if a non-trivial crash situation occurs; no data are recorded by the EDR under normal driving conditions and no personal data (e.g., name, gender, age, and crash location) are recorded. However, other parties, such as law enforcement, could combine the EDR data with the type of personally identifying data routinely acquired during a crash investigation.

To read data recorded by an EDR, special equipment is required, and access to the vehicle or the EDR is needed. In addition to the vehicle manufacturer, other parties, such as law enforcement, that have the special equipment, can read the information if they have access to the vehicle or the EDR.

● Disclosure of the EDR data

Toyota will not disclose the data recorded in an EDR to a third party except when:

- An agreement from the vehicle's owner (or the lessee for a leased vehicle) is obtained
- In response to an official request by the police, a court of law or a government agency
- For use by Toyota in a lawsuit

However, if necessary, Toyota may:

- Use the data for research on vehicle safety performance
- Disclose the data to a third party for research purposes without disclosing information about the specific vehicle or vehicle owner

Scrapping of your Toyota

The SRS airbag and seat belt pretensioner devices in your Toyota contain explosive chemicals. If the vehicle is scrapped with the airbags and seat belt pretensioners left as they are, this may cause an accident such as fire. Be sure to have the systems of the SRS airbag and seat belt pretensioner removed and disposed of by a qualified service shop or by your Toyota dealer before you scrap your vehicle.

Perchlorate Material

Special handling may apply, See www.dtsc.ca.gov/hazardouswaste/perchlorate.

Your vehicle has components that may contain perchlorate. These components may include airbag, seat belt pretensioners, and wireless remote control batteries.

CAUTION

■ General precautions while driving

Driving under the influence: Never drive your vehicle when under the influence of alcohol or drugs that have impaired your ability to operate your vehicle. Alcohol and certain drugs delay reaction time, impair judgment and reduce coordination, which could lead to an accident that could result in death or serious injury.

Defensive driving: Always drive defensively. Anticipate mistakes that other drivers or pedestrians might make and be ready to avoid accidents.

Driver distraction: Always give your full attention to driving. Anything that distracts the driver, such as adjusting controls, talking on a cellular phone or reading can result in a collision with resulting death or serious injury to you, your occupants or others.

■ General precaution regarding children's safety

Never leave children unattended in the vehicle, and never allow children to have or use the key.

Children may be able to start the vehicle or shift the vehicle into neutral. There is also a danger that children may injure themselves by playing with the windows, the moon roof, or other features of the vehicle. In addition, heat build-up or extremely cold temperatures inside the vehicle can be fatal to children.

Reading this manual

 **CAUTION:**
Explains something that, if not obeyed, could cause death or serious injury to people.

 **NOTICE:**
Explains something that, if not obeyed, could cause damage to or a malfunction in the vehicle or its equipment.

... Indicates operating or working procedures. Follow the steps in numerical order.

 Indicates the action (pushing, turning, etc.) used to operate switches and other devices.

 Indicates the outcome of an operation (e.g. a lid opens).

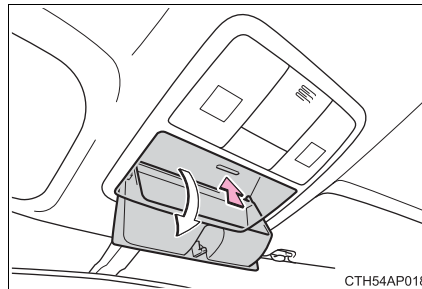

 Indicates the component or position being explained.

 Means “Do not”, “Do not do this”, or “Do not let this happen”.

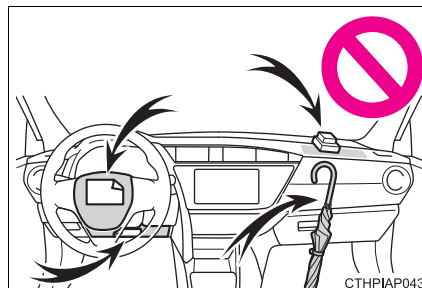

How to search

■ Searching by name

- Alphabetical index.....P. 484

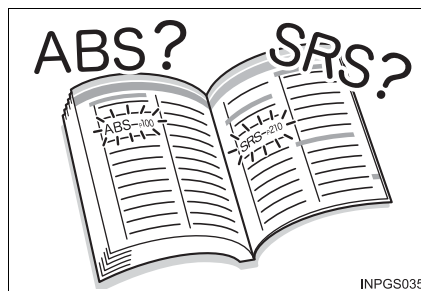

■ Searching by installation position

- Pictorial index.....P. 14

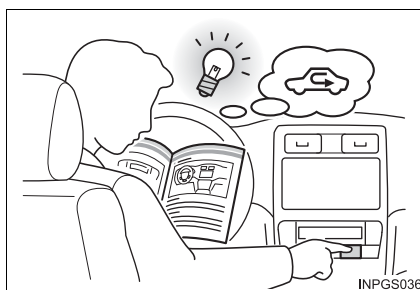

■ Searching by symptom or sound

- What to do if...
(Troubleshooting).....P. 478



■ Searching by title

- Table of contents.....P. 2

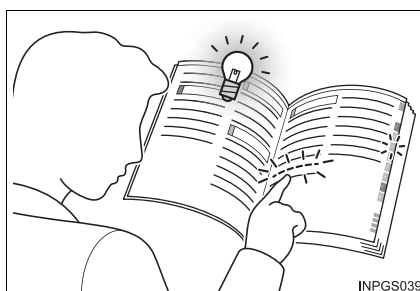

Pictorial index

■ Exterior

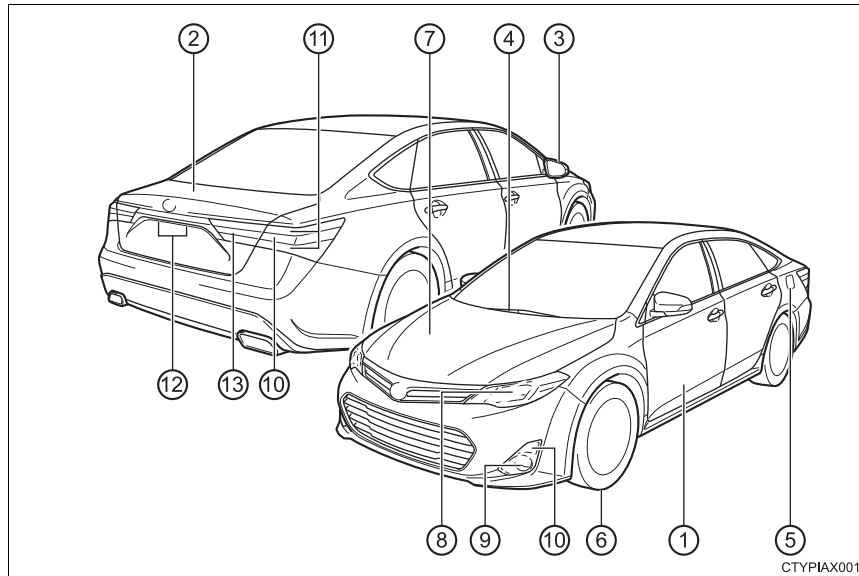

CTYPIAX001

①	Doors	P. 111
	Locking/unlocking	P. 94, 108
	Opening/closing the door glasses	P. 134
	Locking/unlocking by using the mechanical key	P. 416
	Warning lights/warning messages	P. 391, 399
②	Trunk	P. 114
	Opening from inside	P. 114
	Opening from outside	P. 94, 108
	Warning lights/warning messages	P. 391, 399
③	Outside rear view mirrors	P. 131
	Adjusting the mirror angle	P. 131
	Folding the mirrors	P. 131
	Driving position memory	P. 120
	Defogging the mirrors	P. 252

- ④ **Windshield wipers** **P. 183**
 Precautions against winter season P. 236
 Precautions against car wash P. 304
- ⑤ **Fuel filler door** **P. 189**
 Refueling method P. 189
 Fuel type/fuel tank capacity P. 432
- ⑥ **Tires** **P. 334**
 Tire size/inflation pressure P. 437
 Winter tires/tire chain P. 236
 Checking/rotation/tire pressure warning system P. 334
 Coping with flat tires P. 400
- ⑦ **Hood** **P. 319**
 Opening P. 319
 Engine oil P. 432
 Coping with overheat P. 423

Light bulbs of the exterior lights for driving

(Replacing method: P. 361, Wattages: P. 438)

- ⑧ **Headlights/parking lights/side marker lights/
daytime running lights** **P. 172**
- ⑨ **Fog lights*** **P. 181**
- ⑩ **Turn signal lights** **P. 169**
- ⑪ **Stop/tail lights** **P. 172**
- ⑫ **License plate lights** **P. 172**
- ⑬ **Back-up lights**
 Shifting the shift lever to R P. 165

*: If equipped

■ Instrument panel

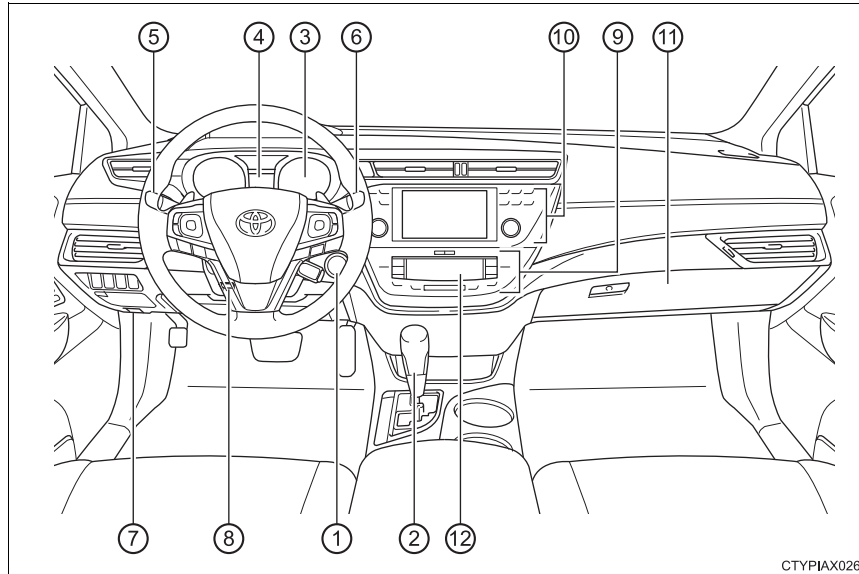

CTYPIAX026

- ① **Engine switch** **P. 159**
 Starting the engine/changing the modes P. 159
 Emergency stop of the engine P. 381
 When the engine will not start P. 413
- ② **Shift lever** **P. 165**
 Changing the shift position. P. 165
 When the shift lever does not move. P. 415
- ③ **Meters** **P. 77**
 Reading the meters/adjusting the instrument panel light. P. 77
 Warning lights/indicator lights P. 72
 When the warning lights come on P. 388

- ④ **Multi-information display** **P. 80**
 - Display P. 80
 - When the warning messages are displayed P. 399
- ⑤ **Turn signal lever** **P. 169**
 - Headlight switch P. 172
 - Headlights/parking lights/tail lights/daytime running lights P. 172
 - Fog lights*¹ P. 181
- ⑥ **Windshield wiper and washer switch** **P. 183**
 - Usage P. 183
 - Adding washer fluid P. 333
- ⑦ **Hood lock release lever** **P. 319**
- ⑧ **Tilt and telescopic steering lock release lever** **P. 128**
- ⑨ **Air conditioning system** **P. 242**
 - Usage P. 242
 - Rear window defogger P. 252
- ⑩ **Audio/Navigation system***²
- ⑪ **Glove box** **P. 257**
- ⑫ **Clock** **P. 268**

*¹: If equipped

*²: Refer to "NAVIGATION AND MULTIMEDIA SYSTEM OWNER'S MANUAL".

Switches

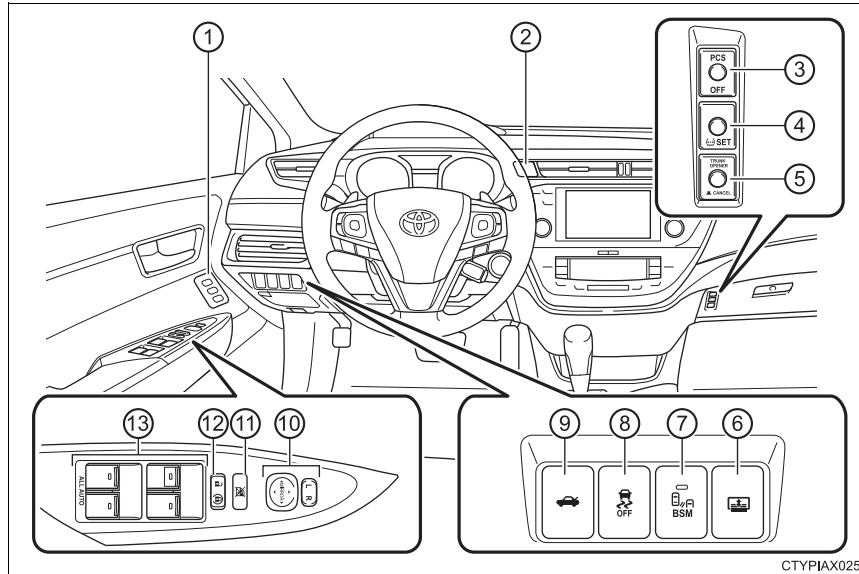

CTYPIAX025

- ① Driving position memory switches*1 P. 120
- ② Emergency flasher switch P. 380
- ③ PCS OFF switch*1 P. 221
- ④ Tire pressure warning reset switch. P. 336
- ⑤ Trunk opener main switch P. 115
- ⑥ Rear sunshade switch*1 P. 278
- ⑦ BSM (Blind Spot Monitor) main switch*1 P. 227
- ⑧ VSC OFF switch P. 216
- ⑨ Trunk opener P. 114
- ⑩ Outside rear view mirror switches P. 131
- ⑪ Window lock switch. P. 134
- ⑫ Door lock switches P. 111
- ⑬ Power window switches P. 134

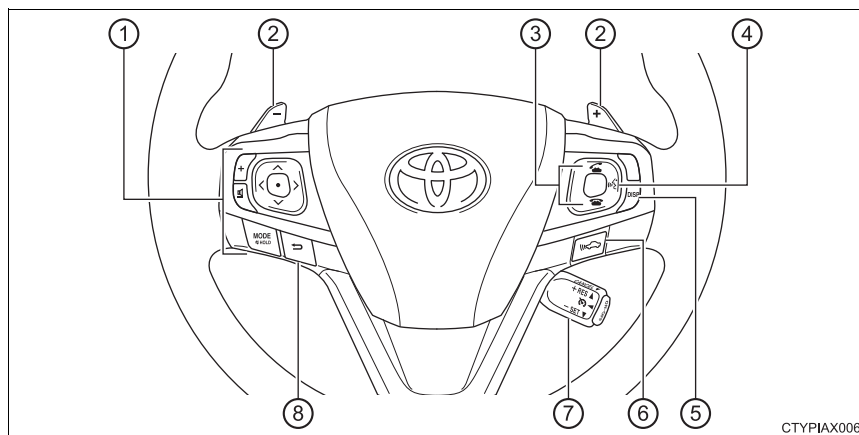

- ① Audio remote control switches*2
- ② Paddle shift switches P. 166
- ③ Telephone switches*2
- ④ Talk switch*2
- ⑤ “DISP” button..... P. 81
- ⑥ Vehicle-to-vehicle distance button*1 P. 201
- ⑦ Cruise control switch*1 P. 194
Dynamic radar cruise control switch*1 P. 198
- ⑧ Back switch*2

*1: If equipped

*2: Refer to “NAVIGATION AND MULTIMEDIA SYSTEM OWNER’S MANUAL”.

Interior

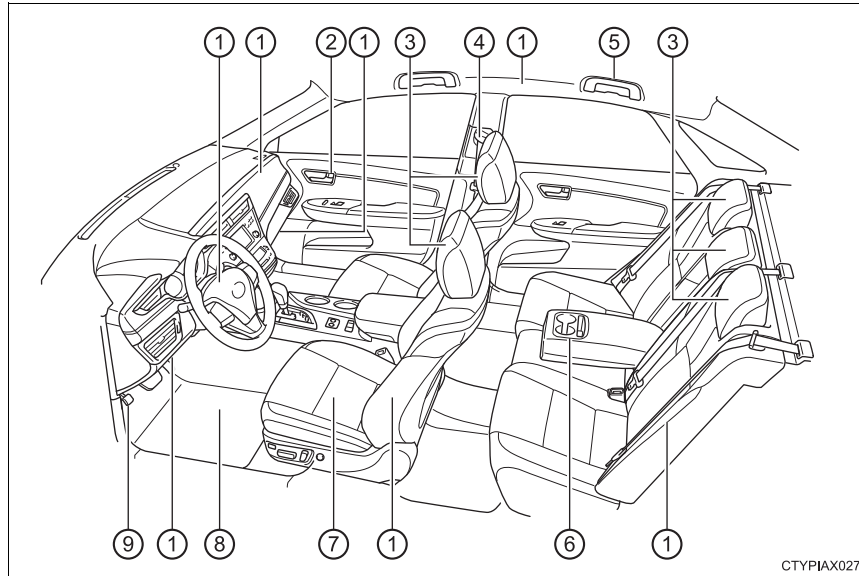

①	SRS airbags	P. 34
②	Inside lock buttons	P. 111
③	Head restraints	P. 125
④	Seat belts	P. 28
⑤	Assist grips	P. 282
⑥	Armrest	P. 277
	Cup holders	P. 259
	Power outlet*1	P. 271
⑦	Front seats	P. 118
⑧	Floor mat	P. 24
⑨	Parking brake	P. 170
	Applying/releasing	P. 170
	Precautions against winter season	P. 237
	Warning light/buzzer	P. 388

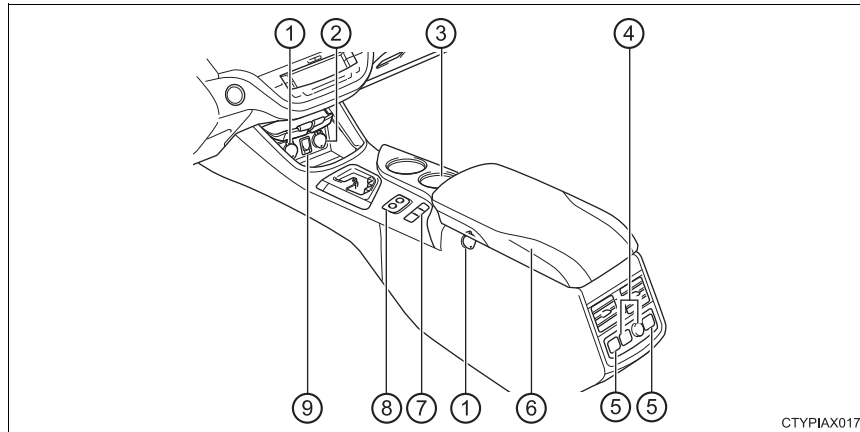

CTYPIAX017

- ① Power outlets P. 271
- ② Power outlet*1 P. 271
- Wireless charger switch*1 P. 262
- ③ Cup holders P. 259
- ④ Air conditioning controls*1 P. 242
- ⑤ Rear seat heater switches*1 P. 274
- ⑥ Console box P. 258
- ⑦ Driving mode select switches P. 213
- ⑧ Seat heater/ventilator switches*1 P. 274
- ⑨ AUX/USB port*2

*1: If equipped

*2: Refer to "NAVIGATION AND MULTIMEDIA SYSTEM OWNER'S MANUAL".

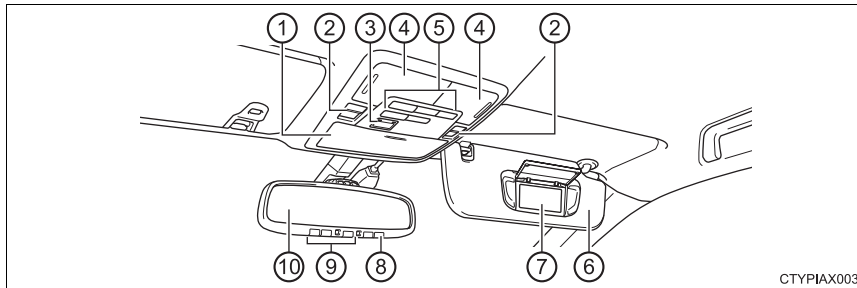

CTYPIAX003

①	Auxiliary box	P. 260
②	Moon roof switches ^{*1}	P. 137
③	“SOS” button ^{*1}	P. 290
④	Interior lights/personal lights ^{*2}	P. 254
⑤	Interior light/ambient lights ^{*1} switches	P. 254
⑥	Sun visors	P. 267
⑦	Vanity mirrors	P. 267
⑧	Compass switch ^{*1}	P. 296
⑨	Garage door opener switches ^{*1}	P. 283
⑩	Inside rear view mirror	P. 129

^{*1}: If equipped

^{*2}: The illustration shows the front, but they are also equipped in the rear.

For safety and security**1****1-1. For safe use**

Before driving.....	24
For safety drive	26
Seat belts	28
SRS airbags.....	34
Front passenger occupant classification system	44
Safety information for children	50
Child restraint systems.....	51
Installing child restraints.....	55
Exhaust gas precautions.....	65

1-2. Theft deterrent system

Engine immobilizer system	66
Alarm.....	68
Theft prevention labels (U.S.A.)	70

Before driving

Floor mat

Use only floor mats designed specifically for vehicles of the same model and model year as your vehicle. Fix them securely in place onto the carpet.

- 1 Insert the retaining hooks (clips) into the floor mat eyelets.

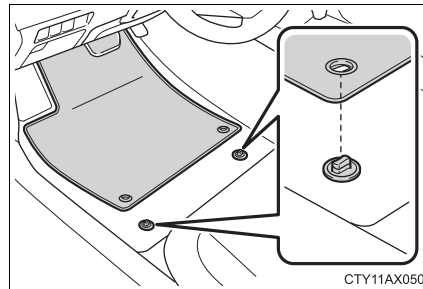

- 2 Turn the upper knob of each retaining hook (clip) to secure the floor mats in place.

*: Always align the \triangle marks.

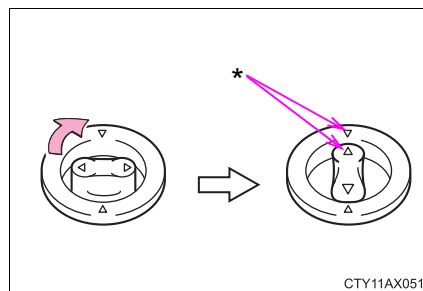

The shape of the retaining hooks (clips) may differ from that shown in the illustration.

⚠ CAUTION

Observe the following precautions.

Failure to do so may cause the driver's floor mat to slip, possibly interfering with the pedals while driving. An unexpectedly high speed may result or it may become difficult to stop the vehicle. This could lead to an accident, resulting in death or serious injury.

■ When installing the driver's floor mat

- Do not use floor mats designed for other models or different model year vehicles, even if they are Toyota Genuine floor mats.
- Only use floor mats designed for the driver's seat.
- Always install the floor mat securely using the retaining hooks (clips) provided.
- Do not use two or more floor mats on top of each other.
- Do not place the floor mat bottom-side up or upside-down.

■ Before driving

- Check that the floor mat is securely fixed in the correct place with all the provided retaining hooks (clips). Be especially careful to perform this check after cleaning the floor.
- With the engine stopped and the shift lever in P, fully depress each pedal to the floor to make sure it does not interfere with the floor mat.

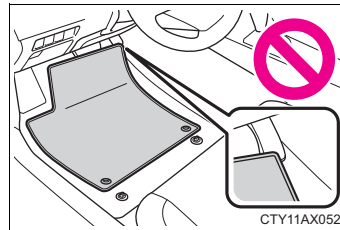

For safety drive

For safe driving, adjust the seat and mirror to an appropriate position before driving.

Correct driving posture

- ① Adjust the angle of the seat-back so that you are sitting straight up and so that you do not have to lean forward to steer. (→P. 118)
- ② Adjust the seat so that you can depress the pedals fully and so that your arms bend slightly at the elbow when gripping the steering wheel. (→P. 118)
- ③ Adjust the tilt and telescopic positions of the steering wheel downward so the airbag is facing your chest. (→P. 128)
- ④ Lock the head restraint in place with the center of the head restraint closest to the top of your ears. (→P. 125)
- ⑤ Wear the seat belt correctly. (→P. 28)

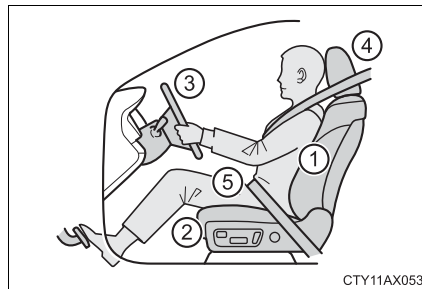

Correct use of the seat belts

Make sure that all occupants are wearing their seat belts before driving the vehicle. (→P. 28)

Use a child restraint system appropriate for the child until the child becomes large enough to properly wear the vehicle's seat belt.

(→P. 51)

Adjusting the mirrors

Make sure that you can see backward clearly by adjusting the inside and outside rear view mirrors properly. (→P. 129, 131)

CAUTION

Observe the following precautions.

Failure to do so may result in death or serious injury.

- Do not adjust the position of the driver's seat while driving.
Doing so could cause the driver to lose control of the vehicle.
- Do not place a cushion between the driver or passenger and the seatback.
A cushion may prevent correct posture from being achieved, and reduce the effectiveness of the seat belt and head restraint.
- Do not place anything under the front seats.
Objects placed under the front seats may become jammed in the seat tracks and stop the seat from locking in place. This may lead to an accident and the adjustment mechanism may also be damaged.
- When driving over long distances, take regular breaks before you start to feel tired.
Also, if you feel tired or sleepy while driving, do not force yourself to continue driving and take a break immediately.

Seat belts

Make sure that all occupants are wearing their seat belts before driving the vehicle.

Correct use of the seat belts

- Extend the shoulder belt so that it comes fully over the shoulder, but does not come into contact with the neck or slide off the shoulder.
- Position the lap belt as low as possible over the hips.
- Adjust the position of the seat-back. Sit up straight and well back in the seat.
- Do not twist the seat belt.

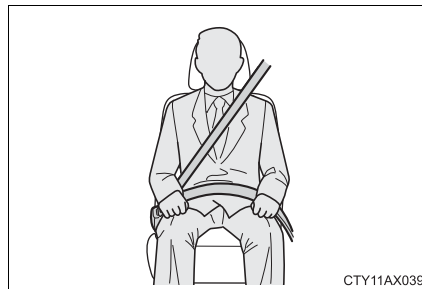

Fastening and releasing the seat belt

- ① To fasten the seat belt, push the plate into the buckle until a click sound is heard.
- ② To release the seat belt, press the release button.

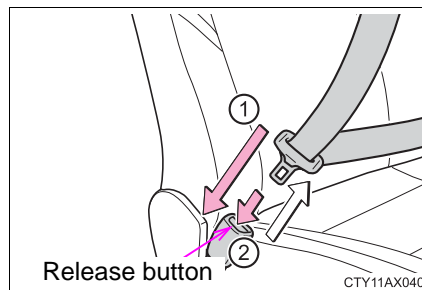

Adjusting the seat belt shoulder anchor height (front seats)

- ① Push the seat belt shoulder anchor down while pressing the release button.

- ② Push the seat belt shoulder anchor up.

Move the height adjuster up and down as needed until you hear a click.



Seat belt pretensioners (front seats)

The pretensioners help the seat belts to quickly restrain the occupants by retracting the seat belts when the vehicle is subjected to certain types of severe frontal collision.

The pretensioners also activate when the vehicle is subjected to certain types of severe side collision.

The pretensioners do not activate in the event of a minor frontal impact, a minor side impact, a rear impact or a vehicle rollover.

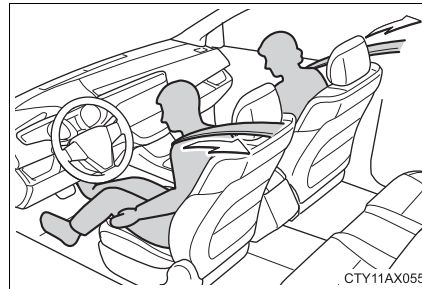

Pre-collision seat belts (front seats of vehicles with pre-collision system)

If the system determines that a collision is unavoidable, the front seat belts will retract before the collision. (→P. 220)

■ Emergency locking retractor (ELR)

The retractor will lock the belt during a sudden stop or on impact. It may also lock if you lean forward too quickly. A slow, easy motion will allow the belt to extend so that you can move around fully.

■ Automatic locking retractor (ALR)

When a passenger's shoulder belt is completely extended and then retracted even slightly, the belt is locked in that position and cannot be extended. This feature is used to hold the child restraint system (CRS) firmly. To free the belt again, fully retract the belt and then pull the belt out once more. (→P. 55)

■ Child seat belt usage

The seat belts of your vehicle were principally designed for persons of adult size.

- Use a child restraint system appropriate for the child, until the child becomes large enough to properly wear the vehicle's seat belt. (→P. 51)
- When the child becomes large enough to properly wear the vehicle's seat belt, follow the instructions regarding seat belt usage. (→P. 28)

■ Replacing the belt after the pretensioner has been activated

If the vehicle is involved in multiple collisions, the pretensioner will activate for the first collision, but will not activate for the second or subsequent collisions.

■ Seat belt extender

If your seat belts cannot be fastened securely because they are not long enough, a personalized seat belt extender is available from your Toyota dealer free of charge.

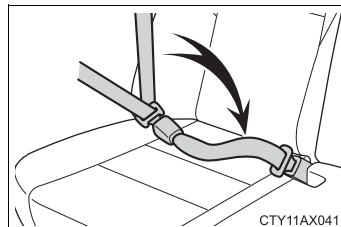

⚠ CAUTION

Observe the following precautions to reduce the risk of injury in the event of sudden braking, sudden swerving or an accident. Failure to do so may cause death or serious injury.

■ Wearing a seat belt

- Ensure that all passengers wear a seat belt.
- Always wear a seat belt properly.
- Each seat belt should be used by one person only. Do not use a seat belt for more than one person at once, including children.
- Toyota recommends that children be seated in the rear seat and always use a seat belt and/or an appropriate child restraint system.
- To achieve a proper seating position, do not recline the seat more than necessary. The seat belt is most effective when the occupants are sitting up straight and well back in the seats.
- Do not wear the shoulder belt under your arm.
- Always wear your seat belt low and snug across your hips.

■ Pregnant women

Obtain medical advice and wear the seat belt in the proper way. (→P. 28)

Women who are pregnant should position the lap belt as low as possible over the hips in the same manner as other occupants, extending the shoulder belt completely over the shoulder and avoiding belt contact with the rounding of the abdominal area.

If the seat belt is not worn properly, not only the pregnant woman, but also the fetus could suffer death or serious injury as a result of sudden braking or a collision.

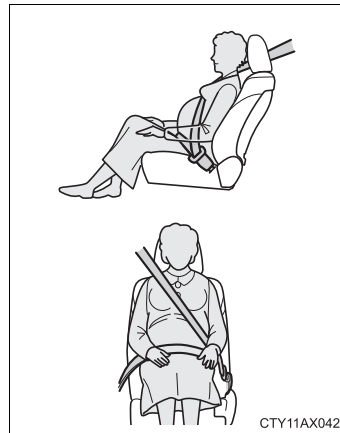

 **CAUTION****■ People suffering illness**

Obtain medical advice and wear the seat belt in the proper way. (→P. 28)

■ When children are in the vehicle

Do not allow children to play with the seat belt. If the seat belt becomes twisted around a child's neck, it may lead to choking or other serious injuries that could result in death.

If this occurs and the buckle cannot be unfastened, scissors should be used to cut the belt.

■ Seat belt pretensioners

If the pretensioner has activated, the SRS warning light will come on. In that case, the seat belt cannot be used again and must be replaced at your Toyota dealer.

■ Adjustable shoulder anchor

Always make sure the shoulder belt is positioned across the center of your shoulder. The belt should be kept away from your neck, but not falling off your shoulder. Failure to do so could reduce the amount of protection in an accident and cause death or serious injuries in the event of a sudden stop, sudden swerve or accident. (→P. 29)

 CAUTION**■ Seat belt damage and wear**

- Do not damage the seat belts by allowing the belt, plate, or buckle to be jammed in the door.
- Inspect the seat belt system periodically. Check for cuts, fraying, and loose parts. Do not use a damaged seat belt until it is replaced. Damaged seat belts cannot protect an occupant from death or serious injury.
- Ensure that the belt and plate are locked and the belt is not twisted. If the seat belt does not function correctly, immediately contact your Toyota dealer.
- Replace the seat assembly, including the belts, if your vehicle has been involved in a serious accident, even if there is no obvious damage.
- Do not attempt to install, remove, modify, disassemble or dispose of the seat belts. Have any necessary repairs carried out by your Toyota dealer. Inappropriate handling may lead to incorrect operation.

■ Using a seat belt extender

- Do not wear the seat belt extender if you can fasten the seat belt without the extender.
- Do not use the seat belt extender when installing a child restraint system because the belt will not securely hold the child restraint system, increasing the risk of death or serious injury in the event of an accident.
- The personalized extender may not be safe on another vehicle, when used by another person, or at a different seating position other than the one originally intended.

 NOTICE**■ When using a seat belt extender**

When releasing the seat belt, press on the buckle release button on the extender, not on the seat belt.
This helps prevent damage to the vehicle interior and the extender itself.

SRS airbags

The SRS airbags inflate when the vehicle is subjected to certain types of severe impacts that may cause significant injury to the occupants. They work together with the seat belts to help reduce the risk of death or serious injury.

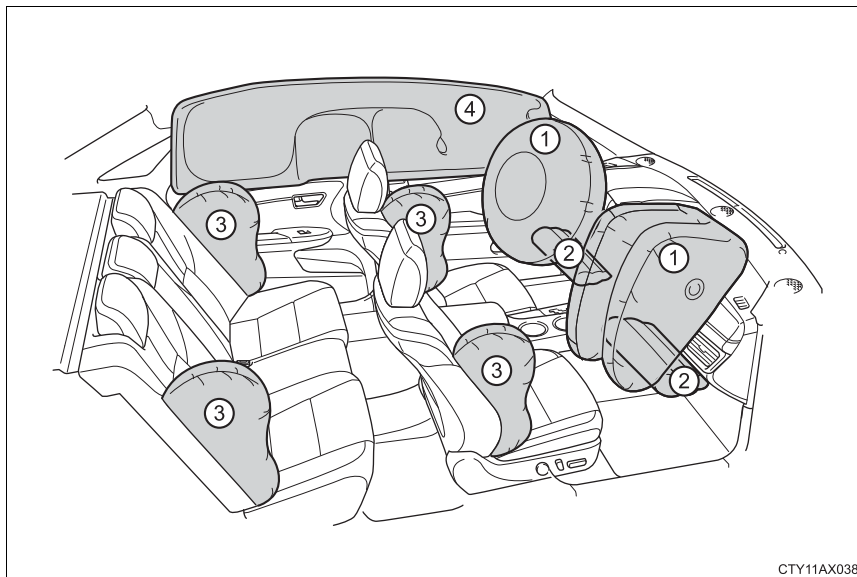

◆ SRS front airbags

- ① SRS driver airbag/front passenger airbag
Can help protect the head and chest of the driver and front passenger from impact with interior components
- ② SRS knee airbags
Can help provide driver and front passenger protection

◆ SRS side and curtain shield airbags

- ③ SRS front side airbags
Can help protect the torso of the front seat occupants
- SRS rear side airbags
Can help protect the torso of occupants in the rear outer seats
- ④ SRS curtain shield airbags
Can help protect primarily the head of occupants in the outer seats

SRS airbag system components

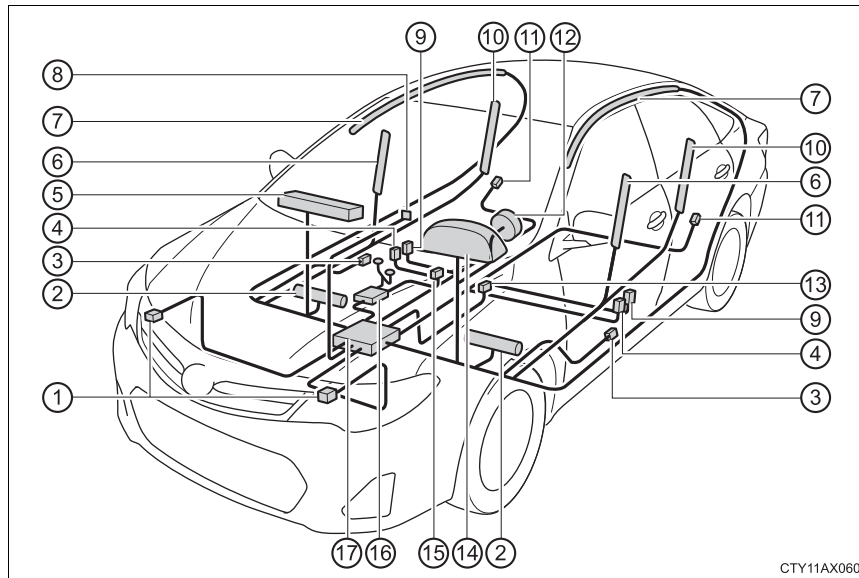

- | | |
|---|--|
| ① Front impact sensors | ⑪ Side impact sensors (rear) |
| ② Knee airbags | ⑫ Driver airbag |
| ③ Side impact sensors (front doors) | ⑬ Driver's seat belt buckle switch |
| ④ Seat belt pretensioners and force limiters | ⑭ SRS warning light |
| ⑤ Front passenger airbag | ⑮ Front passenger's seat belt buckle switch |
| ⑥ Front side airbags | ⑯ Front passenger occupant classification system (ECU and sensors) |
| ⑦ Curtain shield airbags | ⑰ Airbag sensor assembly |
| ⑧ "AIR BAG ON" and "AIR BAG OFF" indicator lights | |
| ⑨ Side impact sensors (front) | |
| ⑩ Rear side airbags | |

Your vehicle is equipped with ADVANCED AIRBAGS designed based on the US motor vehicle safety standards (FMVSS208). The airbag sensor assembly (ECU) controls airbag deployment based on information obtained from the sensors etc. shown in the system components diagram above. This information includes crash severity and occupant information. As the airbags deploy, a chemical reaction in the inflators quickly fills the airbags with non-toxic gas to help restrain the motion of the occupants.

 CAUTION

■ **SRS airbag precautions**

Observe the following precautions regarding the SRS airbags. Failure to do so may cause death or serious injury.

- The driver and all passengers in the vehicle must wear their seat belts properly.

The SRS airbags are supplemental devices to be used with the seat belts.

- The SRS driver airbag deploys with considerable force, and can cause death or serious injury especially if the driver is very close to the airbag. The National Highway Traffic Safety Administration (NHTSA) advises:

Since the risk zone for the driver's airbag is the first 2 - 3 in. (50 - 75 mm) of inflation, placing yourself 10 in. (250 mm) from your driver airbag provides you with a clear margin of safety. This distance is measured from the center of the steering wheel to your breastbone. If you sit less than 10 in. (250 mm) away now, you can change your driving position in several ways:

- Move your seat to the rear as far as you can while still reaching the pedals comfortably.
- Slightly recline the back of the seat.
Although vehicle designs vary, many drivers can achieve the 10 in. (250 mm) distance, even with the driver seat all the way forward, simply by reclining the back of the seat somewhat. If reclining the back of your seat makes it hard to see the road, raise yourself by using a firm, non-slippery cushion, or raise the seat if your vehicle has that feature.
- If your steering wheel is adjustable, tilt it downward. This points the airbag toward your chest instead of your head and neck.

The seat should be adjusted as recommended by NHTSA above, while still maintaining control of the foot pedals, steering wheel, and your view of the instrument panel controls.

⚠ CAUTION

■ **SRS airbag precautions**

- If the seat belt extender has been connected to the front seat belt buckle but the seat belt extender has not also been fastened to the latch plate of the seat belt, the SRS front airbags will judge that the driver and front passenger are wearing the seat belt even though the seat belt has not been connected. In this case, the SRS front airbags may not activate correctly in a collision, resulting in death or serious injury in the event of a collision. Be sure to wear the seat belt with the seat belt extender.

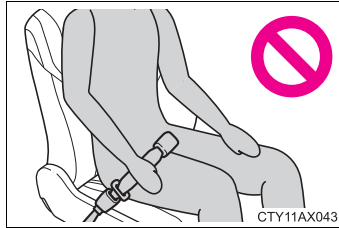

- The SRS front passenger airbag also deploys with considerable force, and can cause death or serious injury especially if the front passenger is very close to the airbag. The front passenger seat should be as far from the airbag as possible with the seatback adjusted, so the front passenger sits upright.
- Improperly seated and/or restrained infants and children can be killed or seriously injured by a deploying airbag. An infant or child who is too small to use a seat belt should be properly secured using a child restraint system. Toyota strongly recommends that all infants and children be placed in the rear seats of the vehicle and properly restrained. The rear seats are safer for infants and children than the front passenger seat. (→P. 51)
- Do not sit on the edge of the seat or lean against the dashboard.

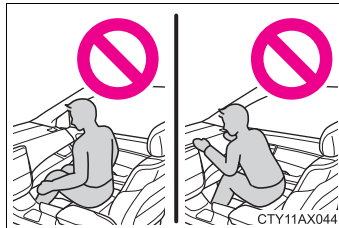

⚠ CAUTION

■ SRS airbag precautions

- Do not allow a child to stand in front of the SRS front passenger airbag unit or sit on the knees of a front passenger.
- Do not allow the front seat occupants to hold items on their knees.

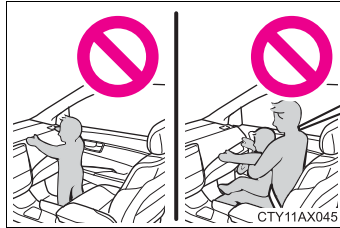

- Do not lean against the door, the roof side rail or the front, side and rear pillars.



- Do not allow anyone to kneel on the passenger seats toward the door or put their head or hands outside the vehicle.



- Do not attach anything to or lean anything against areas such as the dashboard, steering wheel pad and lower portion of the instrument panel. These items can become projectiles when the SRS driver, front passenger and knee airbags deploy.

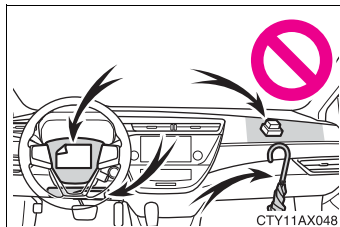

- Do not attach anything to areas such as a door, windshield glass, side door glass, front or rear pillar, roof side rail and assist grip.

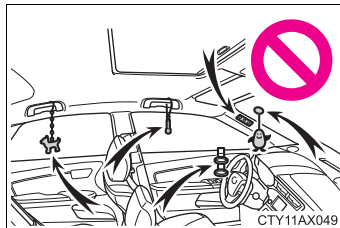

 CAUTION**■ SRS airbag precautions**

- Do not hang coat hangers or hard objects on the coat hooks. All of these items could become projectiles and may cause death or serious injury, should the SRS curtain shield airbags deploy.
- If a vinyl cover is put on the area where the SRS knee airbag will deploy, be sure to remove it.
- Do not use seat accessories which cover the parts where the SRS side airbags inflate as they may interfere with inflation of the airbags. Such accessories may prevent the side airbags from activating correctly, disable the system or cause the side airbags to inflate accidentally, resulting in death or serious injury.
- Do not strike or apply significant levels of force to the area of the SRS airbag components.
Doing so can cause the SRS airbags to malfunction.
- Do not touch any of the component parts immediately after the SRS airbags have deployed (inflated) as they may be hot.
- If breathing becomes difficult after the SRS airbags have deployed, open a door or window to allow fresh air in, or leave the vehicle if it is safe to do so. Wash off any residue as soon as possible to prevent skin irritation.
- If the areas where the SRS airbags are stored, such as the steering wheel pad and front and rear pillar garnishes are damaged or cracked, have them replaced by your Toyota dealer.

 **CAUTION****■ Modification and disposal of SRS airbag system components**

Do not dispose of your vehicle or perform any of the following modifications without consulting your Toyota dealer. The SRS airbags may malfunction or deploy (inflate) accidentally, causing death or serious injury.

- Installation, removal, disassembly and repair of the SRS airbags
- Repairs, modifications, removal or replacement of the steering wheel, instrument panel, dashboard, seats or seat upholstery, front, side and rear pillars or roof side rails
- Repairs or modifications of the front fender, front bumper, or side of the occupant compartment
- Installation of a grille guard (bull bars, kangaroo bar, etc.), snow plows or winches
- Modifications to the vehicle's suspension system
- Installation of electronic devices such as mobile two-way radios and CD players
- Modifications to your vehicle for a person with a physical disability

■ If the SRS airbags deploy (inflate)

- Bruising and slight abrasions may result from contact with a deploying (inflating) SRS airbag.
- A loud noise and white powder will be emitted.
- Parts of the airbag module (steering wheel hub, airbag cover and inflator) as well as the seats, parts of the front and rear pillars, and roof side rails may be hot for several minutes. The airbag itself may also be hot.
- The windshield may crack.
- For Safety Connect subscribers, if the SRS airbags deploy or in the event of a severe rear-end collision, the system is designed to send an emergency call to the response center, notifying them of the vehicle's location (without needing to push the "SOS" button) and an agent will attempt to speak with the occupants to ascertain the level of emergency and assistance required. If the occupants are unable to communicate, the agent automatically treats the call as an emergency and helps to dispatch the necessary emergency services. (→P. 290)

■ SRS airbag deployment conditions (SRS front airbags)

- The SRS front airbags will deploy in the event of an impact that exceeds the set threshold level (the level of force corresponding to an approximately 12 - 18 mph [20 - 30 km/h] frontal collision with a fixed wall that does not move or deform).

However, this threshold velocity will be considerably higher in the following situations:

- If the vehicle strikes an object, such as a parked vehicle or sign pole, which can move or deform on impact
- If the vehicle is involved in an underride collision, such as a collision in which the front of the vehicle “underrides”, or goes under, the bed of a truck
- Depending on the type of collision, it is possible that only the seat belt pretensioners will activate.
- The SRS front airbags for the front passenger will not activate if there is no passenger sitting in the front passenger seat. However, the SRS front airbags for the front passenger may deploy if luggage is put in the seat, even if the seat is unoccupied. (→P. 44)

■ SRS airbag deployment conditions (SRS side and curtain shield airbags)

- The SRS side and curtain shield airbags will deploy in the event of an impact that exceeds the set threshold level (the level of force corresponding to the impact force produced by an approximately 3300 lb. [1500 kg] vehicle colliding with the vehicle cabin from a direction perpendicular to the vehicle orientation at an approximate speed of 12 - 18 mph [20 - 30 km/h]).
- The SRS curtain shield airbags may also deploy in the event of a severe frontal collision.

■ Conditions under which the SRS airbags may deploy (inflate), other than a collision

The SRS front airbags may also deploy if a serious impact occurs to the underside of your vehicle. Some examples are shown in the illustration.

- Hitting a curb, edge of pavement or hard surface
- Falling into or jumping over a deep hole
- Landing hard or falling

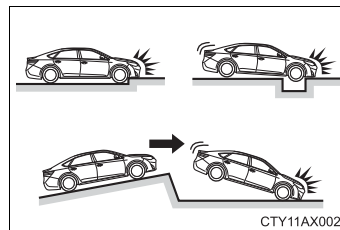

■ Types of collisions that may not deploy the SRS airbags (SRS front airbags)

The SRS front airbags do not generally inflate if the vehicle is involved in a side or rear collision, if it rolls over, or if it is involved in a low-speed frontal collision. But, whenever a collision of any type causes sufficient forward deceleration of the vehicle, deployment of the SRS front airbags may occur.

- Collision from the side
- Collision from the rear
- Vehicle rollover

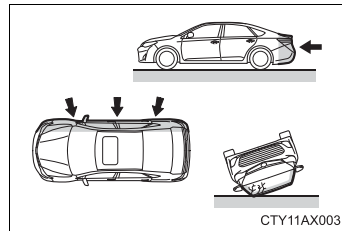

■ Types of collisions that may not deploy the SRS airbags (SRS side and curtain shield airbags)

The SRS side and curtain shield airbags may not activate if the vehicle is subjected to a collision from the side at certain angles, or a collision to the side of the vehicle body other than the passenger compartment.

- Collision from the side to the vehicle body other than the passenger compartment
- Collision from the side at an angle

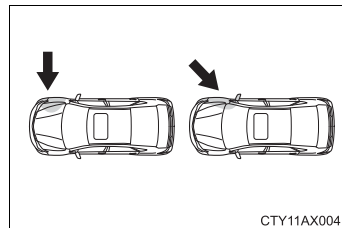

The SRS side and curtain shield airbags do not generally inflate if the vehicle is involved in a frontal or rear collision, if it rolls over, or if it is involved in a low-speed side collision.

- Collision from the front*
- Collision from the rear
- Vehicle rollover

*: Depending on the conditions and type of accident, the curtain shield airbags may deploy (inflate) upon frontal impact.

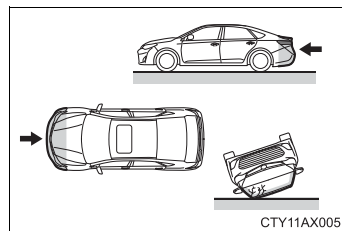

■ When to contact your Toyota dealer

In the following cases, the vehicle will require inspection and/or repair. Contact your Toyota dealer as soon as possible.

- Any of the SRS airbags have been inflated.
- The front of the vehicle is damaged or deformed, or was involved in an accident that was not severe enough to cause the SRS front airbags and SRS curtain shield airbags to inflate.

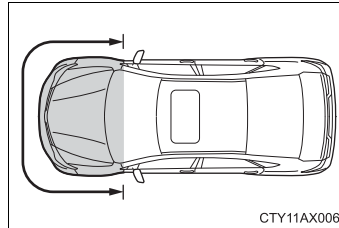

- A portion of a door is damaged or deformed, or the vehicle was involved in an accident that was not severe enough to cause the SRS side and curtain shield airbags to inflate.

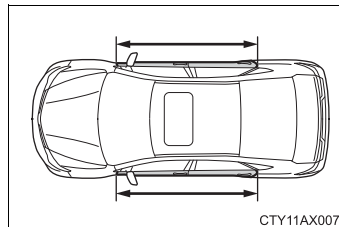

- The pad section of the steering wheel, dashboard near the front passenger airbag or lower portion of the instrument panel is scratched, cracked, or otherwise damaged.

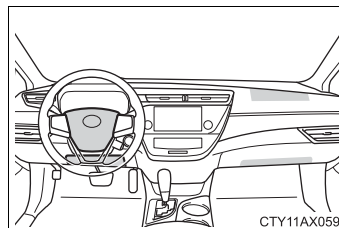

- The surface of the seats with the side airbag is scratched, cracked, or otherwise damaged.

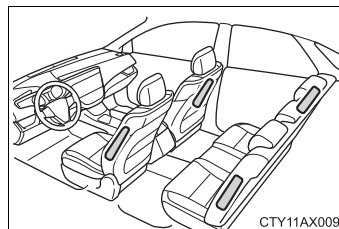

- The portion of the front pillars, rear pillars or roof side rail garnishes (padding) containing the curtain shield airbags inside is scratched, cracked, or otherwise damaged.

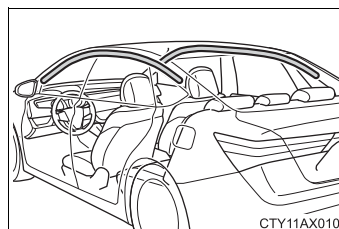

Front passenger occupant classification system

Your vehicle is equipped with a front passenger occupant classification system. This system detects the conditions of the front passenger seat and activates or deactivates the devices for the front passenger.

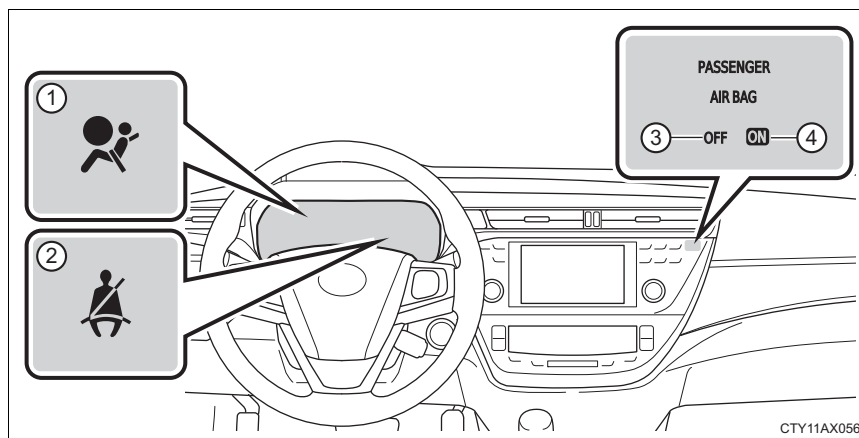

- ① SRS warning light
- ② Seat belt reminder light
- ③ "AIR BAG OFF" indicator light
- ④ "AIR BAG ON" indicator light

Condition and operation in the front passenger occupant classification system

■ Adult*1

Indicator/ warning light	“AIR BAG ON” and “AIR BAG OFF” indicator lights	“AIR BAG ON”
	SRS warning light	Off
	Seat belt reminder light	Off*2 or flashing*3
Devices	Front passenger airbag	Activated
	Side airbag on the front passenger seat	
	Curtain shield airbag in the front passenger side	
	Front passenger knee airbag	
	Front passenger’s seat belt pretensioner	

■ Child*4

Indicator/ warning light	“AIR BAG ON” and “AIR BAG OFF” indicator lights	“AIR BAG OFF” or “AIR BAG ON”*4
	SRS warning light	Off
	Seat belt reminder light	Off*2 or flashing*3
Devices	Front passenger airbag	Deactivated or activated*4
	Side airbag on the front passenger seat	Activated
	Curtain shield airbag in the front passenger side	
	Front passenger knee airbag	Deactivated or activated*4
	Front passenger's seat belt pretensioner	Activated

1

For safety and security

■ Child restraint system with infant*5

Indicator/ warning light	“AIR BAG ON” and “AIR BAG OFF” indicator lights	“AIR BAG OFF”*6
	SRS warning light	Off
	Seat belt reminder light	Off*2 or flashing *3
Devices	Front passenger airbag	Deactivated
	Side airbag on the front passenger seat	Activated
	Curtain shield airbag in the front passenger side	
	Front passenger knee airbag	Deactivated
	Front passenger’s seat belt pretensioner	Activated

■ Unoccupied

Indicator/ warning light	“AIR BAG ON” and “AIR BAG OFF” indicator lights	“AIR BAG OFF”
	SRS warning light	Off
	Seat belt reminder light	
Devices	Front passenger airbag	Deactivated
	Side airbag on the front passenger seat	Activated
	Curtain shield airbag in the front passenger side	
	Front passenger knee airbag	Deactivated
	Front passenger’s seat belt pretensioner	Activated

■ **There is a malfunction in the system**

Indicator/ warning light	“AIR BAG ON” and “AIR BAG OFF” indicator lights	“AIR BAG OFF”
	SRS warning light	On
	Seat belt reminder light	
Devices	Front passenger airbag	Deactivated
	Side airbag on the front passenger seat	Activated
	Curtain shield airbag in the front passenger side	
	Front passenger knee airbag	Deactivated
	Front passenger’s seat belt pretensioner	Activated

*1: The system judges a person of adult size as an adult. When a smaller adult sits in the front passenger seat, the system may not recognize him/her as an adult depending on his/her physique and posture.

*2: In the event the front passenger is wearing a seat belt.

*3: In the event the front passenger does not wear a seat belt

*4: For some children, child in seat, child in booster seat or child in convertible seat, the system may not recognize him/her as a child. Factors which may affect this can be the physique or posture.

*5: Never install a rear-facing child restraint system on the front passenger seat. A forward-facing child restraint system should only be installed on the front passenger seat when it is unavoidable. (→P. 51)

*6: In case the indicator light is not illuminated, consult this manual on how to install the child restraint system properly. (→P. 55)

 CAUTION**■ Front passenger occupant classification system precautions**

Observe the following precautions regarding the front passenger occupant classification system.

Failure to do so may cause death or serious injury.

- Wear the seat belt properly.
- Make sure the front passenger's seat belt plate has not been left inserted into the buckle before someone sits in the front passenger seat.
- Make sure the "AIR BAG OFF" indicator light is not illuminated when using the seat belt extender for the front passenger seat. If the "AIR BAG OFF" indicator light is illuminated, disconnect the extender tongue from the seat belt buckle, and reconnect the seat belt. Reconnect the seat belt extender after making sure the "AIR BAG ON" indicator light is illuminated. If you use the seat belt extender while the "AIR BAG OFF" indicator light is illuminated, the SRS airbags for the front passenger will not activate correctly, which could cause death or serious injury in the event of a collision.
- Do not apply a heavy load to the front passenger seat or equipment (e.g. seatback pockets or armrest).
- Do not put weight on the front passenger seat by putting your hands or feet on the front passenger seat seatback from the rear passenger seat.
- Do not let a rear passenger lift the front passenger seat with their feet or press on the seatback with their legs.
- Do not put objects under the front passenger seat.

 CAUTION**■ Front passenger occupant classification system precautions**

- Do not recline the front passenger seatback so far that it touches a rear seat. This may cause the “AIR BAG OFF” indicator light to be illuminated, which indicates that the SRS airbags for the front passenger will not deploy in the event of a severe accident. If the seatback touches the rear seat, return the seatback to a position where it does not touch the rear seat. Keep the front passenger seatback as upright as possible when the vehicle is moving. Reclining the seatback excessively may lessen the effectiveness of the seat belt system.
- If an adult sits in the front passenger seat, the “AIR BAG ON” indicator light is illuminated. If the “AIR BAG OFF” indicator is illuminated, ask the passenger to sit up straight, well back in the seat, feet on the floor, and with the seat belt worn correctly. If the “AIR BAG OFF” indicator still remains illuminated, either ask the passenger to move to the rear seat, or if that is not possible, move the front passenger seat fully rearward.
- When it is unavoidable to install a forward-facing child restraint system on the front passenger seat, install the child restraint system on the front passenger seat in the proper order. (→P. 55)
- Do not modify or remove the front seats.
- Do not kick the front passenger seat or subject it to severe impact. Otherwise, the SRS warning light may come on to indicate a malfunction of the detection system. In this case, contact your Toyota dealer immediately.
- Child restraint systems installed on the rear seat should not contact the front seatbacks.
- Do not use a seat accessory, such as a cushion and seat cover, that covers the seat cushion surface.
- Do not modify or replace the upholstery of the front seat.

Safety information for children

Observe the following precautions when children are in the vehicle.

Use a child restraint system appropriate for the child, until the child becomes large enough to properly wear the vehicle's seat belt.

- It is recommended that children sit in the rear seats to avoid accidental contact with the shift lever, wiper switch etc.
- Use the rear door child-protector lock or the window lock switch to avoid children opening the door while driving or operating the power window accidentally.
- Do not let small children operate equipment which may catch or pinch body parts, such as the power window, hood, trunk, seats etc.

CAUTION

Never leave children unattended in the vehicle, and never allow children to have or use the key.

Children may be able to start the vehicle or shift the vehicle into neutral. There is also a danger that children may injure themselves by playing with the windows, the moon roof or other features of the vehicle. In addition, heat build-up or extremely cold temperatures inside the vehicle can be fatal to children.

Child restraint systems

A child restraint system for a small child or baby must itself be properly restrained on the seat with the LATCH anchors or the lap portion of the lap/shoulder belt.

The laws of all 50 states of the U.S.A. and Canada now require the use of child restraint systems.

Points to remember

Studies have shown that installing a child restraint on a rear seat is much safer than installing one on the front passenger seat.

- Choose a child restraint system that suits your vehicle and is appropriate to the age and size of the child.
- For installation details, follow the instructions provided with the child restraint system.

General installation instructions are provided in this manual.

(→P. 55)

Types of child restraints

Child restraint systems are classified into the following 3 types according to the age and size of the child:

- ▶ Rear facing — Infant seat/convertible seat
- ▶ Forward facing — Convertible seat

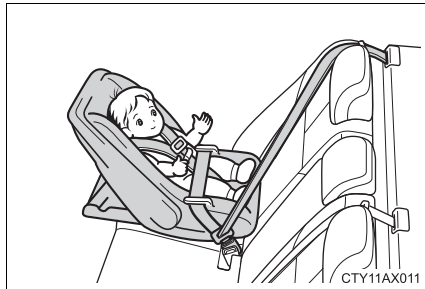

- ▶ Booster seat

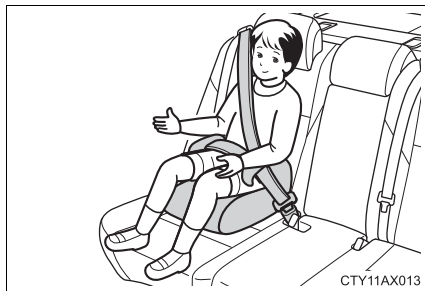

■ Selecting an appropriate child restraint system

- Use a child restraint system appropriate for the child until the child becomes large enough to properly wear the vehicle's seat belt.
- If the child is too large for a child restraint system, sit the child on a rear seat and use the vehicle's seat belt. (→P. 28)

 CAUTION**■ Child restraint precautions**

- For effective protection in automobile accidents and sudden stops, a child must be properly restrained, using a seat belt or child restraint system depending on the age and size of the child. Holding a child in your arms is not a substitute for a child restraint system. In an accident, the child can be crushed against the windshield, or between you and the vehicle's interior.
- Toyota strongly urges the use of a proper child restraint system that conforms to the size of the child, installed on the rear seat. According to accident statistics, the child is safer when properly restrained in the rear seat than in the front seat.
- Never install a rear-facing child restraint system on the front passenger seat even if the "AIR BAG OFF" indicator light is illuminated.
In the event of an accident, the force of the rapid inflation of the front passenger airbag can cause death or serious injury to the child if the rear-facing child restraint system is installed on the front passenger seat.
- A forward-facing child restraint system may be installed on the front passenger seat only when it is unavoidable. A child restraint system that requires a top tether strap should not be used in the front passenger seat since there is no top tether strap anchor for the front passenger seat. Adjust the seatback as upright as possible and always move the seat as far back as possible even if the "AIR BAG OFF" indicator light is illuminated, because the front passenger airbag could inflate with considerable speed and force. Otherwise, the child may be killed or seriously injured.
- Do not use the seat belt extender when installing a child restraint system on the front or rear passenger seat. If installing a child restraint system with the seat belt extender connected to the seat belt, the seat belt will not securely hold the child restraint system, which could cause death or serious injury to the child or other passengers in the event of an accident.
- Do not allow the child to lean his/her head or any part of his/her body against the door or the area of the seat, front and rear pillars or roof side rails from which the SRS side airbags or SRS curtain shield airbags deploy even if the child is seated in the child restraint system. It is dangerous if the SRS side airbags and curtain shield airbags inflate, and the impact could cause death or serious injury to the child.
- Make sure you have complied with all installation instructions provided by the child restraint manufacturer and that the system is properly secured. If it is not secured properly, it may cause death or serious injury to the child in the event of a sudden stop, sudden swerve or accident.

 **CAUTION****■ When children are in the vehicle**

Do not allow children to play with the seat belt. If the seat belt becomes twisted around a child's neck, it may lead to choking or other serious injuries that could result in death.

If this occurs and the buckle cannot be unfastened, scissors should be used to cut the belt.

■ When the child restraint system is not in use

- Keep the child restraint system properly secured on the seat even if it is not in use. Do not store the child restraint system unsecured in the passenger compartment.

- If it is necessary to detach the child restraint system, remove it from the vehicle or store it securely in the trunk. This will prevent it from injuring passengers in the event of a sudden stop, sudden swerve or accident.

Installing child restraints

Follow the child restraint system manufacturer's instructions. Firmly secure child restraints to the seats using the LATCH anchors or a seat belt. Attach the top tether strap when installing a child restraint.

The lap/shoulder belt can be used if your child restraint system is not compatible with the LATCH (Lower Anchors and Tethers for Children) system.

Child restraint LATCH anchors

LATCH anchors are provided for the outboard rear seats. (Buttons displaying the location of the anchors are attached to the seats.)

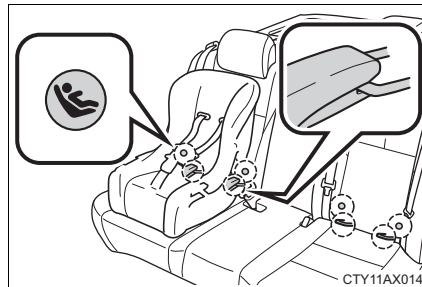

Seat belts equipped with a child restraint locking mechanism (ALR/ELR belts except driver's seat belt) (→P. 30)

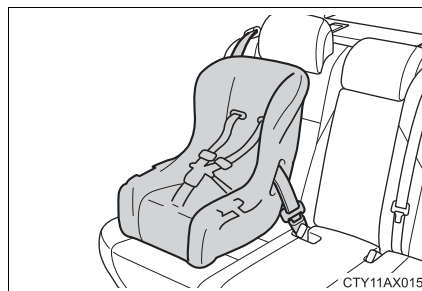

Anchor brackets (for top tether strap)

An anchor bracket is provided for each rear seat.

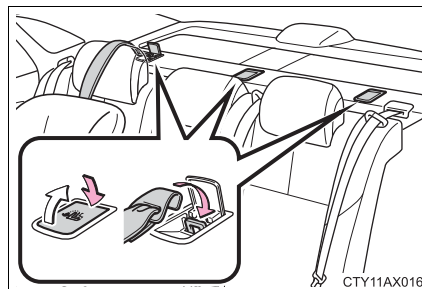

Installation with LATCH system

- 1 Adjust the head restraint to the downmost position. (→P. 125)
- 2 Widen the gap between the seat cushion and seatback slightly.
- 3 Rear left seat only: Slide the rear center seat belt to the side to prevent it from getting pinched in the lower anchorage.

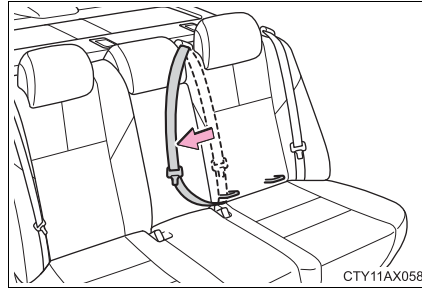

► Type A

- 4 Latch the hooks of the lower straps onto the LATCH anchors. If the child restraint has a top tether strap, the top tether strap should be latched onto the top tether strap anchor.

For owners in Canada:

The symbol on a child restraint system indicates the presence of a lower connector system.

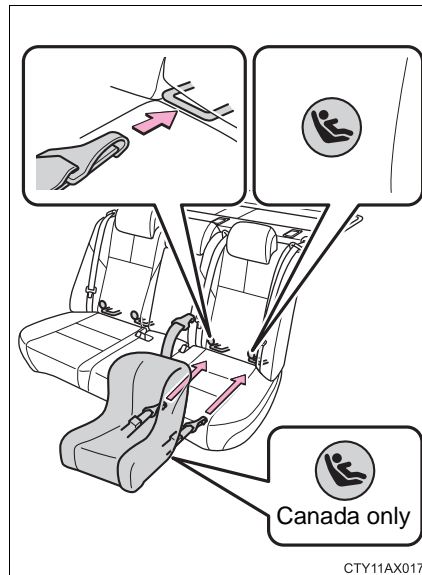

► Type B

- 4 Latch the buckles onto the LATCH anchors. If the child restraint has a top tether strap, the top tether strap should be latched onto the top tether strap anchor.

For owners in Canada:

The symbol on a child restraint system indicates the presence of a lower connector system.



Installing child restraints using a seat belt (child restraint lock function belt)**■ Rear-facing — Infant seat/convertible seat**

- 1 Place the child restraint system on the rear seat facing the rear of the vehicle.

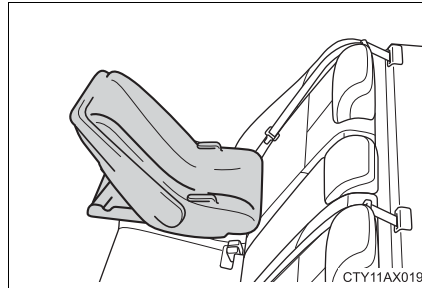

- 2 Run the seat belt through the child restraint system and insert the plate into the buckle. Make sure that the belt is not twisted.

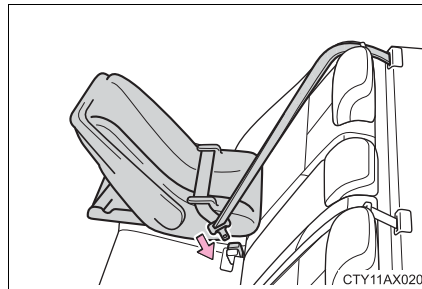

- 3 Fully extend the shoulder belt and allow it to retract to put it in lock mode. In lock mode, the belt cannot be extended.

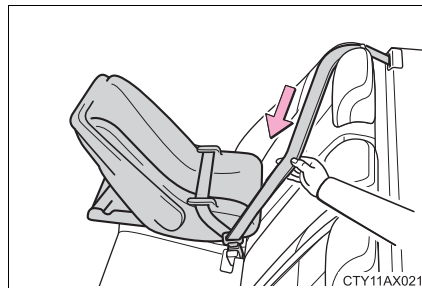

- 4 While pushing the child restraint system down into the rear seat, allow the shoulder belt to retract until the child restraint system is securely in place.

After the shoulder belt has retracted to a point where there is no slack in the belt, pull the belt to check that it cannot be extended.

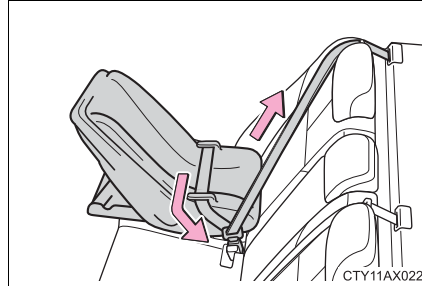

■ Forward-facing — Convertible seat

- 1 Adjust the head restraint to the downmost position. (→P. 125)
- 2 Place the child restraint system on the seat facing the front of the vehicle.

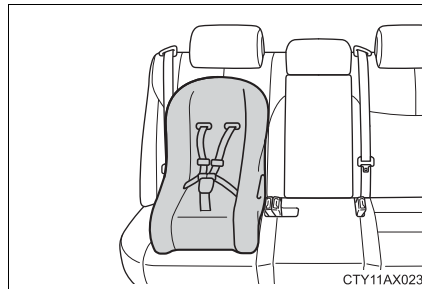

- 3 Run the seat belt through the child restraint system and insert the plate into the buckle. Make sure that the belt is not twisted.

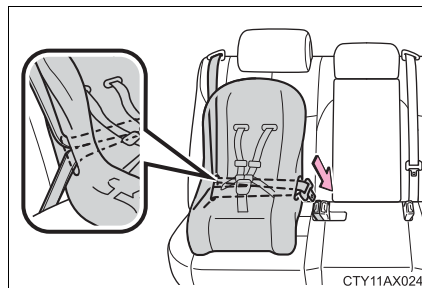

- 4 Fully extend the shoulder belt and allow it to retract to put it in lock mode. In lock mode, the belt cannot be extended.

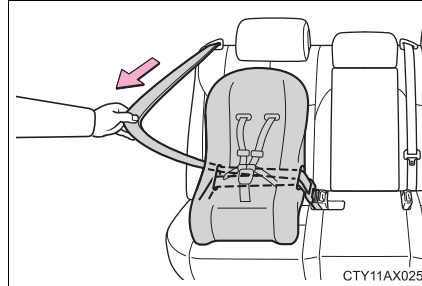

- 5 While pushing the child restraint system into the rear seat, allow the shoulder belt to retract until the child restraint system is securely in place.

After the shoulder belt has retracted to a point where there is no slack in the belt, pull the belt to check that it cannot be extended.

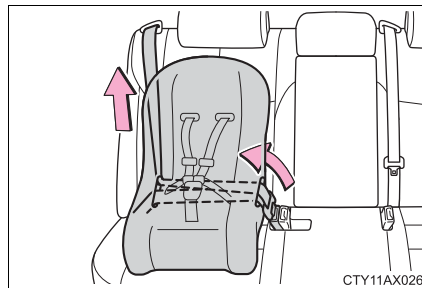

- 6 If the child restraint has a top tether strap, the top tether strap should be latched onto the top tether strap anchor. (→P. 62)

■ Booster seat

- 1 Place the child restraint system on the seat facing the front of the vehicle.

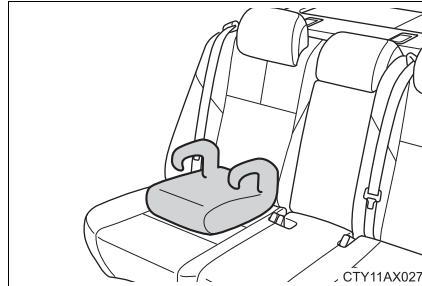

- 2 Sit the child in the child restraint system. Fit the seat belt to the child restraint system according to the manufacturer's instructions and insert the plate into the buckle. Make sure that the belt is not twisted.



Check that the shoulder belt is correctly positioned over the child's shoulder and that the lap belt is as low as possible.

(→P. 28)

Removing a child restraint installed with a seat belt

Push the buckle release button and fully retract the seat belt.

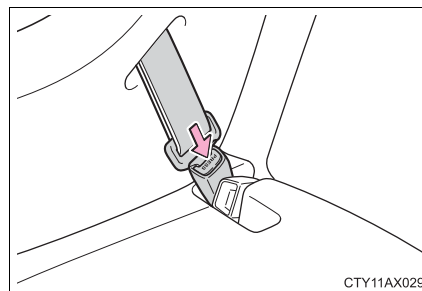

Child restraint systems with a top tether strap

- 1 Adjust the head restraint to the downmost position. (→P. 125)
- 2 Secure the child restraint system using the seat belt or LATCH anchors.

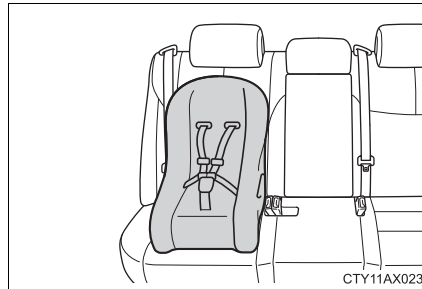

- 3 Open the anchor bracket cover, latch the hook onto the anchor bracket and tighten the top tether strap.
Make sure the top tether strap is securely latched.

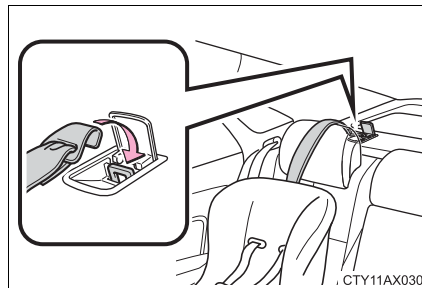

■ Laws and regulations pertaining to anchorages

The LATCH system conforms to FMVSS225 or CMVSS210.2.

Child restraint systems conforming to FMVSS213 or CMVSS213 specifications can be used.

This vehicle is designed to conform to the SAE J1819.

⚠ CAUTION

■ **When installing a booster seat**

To prevent the belt from going into ALR lock mode, do not fully extend the shoulder belt. ALR mode causes the belt to tighten only. This could cause injury or discomfort to the child. (→P. 30)

■ **When installing a child restraint system**

Follow the directions given in the child restraint system installation manual and fix the child restraint system securely in place.

If the child restraint system is not correctly fixed in place, the child or other passengers may be seriously injured or even killed in the event of a sudden braking or an accident.

- If the driver's seat interferes with the child restraint system and prevents it from being attached correctly, attach the child restraint system to the right-hand rear seat.
- Adjust the front passenger seat so that it does not interfere with the child restraint system.
- Only put a forward-facing child restraint system on the front seat when unavoidable. When installing a forward-facing child restraint system on the front passenger seat, move the seat as far back as possible even if the "AIR BAG OFF" indicator light is illuminated. Failure to do so may result in death or serious injury if the airbags deploy (inflate).

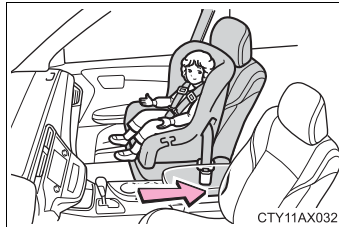
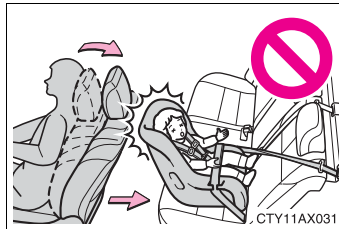

 **CAUTION****■ When installing a child restraint system**

- When a booster seat is installed, always ensure that the shoulder belt is positioned across the center of the child's shoulder. The belt should be kept away from the child's neck, but not so that it could fall off the child's shoulder. Failing to do so may result in death or serious injury in the event of an accident or a sudden braking.
- Ensure that the belt and plate are securely locked and the seat belt is not twisted.
- Shake the child restraint system left and right, and forward and backward to ensure that it has been securely installed.
- After securing a child restraint system, never adjust the seat.
- Follow all installation instructions provided by the child restraint system manufacturer.

■ Do not use a seat belt extender

If a seat belt extender is used when installing a child restraint system, the seat belt will not securely hold the child restraint system, which could cause death or serious injury to the child or other passengers in the event of a sudden braking, sudden swerving or an accident.

■ To correctly attach a child restraint system to the anchors

When using the LATCH anchors, be sure that there are no foreign objects around the anchors and that the seat belt is not caught behind the child restraint system. Make sure the child restraint system is securely attached, or it may cause death or serious injury to the child or other passengers in the event of a sudden braking or an accident.

Exhaust gas precautions

Harmful substance to the human body is included in exhaust gases if inhaled.

CAUTION

Exhaust gases include harmful carbon monoxide (CO), which is colorless and odorless. Observe the following precautions.

Failure to do so may cause exhaust gases to enter the vehicle and may lead to an accident caused by light-headedness, or may lead to death or a serious health hazard.

■ Important points while driving

- Keep the trunk lid closed.
- If you smell exhaust gases in the vehicle even when the trunk lid is closed, open the windows and have the vehicle inspected at your Toyota dealer as soon as possible.

■ When parking

- If the vehicle is in a poorly ventilated area or a closed area, such as a garage, stop the engine.
- Do not leave the vehicle with the engine on for a long time.
If such a situation cannot be avoided, park the vehicle in an open space and ensure that exhaust fumes do not enter the vehicle interior.
- Do not leave the engine running in an area with snow build-up, or where it is snowing. If snowbanks build up around the vehicle while the engine is running, exhaust gases may collect and enter the vehicle.

■ Exhaust pipe

The exhaust system needs to be checked periodically. If there is a hole or crack caused by corrosion, damage to a joint or abnormal exhaust noise, be sure to have the vehicle inspected and repaired by your Toyota dealer.

Engine immobilizer system

The vehicle's keys have built-in transponder chips that prevent the engine from starting if a key has not been previously registered in the vehicle's on-board computer.

Never leave the keys inside the vehicle when you leave the vehicle.

This system is designed to help prevent vehicle theft but does not guarantee absolute security against all vehicle thefts.

The indicator light flashes after the engine switch has been turned off to indicate that the system is operating.

The indicator light stops flashing after the engine switch has been turned to ACCESSORY or IGNITION ON mode to indicate that the system has been canceled.

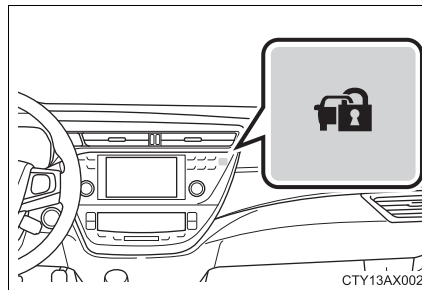

■ System maintenance

The vehicle has a maintenance-free type engine immobilizer system.

■ Conditions that may cause the system to malfunction

- If the grip portion of the key is in contact with a metallic object
- If the key is in close proximity to or touching a key to the security system (key with a built-in transponder chip) of another vehicle

■ Certifications for the engine immobilizer system

- ▶ For vehicles sold in the U.S.A.

FCC ID: NI4TMIMB-3

This device complies with part 15 of the FCC Rules. Operation is subject to the following two conditions: (1) This device may not cause harmful interference, and (2) this device must accept any interference received, including interference that may cause undesired operation.

- ▶ For vehicles sold in Canada

Operation is subject to the following two conditions: (1) this device may not cause interference, and (2) this device must accept any interference, including interference that may cause undesired operation of the device.

⚠ CAUTION**■ Certifications for the engine immobilizer system**

Changes or modifications not expressly approved by the party responsible for compliance could void the user's authority to operate the equipment.

⚠ NOTICE**■ To ensure the system operates correctly**

Do not modify or remove the system. If modified or removed, the proper operation of the system cannot be guaranteed.

Alarm

The alarm

The alarm uses light and sound to give an alert when an intrusion is detected.

The alarm is triggered in the following situations when the alarm is set:

- A locked door or trunk is unlocked or opened in any way other than using the entry function, wireless remote control or mechanical key.
- The hood is opened.
- Some models: The window is tapped or broken.

Setting the alarm system

Close the doors, trunk and hood, and lock all the doors. The system will be set automatically after 30 seconds.

The indicator light changes from being on to flashing when the system is set.

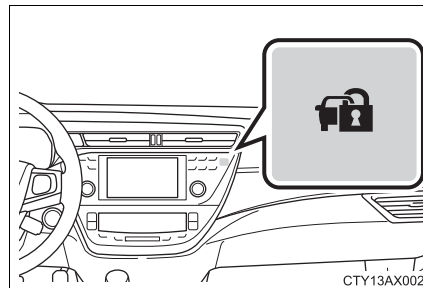

Deactivating or stopping the alarm

Do one of the following to deactivate or stop the alarms:

- Unlock the doors or open the trunk.
- Turn the engine switch to ACCESSORY or IGNITION ON mode, or start the engine. (The alarm will be deactivated or stopped after a few seconds.)

■ System maintenance

The vehicle has a maintenance-free type alarm system.

■ Items to check before locking the vehicle

To prevent unexpected triggering of the alarm and vehicle theft, make sure of the following:

- Nobody is in the vehicle.
- The windows and moon roof are closed before the alarm is set.
- No valuables or other personal items are left in the vehicle.

■ Triggering of the alarm

The alarm may be triggered in the following situations:
(Stopping the alarm deactivates the alarm system.)

- A person inside the vehicle opens a door, the trunk or hood.



- The battery is recharged or replaced when the vehicle is locked.

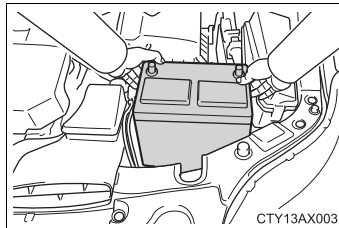

■ Alarm-operated door lock

- When the alarm is operating, the doors are locked automatically to prevent intruders.
- Do not leave the key inside the vehicle when the alarm is operating, and make sure the key is not inside the vehicle when recharging or replacing the battery.

⚠ NOTICE

■ To ensure the system operates correctly

Do not modify or remove the system. If modified or removed, the proper operation of the system cannot be guaranteed.

Theft prevention labels (U.S.A.)

These labels are attached to the vehicle to reduce vehicle theft by facilitating the tracing and recovery of parts from stolen vehicles. Do not remove under penalty of law.

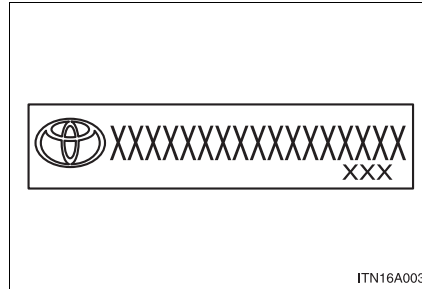

Instrument cluster

2

71

2. Instrument cluster

Warning lights and indicators 72
Gauges and meters 77
Multi-information display 80
Fuel consumption information 86

Warning lights and indicators

The warning lights and indicators on the instrument cluster and center panel inform the driver of the status of the vehicle's various systems.

For the purpose of explanation, the following illustration displays all warning lights and indicators illuminated.

◆ Instrument cluster

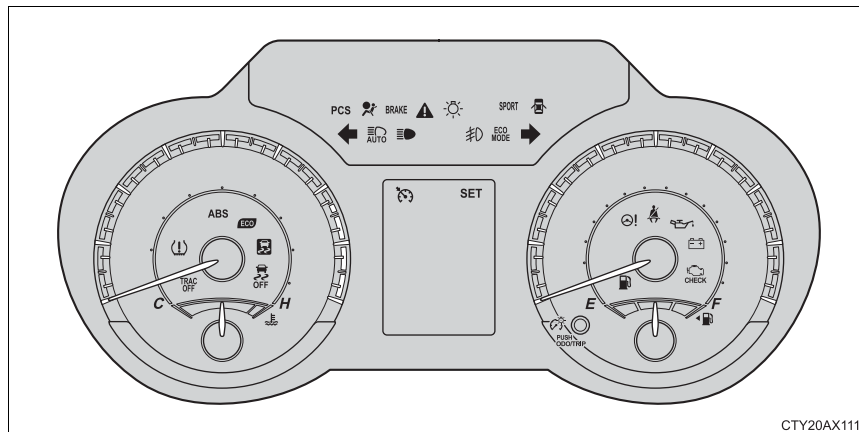





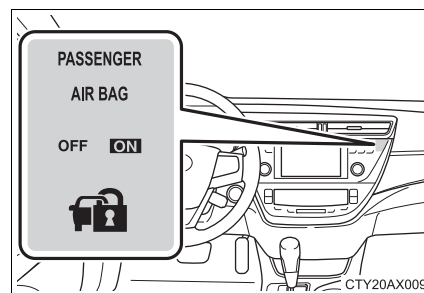











The units used on the speedometer and some indicators may differ depending on where the vehicle is sold.

◆ Center panel



Warning lights

Warning lights inform the driver of malfunctions in the indicated vehicle's systems.

* ₁		* ₁	
(U.S.A.)	Brake system warning light (→P. 388)	(U.S.A.)	Slip indicator (→P. 390)
* ₁		* ₁	
(Canada)	Brake system warning light (→P. 388)	(Canada)	Open door warning light (→P. 391)
* ₁		* ₁	
(U.S.A.)	Charging system warning light (→P. 389)	(U.S.A.)	Low fuel level warning light (→P. 391)
* ₁		* ₁	
(U.S.A.)	Malfunction indicator lamp (→P. 389)	(U.S.A.)	Seat belt reminder light (→P. 391)
* ₁		* ₁	
(Canada)	Malfunction indicator lamp (→P. 389)	(Canada)	Low engine oil pressure warning light (→P. 389)
* ₁		* ₁	
(U.S.A.)	SRS warning light (→P. 389)	(U.S.A.)	Electric power steering system warning light (→P. 390)
* ₁		* _{1, 2}	
(U.S.A.)	ABS warning light (→P. 389)	(if equipped)	"PCS" warning light (→P. 390)
* ₁		* ₁	
(Canada)	ABS warning light (→P. 389)	(Canada)	Master warning light (→P. 391)

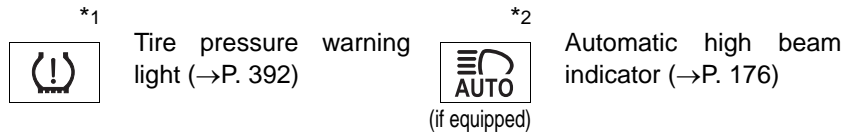



















*1: These lights turn on when the engine switch is turned to IGNITION ON mode to indicate that a system check is being performed. They will turn off after the engine is started, or after a few seconds. There may be a malfunction in a system if the lights do not come on, or do not turn off. Have the vehicle inspected by your Toyota dealer.

*2: The light flashes to indicate a malfunction.

Indicators

The indicators inform the driver of the operating state of the vehicle's various systems.

	Turn signal indicator (→P. 169)		Automatic high beam indicator (→P. 176)
		(if equipped)	
	Headlight indicator (→P. 172)		Eco drive mode indicator (→P. 213)
(U.S.A.)			
	Tail light indicator (→P. 172)		Sport mode indicator (→P. 213)
(Canada)			
	Headlight high beam indicator (→P. 173)		Slip indicator (→P. 216)
		*1, 2	
	Front fog light indicator (→P. 181)		VSC OFF indicator (→P. 216)
(if equipped)		*1	
	Security indicator (→P. 66, 68)		"PCS" warning light (→P. 221)
		*1, 3	
		(if equipped)	
	Eco Driving Indicator Light (→P. 144)		"AIR BAG ON/OFF" indicator (→P. 44)
*1		*1	
	"TRAC OFF" indicator (→P. 216)		Cruise control set indicator (→P. 194, 198)
*1			
	Cruise control indicator (→P. 194)		Radar cruise control indicator (→P. 198)
(if equipped)		(if equipped)	

- *1: These lights turn on when the engine switch is turned to IGNITION ON mode to indicate that a system check is being performed. They will turn off after the engine is started, or after a few seconds. There may be a malfunction in a system if the lights do not come on, or do not turn off. Have the vehicle inspected by your Toyota dealer.
- *2: The light flashes to indicate that the system is operating.
- *3: The light comes on when the system is turned off. The light flashes faster than usual to indicate that the system is operating.

 CAUTION

■ **If a safety system warning light does not come on**

Should a safety system light such as the ABS and SRS warning light not come on when you start the engine, this could mean that these systems are not available to help protect you in an accident, which could result in death or serious injury. Have the vehicle inspected by your Toyota dealer immediately if this occurs.

Gauges and meters

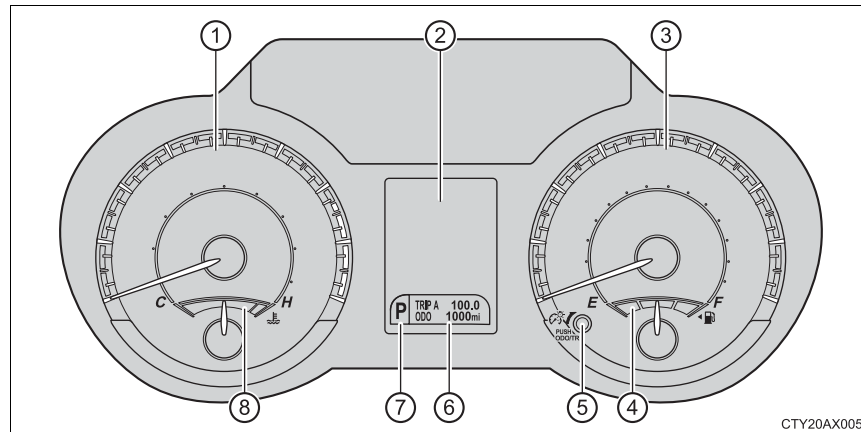

The units used on the speedometer may differ depending on where the vehicle is sold.

- ① Tachometer
Displays the engine speed in revolutions per minute
- ② Multi-information display
Presents the driver with a variety of driving-related data (→P. 80)
- ③ Speedometer
Displays the vehicle speed
- ④ Fuel gauge
Displays the quantity of fuel remaining in the tank
- ⑤ Trip meter reset knob/instrument panel light control knob
→P. 78, 79

2

Instrument cluster

⑥ Odometer and trip meter display

Odometer:

Displays the total distance the vehicle has been driven

Trip meter:

Displays the distance the vehicle has been driven since the meter was last reset. Trip meters "A" and "B" can be used to record and display different distances independently.

⑦ Shift position and shift range

Displays the selected shift position or selected shift range (→P. 165)

⑧ Engine coolant temperature gauge

Displays the engine coolant temperature

Changing the trip meter display

Switches between trip meter "A" and "B" displays. When the trip meter is displayed, pressing and holding the knob will reset the trip meter.

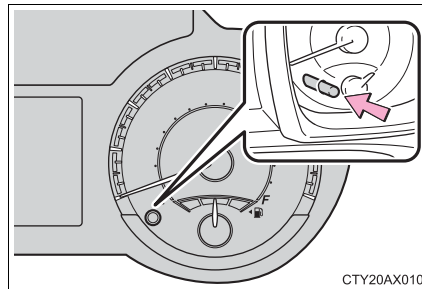

Instrument panel light control

The brightness of the instrument panel lights can be adjusted.

- ① Darker
- ② Brighter

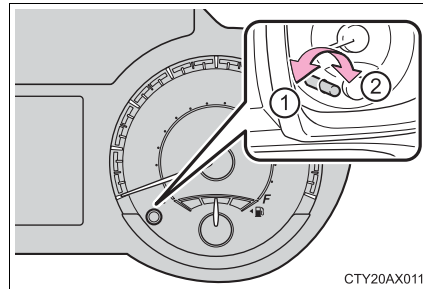

2

Instrument cluster

■ The meters and display illuminate when

The engine switch is in IGNITION ON mode.

■ The brightness of the instrument panel lights

- When the headlight switch is turned to on, the brightness will be reduced slightly unless the control knob is turned fully clockwise.
- When the knob is turned fully clockwise, the display audio/navigation system screen will always be in day mode regardless of the headlight switch position.

■ Customization

The instrument panel light auto dimmer control can be changed.
(Customizable feature: →P. 455)

⚠ NOTICE

■ To prevent damage to the engine and its components

- Do not let the indicator needle of the tachometer enter the red zone, which indicates the maximum engine speed.
- The engine may be overheating if the engine coolant temperature gauge is in the red zone (H). In this case, immediately stop the vehicle in a safe place, and check the engine after it has cooled completely. (→P. 423)

Multi-information display

Display contents

The multi-information display presents the driver with a variety of driving-related data.

- Distance to empty (→P. 81)
- Average fuel economy (→P. 81)
- Current fuel economy (→P. 82)
- ECO Drive Level (→P. 82)
- Digital speedometer (→P. 82)
- Turn-by-turn navigation (vehicles with a navigation system) (→P. 82)
- Settings (→P. 83)
- Warning messages and reminder messages (→P. 399)
Automatically displayed when a malfunction occurs in one of the vehicle's systems or when a reminder message is required. The display returns to the previous screen by pressing the "DISP" button. (→P. 81)
- Cruise control display (if equipped) (→P. 194)
- Dynamic radar cruise control display (if equipped) (→P. 198)

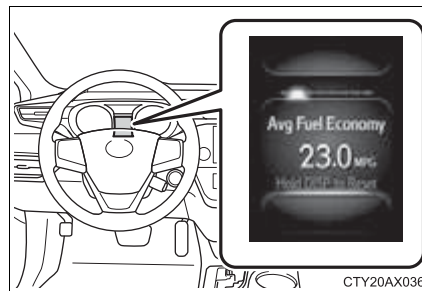

Trip information

■ Switching the display

Items displayed can be switched by pressing the “DISP” button.

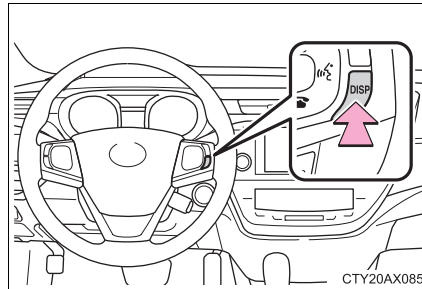

■ Distance to empty

Displays the estimated maximum distance that can be driven with the quantity of fuel remaining.

- This distance is computed based on your average fuel consumption. As a result, the actual distance that can be driven may differ from that displayed.
- When only a small amount of fuel is added to the tank, the display may not be updated. When refueling, turn the engine switch off. If the vehicle is refueled without turning the engine switch off, the display may not be updated.

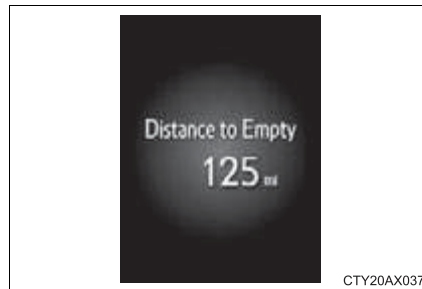

■ Average fuel economy

Displays the average fuel consumption since the function was reset.

- The function can be reset by pressing and holding the “DISP” button when the average fuel consumption is displayed.
- Use the displayed average fuel consumption as a reference.



■ Current fuel economy

Displays the current rate of fuel consumption.



CTY20AX039

■ ECO Drive Level

Suggests Eco driving level based on acceleration.

- ① All green suggests the status of the most Eco-friendly driving.
- ② All blue suggests the status of the least Eco-friendly driving.

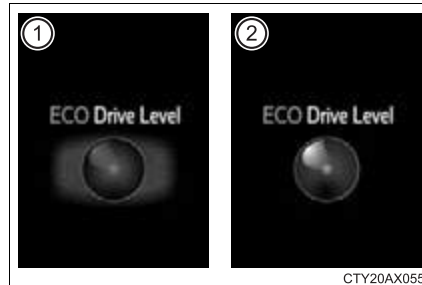

CTY20AX055

■ Digital speedometer

Displays the current vehicle speed.

This screen can be disabled in the "Settings" screen. (→P. 83)

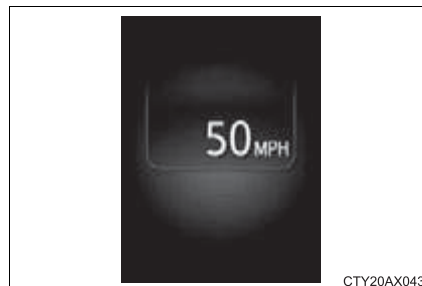

CTY20AX043

■ Turn-by-turn navigation (vehicles with a navigation system)

Displays information from the navigation system about the next turn on the guidance route.



CTY20AX100

Setting up the displays

■ Customizable items

Item	Default setting	Customized setting
Digital speedometer	On	Off
Units (vehicles without a navigation system)	English	Metric
Turn-by-turn navigation (vehicles with a navigation system)	On	Off
Eco Driving Indicator Light	Off	On

■ Changing the settings

- 1 While the vehicle is stopped, press the “DISP” button until the “Settings” screen appears.

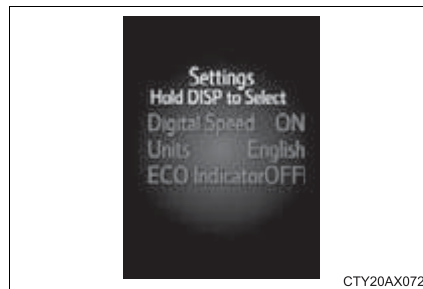

- 2 Press and hold the “DISP” button while the “Settings” screen is displayed.

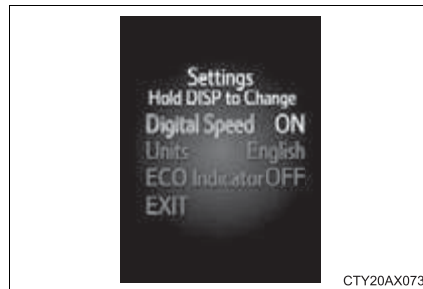

- 3 Press the “DISP” button to select the desired setting item.



- 4 Press and hold the “DISP” button to select the desired setting.

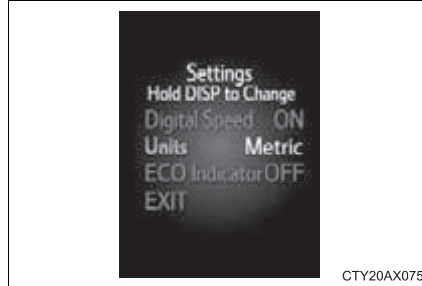

- 5 Press and hold the “DISP” button after selecting the “EXIT” by pressing the “DISP” button.
The display goes back to step 1.



■ **System check display**

After turning the engine switch to IGNITION ON mode, “SYSTEM CHECK” is displayed while system operation is checked.

■ **Trip summary display**

When the engine is turned off, drive information data since the engine was started is displayed for 3 seconds.



■ **Setting display automatic cancelation**

In the following situations, setting display in which the settings can be changed through the “DISP” button will automatically be turned off.

- When a warning message appears while the setting display is displayed
- When the vehicle begins to move while the setting display is displayed

■ **Liquid crystal display**

Small spots or light spots may appear on the display. This phenomenon is characteristic of liquid crystal displays, and there is no problem continuing to use the display.

 CAUTION**■ The information display at low temperatures**

Allow the interior of the vehicle to warm up before using the liquid crystal information display. At extremely low temperatures, the information display monitor may respond slowly, and display changes may be delayed.

For example, there is a lag between the driver's shifting and the new gear number appearing on the display. This lag could cause the driver to down-shift again, causing rapid and excessive engine braking and possibly an accident resulting in death or injury.

■ Cautions during setting up the display

As the engine needs to be running during setting up the display, ensure that the vehicle is parked in a place with adequate ventilation. In a closed area such as a garage, exhaust gases including harmful carbon monoxide (CO) may collect and enter the vehicle. This may lead to death or a serious health hazard.

 NOTICE**■ During setting up the display**

To prevent battery discharge, ensure that the engine is running while setting up the display features.

Fuel consumption information

Fuel consumption information can be displayed on the audio system screen.

Audio system

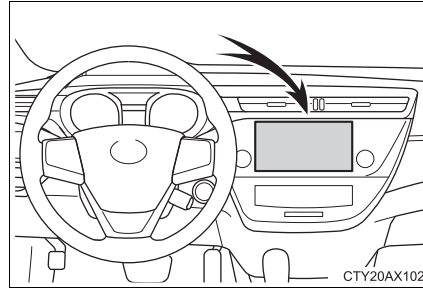

Trip information

Press “APPS” button and select “Eco” to display the “Trip Information” screen.

If the “Trip Information” screen does not appear, select “Trip Information”.

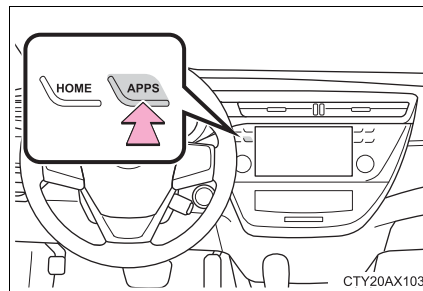

- ① Average vehicle speed
- ② Elapsed time
- ③ Range
- ④ Previous fuel consumption per minute
- ⑤ Current fuel consumption
- ⑥ Reset the trip information data
- ⑦ “Past Record” screen appears

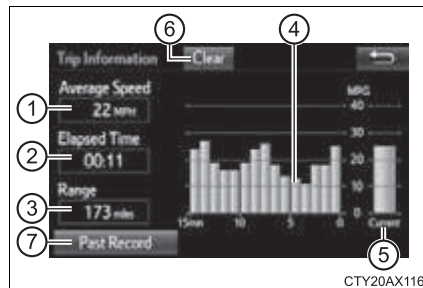

These images are examples only, and may vary slightly from actual conditions.

Past record

Press “APPS” button and select “Eco” to display the “Past Record” screen.

If the “Past Record” screen does not appear, select “Past Record”.

- ① Previous fuel economy record
- ② Current fuel economy
- ③ Best recorded fuel economy
- ④ Update the past record data
- ⑤ Reset the past record data
- ⑥ “Trip Information” screen appears
- ⑦ Average recorded fuel economy

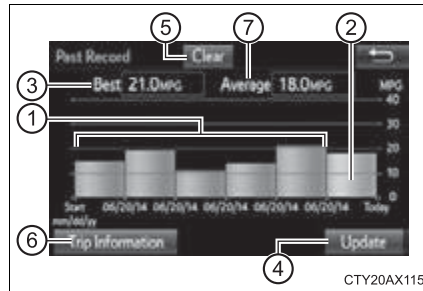

2

Instrument cluster

These images are examples only, and may vary slightly from actual conditions.

■ Updating the past record data

Selecting “Update” on the “Past Record” screen will update the past record data.

■ Resetting the data

Selecting “Clear” on the consumption screen will reset the consumption data.
Selecting “Clear” on the “Past Record” screen will reset the past record data.

■ Customization

The touch button sensitivity can be changed.
(Customizable features: →P. 455)

**Operation of
each component****3**

- 3-1. Key information**
 - Keys 90
- 3-2. Opening, closing and locking the doors**
 - Smart key system 93
 - Wireless remote control 108
 - Doors 111
 - Trunk..... 114
- 3-3. Adjusting the seats**
 - Front seats 118
 - Driving position memory 120
 - Head restraints..... 125
- 3-4. Adjusting the steering wheel and mirrors**
 - Steering wheel 128
 - Inside rear view mirror 129
 - Outside rear view mirrors..... 131
- 3-5. Opening, closing the windows and moon roof**
 - Power windows 134
 - Moon roof..... 137

Keys

The keys

The following keys are provided with the vehicle.

- ① Electronic keys
 - Operating the smart key system (→P. 93)
 - Operating the wireless remote control function (→P. 108)
- ② Mechanical keys
- ③ Key number plate

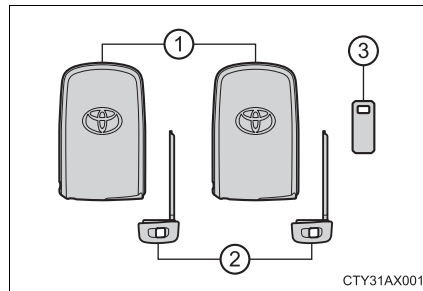

Using the mechanical key

To take out the mechanical key, push the release button and take the key out.

The mechanical key can only be inserted in one direction, as the key only has grooves on one side. If the key cannot be inserted in a lock cylinder, turn it over and re-attempt to insert it.

After using the mechanical key, store it in the electronic key. Carry the mechanical key together with the electronic key. If the electronic key battery is depleted or the entry function does not operate properly, you will need the mechanical key. (→P. 416)

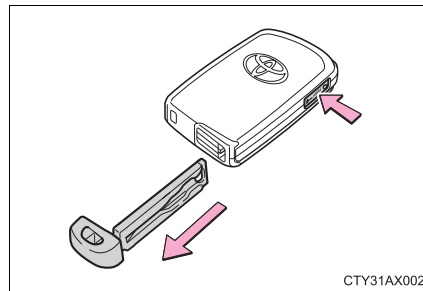

■ When required to leave the vehicle's key with a parking attendant

Turn the trunk opener main switch off, lock the glove box and armrest door as circumstances demand. (→P. 115, 257, 280)

Remove the mechanical key for your own use and provide the attendant with the electronic key only.

■ If you lose your mechanical keys

New genuine mechanical keys can be made by your Toyota dealer using the other mechanical key and the key number stamped on your key number plate. Keep the plate in a safe place such as your wallet, not in the vehicle.

■ When riding in an aircraft

When bringing an electronic key onto an aircraft, make sure you do not press any buttons on the electronic key while inside the aircraft cabin. If you are carrying an electronic key in your bag etc., ensure that the buttons are not likely to be pressed accidentally. Pressing a button may cause the electronic key to emit radio waves that could interfere with the operation of the aircraft.

 NOTICE**■ To prevent key damage**

- Do not drop the keys, subject them to strong shocks or bend them.
- Do not expose the keys to high temperatures for long periods of time.
- Do not get the keys wet or wash them in an ultrasonic washer etc.
- Do not attach metallic or magnetic materials to the keys or place the keys close to such materials.
- Do not disassemble the keys.
- Do not attach a sticker or anything else to the surface of the electronic key.
- Do not place the keys near objects that produce magnetic fields, such as TVs, audio systems and induction cookers, or medical electrical equipment, such as low-frequency therapy equipment.

■ Carrying the electronic key on your person

Carry the electronic key 3.9 in. (10 cm) or more away from electric appliances that are turned on. Radio waves emitted from electric appliances within 3.9 in. (10 cm) of the electronic key may interfere with the key, causing the key to not function properly.

■ In case of a smart key system malfunction or other key-related problems

Take your vehicle with all the electronic keys provided with your vehicle to your Toyota dealer.

■ When an electronic key is lost

If the electronic key remains lost, the risk of vehicle theft increases significantly. Visit your Toyota dealer immediately with all remaining electronic keys that was provided with your vehicle.

Smart key system

Function summary

The following operations can be performed simply by carrying the electronic key on your person, for example in your pocket. (The driver should always carry the electronic key.)

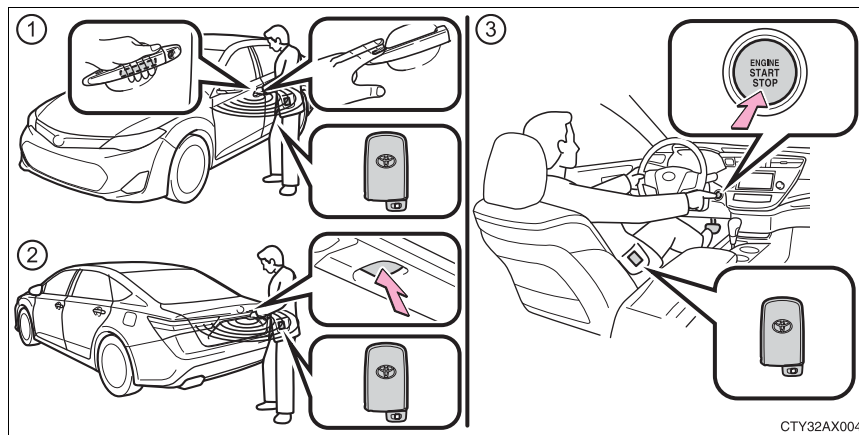

- ① Locks and unlocks the doors (→P. 94)
- ② Unlocks the trunk (→P. 94)
- ③ Starts the engine (→P. 159)

■ Operation signals

A buzzer sounds and the emergency flashers flash to indicate that the doors have been locked/unlocked. (Locked: once; Unlocked: twice)

■ Security feature

If a door is not opened within approximately 60 seconds after the vehicle is unlocked, the security feature automatically locks the vehicle again.

Unlocking and locking the doors

Grip the driver's door handle to unlock the door. Some models, grip the passenger's door handle to unlock all the doors.*

Make sure to touch the sensor on the back of the handle.

The doors cannot be unlocked for 3 seconds after the doors are locked.

*: The door unlock settings can be changed. (→P. 100)

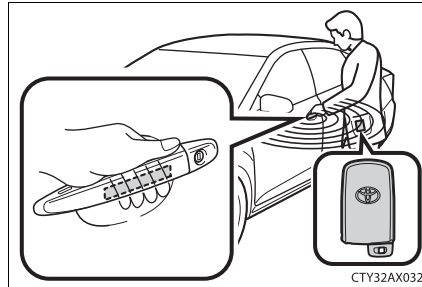

Touch the lock sensor (the indentation on the upper part of the door handle) to lock all the doors.

Check that the door is securely locked.

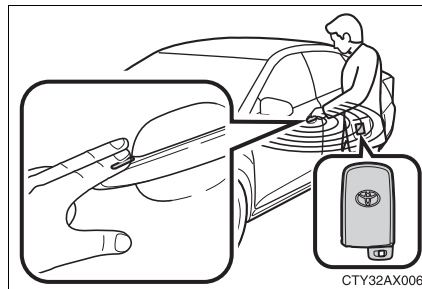

Unlocking the trunk

Press the button to unlock the trunk.

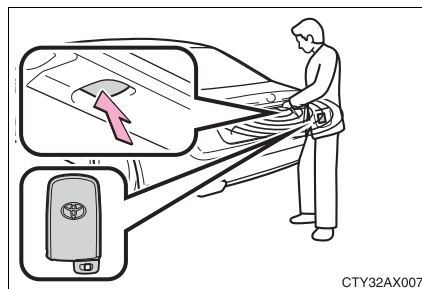

Antenna location and effective range**■ Antenna location**

- ① Right side antenna outside the cabin (if equipped)
- ② Antennas inside the cabin
- ③ Antenna outside the trunk
- ④ Antenna inside the trunk
- ⑤ Left side antenna outside the cabin

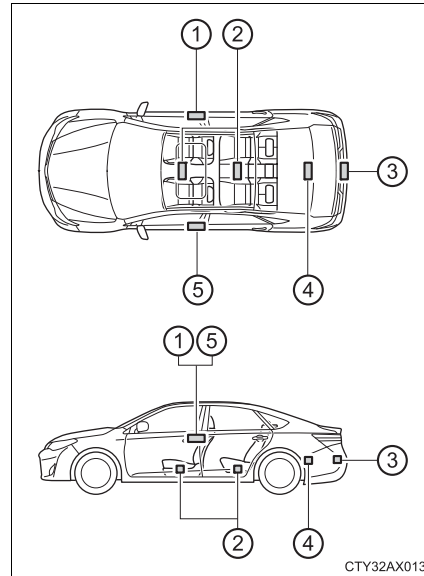

3

Operation of each component

■ **Effective range (areas within which the electronic key is detected)**

▶ Type A

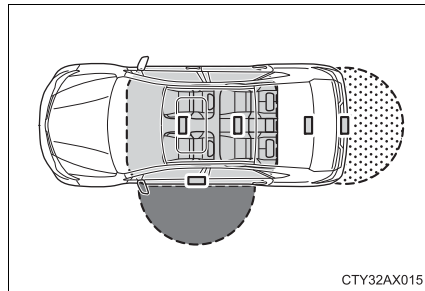

▶ Type B

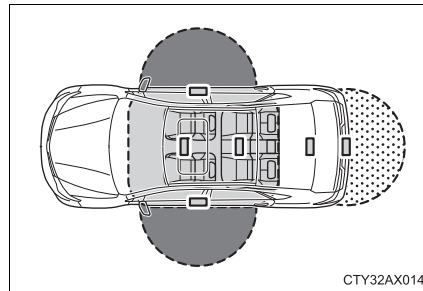

● When locking or unlocking the doors

The system can be operated when the electronic key is within about 2.3 ft. (0.7 m) of an outside door handle. (Only the doors detecting the key can be operated.)

● When unlocking the trunk

The system can be operated when the electronic key is within about 2.3 ft. (0.7 m) of the trunk release button.

● When starting the engine or changing engine switch modes

The system can be operated when the electronic key is inside the vehicle.

■ **When the door cannot be locked by the lock sensor on the upper part of the door handle**

If the door will not lock even when the topside sensor area is touched, try touching both the topside and underside sensor areas at the same time.

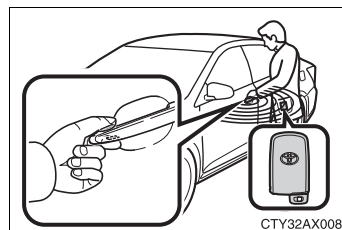

■ Alarms and warning indicators

An alarm sounds and warning message displays shown on the multi-information display are used to protect against unexpected accidents or theft of the vehicle resulting from erroneous operation. When a warning message is displayed, take appropriate measures based on the displayed message.

The following table describes circumstances and correction procedures when only alarms are sounded.

Alarm	Situation	Correction procedure
Exterior alarm sounds once for 5 seconds	An attempt was made to lock the doors using the smart key system while the electronic key was still inside the vehicle.	Retrieve the electronic key from the passenger compartment and lock the doors again.
	The trunk was closed while the electronic key was still inside the trunk and all the doors were locked.	Retrieve the electronic key from the trunk and close the trunk lid.
	An attempt was made to lock the vehicle while a door was open.	Close all of the doors and lock the doors again.
Interior alarm pings once and exterior alarm sounds once for 5 seconds	An attempt was made to lock either front door by opening a door and putting the inside lock button into the lock position, then closing the door with the electronic key still inside the vehicle.	Retrieve the electronic key from the vehicle and lock the doors again.

Alarm	Situation	Correction procedure
Interior alarm sounds continuously	The engine switch was turned to ACCESSORY mode while the driver's door was open (The driver's door was opened when the engine switch was in ACCESSORY mode.)	Turn the engine switch off and close the driver's door.
	The driver's door was opened while any shift position other than P was selected without turning off the engine switch.	Shift the shift lever to P.





The following table describes circumstances and correction procedures when alarms are sounded and a message or key icon is displayed.

Interior buzzer	Exterior buzzer	Situation	Correction procedure
Continuous	Continuous	The electronic key was carried outside the vehicle and the driver's door was opened and closed while any shift position other than P was selected without turning off the engine switch.	<ul style="list-style-type: none"> • Change the shift position to P. • Bring the electronic key back into the vehicle.
Once	3 times	The electronic key was carried outside the vehicle and the driver's door was opened and closed while the shift position P was selected without turning off the engine switch.	Turn the engine switch off or bring the electronic key back into the vehicle.
Once	3 times	Indicates that a door other than the driver's door has been opened and closed with the engine switch in any mode other than off and the electronic key outside of the detection area.	Confirm the location of the electronic key.



Interior buzzer	Exterior buzzer	Situation	Correction procedure
Once	Continuous (5 seconds)	An attempt was made to exit the vehicle with the electronic key and lock the doors without first turning the engine switch off.	Turn the engine switch off and lock the doors again.
Once	—	Indicates that the electronic key is not present when attempting to start the engine.	Confirm the location of the electronic key.
9 times	—	An attempt was made to drive when the regular key was not inside the vehicle.	Confirm that the electronic key is inside the vehicle.
Once	—	Indicates that the electronic key battery is low.	Replace the battery. (→P. 350)
Once	—	Indicates that the steering lock has not been released.	Release the steering lock. (→P. 163)
Once	—	<ul style="list-style-type: none"> When the doors were unlocked with the mechanical key and then the engine switch was pressed, the electronic key could not be detected in the vehicle. The electronic key could not be detected in the vehicle even after the engine switch was pressed two consecutive times. 	Touch the electronic key to the engine switch while depressing the brake pedal.

■ **Switching the door unlock function (some models)**

It is possible to set which doors the entry function unlocks using the wireless remote control.

- 1 Turn the engine switch off.
- 2 When the indicator light on the key surface is not on, press and hold  ,  or  for approximately 5 seconds while pressing and holding  .

The setting changes each time an operation is performed, as shown below. (When changing the setting continuously, release the buttons, wait for at least 5 seconds, and repeat step 2.)

Multi-information display	Unlocking function	Beep
	Holding the driver's door handle unlocks only the driver's door.	Exterior: Beeps 3 times Interior: Pings once
	Holding a passenger's door handle unlocks all the doors.	
	Holding either front door handle unlocks all the doors.	Exterior: Beeps twice Interior: Pings once

To prevent unintended triggering of the alarm, unlock the doors using the wireless remote control and open and close a door once after the settings have been changed. (If a door is not opened within 60 seconds after  is pressed, the doors will be locked again and the alarm will automatically be set.)

In case that the alarm is triggered, immediately stop the alarm. (→P. 68)



■ Battery-saving function

The battery-saving function will be activated in order to prevent the electronic key battery and the vehicle battery from being discharged while the vehicle is not in operation for a long time.

- In the following situations, the smart key system may take some time to unlock the doors.
 - The electronic key has been left in an area of approximately 6 ft. (2 m) of the outside of the vehicle for 10 minutes or longer.
 - The smart key system has not been used for 5 days or longer.
- If the smart key system has not been used for 14 days or longer, the doors cannot be unlocked at any doors except the driver's door. In this case, take hold of the driver's door handle, or use the wireless remote control or the mechanical key, to unlock the doors.

■ Electronic Key Battery-Saving Function

When battery-saving mode is set, battery depletion is minimized by stopping the electronic key from receiving radio waves.

Press  twice while pressing and holding . Confirm that the electronic key indicator flashes 4 times.

While the battery-saving mode is set, the smart key system cannot be used. To cancel the function, press any of the electronic key buttons.

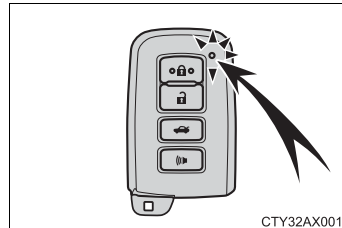

■ Conditions affecting operation

The smart key system uses weak radio waves. In the following situations, the communication between the electronic key and the vehicle may be affected, preventing the smart key system, wireless remote control and engine immobilizer system from operating properly. (Ways of coping: →P. 416)

- When the electronic key battery is depleted
- Near a TV tower, electric power plant, gas station, radio station, large display, airport or other facility that generates strong radio waves or electrical noise
- When carrying a portable radio, cellular phone, cordless phone or other wireless communication device
- When the electronic key is in contact with, or is covered by the following metallic objects
 - Cards to which aluminum foil is attached
 - Cigarette boxes that have aluminum foil inside
 - Metallic wallets or bags
 - Coins
 - Hand warmers made of metal
 - Media such as CDs and DVDs
- When other wireless keys (that emit radio waves) are being used nearby
- When carrying the electronic key together with the following devices that emit radio waves
 - Another vehicle's electronic key or a wireless key that emits radio waves
 - Personal computers or personal digital assistants (PDAs)
 - Digital audio players
 - Portable game systems
- If window tint with a metallic content or metallic objects are attached to the rear window

■ Note for the entry function

- Even when the electronic key is within the effective range (detection areas), the system may not operate properly in the following cases:
 - The electronic key is too close to the window or outside door handle, near the ground, or in a high place when the doors are locked or unlocked.
 - The electronic key is near the ground or in a high place, or too close to the rear bumper center when the trunk is opened.
 - The electronic key is on the instrument panel, rear package tray or floor, or in the door pockets or glove box when the engine is started or engine switch modes are changed.
- Do not leave the electronic key on top of the instrument panel or near the door pockets when exiting the vehicle. Depending on the radio wave reception conditions, it may be detected by the antenna outside the cabin and the door will become lockable from the outside, possibly trapping the electronic key inside the vehicle.
- As long as the electronic key is within the effective range, the doors may be locked or unlocked by anyone. However, only the doors detecting the electronic key can be used to unlock the vehicle.
- Even if the electronic key is not inside the vehicle, it may be possible to start the engine if the electronic key is near the window.
- The doors may unlock or lock if a large amount of water splashes on the door handle, such as in the rain or in a car wash when the electronic key is within the effective range. (The doors will automatically be locked after approximately 60 seconds if the doors are not opened and closed.)
- If the wireless remote control is used to lock the doors when the electronic key is near the vehicle, there is a possibility that the door may not be unlocked by the entry function. (Use the wireless remote control to unlock the doors.)

■ Note for locking the doors

- Touching the door lock sensor while wearing gloves may delay or prevent lock operation. Remove the gloves and touch the lock sensor again.
- If the door handle becomes wet while the electronic key is within the effective range, the door may lock and unlock repeatedly. In that case, follow the following correction procedures to wash the vehicle:
 - Place the electronic key in a location 6 ft. (2 m) or more away from the vehicle. (Take care to ensure that the key is not stolen.)
 - Set the electronic key to battery-saving mode to disable the smart key system. (→P. 101)
- If the electronic key is inside the vehicle and a door handle becomes wet during a car wash, a message may be shown on the multi-information display and a buzzer will sound outside the vehicle. To turn off the alarm, lock all the doors.
- The lock sensor may not work properly if it comes into contact with ice, snow, mud, etc. Clean the lock sensor and attempt to operate it again, or use the lock sensor on the lower part of the door handle.
- Fingernails may scrape against the door during operation of the door handle. Be careful not to injure fingernails or damage the surface of the door.

■ Note for the unlocking function

- A sudden approach to the effective range or door handle may prevent the doors from being unlocked. In this case, return the door handle to the original position and check that the doors unlock before pulling the door handle again.
- Gripping the door handle when wearing a glove may not unlock the door.
- If the door handle becomes wet while the electronic key is within the effective range, the door may lock and unlock repeatedly. In that case, follow the following correction procedures to wash the vehicle:
 - Place the electronic key in a location 6 ft. (2 m) or more away from the vehicle. (Take care to ensure that the key is not stolen.)
 - Set the electronic key to battery-saving mode to disable the smart key system. (→P. 101)
- If there is another electronic key in the detection area, it may take slightly longer to unlock the doors after the door handle is gripped.
- Fingernails may scrape against the door during operation of the door handle. Be careful not to injure fingernails or damage the surface of the door.

■ When the vehicle is not driven for extended periods

- To prevent theft of the vehicle, do not leave the electronic key within 6 ft. (2 m) of the vehicle.
- The smart key system can be deactivated in advance. (→P. 455)

■ Alarm

Using the smart key system to lock the doors will set the alarm system. (→P. 68)

■ To operate the system properly

- Make sure to carry the electronic key when operating the system. Do not get the electronic key too close to the vehicle when operating the system from the outside of the vehicle.

Depending on the position and holding condition of the electronic key, the key may not be detected correctly and the system may not operate properly. (The alarm may go off accidentally, or the door lock prevention function may not operate.)

- Do not leave the electronic key inside the luggage compartment. The key confinement prevention function may not operate, depending on the location of the key (close to a spare tire, the inside edge of the luggage compartment), conditions (inside a metal bag, close to metallic objects) and the radio waves in the surrounding area. (→P. 115)

■ If the smart key system does not operate properly

- Locking and unlocking the doors: Use the mechanical key. (→P. 416)
- Unlocking the trunk: →P. 116
- Starting the engine: →P. 417

■ **Electronic key battery depletion**

- The standard battery life is 1 to 2 years.
- If the battery becomes low, an alarm will sound in the cabin when the engine stops. (→P. 97)
- As the electronic key always receives radio waves, the battery will become depleted even if the electronic key is not used. The following symptoms indicate that the electronic key battery may be depleted. Replace the battery when necessary. (→P. 350)
 - The smart key system or the wireless remote control does not operate.
 - The detection area becomes smaller.
 - The LED indicator on the key surface does not turn on.
- To avoid serious deterioration, do not leave the electronic key within 3 ft. (1 m) of the following electrical appliances that produce a magnetic field:
 - TVs
 - Personal computers
 - Cellular phones, cordless phones and battery chargers
 - Recharging cellular phones or cordless phones
 - Table lamps
 - Induction cookers

■ **When the electronic key battery is fully depleted**

→P. 350

■ **Customization**

Settings (e. g. operation signal) can be changed.
(Customizable features: →P. 455)

■ **If the smart key system has been deactivated in a customized setting**

- Locking and unlocking the doors: →P. 108, 416
- Unlocking the trunk: →P. 108, 116
- Starting the engine and changing engine switch modes: →P. 417
- Stopping the engine: →P. 160

■ Certification for the smart key system

- ▶ For vehicles sold in the U.S.A.

FCC ID: NI4TMLF10-50

FCC ID: NI4TMLF10-51

NOTE:

This device complies with part 15 of the FCC Rules. Operation is subject to the following two conditions: (1) This device may not cause harmful interference, and (2) this device must accept any interference received, including interference that may cause undesired operation.

FCC WARNING:

Changes or modifications not expressly approved by the party responsible for compliance could void the user's authority to operate the equipment.

- ▶ For vehicles sold in Canada

NOTE:

Operation is subject to the following two conditions: (1) this device may not cause interference, and (2) this device must accept any interference, including interference that may cause undesired operation of the device.

CAUTION

■ Caution regarding interference with electronic devices

- People with implantable cardiac pacemakers, cardiac resynchronization therapy-pacemakers or implantable cardioverter defibrillators should keep away from the smart key system antennas.

(→P. 95)

The radio waves may affect the operation of such devices. If necessary, the entry function can be disabled. Ask your Toyota dealer for details, such as the frequency of radio waves and timing of the emitted radio waves. Then, consult your doctor to see if you should disable the entry function.

- Users of any electrical medical device other than implantable cardiac pacemakers, cardiac resynchronization therapy-pacemakers or implantable cardioverter defibrillators should consult the manufacturer of the device for information about its operation under the influence of radio waves.

Radio waves could have unexpected effects on the operation of such medical devices.

Ask your Toyota dealer for details on disabling the entry function.

Wireless remote control

Function summary

The wireless remote control can be used to lock and unlock the vehicle.

- ① Locks all the doors
Check that the door is securely locked.
- ② Unlocks all the doors
Pressing the button unlocks the driver's door. Pressing the button again within 5 seconds unlocks the other doors.
- ③ Unlocks the trunk
(press and hold)
- ④ Sounds the alarm
(press and hold) (→P. 109)

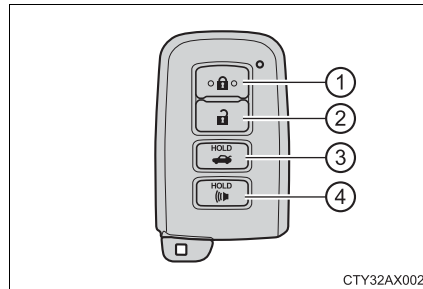

■ Operation signals

Doors:

A buzzer sounds and the emergency flashers flash to indicate that the doors have been locked/unlocked. (Locked: once; Unlocked: twice)

Trunk:

A buzzer sounds to indicate that the trunk has been opened.

■ Door lock buzzer

If an attempt to lock the doors is made when a door is not fully closed, a buzzer sounds continuously for 5 seconds. Fully close the door to stop the buzzer, and lock the vehicle once more.

■ Panic mode

When  is pressed for longer than about one second, an alarm will sound intermittently and the vehicle lights will flash to deter any person from trying to break into or damage your vehicle.

To stop the alarm, press any button on the electronic key.

**■ Security feature**

→P. 93

■ Alarm

Using the wireless remote control to lock the doors will set the alarm system. (→P. 68)

■ Conditions affecting operation

→P. 102

■ **If the wireless remote control does not operate properly**

- Locking and unlocking the doors: Use the mechanical key. (→P. 416)
- Unlocking the trunk: →P. 116

■ **Electronic key battery depletion**

→P. 106

■ **When the electronic key battery is fully depleted**

→P. 350

■ **Confirmation of the registered key number**

The number of keys already registered to the vehicle can be confirmed. Ask your Toyota dealer for details.

■ **Customization**

Settings (e.g. wireless remote control system) can be changed.
(Customizable features: →P. 455)

■ **Certification for wireless remote control**

- ▶ For vehicles sold in the U.S.A.

FCC ID: HYQ23AAB

FCC ID: HYQ14FBA

NOTE:

This device complies with part 15 of the FCC Rules. Operation is subject to the following two conditions: (1) This device may not cause harmful interference, and (2) this device must accept any interference received, including interference that may cause undesired operation.

FCC WARNING:

Changes or modifications not expressly approved by the party responsible for compliance could void the user's authority to operate the equipment.

- ▶ For vehicles sold in Canada

NOTE:

Operation is subject to the following two conditions: (1) this device may not cause interference, and (2) this device must accept any interference, including interference that may cause undesired operation of the device.

Doors

Unlocking and locking the doors

The vehicle can be locked and unlocked using the entry function, wireless remote control or door lock switches.

◆ Entry function

→P. 93

◆ Wireless remote control

→P. 108

◆ Door lock switches

- ① Locks all the doors
- ② Unlocks all the doors

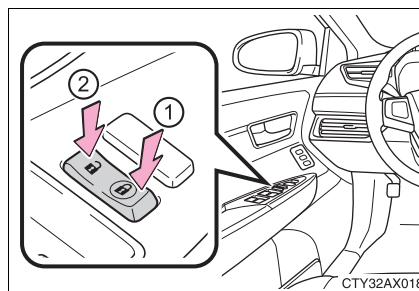

◆ Inside lock buttons

- ① Unlocks the door
- ② Locks the door

The front doors can be opened by pulling the inside handle even if the lock buttons are in the lock position.

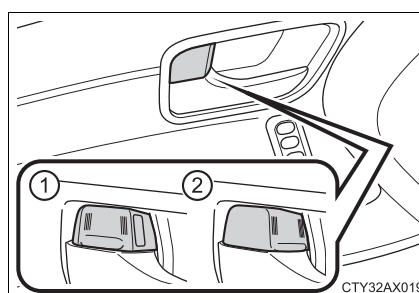

3

Operation of each component

Locking the front doors from the outside without a key

- 1 Move the inside lock button to the lock position.
- 2 Close the door.

The door cannot be locked if the engine switch is in ACCESSORY or IGNITION ON mode, or the electronic key is left inside the vehicle.

The key may not be detected correctly and the door may be locked.

Rear door child-protector lock

The door cannot be opened from inside the vehicle when the lock is set.

- 1 Unlock
- 2 Lock

These locks can be set to prevent children from opening the rear doors. Push down on each rear door switch to lock both rear doors.

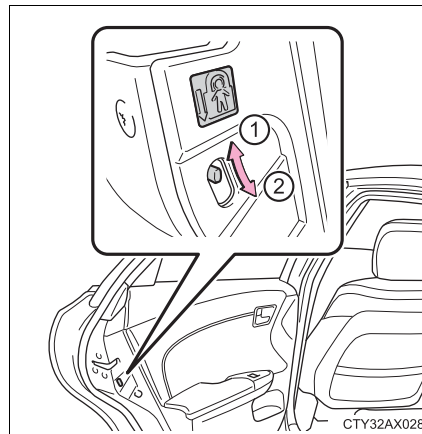

Automatic door locking and unlocking systems

The following functions can be set or canceled:

For instructions on customizing, refer to P. 455.

Function	Operation
Speed linked door locking function	All doors are automatically locked when vehicle speed is approximately 12 mph (20 km/h) or higher.
Shift position linked door locking function	All doors are automatically locked when shifting the shift lever to position other than P.
Shift position linked door unlocking function	All doors are automatically unlocked when shifting the shift lever to P.
Driver's door linked door unlocking function	All doors are automatically unlocked when driver's door is opened.

■ Using the mechanical key

The doors can also be locked and unlocked with the mechanical key.
(→P. 416)

■ If a wrong key is used

The key cylinder rotates freely to isolate inside mechanism.

■ Customization

Settings (e.g. unlocking function using a key) can be changed.
(Customizable features: →P. 455)

CAUTION

■ To prevent an accident

Observe the following precautions while driving the vehicle.
Failure to do so may result in a door opening and an occupant throwing out of the vehicle, resulting in death or serious injury.

- Ensure that all doors are properly closed and locked.
- Do not pull the inside handle of the doors while driving.
Be especially careful for the front doors, as the doors may be opened even if the inside lock buttons are in locked position.
- Set the rear door child-protector locks when children are seated in the rear seats.

Trunk

The trunk can be opened using the trunk opener, entry function or wireless remote control.

Opening the trunk from inside the vehicle

Press the opener switch.

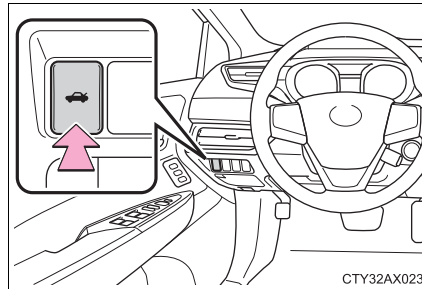

Opening the trunk from outside the vehicle

- **Entry function**
→P. 93
- **Wireless remote control**
→P. 108

When closing the trunk

Using the trunk grip, lower the trunk without applying force to the side and push the trunk down from the outside to close it.

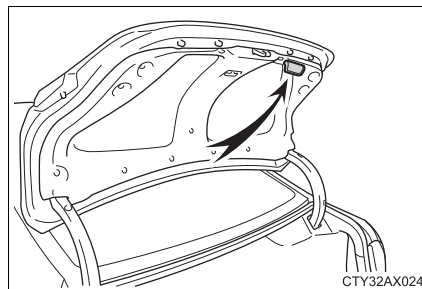

Luggage security system

The trunk opener switch can be temporarily disabled to protect luggage stored in the trunk against theft.

Turn the main switch in the glove box off to disable the trunk opener.

① On

② Off

The trunk lid cannot be opened even with the wireless remote control or the entry function.

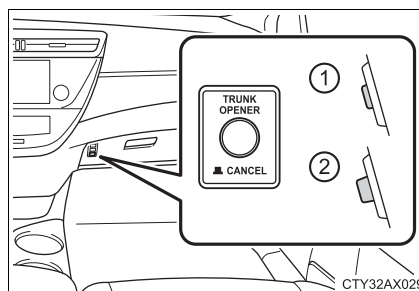

Trunk light

The trunk light turns on when the trunk is opened.

Function to prevent the trunk being locked with the electronic key inside

- When all doors are being locked, closing the trunk lid with the electronic key left inside the trunk will sound an alarm. In this case, the trunk lid can be opened pressing the trunk release button on the trunk lid.
- Even when the spare electronic key is put in the trunk with all the doors locked, the key confinement prevention function can be activated so the trunk can be opened. In order to prevent theft, take all electronic keys with you when leaving the vehicle.
- Even when the electronic key is put in the trunk with all the doors are locked, the key may not be detected depending on the places and the surrounding radio wave conditions. In this case, the key confinement prevention function cannot be activated, causing the doors to lock when the trunk is closed. Make sure to check where the key is before closing the trunk.
- The key confinement prevention function cannot be activated if any one of the doors is unlocked. In this case, open the trunk using the trunk opener.

Internal trunk release lever

The trunk lid can be opened by pulling the glow-in-the-dark lever located on the inside of the trunk lid.

The lever will continue to glow for some time after the trunk lid is closed.

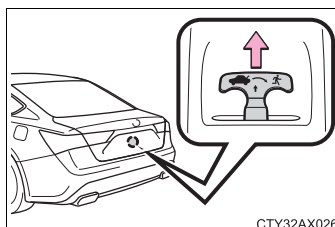

■ **In case the trunk opener is not actuated**

- 1 Pull down the rear armrest and open the door behind it.

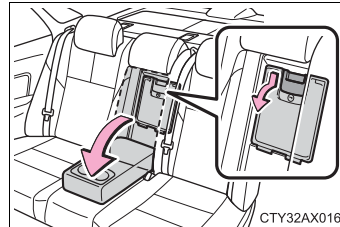

- 2 Pull the loop of wire to unlock the trunk lid.

This is used in case the trunk lid cannot be unlocked due to a discharged battery or other trouble.

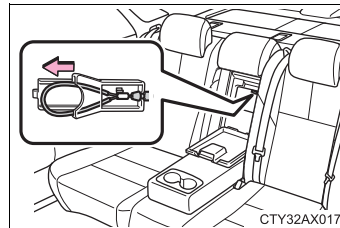

■ **When leaving a key to the vehicle with a parking attendant**

→P. 91

■ **Customization**

The trunk opener main switch can be deactivated.
(Customizable feature: →P. 455)

⚠ CAUTION

Observe the following precautions.
Failure to do so may result in death or serious injury.

■ **Before driving**

- Make sure that the trunk lid is fully closed. If the trunk lid is not fully closed, it may open unexpectedly while driving and hit near-by objects or luggage in the trunk may be thrown out, causing an accident.
- Do not allow children to play in the trunk.
If a child is accidentally locked in the trunk, they could suffer from heat exhaustion, suffocation or other injuries.
- Do not allow a child to open or close the trunk lid.
Doing so may cause the trunk lid to open unexpectedly, or cause the child's hands, head, or neck to be caught by the closing trunk lid.

■ **Important points while driving**

Never let anyone sit in the trunk. In the event of sudden braking or a collision, they are susceptible to death or serious injury.

⚠ CAUTION

■ Using the trunk

Observe the following precautions.

Failure to do so may cause parts of the body to be caught, resulting in serious injury.

- Remove any heavy loads, such as snow and ice, from the trunk lid before opening it. Failure to do so may cause the trunk lid to suddenly shut again after it is opened.
- When opening or closing the trunk lid, thoroughly check to make sure the surrounding area is safe.
- If anyone is in the vicinity, make sure they are safe and let them know that the trunk is about to open or close.
- Use caution when opening or closing the trunk lid in windy weather as it may move abruptly in strong wind.

- The trunk lid may suddenly shut if it is not opened fully. It is more difficult to open or close the trunk lid on an incline than on a level surface, so beware of the trunk lid unexpectedly opening or closing by itself. Make sure that the trunk lid is fully open and secure before using the trunk.

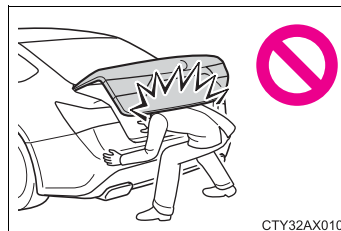

- When closing the trunk lid, take extra care to prevent your fingers etc. from being caught.
- When closing the trunk lid, make sure to press it lightly on its outer surface. If the trunk handle is used to fully close the trunk lid, it may result in hands or arms being caught.

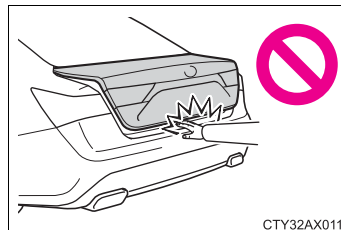

- Do not attach any accessories other than genuine Toyota parts to the trunk lid. Such additional weight on the trunk lid may cause the lid to suddenly shut again after it is opened.

Front seats

Adjustment procedure

▶ Driver's seat

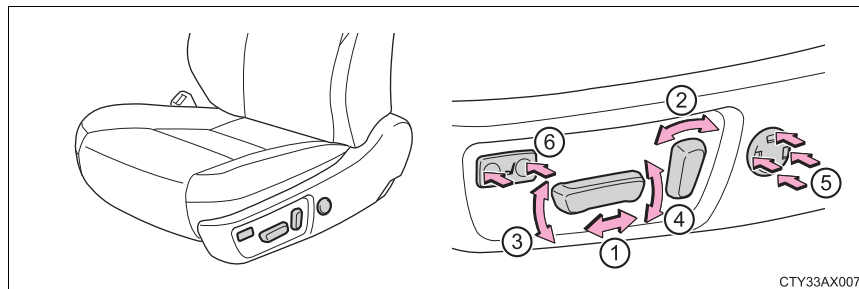

▶ Passenger's seat

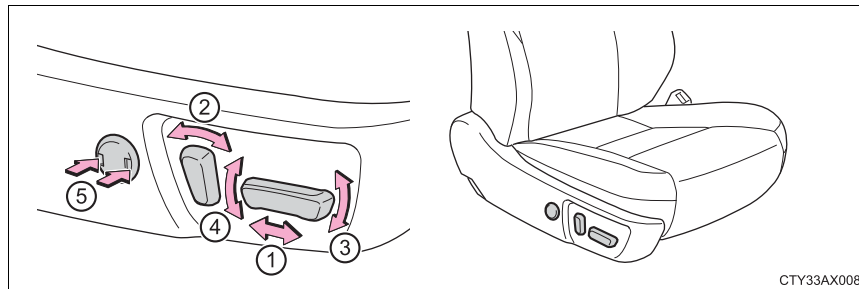

- ① Seat position adjustment switch
- ② Seatback angle adjustment switch
- ③ Seat cushion (front) angle adjustment switch (if equipped for passenger's seat)
- ④ Vertical height adjustment switch (if equipped for passenger's seat)
- ⑤ Lumbar support adjustment switch (if equipped for passenger's seat)
- ⑥ Seat cushion length adjustment switch (if equipped)

■ Power easy access system (vehicles with driving position memory)

The auto away/return function enables easy access by activating when the driver attempts to enter or exit the vehicle.

- When the engine switch has been turned to IGNITION ON mode or the driver's seat belt has been fastened, the driver's seat will move forward.
- When the engine switch has been turned off and the driver's seat belt has been unfastened, the driver's seat will move backward.

■ Customization

Settings (e.g. driver's seat movement when exiting the vehicle) can be changed. (Customizable features: →P. 455)

CAUTION

■ When adjusting the seat position

- Take care when adjusting the seat position to ensure that other passengers are not injured by the moving seat.
- Do not put your hands under the seat or near the moving parts to avoid injury.
Fingers or hands may become jammed in the seat mechanism.

■ Seat adjustment

To reduce the risk of sliding under the lap belt during a collision, do not recline the seat more than necessary.

If the seat is too reclined, the lap belt may slide past the hips and apply restraint forces directly to the abdomen, or your neck may contact the shoulder belt, increasing the risk of death or serious injury in the event of an accident.

Adjustments should not be made while driving as the seat may unexpectedly move and cause the driver to lose control of the vehicle.

■ When adjusting the seat positions

Make sure to leave enough space around the feet so they do not get stuck.

Driving position memory*

This feature automatically adjusts the driver's seat and outside rear view mirrors to make entering and exiting the vehicle easier or to suit your preferences.

Power easy access system

The seat is automatically adjusted to allow the driver to enter and exit the vehicle easily.

When all of the following have been performed, the driver's seat is automatically adjusted to a position that allows driver to enter and exit the vehicle easily.

- The shift lever has been shifted to P.
- The engine switch has been turned off.
- The driver's seat belt has been unfastened.

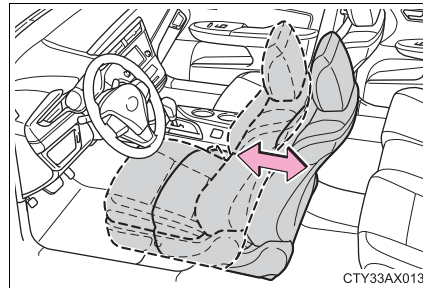

When any of the following is performed, the driver's seat automatically returns to its original position.

- The engine switch has been turned to ACCESSORY or IGNITION ON mode.
- The driver's seat belt has been fastened.

■ Operation of the power easy access system

When exiting the vehicle, the power easy access system may not operate if the seat is already close to the rearmost position, etc.

■ Customization

The seat movement amount settings of the power easy access system can be customized. (Customizable features: →P. 455)

*: If equipped

Driving position memory

Your preferred driving position (the position of the driver's seat and outside rear view mirrors) can be recorded and recalled by pressing a button.

Two different driving positions can be recorded into memory.

■ Recording procedure

- 1 Check that the shift lever is in P.
- 2 Turn the engine switch to IGNITION ON mode.
- 3 Adjust the driver's seat and outside rear view mirrors to the desired positions.
- 4 While pressing the "SET" button, or within 3 seconds after the "SET" button is pressed, press button "1" or "2" until the signal beeps.

If the selected button has already been preset, the previously recorded position will be overwritten.

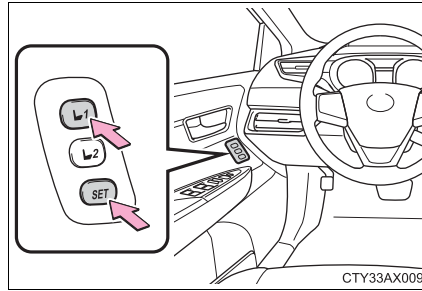

3

Operation of each component

■ Recall procedure

- 1 Check that the shift lever is in P.
- 2 Turn the engine switch to IGNITION ON mode.
- 3 Press button "1" or "2" to recall the desired position.

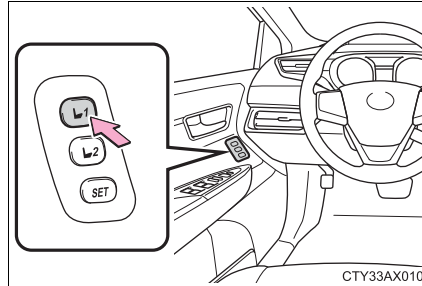
**■ To stop the position recall operation part-way through**

Perform any of the following:

- Press the "SET" button.
- Press button "1" or "2".
- Adjust the seat using the switches (only cancels seat position recall).

■ Seat positions that can be memorized (→P. 118)

The seat position, with the exception of the portions adjusted by the seat cushion length switch and lumbar support switch, can be recorded.

■ Operating the driving position memory after turning the engine switch off

Recorded seat positions can be activated up to 180 seconds after the driver's door is opened and another 60 seconds after it is closed again.

■ In order to correctly use the driving position memory function

If a seat position is already in the furthest possible position and the seat is operated in the same direction, the recorded position may be slightly different when it is recalled.

Memory recall function

Each electronic key can be registered to recall your preferred driving position.

■ Registering procedure

Record your driving position to button 1 or 2 before performing the following:

Carrying only the key to which you want to link the driving position, shift the shift lever to P and then close the driver's door.

If 2 or more keys are in the vehicle, the driving position cannot be linked properly.

- 1 Turn the engine switch to IGNITION ON mode and recall the position which you want to link.
- 2 While pressing the button to recall the position, press the driver's door lock switch (either lock or unlock) until the signal beeps.

The driving position is recalled when the driver's door is unlocked using the entry function or wireless remote control and the driver's door is opened.

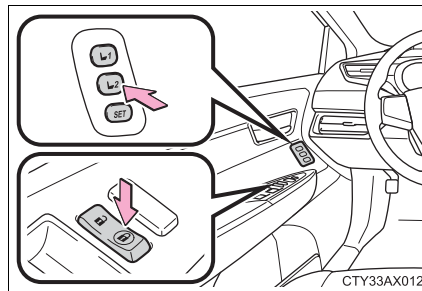

CTY33AX012

3

Operation of each component

■ Recall procedure

- 1 Carry the electronic key that has been registered to the driving position, and then unlock and open the driver's door using the smart key system or wireless remote control.

The driving position will move to the recorded position. However, the seat will move to a position slightly behind the recorded position in order to make entering the vehicle easier.

If the driving position is in a position that has already been recorded, the seat and outside rear view mirrors will not move.

- 2 Turn the engine switch to ACCESSORY or IGNITION ON mode, or fasten a seat belt.

The seat will move to the recorded position.

■ Cancellation procedure

Carry only the key to which you want to cancel the linked door unlock operation.

If 2 or more keys are in the vehicle, the driving position cannot be canceled properly.

- 1 Turn the engine switch to IGNITION ON mode.
- 2 While pressing the "SET" button, press the driver's door lock switch (either lock or unlock) until the signal beeps.

■ Recalling the driving position using the memory recall function

- Different driving positions can be registered for each electronic key. Therefore, the driving position that is recalled may be different depending on the key being carried.
- If a door other than the driver's door is unlocked with the smart key system, the driving position cannot be recalled. In this case, press the driving position button which has been set.

■ Customization

The unlock door settings of the memory recall function can be customized. (Customizable features: →P. 455)

⚠ CAUTION**■ Seat adjustment caution**

Take care during seat adjustment so that the seat does not strike the rear passenger or squeeze your body against the steering wheel.

Head restraints

Head restraints are provided for all seats.

Front seats

Vertical adjustment

- ① Up
Pull the head restraints up.
- ② Down
Push the head restraint down while pressing the lock release button.

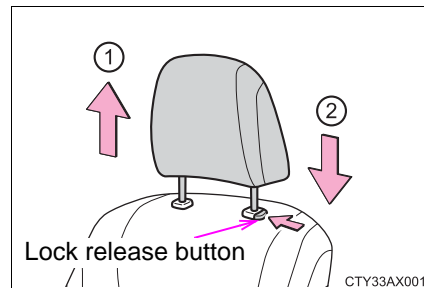

Rear seats (except center seat)

- ① Up
Pull the head restraints up.
- ② Down
Push the head restraint down while pressing the lock release button.

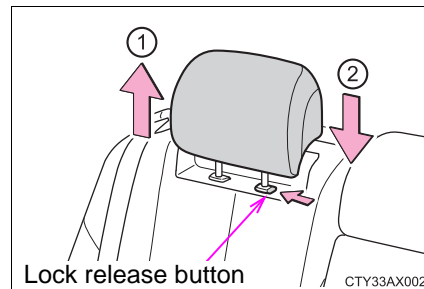

Removing the head restraints (except rear center seat)

Pull the head restraint up while pressing the lock release button.

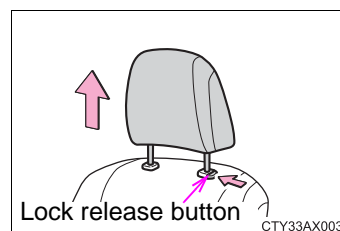

3

Operation of each component

■ **Installing the head restraints**

▶ Front seats

Align the head restraint with the installation holes and push it down to the lock position.

Press and hold the lock release button when lowering the head restraint.

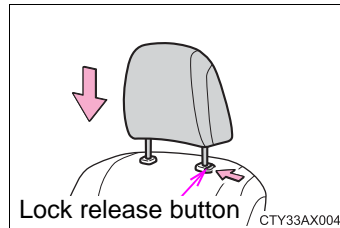

▶ Rear seats (except center seat)

Align the head restraint with the installation holes and push it down to the lowest lock position while pressing the lock release button.

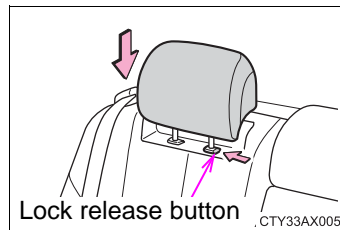

■ **Adjusting the height of the head restraints (except rear center seat)**

Make sure that the head restraints are adjusted so that the center of the head restraint is closest to the top of your ears.

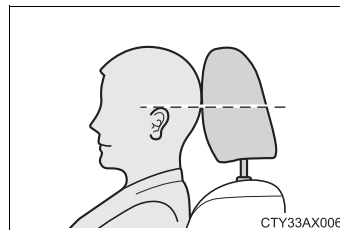

■ **Adjusting the rear seat head restraint (except center seat)**

Always raise the head restraint one level from the stowed position when using.

 CAUTION**■ Head restraint precautions**

Observe the following precautions regarding the head restraints. Failure to do so may result in death or serious injury.

- Use the head restraints designed for each respective seat.
- Adjust the head restraints to the correct position at all times.
- After adjusting the head restraints, push down on them and make sure they are locked in position.
- Do not drive with the head restraints removed.

Steering wheel

The steering wheel can be adjusted to a comfortable position.

Adjustment procedure

- 1 Hold the steering wheel and push the lever down.

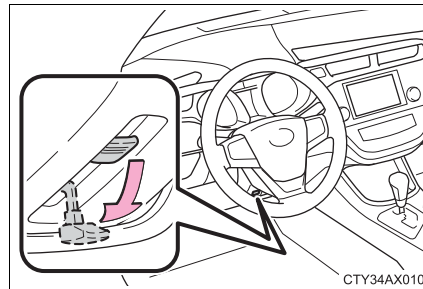

- 2 Adjust to the ideal position by moving the steering wheel horizontally and vertically.
After adjustment, pull the lever up to secure the steering wheel.

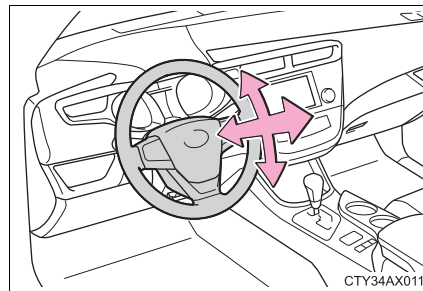

⚠ CAUTION

■ Caution while driving

Do not adjust the steering wheel while driving.
Doing so may cause the driver to mishandle the vehicle and cause an accident, resulting in death or serious injury.

■ After adjusting the steering wheel

Make sure that the steering wheel is securely locked.
Otherwise, the steering wheel may move suddenly, possibly causing an accident, and resulting in death or serious injury.

Inside rear view mirror

The rear view mirror's position can be adjusted to enable sufficient confirmation of the rear view.

Adjusting the height of rear view mirror

The height of the rear view mirror can be adjusted to suit your driving posture.

Adjust the height of the rear view mirror by moving it up and down.

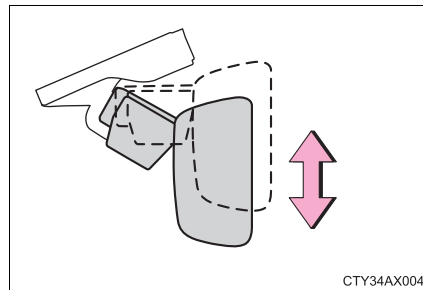

Anti-glare function

► Manual anti-glare inside rear view mirror

- ① Normal position
- ② Anti-glare position

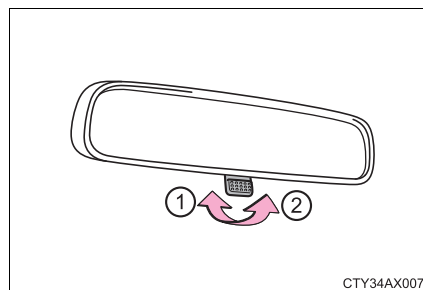

3

Operation of each component

▶ Auto anti-glare inside rear view mirror

Responding to the level of brightness of the headlights of vehicles behind, the reflected light is automatically reduced.

Changing automatic anti-glare function mode
ON/OFF

When the automatic anti-glare function is in on mode, the indicator illuminates.

The function will set to on mode each time the engine switch is turned to IGNITION ON mode.

Pressing the button turns the function to off mode. (The indicator also turns off.)

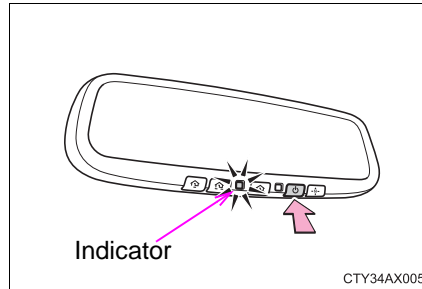

■ To prevent sensor error (auto anti-glare type)

To ensure that the sensors operate properly, do not touch or cover them.

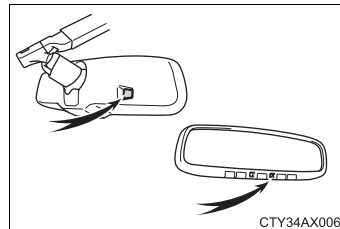

⚠ CAUTION

Do not adjust the position of the mirror while driving.
Doing so may lead to mishandling of the vehicle and cause an accident, resulting in death or serious injury.

Outside rear view mirrors

Adjustment procedure

- 1 To select a mirror to adjust, press the switch.

- ① Left
- ② Right

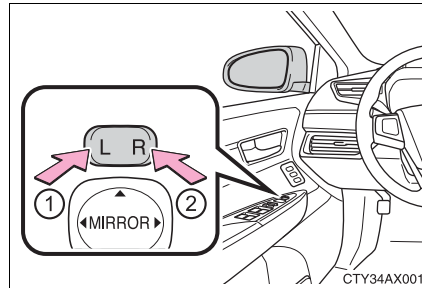

- 2 To adjust the mirror, press the switch.

- ① Up
- ② Right
- ③ Down
- ④ Left

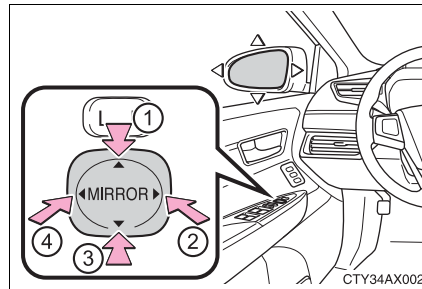

Folding the mirrors

Push the mirror back in the direction of the vehicle's rear.

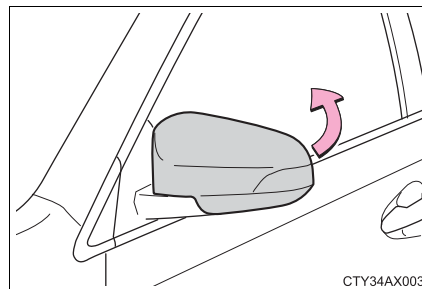

3

Operation of each component

Linked mirror function when reversing (vehicles with driving position memory)

When the mirror select switch is in the L or R position, the outside rear view mirrors will automatically angle downwards when the vehicle is reversing in order to give a better view of the ground.

To disable this function, move the mirror select switch to the neutral position (between L and R).

■ Adjusting the mirror angle when the vehicle is reversing

With the shift lever in R, adjust the mirror angle at a desired position. The adjusted angle will be memorized and the mirror will automatically tilt to the memorized angle whenever the shift lever is shifted to R from next time.

The memorized downward tilt position of the mirror is linked to the normal position (angle adjusted with the shift lever in other than R). Therefore, if the normal position is changed after adjustment, the tilt position will also change.

When the normal position is changed, readjust the angle in reversing.

■ Mirror angle can be adjusted when

The engine switch is in ACCESSORY or IGNITION ON mode.

■ When the mirrors are fogged up

The outside rear view mirrors can be cleared using the mirror defoggers. Turn on the rear window defogger to turn on the outside rear view mirror defoggers. (→P. 252)

■ Automatic adjustment of the mirror angle (vehicles with driving position memory)

A desired mirror face angle can be entered to memory and recalled automatically by the driving position memory. (→P. 120)

■ Auto anti-glare function (vehicles with outer foot lights)

When the anti-glare inside rear view mirror is set to automatic mode, the outside rear view mirrors will activate in conjunction with the anti-glare inside rear view mirror to reduce reflected light. (→P. 129)

 CAUTION**■ Important points while driving**

Observe the following precautions while driving.

Failure to do so may result in loss of control of the vehicle and cause an accident, resulting in death or serious injury.

- Do not adjust the mirrors while driving.
- Do not drive with the mirrors folded.
- Both the driver and passenger side mirrors must be extended and properly adjusted before driving.

■ When a mirror is moving

To avoid personal injury and mirror malfunction, be careful not to get your hand caught by the moving mirror.

■ When the mirror defoggers are operating

Do not touch the rear view mirror surfaces, as they can become very hot and burn you.

Power windows

Opening and closing procedures

The power windows can be opened and closed using the switches.

Operating the switch moves the windows as follows:

- ① Closing
- ② One-touch closing*
- ③ Opening
- ④ One-touch opening*

*: To stop the window partway, operate the switch in the opposite direction.

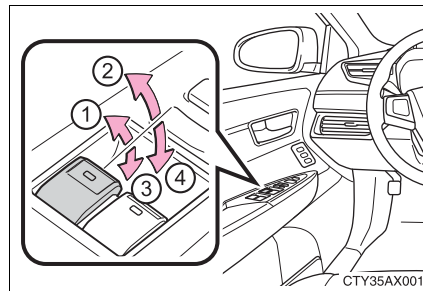

Window lock switch

Press the switch to lock the passenger window switches.

Use this switch to prevent children from accidentally opening or closing a passenger window.

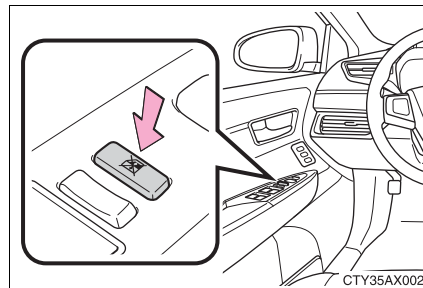

■ The power windows can be operated when

The engine switch is in IGNITION ON mode.

■ Operating the power windows after turning the engine off

The power windows can be operated for approximately 45 seconds even after the engine switch is turned to ACCESSORY mode or turned off. They cannot, however, be operated once either front door is opened.

■ Jam protection function

If an object becomes caught between the window and the window frame, window travel is stopped and the window is opened slightly.

■ When the power window does not close normally

If the jam protection function is operating abnormally and a window cannot be closed, perform the following operations using the power window switch on the relevant door.

- After stopping the vehicle, the window can be closed by holding the power window switch in the one-touch closing position while the engine switch is turned to IGNITION ON mode.
- If the window still cannot be closed even by carrying out the operation as explained above, initialize the function by performing the following procedure.
 - 1 Hold the power window switch in the one-touch closing position. Continue holding the switch for a further 6 seconds after the window has closed.
 - 2 Hold the power window switch in the one-touch opening position. Continue holding the switch for a further 2 seconds after the window has opened completely.
 - 3 Hold the power window switch in the one-touch closing position once again. Continue holding the switch for a further 2 seconds after the window has closed.

If you release the switch while the window is moving, start again from the beginning.

If the window continues to close but then re-open slightly even after performing the above procedure correctly, have the vehicle inspected by your Toyota dealer.

■ When the battery is disconnected

The window lock switch is disabled. If necessary, press the window lock switch after reconnecting the battery.

 **CAUTION**

Observe the following precautions.

Failure to do so may result in death or serious injury.

■ Closing the windows

- The driver is responsible for all the power window operations, including the operation for the passengers. In order to prevent accidental operation, especially by a child, do not let a child operate the power windows. It is possible for children and other passengers to have body parts caught in the power window. Also, when riding with a child, it is recommended to use the window lock switch. (→P. 134)
- Check to make sure that all passengers do not have any part of their body in a position where it could be caught when a window is being operated.
- When exiting the vehicle, turn the engine switch off, carry the key and exit the vehicle along with the child. There may be accidental operation, due to mischief, etc., that may possibly lead to an accident.

■ Jam protection function

- Never use any part of your body to intentionally activate the jam protection function.
- The jam protection function may not work if something gets caught just before the window fully closes.

Moon roof*

Use the overhead switches to open and close the moon roof and tilt it up and down.

Opening and closing

① Opens the moon roof*

The moon roof stops slightly before the fully open position to reduce wind noise.

Press the switch again to fully open the moon roof.

② Closes the moon roof*

*: Lightly press either way of the moon roof switch to stop the moon roof partway.

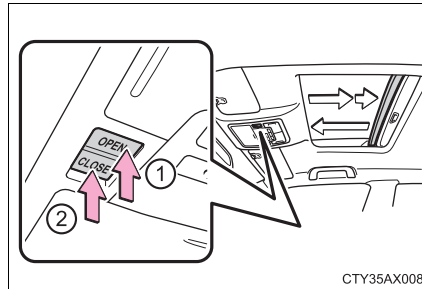

Tilting up and down

① Tilts the moon roof up*

② Tilts the moon roof down*

*: Lightly press either way of the moon roof switch to stop the moon roof partway.

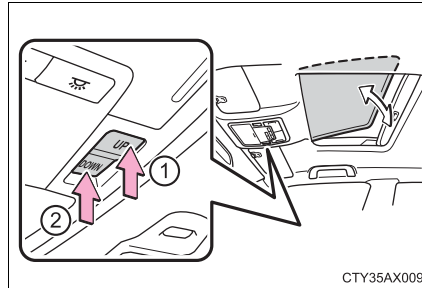

3

Operation of each component

*: If equipped

■ **The moon roof can be operated when**

The engine switch is in IGNITION ON mode.

■ **Operating the moon roof after turning the engine off**

The moon roof can be operated for approximately 45 seconds after the engine switch is turned to ACCESSORY mode or turned off. It cannot, however, be operated once either front door is opened.

■ **Jam protection function**

If an object is detected between the moon roof and the frame while the moon roof is closing or tilting down, travel is stopped and the moon roof opens slightly.

■ **Sunshade**

The sunshade can be opened and closed manually. However, the sunshade will open automatically when the moon roof is opened.

■ When the moon roof does not close normally

Perform the following procedure:

- If the moon roof closes but then re-opens slightly

- 1 Stop the vehicle.
- 2 Press and hold the "CLOSE" switch.*1
The moon roof will close, reopen and pause for approximately 10 seconds.*2 Then it will close again, tilt up and pause for approximately 1 second. Finally, it will tilt down, open and close.
- 3 Check to make sure that the moon roof is completely closed and then release the switch.

- If the moon roof tilts down but then tilts back up

- 1 Stop the vehicle.
- 2 Press and hold the "UP" switch*1 until the moon roof moves into the tilt up position and stops.
- 3 Release the "UP" switch once and then press and hold the "UP" switch again.*1
The moon roof will pause for approximately 10 seconds in the tilt up position.*2 Then it will adjust slightly and pause for approximately 1 second. Finally, it will tilt down, open and close.
- 4 Check to make sure that the moon roof is completely closed and then release the switch.

*1: If the switch is released at the incorrect time, the procedure will have to be performed again from the beginning.

*2: If the switch is released after the above mentioned 10 second pause, automatic operation will be disabled. In that case, press and hold the "CLOSE" or "UP" switch, and the moon roof will tilt up and pause for approximately 1 second. Then it will tilt down, open and close. Check to make sure that the moon roof is completely closed and then release the switch.

If the moon roof does not fully close even after performing the above procedure correctly, have the vehicle inspected by your Toyota dealer.

■ Moon roof open warning buzzer

The buzzer sounds and a message is shown on the multi-information display when the engine switch is turned off and the driver's door is opened with the moon roof open.

▲ CAUTION

Observe the following precautions.
Failure to do so may cause death or serious injury.

■ Opening the moon roof

- Do not allow any passengers to put their hands or heads outside the vehicle while it is moving.
- Do not sit on top of the moon roof.

■ Closing the moon roof

- The driver is responsible for moon roof opening and closing operations. In order to prevent accidental operation, especially by a child, do not let a child operate the moon roof. It is possible for children and other passengers to have body parts caught in the moon roof.
- Check to make sure that all passengers do not have any part of their body in a position where it could be caught when the moon roof is being operated.
- When exiting the vehicle, turn the engine switch off, carry the key and exit the vehicle along with the child. There may be accidental operation, due to mischief, etc., that may possibly lead to an accident.

■ Jam protection function

- Never use any part of your body to intentionally activate the jam protection function.
- The jam protection function may not work if something gets caught just before the moon roof fully closes.

Driving

4

- | | |
|---|--|
| <p>4-1. Before driving</p> <ul style="list-style-type: none"> Driving the vehicle..... 142 Cargo and luggage 153 Vehicle load limits 156 Trailer towing..... 157 Dinghy towing 158 <p>4-2. Driving procedures</p> <ul style="list-style-type: none"> Engine (ignition) switch 159 Automatic transmission..... 165 Turn signal lever..... 169 Parking brake 170 Horn 171 | <p>4-3. Operating the lights and wipers</p> <ul style="list-style-type: none"> Headlight switch..... 172 Automatic High Beam 176 Fog light switch 181 Windshield wipers and washer 183 <p>4-4. Refueling</p> <ul style="list-style-type: none"> Opening the fuel tank cap 189 <p>4-5. Using the driving support systems</p> <ul style="list-style-type: none"> Cruise control..... 194 Dynamic radar cruise control 198 Driving mode select switches 213 Driving assist systems 215 PCS (Pre-Collision System)..... 220 BSM (Blind Spot Monitor) 227 <p>4-6. Driving tips</p> <ul style="list-style-type: none"> Winter driving tips 236 |
|---|--|

Driving the vehicle

The following procedures should be observed to ensure safe driving:

Starting the engine

→P. 159

Driving

- 1 With the brake pedal depressed, shift the shift lever to D. (→P. 165)
- 2 Release the parking brake. (→P. 170)
- 3 Gradually release the brake pedal and gently depress the accelerator pedal to accelerate the vehicle.

Stopping

- 1 With the shift lever in D, depress the brake pedal until the vehicle comes to a stop.
- 2 If necessary, set the parking brake.
If the vehicle is to be stopped for an extended period of time, shift the shift lever to P or N. (→P. 165)

Parking the vehicle

- 1 With the shift lever in D, depress the brake pedal.
- 2 Set the parking brake. (→P. 170)
- 3 Shift the shift lever to P. (→P. 165)
If parking on a hill, block the wheels as needed.
- 4 Press the engine switch to stop the engine.
- 5 Lock the door, making sure that you have the electronic key on your person.

Starting off on a steep uphill

- 1 Make sure that the parking brake is set and shift the shift lever to D.
- 2 Gently depress the accelerator pedal.
- 3 Release the parking brake.

Driving in the rain

- Drive carefully when it is raining, because visibility will be reduced, the windows may become fogged-up, and the road will be slippery.
- Drive carefully when it starts to rain, because the road surface will be especially slippery.
- Refrain from driving at high speeds in the rain, as there may be a layer of water between the tires and the road surface, preventing the steering and brakes from operating properly.

Engine speed while driving

In the following conditions, the engine speed may become high while driving. This is due to automatic up-shifting control or down-shifting implementation to meet driving conditions. It does not indicate sudden acceleration.

- The vehicle is judged to be driving uphill or downhill
- When the accelerator pedal is released

■ Breaking in your new Toyota

To extend the life of the vehicle, observing the following precautions is recommended:

- For the first 186 miles (300 km):
Avoid sudden stops.
- For the first 621 miles (1000 km):
 - Do not drive at extremely high speeds.
 - Avoid sudden acceleration.
 - Do not drive continuously in low gears.
 - Do not drive at a constant speed for extended periods.

■ Drum-in-disc type parking brake system

Your vehicle has a drum-in-disc type parking brake system. This type of brake system needs bedding-down of the brake shoes periodically or whenever the parking brake shoes and/or drum are replaced. Have your Toyota dealer perform the bedding down operation.

■ Operating your vehicle in a foreign country

Comply with the relevant vehicle registration laws and confirm the availability of the correct fuel. (→P. 439)

■ Eco-friendly driving

During Eco-friendly acceleration (Eco driving), Eco Driving Indicator Light will turn on. If the acceleration exceeds the Eco driving accelerator upper limit, or the vehicle is stopped, the light turns off.

Eco Driving Indicator Light will not operate in the following conditions:

- The shift lever is in anything other than D.
- The paddle shift switch is used.
- The vehicle is in sport mode.
- The vehicle speed is approximately 80 mph (130 km/h) or higher.

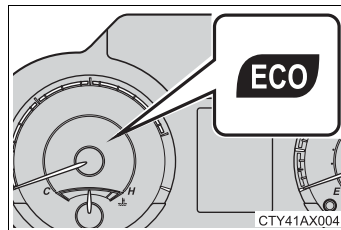

 **CAUTION**

Observe the following precautions.

Failure to do so may result in death or serious injury.

■ **When starting the vehicle**

Always keep your foot on the brake pedal while stopped with the engine running. This prevents the vehicle from creeping.

■ **When driving the vehicle**

- Do not drive if you are unfamiliar with the location of the brake and accelerator pedals to avoid depressing the wrong pedal.
 - Accidentally depressing the accelerator pedal instead of the brake pedal will result in sudden acceleration that may lead to an accident.
 - When backing up, you may twist your body around, leading to a difficulty in operating the pedals. Make sure to operate the pedals properly.
 - Make sure to keep a correct driving posture even when moving the vehicle only slightly. This allows you to depress the brake and accelerator pedals properly.
 - Depress the brake pedal using your right foot. Depressing the brake pedal using your left foot may delay response in an emergency, resulting in an accident.
- Do not drive the vehicle over or stop the vehicle near flammable materials. The exhaust system and exhaust gases can be extremely hot. These hot parts may cause a fire if there is any flammable material nearby.

 CAUTION

Observe the following precautions.

Failure to do so may result in death or serious injury.

■ **When driving the vehicle**

- During normal driving, do not turn off the engine. Turning the engine off while driving will not cause loss of steering or braking control, but the power assist to these systems will be lost. This will make it more difficult to steer and brake, so you should pull over and stop the vehicle as soon as it is safe to do so.
However, in the event of an emergency, such as if it becomes impossible to stop the vehicle in the normal way: →P. 381
- Use engine braking (downshift) to maintain a safe speed when driving down a steep hill.
Using the brakes continuously may cause the brakes to overheat and lose effectiveness. (→P. 165)
- Do not adjust the positions of the steering wheel, the seat, or the inside or outside rear view mirrors while driving.
Doing so may result in a loss of vehicle control.
- Always check that all passengers' arms, heads or other parts of their body are not outside the vehicle.
- Do not drive in excess of the speed limit. Even if the legal speed limit permits it, do not drive over 85 mph (140 km/h) unless your vehicle has high-speed capability tires. Driving over 85 mph (140 km/h) may result in tire failure, loss of control and possible injury. Be sure to consult a tire dealer to determine whether the tires on your vehicle are high-speed capability tires or not before driving at such speeds.

 CAUTION

Observe the following precautions.

Failure to do so may result in death or serious injury.

■ **When driving on slippery road surfaces**

- Sudden braking, acceleration and steering may cause tire slippage and reduce your ability to control the vehicle.
- Sudden acceleration, engine braking due to shifting, or changes in engine speed could cause the vehicle to skid.
- After driving through a puddle, lightly depress the brake pedal to make sure that the brakes are functioning properly. Wet brake pads may prevent the brakes from functioning properly. If the brakes on only one side are wet and not functioning properly, steering control may be affected.

■ **When shifting the shift lever**

- Do not let the vehicle roll backward while the shift lever is in a driving position, or roll forward while the shift lever is in R.
Doing so may cause the engine to stall or lead to poor brake and steering performance, resulting in an accident or damage to the vehicle.
- Do not shift the shift lever to P while the vehicle is moving.
Doing so can damage the transmission and may result in a loss of vehicle control.
- Do not shift the shift lever to R while the vehicle is moving forward.
Doing so can damage the transmission and may result in a loss of vehicle control.
- Do not shift the shift lever to D while the vehicle is moving backward.
Doing so can damage the transmission and may result in a loss of vehicle control.
- Moving the shift lever to N while the vehicle is moving will disengage the engine from the transmission. Engine braking is not available when N is selected.
- Be careful not to shift the shift lever with the accelerator pedal depressed.
Shifting the shift lever to a gear other than P or N may lead to unexpected rapid acceleration of the vehicle that may cause an accident and result in death or serious injury.

 CAUTION

Observe the following precautions.

Failure to do so may result in death or serious injury.

■ **If you hear a squealing or scraping noise (brake pad wear limit indicators)**

Have the brake pads checked and replaced by your Toyota dealer as soon as possible.

Rotor damage may result if the pads are not replaced when needed.

It is dangerous to drive the vehicle when the wear limits of the brake pads and/or those of the brake discs are exceeded.

■ **When the vehicle is stopped**

- Do not race the engine.

If the vehicle is in any gear other than P or N, the vehicle may accelerate suddenly and unexpectedly, causing an accident.

- In order to prevent accidents due to the vehicle rolling away, always keep depressing the brake pedal while the engine is running, and apply the parking brake as necessary.

- If the vehicle is stopped on an incline, in order to prevent accidents caused by the vehicle rolling forward or backward, always depress the brake pedal and securely apply the parking brake as needed.

- Avoid revving or racing the engine.

Running the engine at high speed while the vehicle is stopped may cause the exhaust system to overheat, which could result in a fire if combustible material is nearby.

 **CAUTION**

Observe the following precautions.

Failure to do so may result in death or serious injury.

■ **When the vehicle is parked**

- Do not leave glasses, cigarette lighters, spray cans, or soft drink cans in the vehicle when it is in the sun.

Doing so may result in the following:

- Gas may leak from a cigarette lighter or spray can, and may lead to a fire.
 - The temperature inside the vehicle may cause the plastic lenses and plastic material of glasses to deform or crack.
 - Soft drink cans may fracture, causing the contents to spray over the interior of the vehicle, and may also cause a short circuit in the vehicle's electrical components.
- Do not leave cigarette lighters in the vehicle. If a cigarette lighter is in a place such as the glove box or on the floor, it may be lit accidentally when luggage is loaded or the seat is adjusted, causing a fire.
 - Do not attach adhesive discs to the windshield or windows. Do not place containers such as air fresheners on the instrument panel or dashboard. Adhesive discs or containers may act as lenses, causing a fire in the vehicle.
 - Do not leave a door or window open if the curved glass is coated with a metallized film such as a silver-colored one. Reflected sunlight may cause the glass to act as a lens, causing a fire.
 - Always apply the parking brake, shift the shift lever to P, stop the engine and lock the vehicle.
Do not leave the vehicle unattended while the engine is running.
 - Do not touch the exhaust pipes while the engine is running or immediately after turning the engine off.
Doing so may cause burns.

 **CAUTION**

Observe the following precautions.
Failure to do so may result in death or serious injury.

■ When taking a nap in the vehicle

Always turn the engine off. Otherwise, if you accidentally move the shift lever or depress the accelerator pedal, this could cause an accident or fire due to engine overheating. Additionally, if the vehicle is parked in a poorly ventilated area, exhaust gases may collect and enter the vehicle, leading to death or a serious health hazard.

■ When braking

- When the brakes are wet, drive more cautiously.
Braking distance increases when the brakes are wet, and this may cause one side of the vehicle to brake differently than the other side. Also, the parking brake may not securely hold the vehicle.
- If the power brake assist function does not operate, do not follow other vehicles closely and avoid hills or sharp turns that require braking.
In this case, braking is still possible, but the brake pedal should be depressed more firmly than usual. Also, the braking distance will increase. Have your brakes fixed immediately.
- Do not pump the brake pedal if the engine stalls.
Each push on the brake pedal uses up the reserve for the power-assisted brakes.
- The brake system consists of 2 individual hydraulic systems; if one of the systems fails, the other will still operate. In this case, the brake pedal should be depressed more firmly than usual and the braking distance will increase.
Have your brakes fixed immediately.

 NOTICE**■ When driving the vehicle**

- Do not depress the accelerator and brake pedals at the same time during driving, as this may restrain driving torque.
- Do not use the accelerator pedal or depress the accelerator and brake pedals at the same time to hold the vehicle on a hill.

■ When parking the vehicle

Always shift the shift lever to P. Failure to do so may cause the vehicle to move or the vehicle may accelerate suddenly if the accelerator pedal is accidentally depressed.

■ Avoiding damage to vehicle parts

- Do not turn the steering wheel fully in either direction and hold it there for an extended period of time.
Doing so may damage the power steering motor.
- When driving over bumps in the road, drive as slowly as possible to avoid damaging the wheels, underside of the vehicle, etc.

■ If you get a flat tire while driving

A flat or damaged tire may cause the following situations. Hold the steering wheel firmly and gradually depress the brake pedal to slow down the vehicle.

- It may be difficult to control your vehicle.
- The vehicle will make abnormal sounds or vibrations.
- The vehicle will behave abnormally.

Information on what to do in case of a flat tire (→P. 400)

 NOTICE

■ **When encountering flooded roads**

Do not drive on a road that has flooded after heavy rain etc. Doing so may cause the following serious damage to the vehicle:

- Engine stalling
- Short in electrical components
- Engine damage caused by water immersion

In the event that you drive on a flooded road and the vehicle is flooded, be sure to have your Toyota dealer check the following:

- Brake function
- Changes in quantity and quality of oil and fluid used for the engine, transmission, etc.
- Lubricant condition for the bearings and suspension joints (where possible), and the function of all joints, bearings, etc.

Cargo and luggage

Take notice of the following information about storage precautions, cargo capacity and load:

Capacity and distribution

Cargo capacity depends on the total weight of the occupants.

(Cargo capacity) = (Total load capacity) — (Total weight of occupants)

Steps for Determining Correct Load Limit —

- (1) Locate the statement “The combined weight of occupants and cargo should never exceed XXX kg or XXX lbs.” on your vehicle’s placard.
- (2) Determine the combined weight of the driver and passengers that will be riding in your vehicle.
- (3) Subtract the combined weight of the driver and passengers from XXX kg or XXX lbs.
- (4) The resulting figure equals the available amount of cargo and luggage load capacity.
For example, if the “XXX” amount equals 1400 lbs. and there will be five 150 lb passengers in your vehicle, the amount of available cargo and luggage load capacity is 650 lbs. (1400 – 750 (5 × 150) = 650 lbs.)
- (5) Determine the combined weight of luggage and cargo being loaded on the vehicle. That weight may not safely exceed the available cargo and luggage load capacity calculated in Step 4.
- (6) If your vehicle will be towing a trailer, load from your trailer will be transferred to your vehicle. Consult this manual to determine how this reduces the available cargo and luggage load capacity of your vehicle.

(→P. 156)

Toyota does not recommend towing a trailer with your vehicle. Your vehicle is not designed for trailer towing.

Calculation formula for on your vehicle

- ① Cargo capacity
- ② Total load capacity
(vehicle capacity weight)
(→P. 430)

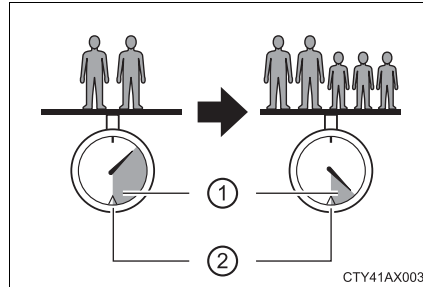

When 2 people with the combined weight of A lb. (kg) are riding in your vehicle, which has a total load capacity (vehicle capacity weight) of B lb. (kg), the available amount of cargo and luggage load capacity will be C lb. (kg) as follows:

$$B^{*2} \text{ lb. (kg)} - A^{*1} \text{ lb. (kg)} = C^{*3} \text{ lb. (kg)}$$

- *1: A = Weight of people
- *2: B = Total load capacity
- *3: C = Available cargo and luggage load

In this condition, if 3 more passengers with the combined weight of D lb. (kg) get on, the available cargo and luggage load will be reduced E lb. (kg) as follows:

$$C \text{ lb. (kg)} - D^{*4} \text{ lb. (kg)} = E^{*5} \text{ lb. (kg)}$$

- *4: D = Additional weight of people
- *5: E = Available cargo and luggage load

As shown in the example above, if the number of occupants increases, the cargo and luggage load will be reduced by an amount that equals the increased weight due to the additional occupants. In other words, if an increase in the number of occupants causes an excess of the total load capacity (combined weight of occupants plus cargo and luggage load), you must reduce the cargo and luggage on your vehicle.

 CAUTION**■ Things that must not be carried in the trunk**

The following things may cause a fire if loaded in the trunk:

- Receptacles containing gasoline
- Aerosol cans

■ Storage precautions

Observe the following precautions.

Failure to do so may prevent the pedals from being depressed properly, may block the driver's vision, or may result in items hitting the driver or passengers, possibly causing an accident.

- Stow cargo and luggage in the trunk whenever possible.
- Do not place cargo or luggage in or on the following locations.
 - At the feet of the driver
 - On the front passenger or rear seats (when stacking items)
 - On the package tray
 - On the instrument panel
 - On the dashboard
- Secure all items in the occupant compartment.

■ Capacity and distribution

- Do not exceed the maximum axle weight rating or the total vehicle weight rating.
- Even if the total load of occupant's weight and the cargo load is less than the total load capacity, do not apply the load unevenly. Improper loading may cause deterioration of steering or braking control which may cause death or serious injury.

Vehicle load limits

Vehicle load limits include total load capacity, seating capacity, towing capacity and cargo capacity.

◆ **Total load capacity (vehicle capacity weight): (→P. 430)**

Total load capacity means the combined weight of occupants, cargo and luggage.

◆ **Seating capacity: 5 occupants (Front 2, Rear 3)**

Seating capacity means the maximum number of occupants whose estimated average weight is 150 lb. (68 kg) per person.

◆ **Towing capacity**

Toyota does not recommend towing a trailer with your vehicle.

◆ **Cargo capacity**

Cargo capacity may increase or decrease depending on the weight and the number of occupants.

■ **Total load capacity and seating capacity**

These details are also described on the tire and loading information label. (→P. 342)

 **CAUTION**

■ **Overloading the vehicle**

Do not overload the vehicle.

It may not only cause damage to the tires, but also degrade steering and braking ability, resulting in an accident.

Trailer towing

Toyota does not recommend towing a trailer with your vehicle. Toyota also does not recommend the installation of a tow hitch or the use of a tow hitch carrier for a wheelchair, scooter, bicycle, etc. Your vehicle is not designed for trailer towing or for the use of tow hitch mounted carriers.



4

Driving

Dinghy towing

Your vehicle is not designed to be dinghy towed (with 4 wheels on the ground) behind a motor home.

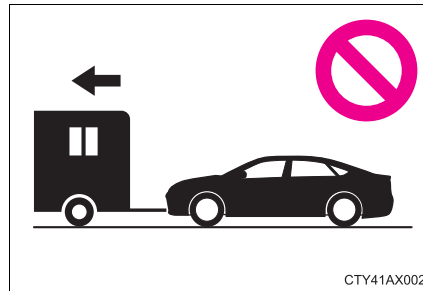

 **NOTICE**

- **To avoid serious damage to your vehicle**
Do not tow your vehicle with the four wheels on the ground.

Engine (ignition) switch

Performing the following operations when carrying the electronic key on your person starts the engine or changes engine switch modes.

Starting the engine

- 1 Check that the parking brake is set.
- 2 Check that the shift lever is set in P.
- 3 Firmly depress the brake pedal.

Messages indicating how to start the engine and how to turn to ACCESSORY mode will be displayed alternately on the multi-information display.

- 4 Press the engine switch.

The engine will crank until it starts or for up to 30 seconds, whichever is less.

Continue depressing the brake pedal until the engine is completely started.

The engine can be started from any engine switch mode.

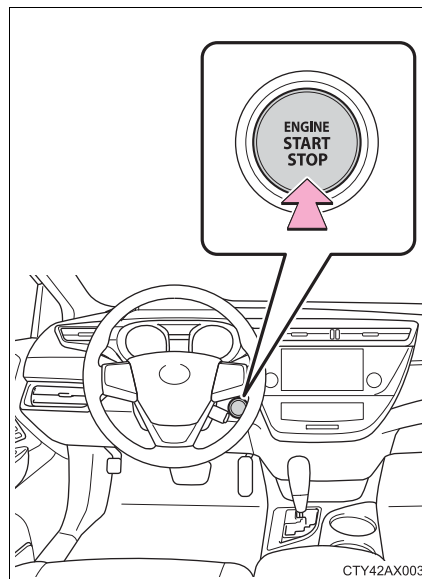

Stopping the engine

- 1 Stop the vehicle.
- 2 Shift the shift lever to P.
- 3 Set the parking brake. (→P. 170)
- 4 Press the engine switch.

Driving-related data will be displayed on the multi-information display.
(→P. 84)

Changing engine switch modes

Modes can be changed by pressing the engine switch with brake pedal released. (The mode changes each time the switch is pressed.)

Off*

The emergency flashers can be used.

The multi-information display will not be displayed.

ACCESSORY mode

Some electrical components such as the audio system can be used.

A message indicating how to start the engine will be displayed on the multi-information display.

IGNITION ON mode

All electrical components can be used.

*: If the shift lever is in a position other than P when turning off the engine, the engine switch will be turned to ACCESSORY mode, not to off.

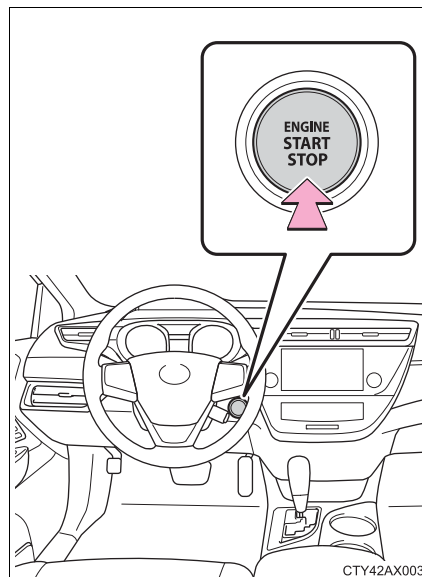

When stopping the engine with the shift lever in a position other than P

If the engine is stopped with the shift lever in a position other than P, a message indicating to shift the shift lever to P will be displayed on the multi-information display. At this time, the engine switch will not be turned off but instead be turned to ACCESSORY mode. Perform the following procedure to turn the switch off:

- 1 Check that the parking brake is set.
- 2 Shift the shift lever to P.
- 3 Check that "Turn Power OFF" is displayed on the multi-information display and then press the engine switch once.
- 4 Check that "Turn Power OFF" on the multi-information display is turned off.

■ **Auto power off function**

If the vehicle is left in ACCESSORY mode for more than 20 minutes or IGNITION ON mode (the engine is not running) for more than an hour with the shift lever in P, the engine switch will automatically turn off. However, this function cannot entirely prevent battery discharge. Do not leave the vehicle with the engine switch in ACCESSORY or IGNITION ON mode for long periods of time when the engine is not running.

■ **Electronic key battery depletion**

→P. 106

■ **Conditions affecting operation**

→P. 102

■ **Notes for the entry function**

→P. 103

■ **If the engine does not start**

- The engine immobilizer system may not have been deactivated. (→P. 66)
Contact your Toyota dealer.
- Check that the shift lever is securely set in P. The engine may not start if the shift lever is displaced out of P.

■ **Steering lock**

After turning the engine switch off and opening and closing the doors, the steering wheel will be locked due to the steering lock function. Operating the engine switch again automatically cancels the steering lock.

■ When the steering lock cannot be released

A message informing the driver that the steering wheel is locked will be displayed on the multi-information display.

Check that the shift lever is set in P. Press the engine switch while turning the steering wheel left and right.

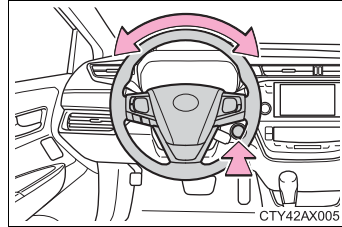

■ Steering lock motor overheating prevention

To prevent the steering lock motor from overheating, the motor may be suspended if the engine is turned on and off repeatedly in a short period of time. In this case, refrain from operating the engine. After about 10 seconds, the steering lock motor will resume functioning.

■ When a message requesting the smart key system be inspected is displayed on the multi-information display

The system may be malfunctioning. Have the vehicle inspected by your Toyota dealer immediately.

■ If the electronic key battery is depleted

→P. 350

■ Operation of the engine switch

- When operating the engine switch, one short, firm press is enough. If the switch is pressed improperly, the engine may not start or the engine switch mode may not change. It is not necessary to press and hold the switch.

- If attempting to restart the engine immediately after turning the engine switch off, the engine may not start in some cases. After turning the engine switch off, please wait a few seconds before restarting the engine.

■ If the smart key system has been deactivated in a customized setting

→P. 416

■ Customization

The time elapsed before the engine switch related messages on the multi-information display turn off can be changed.

(Customizable features: →P. 455)

 CAUTION

■ **When starting the engine**

Always start the engine while sitting in the driver's seat. Do not depress the accelerator pedal while starting the engine under any circumstances. Doing so may cause an accident resulting in death or serious injury.

■ **Caution while driving**

If engine failure occurs while the vehicle is moving, do not lock or open the doors until the vehicle reaches a safe and complete stop. Activation of the steering lock in this circumstance may lead to an accident, resulting in death or serious injury.

■ **Stopping the engine in an emergency**

If you want to stop the engine in an emergency while driving the vehicle, press and hold the engine switch for more than 2 seconds, or press it briefly 3 times or more in succession. (→P. 381)

However, do not touch the engine switch while driving except in an emergency. Turning the engine off while driving will not cause loss of steering or braking control, but the power assist to these systems will be lost. This will make it more difficult to steer and brake, so you should pull over and stop the vehicle as soon as it is safe to do so.

 NOTICE

■ **To prevent battery discharge**

- Do not leave the engine switch in ACCESSORY or IGNITION ON mode for long periods of time without the engine running.
- Do not stop the engine when the shift lever is in a position other than P. If the engine is stopped in another shift lever position, the engine switch will not be turned off but instead be turned to ACCESSORY mode. If the vehicle is left in ACCESSORY mode, battery discharge may occur.

■ **When starting the engine**

- Do not race a cold engine.
- If the engine becomes difficult to start or stalls frequently, have your vehicle checked by your Toyota dealer immediately.

■ **Symptoms indicating a malfunction with the engine switch**

If the engine switch seems to be operating somewhat differently than usual, such as the switch sticking slightly, there may be a malfunction. Contact your Toyota dealer immediately.

Automatic transmission

Shifting the shift lever

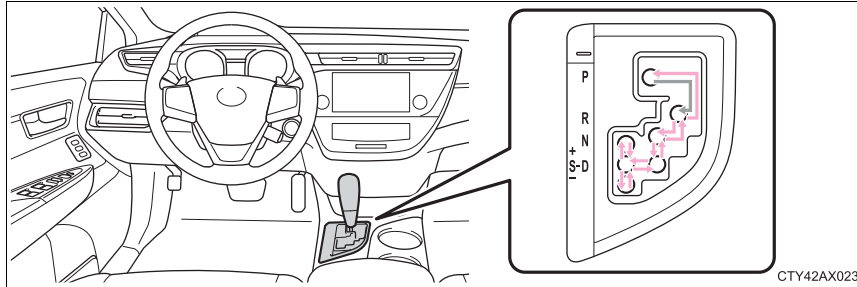

← While the engine switch is in IGNITION ON mode, move the shift lever with the brake pedal depressed.

When shifting the shift lever between P and D, make sure that the vehicle is completely stopped.

Shift position purpose

Shift position	Objective or function
P	Parking the vehicle/starting the engine
R	Reversing
N	Neutral
D	Normal driving ^{*1}
S	S mode driving ^{*2} (→P. 166)

^{*1}: To improve fuel efficiency and reduce noises, set the shift lever in the D position for normal driving.

^{*2}: Selecting shift ranges using S mode restricts the upper limit of the possible gear ranges, controls engine braking force, and prevents upshifting above the selected range.

Changing shift ranges in S mode

When the shift lever is in the S position, the shift lever or paddle shift switches can be operated as follows:

▶ Shift lever

- ① Upshifting
- ② Downshifting

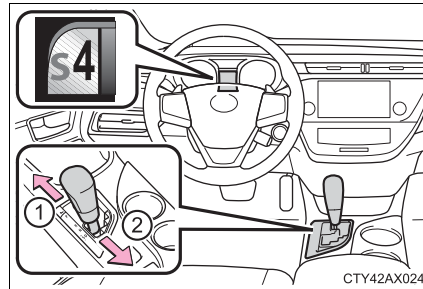

▶ Paddle shift switches

- ① Upshifting
- ② Downshifting

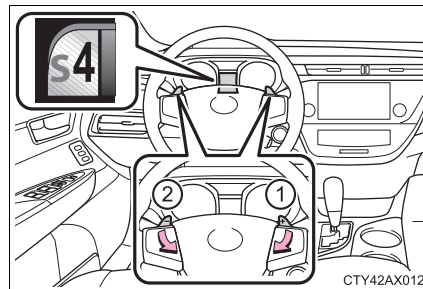

The initial shift range in S mode is set automatically to “4” or “5” according to vehicle speed. However, the initial shift range may be set to “3” if AI-SHIFT has operated while the shift lever was in the D position. (→P. 168)

■ Shift ranges and their functions

- The vehicle is allowed to shift up and down to provide the most suitable gear selection based on your driving situation. (e.g. S4: 1 to 4 or, 4 to 1)
- You can choose from 6 levels of engine braking force.
A lower shift range will provide greater engine braking force than a higher shift range, and the engine speed will also increase.
- You can choose the gear range you want for different levels of acceleration. (e.g. uphill, sporty driving, etc.)

Selecting shift ranges in the D position

To drive using temporary shift range selection, operate the “-” paddle shift switch. The shift range can then be selected by operating the “-” and “+” paddle shift switches. Changing the shift range allows restriction of the highest gear, preventing upshifting and enabling the level of engine braking force to be selected.

- ① Upshifting
- ② Downshifting

The selected shift range, from “1” to “5”, or D will be displayed in the meter.

To return to normal D position driving, the “+” paddle shift switch must be held down for a period of time.

When a shift range higher than “5” is selected, the shift range will return to the normal D position.

When the vehicle comes to a stop, the shift range will return to the normal D position.

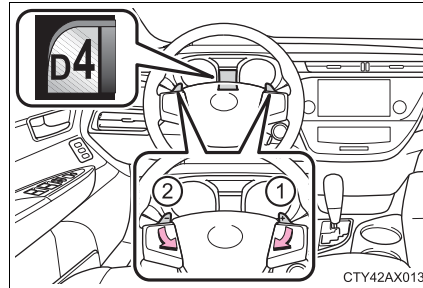

■ S mode

- When the shift range is “4” or lower, holding the shift lever toward “+” sets the shift range to “6”.
- To prevent the engine from over-revving, upshifting may automatically occur.
- To protect the automatic transmission, a function is adopted that automatically shifts to the top range when the temperature is too hot.

■ AI-SHIFT

AI-SHIFT automatically selects the suitable gear according to driver input and the driving situation.

AI-SHIFT automatically operates when the shift lever is in the D position. (Shifting the shift lever to the S position or paddle shifting cancels the function.)

■ When driving with cruise control or radar cruise control activated

When downshifting to 5 or 4 by shifting the shift lever to the S position or paddle shifting, cruise control or radar cruise control will not be canceled.

(→P. 194, 198)

■ If the shift lever cannot be shifted from P

→P. 415

■ If the “S” indicator does not come on or the “D” indicator is displayed even after shifting the shift lever to S

This may indicate a malfunction in the automatic transmission system. Have the vehicle inspected by your Toyota dealer immediately.

(In this situation, the transmission will operate in the same manner as when the shift lever is in D.)

■ Downshift restriction warning buzzer (S mode or paddle shifting)

To help ensure safety and driving performance, downshifting operation may sometimes be restricted. In some circumstances, downshifting may not be possible even when the shift lever or paddle shift switches are operated. (A buzzer will sound twice.)

▲ CAUTION**■ When driving on slippery road surfaces**

Be careful of downshifting and sudden acceleration, as this could result in the vehicle skidding to the side or spinning.

Turn signal lever

Operating instructions

The lever will return to its original position after operation.

- ① Right turn
- ② Lane change to the right (move the lever partway and release it)
The right hand signals will flash 3 times.
- ③ Lane change to the left (move the lever partway and release it)
The left hand signals will flash 3 times.
- ④ Left turn

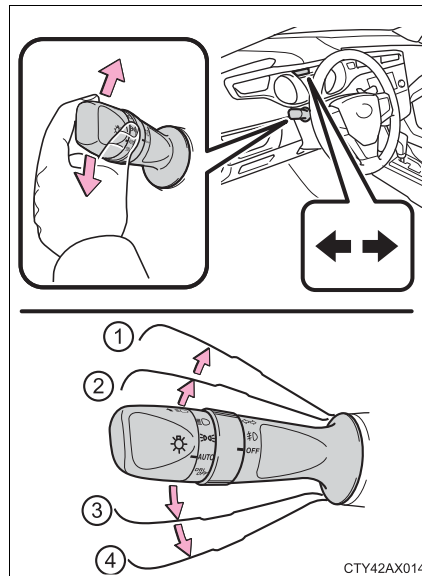

■ Turn signals can be operated when

The engine switch is in IGNITION ON mode.

■ If the indicator flashes faster than usual

Check that a light bulb in the front or rear turn signal lights has not burned out.

■ If the turn signals stop flashing before a lane change has been performed

Operate the lever again.

■ To discontinue flashing of the turn signals during a lane change

Operate the lever in the opposite direction.

■ When the lever is pushed and held partway

The turn signals will keep flashing until the lever is released.

■ Customization

The number of times the turn signals flash during a lane change can be changed. (Customizable feature →P. 455)

Parking brake

To set the parking brake, fully depress the parking brake pedal with your left foot while depressing the brake pedal with your right foot.

(Depressing the pedal again releases the parking brake.)

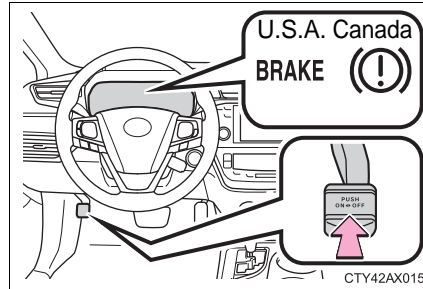

■ Usage in winter time

→P. 237

NOTICE

■ Before driving

Fully release the parking brake.

Driving the vehicle with the parking brake set will lead to brake components overheating, which may affect braking performance and increase brake wear.

Horn

To sound the horn, press on or close to the  mark.

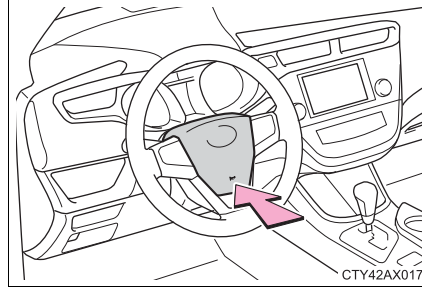

■ After adjusting the steering wheel

Make sure that the steering wheel is securely locked.

The horn may not sound if the steering wheel is not securely locked.

(→P. 128)



Headlight switch

The headlights can be operated manually or automatically.

Operating instructions

Turning the end of the lever turns on the lights as follows:

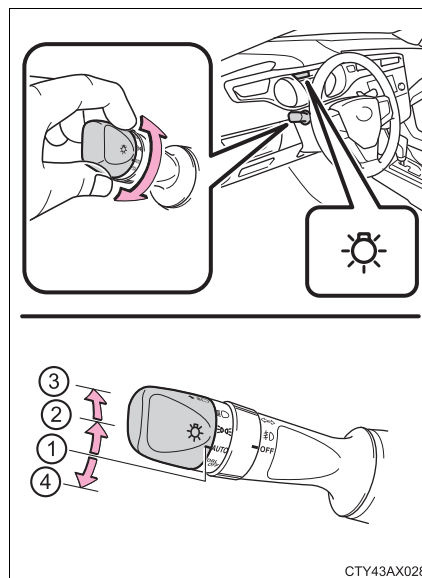

► Type A

- ① **AUTO** The headlights, parking lights, daytime running lights and so on turn on and off automatically (when the engine switch is in IGNITION ON mode).
- ②  The side marker, parking, tail, license plate, daytime running lights and instrument panel lights turn on.
- ③  The headlights and all the lights listed above (except daytime running lights) turn on.
- ④  The daytime running lights turn off.



CTY43AX028

► Type B

- ① **AUTO** The headlights, parking lights, daytime running lights and so on turn on and off automatically (when the engine switch is in IGNITION ON mode).
- ②  The side marker, parking, tail, license plate, daytime running lights and instrument panel lights turn on.
- ③  The headlights and all the lights listed above (except daytime running lights) turn on.
- ④  The daytime running lights turn on.

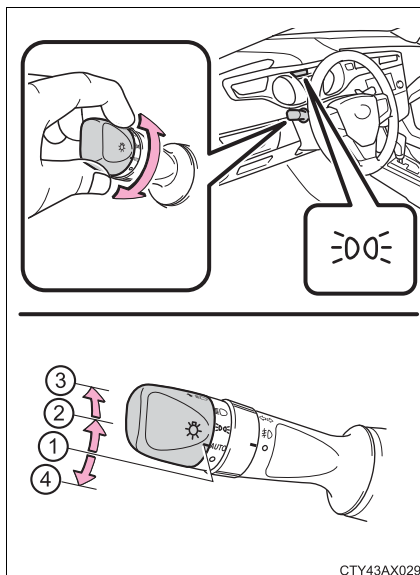

4

Driving

Turning on the high beam headlights

- ① With the headlights on, push the lever away from you to turn on the high beams.
Pull the lever toward you to the center position to turn the high beams off.
- ② Pull the lever toward you and release it to flash the high beams once.
You can flash the high beams with the headlights on or off.

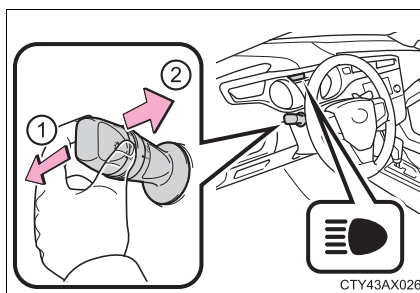

■ Daytime running light system

- Vehicles with halogen headlights: To make your vehicle more visible to other drivers, the headlight high beam turn on automatically (at a decreased intensity) whenever the engine is started and the parking brake is released. Daytime running lights are not designed for use at night.

Vehicles with discharge headlights: To make your vehicle more visible to other drivers, the parking lights turn on automatically (at an increased intensity) whenever the engine is started and the parking brake is released. Daytime running lights are not designed for use at night.

Type A: Daytime running lights can be turned off by operating the switch.

- Compared to turning on the headlights, the daytime running light system offers greater durability and consumes less electricity, so it can help improve fuel economy.

■ Headlight control sensor

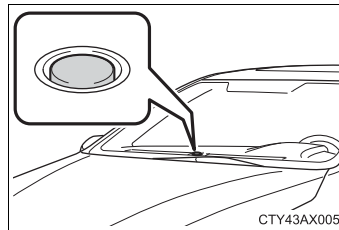

The sensor may not function properly if an object is placed on the sensor, or anything that blocks the sensor is affixed to the windshield.

Doing so interferes with the sensor detecting the level of ambient light and may cause the automatic headlight system to malfunction.



■ Automatic light off system

- When the headlights are on: The headlights and tail lights turn off 30 seconds after the engine switch is turned off and a door is opened and all of the doors and trunk are closed. (The lights turn off immediately if  on the key is pressed twice after all the doors are closed.)
- When only the tail lights are on: The tail lights turn off automatically if the engine switch is turned off and the driver's door is opened.

To turn the lights on again, turn the engine switch to IGNITION ON mode, or turn the light switch off once and then back to  or .

If any of the doors or trunk lid is kept open, the lights automatically turn off after 20 minutes.

■ Light reminder buzzer

A buzzer sounds when the engine switch is turned off or turned to ACCESSORY mode and the driver's door is opened while the lights are turned on.

■ Automatic headlight leveling system (if equipped)

The level of the headlights is automatically adjusted according to the number of passengers and the loading condition of the vehicle to ensure that the headlights do not interfere with other road users.

■ Customization

Settings (e.g. light sensor sensitivity) can be changed.
(Customizable features: →P. 455)

**NOTICE****■ To prevent battery discharge**

Do not leave the lights on longer than necessary when the engine is not running.

Automatic High Beam*

The Automatic High Beam uses an in-vehicle camera sensor to assess the brightness of streetlights, the lights of oncoming and preceding vehicles, etc., and automatically turns high beam on or off as necessary.

Activating the Automatic High Beam system

- 1 Put the headlight switch in the "AUTO" position.

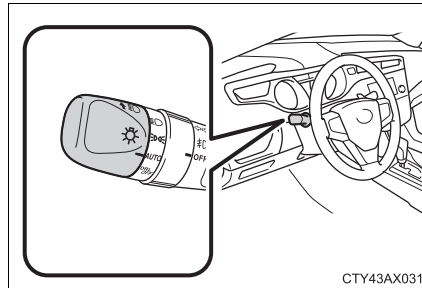

- 2 Push the lever away from you.

The Automatic High Beam indicator will come on when the headlights are turned on automatically to indicate that the system is active.

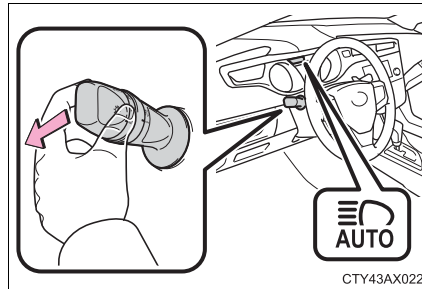

*: If equipped

High beam automatic turning on or off conditions

When all of the following conditions are fulfilled, high beam will be automatically turned on (after approximately 1 second):

- Vehicle speed is above approximately 25 mph (40 km/h).
- The area ahead of the vehicle is dark.
- There are no oncoming or preceding vehicles with headlights or tail lights turned on.

If any of the following conditions are fulfilled, high beam will be automatically turned off:

- Vehicle speed drops below approximately 19 mph (30 km/h).
- The area ahead of the vehicle is not dark.

Turning the high beam on/off manually

■ Switching to low beam

Pull the lever to original position.

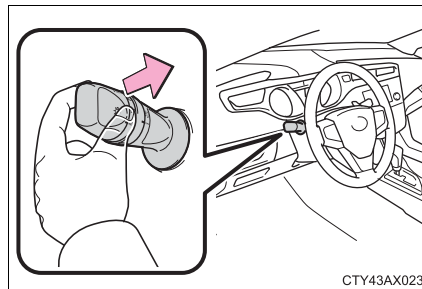

■ Switching to high beam

Turn the light switch to  position.

The Automatic High Beam indicator will turn off and the high beam indicator will turn on.

Press the switch to activate the Automatic High Beam system again.

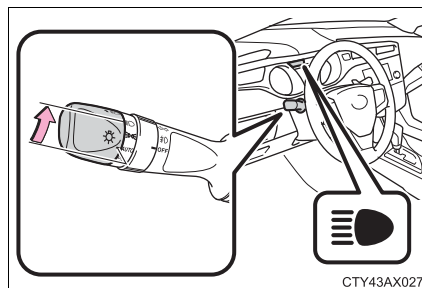

■ **The Automatic High Beam can be operated when**

The engine switch is in IGNITION ON mode.

■ **Camera sensor detection information**

- High beam may not be automatically turned off in the following situations:
 - When oncoming vehicles suddenly appear from a curve
 - When the vehicle is cut in front of by another
- High beam may be turned off if an oncoming vehicle that is using fog lights without using the headlights is detected.
- House lights, street lights, red traffic signals, and illuminated billboards or signs may cause the high beam to turn off.
- The following factors may affect the amount of time taken to turn high beam on or off:
 - The brightness of headlights, fog lights, and tail lights of oncoming and preceding vehicles
 - The condition of the road (gradient, curve, condition of the road surface etc.)
 - The number of passengers and amount of luggage
- High beam may be turned on or off when unexpected by the driver.

- In the situations below, the system may not be able to correctly detect the surrounding brightness levels, and may flash or expose nearby pedestrians to the high beam. Therefore, you should consider turning the high beams on or off manually rather than relying on the Automatic High Beam system.
 - In bad weather (rain, snow, fog, sandstorms etc.)
 - The windshield is obscured by fog, mist, ice, dirt etc.
 - The windshield is cracked or damaged.
 - The inside rear view mirror or camera sensor is deformed or dirty.
 - Surrounding brightness levels are equal to those of headlights, tail lights or fog lights.
 - Vehicles ahead have headlights that are either switched off, dirty, are changing color, or have are not aimed properly.
 - When driving through an area of intermittently changing brightness and darkness.
 - When frequently and repeatedly driving ascending/descending roads, or roads with rough, bumpy or uneven surfaces (such as stone-paved roads, gravel tracks etc.).
 - When frequently and repeatedly taking curves or driving on a winding road.
 - There is a highly reflective object ahead of the vehicle, such as a sign or a mirror.
 - The vehicle's headlights are damaged or dirty.
 - The vehicle is listing or tilting, due to a flat tire etc.
 - The driver believes that the high beam may be causing problems or distress to other drivers or pedestrians nearby.

■ **If the Automatic High Beam indicator flashes**

It may indicate a malfunction in the system. Contact your Toyota dealer.

■ **Customization**

The automatic high beam can be deactivated.
(Customizable feature: →P. 455)

 **CAUTION**

■ **Limitations of the Automatic High Beam**

Do not rely on the Automatic High Beam. Always drive safely, taking care to observe your surroundings and turning high beam on or off manually if necessary.

 NOTICE

■ **Notes when using the Automatic High Beam system**

Observe the following to ensure that the Automatic High Beam functions correctly.

- Do not touch the camera sensor.

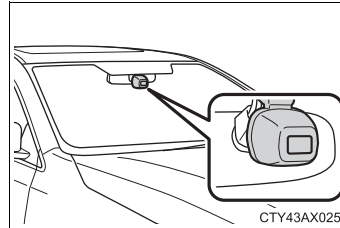

- Do not subject the inside rear view mirror or the camera sensor to a strong impact.
- Do not disassemble the camera sensor.
- Do not spill liquid onto the inside rear view mirror or the camera sensor.
- Do not apply window tinting or stickers to the camera sensor or the area of windshield near the camera sensor.
- Do not place items on the dashboard. There is a possibility that the camera sensor will mistake items reflected in the windshield for streetlights, the headlights of other vehicles, etc.
- Do not install a parking tag or any other accessories near or around the inside rear view mirror and the camera sensor.
- Do not overload the vehicle.
- Do not modify the vehicle.
- Do not replace windshield with non-genuine windshield.
Contact your Toyota dealer.

Fog light switch*

The fog lights secure excellent visibility in difficult driving conditions, such as in rain and fog.

► Type A

- ① OFF Turns the front fog lights off
- ②  Turns the front fog lights on

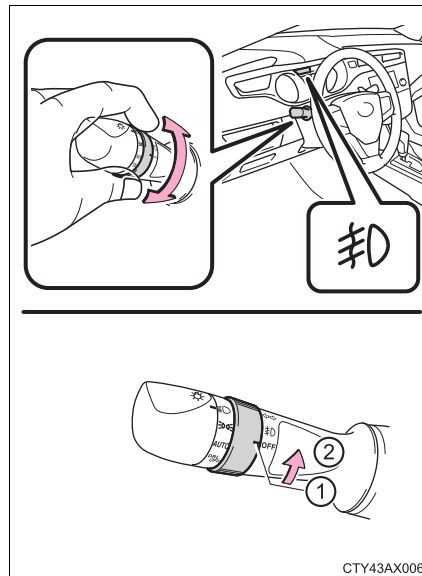

4

Driving

*: If equipped

► Type B

- ① ○ Turns the front fog lights off
- ②  Turns the front fog lights on

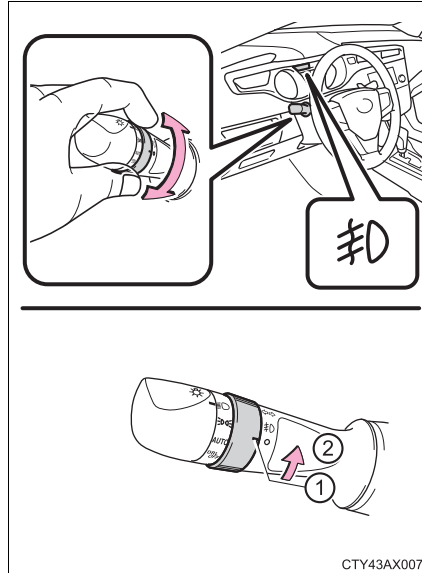

■ **Fog lights can be used when**

The headlights are on in low beam.

Windshield wipers and washer

Intermittent wiper with interval adjuster (if equipped)

► Type A

Wiper intervals can be adjusted for intermittent operation (when INT is selected).

- ① INT Intermittent wiper operation
- ② LO Low speed wiper operation
- ③ HI High speed wiper operation
- ④ MIST Temporary operation

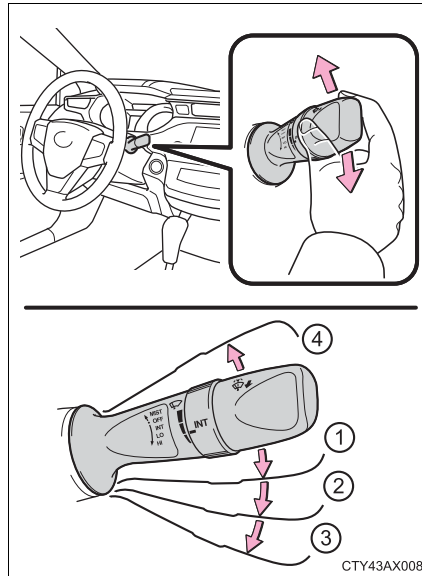



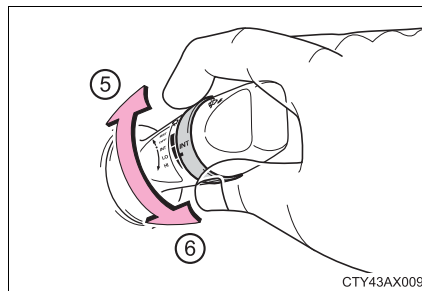

- ⑤ Increases the intermittent windshield wiper frequency
- ⑥ Decreases the intermittent windshield wiper frequency



► Type B

Wiper intervals can be adjusted for intermittent operation (when  is selected).

- ①  Intermittent wiper operation
- ②  Low speed wiper operation
- ③  High speed wiper operation
- ④  Temporary operation

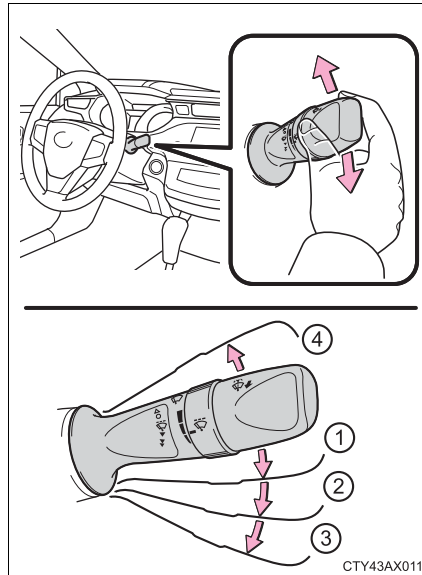

- ⑤ Increases the intermittent windshield wiper frequency
- ⑥ Decreases the intermittent windshield wiper frequency

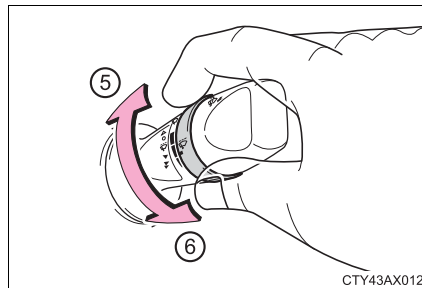

■ Washer/wiper dual operation

Wipers will automatically operate a couple of times after the washer squirts.

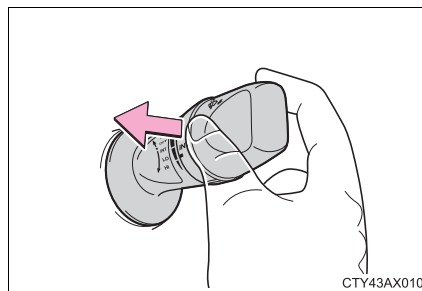

Rain-sensing windshield wipers (if equipped)

► Type A

With “AUTO” selected, the wipers will operate automatically when the sensor detects falling rain. The system automatically adjusts wiper timing in accordance with rain volume and vehicle speed.

- ① **AUTO** Rain-sensing wiper operation
- ② **LO** Low speed wiper operation
- ③ **HI** High speed wiper operation
- ④ **MIST** Temporary operation

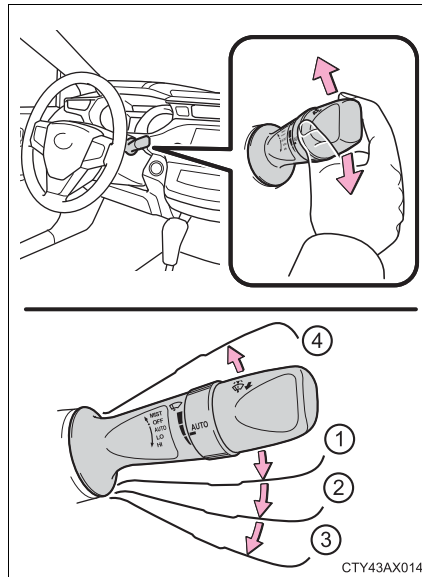

- ⑤ Increases the sensitivity
- ⑥ Decreases the sensitivity

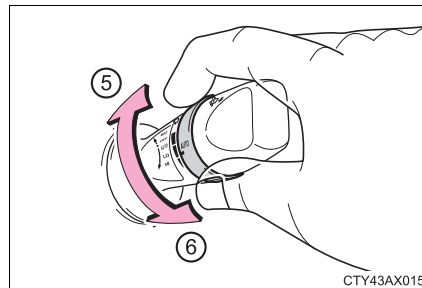

► Type B

With “AUTO” selected, the wipers will operate automatically when the sensor detects falling rain. The system automatically adjusts wiper timing in accordance with rain volume and vehicle speed.

- ① **AUTO** Rain-sensing wiper operation
- ② ▼ Low speed wiper operation
- ③ ▼ High speed wiper operation
- ④ ▲ Temporary operation

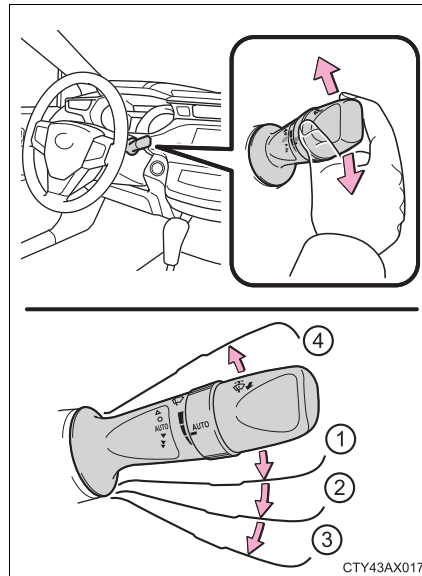

- ⑤ Increases the sensitivity
- ⑥ Decreases the sensitivity

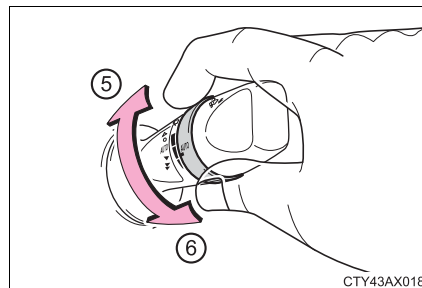

■ **Washer/wiper dual operation**

Wipers will automatically operate a couple of times after the washer squirts.

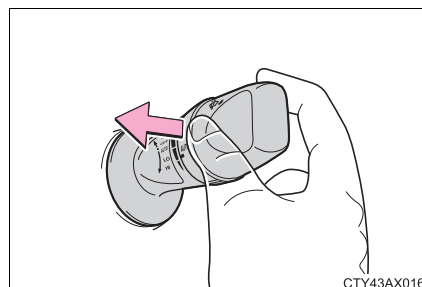

■ The windshield wiper and washer can be operated when

The engine switch is in IGNITION ON mode.

■ Effects of vehicle speed on wiper operation (vehicles with rain-sensing windshield wipers)

With low speed windshield wiper operation selected, wiper operation will be switched from low speed to intermittent wiper operation only when the vehicle is stationary.

■ Raindrop sensor (vehicles with rain-sensing windshield wipers)

- The raindrop sensor judges the amount of raindrops.

An optical sensor is adopted. It may not operate properly when sunlight from the rising or setting of the sun intermittently strikes the windshield, or if bugs etc. are present on the windshield.

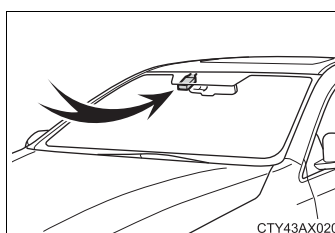

- If the wiper is turned to AUTO mode while the engine switch is in IGNITION ON mode, the wipers will operate once to show that AUTO mode is activated.
- If the temperature of the raindrop sensor is 194°F (90°C) or higher, or 14°F (-10°C) or lower, automatic operation may not occur. In this case, operate the wipers in any mode other than AUTO mode.

■ If no windshield washer fluid sprays

Check that the washer nozzles are not blocked if there is washer fluid in the windshield washer fluid reservoir.

 CAUTION

■ **Caution regarding the use of windshield wipers in AUTO mode (vehicles with rain-sensing windshield wipers)**

The windshield wipers may operate unexpectedly if the sensor is touched or the windshield is subject to vibration in AUTO mode. Take care that your fingers or anything else do not become caught in the windshield wipers.

■ **Caution regarding the use of washer fluid**

When it is cold, do not use the washer fluid until the windshield becomes warm. The fluid may freeze on the windshield and cause low visibility. This may lead to an accident, resulting in death or serious injury.

 NOTICE

■ **When the windshield is dry**

Do not use the wipers, as they may damage the windshield.

■ **When there is no washer fluid spray from the nozzle**

Damage to the washer fluid pump may be caused if the lever is pulled toward you and held continually.

■ **When a nozzle becomes blocked**

In this case, contact your Toyota dealer.

Do not try to clear it with a pin or other object. The nozzle will be damaged.

Opening the fuel tank cap

Perform the following steps to open the fuel tank cap:

Before refueling the vehicle

- Close all the doors and windows, and turn the engine switch off.
- Confirm the type of fuel.

■ **Fuel types**

Use unleaded gasoline (Octane rating 87 [Research Octane Number 91] or higher)

 CAUTION**■ When refueling the vehicle**

Observe the following precautions while refueling the vehicle. Failure to do so may result in death or serious injury.

- After exiting the vehicle and before opening the fuel door, touch an unpainted metal surface to discharge any static electricity. It is important to discharge static electricity before refueling because sparks resulting from static electricity can cause fuel vapors to ignite while refueling.
- Always hold the grips on the fuel tank cap and turn it slowly to remove it. A whooshing sound may be heard when the fuel tank cap is loosened. Wait until the sound cannot be heard before fully removing the cap. In hot weather, pressurized fuel may spray out the filler neck and cause injury.
- Do not allow anyone that has not discharged static electricity from their body to come close to an open fuel tank.
- Do not inhale vaporized fuel.
Fuel contains substances that are harmful if inhaled.
- Do not smoke while refueling the vehicle.
Doing so may cause the fuel to ignite and cause a fire.
- Do not return to the vehicle or touch any person or object that is statically charged.
This may cause static electricity to build up, resulting in a possible ignition hazard.

■ When refueling

Observe the following precautions to prevent fuel overflowing from the fuel tank:

- Securely insert the fuel nozzle into the fuel filler neck.
- Stop filling the tank after the fuel nozzle automatically clicks off.
- Do not top off the fuel tank.

 NOTICE**■ Refueling**

Do not spill fuel during refueling.

Doing so may damage the vehicle, such as causing the emission control system to operate abnormally or damaging fuel system components or the vehicle's painted surface.

Opening the fuel tank cap

- 1 With the doors unlocked, press the center of the rear edge of the fuel filler door.

Push until you hear a click and take your hand away to slightly open the fuel filler door. Then open the door fully by hand.

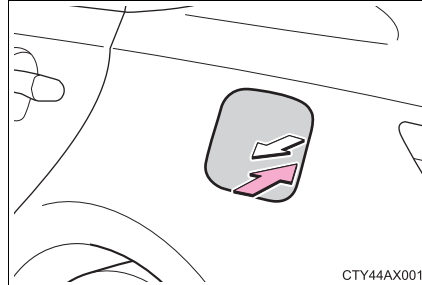

- 2 Turn the fuel tank cap slowly to open.

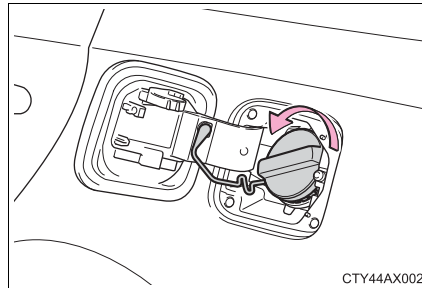

- 3 Hang the fuel tank cap on the back of the fuel filler door.

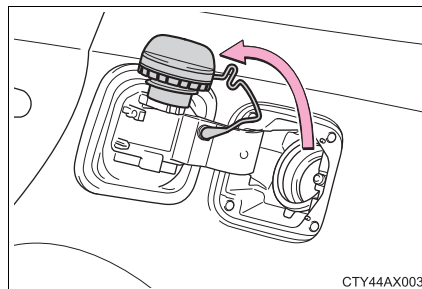

■ **If the fuel filler door cannot be opened**

Remove the cover inside the trunk and pull the lever to unlock the fuel filler door. Then press the center of the rear edge of the fuel filler door to open it.

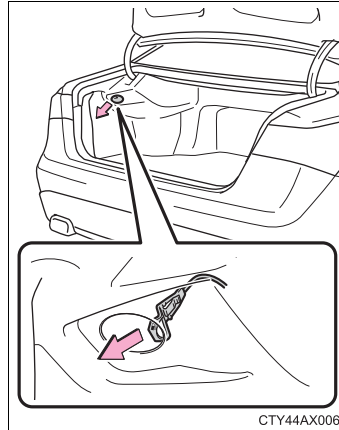

Closing the fuel tank cap

- 1 After refueling, turn the fuel tank cap until you hear a click. Once the cap is released, it will turn slightly in the opposite direction.

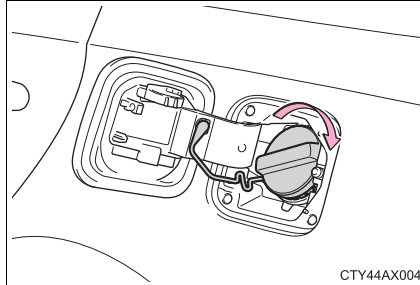

- 2 Close the fuel filler door, and press the center of the rear edge of the fuel filler door until you hear a click.

When you lock the doors, the fuel filler door will lock also.

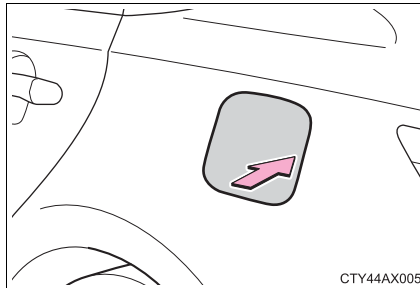

4

Driving

Fuel filler door lock condition

The fuel filler door may not be locked even when the vehicle's doors are locked in the following conditions:

- When operating the door lock button inside the vehicle
- When the automatic door locking system is operated (→P. 113)
- When the fuel filler door is closed after the vehicle's doors are locked

CAUTION

When replacing the fuel tank cap

Do not use anything but a genuine Toyota fuel tank cap designed for your vehicle. Doing so may cause a fire or other incident which may result in death or serious injury.

Cruise control*

Summary of functions

Use the cruise control to maintain a set speed without depressing the accelerator pedal.

- ① Display
- ② Indicators
- ③ Set speed
- ④ Cruise control switch

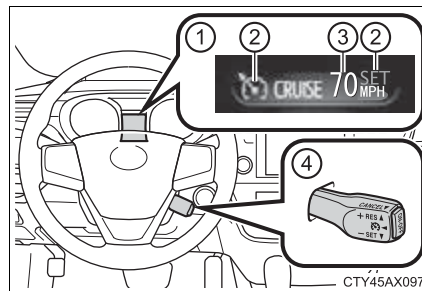

Setting the vehicle speed

- 1 Press the "ON-OFF" button to activate the cruise control.
Cruise control indicator will be displayed.
Press the button again to deactivate the cruise control.

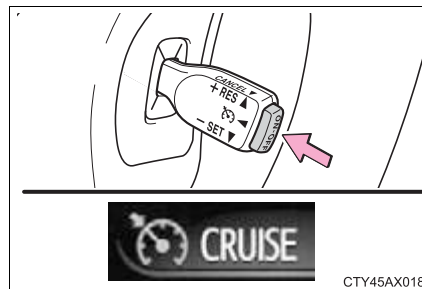

- 2 Accelerate or decelerate the vehicle to the desired speed, and push the lever down to set the speed.
"SET" indicator will be displayed.
The vehicle speed at the moment the lever is released becomes the set speed.

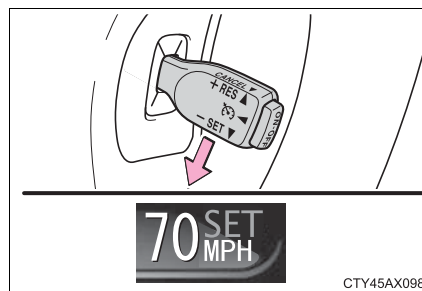

*: If equipped

Adjusting the set speed

To change the set speed, operate the lever until the desired set speed is obtained.

- ① Increases the speed
- ② Decreases the speed

Fine adjustment: Momentarily move the lever in the desired direction.

Large adjustment: Hold the lever in the desired direction.

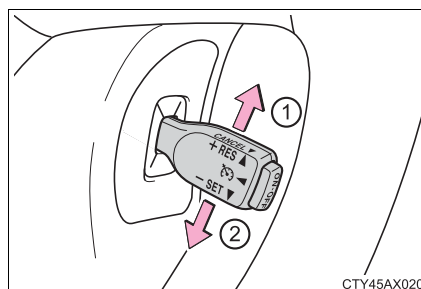

The set speed will be increased or decreased as follows:

- When the set speed is shown in "MPH"

Fine adjustment: By approximately 1 mph (1.6 km/h) each time the lever is operated.

Large adjustment: The set speed can be increased or decreased continually until the lever is released.

- When the set speed is shown in "km/h"

Fine adjustment: By approximately 0.6 mph (1 km/h) each time the lever is operated

Large adjustment: The set speed can be increased or decreased continually until the lever is released.

Canceling and resuming the constant speed control

- ① Pulling the lever toward you cancels the constant speed control.

The speed setting is also canceled when the brakes are applied.

- ② Pushing the lever up resumes the constant speed control.

Resuming is available when the vehicle speed is more than approximately 25 mph (40 km/h).



■ **Cruise control can be set when**

- The shift lever is in D or range 4 or higher of S has been selected.
- Range 4 or higher of D has been selected by using the paddle shift.
- Vehicle speed is above approximately 25 mph (40 km/h).

■ **Accelerating after setting the vehicle speed**

- The vehicle can be accelerated normally. After acceleration, the set speed resumes.
- Even without canceling the cruise control, the set speed can be increased by first accelerating the vehicle to the desired speed and then pushing the lever down to set the new speed.

■ **Automatic cruise control cancelation**

Cruise control will stop maintaining the vehicle speed in any of the following situations.

- Actual vehicle speed falls more than approximately 10 mph (16 km/h) below the preset vehicle speed.
At this time, the memorized set speed is not retained.
- Actual vehicle speed is below approximately 25 mph (40 km/h).
- VSC is activated.

■ **If the warning message for the cruise control is shown on the multi-information display**

Press the "ON-OFF" button once to deactivate the system, and then press the button again to reactivate the system.

If the cruise control speed cannot be set or if the cruise control cancels immediately after being activated, there may be a malfunction in the cruise control system. Have the vehicle inspected by your Toyota dealer.

 CAUTION**■ To avoid operating the cruise control by mistake**

Switch the cruise control off using the “ON-OFF” button when not in use.

■ Situations unsuitable for cruise control

Do not use cruise control in any of the following situations.

Doing so may result in loss of control and could cause an accident resulting in death or serious injury.

- In heavy traffic
- On roads with sharp bends
- On winding roads
- On slippery roads, such as those covered with rain, ice or snow
- On steep hills
Vehicle speed may exceed the set speed when driving down a steep hill.
- During emergency towing

Dynamic radar cruise control*

Summary of functions

Dynamic radar cruise control supplements conventional cruise control with a vehicle-to-vehicle distance control. In vehicle-to-vehicle distance control mode, the vehicle automatically accelerates or decelerates in order to maintain a set following distance from vehicles ahead.

- ① Vehicle-to-vehicle distance button
- ② Display
- ③ Indicators
- ④ Set speed
- ⑤ Cruise control switch

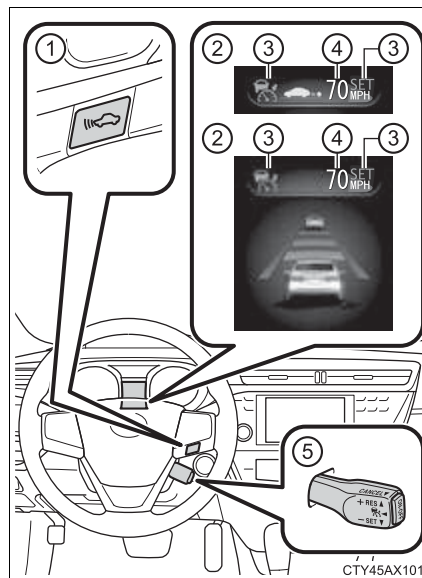

*: If equipped

Setting the vehicle speed (vehicle-to-vehicle distance control mode)

- 1 Press the "ON-OFF" button to activate the cruise control.

Radar cruise control indicator will be displayed.

Press the button again to deactivate the cruise control.

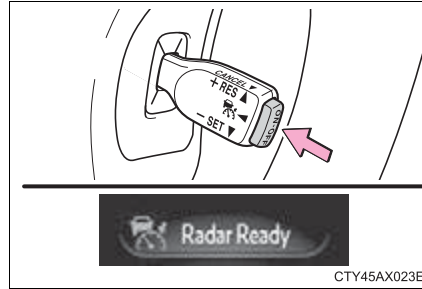

- 2 Accelerate or decelerate the vehicle to the desired speed, and push the lever down to set the speed.

"SET" indicator will be displayed.

The vehicle speed at the moment the lever is released becomes the set speed.

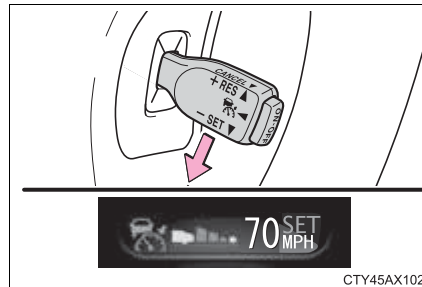

Adjusting the set speed

To change the set speed, operate the lever until the desired set speed is displayed.

- ① Increases the speed
- ② Decreases the speed

Fine adjustment: Momentarily move the lever in the desired direction.

Large adjustment: Hold the lever in the desired direction.

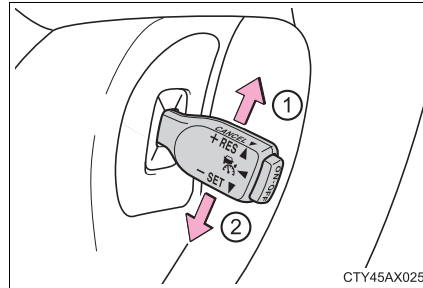

In the vehicle-to-vehicle distance control mode, the set speed will be increased or decreased as follows:

- When the set speed is shown in “MPH”

Fine adjustment: By approximately 1 mph (1.6 km/h) each time the lever is operated

Large adjustment: By approximately 5 mph (8 km/h) for each 0.75 seconds the lever is held

- When the set speed is shown in “km/h”

Fine adjustment: By approximately 0.6 mph (1 km/h) each time the lever is operated

Large adjustment: By approximately 3.1 mph (5 km/h) for each 0.75 seconds the lever is held

In the constant speed control mode (→P. 205), the set speed will be increased or decreased as follows:

Fine adjustment: By approximately 1 mph (1.6 km/h) each time the lever is operated

Large adjustment: The set speed can be increased or decreased continually until the lever is released.

Changing the vehicle-to-vehicle distance

Pressing the button changes the vehicle-to-vehicle distance as follows:

- ① Long
- ② Medium
- ③ Short

The vehicle-to-vehicle distance is set automatically to long mode when the engine switch is turned to IGNITION ON mode.

If a vehicle is running ahead of you, the preceding vehicle mark will also be displayed.

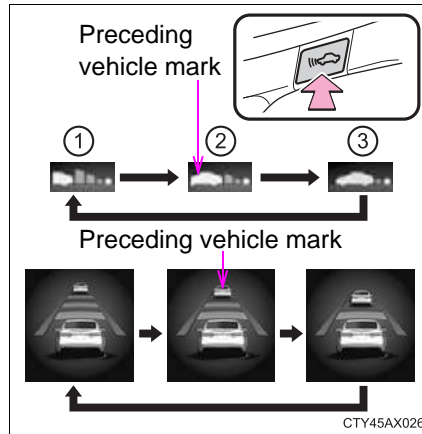

Vehicle-to-vehicle distance settings

Select a distance from the table below. Note that the distances shown correspond to a vehicle speed of 50 mph (80 km/h). Vehicle-to-vehicle distance increases/decreases in accordance with vehicle speed.

Distance options	Vehicle-to-vehicle distance
Long	Approximately 160 ft. (50 m)
Medium	Approximately 130 ft. (40 m)
Short	Approximately 100 ft. (30 m)

Canceling and resuming the speed control

- ① Pulling the lever toward you cancels the cruise control.
The speed setting is also canceled when the brakes are applied.
- ② Pushing the lever up resumes the cruise control and returns vehicle speed to the set speed.
Resuming is available when the vehicle speed is more than approximately 25 mph (40 km/h).

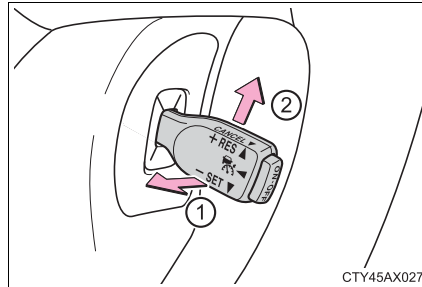

Driving in vehicle-to-vehicle distance control mode

This mode employs a radar sensor to detect the presence of vehicles up to approximately 400 ft. (120 m) ahead, determines the current vehicle-to-vehicle following distance, and operates to maintain a suitable following distance from the vehicle ahead.

Note that vehicle-to-vehicle distance will close in when traveling on long downhill slopes.

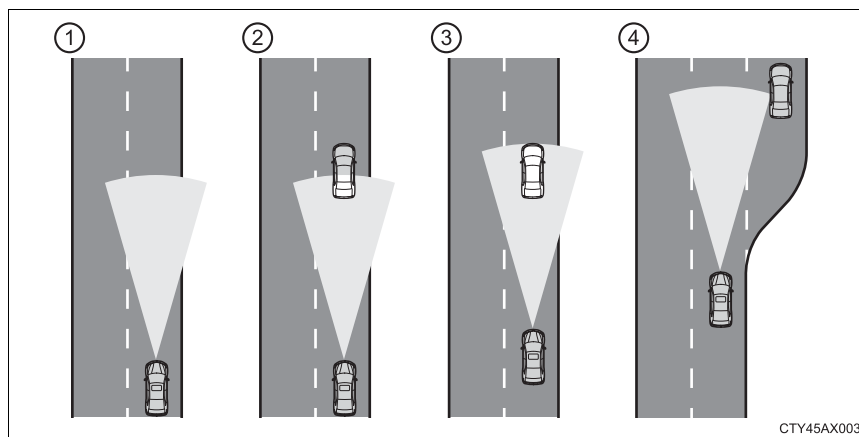

① Example of constant speed cruising

When there are no vehicles ahead

The vehicle travels at the speed set by the driver. The desired vehicle-to-vehicle distance can also be set by operating the vehicle-to-vehicle distance control.

② Example of deceleration cruising

When the vehicle ahead is driving slower than the set speed

When a vehicle is detected running ahead of you, the system automatically decelerates your vehicle. When a greater reduction in vehicle speed is necessary, the system applies the brakes. A warning tone warns you when the system cannot decelerate sufficiently to prevent your vehicle from closing in on the vehicle ahead.

③ Example of follow-up cruising

When following a vehicle driving slower than the set speed

The system continues follow-up cruising while adjusting for changes in the speed of the vehicle ahead in order to maintain the vehicle-to-vehicle distance set by the driver.

④ Example of acceleration

When there are no longer any vehicles ahead driving slower than the set speed

The system accelerates until the set speed is reached. The system then returns to constant speed cruising.

Approach warning

When your vehicle is too close to a vehicle ahead, and sufficient automatic deceleration via the cruise control is not possible, the display will flash and the buzzer will sound to alert the driver. An example of this would be if another driver cuts in front of you while you are following a vehicle. Apply the brakes to ensure an appropriate vehicle-to-vehicle distance.

■ Warnings may not occur when

In the following instances, there is a possibility that the warnings will not occur:

- When the speed of the vehicle ahead matches or exceeds your vehicle speed
- When the vehicle ahead is traveling at an extremely slow speed
- Immediately after the cruise control speed was set
- At the instant the accelerator is applied

Selecting conventional constant speed control mode

When constant speed control mode is selected, your vehicle will maintain a set speed without controlling the vehicle-to-vehicle distance. Select this mode only when vehicle-to-vehicle distance control mode does not function correctly due to dirt etc.

- ① Press the "ON-OFF" button to activate the cruise control.

Press the button again to deactivate the cruise control.

- ② Switch to constant speed control mode.

(Push the lever forward and hold for approximately one second.)

Constant speed control mode indicator will come on.

When in constant speed control mode, to return to vehicle-to-vehicle distance control mode, push the lever forward again and hold for approximately 1 second.

After the desired speed has been set, it is not possible to return to vehicle-to-vehicle distance control mode.

If the engine switch is turned off and then turned to IGNITION ON mode again, the vehicle will automatically return to vehicle-to-vehicle distance control mode.

Adjusting the speed setting:

→P. 195

Canceling and resuming the speed setting: →P. 195

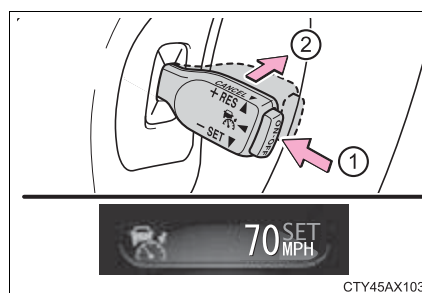

■ **Dynamic radar cruise control can be set when**

- The shift lever is in D or range 4 or higher of S has been selected.
- Range 4 or higher of D has been selected by using the paddle shift.
- Vehicle speed is above approximately 30 mph (50 km/h).

■ **Accelerating after setting the vehicle speed**

The vehicle can accelerate normally. After acceleration, the set speed resumes. However, during vehicle-to-vehicle distance control mode, the vehicle speed may decrease below the set speed in order to maintain the distance to the vehicle ahead.

■ **Automatic cancelation of vehicle-to-vehicle distance control**

Vehicle-to-vehicle distance control driving is automatically canceled in the following situations:

- Actual vehicle speed falls below approximately 25 mph (40 km/h).
- VSC is activated.
- The sensor cannot operate correctly because it is covered in some way.
- The windshield wipers are operating at high speed (when the wipers are in AUTO mode [rain-sensing windshield wipers] or the high speed wiper operation).

If vehicle-to-vehicle distance control driving is automatically canceled for any other reason, there may be a malfunction in the system. Contact your Toyota dealer.

■ Automatic cancelation of constant speed control

The cruise control will stop maintaining the vehicle speed in the following situations:

- Actual vehicle speed is more than approximately 10 mph (16 km/h) below the set vehicle speed.

At this time, the memorized set speed is not retained.

- Vehicle speed falls below approximately 25 mph (40 km/h).
- VSC is activated.

■ Radar sensor and grille cover

Always keep the sensor and grille cover clean to ensure that the vehicle-to-vehicle distance control operates properly. (Some obstructions, such as snow, ice and plastic objects, cannot be detected by the obstruction sensor.)

Dynamic radar cruise control is canceled if an obstruction is detected.

- ① Grille cover
- ② Radar sensor

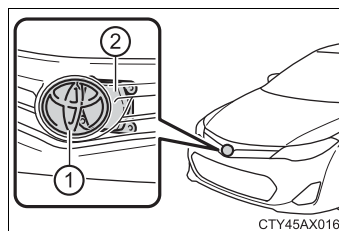

■ Warning messages and buzzers for dynamic radar cruise control

Warning messages and buzzers are used to indicate a system malfunction or to inform the driver of the need for caution while driving. The following actions may solve the problem.

- When a message indicating to perform system check is displayed:
Press the "ON-OFF" button once to deactivate the system, and then press the button again to reactivate the system.
- When a message indicating to clean the radar sensor is displayed:
Dirt, ice, etc. is on the radar sensor surface. Clean the sensor.
- When a message indicating that the cruise control is not available is displayed:
If the wipers are operating at high speed (including when the wiper switch is in the AUTO position), the radar cruise control is not available. Use the cruise control when it is possible to drive without operating the wipers at high speed.

If the warning message remains on even after the above actions have been performed, the system may be malfunctioning. Have the vehicle inspected by your Toyota dealer.

■ **Certification**

- ▶ For vehicles sold in the U.S.A.

FCC ID: HYQDNMWR004

This device complies with part 15 of the FCC Rules. Operation is subject to the following two conditions: (1) This device may not cause harmful interference, and (2) this device must accept any interference received, including interference that may cause undesired operation.

FCC WARNING

Changes or modifications not expressly approved by the party responsible for compliance could void the user's authority to operate the equipment.

Radiofrequency radiation exposure Information:

This equipment complies with FCC radiation exposure limits set forth for an uncontrolled environment.

This equipment should be installed and operated with minimum distance of 20 cm between the radiator (antenna) and your body.

This transmitter must not be co-located or operating in conjunction with any other antenna or transmitter.

- ▶ For vehicles sold in Canada

This device complies with Industry Canada licence-exempt RSS standard(s).

Operation is subject to the following two conditions: (1) this device may not cause interference, and (2) this device must accept any interference, including interference that may cause undesired operation of the device.

 CAUTION**■ Before using dynamic radar cruise control**

Do not overly rely on vehicle-to-vehicle distance control.

Be aware of the set speed. If automatic deceleration/acceleration is not appropriate, adjust the vehicle speed, as well as the distance between your vehicle and vehicles ahead by applying the brakes etc.

■ Cautions regarding the driving assist systems

Observe the following precautions.

Failure to do so may cause an accident resulting in death or serious injury.

● Assisting the driver to measure following distance

The dynamic radar cruise control is only intended to help the driver in determining the following distance between the driver's own vehicle and a designated vehicle traveling ahead. It is not a mechanism that allows careless or inattentive driving, and it is not a system that can assist the driver in low-visibility conditions. It is still necessary for driver to pay close attention to the vehicle's surroundings.

● Assisting the driver to judge proper following distance

The dynamic radar cruise control determines whether the following distance between the driver's own vehicle and a designated vehicle traveling ahead is appropriate or not. It is not capable of making any other type of judgement. Therefore, it is absolutely necessary for the driver to remain vigilant and to determine whether or not there is a possibility of danger in any given situation.

● Assisting the driver to operate the vehicle

The dynamic radar cruise control has no capability to prevent or avoid a collision with a vehicle traveling ahead. Therefore, if there is ever any danger, the driver must take immediate and direct control of the vehicle and act appropriately in order to ensure the safety of all involved.

 CAUTION

■ **To avoid inadvertent cruise control activation**

Switch the cruise control off using the “ON-OFF” button when not in use.

■ **Situations unsuitable for dynamic radar cruise control**

Do not use dynamic radar cruise control in any of the following situations. Doing so may result in inappropriate speed control and could cause an accident resulting in death or serious injury.

- In heavy traffic
- On roads with sharp bends
- On winding roads
- On slippery roads, such as those covered with rain, ice or snow
- On steep downhills, or where there are sudden changes between sharp up and down gradients
Vehicle speed may exceed the set speed when driving down a steep hill.
- At entrances to expressways
- When weather conditions are bad enough that they may prevent the sensors from functioning correctly (fog, snow, sandstorm, heavy rain, etc.)
- When an approach warning buzzer is heard often

 CAUTION**■ When the sensor may not be correctly detecting the vehicle ahead**

Apply the brakes as necessary when any of the following types of vehicles are in front of you.

As the sensor may not be able to correctly detect these types of vehicles, the approach warning (→P. 204) will not be activated, and a fatal or serious accident may result.

- Vehicles that cut in suddenly
- Vehicles traveling at low speeds
- Vehicles that are not moving
- Vehicles with small rear ends (trailers with no load on board etc.)
- Motorcycles traveling in the same lane

■ Conditions under which the vehicle-to-vehicle distance control may not function correctly

Apply the brakes as necessary in the following conditions as the radar sensor may not be able to correctly detect vehicles ahead, and a fatal or serious accident may result:

- When water or snow thrown up by the surrounding vehicles hinders the functioning of the sensor
- When your vehicle is pointing upwards (caused by a heavy load in the trunk etc.)
- When the road curves or when the lanes are narrow
- When steering wheel operation or your position in the lane is unstable
- When the vehicle ahead of you decelerates suddenly

 CAUTION**■ Handling the radar sensor**

Observe the following to ensure the cruise control system can function effectively.

Otherwise, the system may not function correctly and could result in an accident.

- Keep the sensor and grille cover clean at all times.
Clean the sensor and grille cover with a soft cloth so you do not mark or damage them.
- Do not subject the sensor or surrounding area to a strong impact.
If the sensor moves even slightly off position, the system may malfunction.
If the sensor or surrounding area is subject to a strong impact, always have the area inspected and adjusted by your Toyota dealer.
- Do not disassemble the sensor.
- Do not attach accessories or stickers to the sensor, grille cover or surrounding area.
- Do not modify or paint the sensor and grille cover.
- Do not replace them with non-genuine parts.

Driving mode select switches

The driving modes can be selected to suit driving condition.

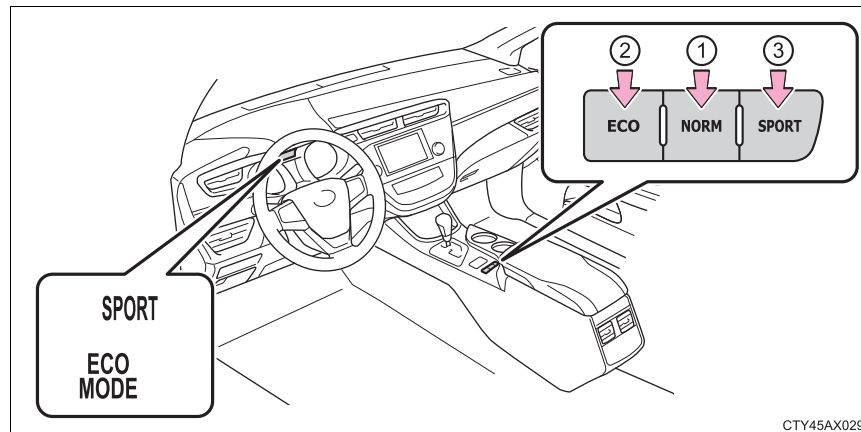

① Normal mode

Use for normal driving.

While in Eco drive mode or sport mode, press the switch to change the driving mode to normal mode.

② Eco drive mode

Use Eco drive mode to help achieve low fuel consumption during trips that involve frequent accelerating.

When the "ECO" switch is pressed, the "ECO MODE" indicator comes on in the instrument cluster.

③ Sport mode

Use sport mode when increased acceleration response and precise handling is desired, for example, when driving on mountain roads.

When the "SPORT" switch is pressed, the "SPORT" indicator comes on in the instrument cluster.

■ **Operation of the air conditioning system in Eco drive mode**

Eco drive mode controls the heating/cooling operations and fan speed of the air conditioning system to enhance fuel efficiency (→P. 242). To improve air conditioning performance, adjust the fan speed or turn off Eco drive mode.

■ **Sport mode automatic deactivation**

Sport mode is automatically deactivated if the engine switch is turned off after driving in sport mode.

Driving assist systems

To help enhance driving safety and performance, the following systems operate automatically in response to various driving situations. Be aware, however, that these systems are supplementary and should not be relied upon too heavily when operating the vehicle.

◆ ABS (Anti-lock Brake System)

Helps to prevent wheel lock when the brakes are applied suddenly, or if the brakes are applied while driving on a slippery road surface

◆ Brake assist

Generates an increased level of braking force after the brake pedal is depressed when the system detects a panic stop situation

◆ VSC (Vehicle Stability Control)

Helps the driver to control skidding when swerving suddenly or turning on slippery road surfaces

◆ TRAC (Traction Control)

Helps to maintain drive power and prevent the drive wheels from spinning when starting the vehicle or accelerating on slippery roads

◆ EPS (Electric Power Steering)

Employs an electric motor to reduce the amount of effort needed to turn the steering wheel

◆ PCS (Pre-Collision System) (if equipped)

→P. 220

◆ BSM (Blind Spot Monitor) (if equipped)

→P. 227

When the TRAC/VSC systems are operating

The slip indicator light will flash while the TRAC/VSC systems are operating.

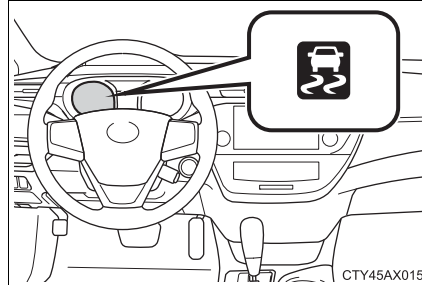

Disabling the TRAC system

If the vehicle gets stuck in mud, dirt or snow, the TRAC system may reduce power from the engine to the wheels. Pressing the switch to turn the system off may make it easier for you to rock the vehicle in order to free it.

To turn the TRAC system off, quickly press and release the switch.

The "TRAC OFF" indicator light should come on and message will be shown on the multi-information display.

Press the switch again to turn the system back on.

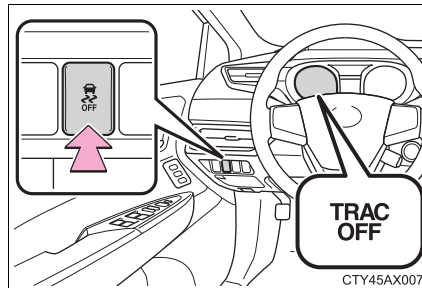

■ Turning off both TRAC/VSC systems

To turn the TRAC/VSC systems off, press and hold the switch for more than 3 seconds while the vehicle is stopped.

The VSC OFF and “TRAC OFF” indicator lights will come on and the message will be shown on the multi-information display.

Press the switch again to turn the systems back on.

■ When the message is displayed on the multi-information display showing that TRAC has been disabled and “TRAC OFF” indicator light comes on even if the TRAC/VSC OFF switch has not been pressed

TRAC cannot be operated. Contact your Toyota dealer.

■ Sounds and vibrations caused by the ABS, brake assist, VSC and TRAC systems

● A sound may be heard from the engine compartment when the brake pedal is depressed repeatedly, when the engine is started or just after the vehicle begins to move. This sound does not indicate that a malfunction has occurred in any of these systems.

● Any of the following conditions may occur when the above systems are operating. None of these indicates that a malfunction has occurred.

- Vibrations may be felt through the vehicle body and steering.
- A motor sound may be heard after the vehicle comes to a stop.
- The brake pedal may pulsate slightly after the ABS is activated.
- The brake pedal may move down slightly after the ABS is activated.

■ EPS operation sound

When the steering wheel is operated, a motor sound (whirring sound) may be heard. This does not indicate a malfunction.

■ Automatic reactivation of TRAC and VSC systems

After turning the TRAC and VSC systems off, the systems will be automatically re-enabled in the following situations:

● When the engine switch is turned off

● If only the TRAC system is turned off, the TRAC will turn on when vehicle speed increases

If both the TRAC and VSC systems are turned off, automatic re-enabling will not occur when vehicle speed increases.

■ Reduced effectiveness of the EPS system

The effectiveness of the EPS system is reduced to prevent the system from overheating when there is frequent steering input over an extended period of time. The steering wheel may feel heavy as a result. Should this occur, refrain from excessive steering input or stop the vehicle and turn the engine off. The effectiveness of the EPS system will be restored after a short while.

 **CAUTION****■ The ABS does not operate effectively when**

- The limits of tire gripping performance have been exceeded (such as excessively worn tires on a snow covered road).
- The vehicle hydroplanes while driving at high speed on wet or slick roads.

■ Stopping distance when the ABS is operating may exceed that of normal conditions

The ABS is not designed to shorten the vehicle's stopping distance. Always maintain a safe distance from the vehicle in front of you, especially in the following situations:

- When driving on dirt, gravel or snow-covered roads
- When driving with tire chains
- When driving over bumps in the road
- When driving over roads with potholes or uneven surfaces

■ TRAC may not operate effectively when

Directional control and power may not be achievable while driving on slippery road surfaces, even if the TRAC system is operating.

Drive the vehicle carefully in conditions where stability and power may be lost.

■ When the VSC is activated

The slip indicator light flashes. Always drive carefully. Reckless driving may cause an accident. Exercise particular care when the indicator light flashes.

■ When the TRAC/VSC systems are turned off

Be especially careful and drive at a speed appropriate to the road conditions. As these are the systems to help ensure vehicle stability and driving force, do not turn the TRAC/VSC systems off unless necessary.

 **CAUTION****■ Replacing tires**

Make sure that all tires are of the specified size, brand, tread pattern and total load capacity. In addition, make sure that the tires are inflated to the recommended tire inflation pressure level.

The ABS, TRAC and VSC systems will not function correctly if different tires are installed on the vehicle.

Contact your Toyota dealer for further information when replacing tires or wheels.

■ Handling of tires and the suspension

Using tires with any kind of problem or modifying the suspension will affect the driving assist systems, and may cause a system to malfunction.

PCS (Pre-Collision System)*

When the radar sensor detects possibility of a frontal collision, the pre-collision system such as the brakes and seat belts are automatically engaged to lessen impact as well as vehicle damage.

The pre-collision system can be turned on and off as necessary by operating the switch. (→P. 221)

◆ Pre-collision seat belts (front seats only)

If the pre-collision sensor detects that a collision is unavoidable, the pre-collision system will retract the seat belt before the collision occurs.

The same will happen if the driver makes an emergency braking or loses control of the vehicle. (→P. 29)

However, when the VSC system is disabled, the system will not operate in the event of skidding.

◆ Pre-collision brake assist

When there is a high possibility of a frontal collision, the system applies greater braking force in relation to how strongly the brake pedal is depressed.

◆ Pre-collision braking

When there is a high possibility of a frontal collision, the system warns the driver using a warning light, warning display and buzzer. If the system determines that a collision is unavoidable, the brakes are automatically applied to reduce the collision speed.

*: If equipped

Disabling pre-collision system

- ① Enabled
- ② Disabled

The “PCS” warning light turns on when pre-collision system is disabled.

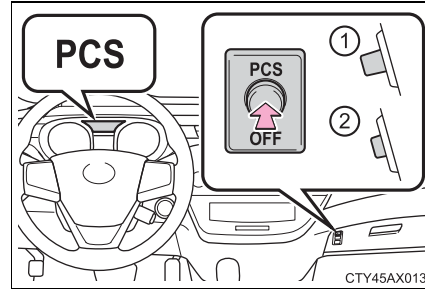

Radar sensor

The radar sensor detects vehicles or other obstacles on or near the road ahead and determines whether a collision is imminent based on the position, speed, and heading of the obstacles.

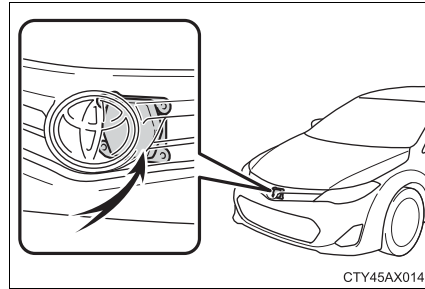

■ **The pre-collision system is operational when**

The pre-collision system off switch is not pressed and the following conditions are met:

- Pre-collision seat belts (operating conditions A):
 - Vehicle speed is greater than about 19 mph (30 km/h).
 - The system detects sudden braking or skidding.
 - The front occupants are wearing a seat belt.
- Pre-collision seat belts (operating conditions B):
 - Vehicle speed is greater than about 4 mph (5 km/h).
 - The speed at which your vehicle is approaching the obstacle or the vehicle running ahead of you is greater than about 19 mph (30 km/h).
 - The front occupants are wearing a seat belt.
- Pre-collision brake assist:
 - Vehicle speed is greater than about 19 mph (30 km/h).
 - The speed at which your vehicle is approaching the obstacle or the vehicle running ahead of you is greater than about 19 mph (30 km/h).
 - The brake pedal is depressed.
- Pre-collision braking:
 - Vehicle speed is greater than about 10 mph (15 km/h).
 - The speed at which your vehicle is approaching the obstacle or the vehicle running ahead of you is greater than about 10 mph (15 km/h).

■ Conditions that may trigger the system even if there is no possibility of a collision

- When there is an object by the roadside at the entrance to a curve
- When passing an oncoming vehicle on a curve
- When driving over a narrow iron bridge
- When there is a metal object on the road surface
- When driving on an uneven road surface
- When passing an oncoming vehicle on a left-turn
- When your vehicle rapidly closes on the vehicle in front
- When a grade separation/interchange, sign, billboard, or other structure appears to be directly in the vehicle's line of travel
- When the steep angle of the road causes a metal object located beneath the road surface to be seen ahead of the vehicle
- When an extreme change in vehicle height occurs
- When the axis of the radar is out of adjustment
- When passing through certain toll gates
- When passing through an overpass

When the system is activated in the situations described above, there is also a possibility that the seat belts will retract quickly and the brakes will be applied with a force greater than normal. When the seat belt is locked in the retracted position, stop the vehicle in a safe place, release the seat belt and refasten it.

■ Obstacles not detected

The sensor cannot detect plastic obstacles such as traffic cones. There may also be occasions when the sensor cannot detect pedestrians, animals, bicycles, motorcycles, trees, or snowdrifts.

■ Situations in which the pre-collision system does not function properly

The system may not function effectively in situations such as the following:

- On roads with sharp bends or uneven surfaces
- If a vehicle suddenly moves in front of your vehicle, such as at an intersection
- If a vehicle suddenly cuts in front of your vehicle, such as when overtaking
- In inclement weather such as heavy rain, fog, snow or sand storms
- When your vehicle is skidding such as the VSC system off
- When your vehicle is steeply inclined
- When the axis of the radar is out of adjustment

■ **Automatic cancelation of the pre-collision system**

When a malfunction occurs due to sensor contamination, etc. that results in the sensors being unable to detect obstacles, the pre-collision system will be automatically disabled. In this case, the system will not activate even if there is a collision possibility.

■ **When there is a malfunction in the system**

“PCS” warning light will flash and warning messages will be displayed.
(→P. 390) Have the vehicle inspected by your Toyota dealer immediately.

■ **Certification**

► For vehicles sold in the U.S.A.

FCC ID: HYQDNMWR004

This device complies with part 15 of the FCC Rules. Operation is subject to the following two conditions: (1) This device may not cause harmful interference, and (2) this device must accept any interference received, including interference that may cause undesired operation.

FCC WARNING

Changes or modifications not expressly approved by the party responsible for compliance could void the user’s authority to operate the equipment.

Radiofrequency radiation exposure Information:

This equipment complies with FCC radiation exposure limits set forth for an uncontrolled environment.

This equipment should be installed and operated with minimum distance of 20 cm between the radiator (antenna) and your body.

This transmitter must not be co-located or operating in conjunction with any other antenna or transmitter.

► For vehicles sold in Canada

This device complies with Industry Canada licence-exempt RSS standard(s).

Operation is subject to the following two conditions: (1) this device may not cause interference, and (2) this device must accept any interference, including interference that may cause undesired operation of the device.

 CAUTION**■ Limitations of the pre-collision system**

Do not overly rely on the pre-collision system. Always drive safely, taking care to observe your surroundings and checking for any obstacles or other road hazards.

Failure to do so may cause an accident resulting in death or serious injury.

■ When the sensor may not be correctly detecting the vehicle ahead

Apply the brakes as necessary in any of the following situations.

- When water or snow thrown up by the surrounding vehicles hinders the functioning of the sensor
- When your vehicle is pointing upwards (caused by a heavy load in the luggage compartment etc.)
- Vehicles that cut in suddenly
- Vehicles with small rear ends (trailers with no load on board etc.)
- Motorcycles traveling in the same lane

■ Handling the radar sensor

Observe the following to ensure the pre-collision system can function effectively.

Otherwise, the system may not function correctly and could result in an accident.

- Keep the sensor and grille cover clean at all times.
Clean the sensor and grille cover with a soft cloth so you do not mark or damage them.
- Do not subject the sensor or surrounding area to a strong impact.
If the sensor moves even slightly off position, the system may become inaccurate or malfunction. If the sensor or surrounding area is subject to a strong impact, always have the area inspected and adjusted by your Toyota dealer.
- Do not disassemble the sensor.
- Do not attach accessories or stickers to the sensor, grille cover or surrounding area.
- Do not modify or paint the sensor and grille cover.
- Do not replace them with non-genuine parts.

 CAUTION**■ Cautions regarding the assist contents of the system**

By means of alarms and brake control, the pre-collision system is intended to assist the driver in avoiding collisions through the process of LOOK-JUDGE-ACT. There are limits to the degree of assistance the system can provide, so please keep in mind the following important points.

● Assisting the driver in watching the road

The pre-collision system is only able to detect obstacles directly in front of the vehicle, and only within a limited range. It is not a mechanism that allows careless or inattentive driving, and it is not a system that can assist the driver in low-visibility conditions. It is still necessary for the driver to pay close attention to the vehicle's surroundings.

● Assisting the driver in making correct judgment

When attempting to estimate the likelihood of a collision, the only data available to the pre-collision system is that from obstacles it has detected directly in front of the vehicle. Therefore, it is absolutely necessary for the driver to remain vigilant and to determine whether or not there is a possibility of collision in any given situation.

● Assisting the driver in taking action

The pre-collision system's braking assist feature is designed to help reduce the severity of a collision, and so only acts when the system has judged that a collision is unavoidable. This system by itself is not capable of automatically avoiding a collision or bringing the vehicle to a stop safely. For this reason, when encountering a dangerous situation the driver must take direct and immediate action in order to ensure the safety of all involved.

BSM (Blind Spot Monitor)*

Summary of the Blind Spot Monitor

The Blind Spot Monitor is a system that has 2 functions;

- The Blind Spot Monitor function
Assists the driver in making the decision when changing lanes
- The Rear Cross Traffic Alert function
Assists the driver when backing up

These functions use same sensors.

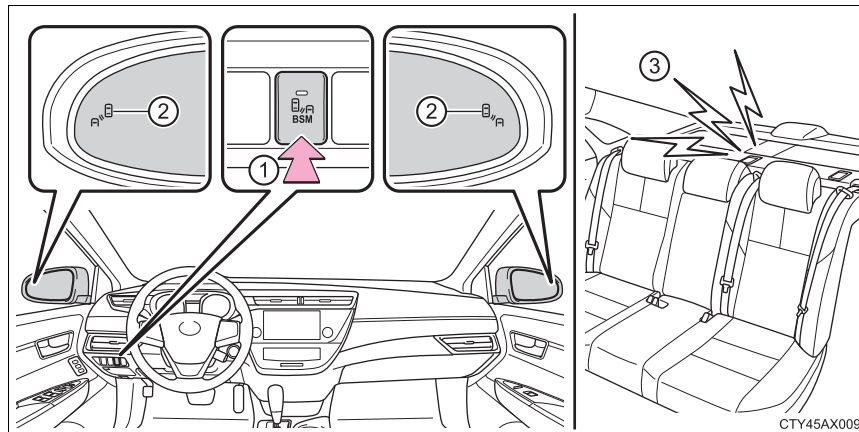

① BSM main switch

Pressing the switch turns the system on or off. When the switch is set to on, the switch's indicator illuminates. Common switch for Blind Spot Monitor function and Rear Cross Traffic Alert function.

② Outside rear view mirror indicator

Blind Spot Monitor function:

When a vehicle is detected in the blind spot, the outside rear view mirror indicator comes on while the turn signal lever is not operated and the outside rear view mirror indicator flashes while the turn signal lever is operated.

Rear Cross Traffic Alert function:

When a vehicle approaching from the right or left rear of the vehicle is detected, the outside rear view mirror indicators flash.

*: If equipped

③ **Rear Cross Traffic Alert buzzer (Rear Cross Traffic Alert function only)**

When a vehicle approaching from the right or left rear of the vehicle is detected, a buzzer sounds from behind the rear seat.

■ **The outside rear view mirror indicators visibility**

When under strong sunlight, the outside rear view mirror indicator may be difficult to see.

■ **Rear Cross Traffic Alert buzzer hearing**

Rear Cross Traffic Alert function may be difficult to hear over loud noises such as high audio volume.

■ **When there is a malfunction in the Blind Spot Monitor system**

If a system malfunction is detected due to any of the following reasons, warning messages will be displayed:

- There is a malfunction with the sensors
- The sensors have become dirty
Clean the sensor and its surrounding area on the bumper.
- The outside temperature is extremely high or low
- The sensor voltage has become abnormal

If a message continues to be displayed, have the vehicle inspected by your Toyota dealer.

■ **Certification for the Blind Spot Monitor system**

- ▶ For vehicles sold in the U.S.A.

FCC ID: OAYSRR2A

This device complies with part 15 of the FCC Rules. Operation is subject to the following two conditions:

- (1) This device may not cause harmful interference, and
- (2) this device must accept any interference received, including interference that may cause undesired operation.

FCC WARNING

Changes or modifications not expressly approved by the party responsible for compliance could void the user's authority to operate the equipment.

► For vehicles sold in Canada

Applicable law : Canada 310

This device complies with Industry Canada licence-exempt RSS standard(s). Operation is subject to the following two conditions: (1) this device may not cause interference, and (2) this device must accept any interference, including interference that may cause undesired operation of the device.

Frequency bands : 24.05 - 24.25GHz

Output power : less than 20 milliwatts

⚠ CAUTION

■ Handling the radar sensor

One Blind Spot Monitor sensor is installed inside the left and right side of the vehicle rear bumper respectively. Observe the following to ensure the Blind Spot Monitor system can function correctly.

- Keep the sensor and its surrounding area on the bumper clean at all times.

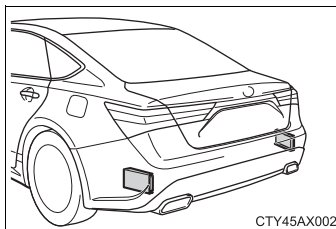

- Do not subject the sensor or surrounding area on the bumper to a strong impact. If the sensor moves even slightly off position, the system may malfunction and vehicles that enter the detection area may not be detected. If the sensor or surrounding area is subject to a strong impact, always have the area inspected by your Toyota dealer.
- Do not disassemble the sensor.
- Do not attach accessories or stickers to the sensor or surrounding area on the bumper.
- Do not modify the sensor or surrounding area on the bumper.
- Do not paint the sensor or surrounding area on the bumper.

The Blind Spot Monitor function

The Blind Spot Monitor function uses radar sensors to detect vehicles that are traveling in an adjacent lane in the area that is not reflected in the outside rear view mirror (the blind spot), and advises the driver of the vehicles existence via the outside rear view mirror indicator.

The Blind Spot Monitor function detection areas

The areas that vehicles can be detected in are outlined below.

The range of the detection area extends to:

- ① Approximately 11.5 ft. (3.5 m) from the side of the vehicle
The first 1.6 ft. (0.5 m) from the side of the vehicle is not in the detection area
- ② Approximately 9.8 ft. (3 m) from the rear bumper
- ③ Approximately 3.3 ft. (1 m) forward of the rear bumper

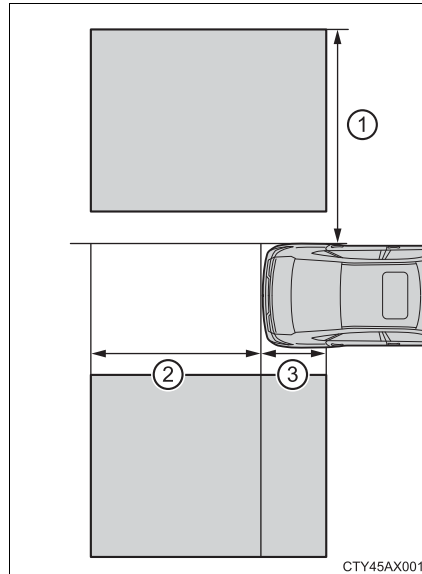

⚠ CAUTION

■ Cautions regarding the use of the system

The driver is solely responsible for safe driving. Always drive safely, taking care to observe your surroundings.

The Blind Spot Monitor function is a supplementary function which alerts the driver that a vehicle is present in the blind spot. Do not overly rely on the Blind Spot Monitor function. The function cannot judge if it is safe to change lanes, therefore over reliance could cause an accident resulting in death or serious injury.

According to conditions, the system may not function correctly. Therefore the driver's own visual confirmation of safety is necessary.

■ The Blind Spot Monitor function is operational when

- The BSM main switch is set to on
- Vehicle speed is greater than approximately 10 mph (16 km/h).

■ The Blind Spot Monitor function will detect a vehicle when

- A vehicle in an adjacent lane overtakes your vehicle.
- Another vehicle enters the detection area when it changes lanes.

■ Conditions under which the Blind Spot Monitor function will not detect a vehicle

The Blind Spot Monitor function is not designed to detect the following types of vehicles and/or objects:

- Small motorcycles, bicycles, pedestrians etc.*
- Vehicles traveling in the opposite direction
- Guardrails, walls, signs, parked vehicles and similar stationary objects*
- Following vehicles that are in the same lane*
- Vehicles driving 2 lanes across from your vehicle*

*: Depending on conditions, detection of a vehicle and/or object may occur.

■ Conditions under which the Blind Spot Monitor function may not function correctly

- The Blind Spot Monitor function may not detect vehicles correctly in the following conditions:
 - During bad weather such as heavy rain, fog, snow etc.
 - When ice or mud etc. is attached to the rear bumper
 - When driving on a road surface that is wet due to rain, standing water etc.
 - When there is a significant difference in speed between your vehicle and the vehicle that enters the detection area
 - When a vehicle is in the detection area from a stop and remains in the detection area as your vehicle accelerates
 - When driving up or down consecutive steep inclines, such as hills, a dip in the road etc.
 - When multiple vehicles approach with only a small gap between each vehicle
 - When vehicle lanes are wide, and the vehicle in the next lane is too far away from your vehicle
 - When the vehicle that enters the detection area is traveling at about the same speed as your vehicle
 - When there is a significant difference in height between your vehicle and the vehicle that enters the detection area
 - Directly after the BSM main switch is set to on
- Instances of the Blind Spot Monitor function unnecessarily detecting a vehicle and/or object may increase under the following conditions:
 - When there is only a short distance between your vehicle and a guardrail, wall etc.
 - When there is only a short distance between your vehicle and a following vehicle
 - When vehicle lanes are narrow and a vehicle driving 2 lanes across from your vehicle enters the detection area
 - When items such as a bicycle carrier are installed on the rear of the vehicle

The Rear Cross Traffic Alert function

The Rear Cross Traffic Alert functions when your vehicle is in reverse. It can detect other vehicles approaching from the right or left rear of the vehicle. It uses radar sensors to alert the driver of the other vehicle's existence through flashing the outside rear view mirror indicators and sounding a buzzer.

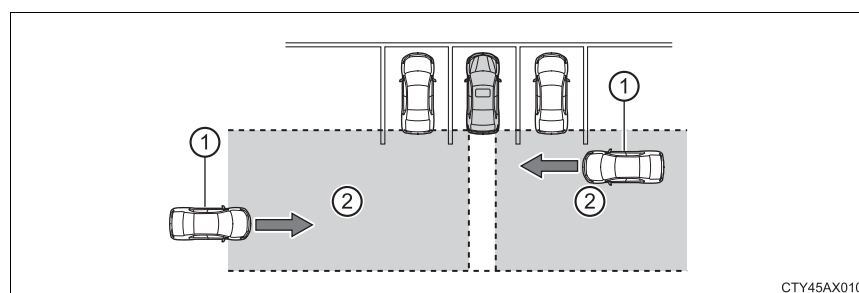

① Approaching vehicles

② Detection areas

⚠ CAUTION

■ Cautions regarding the use of the system

The driver is solely responsible for safe driving. Always drive safely, taking care to observe your surroundings.

The Rear Cross Traffic Alert function is only an assist and is not a replacement for careful driving. Driver must be careful when backing up, even when using Rear Cross Traffic Alert function. The driver's own visual confirmation of behind you and your vehicle is necessary and be sure there are no pedestrians, other vehicles etc. before backing up. Failure to do so could cause death or serious injury.

According to conditions, the system may not function correctly. Therefore the driver's own visual confirmation of safety is necessary.

The Rear Cross Traffic Alert function detection areas

The areas that vehicles can be detected in are outlined below.

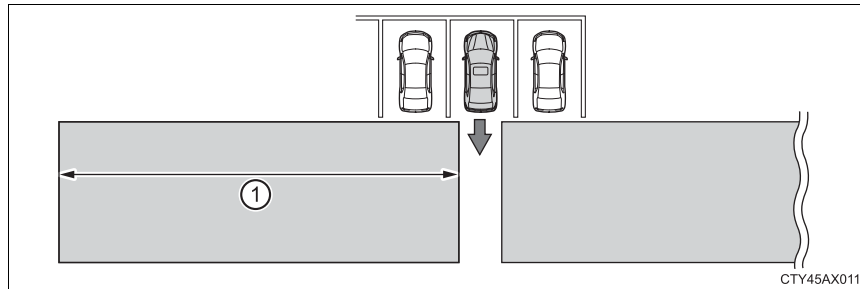

To give the driver a more consistent time to react, the buzzer can alert for faster vehicles from farther away.

Example:

Approaching vehicle	Speed	① Approximate alert distance
Fast	18 mph (28 km/h)	65 ft. (20 m)
Slow	5 mph (8 km/h)	18 ft. (5.5 m)

The Rear Cross Traffic Alert function is operational when

- The BSM main switch is set to on.
- The shift lever is in R.
- Vehicle speed is less than approximately 5 mph (8 km/h).
- Approaching vehicle speed is between approximately 5 mph (8 km/h) and 18 mph (28 km/h).

■ Conditions under which the Rear Cross Traffic Alert function will not detect a vehicle

The Rear Cross Traffic Alert function is not designed to detect the following types of vehicles and/or objects.

- Small motorcycles, bicycles, pedestrians etc.*
- Vehicles approaching from directly behind
- Guardrails, walls, signs, parked vehicles and similar stationary objects*
- Vehicles moving away from your vehicle
- Vehicles approaching from the parking spaces next to your vehicle*
- Vehicles backing up in the parking space next to your vehicle*

*: Depending on conditions, detection of a vehicle and/or object may occur.

■ Conditions under which the Rear Cross Traffic Alert function may not function correctly

The Rear Cross Traffic Alert function may not detect vehicles correctly in the following conditions:

- When ice or mud etc. is attached to the rear bumper
- During bad weather such as heavy rain, fog, snow etc.
- When multiple vehicles approach continuously
- Shallow angle parking
- When a vehicle is approaching at high speed
- When parking on a steep incline, such as hills, a dip in the road etc.
- Directly after the BSM main switch is set to on
- Vehicles that the sensors cannot detect because of obstacles

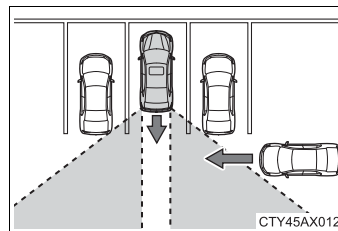

Winter driving tips

Carry out the necessary preparations and inspections before driving the vehicle in winter. Always drive the vehicle in a manner appropriate to the prevailing weather conditions.

Preparation for winter

- Use fluids that are appropriate to the prevailing outside temperatures.
 - Engine oil
 - Engine coolant
 - Washer fluid
- Have a service technician inspect the condition of the battery.
- Have the vehicle fitted with four snow tires or purchase a set of tire chains for the front tires.

Ensure that all tires are the specified size and brand, and that chains match the size of the tires.

Before driving the vehicle

Perform the following according to the driving conditions:

- Do not try to forcibly open a window or move a wiper that is frozen. Pour warm water over the frozen area to melt the ice. Wipe away the water immediately to prevent it from freezing.
- To ensure proper operation of the climate control system fan, remove any snow that has accumulated on the air inlet vents in front of the windshield.
- Check for and remove any excess ice or snow that may have accumulated on the exterior lights, vehicle's roof, chassis, around the tires or on the brakes.
- Remove any snow or mud from the bottom of your shoes before getting in the vehicle.

When driving the vehicle

Accelerate the vehicle slowly, keep a safe distance between you and the vehicle ahead, and drive at a reduced speed suitable to road conditions.

When parking the vehicle

Park the vehicle and move the shift lever to P without setting the parking brake. The parking brake may freeze up, preventing it from being released. If necessary, block the wheels to prevent inadvertent sliding or creeping.

Selecting tire chains

Use the correct tire chain size when mounting the tire chains.
Chain size is regulated for each tire size.

Side chain:

- ① 0.12 in. (3 mm) in diameter
- ② 0.39 in. (10 mm) in width
- ③ 1.18 in. (30 mm) in length

Cross chain:

- ④ 0.16 in. (4 mm) in diameter
- ⑤ 0.55 in. (14 mm) in width
- ⑥ 0.98 in. (25 mm) in length

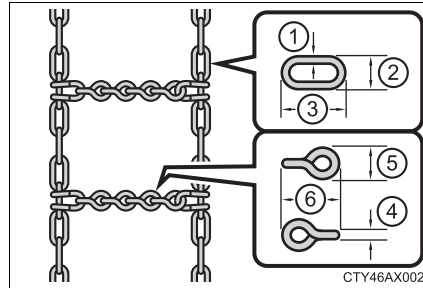

Regulations on the use of tire chains

Regulations regarding the use of tire chains vary depending on location and type of road. Always check local regulations before installing chains.

■ Tire chain installation

Observe the following precautions when installing and removing chains:

- Install and remove tire chains in a safe location.
- Install tire chains on the front tires. Do not install tire chains on the rear tires.
- Install tire chains on front tires as tightly as possible. Retighten chains after driving 1/4 — 1/2 mile (0.5 — 1.0 km).
- Install tire chains following the instructions provided with the tire chains.

 CAUTION**■ Driving with snow tires**

Observe the following precautions to reduce the risk of accidents. Failure to do so may result in a loss of vehicle control and cause death or serious injury.

- Use tires of the specified size.
- Maintain the recommended level of air pressure.
- Do not drive in excess of 75 mph (120 km/h), regardless of the type of snow tires being used.
- Use snow tires on all, not just some wheels.

■ Driving with tire chains

Observe the following precautions to reduce the risk of accidents. Failure to do so may result in the vehicle being unable to be driven safely, and may cause death or serious injury.

- Do not drive in excess of the speed limit specified for the tire chains being used, or 30 mph (50 km/h), whichever is lower.
- Avoid driving on bumpy road surfaces or over potholes.
- Avoid sudden acceleration, abrupt steering, sudden braking and shifting operations that cause sudden engine braking.
- Slow down sufficiently before entering a curve to ensure that vehicle control is maintained.

4

Driving

 NOTICE**■ Repairing or replacing snow tires**

Request repairs or replacement of snow tires from Toyota dealers or legitimate tire retailers.

This is because the removal and attachment of snow tires affects the operation of the tire pressure warning valves and transmitters.

■ Fitting tire chains

The tire pressure warning valves and transmitters may not function correctly when tire chains are fitted.

Interior features

5

5-1. Using the air conditioning system and defogger

Automatic air conditioning system.....	242
Rear window and outside rear view mirror defoggers	252

5-2. Using the interior lights

Interior lights list	253
• Personal/interior light main switch	254
• Personal/interior lights	254
• Ambient lights	255

5-3. Using the storage features

List of storage features	256
• Glove box.....	257
• Console box.....	258
• Cup holders	259
• Auxiliary boxes.....	260
Trunk features.....	265

5-4. Other interior features

Sun visors and vanity mirrors.....	267
Clock	268
Outside temperature display.....	270
Power outlets	271
Seat heaters/seat ventilators	274
Armrest	277
Rear sunshade.....	278
Trunk storage extension	280
Coat hooks.....	281
Assist grips.....	282
Garage door opener.....	283
Safety Connect	290
Compass.....	296

Automatic air conditioning system

Air outlets and fan speed are automatically adjusted according to the temperature setting.

► Front control panel (type A)

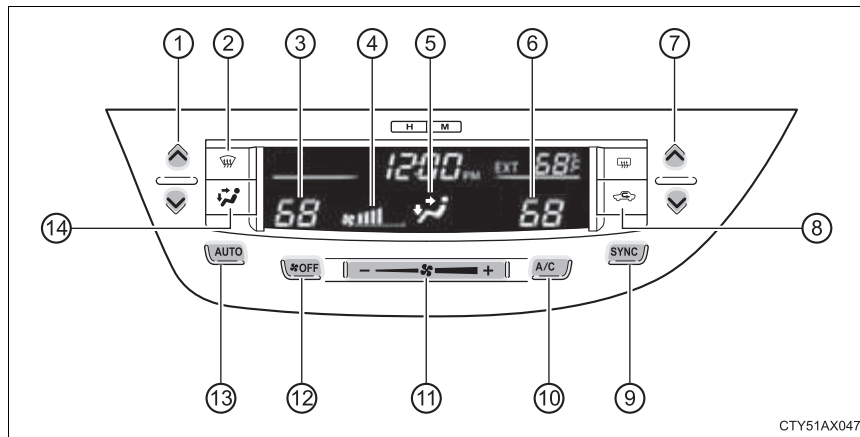

► Front control panel (type B)

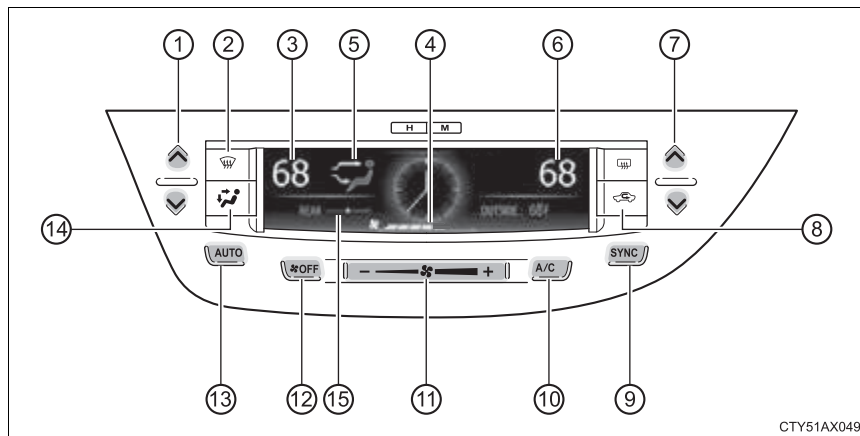

- | | |
|--|--|
| ① Driver's side temperature control | ⑧ Outside air or recirculated mode |
| ② Windshield defogger | ⑨ SYNC mode |
| ③ Driver's side temperature display | ⑩ Cooling and dehumidification function on/off |
| ④ Fan speed display | ⑪ Fan speed control |
| ⑤ Air outlet display | ⑫ Off |
| ⑥ Front passenger's side temperature display | ⑬ Automatic mode |
| ⑦ Front passenger's side temperature control | ⑭ Air outlet selector |
| | ⑮ Rear passenger's temperature setting display (if equipped) |

► Rear control panel (if equipped)

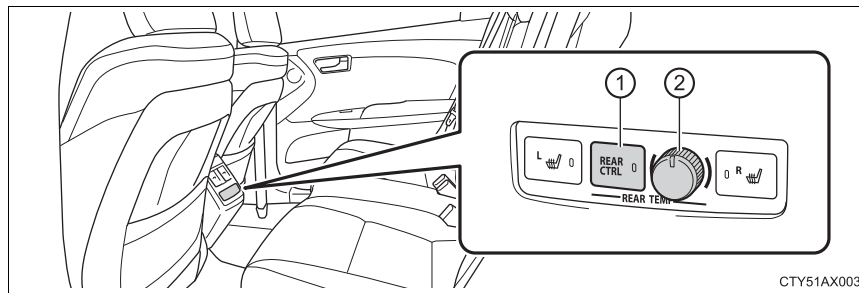



- | | |
|-----------------------|--|
| ① Rear control switch | ② Rear passenger's temperature control |
|-----------------------|--|

Using the automatic air conditioning system





■ Using automatic operation

- 1 Touch .

The air conditioning system begins to operate. Air outlets and fan speed are automatically adjusted according to the temperature setting.

- 2 Touch  (driver's side) to increase the temperature and touch  (driver's side) to decrease the temperature.

The temperature for the driver's, front passenger's and rear seats (vehicles with a rear control switch) can be adjusted separately when:



-  is pressed (the "SYNC" display disappears).
- The front passenger's side temperature control switch is touched (the front passenger's side temperature setting is shown).
- Vehicles with a rear control switch:  is pressed ( indicator is on and the rear passenger's temperature setting is shown).
- Vehicles with a rear control switch:  is turned ( indicator is on and the rear passenger's temperature setting is shown).

The air conditioning system switches between individual and synchronized modes each time  is touched.

Vehicles with a rear control switch: The rear passenger's temperature setting switches between individual and synchronized modes each time

-  is pressed.

■ Changing the rear seat temperature settings (vehicles with a rear control switch)

Turn  clockwise to increase the temperature and turn  counterclockwise to decrease the temperature.

■ Confirming automatic operation status

During automatic operation, the operation status of fan speed, air outlet mode, outside/recirculated air mode and whether the A/C is on or off can be confirmed on the display by touching .

The display will return to its previous state after a few seconds.

■ Automatic mode indicator

If the fan speed setting or air flow modes are operated, the automatic mode indicator goes off. However, automatic mode for functions other than that operated are maintained.

Adjusting the settings manually

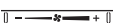

- To adjust the fan speed, touch  and slide your finger toward “+” to increase the fan speed or “-” to decrease the fan speed.

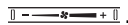
The fan speed can also be adjusted by touching “+” or “-” on



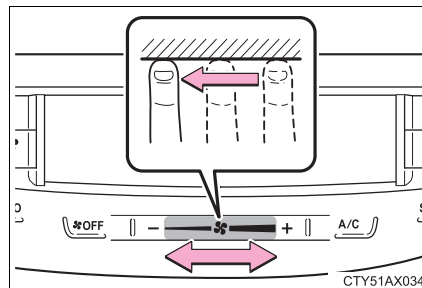





Touch  to turn the fan off.



- 2 To adjust the temperature setting, touch  (driver's side) to increase the temperature and touch  (driver's side) to decrease the temperature.

The temperature for the driver's, front passenger's and rear seats (vehicles with a rear control switch) can be adjusted separately when:

-  is pressed (the "SYNC" display disappears).
- The front passenger's side temperature control switch is touched (the front passenger's side temperature setting is shown).
- Vehicles with a rear control switch:  is pressed ( indicator is on and the rear passenger's temperature setting is shown).
- Vehicles with a rear control switch:  is turned ( indicator is on and the rear passenger's temperature setting is shown).

The air conditioning system switches between individual and synchronized modes each time  is touched.

Vehicles with a rear control switch: The rear passenger's temperature setting switches between individual and synchronized modes each time

 is pressed.

- 3 To change the air outlets, press  .

The air outlets used are switched each time  is pressed.

■ **Changing the rear seat temperature settings (vehicles with a rear control switch)**

→P. 245

Defogging the windshield

Press  .

The dehumidification function operates and fan speed increases. Set the outside/recirculated air mode button to the outside air mode if the recirculated air mode is used. (It may switch automatically.) To defog the windshield and the side windows early, turn the air flow and temperature up.

To return to the previous mode, press  again when the windshield is defogged.

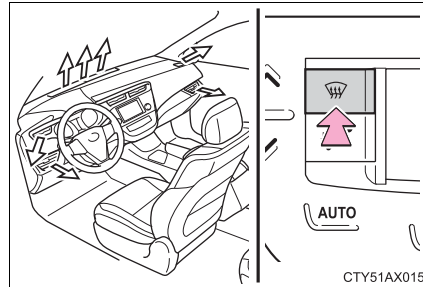

Air outlets and air flow

Air flows to the upper body.

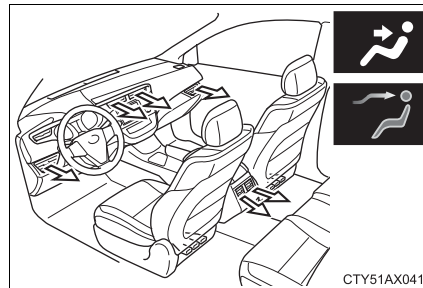

Air flows to the upper body and feet.

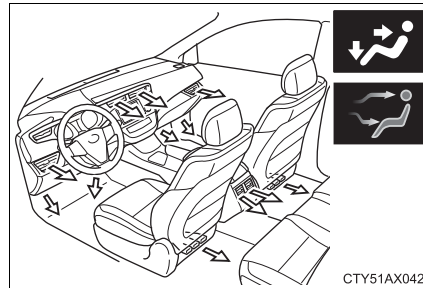

5

Interior features

Air flows mainly to the feet.

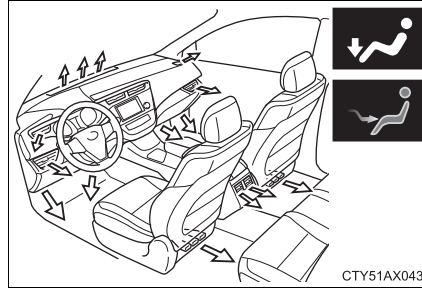

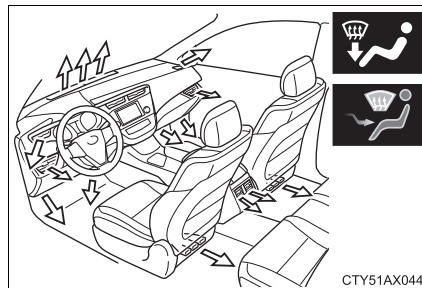

Air flows to the feet and the windshield defogger operates.



Switching between outside air and recirculated air modes

Press  .

The mode switches between  (outside air mode) and  (recirculated air mode) each time the button is pressed.

Adjusting the position of and opening and closing the air outlets

► Front center outlets

- ① Direct air flow to the left or right, up or down.
- ② Turn the knob to open or close the vent.

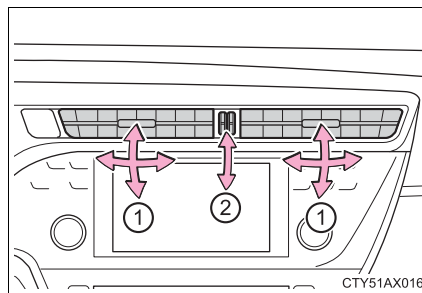

► Front side outlets

- ① Direct air flow to the left or right, up or down.
- ② Turn the knob to open or close the vent.

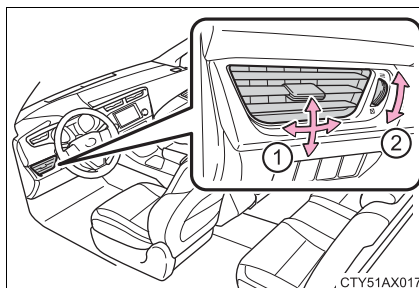

► Rear outlets

- ① Direct air flow to the left or right, up or down.
- ② Turn the knob to open or close the vent.

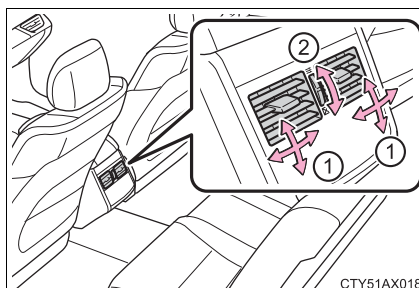

■ Operation of the air conditioning system in Eco drive mode

In Eco drive mode, the air conditioning system is controlled as follows to prioritize fuel efficiency:



- When the outside temperature exceeds 68°F (20°C), the air conditioning system may switch to recirculated air mode automatically. This may also reduce fuel consumption.
- It is possible to switch to outside air mode at any time by pressing  .

■ Using automatic mode

Fan speed is adjusted automatically according to the temperature setting and the ambient conditions.

Therefore, the fan may stop for a while until warm or cool air is ready to flow immediately after  is touched.

■ Fogging up of the windows

- The windows will easily fog up when the humidity in the vehicle is high. Turning  on will dehumidify the air from the outlets and defog the windshield effectively.
- If you turn  off, the windows may fog up more easily.
- The windows may fog up if the recirculated air mode is used.

■ Outside/recirculated air mode

- When driving on dusty roads such as tunnels or in heavy traffic, set the outside/recirculated air mode to the recirculated air mode. This is effective in preventing outside air from entering the vehicle interior. During cooling operation, setting the recirculated air mode will also cool the vehicle interior effectively.
- Outside/recirculated air mode may automatically switch depending on the temperature setting, outside temperature, pressure, engine coolant temperature or inside temperature.

■ When the outside temperature exceeds 75°F (24°C) and the air conditioning system is on (U.S.A. only)

- In order to reduce the air conditioning power consumption, the air conditioning system may switch to recirculated air mode automatically. This may also reduce fuel consumption.
- Recirculated air mode is selected as a default mode when the engine switch is turned to IGNITION ON mode.
- It is possible to switch to outside air mode at any time by pressing  .

■ When the outside temperature falls to nearly 32°F (0°C)

The dehumidification function may not operate even when  is touched.

■ Ventilation and air conditioning odors

- To let fresh air in, set the air conditioning system to the outside air mode.
- During use, various odors from inside and outside the vehicle may enter into and accumulate in the air conditioning system. This may then cause odor to be emitted from the vents.
- To reduce potential odors from occurring:
 - It is recommended that the air conditioning system be set to outside air mode prior to turning the vehicle off.
 - The start timing of the blower may be delayed for a short period of time immediately after the air conditioning system is started in automatic mode.

■ Air conditioning filter

→P. 348

■ Handling of the air conditioning panel

The operating section of the air conditioning panel uses capacitive touch sensors. In the following cases, incorrect operation or non-response may occur.

- If the operating section is dirty or has liquid attached to it, incorrect operation or non-response may occur.
- If the operating section receives electromagnetic waves, incorrect operation or non-response may occur.
- If wearing gloves during operation, non-response may occur.
- If fingernails are used to operate the system, non-response may occur.
- If a touch pen is used to operate the system, non-response may occur.
- If the palm of your hand touches the operating section during operation, incorrect operation may occur.
- If the palm of your hand touches the operating section, incorrect operation may occur.
- If operations are performed quickly, non-response may occur.

■ Customization

Settings (e.g. air conditioning setting) can be changed.
(Customizable features →P. 455)

CAUTION

■ To prevent the windshield from fogging up

Do not use  during cool air operation in extremely humid weather. The difference between the temperature of the outside air and that of the windshield can cause the outer surface of the windshield to fog up, blocking your vision.

NOTICE

■ To prevent battery discharge

Do not leave the air conditioning system on longer than necessary when the engine is stopped.

Rear window and outside rear view mirror defoggers

These features are used to defog the rear window, and to remove raindrops, dew and frost from the outside rear view mirrors.

On/off

The defoggers will automatically turn off after 15 to 60 minutes. The operation time changes according to the ambient temperature and vehicle speed.

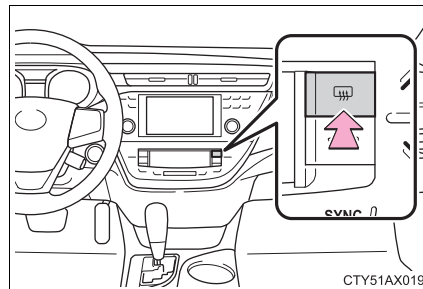

■ Operating conditions

The engine switch must be in the IGNITION ON mode.

⚠ CAUTION

■ When the outside rear view mirror defoggers are on

Do not touch the rear view mirror surfaces, as they can become very hot and burn you.

⚠ NOTICE

■ To prevent battery discharge

Turn the defoggers off when the engine is off.

Interior lights list

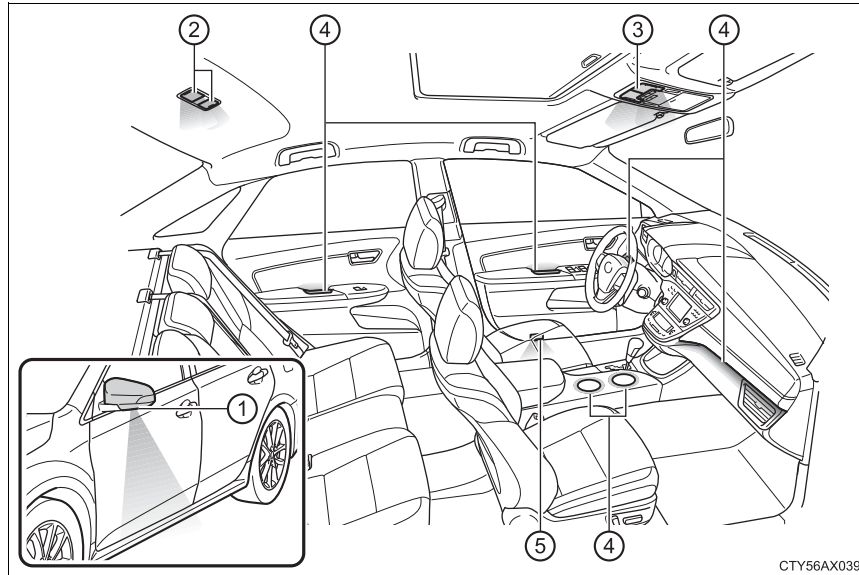

- ① Outer foot lights (if equipped)
- ② Rear personal/interior lights
(→P. 254)
- ③ Front personal/interior lights
(→P. 254)
- ④ Ambient lights (if equipped)
(→P. 255)
- ⑤ Front door courtesy lights

5

Interior features

Personal/interior light main switch

- ① Turns the lights on/off
- ② Turns the lights on/off linked to door position

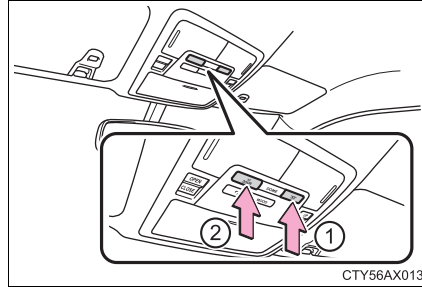

Personal/interior lights

■ Front

Turns the light on/off

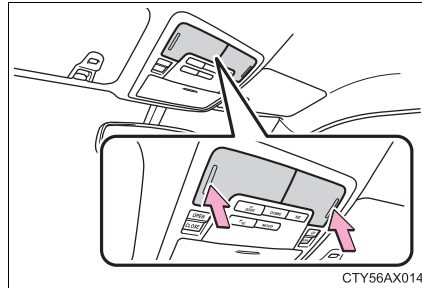

■ Rear

Turns the light on/off

If the lights are turned on by the personal/interior light main switch, the lights cannot turn off by pressing the switch.

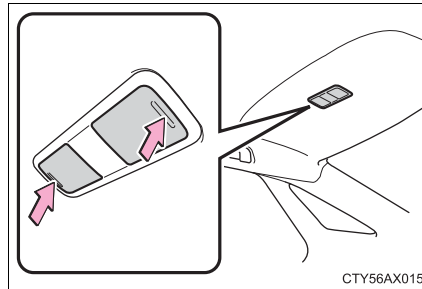

Ambient lights (if equipped)

Each time the “MOOD” switch is pressed, the brightness level changes.

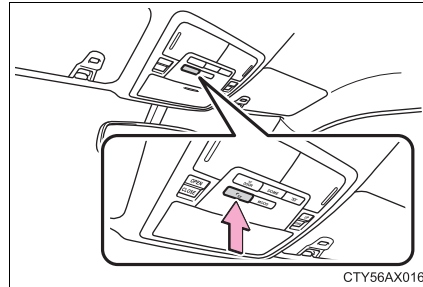

■ Illuminated entry system

The lights automatically turn on/off according to engine switch mode, the presence of the electronic key, whether the doors are locked/unlocked, and whether the doors are opened/closed.

■ To prevent battery discharge

If the personal/interior lights remain on when the engine switch is turned off, the lights will go off automatically after 20 minutes.

■ Customization

Setting (e.g. the time elapsed before lights turn off) can be changed.
(Customizable features: →P. 455)

⚠ NOTICE

■ To prevent battery discharge

Do not leave the lights on longer than necessary when the engine is not running.

List of storage features

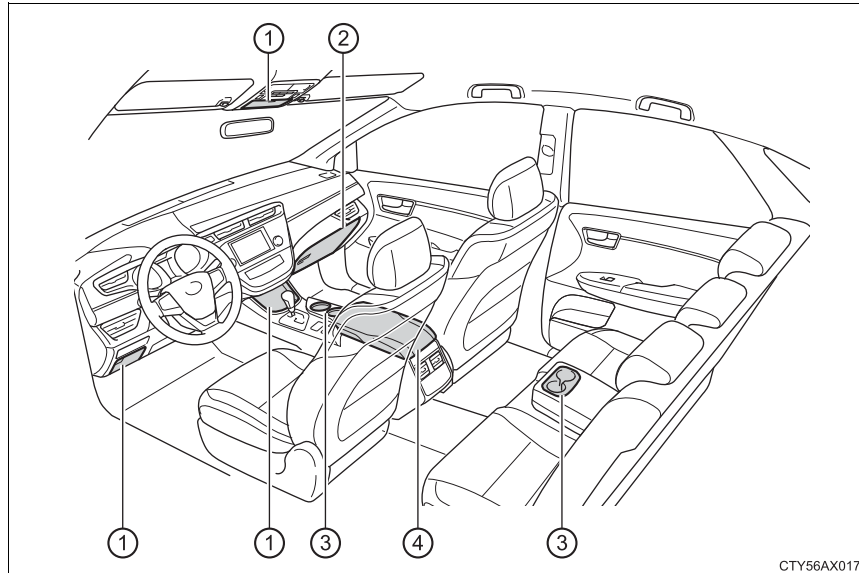

- | | | | |
|-------------------|-----------|---------------|-----------|
| ① Auxiliary boxes | (→P. 260) | ③ Cup holders | (→P. 259) |
| ② Glove box | (→P. 257) | ④ Console box | (→P. 258) |

⚠ CAUTION

■ Items that should not be left in the storage spaces

Do not leave glasses, lighters or spray cans in the storage spaces, as this may cause the following when cabin temperature becomes high:

- Glasses may be deformed by heat or cracked if they come into contact with other stored items.
- Lighters or spray cans may explode. If they come into contact with other stored items, the lighter may catch fire or the spray can may release gas, causing a fire hazard.

■ When driving or when the storage compartments are not in use

Keep the lids closed.

In the event of sudden braking or sudden swerving, an accident may occur due to an occupant being struck by an open lid or the items stored inside.

Glove box

- ① Open (pull up the lever)
- ② Lock with the mechanical key
- ③ Unlock with the mechanical key

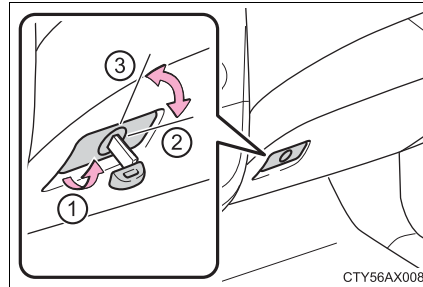
**⚠ CAUTION****■ Caution while driving**

Keep the glove box closed. In the event of sudden braking or sudden swerving, an accident may occur due to an occupant being struck by the open glove box or the items stored inside.

Console box

Lift the lid while pulling up the lever to release the lock.

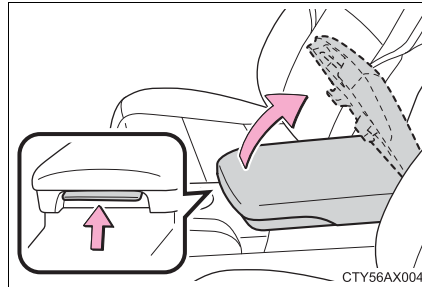

■ When using the console box lid as an armrest

Slide the console box lid forward as needed. Slide the lid forward while pulling up the lever.

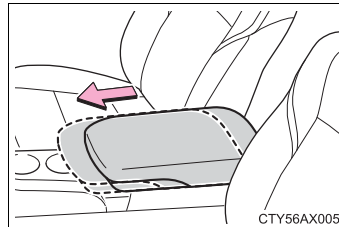

The lid can also be opened from the forwardmost position.

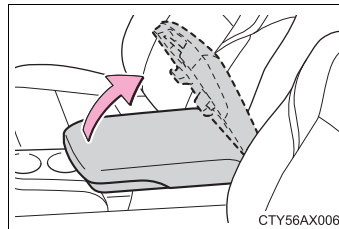

■ Tray in the console box

The tray slides forward/backward and can be removed.

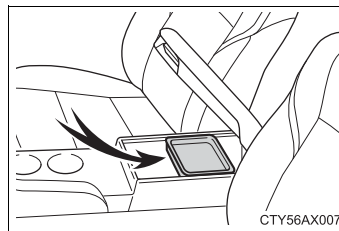

⚠ CAUTION

■ Caution while driving

Keep the console box closed. In the event of sudden braking, an accident may occur due to an occupant being struck by the open console box or the items stored inside.

Cup holders

► Front

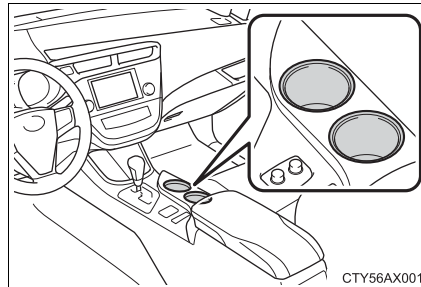

► Rear (type A)

Pull down the armrest.

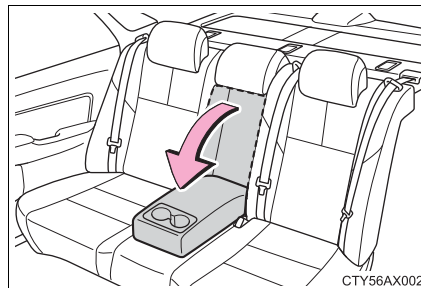

► Rear (type B)

Pull down the armrest and open the lid.

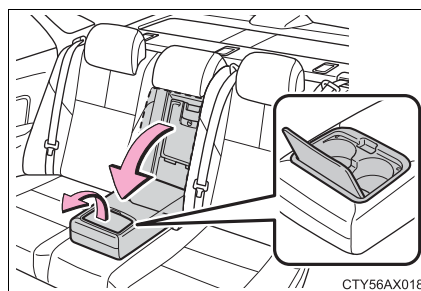

⚠ CAUTION

■ **Items unsuitable for the cup holders**

Do not place anything other than cups or aluminum cans in the cup holders. Other items may be thrown out of the holders in the event of an accident or sudden braking, causing injury. If possible, cover hot drinks to prevent burns.

■ **When not in use (type B)**

Keep the cup holders closed. In the event of sudden braking, an accident may occur due to an occupant being struck by the open cup holders or the items stored inside.

Auxiliary boxes

▶ **Type A**

Press in the button.

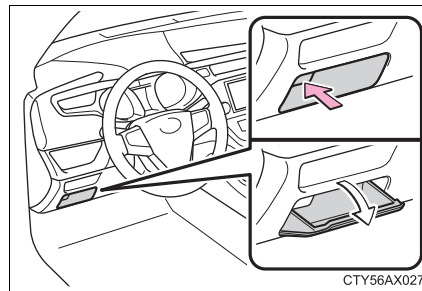

▶ **Type B**

Push the lid.

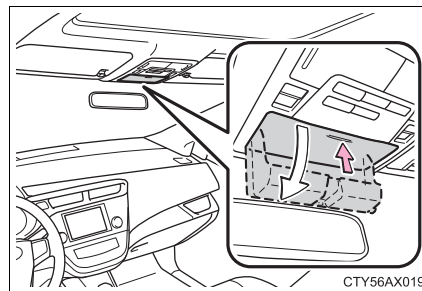

► Type C

Opening

Push the tray forward until it locks.

Closing

Push the tray forward to release the lock and the tray will automatically close.

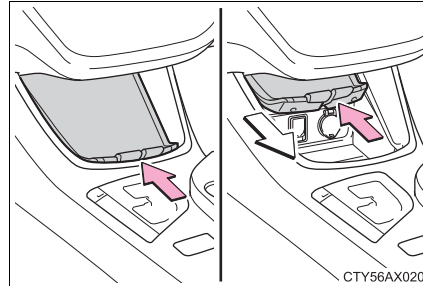

■ When placing small items on top of the tray

The tray can be opened while small items are placed on it.

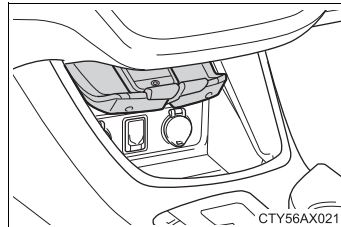

An electronic device on the tray can be recharged by running a charging cable through the clearance of the tray and connecting it to the AUX/USB port or power outlet underneath the tray.

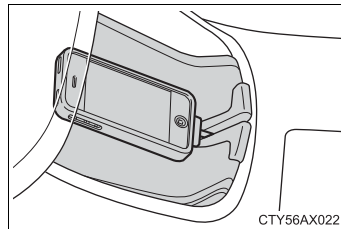

■ When using wireless charger (if equipped)

A mobile device can be charged wirelessly on the tray.

Charging can only be performed with the engine switch in ACCESSORY or IGNITION ON mode and only on mobile devices with the “ Φ ” logo.

- ① Push the tray forward until it locks and press the wireless charger switch.
- ② Push the tray forward to release the lock to close the tray and place a mobile device on the tray as shown in the illustration.

An amber indicator is illuminated while charging is in progress. When charging is complete, a green indicator will also be illuminated.

Some phones, cases or cover type wireless chargers may not cause the green indicator to illuminate even though it is fully charged.

When placing the mobile device on the wireless charging surface of the tray, make sure that there are no objects in-between the mobile device and the tray. They may interfere with charging.

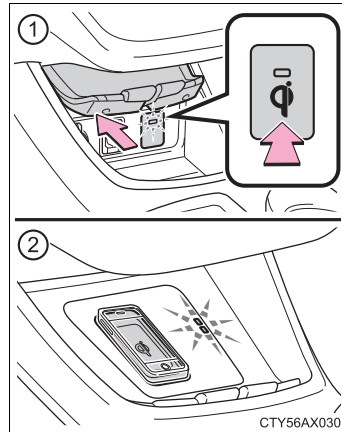

■ If the wireless charger LED indicators flash

If the wireless charging surface of the tray becomes too hot, the LED indicators will flash and charging is canceled. The LED indicators will be illuminated if the surface of the tray cools down.

If the LED indicators flash even though the surface of the tray is not hot, the wireless charger may be malfunctioning. Consult your Toyota dealer.

■ When charging of the wireless charger stops temporarily

If any of the following operations are performed with the electronic key present, charging may stop temporarily. Charging will start again after a while.

- Locking/unlocking the doors by touching the door handle
- Opening/closing the doors
- Pressing the trunk opener switch
- Closing the trunk lid
- Starting the engine
- Locking the doors by pressing the lock button on the electronic key
- When the electronic key is out of the detection area

■ Certification for the wireless charger

- ▶ For vehicles sold in the U.S.A.

This device complies with Part 18 of the FCC Rules.

Toyota Motor Sales, U.S.A., Inc.
19001 S. Western Avenue
Torrance, CA 90501

- ▶ For vehicles sold in Canada

This ISM device complies with Canadian ICES-001.
Cet appareil ISM est conforme à la norme NMB-001 du Canada.

▲ CAUTION**■ Caution while driving**

Keep the auxiliary boxes closed. In the event of sudden braking, an accident may occur due to an occupant being struck by an open auxiliary box or the items stored inside.

■ Items unsuitable for storing (type B only)

Do not store items heavier than 0.4 lb. (0.2 kg).
Doing so may cause the auxiliary box to open and the items inside may fall out, resulting in an accident.

 CAUTION

■ **Caution regarding interference with electronic devices (vehicles with a wireless charger)**

- People with implantable cardiac pacemakers, cardiac resynchronization therapy-pacemakers or implantable cardioverter defibrillators should maintain a reasonable distance between themselves and the wireless charger. The radio waves may affect the operation of such devices.
- Before using the wireless charger, users of any electrical medical device other than implantable cardiac pacemakers, cardiac resynchronization therapy-pacemakers or implantable cardioverter defibrillators should consult the manufacturer of the device for information about its operation under the influence of radio waves. Radio waves could have unexpected effects on the operation of such medical devices.
- To avoid interference with other electrical devices, turn the wireless charger off by turning off the wireless charger switch.

■ **When using wireless charger**

Avoid placing metal objects between the wireless charger and the mobile device when charging is active. Doing so may cause metal objects to become hot and could cause burns.

 NOTICE

■ **To prevent damaging small items**

When opening the tray while small items are placed on it, make sure the items will not get caught.

■ **To prevent damaging the tray**

Do not pull down the tray to close it. Doing so may damage the tray.

■ **When on a steep downward incline**

The tray can be closed slowly. In this case, the tray can be pulled down to close it.

However, make sure the lock has been released before doing so.

Trunk features

Grocery bag hooks

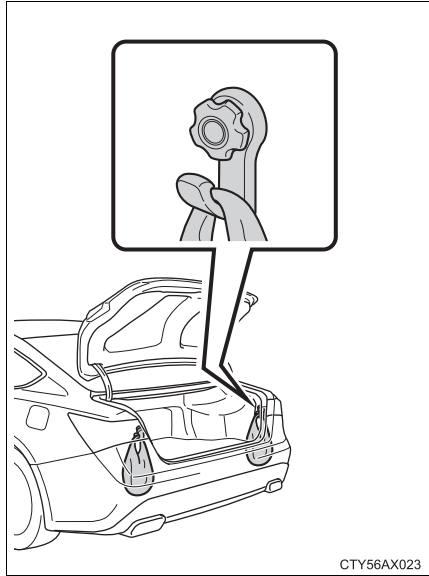

Cargo net (if equipped)

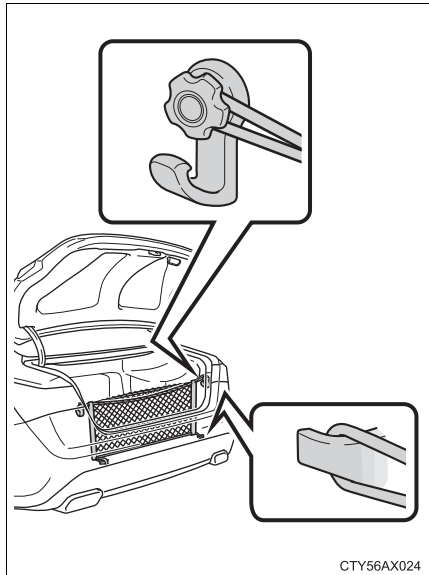

5

Interior features

 NOTICE

■ **To prevent damage to the hooks**

Do not apply too much load to the hooks.

Sun visors and vanity mirrors

Sun visors

- ① To set the visor in the forward position, flip it down.
- ② To set the visor in the side position, flip down, unhook, and swing it to the side.
- ③ To use the side extender, place the visor in the side position, then slide it backward.

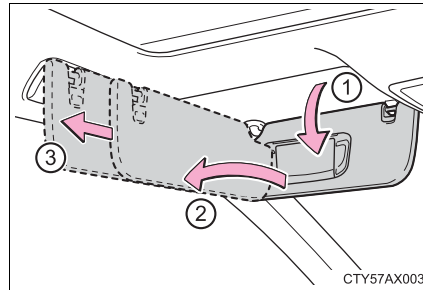

Vanity mirrors

Open the cover to use.

The light turns on when the cover is opened.

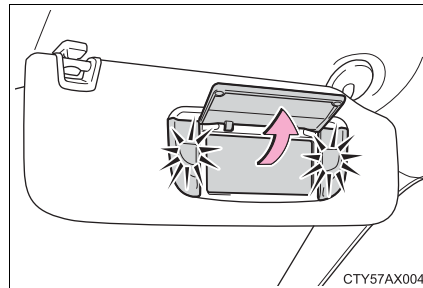

⚠ NOTICE

■ To prevent battery discharge

Do not leave the vanity lights on for extended periods while the engine is off.

Clock

The clock can be adjusted by pressing the buttons.

► Type A

- ① Adjusts the hours
Pressing and holding the button adjusts the hours forward quickly 1 hour at a time.
- ② Adjusts the minutes
Pressing and holding the button adjusts the minutes forward quickly by 1 minute at a time. If the button is pressed and held for 5 seconds or more, the minutes move forward by 5 minutes at a time.

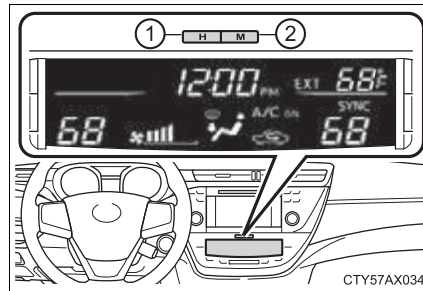

► Type B

- ① Adjusts the hours
Pressing and holding the button adjusts the hours forward quickly 1 hour at a time.
- ② Adjusts the minutes
Pressing and holding the button adjusts the minutes forward quickly by 1 minute at a time. If the button is pressed and held for 5 seconds or more, the minutes move forward by 5 minutes at a time.

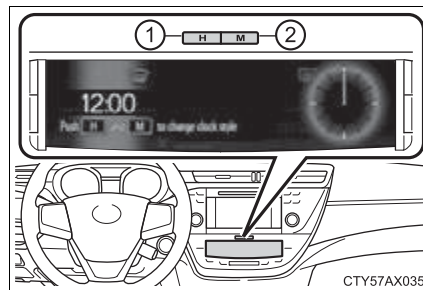

■ The clock is displayed when

The engine switch is in ACCESSORY or IGNITION ON mode.

■ When disconnecting and reconnecting battery terminals**▶ Type A**

The time display will automatically be set to 12:00 AM.

▶ Type B

The time display will automatically be set to 12:00.

■ Time display (Type B)

After pressing “H” or “M” to show the setting screen, press “H” and “M” at the same time to change between the analog and digital displays.

Outside temperature display

The temperature display shows temperatures within the range of -40°F (-40°C) to 122°F (50°C).

► Type A

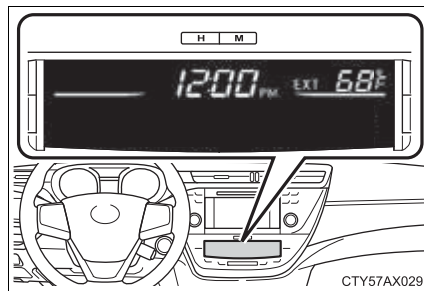

► Type B

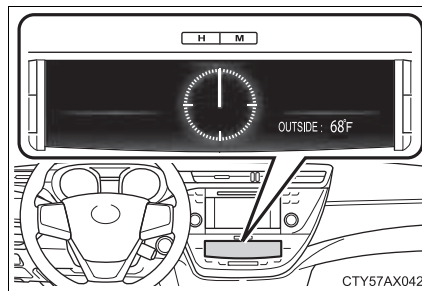

■ **The outside temperature is displayed when**

The engine switch is in IGNITION ON mode.

■ **Display**

In the following situations, the correct outside temperature may not be displayed, or the display may take longer than normal to change.

- When the vehicle is stopped, or moving at low speeds (less than 16 mph [25 km/h]).
- When the outside temperature has changed suddenly (at the entrance/exit of a garage, tunnel, etc.)

■ **When “---°F” is displayed**

The system may be malfunctioning. Take your vehicle to your Toyota dealer.

Power outlets

The power outlets can be used for 12 V accessories that run on less than 10 A.

■ Console box

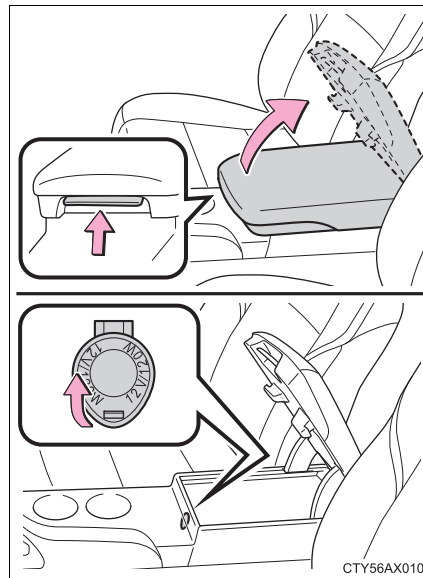

■ Instrument panel

▶ Type A

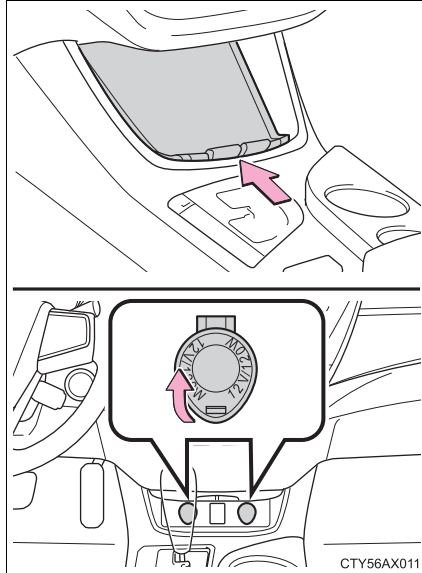

▶ Type B

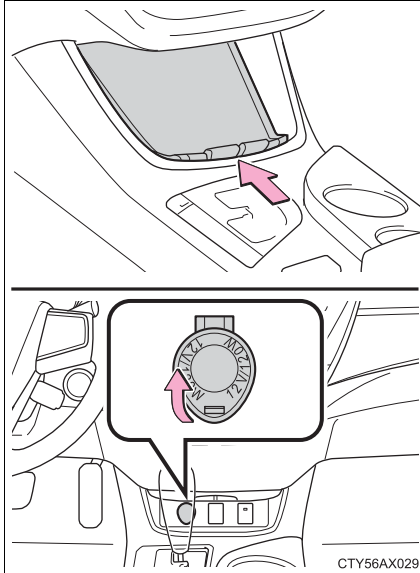

■ Rear armrest (if equipped)

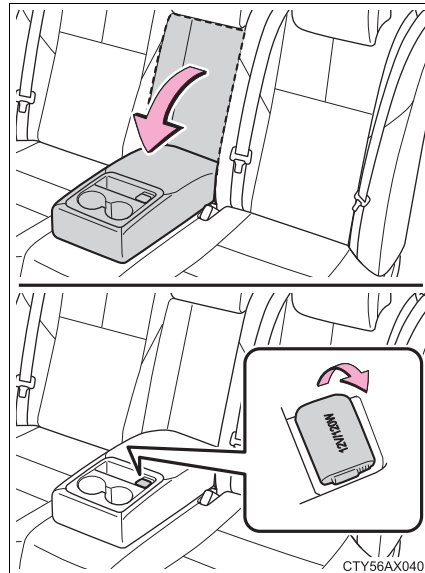

■ The power outlets can be used when

The engine switch is in ACCESSORY or IGNITION ON mode.

 **NOTICE****■ To avoid damaging the power outlets**

Close the power outlet lids when the power outlets are not in use.
Foreign objects or liquids that enter the power outlets may cause a short circuit.

■ To prevent blown fuse

Do not use an accessory that uses more than 12 V 10 A.

■ To prevent battery discharge

Do not use the power outlets longer than necessary when the engine is off.

Seat heaters*/seat ventilators*

The seat heaters warm the seats and the seat ventilators maintain good airflow by blowing air through the seats.

Seat heaters/ventilators

■ Front seats

► Vehicles with ventilator

- ① Press the knob to release it, and turn the knob to the desired temperature setting.
- ② OFF
Press the knob to lock it when not in use.
- ③ Ventilation
- ④ Heat

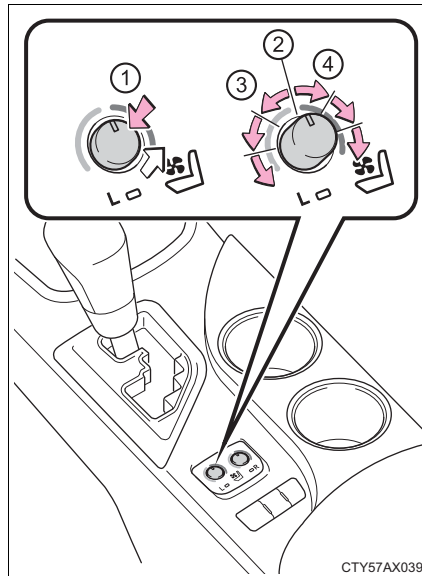

► Vehicles without ventilator

Press the knob to release it, and turn the knob to the desired temperature setting.

The further you turn the knob clockwise, the warmer the seat temperature becomes. Turn the knob counterclockwise all the way to turn the system off.

Press the knob again to lock it when not in use.

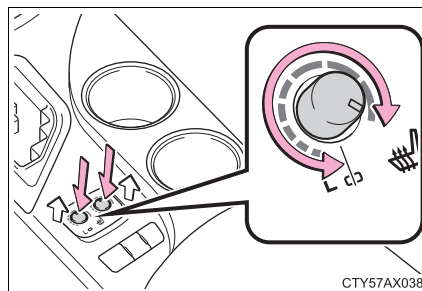

*: If equipped

■ Rear seats

ON/OFF

The indicator illuminates when the seat heater is turned on.

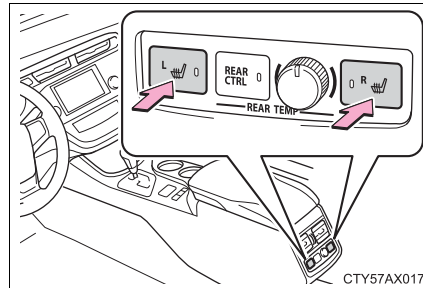

■ The seat heaters/seat ventilators can be used when

The engine switch is in IGNITION ON mode.

■ Automatic operation of the seat ventilator for the passenger's seat

When a passenger leaves the passenger seat while the seat ventilation turns on, the seat ventilator automatically turns off. If the passenger returns to the seat, it automatically turns on again.

■ Operation display illumination (if equipped)

- ① Illuminates when the ventilator is operating.
- ② Illuminates when the front seat heater is operating.

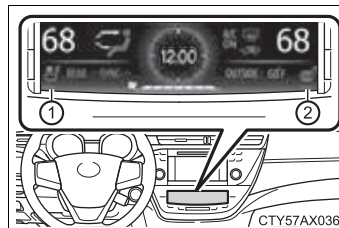

 CAUTION

■ **Burns**

- Use caution when seating the following persons in a seat with the seat heater on to avoid the possibility of burns:
 - Babies, small children, the elderly, the sick and the physically challenged
 - Persons with sensitive skin
 - Persons who are fatigued
 - Persons who have taken alcohol or drugs that induce sleep (sleeping drugs, cold remedies, etc.)
- Do not cover the seat with anything when using the seat heater. Using the seat heater with a blanket or cushion increases the temperature of the seat and may lead to overheating.
- Do not use seat heater more than necessary. Doing so may cause minor burns or overheating.

 NOTICE

■ **To prevent damage to the seat heaters/seat ventilators**

Do not put heavy objects that have an uneven surface on the seat and do not stick sharp objects (needles, nails, etc.) into the seat.

■ **To prevent battery discharge**

Turn the seat heaters/seat ventilators off when the engine is off.

Armrest

Fold down the armrest for use.

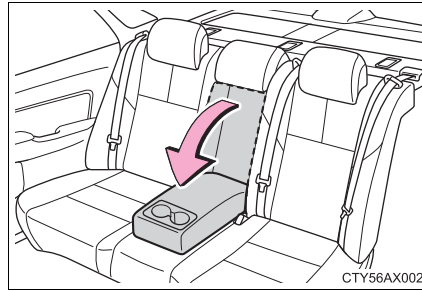

NOTICE

- **To prevent damage to the armrest**
Do not apply too much load on the armrest.

Rear sunshade*

The rear sunshade can be raised and lowered by pressing the switch shown below.

Extends/retracts the rear sunshade

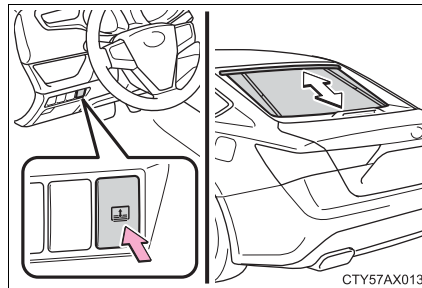

■ The rear sunshade can be used when

The engine switch is in IGNITION ON mode.

■ Reverse operation feature

To ensure adequate rear visibility, the rear sunshade automatically lowers when the shift lever is shifted to R.

However, the rear sunshade is raised again if either of the following occurs:

- The button is pressed again.
- The shift lever is shifted out of R, and the vehicle reaches a speed of 9 mph (15 km/h).

If the engine is turned off when the rear sunshade has been lowered due to the reverse operation feature, it will not be raised even when the engine is turned on again and the vehicle reaches a speed of 9 mph (15 km/h). To raise the sunshade again, press the button.

■ Customization

Settings (e.g. time elapsed before the reverse operation feature activates) can be changed.

(Customizable features: →P. 455)

*: If equipped

 CAUTION**■ When the rear sunshade is being raised or lowered**

Do not place fingers or other objects in the fastener section or in the opening. They may get caught, causing injury.

 NOTICE**■ To prevent battery discharge**

Do not operate the rear sunshade when the engine is not running.

■ To ensure normal operation of the sunshade

Observe the following precautions.

- Do not place excessive load on the motor or other components.
- Do not place objects where they may hinder opening and closing operations.
- Do not attach items to the rear sunshade.
- Keep the opening clean and clear of obstructions.
- Do not operate the rear sunshade continuously for long periods of time.

Trunk storage extension

Long objects can be loaded into the vehicle by utilizing the trunk space and rear seat area.

- 1 Fold down the armrest.

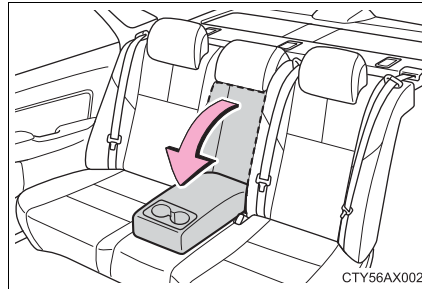

- 2 Push down the handle and open the armrest door.

The armrest door can be locked and unlocked using the mechanical key.

- ① Lock
- ② Unlock

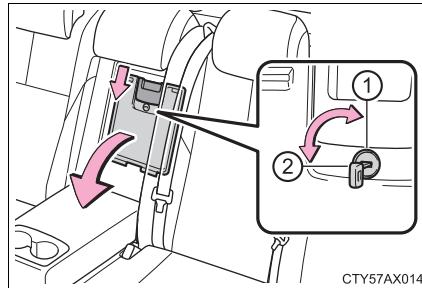

CAUTION

When not in use

Ensure that the armrest door is closed.

In the event of sudden braking, items stored in the trunk may be thrown forward into the cabin, resulting in injury.

Coat hooks

The coat hooks are provided with the rear assist grips.

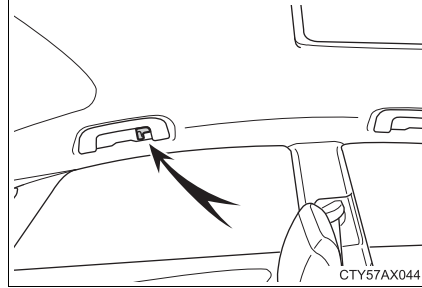

CAUTION

■ Items that cannot be hung on the coat hook

Do not hang coat hangers or other hard or sharp objects on the hook. If the SRS curtain shield airbags deploy, these items may become projectiles, causing death or serious injury.

Assist grips

An assist grip installed on the ceiling can be used to support your body while sitting on the seat.

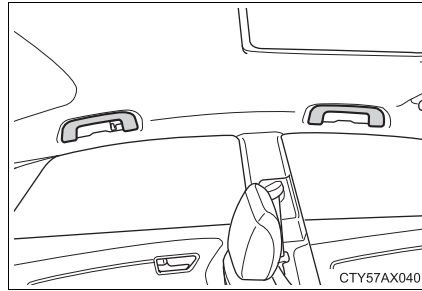

CAUTION

■ Assist grip

Do not use the assist grip when getting in or out of the vehicle or rising from your seat.

NOTICE

■ To prevent damage to the assist grip

Do not hang any heavy object or put a heavy load on the assist grip.

Garage door opener*

The garage door opener can be programmed to operate garage doors, gates, entry doors, door locks, home lighting systems, security systems, and other devices.

The garage door opener (HomeLink® Universal Transceiver) is manufactured under license from HomeLink®.

Programming the HomeLink® (for U.S.A. owners)

The HomeLink® compatible transceiver in your vehicle has 3 buttons which can be programmed to operate 3 different devices. Refer to the programming method below appropriate for the device.

- ① Indicator light
- ② Buttons

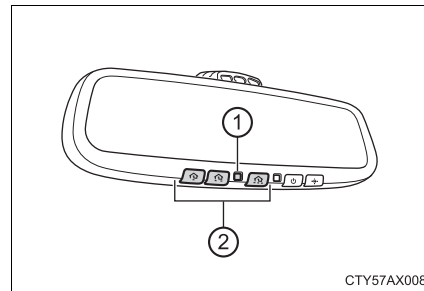

5

Interior features

*: If equipped

■ **Programming the HomeLink®**

- 1 Point the remote control for the device 1 to 3 in. (25 to 75 mm) from the HomeLink® control buttons.

Keep the indicator light on the HomeLink® in view while programming.

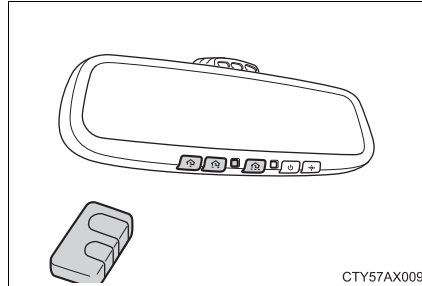

- 2 Press and hold one of the HomeLink® buttons and the transmitter button. When the HomeLink® indicator light changes from a slow to a rapid flash, you can release both buttons.

If the HomeLink® indicator light comes on but does not flash, or flashes rapidly for 2 seconds and remains lit, the HomeLink® button is already programmed. Use the other buttons or follow the “Reprogramming a HomeLink® button” instructions. (→P. 288)

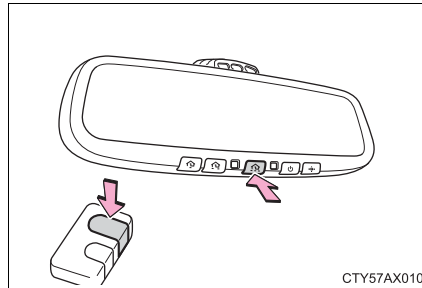

- 3 Test the operation of the HomeLink® by pressing the newly programmed button.

If programming a garage door opener, check to see if the garage door opens and closes. If the garage door does not operate, see if your garage transmitter is of the Rolling Code type. Press and hold the programmed HomeLink® button. The garage door has the rolling code feature if the indicator light (on the HomeLink®) flashes rapidly for 2 seconds and then remains lit. If your transmitter is the Rolling Code type, proceed to the heading “Programming a rolling code system”.

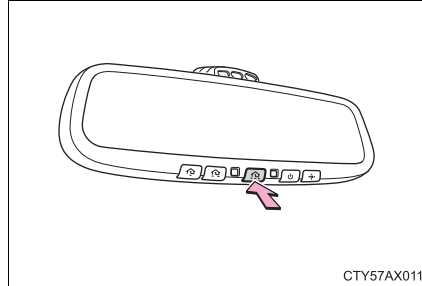

- 4 Repeat the steps above to program another device for each of the remaining HomeLink® buttons.

■ Programming a Rolling Code system (for U.S.A. owners)

If your device is Rolling Code equipped, follow the steps under the heading “Programming the HomeLink[®]” before proceeding with the steps listed below.

- 1 Locate the training button on the ceiling mounted garage door opener motor. The exact location and color of the button may vary by brand of garage door opener.

Refer to the operation manual supplied with the garage door opener for the location of the training button.

- 2 Press the training button.

Following this step, you have 30 seconds in which to initiate step 3 below.

- 3 Press and hold the vehicle’s programmed HomeLink[®] button for 2 seconds and release it. Repeat this step once again. The garage door may open.

If the garage door opens, the programming process is complete. If the door does not open, press and release the button a third time. This third press and release will complete the programming process by opening the garage door.

The ceiling mounted garage door opener motor should now recognize the HomeLink[®] transceiver and operate the garage door.

- 4 Repeat the steps above to program another rolling code system for any of the remaining HomeLink[®] buttons.

■ Programming an entry gate (for U.S.A. owners)/Programming all devices in the Canadian market

- 1 Place your transmitter 1 to 3 in. (25 to 75 mm) away from the surface of the HomeLink®.

Keep the indicator light on the HomeLink® in view while programming.

- 2 Press and hold the selected HomeLink® button.
- 3 Repeatedly press and release (cycle) the device's remote control button for two seconds each until step 4 is completed.
- 4 When the indicator light on the HomeLink® compatible transceiver starts to flash rapidly, release the buttons.
- 5 Test the operation of the HomeLink® by pressing the newly programmed button. Check to see if the gate/device operates correctly.
- 6 Repeat the steps above to program another device for each of the remaining HomeLink® buttons.

■ Programming other devices

To program other devices such as home security systems, home door locks or lighting, contact your authorized Toyota dealer for assistance.

■ Reprogramming a button

The individual HomeLink® buttons cannot be erased but can be reprogrammed. To reprogram a button, follow the "Basic programming" instructions.

Operating the HomeLink®

Press the appropriate HomeLink® button. The HomeLink® indicator light on the HomeLink® transceiver should turn on.

The HomeLink® continues to send a signal for up to 20 seconds as long as the button is pressed.

Reprogramming a HomeLink® button

Press and hold the desired HomeLink® button. After 20 seconds, the HomeLink® indicator light will start flashing slowly. Keep pressing the HomeLink® button and press and hold the transmitter button until the HomeLink® indicator light changes from a slow to a rapid flash. Release the buttons.

Erasing the entire HomeLink® memory (all three programs)

Press and hold down the 2 outside buttons for 10 seconds until the indicator light flashes.

If you sell your vehicle, be sure to erase the programs stored in the HomeLink® memory.

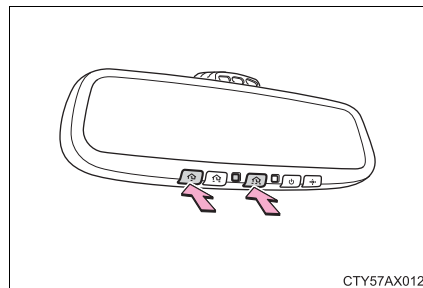

■ Before programming

- Install a new battery in the transmitter.
- The battery side of the transmitter must be pointed away from the HomeLink®.

■ Certification for the garage door opener

- ▶ For vehicles sold in U.S.A.

FCC ID: NZLWZLHL4

NOTE:

This device complies with Part 15 of the FCC Rules.

Operation is subject to the following two conditions: (1) this device may not cause harmful interference, and (2) this device must accept any interference received, including interference that may cause undesired operation.

FCC WARNING:

Changes or modifications not expressly approved by the party responsible for compliance could void the user's authority to operate the equipment.

- ▶ For vehicles sold in Canada

NOTE:

Operation is subject to the following two conditions: (1) this device may not cause interference, and (2) this device must accept any interference, including interference that may cause undesired operation of the device.

■ For additional programming assistance with your HomeLink® Universal Transceiver

Visit on the web at www.homelink.com or call 1-800-355-3515.

⚠ CAUTION**■ When programming a garage door or other remote control device**

The garage door may operate, so ensure people and objects are out of danger to prevent potential harm.

■ Conforming to federal safety standards

Do not use the HomeLink® Compatible Transceiver with any garage door opener or device that lacks safety stop and reverse features as required by federal safety standards.

This includes any garage door that cannot detect an obstruction object. A door or device without these features increases the risk of death or serious injury.

Safety Connect*

Safety Connect is a subscription-based telematics service that uses Global Positioning System (GPS) data and embedded cellular technology to provide safety and security features to subscribers. Safety Connect is supported by Toyota's designated response center, which operates 24 hours per day, 7 days per week.

Safety Connect service is available by subscription on select, telematics hardware-equipped vehicles.

By using the Safety Connect service, you are agreeing to be bound by the Telematics Subscription Service Agreement and its Terms and Conditions, as in effect and amended from time to time, a current copy of which is available at Toyota.com. All use of the Safety Connect service is subject to such then-applicable Terms and Conditions.

■ System components

- ① Microphone
- ② LED light indicators
- ③ "SOS" button

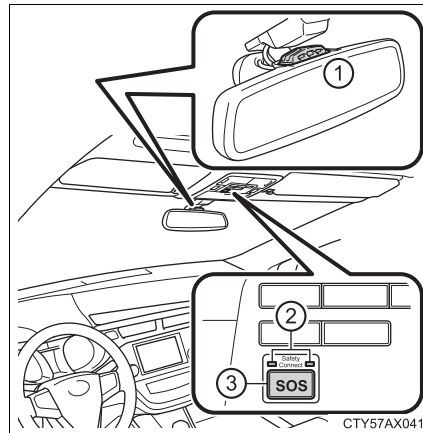

*: If equipped

■ Services

Subscribers have the following Safety Connect services available:

● Automatic Collision Notification*

Helps drivers receive necessary response from emergency service providers. (→P. 293)

*: U.S. Patent No. 7,508,298 B2

● Stolen Vehicle Location

Helps drivers in the event of vehicle theft. (→P. 294)

● Emergency Assistance Button (SOS)

Connects drivers to response-center support. (→P. 294)

● Enhanced Roadside Assistance

Provides drivers various on-road assistance. (→P. 294)

■ Subscription

After you have signed the Telematics Subscription Service Agreement and are enrolled, you can begin receiving services.

A variety of subscription terms is available for purchase. Contact your Toyota dealer, call 1-800-331-4331, or push the “SOS” button in your vehicle for further subscription details.

■ **Safety Connect Services Information**

- Phone calls using the vehicles Bluetooth® technology will not be possible during Safety Connect.
- Safety Connect is available beginning Fall 2009 on select Toyota models. Contact with the Safety Connect response center is dependent upon the telematics device being in operative condition, cellular connection availability, and GPS satellite signal reception, which can limit the ability to reach the response center or receive emergency service support. Enrollment and Telematics Subscription Service Agreement required. A variety of subscription terms is available; charges vary by subscription term selected.
- Automatic Collision Notification, Emergency Assistance, Stolen Vehicle Location, and Enhanced Roadside Assistance will function in the United States, including Hawaii and Alaska, and in Canada. No Safety Connect services will function outside of the United States in countries other than Canada.
- Safety Connect services are not subject to section 255 of the Telecommunications Act and the device is not TTY compatible.

■ **Languages**

The Safety Connect response center will offer support in multiple languages. The Safety Connect system will offer voice prompts in English and Spanish. Please indicate your language of choice when enrolling.

■ **When contacting the response center**

You may be unable to contact the response center if the network is busy.

Safety Connect LED light indicators

When the engine switch is turned to IGNITION ON mode, the red indicator light comes on for 2 seconds then turns off. Afterward, the green indicator light comes on, indicating that the service is active.

The following indicator light patterns indicate specific system usage conditions:

- Green indicator light on = Active service
- Green indicator light flashing = Safety Connect call in process
- Red indicator light (except at vehicle start-up) = System malfunction (contact your Toyota dealer)
- No indicator light (off) = Safety Connect service not active

Safety Connect services

■ Automatic Collision Notification

In case of either airbag deployment or severe rear-end collision, the system is designed to automatically call the response center. The responding agent receives the vehicle's location and attempts to speak with the vehicle occupants to assess the level of emergency. If the occupants are unable to communicate, the agent automatically treats the call as an emergency, contacts the nearest emergency services provider to describe the situation, and requests that assistance be sent to the location.

■ **Stolen Vehicle Location**

If your vehicle is stolen, Safety Connect can work with local authorities to assist them in locating and recovering the vehicle. After filing a police report, call the Safety Connect response center at 1-800-331-4331 and follow the prompts for Safety Connect to initiate this service.

In addition to assisting law enforcement with recovery of a stolen vehicle, Safety-Connect-equipped vehicle location data may, under certain circumstances, be shared with third parties to locate your vehicle. Further information is available at Toyota.com.

■ **Emergency Assistance Button (“SOS”)**

In the event of an emergency on the road, push the “SOS” button to reach the Safety Connect response center. The answering agent will determine your vehicle’s location, assess the emergency, and dispatch the necessary assistance required.

If you accidentally press the “SOS” button, tell the response-center agent that you are not experiencing an emergency.

■ **Enhanced Roadside Assistance**

Enhanced Roadside Assistance adds GPS data to the already included warranty-based Toyota roadside service.

Subscribers can press the “SOS” button to reach a Safety Connect response-center agent, who can help with a wide range of needs, such as: towing, flat tire, fuel delivery, etc. For a description of the Enhanced Roadside Assistance services and their limitations, please see the Safety Connect Terms and Conditions, which are available at Toyota.com.

Safety information for Safety Connect

Important! Read this information before using Safety Connect.

■ Exposure to radio frequency signals

The Safety Connect system installed in your vehicle is a low-power radio transmitter and receiver. It receives and also sends out radio frequency (RF) signals.

In August 1996, the Federal Communications Commission (FCC) adopted RF exposure guidelines with safety levels for mobile wireless phones. Those guidelines are consistent with the safety standards previously set by the following U.S. and international standards bodies.

- ANSI (American National Standards Institute) C95.1 [1992]
- NCRP (National Council on Radiation Protection and Measurement) Report 86 [1986]
- ICNIRP (International Commission on Non-Ionizing Radiation Protection) [1996]

Those standards were based on comprehensive and periodic evaluations of the relevant scientific literature. Over 120 scientists, engineers, and physicians from universities, and government health agencies and industries reviewed the available body of research to develop the ANSI Standard (C95.1).

The design of Safety Connect complies with the FCC guidelines in addition to those standards.

■ Certification for Safety Connect

FCC ID: O6Y-CDMRF101

FCC ID: XOECDMRF101B

FCC ID: N7NGTM2

NOTE:

This device complies with Part 15 of the FCC Rules. Operation is subject to the following two conditions: (1) This device may not cause harmful interference, and (2) this device must accept any interference received, including interference that may cause undesired operation.

FCC WARNING:

Changes or modifications not expressly approved by the party responsible for compliance could void the user's authority to operate the equipment.

Compass*

The compass on the inside rear view mirror indicates the direction in which the vehicle is heading.

■ Operation

To turn the compass on or off, press the switch for more than 3 seconds.

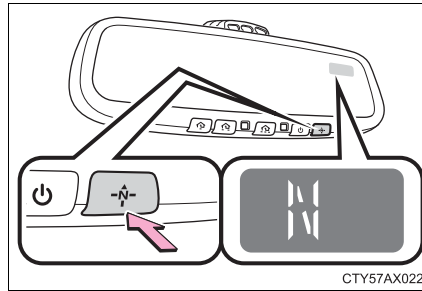

■ Displays and directions

Display	Direction
N	North
NE	Northeast
E	East
SE	Southeast
S	South
SW	Southwest
W	West
NW	Northwest

*: If equipped

Calibrating the compass

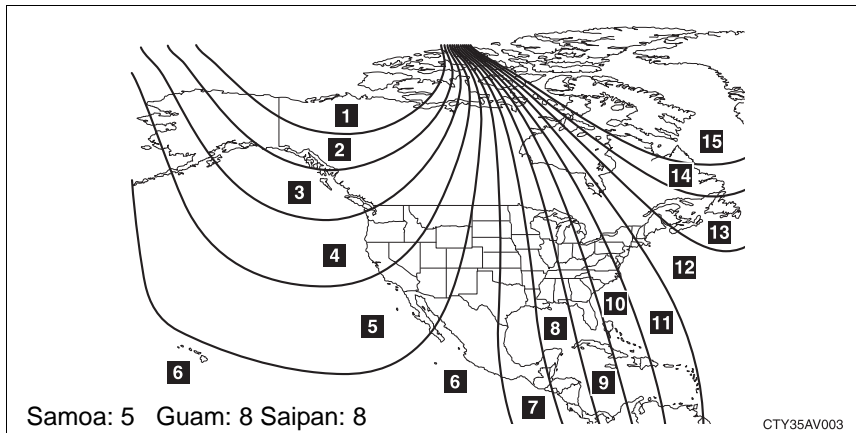

The direction display deviates from the true direction determined by the earth's magnetic field. The amount of deviation varies according to the geographic position of the vehicle.

If you cross over a map boundary shown in illustration, the compass will deviate.

To obtain higher precision or perfect calibration, refer to the following.

■ Deviation calibration

- 1 Stop the vehicle.
- 2 Press and hold the switch.
A number (1 to 15) appears on the compass display.

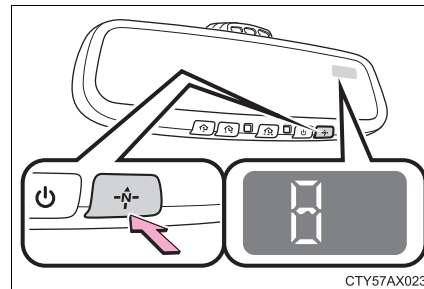

- 3 Referring to the map above, press the switch to select the number of the zone you are in.
If the direction is displayed several seconds after adjustment, the calibration is complete.

■ **Circling calibration**

When “C” appears on the display, drive the vehicle at 5 mph (8 km/h) or less in a circle until a direction is displayed.

If there is not enough space to drive in a circle, drive around the block until the direction is displayed.

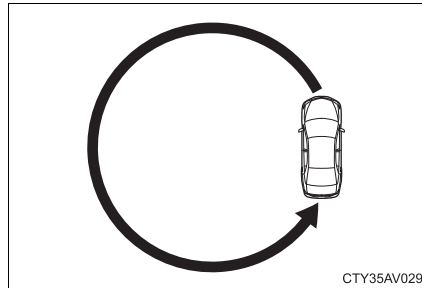

■ **Conditions unfavorable to correct operation**

The compass may not show the correct direction in the following conditions:

- The vehicle is stopped immediately after turning.
- The vehicle is on an inclined surface.
- The vehicle is in a place where the earth’s magnetic field is subject to interference by artificial magnetic fields (underground car park/parking lot, under a steel tower, between buildings, roof car park/parking lot, near an intersection, near a large vehicle, etc.).
- The vehicle has become magnetized.
(There is a magnet or metal object near the inside rear view mirror.)
- The battery has been disconnected.
- A door is open.

<p>⚠ CAUTION</p>
<p>■ While driving Do not adjust the display. Be sure to adjust the display only when the vehicle is stopped.</p> <p>■ When doing the circling calibration Be sure to secure a wide space, and watch out for people and vehicles in the neighborhood. Do not violate any local traffic rules while performing circling calibration.</p>

 NOTICE**■ To avoid the compass malfunctions**

Do not place magnets or any metal objects near the inside rear view mirror. Doing this may cause a malfunction of the compass sensor.

■ To ensure normal operation of the compass

- Do not perform circling calibration of the compass in a place where the earth's magnetic field is subject to interference by artificial magnetic fields.
- During calibration, do not operate electric systems (moon roof, power windows, etc.) as they may interfere with the calibration.

Maintenance and care**6**

6-1. Maintenance and care	
Cleaning and protecting the vehicle exterior.....	302
Cleaning and protecting the vehicle interior.....	306
6-2. Maintenance	
Maintenance requirements	309
General maintenance.....	311
Emission inspection and maintenance (I/M) programs.....	315
6-3. Do-it-yourself maintenance	
Do-it-yourself service precautions	316
Hood	319
Positioning a floor jack	320
Engine compartment.....	322
Tires	334
Tire inflation pressure	342
Wheels	345
Air conditioning filter.....	348
Electronic key battery.....	350
Checking and replacing fuses	352
Light bulbs.....	361

Cleaning and protecting the vehicle exterior

Perform the following to protect the vehicle and maintain it in prime condition:

- Working from top to bottom, liberally apply water to the vehicle body, wheel wells and underside of the vehicle to remove any dirt and dust.
- Wash the vehicle body using a sponge or soft cloth, such as a chamois.
- For hard-to-remove marks, use car wash soap and rinse thoroughly with water.
- Wipe away any water.
- Wax the vehicle when the waterproof coating deteriorates.
If water does not bead on a clean surface, apply wax when the vehicle body is cool.

■ Automatic car washes

- Fold the mirrors before washing the vehicle. Start washing from the front of the vehicle. Make sure to extend the mirrors before driving.
- Brushes used in automatic car washes may scratch the vehicle surface and harm your vehicle's paint.

■ High pressure car washes

- Do not allow the nozzles of the car wash to come within close proximity of the windows.
- Before using the car wash, check that the fuel filler door on your vehicle is closed properly.

■ When using a car wash

If the door handle becomes wet while the electronic key is within the effective range, the door may lock and unlock repeatedly. In that case, follow the following correction procedures to wash the vehicle:

- Place the key in a position 6 ft. (2 m) or more separate from the vehicle while the vehicle is being washed. (Take care to ensure that the key is not stolen.)
- Set the electronic key to battery-saving mode to disable the smart key system. (→P. 101)

■ Aluminum wheels

- Remove any dirt immediately by using a neutral detergent. Do not use hard brushes or abrasive cleaners. Do not use strong or harsh chemical cleaners.
Use the same mild detergent and wax as used on the paint.
- Do not use detergent on the wheels when they are hot, for example after driving for long distance in the hot weather.
- Wash detergent from the wheels immediately after use.

■ Bumpers

Do not scrub with abrasive cleaners.

⚠ CAUTION

■ **When washing the vehicle**

Do not apply water to the inside of the engine compartment. Doing so may cause the electrical components etc. to catch fire.

■ **When cleaning the windshield (vehicles with rain-sensing windshield wipers)**

Set the wiper switch to off.

If the wiper switch is in "AUTO", the wipers may operate unexpectedly in the following situations, and may result in hands being caught or other serious injuries and cause damage to the wiper blades.

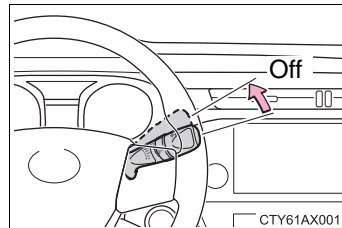

- When the upper part of the windshield where the raindrop sensor is located is touched by hand
- When a wet rag or similar is held close to the raindrop sensor
- If something bumps against the windshield
- If you directly touch the raindrop sensor body or if something bumps into the raindrop sensor

■ **Precautions regarding the exhaust pipes**

Exhaust gases cause the exhaust pipes to become quite hot.

When washing the vehicle, be careful not to touch the pipes until they have cooled sufficiently, as touching hot exhaust pipes can cause burns.

■ **Precaution regarding the Blind Spot Monitor (if equipped)**

If the paint of the rear bumper is chipped or scratched, the system may malfunction. If this occurs, consult your Toyota dealer.

 NOTICE**■ To prevent paint deterioration and corrosion on the body and components (aluminum wheels etc.)**

● Wash the vehicle immediately in the following cases:

- After driving near the sea coast
- After driving on salted roads
- If coal tar or tree sap is present on the paint surface
- If dead insects, insect droppings or bird droppings are present on the paint surface
- After driving in an area contaminated with soot, oily smoke, mine dust, iron powder or chemical substances
- If the vehicle becomes heavily soiled with dust or mud
- If liquids such as benzene and gasoline are spilled on the paint surface

● If the paint is chipped or scratched, have it repaired immediately.

● To prevent the wheels from corroding, remove any dirt and store in a place with low humidity when storing the wheels.

■ Cleaning the exterior lights

● Wash carefully. Do not use organic substances or scrub with a hard brush. This may damage the surfaces of the lights.

● Do not apply wax to the surfaces of the lights. Wax may cause damage to the lenses.

■ To prevent damage to the windshield wiper arms

When lifting the wiper arms away from the windshield, pull the driver side wiper arm upward first, and repeat for the passenger side. When returning the wipers to their original position, do so from the passenger side first.

■ When using an automatic car wash (vehicles with rain-sensing windshield wipers)

Set the wipers switch to off.

If AUTO mode is selected, the wipers may operate and the wiper blades may be damaged.

Cleaning and protecting the vehicle interior

The following procedures will help protect your vehicle's interior and keep it in top condition:

Protecting the vehicle interior

Remove dirt and dust using a vacuum cleaner. Wipe dirty surfaces with a cloth dampened with lukewarm water.

Cleaning the leather areas

- Remove dirt and dust using a vacuum cleaner.
- Wipe off any excess dirt and dust with a soft cloth dampened with diluted detergent.
Use a diluted water solution of approximately 5% neutral wool detergent.
- Wring out any excess water from the cloth and thoroughly wipe off all remaining traces of detergent.
- Wipe the surface with a dry, soft cloth to remove any remaining moisture. Allow the leather to dry in a shaded and ventilated area.

Cleaning the synthetic leather areas

- Remove loose dirt using a vacuum cleaner.
- Apply a mild soap solution to the synthetic leather using a sponge or soft cloth.
- Allow the solution to soak in for a few minutes. Remove the dirt and wipe off the solution with a clean, damp cloth.

■ Caring for leather areas

Toyota recommends cleaning the interior of the vehicle at least twice a year to maintain the quality of the vehicle's interior.

■ Shampooing the carpets

There are several commercial foaming-type cleaners available. Use a sponge or brush to apply the foam. Rub in overlapping circles. Do not use water. Wipe dirty surfaces and let them dry. Excellent results are obtained by keeping the carpet as dry as possible.

■ Seat belts

Clean with mild soap and lukewarm water using a cloth or sponge. Also check the belts periodically for excessive wear, fraying or cuts.

■ When cleaning the carpeted portions of the glove box, console box, etc.

If a strong adhesive tape is used, there is a possibility that the surface of the carpet could be damaged.

▲ CAUTION**■ Water in the vehicle**

- Do not splash or spill liquid in the vehicle.
Doing so may cause electrical components etc. to malfunction or catch fire.
- Do not get any of the SRS components or wiring in the vehicle interior wet.
(→P. 35)
An electrical malfunction may cause the airbags to deploy or not function properly, resulting in death or serious injury.

■ Cleaning the interior (especially instrument panel)

Do not use polish wax or polish cleaner. The instrument panel may reflect off the windshield, obstructing the driver's view and leading to an accident, resulting in death or serious injury.

 NOTICE**■ Cleaning detergents**

- Do not use the following types of detergent, as they may discolor the vehicle interior or cause streaks or damage to painted surfaces:
 - Non-seat portions: Organic substances such as benzene or gasoline, alkaline or acidic solutions, dye, and bleach
 - Seats: Alkaline or acidic solutions, such as thinner, benzene, and alcohol
- Do not use polish wax or polish cleaner. The instrument panel's or other interior part's painted surface may be damaged.

■ Preventing damage to leather surfaces

Observe the following precautions to avoid damage to and deterioration of leather surfaces:

- Remove any dust or dirt from leather surfaces immediately.
- Do not expose the vehicle to direct sunlight for extended periods of time. Park the vehicle in the shade, especially during summer.
- Do not place items made of vinyl, plastic, or containing wax on the upholstery, as they may stick to the leather surface if the vehicle interior heats up significantly.

■ Water on the floor

Do not wash the vehicle floor with water.

Vehicle systems such as the audio system may be damaged if water comes into contact with electrical components such as the audio system above or under the floor of the vehicle. Water may also cause the body to rust.

■ Cleaning the inside of the rear window

- Do not use glass cleaner to clean the rear window, as this may cause damage to the rear window defogger heater wires or antenna. Use a cloth dampened with lukewarm water to gently wipe the window clean. Wipe the window in strokes running parallel to the heater wires or antenna.
- Be careful not to scratch or damage the heater wires or antenna.

Maintenance requirements

To ensure safe and economical driving, day-to-day care and regular maintenance are essential. It is the owner's responsibility to perform regular checks. Toyota recommends the following maintenance:

General maintenance

General maintenance should be performed on a daily basis. This can be done by yourself or by a Toyota dealer.

Scheduled maintenance

Scheduled maintenance should be performed at specified intervals according to the maintenance schedule.

For details about maintenance items and schedules, refer to the "Scheduled Maintenance Guide" or "Owner's Manual Supplement".

Do-it-yourself maintenance

You can perform some maintenance procedures by yourself. Please be aware that do-it-yourself maintenance may affect warranty coverage.

The use of Toyota Repair Manuals is recommended.

For details about warranty coverage, refer to the separate "Owner's Warranty Information Booklet" or "Owner's Manual Supplement".

■ Repair and replacement

It is recommended that genuine Toyota parts be used for repairs to ensure performance of each system. If non-Toyota parts are used in replacement or if a repair shop other than a Toyota dealer performs repairs, confirm the warranty coverage.

■ Resetting the message indicating maintenance is required (U.S.A. only)

After the required maintenance is performed according to the maintenance schedule, please reset the message.

To reset the data, follow the procedure described below:

- 1 Turn the engine switch off with the trip meter A reading shown. (→P. 78)
- 2 While pressing the trip meter reset knob (→P. 78), turn the engine switch to IGNITION ON mode
- 3 Continue to press and hold the knob until the trip meter displays "000000".

■ Allow inspection and repairs to be performed by a Toyota dealer

- Toyota technicians are well-trained specialists and are kept up to date with the latest service information. They are well informed about the operations of all systems on your vehicle.
- Keep a copy of the repair order. It proves that the maintenance that has been performed is under warranty coverage. If any problem should arise while your vehicle is under warranty, your Toyota dealer will promptly take care of it.

▲ CAUTION**■ If your vehicle is not properly maintained**

Improper maintenance could result in serious damage to the vehicle and possible death or serious injury.

■ Handling of the battery

- Engine exhaust, some of its constituents, and a wide variety of automobile components contain or emit chemicals known to the State of California to cause cancer and birth defects and other reproductive harm. Work in a well ventilated area.
- Oils, fuels and fluids contained in vehicles as well as waste produced by component wear contain or emit chemicals known to the State of California to cause cancer and birth defects or other reproductive harm. Avoid exposure and wash any affected area immediately.
- Battery posts, terminals and related accessories contain lead and lead compounds which are known to cause brain damage. Wash your hands after handling. (→P. 330)

General maintenance

Listed below are the general maintenance items that should be performed at the intervals specified in the “Owner’s Warranty Information Booklet” or “Owner’s Manual Supplement/Scheduled Maintenance Guide”. It is recommended that any problem you notice should be brought to the attention of your Toyota dealer or qualified service shop for advice.

Engine compartment

Items	Check points
Battery	Check the battery fluid level and connections. (→P. 330)
Brake fluid	Is the brake fluid at the correct level? (→P. 329)
Engine coolant	Is the engine coolant at the correct level? (→P. 326)
Engine oil	Is the engine oil at the correct level? (→P. 323)
Exhaust system	There should not be any fumes or strange sounds.
Radiator/condenser	The radiator and condenser should be free from foreign objects. (→P. 328)
Washer fluid	Is there sufficient washer fluid? (→P. 333)

Vehicle interior

Items	Check points
Accelerator pedal	<ul style="list-style-type: none"> The accelerator pedal should move smoothly (without uneven pedal effort or catching).
Automatic transmission "Park" mechanism	<ul style="list-style-type: none"> When parked on a slope and the shift lever is in P, is the vehicle securely stopped?
Brake pedal	<ul style="list-style-type: none"> Does the brake pedal move smoothly? Does the brake pedal have appropriate clearance from the floor? (→P. 436) Does the brake pedal have the correct amount of free play? (→P. 436)
Brakes	<ul style="list-style-type: none"> The vehicle should not pull to one side when the brakes are applied. The brakes should work effectively. The brake pedal should not feel spongy. The brake pedal should not get too close to the floor when the brakes are applied.

Items	Check points
Head restraints	<ul style="list-style-type: none"> • Do the head restraints move smoothly and lock securely?
Indicators/buzzers	<ul style="list-style-type: none"> • Do the indicators and buzzers function properly?
Lights	<ul style="list-style-type: none"> • Do all the lights come on?
Parking brake	<ul style="list-style-type: none"> • Moves smoothly? • When parked on a slope and the parking brake is on, is the vehicle securely stopped?
Seat belts	<ul style="list-style-type: none"> • Do the seat belts operate smoothly? • The seat belts should not be damaged.
Seats	<ul style="list-style-type: none"> • Do the seat controls operate properly?
Steering wheel	<ul style="list-style-type: none"> • Does the steering wheel rotate smoothly? • Does the steering wheel have the correct amount of free play? • There should not be any strange sounds coming from the steering wheel.

Vehicle exterior

Items	Check points
Doors/trunk	<ul style="list-style-type: none"> Do the doors/trunk operate smoothly?
Engine hood	<ul style="list-style-type: none"> Does the engine hood lock system work properly?
Fluid leaks	<ul style="list-style-type: none"> There should not be any signs of fluid leakage after the vehicle has been parked.
Tires	<ul style="list-style-type: none"> Is the tire inflation pressure correct? The tires should not be damaged or excessively worn. Have the tires been rotated according to the maintenance schedule? The wheel nuts should not be loose.
Windshield wipers	<ul style="list-style-type: none"> The wiper blades should not show any signs of cracking, splitting, wear, contamination or deformation. The wiper blades should clear the windshield without streaking or skipping.

 **CAUTION**

■ If the engine is running

Turn the engine off and ensure that there is adequate ventilation before performing maintenance checks.

Emission inspection and maintenance (I/M) programs

Some states have vehicle emission inspection programs which include OBD (On Board Diagnostics) checks. The OBD system monitors the operation of the emission control system.

If the malfunction indicator lamp comes on

The OBD system determines that a problem exists somewhere in the emission control system. Your vehicle may not pass the I/M test and may need to be repaired. Contact your Toyota dealer to service the vehicle.

Your vehicle may not pass the I/M test in the following situations:

- When the battery is disconnected or discharged
Readiness codes that are set during ordinary driving are erased. Also, depending on your driving habits, the readiness codes may not be completely set.
- When the fuel tank cap is loose
The malfunction indicator lamp comes on indicating a temporary malfunction and your vehicle may not pass the I/M test.

When the malfunction indicator lamp still remains on after several driving trips

The error code in the OBD system will not be cleared unless the vehicle is driven 40 or more times.

If your vehicle does not pass the I/M test

Contact your Toyota dealer to prepare the vehicle for re-testing.

Do-it-yourself service precautions

If you perform maintenance by yourself, be sure to follow the correct procedure as given in these sections.

Items	Parts and tools
Battery condition(→P. 330)	<ul style="list-style-type: none"> • Warm water • Baking soda • Grease • Conventional wrench (for terminal clamp bolts) • Distilled water
Brake fluid level (→P. 329)	<ul style="list-style-type: none"> • FMVSS No.116 DOT 3 or SAE J1703 brake fluid • Rag or paper towel • Funnel (used only for adding brake fluid)
Engine coolant level (→P. 326)	<ul style="list-style-type: none"> • “Toyota Super Long Life Coolant” or a similar high quality ethylene glycol-based non-silicate, non-amine, non-nitrite and non-borate coolant with long-life hybrid organic acid technology For the U.S.A.: “Toyota Super Long Life Coolant” is pre-mixed with 50% coolant and 50% deionized water. For Canada: “Toyota Super Long Life Coolant” is pre-mixed with 55% coolant and 45% deionized water. • Funnel (used only for adding coolant)
Engine oil level (→P. 323)	<ul style="list-style-type: none"> • “Toyota Genuine Motor Oil” or equivalent • Rag or paper towel • Funnel (used only for adding engine oil)

Items	Parts and tools
Fuses (→P. 352)	<ul style="list-style-type: none"> • Fuse with same amperage rating as original
Light bulbs (→P. 361)	<ul style="list-style-type: none"> • Bulb with same number and wattage rating as original • Phillips-head screwdriver • Flathead screwdriver • Wrench
Radiator and condenser (→P. 328)	—
Tire inflation pressure (→P. 342)	<ul style="list-style-type: none"> • Tire pressure gauge • Compressed air source
Washer fluid (→P. 333)	<ul style="list-style-type: none"> • Water or washer fluid containing antifreeze (for winter use) • Funnel (used only for adding water or washer fluid)

 **CAUTION**

The engine compartment contains many mechanisms and fluids that may move suddenly, become hot, or become electrically energized. To avoid death or serious injury, observe the following precautions.

■ When working on the engine compartment

- Keep hands, clothing and tools away from the moving fan and engine drive belt.
- Be careful not to touch the engine, radiator, exhaust manifold, etc. right after driving as they may be hot. Oil and other fluids may also be hot.
- Do not leave anything that may burn easily, such as paper and rags, in the engine compartment.
- Do not smoke, cause sparks or expose an open flame to fuel or the battery. Fuel and battery fumes are flammable.
- Be extremely cautious when working on the battery. It contains poisonous and corrosive sulfuric acid.

■ When working near the electric cooling fans or radiator grille

Be sure the engine switch is off.

With the engine switch in IGNITION ON mode, the electric cooling fans may automatically start to run if the air conditioning is on and/or the coolant temperature is high. (→P. 328)

■ Safety glasses

Wear safety glasses to prevent flying or falling material, fluid spray, etc. from getting in your eyes.

 **NOTICE****■ If you remove the air cleaner filter**

Driving with the air cleaner filter removed may cause excessive engine wear due to dirt in the air.

Hood

Release the lock from the inside of the vehicle to open the hood.

- 1 Pull the hood lock release lever.
The hood will pop up slightly.

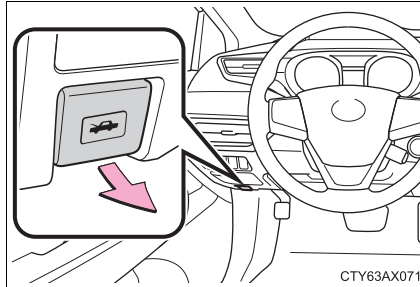

- 2 Pull up the auxiliary catch lever and lift the hood.

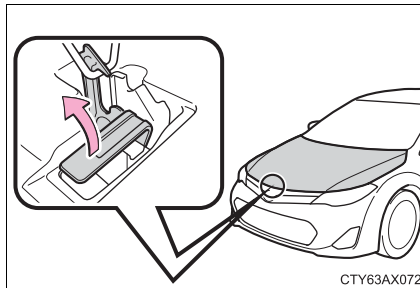

⚠ CAUTION

■ Pre-driving check

Check that the hood is fully closed and locked.
If the hood is not locked properly, it may open while the vehicle is in motion and cause an accident, which may result in death or serious injury.

Positioning a floor jack

When raising your vehicle with a floor jack, position the jack correctly. Improper placement may damage your vehicle or cause injury.

◆ Front

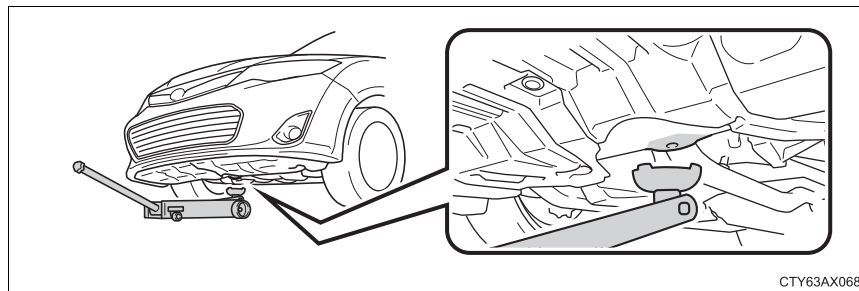

◆ Rear

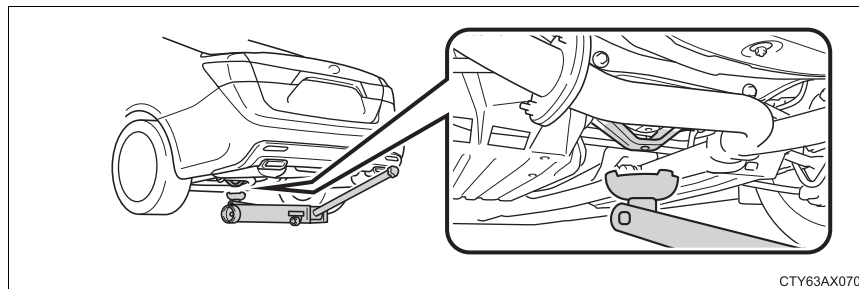

⚠ CAUTION

■ When raising your vehicle

Make sure to observe the following precautions to reduce the possibility of death or serious injury:

- Lift up the vehicle using a floor jack such as the one shown in the illustration.

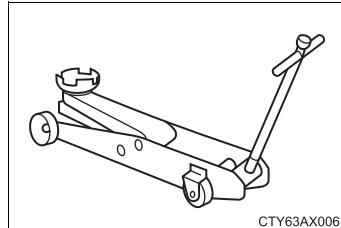

- When using a floor jack, follow the instructions of the manual provided with the jack.
- Do not use the jack that was supplied with your vehicle.
- Do not put any part of your body underneath the vehicle when it is supported only by the floor jack.
- Always use floor jack and/or automotive jack stands on a solid, flat, level surface.
- Do not start the engine while the vehicle is supported by the floor jack.
- Stop the vehicle on level, firm ground, firmly set the parking brake and shift the shift lever to P.
- Make sure to set the floor jack properly at the jack point.
Raising the vehicle with an improperly positioned floor jack will damage the vehicle and may cause the vehicle to fall off the floor jack.
- Do not raise the vehicle while someone is in the vehicle.
- When raising the vehicle, do not place any object on top of or underneath the floor jack.

Engine compartment

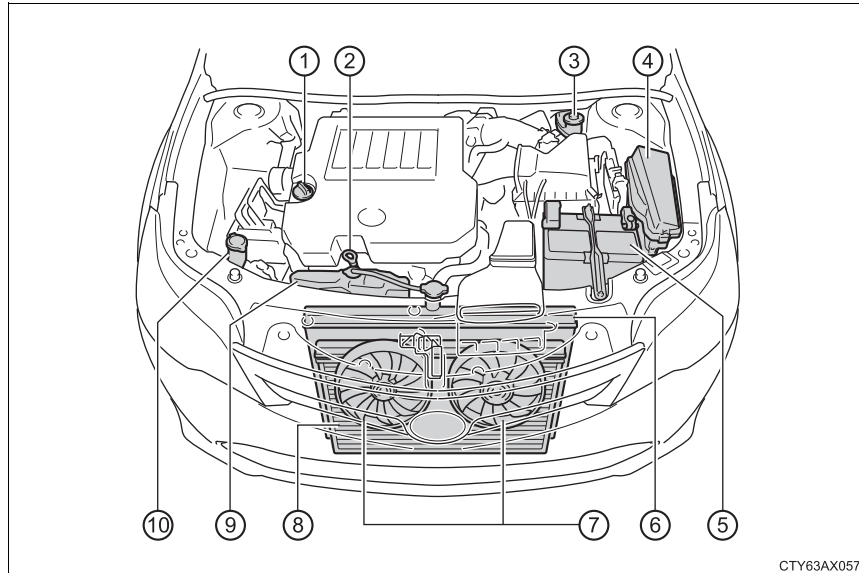

- | | |
|---------------------------------------|--------------------------------------|
| ① Engine oil filler cap (→P. 324) | ⑥ Radiator (→P. 328) |
| ② Engine oil level dipstick (→P. 323) | ⑦ Electric cooling fans |
| ③ Brake fluid reservoir (→P. 329) | ⑧ Condenser (→P. 328) |
| ④ Fuse box (→P. 352) | ⑨ Engine coolant reservoir (→P. 326) |
| ⑤ Battery (→P. 330) | ⑩ Washer fluid tank (→P. 333) |

Engine oil

With the engine at operating temperature and turned off, check the oil level on the dipstick.

■ Checking the engine oil

- 1 Park the vehicle on level ground. After warming up the engine and turning it off, wait more than 5 minutes for the oil to drain back into the bottom of the engine.

- 2 Holding a rag under the end, pull the dipstick out.

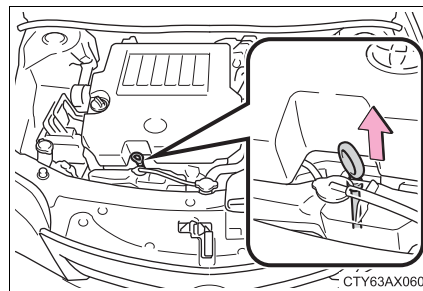

- 3 Wipe the dipstick clean.
- 4 Reinsert the dipstick fully.
- 5 Holding a rag under the end, pull the dipstick out and check the oil level.

- 1 Low
- 2 Normal
- 3 Excessive

The shape of the dipstick may differ depending on the type of vehicle or engine.

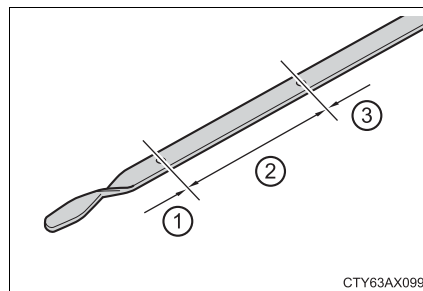

- 6 Wipe the dipstick and reinsert it fully.

■ Adding engine oil

If the oil level is below or near the low level mark, add engine oil of the same type as that already in the engine.

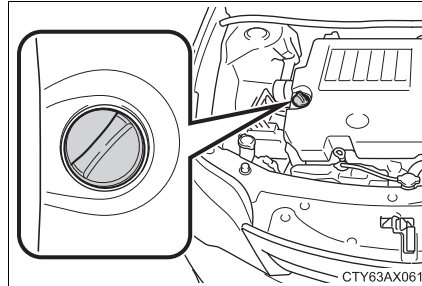

Make sure to check the oil type and prepare the items needed before adding oil.

Engine oil selection	→P. 433
Oil quantity (Low → Full)	1.6 qt. (1.5 L, 1.3 Imp. qt.)
Items	Clean funnel

- 1 Remove the oil filler cap by turning it counterclockwise.
- 2 Add engine oil slowly, checking the dipstick.
- 3 Install the oil filler cap by turning it clockwise.

■ Engine oil consumption

A certain amount of engine oil will be consumed while driving. In the following situations, oil consumption may increase, and engine oil may need to be refilled in between oil maintenance intervals.

- When the engine is new, for example directly after purchasing the vehicle or after replacing the engine
- If low quality oil or oil of an inappropriate viscosity is used
- When driving at high engine speeds or with a heavy load, or when driving while accelerating or decelerating frequently
- When leaving the engine idling for a long time, or when driving frequently through heavy traffic

 CAUTION**■ Used engine oil**

- Used engine oil contains potentially harmful contaminants which may cause skin disorders such as inflammation and skin cancer, so care should be taken to avoid prolonged and repeated contact. To remove used engine oil from your skin, wash thoroughly with soap and water.
- Dispose of used oil and filters only in a safe and acceptable manner. Do not dispose of used oil and filters in household trash, in sewers or onto the ground.
Call your Toyota dealer, service station or auto parts store for information concerning recycling or disposal.
- Do not leave used engine oil within the reach of children.

 NOTICE**■ To prevent serious engine damage**

Check the oil level on a regular basis.

■ When replacing the engine oil

- Be careful not to spill engine oil on the vehicle components.
- Avoid overfilling, or the engine could be damaged.
- Check the oil level on the dipstick every time you refill the vehicle.
- Be sure the engine oil filler cap is properly tightened.

Engine coolant

The coolant level is satisfactory if it is between the “F” and “L” lines on the reservoir when the engine is cold.

- ① Reservoir cap
- ② “F” line
- ③ “L” line

If the level is on or below the “L” line, add coolant up to the “F” line.
(→P. 423)

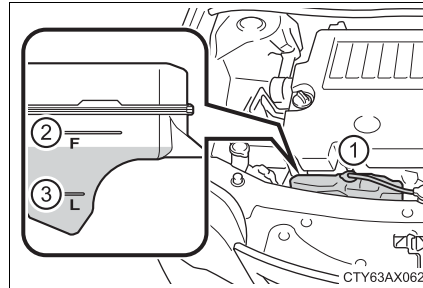

■ Coolant selection

Only use “Toyota Super Long Life Coolant” or a similar high quality ethylene glycol based non-silicate, non-amine, non-nitrite, and non-borate coolant with long-life hybrid organic acid technology.

U.S.A.:

“Toyota Super Long Life Coolant” is a mixture of 50% coolant and 50% deionized water. (Minimum temperature: -31°F [-35°C])

Canada:

“Toyota Super Long Life Coolant” is a mixture of 55% coolant and 45% deionized water. (Minimum temperature: -44°F [-42°C])

For more details about engine coolant, contact your Toyota dealer.

■ If the coolant level drops within a short time of replenishing

Visually check the radiator, hoses, engine coolant reservoir caps, drain cock and water pump.

If you cannot find a leak, have your Toyota dealer test the cap and check for leaks in the cooling system.

 CAUTION**■ When the engine is hot**

Do not remove the engine coolant reservoir cap or the radiator cap.
(→P. 425)

The cooling system may be under pressure and may spray hot coolant if the cap is removed, causing serious injuries, such as burns.

 NOTICE**■ When adding coolant**

Coolant is neither plain water nor straight antifreeze. The correct mixture of water and antifreeze must be used to provide proper lubrication, corrosion protection and cooling. Be sure to read the antifreeze or coolant label.

■ If you spill coolant

Be sure to wash it off with water to prevent it from damaging parts or paint.

Radiator and condenser

Check the radiator and condenser and clear away any foreign objects. If either of the above parts is extremely dirty or you are not sure of their condition, have your vehicle inspected by your Toyota dealer.

⚠ CAUTION**■ When the engine is hot**

Do not touch the radiator or condenser as they may be hot and cause serious injuries, such as burns.

Brake fluid

■ Checking fluid level

The brake fluid level should be between the “MAX” and “MIN” lines on the tank.

- ① “MAX” line
- ② “MIN” line

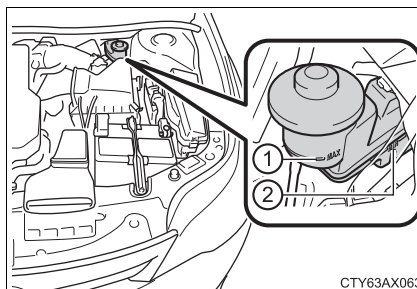

■ Adding fluid

Make sure to check the fluid type and prepare the necessary item.

Fluid type	FMVSS No.116 DOT 3 or SAE J1703 brake fluid
Items	Clean funnel

■ Brake fluid can absorb moisture from the air

Excess moisture in the brake fluid can cause a dangerous loss of braking efficiency. Use only newly opened brake fluid.

⚠ CAUTION

■ When filling the reservoir

Take care as brake fluid can harm your hands and eyes and damage painted surfaces.

If fluid gets on your hands or in your eyes, flush the affected area with clean water immediately.

If you still experience discomfort, see a doctor.

⚠ NOTICE

■ If the fluid level is low or high

It is normal for the brake fluid level to go down slightly as the brake pads wear out or when the fluid level in the accumulator is high.

If the reservoir needs frequent refilling, there may be a serious problem.

Battery

Check the battery as follows.

■ Battery exterior

Make sure that the battery terminals are not corroded and that there are no loose connections, cracks, or loose clamps.

- ① Terminals
- ② Hold-down clamp

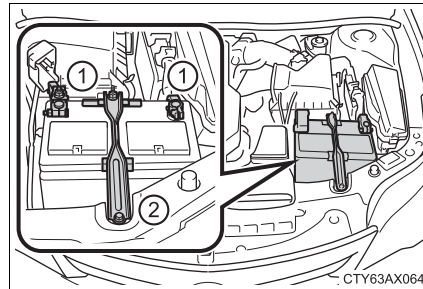

■ Before recharging

When recharging, the battery produces hydrogen gas which is flammable and explosive. Therefore, observe the following before recharging:

- If recharging with the battery installed on the vehicle, be sure to disconnect the ground cable.
- Make sure the power switch on the charger is off when connecting and disconnecting the charger cables to the battery.

■ After recharging/reconnecting the battery

The engine may not start. Follow the procedure below to initialize the system.

- 1 Shift the shift lever to P.
- 2 Open and close any of the doors.
- 3 Restart the engine.

- Unlocking the doors using the smart key system may not be possible immediately after reconnecting the battery. If this happens, use the wireless remote control or the mechanical key to lock/unlock the doors.
- Start the engine with the engine switch in ACCESSORY mode. The engine may not start when the engine switch turned from off. However, the engine will operate normally from the second attempt.
- The engine switch mode is recorded by the vehicle. If the battery is reconnected, the vehicle will return the engine switch mode to the status it was in before the battery was disconnected. Make sure to turn off the engine before disconnect the battery. Take extra care when connecting the battery if the engine switch mode prior to discharge is unknown.

If the system will not start even after multiple attempts, contact your Toyota dealer.

⚠ CAUTION**■ Chemicals in the battery**

Batteries contain poisonous and corrosive sulfuric acid and may produce hydrogen gas which is flammable and explosive. To reduce the risk of death or serious injury, take the following precautions while working on or near the battery:

- Do not cause sparks by touching the battery terminals with tools.
- Do not smoke or light a match near the battery.
- Avoid contact with eyes, skin and clothes.
- Never inhale or swallow electrolyte.
- Wear protective safety glasses when working near the battery.
- Keep children away from the battery.

 **CAUTION****■ Where to safely charge the battery**

Always charge the battery in an open area. Do not charge the battery in a garage or closed room where there is insufficient ventilation.

■ How to recharge the battery

Only perform a slow charge (5 A or less). The battery may explode if charged at a quicker rate.

■ Emergency measures regarding electrolyte**● If electrolyte gets in your eyes**

Flush your eyes with clean water for at least 15 minutes and get immediate medical attention. If possible, continue to apply water with a sponge or cloth while traveling to the nearest medical facility.

● If electrolyte gets on your skin

Wash the affected area thoroughly. If you feel pain or burning, get medical attention immediately.

● If electrolyte gets on your clothes

It can soak through clothing on to your skin. Immediately take off the clothing and follow the procedure above if necessary.

● If you accidentally swallow electrolyte

Drink a large quantity of water or milk. Get emergency medical attention immediately.

 **NOTICE****■ When recharging the battery**

Never recharge the battery while the engine is operating. Also, be sure all accessories are turned off.

Washer fluid

If any washer does not work or the warning message appears on the multi-information display, the washer tank may be empty. Add washer fluid.

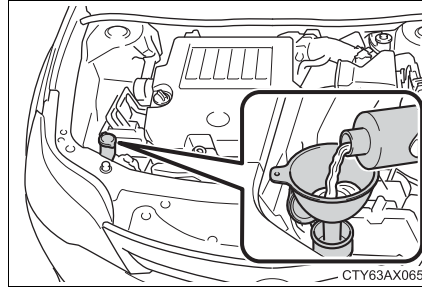
**⚠ CAUTION****■ When adding washer fluid**

Do not add washer fluid when the engine is hot or running as washer fluid contains alcohol and may catch fire if spilled on the engine etc.

⚠ NOTICE**■ Do not use any fluid other than washer fluid**

Do not use soapy water or engine antifreeze instead of washer fluid. Doing so may cause streaking on the vehicle's painted surfaces.

■ Diluting washer fluid

Dilute washer fluid with water as necessary. Refer to the freezing temperatures listed on the label of the washer fluid bottle.

Tires

Replace or rotate tires in accordance with maintenance schedules and treadwear.

Checking tires

- ① New tread
- ② Treadwear indicator
- ③ Worn tread

The location of treadwear indicators is shown by the “TWI” or “Δ” marks, etc., molded on the side-wall of each tire.

Check spare tire condition and pressure if not rotated.

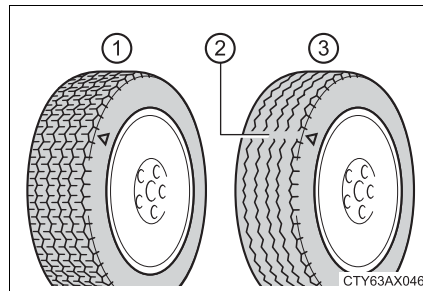

Tire rotation

Rotate the tires in the order shown.

To equalize tire wear and extend tire life, Toyota recommends that tire rotation is carried out at the same interval as tire inspection.

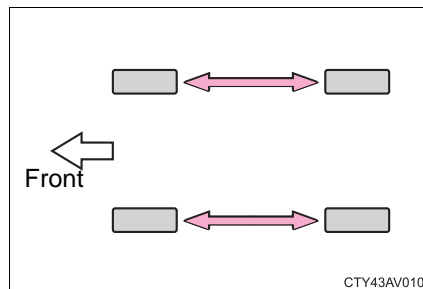

Tire pressure warning system

Your vehicle is equipped with a tire pressure warning system that uses tire pressure warning valves and transmitters to detect low tire inflation pressure before serious problems arise. (→P. 391)

◆ Installing tire pressure warning valves and transmitters

When replacing tires or wheels, tire pressure warning valves and transmitters must also be installed.

When new tire pressure warning valves and transmitters are installed, new ID codes must be registered in the tire pressure warning computer and the tire pressure warning system must be initialized. Have tire pressure warning valve and transmitter ID codes registered by your Toyota dealer. (→P. 337)

◆ Initializing the tire pressure warning system

■ The tire pressure warning system must be initialized in the following circumstances:

- When changing the tire size.
- When the tire inflation pressure is changed such as when changing traveling speed or load weight.

When the tire pressure warning system is initialized, the current tire inflation pressure is set as the benchmark pressure.

■ How to initialize the tire pressure warning system

- 1 Park the vehicle in a safe place and turn the engine switch off.

Initialization cannot be performed while the vehicle is moving.

- 2 Adjust the tire inflation pressure to the specified cold tire inflation pressure level. (→P. 437)

Make sure to adjust the tire pressure to the specified cold tire inflation pressure level. The tire pressure warning system will operate based on this pressure level.

- 3 Turn the engine switch to IGNITION ON mode.

- 4 Press and hold the tire pressure warning reset switch until the tire pressure warning light blinks slowly 3 times.

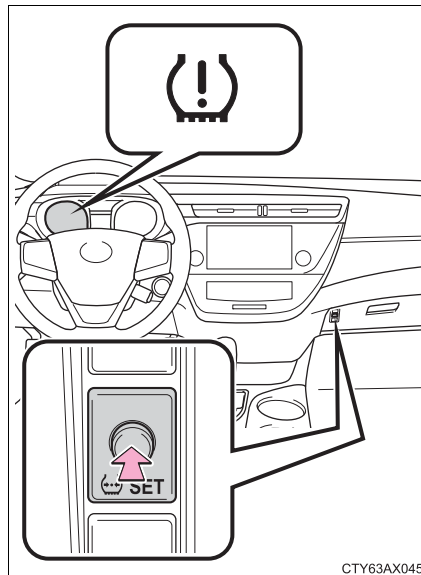

- 5 Wait for a few minutes with the engine switch in IGNITION ON mode and then turn the engine switch off.

◆ Registering ID codes

The tire pressure warning valve and transmitter is equipped with a unique ID code. When replacing a tire pressure warning valve and transmitter, it is necessary to register the ID code. Have the ID code registered by your Toyota dealer.

■ When to replace your vehicle's tires

Tires should be replaced if:

- You have tire damage such as cuts, splits, cracks deep enough to expose the fabric, and bulges indicating internal damage
- A tire goes flat repeatedly or cannot be properly repaired due to the size or location of a cut or other damage

If you are not sure, consult with your Toyota dealer.

■ Replacing tires and wheels

If the ID code of the tire pressure warning valve and transmitter is not registered, the tire pressure warning system will not work properly. After driving for about 20 minutes, the tire pressure warning light blinks for 1 minute and stays on to indicate a system malfunction.

■ Tire life

Any tire over 6 years old must be checked by a qualified technician even if it has seldom or never been used or damage is not obvious.

■ Routine tire inflation pressure checks

The tire pressure warning system does not replace routine tire inflation pressure checks. Make sure to check tire inflation pressure as part of your routine of daily vehicle checks.

■ Low profile tires (18-inch tires)

Generally, low profile tires will wear more rapidly and tire grip performance will be reduced on snowy and/or icy roads when compared to standard tires. Be sure to use snow tires or tire chains on snowy and/or icy roads and drive carefully at a speed appropriate for road and weather conditions.

■ Maximum load of tire

Check that the maximum load of the replacement tire is greater than 1/2 of the Gross Axle Weight Ratings (GAWR) of either the front axle or the rear axle, whichever is greater.

For the GAWR, see the Certification Label. For the maximum load of the tire, see the load limit at maximum cold tire inflation pressure mentioned on the sidewall of the tire. (→P. 442)

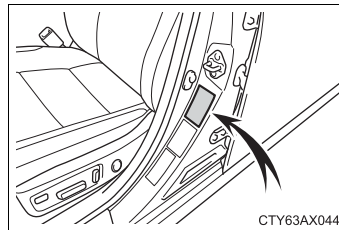
**■ Tire types****● Summer tires**

Summer tires are high-speed performance tires best suited to highway driving under dry conditions. Since summer tires do not have the same traction performance as snow tires, summer tires are inadequate for driving on snow-covered or icy roads. For driving on snow-covered roads or icy roads, the use of snow tires is recommended. When installing snow tires, be sure to replace all four tires.

● All season tires

All season tires are designed to provide better traction in snow and to be adequate for driving in most winter conditions as well as for use year-round. All season tires, however, do not have adequate traction performance compared with snow tires in heavy or loose snow. Also, all season tires fall short in acceleration and handling performance compared with summer tires in highway driving.

● Snow tires

For driving on snow-covered roads or icy roads, we recommend using snow tires. If you need snow tires, select tires of the same size, construction and load capacity as the originally installed tires. Since your vehicle has radial tires as original equipment, make sure your snow tires also have radial construction. Do not install studded tires without first checking local regulations for possible restrictions. Snow tires should be installed on all wheels. (→P. 236)

■ Initializing the tire pressure warning system

Initialize the system with the tire inflation pressure adjusted to the specified level.

■ If the tread on snow tires wears down below 0.16 in. (4 mm)

The effectiveness of the tires as snow tires is lost.

■ If you press the tire pressure warning reset switch accidentally

If initialization is performed, adjust the tire inflation pressure to the specified level and initialize the tire pressure warning system again.

■ When initialization of the tire pressure warning system has failed

Initialization can be completed in a few minutes. However, in the following cases, the settings have not been recorded and the system will not operate properly. If repeated attempts to record tire inflation pressure settings are unsuccessful, have the vehicle inspected by your Toyota dealer.

- When operating the tire pressure warning reset switch, the tire pressure warning light does not blink 3 times.
- After driving for a certain period of time since the initialization has been completed, the warning light comes on after blinking for 1 minute.

■ Tire pressure warning system certification

- ▶ For vehicles sold in the U.S.A.

FCC ID: PAXPMVC010

NOTE:

This device complies with part 15 of the FCC Rules. Operation is subject to the following two conditions: (1) this device may not cause harmful interference, and (2) this device must accept any interference received, including interference that may cause undesired operation.

FCC WARNING:

Changes or modifications not expressly approved by the party responsible for compliance could void the user's authority to operate the equipment.

- ▶ For vehicles sold in Canada

NOTE:

Operation is subject to the following two conditions: (1) this device may not cause interference, and (2) this device must accept any interference, including interference that may cause undesired operation of the device.

 **CAUTION****■ When inspecting or replacing tires**

Observe the following precautions to prevent accidents.

Failure to do so may cause damage to parts of the drive train as well as dangerous handling characteristics, which may lead to an accident resulting in death or serious injury.

- Do not mix tires of different makes, models or tread patterns.
Also, do not mix tires of remarkably different treadwear.
- Do not use tire sizes other than those recommended by Toyota.
- Do not mix differently constructed tires (radial, bias-belted or bias-ply tires).
- Do not mix summer, all season and snow tires.
- Do not use tires that have been used on another vehicle.
Do not use tires if you do not know how they were used previously.

■ When initializing the tire pressure warning system

Do not operate the tire pressure warning reset switch without first adjusting the tire inflation pressure to the specified level. Otherwise, the tire pressure warning light may not come on even if the tire inflation pressure is low, or it may come on when the tire inflation pressure is actually normal.

 NOTICE**■ Repairing or replacing tires, wheels, tire pressure warning valves, transmitters and tire valve caps**

- When removing or fitting the wheels, tires or the tire pressure warning valves and transmitters, contact your Toyota dealer as the tire pressure warning valves and transmitters may be damaged if not handled correctly.
- When replacing tire valve caps, do not use tire valve caps other than those specified. The cap may become stuck.

■ To avoid damage to the tire pressure warning valves and transmitters

When a tire is repaired with liquid sealants, the tire pressure warning valve and transmitter may not operate properly. If a liquid sealant is used, contact your Toyota dealer or other qualified service shop as soon as possible. Make sure to replace the tire pressure warning valve and transmitter when replacing the tire. (→P. 335)

■ Driving on rough roads

Take particular care when driving on roads with loose surfaces or potholes.

These conditions may cause losses in tire inflation pressure, reducing the cushioning ability of the tires. In addition, driving on rough roads may cause damage to the tires themselves, as well as the vehicle's wheels and body.

■ Low profile tires (18-inch tires)

Low profile tires may cause greater damage than usual to the tire wheel when sustaining impact from the road surface. Therefore, pay attention to the following:

- Be sure to use proper tire inflation pressure. If tires are under-inflated, they may be damaged more severely.
- Avoid potholes, uneven pavement, curbs and other road hazards. Failure to do so may lead to severe tire and wheel damage.

■ If tire inflation pressure of each tire becomes low while driving

Do not continue driving, or your tires and/or wheels may be ruined.

Tire inflation pressure

Tire inflation pressure

The recommended cold tire inflation pressure and tire size are displayed on the tire and loading information label. (→P. 437)

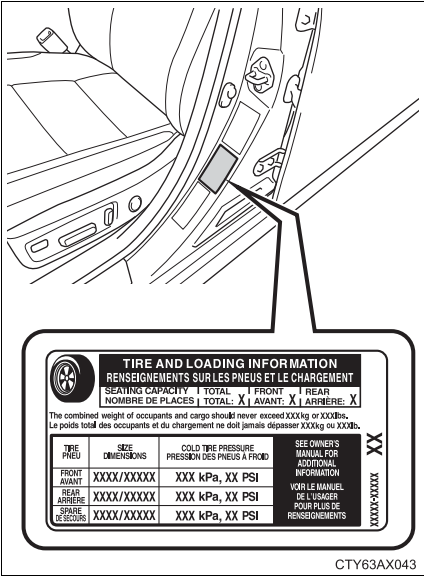

CTY63AX043

Inspection and adjustment procedure

- ① Tire valve
- ② Tire pressure gauge

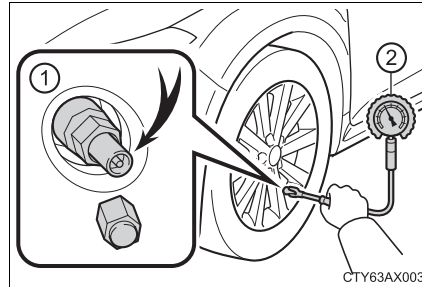

- 1 Remove the tire valve cap.
- 2 Press the tip of the tire pressure gauge onto the tire valve.
- 3 Read the pressure using the gauge gradations.
- 4 If the tire inflation pressure is not at the recommended level, adjust the pressure.
If you add too much air, press the center of the valve to deflate.
- 5 After completing the tire inflation pressure measurement and adjustment, apply soapy water to the valve and check for leakage.
- 6 Put the tire valve cap back on.

■ Tire inflation pressure check interval

You should check tire inflation pressure every two weeks, or at least once a month.

Do not forget to check the spare.

■ Effects of incorrect tire inflation pressure

Driving with incorrect tire inflation pressure may result in the following:

- Reduced fuel efficiency
- Reduced driving comfort and tire life
- Reduced safety
- Damage to the drive train

If a tire needs frequent inflating, have it checked by your Toyota dealer.

■ Instructions for checking tire inflation pressure

When checking tire inflation pressure, observe the following:

- Check only when the tires are cold.
If your vehicle has been parked for at least 3 hours or has not been driven for more than 1 mile or 1.5 km, you will get an accurate cold tire inflation pressure reading.
- Always use a tire pressure gauge.
The appearance of the tire can be misleading. In addition, tire inflation pressure that is even just a few pounds off can affect ride quality and handling.
- Do not reduce tire inflation pressure after driving. It is normal for tire inflation pressure to be higher after driving.
- Never exceed the vehicle capacity weight.
Passengers and luggage weight should be placed so that the vehicle is balanced.

 **CAUTION****■ Proper inflation is critical to save tire performance**

Keep your tires properly inflated. Otherwise, the following conditions may occur and result in an accident causing death or serious injury:

- Excessive wear
- Uneven wear
- Poor handling
- Possibility of blowouts resulting from overheated tires
- Poor sealing of the tire bead
- Wheel deformation and/or tire separation
- A greater possibility of tire damage from road hazards

 **NOTICE****■ When inspecting and adjusting tire inflation pressure**

Be sure to put the tire valve caps back on.
Without the valve caps, dirt or moisture could get into the valve and cause air leakage, which could result in an accident. If the caps are lost, replace them as soon as possible.

Wheels

If a wheel is bent, cracked or heavily corroded, it should be replaced. Otherwise, the tire may separate from the wheel or cause a loss of handling control.

Wheel selection

When replacing wheels, care should be taken to ensure that they are equivalent to those removed in load capacity, diameter, rim width and inset*.

Replacement wheels are available at your Toyota dealer.

*: Conventionally referred to as "offset".

Toyota does not recommend using the following:

- Wheels of different sizes or types
- Used wheels
- Bent wheels that have been straightened

Aluminum wheel precautions

- Use only Toyota wheel nuts and wrenches designed for use with your aluminum wheels.
- When rotating, repairing or changing your tires, check that the wheel nuts are still tight after driving 1000 miles (1600 km).
- Be careful not to damage the aluminum wheels when using tire chains.
- Use only Toyota genuine balance weights or equivalent and a plastic or rubber hammer when balancing your wheels.

■ When replacing wheels

The wheels of your vehicle are equipped with tire pressure warning valves and transmitters that allow the tire pressure warning system to provide advance warning in the event of a loss in tire inflation pressure. Whenever wheels are replaced, tire pressure warning valves and transmitters must be installed. (→P. 335)

▲ CAUTION**■ When replacing wheels**

- Do not use wheels that are a different size from those recommended in the Owner's Manual, as this may result in a loss of handling control.
- Never use an inner tube in a leaking wheel which is designed for a tubeless tire. Doing so may result in an accident, causing death or serious injury.

■ When installing the wheel nuts

- Be sure to install the wheel nuts with the tapered ends facing inward. Installing the nuts with the tapered ends facing outward can cause the wheel to break and eventually cause the wheel to come off while driving, which could lead to an accident resulting in death or serious injury.

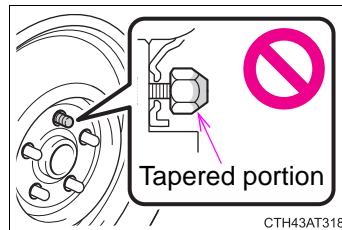

- Never use oil or grease on the wheel bolts or wheel nuts. Oil and grease may cause the wheel nuts to be excessively tightened, leading to bolt or disc wheel damage. In addition, the oil or grease can cause the wheel nuts to loosen and the wheel may fall off, causing an accident and resulting in death or serious injury. Remove any oil or grease from the wheel bolts or wheel nuts.

 NOTICE**■ Replacing tire pressure warning valves and transmitters**

- Because tire repair or replacement may affect the tire pressure warning valves and transmitters, make sure to have tires serviced by your Toyota dealer or other qualified service shop. In addition, make sure to purchase your tire pressure warning valves and transmitters at your Toyota dealer.
- Ensure that only genuine Toyota wheels are used on your vehicle. Tire pressure warning valves and transmitters may not work properly with non-genuine wheels.

Air conditioning filter

The air conditioning filter must be changed regularly to maintain air conditioning efficiency.

Removal method

- 1 Turn the engine switch off.
- 2 Open the glove box. (→P. 257)
- 3 Remove the glove box cover.

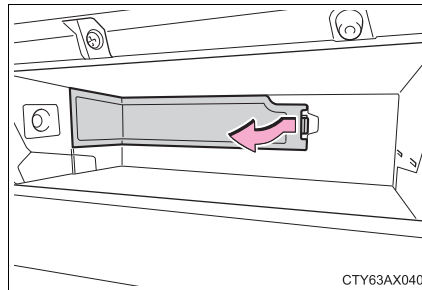

- 4 Press the tabs and remove the filter cover.

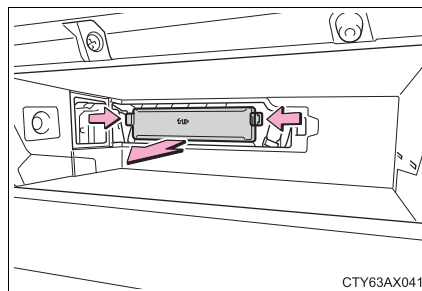

- 5 Remove the air conditioning filter and replace it with a new one.

The "↑UP" marks shown on the filter should be pointing up.

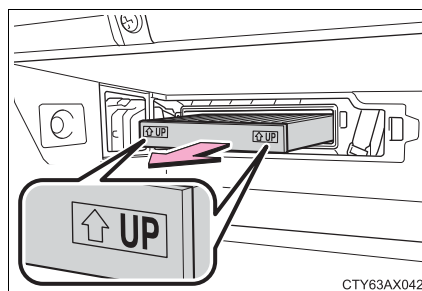

■ Checking interval

Inspect and replace the air conditioning filter according to the maintenance schedule. In dusty areas or areas with heavy traffic flow, early replacement may be required. (For scheduled maintenance information, please refer to the “Schedule maintenance guide” or “Owner’s Manual Supplement”.)

■ If air flow from the vents decreases dramatically

The filter may be clogged. Check the filter and replace if necessary.

 **NOTICE****■ When using the air conditioning system**

Make sure that a filter is always installed.

Using the air conditioning system without a filter may cause damage to the system.

Electronic key battery

Replace the battery with a new one if it is depleted.

You will need the following items:

- Flathead screwdriver
- Small flathead screwdriver
- Lithium battery CR2032

Replacing the battery

- 1 Take out the mechanical key.

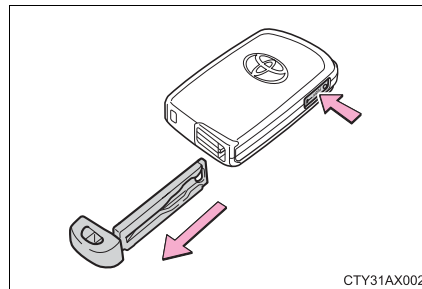

- 2 Remove the cover.

To prevent damage to the key, cover the tip of the screwdriver with a rag.

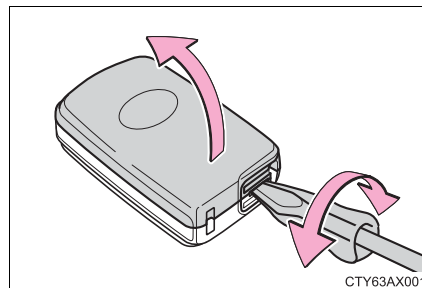

- 3 Remove the depleted battery.

Insert a new battery with the “+” terminal facing up.

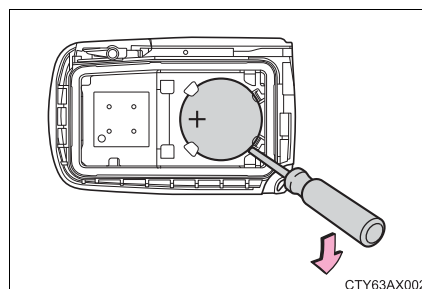

■ Use a CR2032 lithium battery

- Batteries can be purchased at your Toyota dealer, local electrical appliance shops or camera stores.
- Replace only with the same or equivalent type recommended by the manufacturer.
- Dispose of used batteries according to local laws.

■ If the electronic key battery is depleted

The following symptoms may occur:

- The smart key system and wireless remote control will not function properly.
- The operational range will be reduced.

⚠ CAUTION**■ Removed battery and other parts**

These parts are small and if swallowed by a child, they can cause choking. Keep away from children. Failure to do so could result in death or serious injury.

⚠ NOTICE**■ For normal operation after replacing the battery**

Observe the following precautions to prevent accidents:

- Always work with dry hands.
Moisture may cause the battery to rust.
- Do not touch or move any other component inside the remote control.
- Do not bend either of the battery terminals.

Checking and replacing fuses

If any of the electrical components do not operate, a fuse may have blown. If this happens, check and replace the fuses as necessary.

- 1 Turn the engine switch off.
- 2 After a system failure, see “Fuse layout and amperage ratings” for details about which fuse to check. (→P. 354)
- 3 Open the Fuse box cover.

► Engine compartment

Push the tab in and lift the lid off.

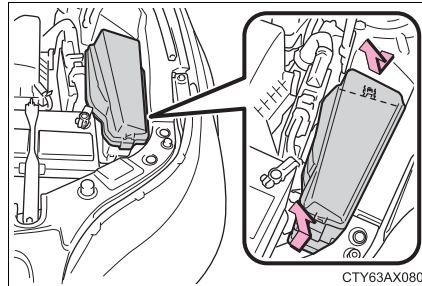

► Driver's side instrument panel

Remove the lid.

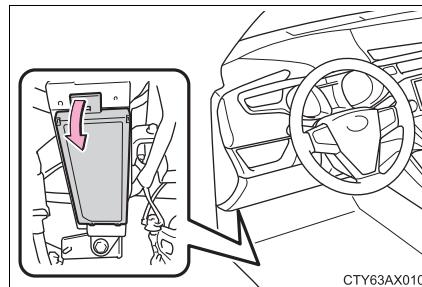

- 4 Remove the fuse with the pull-out tool.

Only type A fuse can be removed using the pullout tool.

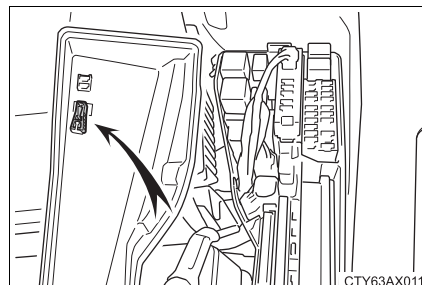

5 Check if the fuse is blown.

- ① Normal fuse
- ② Blown fuse

Type A and B:

Replace the blown fuse with a new fuse of an appropriate amperage rating. The amperage rating can be found on the fuse box lid.

Type C:

Contact your Toyota dealer.

► Type A

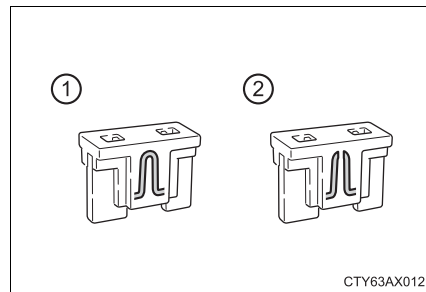

► Type B

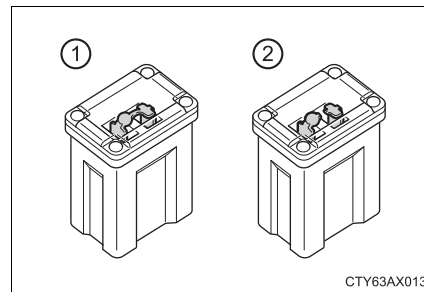

► Type C

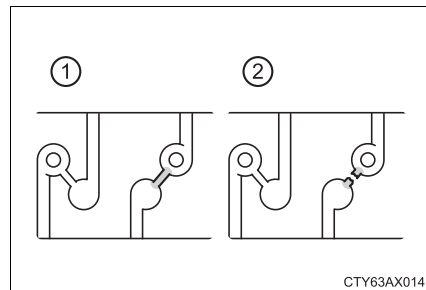

Fuse layout and amperage ratings

■ **Engine compartment**

► **Fuse block**

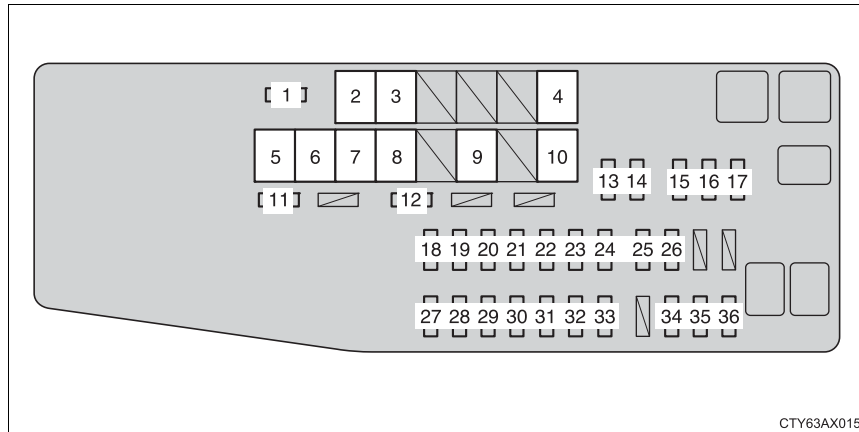

► **Fuse block on the back of the cover**

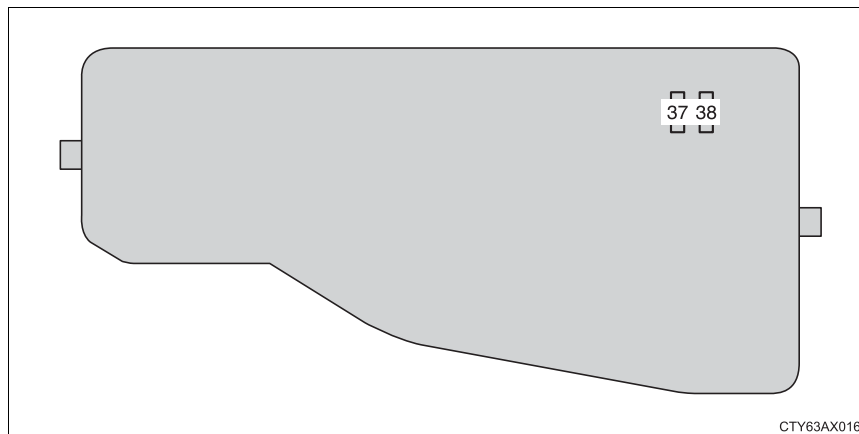

Fuse		Ampere	Circuit
1	METER-IG2	5 A	Gauge and meters
2	FAN	50 A	Electric cooling fans
3	H-LP CLN	30 A	No circuit
4	HTR	50 A	Air conditioning system
5	ALT	140 A ^{*1}	Charging system
		120 A ^{*2}	
6	ABS NO.2	30 A	Vehicle stability control system

Fuse		Ampere	Circuit
7	ST/AM2	30 A	Starter system
8	H-LP-MAIN	30 A	H-LP LH-LO, H-LP RH-LO, headlights (low beam)
9	ABS NO.1	50 A	Vehicle stability control system
10	EPS	80 A	Electric power steering
11	S-HORN	7.5 A	S-HORN
12	HORN	10 A	Horns
13	EFI NO.2	15 A	Multiport fuel injection system/sequential multiport fuel injection system, electronic controlled transmission
14	EFI NO.3	10 A	Multiport fuel injection system/sequential multiport fuel injection system
15	INJ	7.5 A	Multiport fuel injection system/sequential multiport fuel injection system
16	ECU-IG2 NO.3	7.5 A	Multiport fuel injection system/sequential multiport fuel injection system, steering lock system, electronic controlled transmission, stop lights, high-mounted stop light
17	IGN	15 A	Starter system
18	D/L-AM2	20 A	No circuit
19	IG2-MAIN	25 A	IGN, INJ, METER-IG2, ECU-IG2 NO.3, A/B, ECU-IG2 NO.2, ECU-IG2 NO.1
20	ALT-S	7.5 A	Charging system
21	MAYDAY	5 A	MAYDAY
22	TURN&HAZ	15 A	Turn signal lights, emergency flashers, gauge and meters
23	STRG LOCK	10 A	Steering lock system
24	AMP	15 A	Audio system
25	H-LP LH-LO	20 A ^{*1}	Left-hand headlight (low beam)
		15 A ^{*2}	
26	H-LP RH-LO	20 A ^{*1}	Right-hand headlight (low beam)
		15 A ^{*2}	

	Fuse	Ampere	Circuit
27	EFI-MAIN NO.1	30 A	EFI NO.2, EFI NO.3, A/F sensor
28	SMART	5 A	No circuit
29	ETCS	10 A	Electronic throttle control system
30	TOWING	20 A	No circuit
31	EFI NO.1	7.5 A	Multipoint fuel injection system/sequential multipoint fuel injection system, electronic controlled transmission
32	A/F	20 A	A/F sensor
33	AM2	7.5 A	Smart key system
34	RADIO-B	20 A	Audio system, navigation system
35	DOME	7.5 A	Vanity lights, personal/interior lights, trunk light, door courtesy lights, illuminated entry system, ambient light
36	ECU-B NO.1	10 A	Multiplex communication system, smart key system, gauge and meters, starter system, steering sensor, air conditioning system, outside rear view mirror, front power seats
37	SPARE	25 A	Spare fuse
38	SPARE	30 A	Spare fuse

*1: Vehicles with discharge headlight low beam

*2: Vehicles with halogen headlight low beam

■ Driver's side instrument panel

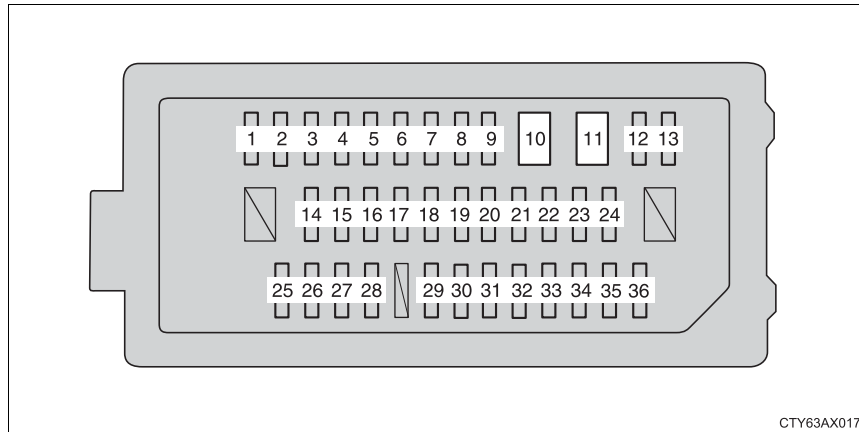

Fuse		Ampere	Circuit
1	H-LP LVL	7.5 A	Automatic headlight leveling system
2	S/HTR RR	20 A	Rear seat heater
3	ECU-ACC	5 A	Outside rear view mirrors, glove box light, air conditioning system, multiplex communication system
4	RR P/OUTLET	15 A	Power outlets
5	ECU-IG2 NO.2	7.5 A	Multiplex communication system, smart key system
6	ECU-IG2 NO.1	7.5 A	Multiport fuel injection system/sequential multiport fuel injection system
7	A/B	10 A	Front passenger occupant classification system, SRS airbag system
8	FUEL DR LOCK	10 A	Fuel filler door lock
9	D/L-AM1	20 A	Multiplex communication system, power door lock, trunk opener switch
10	PSB	30 A	Pre-collision system
11	P/SEAT FR	30 A	Power seats
12	S/ROOF	10 A	Moon roof
13	A/C-B	7.5 A	Air conditioning system

Fuse		Ampere	Circuit
14	STOP	7.5 A	Stop/tail lights, multiport fuel injection system/sequential multiport fuel injection system, vehicle stability control system, anti-lock brake system, electronic controlled transmission, high mounted stop-light, smart key system, shift lock control system
15	AM1	7.5 A	No circuit
16	4-WAY LUMBAR	7.5 A	Power seat
17	ECU-B NO.2	10 A	Smart key system, tire pressure warning system, power window, front passenger occupant classification system
18	OBD	10 A	On-board diagnosis system
19	S/HTR&FAN F/L	10 A	Seat heaters
20	S/HTR&FAN F/R	10 A	Seat heaters
21	RADIO-ACC	5 A	Audio system, navigation system
22	FR P/OUTLET	15 A	Power outlets
23	WIPER-S	10 A	Dynamic radar cruise control, pre-collision system
24	EPS-IG1	7.5 A	Electric power steering
25	BKUP LP	7.5 A	Back-up lights, multiport fuel injection system/sequential multiport fuel injection system, electronic controlled transmission
26	WIPER	25 A	Windshield wipers and washer
27	A/C-IG1	7.5 A	Air conditioning system
28	WASHER	10 A	Windshield wipers and washer
29	DOOR R/L	20 A	Rear left-hand power windows
30	DOOR F/L	20 A	Power windows, outside rear view mirrors
31	DOOR R/R	20 A	Rear right-hand power windows
32	DOOR F/R	20 A	Power windows, outside rear view mirrors

Fuse		Ampere	Circuit
33	TAIL	10 A	Parking lights, side marker lights, stop/tail lights, rear turn signal lights, back up lights, license plate lights, fog lights
34	PANEL	10 A	Switch illumination, air conditioning system, glove box light, interior lights, personal lights, audio system, navigation system, rear sunshade, seat heater, Blind Spot Monitor, driving mode select switch, steering wheel switch, ambient light, trunk opener switch, vehicle stability control off switch, emergency flashers, outside rear view mirrors
35	ECU-IG1 NO.1	10 A	Vehicle stability control system, electric cooling fans, steering sensor, multiport fuel injection system/sequential multiport fuel injection system, charging system, rear window defogger, outside rear view mirror defoggers, rain-sensing windshield wipers, Blind Spot Monitor, rear sunshade, dynamic radar cruise control, multiplex communication system, rear seat heater, backup lights, fog lights, headlight (high beam), daytime running light, pre-collision system
36	ECU-IG1 NO.2	10 A	Shift lock control system, seat heaters, smart key system, tire pressure warning system, wireless remote control, multiplex communication system, audio system, navigation system, moon roof, auto anti-glare inside rear view mirror, outside rear view mirrors, pre-collision system, air conditioning controls, rain-sensing windshield wipers, starting system, dynamic radar cruise control

■ After a fuse is replaced

- If the lights do not turn on even after the fuse has been replaced, a bulb may need replacement. (→P. 361)
- If the replaced fuse blows again, have the vehicle inspected by your Toyota dealer.

■ If there is an overload in a circuit

The fuses are designed to blow, protecting the wiring harness from damage.

■ When replacing light bulbs

Toyota recommends that you use genuine Toyota products designed for this vehicle. Because certain bulbs are connected to circuits designed to prevent overload, non-genuine parts or parts not designed for this vehicle may be unusable.

⚠ CAUTION**■ To prevent system breakdowns and vehicle fire**

Observe the following precautions.

Failure to do so may cause damage to the vehicle, and possibly a fire or injury.

- Never use a fuse of a higher amperage rating than that indicated, or use any other object in place of a fuse.
- Always use a genuine Toyota fuse or equivalent.
Never replace a fuse with a wire, even as a temporary fix.
- Do not modify the fuses or fuse boxes.

⚠ NOTICE**■ Before replacing fuses**

Have the cause of electrical overload determined and repaired by your Toyota dealer as soon as possible.

Light bulbs

You may replace the following bulbs by yourself. The difficulty level of replacement varies depending on the bulb. If necessary bulb replacement seems difficult to perform, contact your Toyota dealer.

For more information about replacing other light bulbs, contact your Toyota dealer.

Preparing for light bulb replacement

Check the wattage of the light bulb to be replaced. (→P. 438)

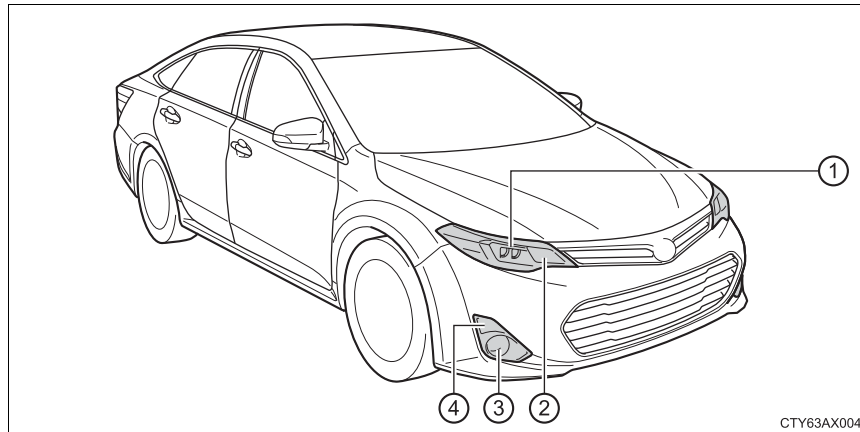
Bulb locations**■ Front**

- ① Headlight low beam (halogen bulb)
- ② Headlight high beam and daytime running light (vehicles with halogen bulbs for low beams)
Headlight high beam (vehicles with discharge bulbs for low beams)
- ③ Fog light (if equipped)
- ④ Front turn signal/parking light

■ Rear

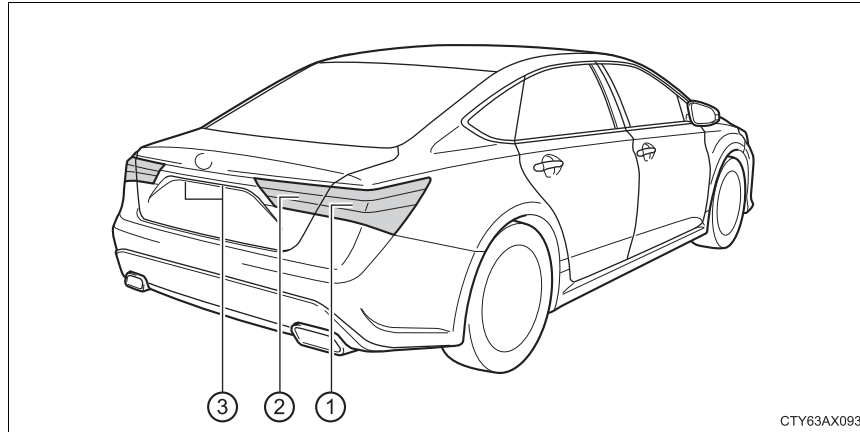

CTY63AX093

- ① Rear turn signal light
- ② Back-up light
- ③ License plate light

Replacing light bulbs

■ Headlight low beam (halogen bulb)

- 1 Unplug the connector while pressing the lock release.

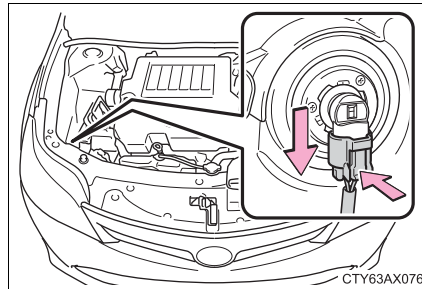

- 2 Turn the bulb base counter-clockwise.

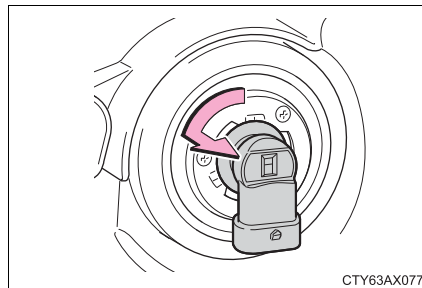

- 3 Set the new light bulb.
Align the 3 tabs on the light bulb with the mounting, and insert. Turn it clockwise to set.

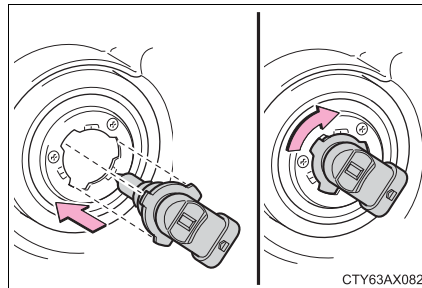

- 4 Set the connector.
After installing the connector, shake the bulb base gently to check that it is not loose, turn the headlights on once and visually confirm that no light is leaking through the mounting.

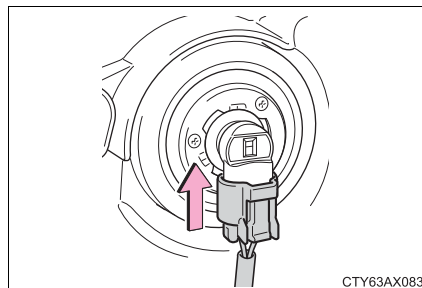

■ **Headlight high beam and daytime running light (vehicles with halogen bulbs for low beams)/Headlight high beam (vehicles with discharge bulbs for low beams)**

- 1 Unplug the connector while pressing the lock release.

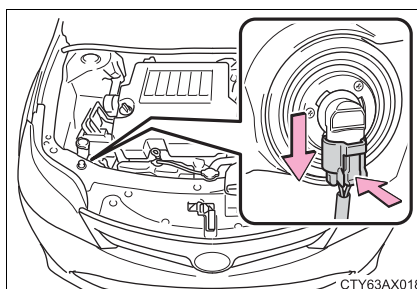

- 2 Turn the bulb base counter-clockwise.

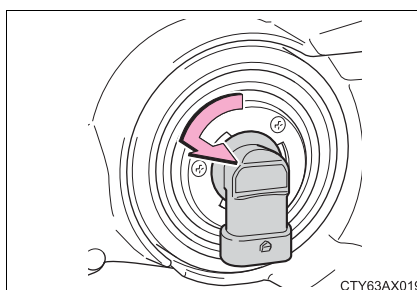

- 3 Set the new light bulb.
Align the 3 tabs on the light bulb with the mounting, and insert. Turn it clockwise to set.

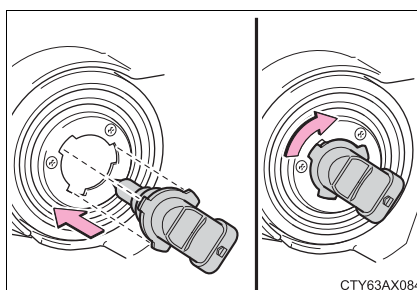

- 4 Set the connector.
After installing the connector, shake the bulb base gently to check that it is not loose, turn the headlights on once and visually confirm that no light is leaking through the mounting.

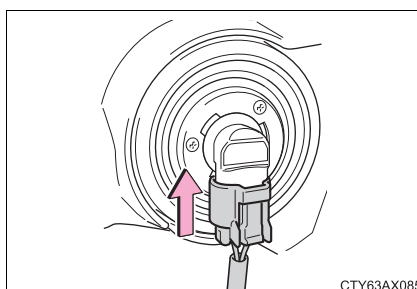

■ **Fog light (if equipped)**

- 1 To allow enough working space, turn the steering wheel to the opposite side of the bulb to be replaced. Remove the 3 fender liner clips.

Turn the steering wheel to the left when replacing the right side light bulb, and turn the steering wheel to the right when replacing the left side light bulb.

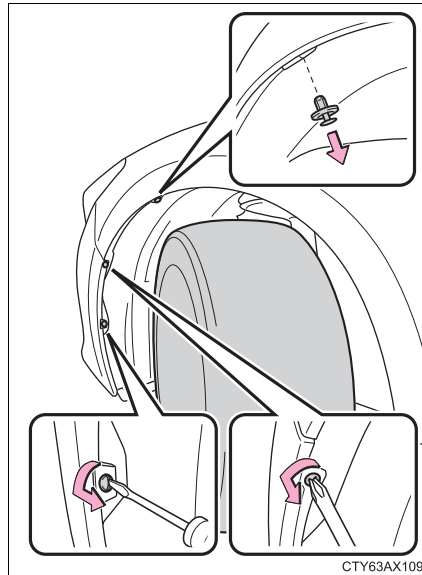

- 2 Remove the fender liner bolt and partly remove the fender liner.

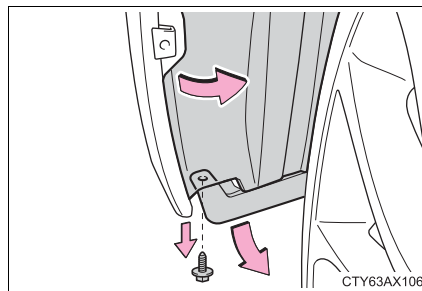

- 3 Unplug the connector while pressing the lock release.

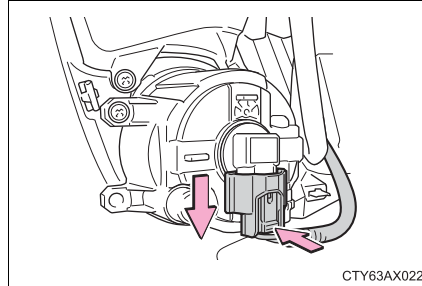

- 4 Turn the bulb base counter-clockwise.

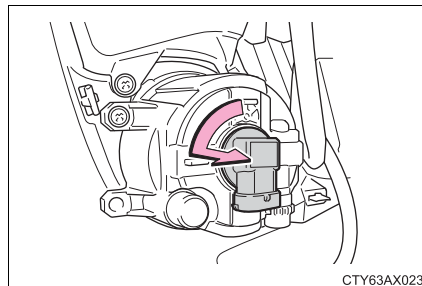

- 5 Set the new light bulb.
Align the 3 tabs on the light bulb with the mounting, and insert.
Turn it clockwise to set.

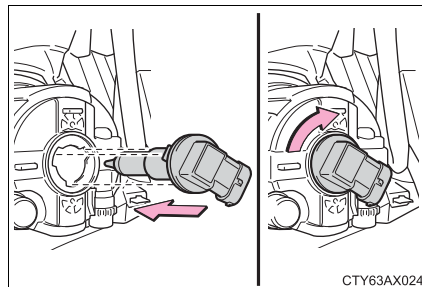

- 6 Set the connector.
After installing the connector, shake the bulb base gently to check that it is not loose, turn the fog lights on once and visually confirm that no light is leaking through the mounting.

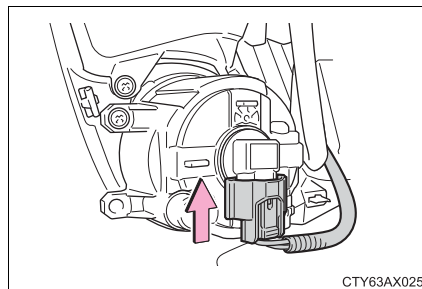

- 7 Reinstall the fender liner and the fender liner bolt.

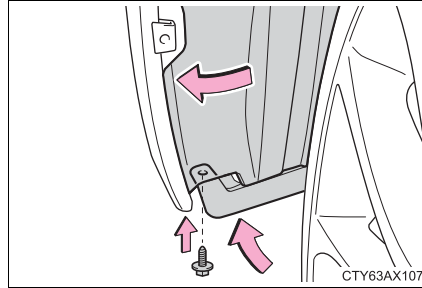

- 8 Reinstall the fender liner clips.

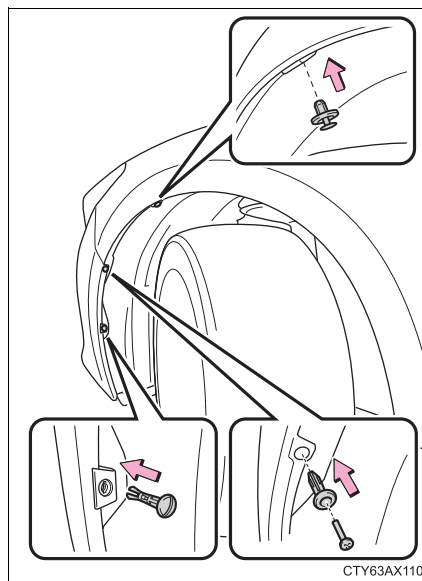

■ Front turn signal/parking light

- 1 To allow enough working space, turn the steering wheel to the opposite side of the bulb to be replaced. Remove the 3 fender liner clips.

Turn the steering wheel to the left when replacing the right side light bulb, and turn the steering wheel to the right when replacing the left side light bulb.

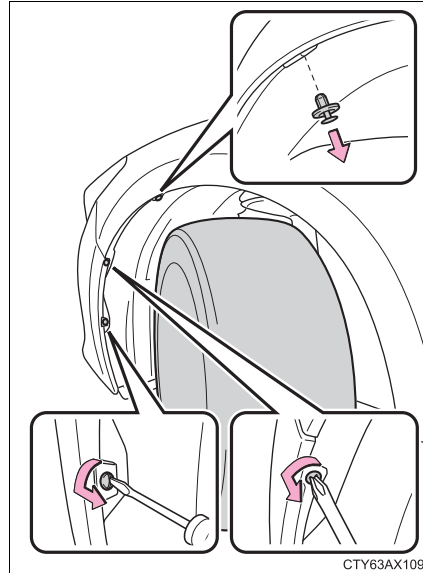

- 2 Remove the fender liner bolt and partly remove the fender liner.

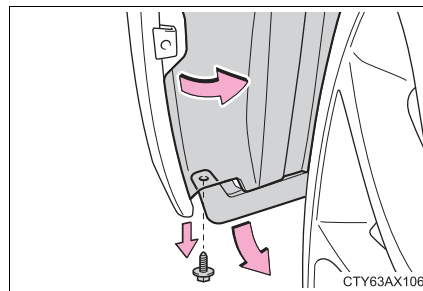

- 3 Unplug the connector while pressing the lock release.

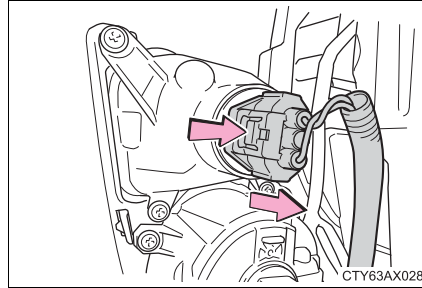

- 4 Turn the bulb base counter-clockwise.

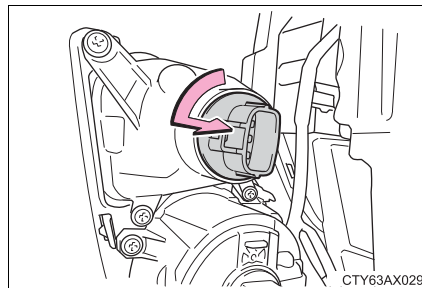

- 5 Remove the light bulb.

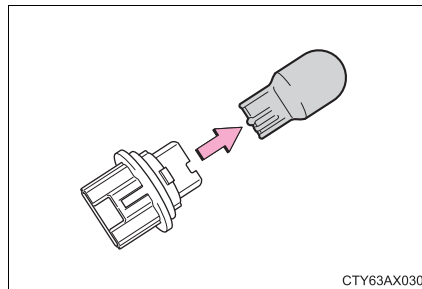

- 6 When installing, reverse the steps listed.

■ Rear turn signal light

- 1 Open the trunk lid and remove the luggage trim cover clip.

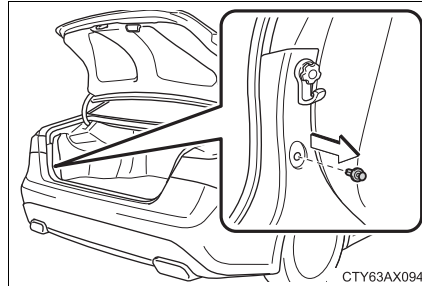

- 2 Pull the hook while depressing the button.

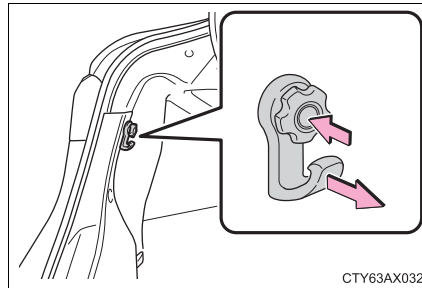

- 3 Partly remove the luggage trim cover.

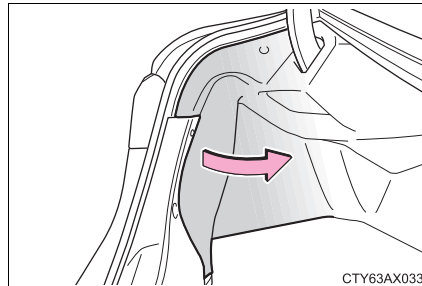

- 4 Turn the bulb base counter-clockwise.

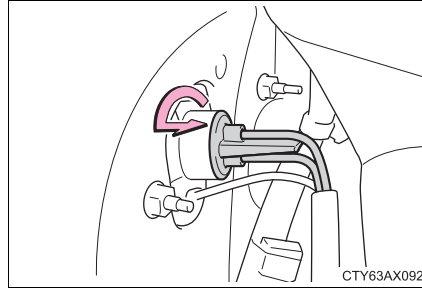

- 5 Remove the light bulb.

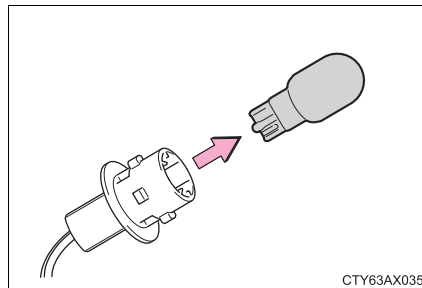

- 6 When installing, reverse the steps listed.

■ Back-up light

- 1 Open the trunk lid and remove the clips. Then partly remove the trunk panel cover.

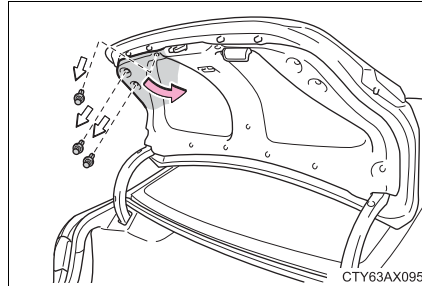

- 2 Turn the bulb base counter-clockwise.

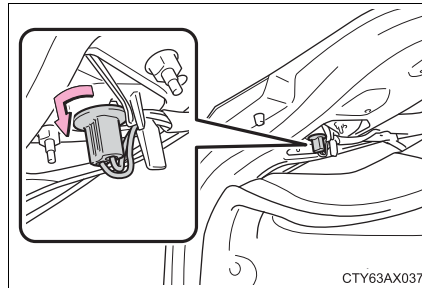

- 3 Remove the light bulb.

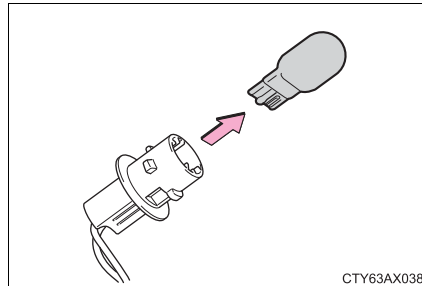

- 4 When installing, reverse the steps listed.

■ License plate light

- 1 Remove the cover.

To prevent damaging the vehicle, wrap the flathead screwdriver with a tape.

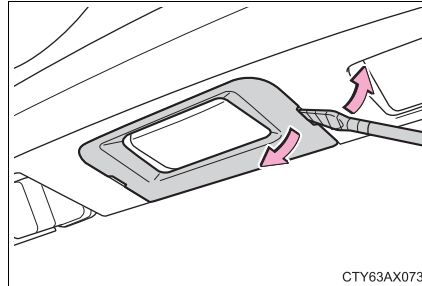

- 2 Remove the lens.

Insert a properly sized screwdriver into the hole of the lens, and pry off the lens as shown in the illustration.

To prevent damaging the vehicle, wrap the screwdriver with a tape.

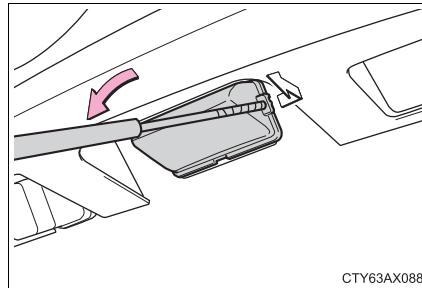

- 3 Remove the light bulb.

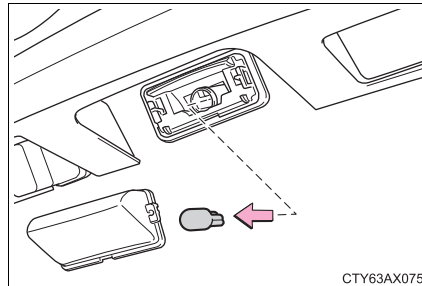

- 4 When installing, reverse the steps listed.

■ Replacing the following bulbs

If any of the lights listed below has burnt out, have it replaced by your Toyota dealer.

- Headlight low beams (discharge bulb)
- Daytime running lights (vehicles with discharge headlights)
- Side marker lights
- Side turn signal lights
- Stop/tail lights
- High mounted stoplight
- Outer foot lights (if equipped)

■ Discharge headlights (if equipped)

If voltage to the discharge bulbs is insufficient, the bulbs may not come on, or may go out temporarily. The discharge bulbs will come on when normal power is restored.

■ LED light bulbs

The daytime running lights (vehicles with discharge headlights), stop/tail lights, high mounted stoplight and outer foot lights each consist of a number of LEDs. If any of the LEDs burn out, take your vehicle to your Toyota dealer to have the light replaced.

■ Condensation build-up on the inside of the lens

Temporary condensation build-up on the inside of the lens does not indicate a malfunction. Contact your Toyota dealer for more information in the following situations:

- Large drops of water have built up on the inside of the lens.
- Water has built up inside the lens.

■ Removing and installing the clips

The fender liner, luggage trim cover and trunk panel cover clip

- ① Removing
- ② Installing

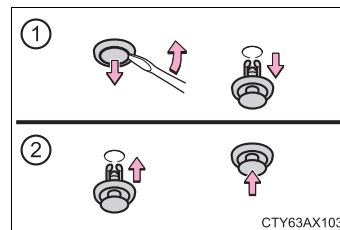
**■ When replacing light bulbs**

→P. 360

⚠ CAUTION**■ Replacing light bulbs**

- Turn off the lights. Do not attempt to replace the bulb immediately after turning off the lights.
The bulbs become very hot and may cause burns.
- Do not touch the glass portion of the light bulb with bare hands. When it is unavoidable to hold the glass portion, use and hold with a clean dry cloth to avoid getting moisture and oils on the bulb.
Also, if the bulb is scratched or dropped, it may blow out or crack.
- Fully install light bulbs and any parts used to secure them. Failure to do so may result in heat damage, fire, or water entering the headlight unit. This may damage the headlights or cause condensation to build up on the lens.
- Vehicles with discharge headlights:
While the low beam headlights are turned on, and for a short time after they have been turned off, metal components at the rear of the headlight assembly will be extremely hot. To prevent burns, do not touch these metal components until you are certain they have cooled down.

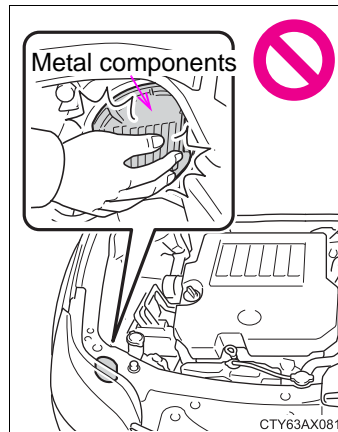

 CAUTION**■ Discharge headlights (if equipped)**

- Contact your Toyota dealer before replacing the discharge headlights (including light bulbs).
- Do not touch the discharge headlight's high voltage socket when the headlights are turned on.
An extremely high voltage of 30000 V will be discharged and could result in death or serious injury by electric shock.
- Do not attempt to take apart or repair the headlight bulbs, connectors, power supply circuits, or related components.
Doing so could result in electric shock and death or serious injury.

■ To prevent damage or fire

- Make sure bulbs are fully seated and locked.
- Check the wattage of the bulb before installing to prevent heat damage.

When trouble arises

7

7-1. Essential information

- Emergency flashers 380
- If your vehicle has to be stopped in an emergency 381

7-2. Steps to take in an emergency

- If your vehicle needs to be towed 382
- If you think something is wrong 386
- Fuel pump shut off system 387
- If a warning light turns on or a warning buzzer sounds 388
- If a warning message is displayed 399
- If you have a flat tire..... 400
- If the engine will not start..... 413
- If the shift lever cannot be shifted from P..... 415
- If the electronic key does not operate properly..... 416
- If the vehicle battery is discharged 419
- If your vehicle overheats 423
- If the vehicle becomes stuck 426

Emergency flashers

The emergency flashers are used to warn other drivers when the vehicle has to be stopped in the road due to a breakdown, etc.

Press the switch.

All the turn signals will flash.
To turn them off, press the switch
once again.

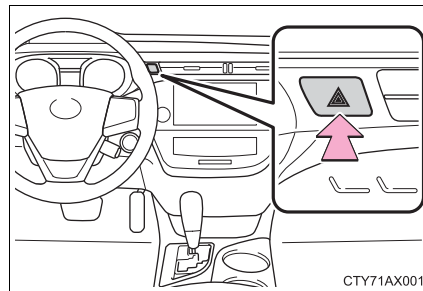

■ Emergency flashers

If the emergency flashers are used for a long time while the engine is not operating, the battery may discharge.

If your vehicle has to be stopped in an emergency

Only in an emergency, such as if it becomes impossible to stop the vehicle in the normal way, stop the vehicle using the following procedure:

- 1 Steadily step on the brake pedal with both feet and firmly depress it.
Do not pump the brake pedal repeatedly as this will increase the effort required to slow the vehicle.
- 2 Shift the shift lever to N.
 - ▶ If the shift lever is shifted to N
- 3 After slowing down, stop the vehicle in a safe place by the road.
- 4 Stop the engine.
 - ▶ If the shift lever cannot be shifted to N
- 3 Keep depressing the brake pedal with both feet to reduce vehicle speed as much as possible.
- 4 To stop the engine, press and hold the engine switch for 2 consecutive seconds or more, or press it briefly 3 times or more in succession.

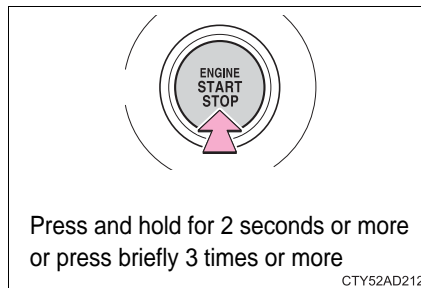

- 5 Stop the vehicle in a safe place by the road.

⚠ CAUTION

■ If the engine has to be turned off while driving

Power assist for the brakes and steering wheel will be lost, making the brake pedal harder to depress and the steering wheel heavier to turn. Decelerate as much as possible before turning off the engine.

If your vehicle needs to be towed

If towing is necessary, we recommend having your vehicle towed by your Toyota dealer or commercial towing service, using a lift-type truck or flat bed truck.

Use a safety chain system for all towing, and abide by all state/provincial and local laws.

If towing your vehicle with a wheel-lift type truck from the front, the vehicle's rear wheels and axles must be in good conditions.

(→P. 383, 384)

If they are damaged, use a towing dolly or flatbed truck.

Situations needs to contact dealers before towing

The following may indicate a problem with your transmission. Contact your Toyota dealer or commercial towing service before towing.

- The engine is running but the vehicle will not move.
- The vehicle makes an abnormal sound.

Towing with a sling-type truck

Do not tow with a sling-type truck to prevent body damage.

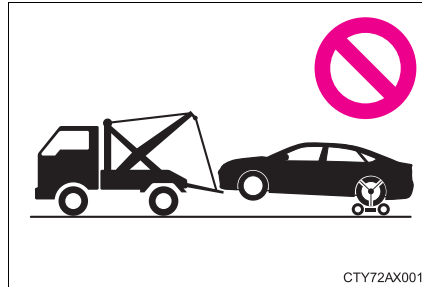
**Towing with a wheel-lift type truck****► From the front**

Release the parking brake.

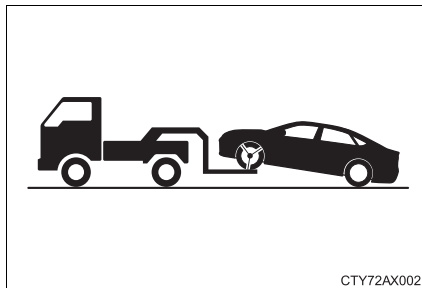
**► From the rear**

Use a towing dolly under the front wheels.

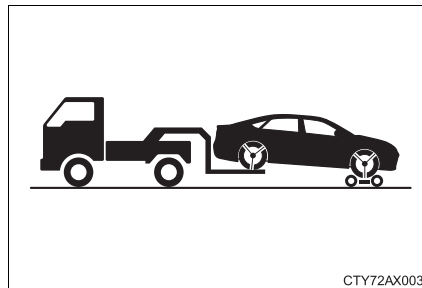

Using a flatbed truck

If your Toyota is transported by a flatbed truck, it should be tied down at the locations shown in the illustration.

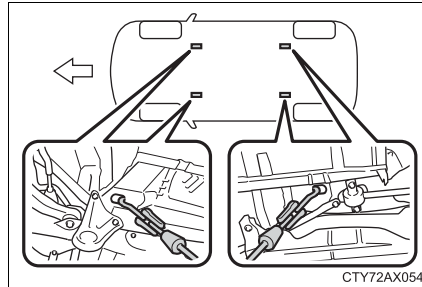

If you use chains or cables to tie down your vehicle, the angles shaded in black must be 45°.

Do not overly tighten the tie downs or the vehicle may be damaged.

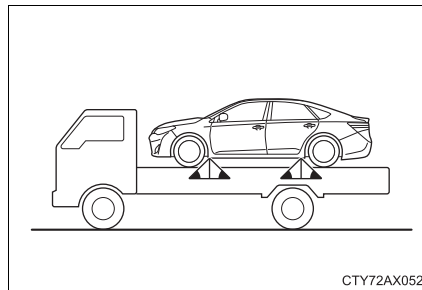

⚠ CAUTION

Observe the following precaution.
Failure to do so may result in death or serious injury.

■ When towing the vehicle

Be sure to transport the vehicle with the front wheels raised or with all four wheels raised off the ground.

If the vehicle is towed with the front wheels contacting the ground, the drivetrain and related parts may be damaged.

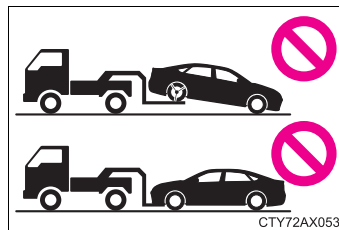

■ While towing

- When towing using a cables or chains, avoid sudden starts, etc. which place excessive stress on the towing eyelets, cables or chains. The towing eyelets, cables or chains may become damaged, broken debris may hit people and cause serious damage.

- Do not turn the engine switch off.
There is a possibility that the steering wheel is locked and cannot be operated.

 NOTICE**■ To prevent damage to the vehicle when towing using a wheel-lift type truck**

When raising the vehicle, ensure adequate ground clearance for towing at the opposite end of the raised vehicle. Without adequate clearance, the vehicle could be damaged while being towed.

■ To prevent body damage when towing with a sling-type truck

Do not tow with a sling-type truck, either from the front or rear.

If you think something is wrong

If you notice any of the following symptoms, your vehicle probably needs adjustment or repair. Contact your Toyota dealer as soon as possible.

Visible symptoms

- Fluid leaks under the vehicle.
(Water dripping from the air conditioning after use is normal.)
- Flat-looking tires or uneven tire wear
- Engine coolant temperature gauge needle continually points higher than normal.

Audible symptoms

- Changes in exhaust sound
- Excessive tire squeal when cornering
- Strange noises related to the suspension system
- Pinging or other noises related to the engine

Operational symptoms

- Engine missing, stumbling or running roughly
- Appreciable loss of power
- Vehicle pulls heavily to one side when braking
- Vehicle pulls heavily to one side when driving on a level road
- Loss of brake effectiveness, spongy feeling, pedal almost touches the floor

Fuel pump shut off system

To minimize the risk of fuel leakage when the engine stalls or when an airbag inflates upon collision, the fuel pump shut off system stops the supply of fuel to the engine.

Follow the procedure below to restart the engine after the system is activated.

- 1 Turn the engine switch to ACCESSORY mode or turn it off.
- 2 Restart the engine.

NOTICE

■ Before starting the engine

Inspect the ground under the vehicle.



If you find that fuel has leaked onto the ground, the fuel system has been damaged and is in need of repair. Do not restart the engine.

If a warning light turns on or a warning buzzer sounds

Calmly perform the following actions if any of the warning lights comes on or flashes. If a light comes on or flashes, but then goes off, this does not necessarily indicate a malfunction in the system. However, if this continues to occur, have the vehicle inspected by your Toyota dealer.

Stop the vehicle immediately. Continuing to drive the vehicle may be dangerous.



The following warning indicates a possible problem in the brake system. Immediately stop the vehicle in a safe place and contact your Toyota dealer.

Warning light	Warning light/Details
 (U.S.A.)  (Canada)	<p>Brake system warning light (warning buzzer)*</p> <ul style="list-style-type: none"> • Low brake fluid • Malfunction in the brake booster system <p>This light also comes on when the parking brake is not released. If the light turns off after the parking brake is fully released the system is operating normally.</p>

*: Parking brake engaged warning buzzer: The buzzer sounds to indicate that the parking brake is still engaged (with the vehicle having reached a speed of 3 mph [5 km/h]).





Stop the vehicle immediately.





The following warning indicates the possibility of damage to the vehicle that may lead to an accident. Immediately stop the vehicle in a safe place and contact your Toyota dealer.

Warning light	Warning light/Details
	Charging system warning light Indicates a malfunction in the vehicle's charging system
	Low engine oil pressure warning light Indicates that the engine oil pressure is too low.

Have the vehicle inspected by your Toyota dealer immediately.





Failure to investigate the cause of the following warnings may lead to the system operating abnormally and possibly cause an accident. Have the vehicle inspected by your Toyota dealer immediately.

Warning light	Warning light/Details
 (U.S.A.)  (Canada)	Malfunction indicator lamp Indicates a malfunction in: <ul style="list-style-type: none"> • The electronic engine control system; • The electronic throttle control system; or • The electronic automatic transmission control system
	SRS warning light Indicates a malfunction in: <ul style="list-style-type: none"> • The SRS airbag system; • The front passenger occupant classification system; or • The seat belt pretensioner system
 (U.S.A.)  (Canada)	ABS warning light Indicates a malfunction in: <ul style="list-style-type: none"> • The ABS; or • The brake assist system

Warning light	Warning light/Details
	<p>Electric power steering system warning light (warning buzzer) Indicates a malfunction in the EPS (Electric Power Steering) system</p>
<p> (Flashes) (If equipped)</p>	<p>“PCS” warning light Indicates a malfunction in the pre-collision system The warning light will operate as follows, even when the system is not malfunctioning:</p> <ul style="list-style-type: none"> • The light will flash quickly when the system is operating. (→P. 220) • The light will turn on when the pre-collision system is disabled. (→P. 221) • The light will flash when the system cannot temporarily be used.
	<p>Slip indicator Indicates a malfunction in:</p> <ul style="list-style-type: none"> • The VSC system; or • The TRAC system <p>The light will flash when the VSC or the TRAC system is operating.</p>
<p> (Flashes) (If equipped)</p>	<p>Automatic High Beam indicator light Indicates a malfunction in the Automatic high beam system.</p>

Follow the correction procedures.

After taking the specified steps to correct the suspected problem, check that the warning light goes off.

Warning light	Warning light/Details	Correction procedure
	Open door warning light (warning buzzer)*¹ Indicates that a door or the trunk is not fully closed	Check that all the doors and the trunk are closed.
	Low fuel level warning light Indicates remaining fuel is approximately 2.6 gal. (9.7 L, 2.1 Imp. gal.) or less	Refuel the vehicle.
	Seat belt reminder light (warning buzzer)*² Warns the driver and/or front passenger to fasten their seat belts	Fasten the seat belt. If the front passenger's seat is occupied, the front passenger's seat belt also needs to be fastened to make the warning light (warning buzzer) off.
	Master warning light A buzzer sounds and the warning light comes on and flashes to indicate that the master warning system has detected a malfunction.	→P. 399

Warning light	Warning light/Details	Correction procedure
	Tire pressure warning light	
	When the light comes on: Low tire inflation pressure such as <ul style="list-style-type: none"> • Natural causes (→P. 394) • Flat tire (→P. 400) 	Adjust the tire inflation pressure to the specified level. The light will turn off after a few minutes. In case the light does not turn off even if the tire inflation pressure is adjusted, have the system checked by your Toyota dealer.
	When the light comes on after blinking for 1 minute: Malfunction in the tire pressure warning system	Have the system checked by your Toyota dealer.

*1: Open door warning buzzer:

A buzzer will sound if the vehicle reaches a speed of 3 mph (5 km/h) or more with any door open.

*2: Driver's seat belt buzzer:

The driver's seat belt buzzer sounds to alert the driver that his or her seat belt is not fastened. Once the engine switch is turned to IGNITION ON mode, the buzzer sounds for 6 seconds. If the vehicle reaches a speed of 12 mph (20 km/h), the buzzer sounds once. If the seat belt is still unfastened after 30 seconds, the buzzer will sound intermittently for 10 seconds. Then, if the seat belt is still unfastened, the buzzer will sound in a different tone for 20 more seconds.

Front passenger's seat belt buzzer:

The front passenger's seat belt buzzer sounds to alert the front passenger that his or her seat belt is not fastened. The buzzer sounds once if the vehicle reaches a speed of 12 mph (20 km/h). If the seat belt is still unfastened after 30 seconds, the buzzer will sound intermittently for 10 seconds. Then, if the seat belt is still unfastened, the buzzer will sound in a different tone for 20 more seconds.

■ SRS warning light

This warning light system monitors the airbag sensor assembly, front impact sensors, side impact sensors (front), side impact sensors (rear), driver's seat belt buckle switch, front passenger occupant classification system, "AIR BAG ON" indicator light, "AIR BAG OFF" indicator light, front passenger's seat belt buckle switch, seat belt pretensioners, airbags, interconnecting wiring and power sources. (→P. 35)

■ Front passenger detection sensor, seat belt reminder and warning buzzer

If luggage is placed on the front passenger seat, the front passenger detection sensor may cause the warning light to flash and the warning buzzer to sound even if a passenger is not sitting in the seat.

■ If the malfunction indicator lamp comes on while driving

First check the following:

- Is the fuel tank empty?
If it is, fill the fuel tank immediately.
- Is the fuel tank cap loose?
If it is, tighten it securely.

The light will go off after several driving trips.

If the light does not go off even after several trips, contact your Toyota dealer as soon as possible.

■ Electric power steering system warning light (warning buzzer)

When the battery charge becomes insufficient or the voltage temporarily drops, the electric power steering system warning light may come on and the warning buzzer may sound.

■ When the tire pressure warning light comes on

Check the tire inflation pressure and adjust to the appropriate level. Pushing the tire pressure warning reset switch will not turn off the tire pressure warning light.

■ The tire pressure warning light may come on due to natural causes

The tire pressure warning light may come on due to natural causes such as natural air leaks and tire inflation pressure changes caused by temperature. In this case, adjusting the tire inflation pressure will turn off the warning light (after a few minutes).

■ When a tire is replaced with a spare tire

The compact spare tire is not equipped with a tire pressure warning valve and transmitter. If a tire goes flat, the tire pressure warning light will not turn off even though the flat tire has been replaced with the spare tire. Replace the spare tire with the repaired tire and adjust the tire inflation pressure. The tire pressure warning light will go off after a few minutes.

■ Conditions that the tire pressure warning system may not function properly

The tire pressure warning system will be disabled in the following conditions:

(When the condition becomes normal, the system will work properly.)

- If tires not equipped with tire pressure warning valves and transmitters are used
- If the ID code on the tire pressure warning valves and transmitters is not registered in the tire pressure warning computer.
- If the tire inflation pressure is 73 psi (500 kPa, 5.1 kgf/cm² or bar) or higher

The tire pressure warning system may be disabled in the following conditions:

(When the condition becomes normal, the system will work properly.)

- If electronic devices or facilities using similar radio wave frequencies are nearby.
- If a radio set at a similar frequencies is in use in the vehicle
- If a window tint that affects the radio wave signals is installed
- If there is a lot of snow or ice on the vehicle, particularly around the wheels or wheel housings
- If non-genuine Toyota wheels are used. (Even if you use Toyota wheels, the tire pressure warning system may not work properly with some types of tires.)
- If tire chains are used

■ If the tire pressure warning light frequently comes on after blinking for 1 minute

If the tire pressure warning light frequently comes on after blinking for 1 minute when the engine switch is turned to IGNITION ON mode, have it checked by your Toyota dealer.

■ Warning buzzer

In some cases, the buzzer may not be heard because of noisy place or an audio sound.

 **CAUTION****■ If both the ABS and the brake system warning lights remain on**

Stop your vehicle in a safe place immediately and contact your Toyota dealer. The vehicle will become extremely unstable during braking, and the ABS system may fail, which could cause an accident resulting in death or serious injury.

■ When the electric power steering system warning light comes on

The steering wheel may become extremely heavy.

If the steering wheel becomes heavier than usual when operating, hold firmly and operate using more force than usual.

■ If the tire pressure warning light comes on

Be sure to observe the following precautions. Failure to do so could cause a loss of vehicle control and result in death or serious injury.

- Stop your vehicle in a safe place as soon as possible. Adjust the tire inflation pressure immediately.
- If the tire pressure warning light comes on even after tire inflation pressure adjustment, it is probable that you have a flat tire. Check the tires. If a tire is flat, change it with the spare tire and have the flat tire repaired by the nearest Toyota dealer.
- Avoid abrupt maneuvering and braking. If the vehicle tires deteriorate, you could lose control of the steering wheel or the brakes.

■ If a blowout or sudden air leakage should occur

The tire pressure warning system may not activate immediately.

 CAUTION**■ Maintenance of the tires**

Each tire, including the spare (if provided), should be checked monthly when cold and inflated to the inflation pressure recommended by the vehicle manufacturer on the vehicle placard or tire inflation pressure label (tire and load information label). (If your vehicle has tires of a different size than the size indicated on the vehicle placard or tire inflation pressure label [tire and load information label], you should determine the proper tire inflation pressure for those tires.)

As an added safety feature, your vehicle has been equipped with a tire pressure monitoring system (TPMS-tire pressure warning system) that illuminates a low tire pressure telltale (tire pressure warning light) when one or more of your tires is significantly under-inflated. Accordingly, when the low tire pressure telltale (tire pressure warning light) illuminates, you should stop and check your tires as soon as possible, and inflate them to the proper pressure. Driving on a significantly under-inflated tire causes the tire to overheat and can lead to tire failure. Under-inflation also reduces fuel efficiency and tire tread life, and may affect the vehicle's handling and stopping ability.

Please note that the TPMS (tire pressure warning system) is not a substitute for proper tire maintenance, and it is the driver's responsibility to maintain correct tire pressure, even if under-inflation has not reached the level to trigger illumination of the TPMS low tire pressure telltale (tire pressure warning light).

Your vehicle has also been equipped with a TPMS (tire pressure warning system) malfunction indicator to indicate when the system is not operating properly. The TPMS (tire pressure warning system) malfunction indicator is combined with the low tire pressure telltale (tire pressure warning light). When the system detects a malfunction, the telltale will flash for approximately one minute and then remain continuously illuminated. This sequence will continue upon subsequent vehicle start-ups as long as the malfunction exists. When the malfunction indicator is illuminated, the system may not be able to detect or signal low tire pressure as intended.

 CAUTION

TPMS (tire pressure warning system) malfunctions may occur for a variety of reasons, including the installation of replacement or alternate tires or wheels on the vehicle that prevent the TPMS (tire pressure warning system) from functioning properly. Always check the TPMS (tire pressure warning system) malfunction telltale after replacing one or more tires or wheels on your vehicle to ensure that the replacement or alternate tires and wheels allow the TPMS (tire pressure warning system) to continue to function properly.

 NOTICE

■ **To ensure the tire pressure warning system operates properly**

Do not install tires with different specifications or makers, as the tire pressure warning system may not operate properly.

If a warning message is displayed

The multi-information display shows warnings of system malfunctions, incorrectly performed operations, messages that indicate a need for maintenance and reminder messages. When a message is shown, perform the correction procedure appropriate to the message.

① Master warning light

The master warning light also comes on or flashes in order to indicate that a message is currently being displayed on the multi-information display.

② Multi-information display

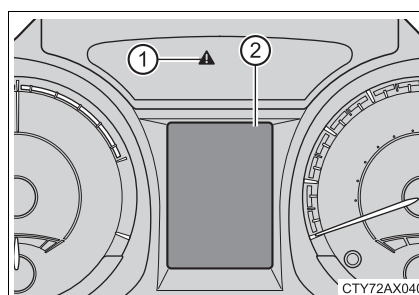

If any of the warning message is shown again after its correction procedure has been performed, contact your Toyota dealer.

■ Warning buzzer

In some cases, the buzzer may not be heard because of noisy place or an audio sound.

If you have a flat tire

Your vehicle is equipped with a spare tire. The flat tire can be replaced with the spare tire.

For details about tires: →P. 334

CAUTION

■ If you have a flat tire

Do not continue driving with a flat tire.

Driving even a short distance with a flat tire can damage the tire and the wheel beyond repair, which could result in an accident.

Before jacking up the vehicle

- Stop the vehicle on a hard, flat surface.
- Set the parking brake.
- Shift the shift lever to P.
- Stop the engine.
- Turn on the emergency flashers. (→P. 380)

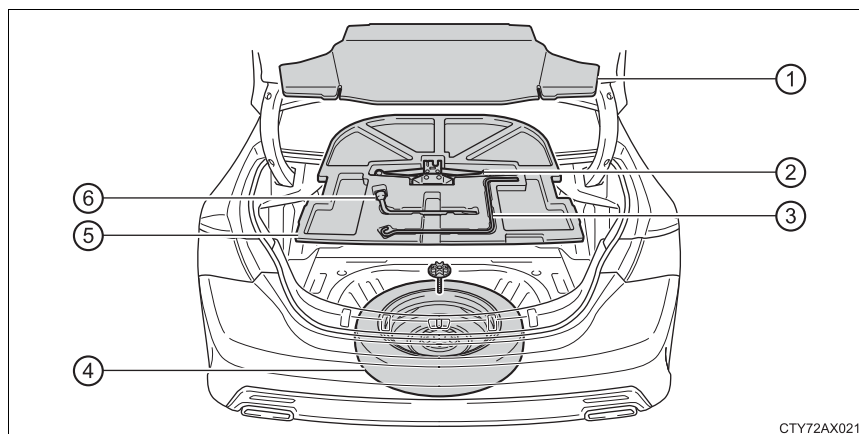
Location of the spare tire, jack and tools

- ① Luggage floor cover
- ② Jack
- ③ Jack handle
- ④ Spare tire
- ⑤ Tool tray
- ⑥ Wheel nut wrench

 CAUTION**■ Using the tire jack**

Observe the following precautions.

Improper use of the tire jack may cause the vehicle to suddenly fall off the jack, leading to death or serious injury.

- Do not use the tire jack for any purpose other than replacing tires or installing and removing tire chains.
- Only use the tire jack that comes with this vehicle for replacing a flat tire.
Do not use it on other vehicles, and do not use other tire jacks for replacing tires on this vehicle.
- Put the jack properly in its jack point.
- Do not put any part of your body under the vehicle while it is supported by the jack.
- Do not start the engine or drive the vehicle while the vehicle is supported by the jack.
- Do not raise the vehicle while someone is inside.
- When raising the vehicle, do not put an object on or under the jack.
- Do not raise the vehicle to a height greater than that required to replace the tire.
- Use a jack stand if it is necessary to get under the vehicle.
- When lowering the vehicle, make sure that there is no-one near the vehicle. If there are people nearby, warn them vocally before lowering.

Taking out the jack and jack handle

- 1 Remove the luggage floor cover.

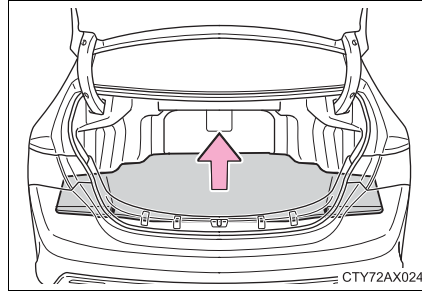

- 2 Remove the jack.

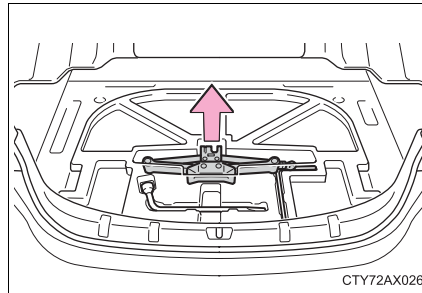

Taking out the spare tire

- 1 Remove the luggage floor cover. (→P. 403)
- 2 Remove the tool tray.

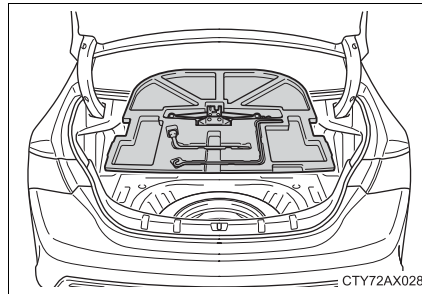

- 3 Loosen the center fastener that secures the spare tire.

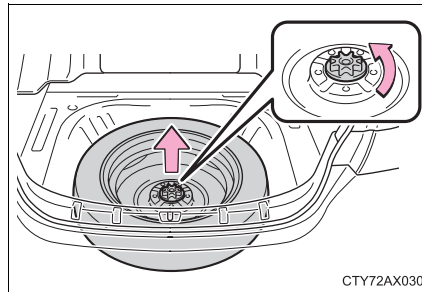

CAUTION

■ When storing the spare tire

Be careful not to catch fingers or other body parts between the spare tire and the body of the vehicle.

Replacing a flat tire

- 1 Check the tires.

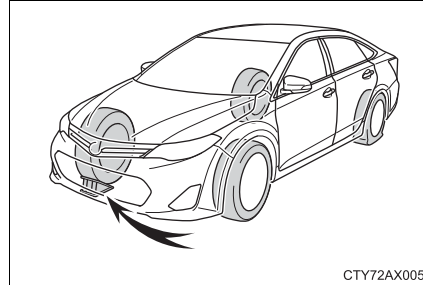

Flat tire		Wheel chock positions
Front	Left-hand side	Behind the rear right-hand side tire
	Right-hand side	Behind the rear left-hand side tire
Rear	Left-hand side	In front of the front right-hand side tire
	Right-hand side	In front of the front left-hand side tire

- 2 Slightly loosen the wheel nuts (one turn).

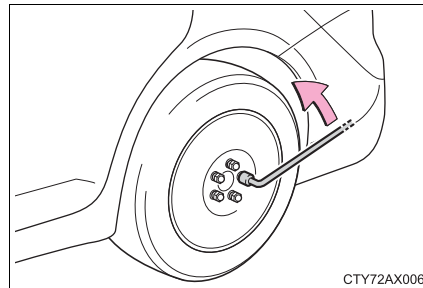

- 3 Turn the tire jack portion "A" by hand until the notch of the jack is in contact with the jack point. The jack point guides are located under the rocker panel. They indicate the jack point positions.

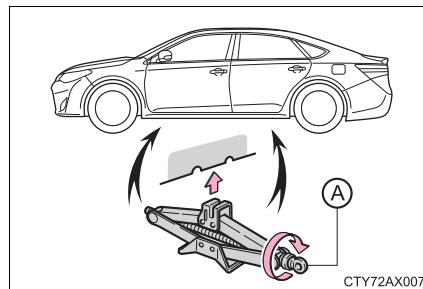

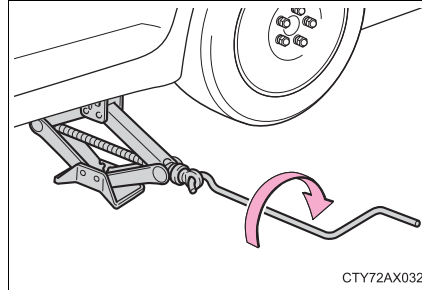

- 4 Raise the vehicle until the tire is slightly raised off the ground.

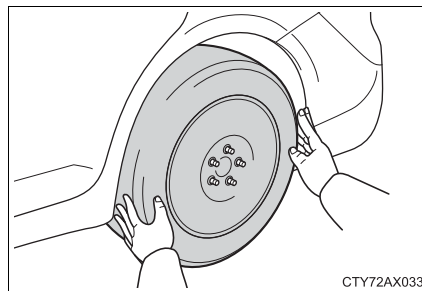

- 5 Remove all the wheel nuts and the tire.

When resting the tire on the ground, place the tire so that the wheel design faces up to avoid scratching the wheel surface.



 CAUTION

■ Replacing a flat tire

- Do not touch the disc wheels or the area around the brakes immediately after the vehicle has been driven.
After the vehicle has been driven the disc wheels and the area around the brakes will be extremely hot. Touching these areas with hands, feet or other body parts while changing a tire, etc. may result in burns.
- Failure to follow these precautions could cause the wheel nuts to loosen and the tire to fall off, resulting in death or serious injury.
 - Have the wheel nuts tightened with a torque wrench to 76 ft•lbf (103 N•m, 10.5 kgf•m) as soon as possible after changing wheels.
 - When installing a tire, only use wheel nuts that have been specifically designed for that wheel.
 - If there are any cracks or deformations in the bolt screws, nut threads or bolt holes of the wheel, have the vehicle inspected by your Toyota dealer.
 - When installing the wheel nuts, be sure to install them with the tapered ends facing inward. (→P. 346)

Installing the spare tire

- 1 Remove any dirt or foreign matter from the wheel contact surface.

If foreign matter is on the wheel contact surface, the wheel nuts may loosen while the vehicle is in motion, causing the tire to come off.

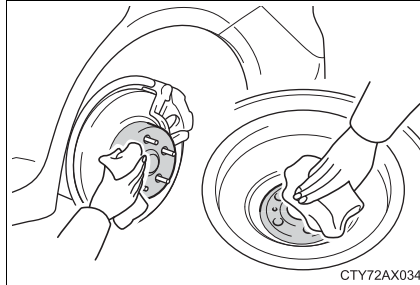

- 2 Install the spare tire and loosely tighten each wheel nut by hand by approximately the same amount.

Tighten the wheel nuts until the tapered portion comes into loose contact with the disc wheel seat.

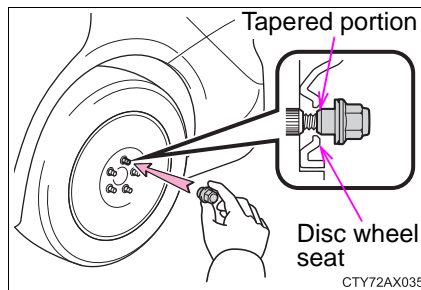

- 3 Lower the vehicle.

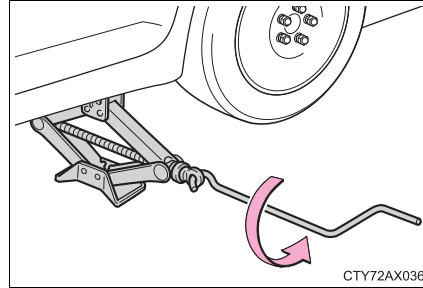

- 4 Firmly tighten each wheel nut two or three times in the order shown in the illustration.

Tightening torque:
76 ft•lbf (103 N•m, 10.5 kgf•m)

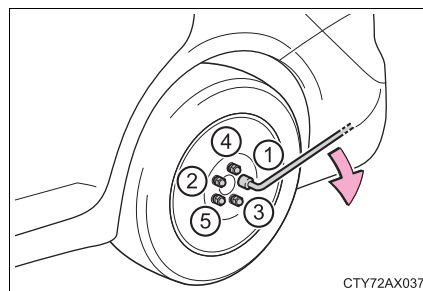

- 5 Stow the flat tire, tire jack and all tools.

■ **The compact spare tire**

- The compact spare tire is identified by the label “TEMPORARY USE ONLY” on the tire sidewall.
Use the compact spare tire temporarily, and only in an emergency.
- Make sure to check the tire inflation pressure of the compact spare tire.
(→P. 437)

■ **After completing the tire change**

The tire pressure warning system must be reset. (→P. 336)

■ **When using the compact spare tire**

As the compact spare tire is not equipped with a tire pressure warning valve and transmitter, low inflation pressure of the spare tire will not be indicated by the tire pressure warning system. Also, if you replace the compact spare tire after the tire pressure warning light comes on, the light remains on.

■ **When the compact spare tire is equipped**

The vehicle becomes lower when driving with the compact spare tire compared to when driving with standard tires.

■ **If you have a flat front tire on a road covered with snow or ice**

Install the compact spare tire on one of the rear wheels of the vehicle.
Perform the following steps and fit tire chains to the front tires:

- 1 Replace a rear tire with the compact spare tire.
- 2 Replace the flat front tire with the tire removed from the rear of the vehicle.
- 3 Fit tire chains to the front tires.

 CAUTION**■ When using the compact spare tire**

- Remember that the compact spare tire provided is specifically designed for use with your vehicle. Do not use your compact spare tire on another vehicle.
- Do not use more than one compact spare tires simultaneously.
- Replace the compact spare tire with a standard tire as soon as possible.
- Avoid sudden acceleration, abrupt steering, as well as sudden braking and shifting operation to engine braking.

■ When the compact spare tire is attached

The vehicle speed may not be correctly detected, and the following systems may not operate correctly:

- ABS & Brake assist
- VSC
- TRAC
- Cruise control (if equipped)
- Dynamic radar cruise control (if equipped)
- PCS (if equipped)
- EPS
- Rear view monitor system (if equipped)
- Navigation system (if equipped)

 CAUTION

■ **Speed limit when using the compact spare tire**

Do not drive at speeds in excess of 50 mph (80 km/h) when a compact spare tire is installed on the vehicle.

The compact spare tire is not designed for driving at high speeds. Failure to observe this precaution may lead to an accident causing death or serious injury.

■ **After using the tools and jack**

Before driving, make sure all the tools and jack are securely in place in their storage location to reduce the possibility of personal injury during a collision or sudden braking.

 NOTICE

■ **Driving with tire chains and the compact spare tire**

Do not fit tire chains to the compact spare tire.

Tire chains may damage the vehicle body and adversely affect driving performance.

■ **When replacing the tires**

When removing or fitting the wheels, tires or the tire pressure warning valve and transmitter, contact your Toyota dealer as the tire pressure warning valve and transmitter may be damaged if not handled correctly.

If the engine will not start

If the engine will not start even though correct starting procedures are being followed (→P. 159), consider each of the following points:

The engine will not start even though the starter motor operates normally.

One of the following may be the cause of the problem:

- There may not be sufficient fuel in the vehicle's tank.
Refuel the vehicle.
- The engine may be flooded.
Try to restart the engine again following correct starting procedures.
(→P. 159)
- There may be a malfunction in the engine immobilizer system.
(→P. 66)

The starter motor turns over slowly, the interior lights and headlights are dim, or the horn does not sound or sounds at a low volume.

One of the following may be the cause of the problem:

- The battery may be discharged. (→P. 419)
- The battery terminal connections may be loose or corroded.

The starter motor does not turn over

The engine starting system may be malfunctioning due to an electrical problem such as electronic key battery depletion or a blown fuse. However, an interim measure is available to start the engine.
(→P. 414)

The starter motor does not turn over, the interior lights and headlights do not turn on, or the horn does not sound.

One of the following may be the cause of the problem:

- One or both of the battery terminals may be disconnected.
- The battery may be discharged. (→P. 419)
- There may be a malfunction in the steering lock system.

Contact your Toyota dealer if the problem cannot be repaired, or if repair procedures are unknown.

Emergency start function

When the engine does not start, the following steps can be used as an interim measure to start the engine if the engine switch is functioning normally:

- 1 Set the parking brake.
- 2 Shift the shift lever to P.
- 3 Turn the engine switch to ACCESSORY mode.
- 4 Press and hold the engine switch for about 15 seconds while depressing the brake pedal firmly.

Even if the engine can be started using the above steps, the system may be malfunctioning. Have the vehicle inspected by your Toyota dealer.

If the shift lever cannot be shifted from P

If the shift lever cannot be shifted with your foot on the brake pedal, there may be a problem with the shift lock system (a system to prevent accidental operation of the shift lever). Have the vehicle inspected by your Toyota dealer immediately.

The following steps may be used as an emergency measure to ensure that the shift lever can be shifted:

- 1 Set the parking brake.
- 2 Turn the engine switch to ACCESSORY mode.
- 3 Depress the brake pedal.

- 4 Pry the cover up with a flathead screwdriver or equivalent tool.

To prevent damage to the cover, cover the tip of the screwdriver with a rag.

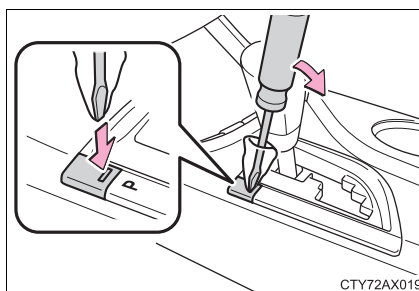

- 5 Press the shift lock override button.

The shift lever can be shifted while the button is pressed.

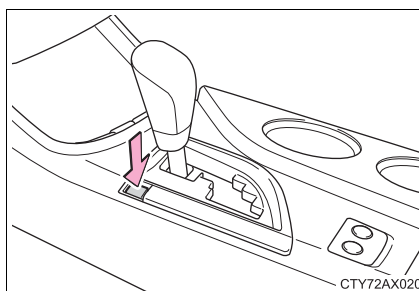

If the electronic key does not operate properly

If communication between the electronic key and vehicle is interrupted (→P. 102) or the electronic key cannot be used because the battery is depleted, the smart key system and wireless remote control cannot be used. In such cases, the doors and trunk can be opened and the engine can be started by following the procedure below.

Locking and unlocking the doors and unlocking the trunk

■ Doors

Use the mechanical key (→P. 90) in order to perform the following operations:

- ① Locks all the doors
- ② Unlocks the door

Turning the key rearward unlocks the driver's door. Turning the key once again within 5 seconds unlocks the other doors.

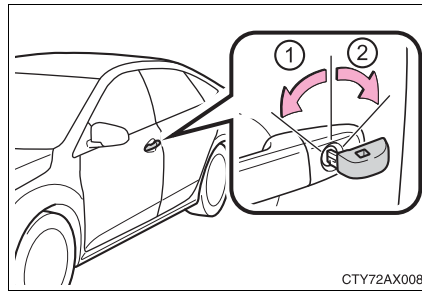

■ Trunk

→P. 116

Starting the engine

- 1 Ensure that the shift lever is in P and depress the brake pedal.

- 2 Touch the Toyota emblem side of the electronic key to the engine switch.

The engine switch will turn to IGNITION ON mode.

When the smart key system is deactivated in customization setting, the engine switch will turn to ACCESSORY mode.

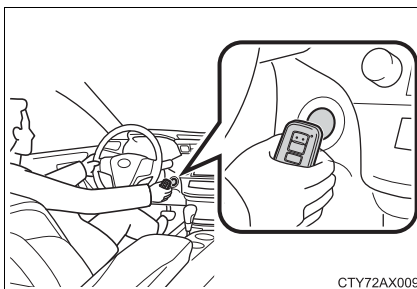

- 3 Firmly depress the brake pedal.

A message indicating how to start the engine will be displayed on the multi-information display.

- 4 Press the engine switch.

In the event that the engine still cannot be started, contact your Toyota dealer.

■ **Stopping the engine**

Shift the shift lever to P and press the engine switch as you normally do when stopping the engine.

■ **Replacing the key battery**

As the above procedure is a temporary measure, it is recommended that the electronic key battery be replaced immediately when the battery is depleted. (→P. 350)

■ **Changing engine switch modes**

Release the brake pedal and press the engine switch in step **3** above. The engine does not start and modes will be changed each time the switch is pressed.(→P. 160)

■ **When the electronic key does not work properly**

- Make sure that the smart key system has not been deactivated in the customization setting. If it is off, turn the function on. (Customizable features →P. 455)
- Check if battery-saving mode is set. If it is set, cancel the function. (→P. 101)

If the vehicle battery is discharged

The following procedures may be used to start the engine if the vehicle's battery is discharged.

You can also call your Toyota dealer or a qualified repair shop.

If you have a set of jumper (or booster) cables and a second vehicle with a 12-volt battery, you can jump start your vehicle by following the steps below.

- 1 Open the hood (→P. 319)
- 2 Connect the jumper cables according to the following procedure:

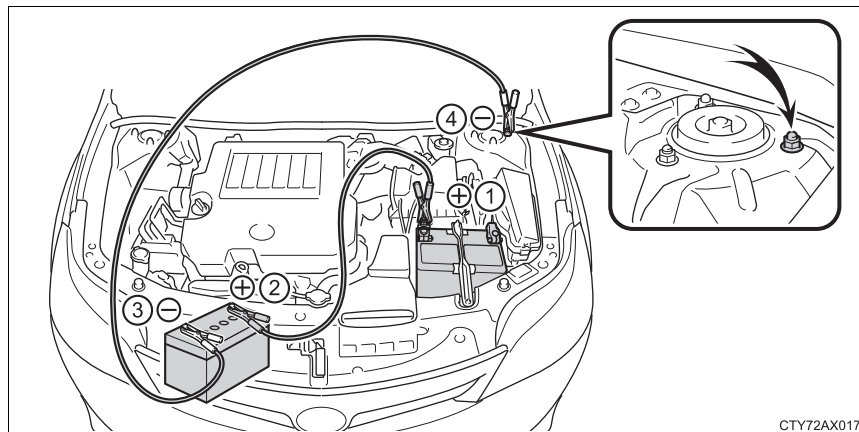

- 1 Connect a positive jumper cable clamp to the positive (+) battery terminal on your vehicle.
 - 2 Connect the clamp on the other end of the positive cable to the positive (+) battery terminal on the second vehicle.
 - 3 Connect a negative cable clamp to the negative (-) battery terminal on the second vehicle.
 - 4 Connect the clamp at the other end of the negative cable to a solid, stationary, unpainted metallic point away from the battery and any moving parts, as shown in the illustration.
- 3 Start the engine of the second vehicle. Increase the engine speed slightly and maintain at that level for approximately 5 minutes to recharge the battery of your vehicle.

- 4 Open and close any of the doors of your vehicle with the engine switch off.
- 5 Maintain the engine speed of the second vehicle and start the engine of your vehicle by turning the engine switch to IGNITION ON mode.
- 6 Once the vehicle's engine has started, remove the jumper cables in the exact reverse order from which they were connected.

Once the engine starts, have the vehicle inspected at your Toyota dealer as soon as possible.

■ Starting the engine when the battery is discharged

The engine cannot be started by push-starting.

■ To prevent battery discharge

- Turn off the headlights and the audio system while the engine is off.
- Turn off any unnecessary electrical components when the vehicle is running at a low speed for an extended period, such as in heavy traffic.

■ Charging the battery

The electricity stored in the battery will discharge gradually even when the vehicle is not in use, due to natural discharge and the draining effects of certain electrical appliances. If the vehicle is left for a long time, the battery may discharge, and the engine may be unable to start. (The battery recharges automatically during driving.)

■ When recharging or replacing the battery

- In some cases, it may not be possible to unlock the doors using the smart key system when the battery is discharged. Use the wireless remote control or the mechanical key to lock or unlock the doors.
- The engine may not start on the first attempt after the battery has recharged but will start normally after the second attempt. This is not a malfunction.
- The engine switch mode is memorized by the vehicle. When the battery is reconnected, the system will return to the mode it was in before the battery was discharged. Before disconnecting the battery, turn the engine switch off. If you are unsure what mode the engine switch was in before the battery discharged, be especially careful when reconnecting the battery.
- Make sure that the key is not inside the vehicle when recharging or replacing the battery. The key may be locked in the vehicle if the alarm is activated. (→P. 69)

 CAUTION**■ Avoiding battery fires or explosions**

Observe the following precautions to prevent accidentally igniting the flammable gas that may be emitted from the battery:

- Make sure each jumper cable is connected to the correct terminal and that it is not unintentionally in contact with any other than the intended terminal.
- Do not allow the other end of the jumper cable connected to the “+” terminal to come into contact with any other parts or metal surfaces in the area, such as brackets or unpainted metal.
- Do not allow the + and - clamps of the jumper cables to come into contact with each other.
- Do not smoke, use matches, cigarette lighters or allow open flame near the battery.

■ Battery precautions

The battery contains poisonous and corrosive acidic electrolyte, while related parts contain lead and lead compounds. Observe the following precautions when handling the battery:

- When working with the battery, always wear safety glasses and take care not to allow any battery fluids (acid) to come into contact with skin, clothing or the vehicle body.
- Do not lean over the battery.
- In the event that battery fluid comes into contact with the skin or eyes, immediately wash the affected area with water and seek medical attention. Place a wet sponge or cloth over the affected area until medical attention can be received.
- Always wash your hands after handling the battery support, terminals, and other battery-related parts.
- Do not allow children near the battery.

 NOTICE**■ When handling jumper cables**

When connecting the jumper cables, ensure that they do not become entangled in the cooling fans or engine drive belt.

If your vehicle overheats

The following may indicate that your vehicle is overheating:

- The needle of the engine coolant temperature gauge (→P. 77) enters the red zone or a loss of engine power is experienced. (For example, the vehicle speed does not increase.)
- Steam comes out from under the hood.

Correction procedures

- 1 Stop the vehicle in a safe place and turn off the air conditioning system, and then stop the engine.
- 2 If you see steam:
Carefully lift the hood after the steam subsides.
If you do not see steam:
Carefully lift the hood.

- 3 After the engine has cooled down sufficiently, inspect the hoses and radiator core (radiator) for any leaks.

- ① Radiator
- ② Cooling fan

If a large amount of coolant leaks, immediately contact your Toyota dealer.

- 4 The coolant level is satisfactory if it is between the "F" and "L" lines on the reservoir.

- ① Reservoir
- ② "F" line
- ③ "L" line
- ④ Radiator cap

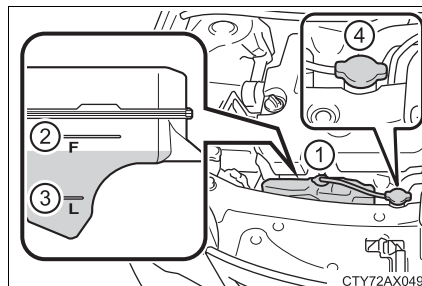
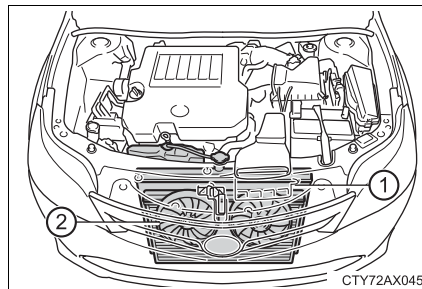

- 5 Add engine coolant if necessary.

Water can be used in an emergency if engine coolant is unavailable.

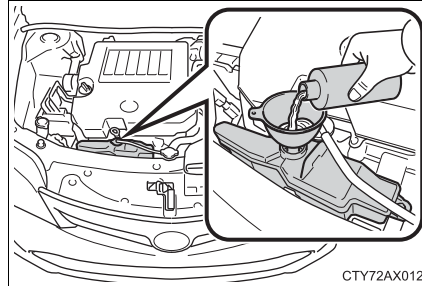

- 6 Start the engine and turn the air conditioning system on to check that the radiator cooling fans operate and to check for coolant leaks from the radiator or hoses.

The fans operate when the air conditioning system is turned on immediately after a cold start. Confirm that the fans are operating by checking the fan sound and air flow. If it is difficult to check these, turn the air conditioning system on and off repeatedly. (The fans may not operate in freezing temperatures.)

- 7 If the fans are not operating:
Stop the engine immediately and contact your Toyota dealer.
If the fans are operating:
Have the vehicle inspected at the nearest Toyota dealer.

⚠ CAUTION**■ When inspecting under the hood of your vehicle**

Observe the following precautions.

Failure to do so may result in serious injury such as burns.

- If steam is seen coming from under the hood, do not open the hood until the steam has subsided. The engine compartment may be very hot.
- Keep hands and clothing (especially a tie, a scarf or a muffler) away from the fans and belts.
- Do not loosen the radiator cap and the coolant reservoir cap while the engine and radiator are hot. High temperature steam or coolant could spray out.

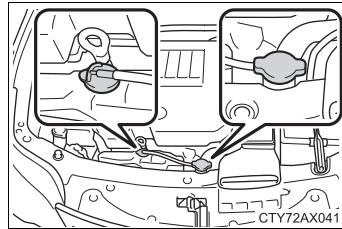
**⚠ NOTICE****■ When adding engine coolant**

Wait until the engine has cooled down before adding engine coolant.

When adding coolant, do so slowly. Adding cool coolant to a hot engine too quickly can cause damage to the engine.

■ To prevent damage to the cooling system

Observe the following precautions:

- Avoid contaminating the coolant with foreign matter (such as sand or dust etc.).
- Do not use any coolant additive.

If the vehicle becomes stuck

Carry out the following procedures if the tires spin or the vehicle becomes stuck in mud, dirt or snow:

- 1 Stop the engine. Set the parking brake and shift the shift lever to P.
- 2 Remove the mud, snow or sand from around the front wheels.
- 3 Place wood, stones or some other material under the front wheels to help provide traction.
- 4 Restart the engine.
- 5 Shift the shift lever to D or R and release the parking brake. Then, while exercising caution, depress the accelerator pedal.

■ When it is difficult to free the vehicle

Press  to turn off TRAC.

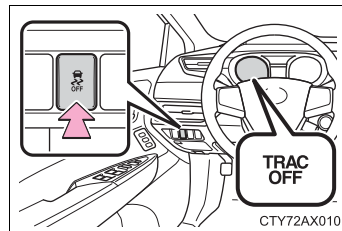

⚠ CAUTION

■ When attempting to free a stuck vehicle

If you choose to push the vehicle back and forth to free it, make sure the surrounding area is clear to avoid striking other vehicles, objects or people. The vehicle may also lunge forward or lunge back suddenly as it becomes free. Use extreme caution.

■ When shifting the shift lever

Be careful not to shift the shift lever with the accelerator pedal depressed. This may lead to unexpected rapid acceleration of the vehicle that may cause an accident resulting in death or serious injury.

 NOTICE**■ To avoid damaging the transmission and other components**

- Avoid spinning the front wheels and depressing the accelerator pedal more than necessary.
- If the vehicle remains stuck even after these procedures are performed, the vehicle may require towing to be freed.

Vehicle specifications

8

429

8-1. Specifications

- Maintenance data
(fuel, oil level, etc.) 430
- Fuel information 439
- Tire information 442

8-2. Customization

- Customizable features 455

8-3. Items to initialize

- Items to initialize 461

Maintenance data (fuel, oil level, etc.)

Dimensions and weight

Overall length	195.3 in. (4960 mm)	
Overall width	72.2 in. (1835 mm)	
Overall height*	57.5 in. (1460 mm)	
Wheelbase	111.0 in. (2820 mm)	
Tread*	Front	62.6 in. (1590 mm)
	Rear	62.2 in. (1580 mm)
Vehicle capacity weight (Occupants + luggage)	930 lb. (420 kg)	

*: Unladen vehicle

Vehicle identification

■ Vehicle identification number

The vehicle identification number (VIN) is the legal identifier for your vehicle. This is the primary identification number for your Toyota. It is used in registering the ownership of your vehicle.

This number is located on the top left of the instrument panel.

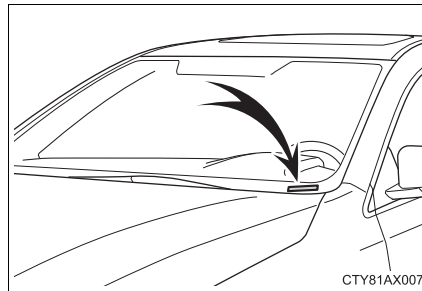

This number is also on the Certification Label.

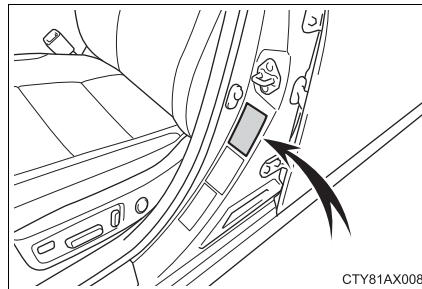

■ Engine number

The engine number is stamped on the engine block as shown.

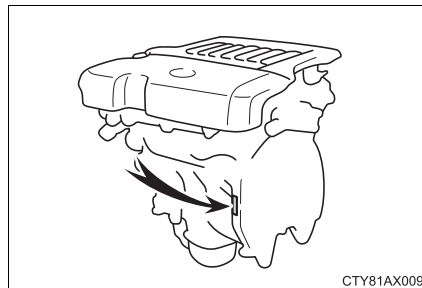

Engine

Model	3.5L 6-cylinder (2GR-FE)
Type	6-cylinder V type, 4-cycle, gasoline
Bore and stroke	3.70 × 3.27 in. (94.0 × 83.0 mm)
Displacement	210.9 cu. in. (3456 cm ³)
Valve clearance (engine cold)	Automatic adjustment
Drive belt tension	Automatic adjustment

Fuel

Fuel type	Unleaded gasoline only
Octane Rating	87 (Research Octane Number 91) or higher
Fuel tank capacity (Reference)	17.0 gal. (64.35 L, 14.2 Imp. gal.)

Lubrication system

Oil capacity Drain and refill (Reference*)	
With filter	6.4 qt. (6.1 L, 5.4 Imp. qt.)
Without filter	6.0 qt. (5.7 L, 5.0 Imp. qt.)

*: The engine oil capacity is a reference quantity to be used when changing the engine oil. Warm up and turn off the engine, wait more than 5 minutes, and check the oil level on the dipstick.

■ Engine oil selection

“Toyota Genuine Motor Oil” is used in your Toyota vehicle. Use Toyota approved “Toyota Genuine Motor Oil” or equivalent to satisfy the following grade and viscosity.

Oil grade: ILSAC GF-5 multigrade engine oil

Recommended viscosity: SAE 0W-20

SAE 0W-20 is the best choice for good fuel economy and good starting in cold weather.

If SAE 0W-20 is not available, SAE 5W-20 oil may be used. However, it must be replaced with SAE 0W-20 at the next oil change.

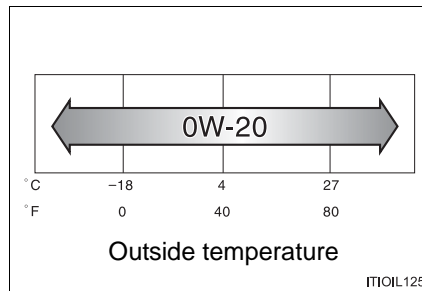

How to read oil container label

The International Lubricant Specification Advisory Committee (ILSAC) Certification Mark is added to some oil containers to help you select the oil you should use.



Cooling system

Capacity	9.7 qt. (9.2 L, 8.1 Imp. qt.)
Coolant type	<p>Use either of the following:</p> <ul style="list-style-type: none"> • “Toyota Super Long Life Coolant” • Similar high-quality ethylene glycol-based non-silicate, non-amine, non-nitrite, and non-borate coolant with long-life hybrid organic acid technology <p>Do not use plain water alone.</p>

Ignition system

Spark plug	
Make	DENSO FK20HR11
Gap	0.043 in. (1.1 mm)

 NOTICE**■ Iridium-tipped spark plugs**

Use only iridium-tipped spark plugs. Do not adjust the spark plug gap.

Electrical system

Battery	
Open voltage at 68°F (20°C):	12.6 — 12.8 V Fully charged 12.2 — 12.4 V Half charged 11.8 — 12.0 V Discharged (Voltage is checked 20 minutes after the engine and all lights are turned off.)
Charging rates	5 A max.

Automatic transaxle

Fluid capacity*	6.9 qt. (6.5 L, 5.7 Imp. qt.)
Fluid type	Toyota Genuine ATF WS

*: The fluid capacity is the quantity of reference.
If replacement is necessary, contact your Toyota dealer.

 **NOTICE**

Automatic transmission fluid type

Using transmission fluid other than “Toyota Genuine ATF WS” may cause deterioration in shift quality, locking up of your transmission accompanied by vibration, and ultimately damage the transmission of your vehicle.

Brakes

Pedal clearance ^{*1}	1.43 in. (36.4 mm) Min.
Pedal free play	0.04 — 0.24 in. (1.0 — 6.0 mm)
Brake pad wear limit	0.04 in. (1.0 mm)
Parking brake lining wear limit	0.04 in. (1.0 mm)
Parking brake pedal travel ^{*2}	7 — 10 clicks
Fluid type	SAE J1703 or FMVSS No.116 DOT 3

*1: Minimum pedal clearance when depressed with a force of 110 lbf (490 N, 50 kgf) while the engine is running

*2: Parking brake pedal travel when depressed with a force of 67 lbf (300 N, 30.6 kgf).

Steering

Free play	Less than 1.2 in. (30 mm)
-----------	---------------------------

Tires and wheels

► Type A

Tire size	P215/55R17 93V
Tire inflation pressure (Recommended cold tire inflation pressure)	Front 33 psi (230 kPa, 2.3 kgf/cm ² or bar) Rear 33 psi (230 kPa, 2.3 kgf/cm ² or bar)
Wheel size	17 × 7 J
Wheel nut torque	76 ft•lbf (103 N•m, 10.5 kgf•m)

► Type B

Tire size	P225/45R18 91V
Tire inflation pressure (Recommended cold tire inflation pressure)	Front 33 psi (230 kPa, 2.3 kgf/cm ² or bar) Rear 33 psi (230 kPa, 2.3 kgf/cm ² or bar)
Wheel size	18 × 7 1/2 J
Wheel nut torque	76 ft•lbf (103 N•m, 10.5 kgf•m)

► Compact spare tire

Tire size	T155/70D17 110M
Tire inflation pressure (Recommended cold tire inflation pressure)	60 psi (420 kPa, 4.2 kgf/cm ² or bar)
Wheel size	17 × 4 T
Wheel nut torque	76 ft•lbf (103 N•m, 10.5 kgf•m)

Light bulbs

	Light bulbs	Bulb No.	W	Type
Exterior	Headlights			
	Low beam (discharge bulbs)	—	35	A
	Low beam (halogen bulbs)	9005	60	B
	High beam	9005	60	C
	Fog lights*	—	55	D
	Front turn signal/parking lights	7444NA	28/8	E
	Side marker lights	W5W	5	F
	Side turn signal lights	WY5W	5	E
	Rear turn signal lights	921	16	F
Interior	Back-up lights	921	16	F
	License plate lights	W5W	5	F
	Interior/front personal lights	W6W	6	F
	Interior/rear personal lights	—	8	F
	Vanity lights	7065	1.4	G
Door courtesy lights	168	5	F	
Trunk light	194	3.8	F	

A: D4S discharge bulbs

B: HB3L+ halogen bulbs

C: HB3 halogen bulbs

D: H11 halogen bulbs

E: Wedge base bulbs (amber)

F: Wedge base bulbs (clear)

G: Double end bulbs

*: If equipped

Fuel information

You must only use unleaded gasoline in your vehicle. Select unleaded gasoline with an octane rating of 87 (Research Octane Number 91) or higher required for optimum engine performance. Use of unleaded gasoline with an octane rating lower than 87 may result in engine knocking and significantly reduced performance. Persistent knocking can lead to engine damage and should be corrected by refueling with higher octane unleaded gasoline.

At minimum, the gasoline you use should meet the specifications of ASTM D4814 in the U.S.A..

■ Fuel tank opening for unleaded gasoline

To help prevent incorrect fueling, your vehicle has a fuel tank opening that only accommodates the special nozzle on unleaded fuel pumps.

■ Gasoline quality

In very few cases, driveability problems may be caused by the brand of gasoline you are using. If driveability problems persist, try changing the brand of gasoline. If this does not correct the problem, consult your Toyota dealer.

■ Gasoline quality standards

- Automotive manufacturers in the U.S.A., Europe and Japan have developed a specification for fuel quality called the World-Wide Fuel Charter (WWFC), which is expected to be applied worldwide.
- The WWFC consists of four categories that are based on required emission levels. In the U.S., category 4 has been adopted.
- The WWFC improves air quality by lowering emissions in vehicle fleets, and improves customer satisfaction through better performance.

■ Recommendation of the use of gasoline containing detergent additives

- Toyota recommends the use of gasoline that contains detergent additives to avoid the build-up of engine deposits.
- All gasoline sold in the U.S.A. contains minimum detergent additives to clean and/or keep clean intake systems, per EPA's lowest additives concentration program.
- Toyota strongly recommends the use of Top Tier Detergent Gasoline. For more information on Top Tier Detergent Gasoline and a list of marketers, please go to the official website www.toptiergas.com.

■ Recommendation of the use of cleaner burning gasoline

Cleaner burning gasoline, including reformulated gasoline that contains oxygenates such as ethanol or MTBE (Methyl Tertiary Butyl Ether) is available in many areas.

Toyota recommends the use of cleaner burning gasoline and appropriately blended reformulated gasoline. These types of gasoline provide excellent vehicle performance, reduce vehicle emissions and improve air quality.

■ Non-recommendation of the use of blended gasoline

- Use only gasoline containing up to 15% ethanol.
DO NOT use any flex-fuel or gasoline that could contain more than 15% ethanol, including from any pump labeled E30, E50, E85 (which are only some examples of fuel containing more than 15% ethanol).

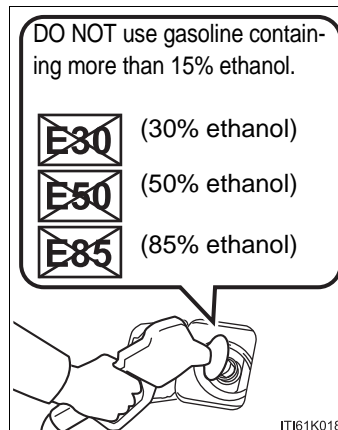

- If you use gasohol in your vehicle, be sure that it has an octane rating no lower than 87.
- Toyota does not recommend the use of gasoline containing methanol.

■ Non-recommendation of the use of gasoline containing MMT

Some gasoline contains an octane enhancing additive called MMT (Methylcyclopentadienyl Manganese Tricarbonyl).

Toyota does not recommend the use of gasoline that contains MMT. If fuel containing MMT is used, your emission control system may be adversely affected.

The malfunction indicator lamp on the instrument cluster may come on. If this happens, contact your Toyota dealer for service.

■ If your engine knocks

- Consult your Toyota dealer.
- You may occasionally notice light knocking for a short time while accelerating or driving uphill. This is normal and there is no need for concern.

NOTICE

■ Notice on fuel quality

- Do not use improper fuels. If improper fuels are used, the engine will be damaged.
- Do not use leaded gasoline.
Leaded gasoline can cause damage to your vehicle's three-way catalytic converters causing the emission control system to malfunction.
- Do not use gasohol other than the type previously stated.
Other gasohol may cause fuel system damage or vehicle performance problems.
- Using unleaded gasoline with an octane number or rating lower than the level previously stated will cause persistent heavy knocking.
At worst, this will lead to engine damage.

■ Fuel-related poor driveability

If poor driveability is encountered after using a different type of fuel (poor hot starting, vaporization, engine knocking, etc.), discontinue the use of that type of fuel.

■ When refueling with gasohol

Take care not to spill gasohol. It can damage your vehicle's paint.

Tire information

Typical tire symbols

► Full-size tire

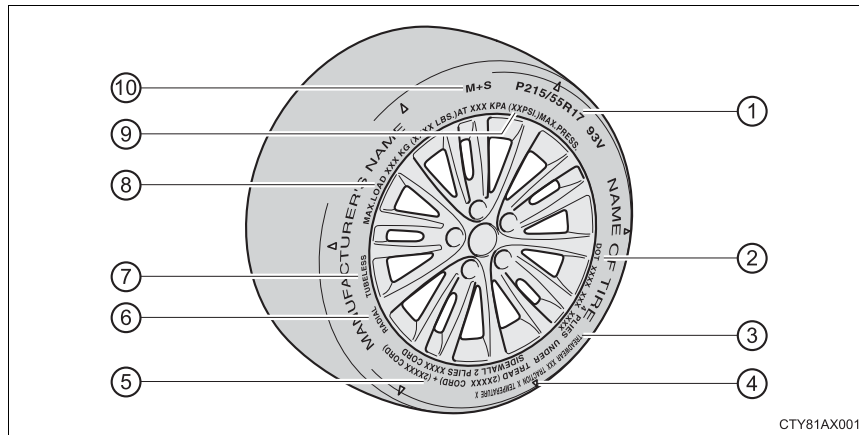

► Compact spare tire

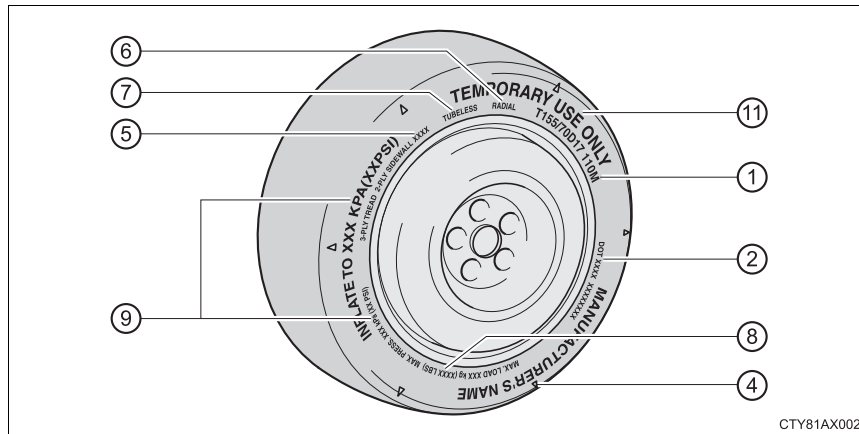

- ① Tire size (→P. 445)
- ② DOT and Tire Identification Number (TIN)(→P. 444)
- ③ Uniform tire quality grading
For details, see “Uniform Tire Quality Grading” that follows.
- ④ Location of treadwear indicators(→P. 334)
- ⑤ Tire ply composition and materials
Plies are layers of rubber-coated parallel cords. Cords are the strands which form the plies in a tire.
- ⑥ Radial tires or bias-ply tires
A radial tire has “RADIAL” on the sidewall. A tire not marked “RADIAL” is a bias-ply tire.
- ⑦ TUBELESS or TUBE TYPE
A tubeless tire does not have a tube and air is directly put into the tire. A tube type tire has a tube inside the tire and the tube maintains the air pressure.
- ⑧ Load limit at maximum cold tire inflation pressure (→P. 449)
- ⑨ Maximum cold tire inflation pressure (→P. 449)
This means the pressure to which a tire may be inflated.
- ⑩ Summer tires or all season tires (→P. 338)
An all season tire has “M+S” on the sidewall. A tire not marked “M+S” is a summer tire.
- ⑪ “TEMPORARY USE ONLY”
A compact spare tire is identified by the phrase “TEMPORARY USE ONLY” molded on its sidewall. This tire is designed for temporary emergency use only.

Typical DOT and Tire Identification Number (TIN)

- ① DOT symbol*
- ② Tire Identification Number (TIN)
- ③ Tire manufacturer's identification mark
- ④ Tire size code
- ⑤ Manufacturer's optional tire type code (3 or 4 letters)
- ⑥ Manufacturing week
- ⑦ Manufacturing year

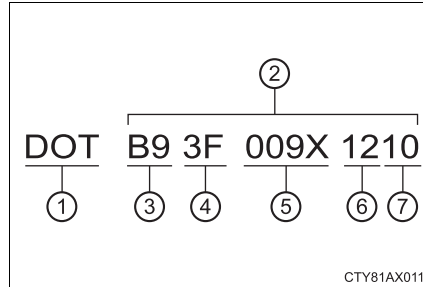

*: The DOT symbol certifies that the tire conforms to applicable Federal Motor Vehicle Safety Standards.

Tire size

■ Typical tire size information

The illustration indicates typical tire size.

- ① Tire use (P = Passenger car, T = Temporary use)
- ② Section width (millimeters)
- ③ Aspect ratio (tire height to section width)
- ④ Tire construction code (R = Radial, D = Diagonal)
- ⑤ Wheel diameter (inches)
- ⑥ Load index (2 digits or 3 digits)
- ⑦ Speed symbol (alphabet with one letter)

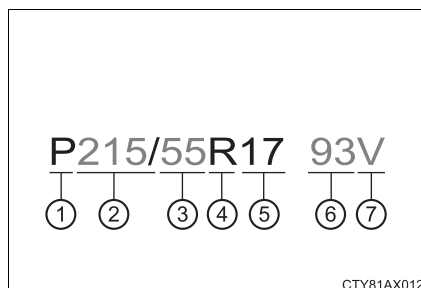

■ Tire dimensions

- ① Section width
- ② Tire height
- ③ Wheel diameter

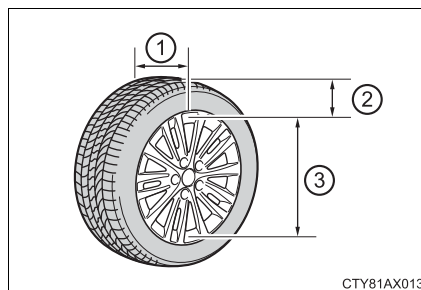

Tire section names

- ① Bead
- ② Sidewall
- ③ Shoulder
- ④ Tread
- ⑤ Belt
- ⑥ Inner liner
- ⑦ Reinforcing rubber
- ⑧ Carcass
- ⑨ Rim lines
- ⑩ Bead wires
- ⑪ Chafer

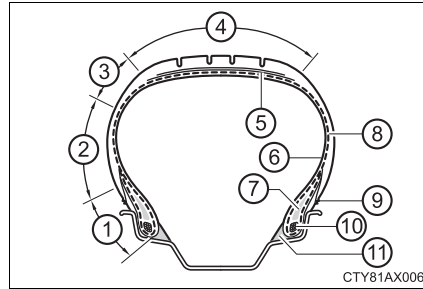

Uniform Tire Quality Grading

This information has been prepared in accordance with regulations issued by the National Highway Traffic Safety Administration of the U.S. Department of Transportation.

It provides the purchasers and/or prospective purchasers of Toyota vehicles with information on uniform tire quality grading.

Your Toyota dealer will help answer any questions you may have as you read this information.

■ DOT quality grades

All passenger vehicle tires must conform to Federal Safety Requirements in addition to these grades. Quality grades can be found where applicable on the tire sidewall between tread shoulder and maximum section width.

For example: Treadwear 200 Traction AA Temperature A

■ Treadwear

The treadwear grade is a comparative rating based on the wear rate of the tire when tested under controlled conditions on a specified government test course.

For example, a tire graded 150 would wear one and a half (1 - 1/2) times as well on the government course as a tire graded 100.

The relative performance of tires depends upon the actual conditions of their use. Performance may differ significantly from the norm due to variations in driving habits, service practices and differences in road characteristics and climate.

■ Traction AA, A, B, C

The traction grades, from highest to lowest, are AA, A, B and C, and they represent the tire's ability to stop on wet pavement as measured under controlled conditions on specified government test surfaces of asphalt and concrete.

A tire marked C may have poor traction performance.

Warning: The traction grade assigned to this tire is based on braking (straight ahead) traction tests and does not include cornering (turning) traction.

■ **Temperature A, B, C**

The temperature grades are A (the highest), B, and C, representing the tire's resistance to the generation of heat and its ability to dissipate heat when tested under controlled conditions on a specified indoor laboratory test wheel.

Sustained high temperature can cause the material of the tire to degenerate and reduce tire life, and excessive temperature can lead to sudden tire failure.

Grade C corresponds to a level of performance which all passenger car tires must meet under the Federal Motor Vehicle Safety Standard No. 109.

Grades B and A represent higher levels of performance on the laboratory test wheel than the minimum required by law.

Warning: The temperature grades of a tire assume that it is properly inflated and not overloaded.

Excessive speed, underinflation, or excessive loading, either separately or in combination, can cause heat buildup and possible tire failure.

Glossary of tire terminology

Tire related term	Meaning
Cold tire inflation pressure	Tire pressure when the vehicle has been parked for three hours or more, or has not been driven more than 1 mile or 1.5 km under that condition
Maximum inflation pressure	The maximum cold inflated pressure to which a tire may be inflated, shown on the sidewall of the tire
Recommended inflation pressure	Cold tire inflation pressure recommended by a manufacturer
Accessory weight	The combined weight (in excess of those standard items which may be replaced) of automatic transmission, power steering, power brakes, power windows, power seats, radio and heater, to the extent that these items are available as factory-installed equipment (whether installed or not)
Curb weight	The weight of a motor vehicle with standard equipment, including the maximum capacity of fuel, oil and coolant, and if so equipped, air conditioning and additional weight optional engine
Maximum loaded vehicle weight	The sum of: (a) Curb weight (b) Accessory weight (c) Vehicle capacity weight (d) Production options weight
Normal occupant weight	150 lb. (68 kg) times the number of occupants specified in the second column of Table 1* that follows
Occupant distribution	Distribution of occupants in a vehicle as specified in the third column of Table 1* below

Tire related term	Meaning
Production options weight	The combined weight of installed regular production options weighing over 5 lb. (2.3 kg) in excess of the standard items which they replace, not previously considered in curb weight or accessory weight, including heavy duty brakes, ride levelers, roof rack, heavy duty battery, and special trim
Rim	A metal support for a tire or a tire and tube assembly upon which the tire beads are seated
Rim diameter (Wheel diameter)	Nominal diameter of the bead seat
Rim size designation	Rim diameter and width
Rim type designation	The industry manufacturer's designation for a rim by style or code
Rim width	Nominal distance between rim flanges
Vehicle capacity weight (Total load capacity)	The rated cargo and luggage load plus 150 lb. (68 kg) times the vehicle's designated seating capacity
Vehicle maximum load on the tire	The load on an individual tire that is determined by distributing to each axle its share of the maximum loaded vehicle weight, and dividing by two
Vehicle normal load on the tire	The load on an individual tire that is determined by distributing to each axle its share of curb weight, accessory weight, and normal occupant weight (distributed in accordance with Table 1* below), and dividing by two
Weather side	The surface area of the rim not covered by the inflated tire
Bead	The part of the tire that is made of steel wires, wrapped or reinforced by ply cords and that is shaped to fit the rim
Bead separation	A breakdown of the bond between components in the bead

Tire related term	Meaning
Bias ply tire	A pneumatic tire in which the ply cords that extend to the beads are laid at alternate angles substantially less than 90 degrees to the centerline of the tread
Carcass	The tire structure, except tread and sidewall rubber which, when inflated, bears the load
Chunking	The breaking away of pieces of the tread or sidewall
Cord	The strands forming the plies in the tire
Cord separation	The parting of cords from adjacent rubber compounds
Cracking	Any parting within the tread, sidewall, or innerliner of the tire extending to cord material
CT	A pneumatic tire with an inverted flange tire and rim system in which the rim is designed with rim flanges pointed radially inward and the tire is designed to fit on the underside of the rim in a manner that encloses the rim flanges inside the air cavity of the tire
Extra load tire	A tire designed to operate at higher loads and at higher inflation pressures than the corresponding standard tire
Groove	The space between two adjacent tread ribs
Innerliner	The layer(s) forming the inside surface of a tubeless tire that contains the inflating medium within the tire
Innerliner separation	The parting of the innerliner from cord material in the carcass
Intended sidewall outboard	(a) The sidewall that contains a whitewall, bears white lettering, or bears manufacturer, brand, and/or model name molding that is higher or deeper than the same molding on the other sidewall of the tire, or (b) The outward facing sidewall of an asymmetrical tire that has a particular side that must always face outward when mounted on a vehicle

Tire related term	Meaning
Light truck (LT) tire	A tire designated by its manufacturer as primarily intended for use on lightweight trucks or multipurpose passenger vehicles
Load rating	The maximum load that a tire is rated to carry for a given inflation pressure
Maximum load rating	The load rating for a tire at the maximum permissible inflation pressure for that tire
Maximum permissible inflation pressure	The maximum cold inflation pressure to which a tire may be inflated
Measuring rim	The rim on which a tire is fitted for physical dimension requirements
Open splice	Any parting at any junction of tread, sidewall, or innerliner that extends to cord material
Outer diameter	The overall diameter of an inflated new tire
Overall width	The linear distance between the exteriors of the sidewalls of an inflated tire, including elevations due to labeling, decorations, or protective bands or ribs
Passenger car tire	A tire intended for use on passenger cars, multipurpose passenger vehicles, and trucks, that have a gross vehicle weight rating (GVWR) of 10,000 lb. or less.
Ply	A layer of rubber-coated parallel cords
Ply separation	A parting of rubber compound between adjacent plies
Pneumatic tire	A mechanical device made of rubber, chemicals, fabric and steel or other materials, that, when mounted on an automotive wheel, provides the traction and contains the gas or fluid that sustains the load
Radial ply tire	A pneumatic tire in which the ply cords that extend to the beads are laid at substantially 90 degrees to the centerline of the tread
Reinforced tire	A tire designed to operate at higher loads and at higher inflation pressures than the corresponding standard tire

Tire related term	Meaning
Section width	The linear distance between the exteriors of the sidewalls of an inflated tire, excluding elevations due to labeling, decoration, or protective bands
Sidewall	That portion of a tire between the tread and bead
Sidewall separation	The parting of the rubber compound from the cord material in the sidewall
Snow tire	A tire that attains a traction index equal to or greater than 110, compared to the ASTM E-1136 Standard Reference Test Tire, when using the snow traction test as described in ASTM F-1805-00, Standard Test Method for Single Wheel Driving Traction in a Straight Line on Snow-and Ice-Covered Surfaces, and which is marked with an Alpine Symbol () on at least one sidewall
Test rim	The rim on which a tire is fitted for testing, and may be any rim listed as appropriate for use with that tire
Tread	That portion of a tire that comes into contact with the road
Tread rib	A tread section running circumferentially around a tire
Tread separation	Pulling away of the tread from the tire carcass
Treadwear indicators (TWI)	The projections within the principal grooves designed to give a visual indication of the degrees of wear of the tread
Wheel-holding fixture	The fixture used to hold the wheel and tire assembly securely during testing

*: Table 1 — Occupant loading and distribution for vehicle normal load for various designated seating capacities

Designated seating capacity, Number of occupants	Vehicle normal load, Number of occupants	Occupant distribution in a normally loaded vehicle
2 through 4	2	2 in front
5 through 10	3	2 in front, 1 in second seat
11 through 15	5	2 in front, 1 in second seat, 1 in third seat, 1 in fourth seat
16 through 20	7	2 in front, 2 in second seat, 2 in third seat, 1 in fourth seat

Customizable features

Your vehicle includes a variety of electronic features that can be personalized to suit your preferences. The settings of these features can be changed on the audio system screen or at your Toyota dealer.

Some function settings are changed simultaneously with other functions being customized. Contact your Toyota dealer for further details.

Customizing vehicle features

It is possible to customize certain vehicle features using the audio system.

- 1 Press the "APPS" button.
- 2 Select "Setup" on the "Apps" screen and select "Vehicle".

Various setting can be changed. Refer to the list of settings that can be changed for details.

Customizable Features

- ① Vehicles with an audio system: Settings that can be changed using the audio system
- ② Settings that can be changed by your Toyota dealer

Definition of symbols: ○ = Available, — = Not available

Item	Function	Default setting	Customized setting	①	②
Smart key system and wireless remote control (→P. 93, 108)	Operation signal (Emergency flashers)	On	Off	O	O
	Operation signal (Buzzer)	On	Off	—	O
	Operation buzzer volume	Level 5	Off to level 7	O	O
	Time elapsed before automatic door lock function is activated if door is not opened after being unlocked	60 seconds	Off	O	O
			30 seconds		
	120 seconds				
Open door warning buzzer	On	Off	—	O	
Smart key system (→P. 93)	Smart key system	On	Off	—	O
	Number of permissible times of continuous smart lock	Twice	Unlimited	—	O
Wireless remote control (→P. 108)	Wireless remote control	On	Off	—	O
	Unlocking operation	Driver's door unlocked in one step, all doors unlocked in two steps	All doors unlocked in one step.	O	O
	Panic function	On	Off	—	O
	Trunk unlocking operation	Press and hold (short)	Off	—	O
Press twice					
One short press					
	Press and hold (long)				

Item	Function	Default setting	Customized setting	①	②
Door lock (→P. 111)	Unlocking using a key	Driver's door unlocked in one step, all doors unlocked in two steps	All doors unlocked in one step.	—	O
	Speed-detecting automatic door lock function	Off	On	O	O
	Opening driver's door unlocks all doors	Off	On	O	O
	Shifting gears to P unlocks all doors.	On	Off	O	O
	Shifting gears to position other than P locks all doors.	On	Off	O	O
Trunk (→P. 114)	Trunk opener main switch	Activated	Deactivated	—	O
Driving position memory* (→P. 119)	Driver's seat movement when exiting the vehicle	Full	Off	O	O
			Partial	O	O
	Doors linked to the driving position memory recall function	Driver's door	All doors	—	O
Engine switch (→P. 159)	Time elapsed before the engine switch related messages on the multi-information display turn off	60 seconds	30 seconds	—	O
			600 seconds		
Turn signal lever (→P. 169)	Times of flashing of the lane change signal flashers	3	4	—	O
			5		
			6		
			7		
			Off		

Item	Function	Default setting	Customized setting	①	②
Automatic light control system (→P. 172)	Light sensor sensitivity	Level 3	Level 1 to 5	<input type="radio"/>	<input type="radio"/>
	Time elapsed before headlights automatically turn off after doors are closed	30 seconds	0 seconds	<input type="radio"/>	<input type="radio"/>
			60 seconds		
		90 seconds			
Lights (→P. 172, 176)	Daytime running light system (except Canada)	On	Off	<input type="radio"/>	<input type="radio"/>
	Automatic high beam*	On	Off	<input type="checkbox"/>	<input type="radio"/>

Item	Function	Default setting	Customized setting	①	②
Illumination (→P. 253)	Interior lights illumination control	On	Off	—	○
	Time elapsed before interior lights turn off*	15 seconds	Off	○	○
			7.5 seconds		
			30 seconds		
	Center console spot light	On	Off	—	○
	Operation when the doors are unlocked	On	Off	—	○
	Operation after the engine switch turned off	On	Off	—	○
	Operation when you approach the vehicle with the electronic key on your person	On	Off	—	○
	Ambient lights*	On	Off	—	○
	Outer foot lights*	On	Off	—	○
	Time elapsed before the outer foot lights turn off*	15 seconds	Off	○	○
			7.5 seconds		
30 seconds					
Enable/disable operation of the outer foot lights when you approach the vehicle with the electronic key on your person*	On	Off	—	○	
Enable/disable operation of the outer foot lights when the doors are unlocked with the power door lock switch*	On	Off	—	○	
Instrument panel (→P. 79)	Instrument panel light auto dimmer control	Level 3	Level 1 to 5	—	○

Item	Function	Default setting	Customized setting	①	②
Automatic air conditioning system (→P. 242)	A/C auto switch operation	Auto	Manual	O	O
Touch button (on the center panel) (→P. 86, 242)	Button sensor sensitivity	Level 3	Level 1 to 3	—	O
Rear sunshade* (→P. 278)	Reverse operation	On	Off	—	O
	Time elapsed before the reverse operation feature activates	0.7 seconds	0 second	—	O
			0.9 seconds		
1.2 seconds					

*: If equipped

⚠ CAUTION

■ **During customization**
 As the engine needs to be running during customization, ensure that the vehicle is parked in a place with adequate ventilation. In a closed area such as a garage, exhaust gases including harmful carbon monoxide (CO) may collect and enter the vehicle. This may lead to death or a serious health hazard.

⚠ NOTICE

■ **During customization**
 To prevent battery discharge, ensure that the engine is running while customizing features.

Items to initialize

The following items must be initialized for normal system operation after such cases as the maintenance being performed on the vehicle:

Item	When to initialize	Reference
Message indicating maintenance is required	<ul style="list-style-type: none">• After the maintenance is performed	P. 310
Tire pressure warning system	<ul style="list-style-type: none">• When changing the tire size• When changing the tire inflation pressure by changing traveling speed or load weight, etc.	P. 336

For owners

9

463

Reporting safety defects
for U.S. owners..... 464

Seat belt instructions
for Canadian owners
(in French) 465

SRS airbag instructions
for Canadian owners
(in French) 467

Reporting safety defects for U.S. owners

If you believe that your vehicle has a defect which could cause a crash or could cause injury or death, you should immediately inform the National Highway Traffic Safety Administration (NHTSA) in addition to notifying Toyota Motor Sales, U.S.A., Inc. (Toll-free: 1-800-331-4331).

If NHTSA receives similar complaints, it may open an investigation, and if it finds that a safety defect exists in a group of vehicles, it may order a recall and remedy campaign. However, NHTSA cannot become involved in individual problems between you, your dealer, or Toyota Motor Sales, U.S.A., Inc.

To contact NHTSA, you may call the Vehicle Safety Hotline toll-free at 1-888-327-4236 (TTY: 1-800-424-9153); go to <http://www.safercar.gov>; or write to: Administrator, NHTSA, 1200 New Jersey Ave, S.E., Washington, DC 20590. You can also obtain other information about motor vehicle safety from <http://www.safercar.gov>.

Seat belt instructions for Canadian owners (in French)

The following is a French explanation of seat belt instructions extracted from the seat belt section in this manual.

See the seat belt section for more detailed seat belt instructions in English.

Utilisation correcte des ceintures de sécurité

- Déroulez la sangle diagonale de telle sorte qu'elle passe bien sur l'épaule, sans pour autant être en contact avec le cou ou glisser de l'épaule.
- Placez la sangle abdominale le plus bas possible sur les hanches.
- Réglez la position du dossier de siège. Asseyez-vous le dos le plus droit possible et calez-vous bien dans le siège.
- Ne vrillez pas la ceinture de sécurité.

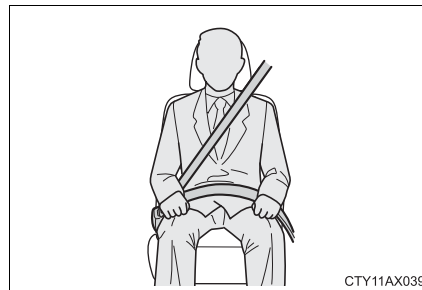

Entretien et soin

■ Ceintures de sécurité

Nettoyez avec un chiffon ou une éponge humectée d'eau savonneuse tiède. Vérifiez régulièrement que les ceintures ne sont pas effilochées, entaillées ou exagérément usées.

 ATTENTION**■ Détérioration et usure des ceintures de sécurité**

Inspectez les ceintures de sécurité périodiquement. Contrôlez qu'elles ne sont pas entaillées, effilochées et que leurs ancrages ne sont pas desserrés. N'utilisez pas une ceinture de sécurité défectueuse avant qu'elle ne soit remplacée. Une ceinture de sécurité défectueuse n'apporte aucune garantie de protection de l'occupant en cas d'accident.

SRS airbag instructions for Canadian owners (in French)

The following is a French explanation of SRS airbag instructions extracted from the SRS airbag section in this manual.

See the SRS airbag section for more detailed SRS airbag instructions in English.

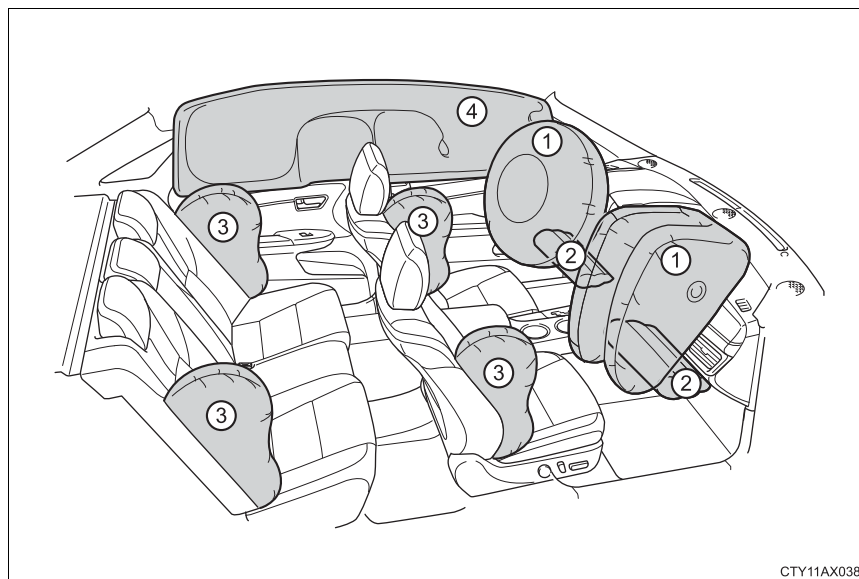

◆ Coussins gonflables frontaux SRS

- ① Le coussin gonflable conducteur/le coussin gonflable passager avant SRS
- ② Coussins gonflables de genoux SRS
Participent à la protection du conducteur et du passager avant

◆ Coussins gonflables latéraux et rideau SRS

- ③ Coussins gonflables avant latéraux SRS
Peuvent aider à protéger le torse des passagers avant
Coussins gonflables arrière SRS latéraux
Participent à la protection du haut du corps des occupants assis
aux places arrière extérieures
- ④ Coussins gonflables rideau SRS
Participent principalement à la protection de la tête des occupants
assis aux places extérieures

Composants du système de coussins gonflables SRS

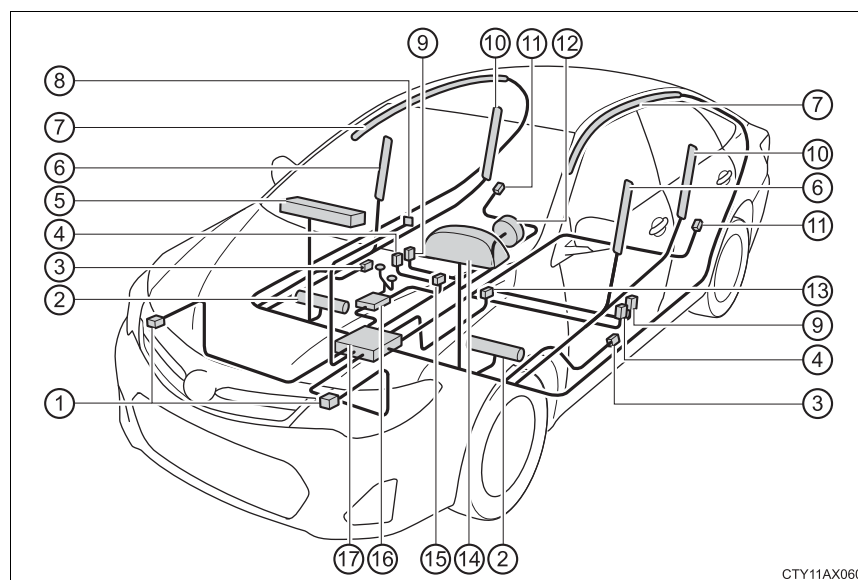

- | | |
|--|---|
| ① Capteurs d'impact avant | ⑪ Capteurs d'impact latéral (arrière) |
| ② Coussins gonflables de genoux | ⑫ Coussin gonflable conducteur |
| ③ Capteurs d'impact latéral (portes avant) | ⑬ Contacteur de boucle de ceinture de sécurité conducteur |
| ④ Prétensionneurs de ceintures de sécurité et limiteurs de force | ⑭ Témoin d'alerte SRS |
| ⑤ Coussin gonflable passager avant | ⑮ Contacteur de boucle de ceinture de sécurité passager avant |
| ⑥ Coussins gonflables latéraux avant | ⑯ Système de classification de l'occupant du siège passager avant (ECU et capteurs) |
| ⑦ Coussins gonflables rideau | ⑰ Boîtier électronique de coussins gonflables |
| ⑧ Témoins indicateurs "AIR BAG ON" et "AIR BAG OFF" | |
| ⑨ Capteurs d'impact latéral (avant) | |
| ⑩ Coussins gonflables arrière | |

Votre véhicule est équipé de COUSSINS GONFLABLES INTELLIGENTS conçus selon les normes de sécurité américaines applicables aux véhicules à moteur (FMVSS208). Le boîtier électronique (ECU) des coussins gonflables régule le déploiement de ces derniers sur la base des informations qu'il reçoit des capteurs, etc., indiqués ci-dessus dans le schéma illustrant les composants du système. Parmi ces informations figurent la gravité du choc et l'occupation du véhicule par les passagers. Le déploiement rapide des coussins gonflables est obtenu au moyen d'une réaction chimique dans les dispositifs pyrotechniques, qui produit un gaz inoffensif permettant d'amortir le mouvement des occupants.

 **ATTENTION**

■ **Précautions concernant les coussins gonflables SRS**

Respectez les précautions suivantes avec les coussins gonflables SRS. Autrement, des blessures graves, voire mortelles, pourraient s'ensuivre.

- Le conducteur et les passagers du véhicule doivent porter correctement leur ceinture de sécurité.
Les coussins gonflables SRS sont des dispositifs supplémentaires à utiliser avec les ceintures de sécurité.

- Le coussin gonflable SRS conducteur se déploie avec une violence considérable, qui peut être très dangereuse, voire mortelle, si le conducteur se trouve très près du coussin gonflable. L'autorité fédérale chargée de la sécurité routière aux États-Unis (NHTSA) conseille:

Sachant que la zone de danger pour le coussin gonflable conducteur se trouve dans les premiers 2 à 3 in. (50 - 75 mm) de déploiement, vous placer à 10 in. (250 mm) de votre coussin gonflable conducteur vous garantit une marge de sécurité suffisante. Cette distance est à mesurer entre l'axe du volant et le sternum. Si vous êtes assis à moins de 10 in. (250 mm), vous pouvez changer votre position de conduite de plusieurs façons:

- Reculez votre siège le plus possible, de manière à pouvoir encore atteindre confortablement les pédales.
- Inclinez légèrement le dossier du siège.
Bien que les véhicules puissent être différents les uns des autres, la plupart des conducteurs peuvent s'asseoir à une distance de 10 in. (250 mm), même avec le siège conducteur complètement avancé, simplement en inclinant un peu le dossier de siège. Si vous avez des difficultés à voir la route après avoir incliné votre siège, utilisez un coussin ferme et antidérapant pour vous rehausser ou, si votre véhicule est équipé du réglage en hauteur du siège, remontez-le.
- Si votre volant est réglable, inclinez-le vers le bas. Cela a pour effet d'orienter le coussin gonflable en direction de votre poitrine plutôt que de votre tête et de votre cou.

Régalez votre siège selon ces recommandations de la NHTSA, tout en conservant le contrôle des pédales, du volant et la vue des commandes du tableau de bord.

ATTENTION

■ Précautions concernant les coussins gonflables SRS

● Si vous attachez une rallonge de ceinture de sécurité aux boucles de ceinture de sécurité avant, mais pas au pêne de la ceinture de sécurité, les coussins gonflables avant SRS détectent que le conducteur et le passager avant ont attaché leur ceinture de sécurité, alors même que ce n'est pas le cas. Dans ce cas, il se peut que les coussins gonflables avant SRS ne se déploient pas correctement en cas de collision et vous risquez d'être tué ou grièvement blessé. Veillez à porter la ceinture de sécurité avec la rallonge de ceinture de sécurité.

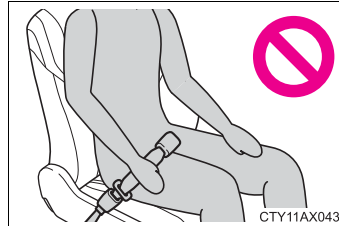

● Le coussin gonflable SRS passager avant se déploie également avec une violence considérable, qui peut être très dangereuse, voire mortelle, si le passager avant se trouve très près du coussin gonflable. Éloignez le siège du passager avant au maximum du coussin gonflable et réglez le dossier de siège de façon à être assis bien droit dans le siège.

● Les nourrissons et les enfants qui ne sont pas correctement assis et/ou protégés peuvent être grièvement blessés ou tués par le déploiement d'un coussin gonflable. Installez dans un siège de sécurité enfant les nourrissons et les enfants trop petits pour pouvoir utiliser la ceinture de sécurité. Toyota recommande vivement que les nourrissons et les jeunes enfants soient installés sur le siège arrière du véhicule et convenablement attachés. Les sièges arrière sont plus sûrs pour les nourrissons et les enfants que le siège du passager avant.

● N'installez jamais un siège de sécurité enfant type dos à la route sur le siège du passager avant, même si le témoin indicateur "AIR BAG OFF" est allumé.

En cas d'accident, par la violence et la vitesse de son déploiement, le coussin gonflable passager avant peut blesser grièvement, voire tuer l'enfant si le siège de sécurité enfant type dos à la route est installé sur le siège du passager avant.

ATTENTION

■ Précautions concernant les coussins gonflables SRS

- Ne vous asseyez pas sur le bord du siège et ne vous appuyez pas contre le tableau de bord.

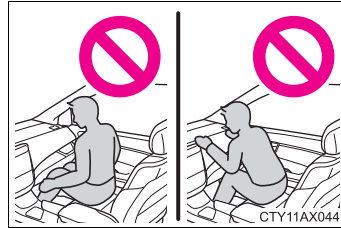

- Ne laissez pas un enfant rester debout devant le coussin gonflable SRS passager avant ou bien s'asseoir sur les genoux du passager avant.

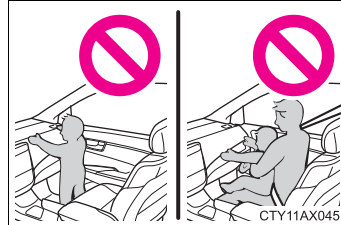

- Ne laissez pas les occupants des sièges avant voyager avec un objet sur les genoux.

- Ne vous appuyez pas contre la porte, contre le rail latéral de toit ou contre les montants avant, latéraux et arrière.



- Ne laissez personne s'agenouiller sur les sièges passagers en appui contre la porte ou sortir la tête ou les mains à l'extérieur du véhicule.

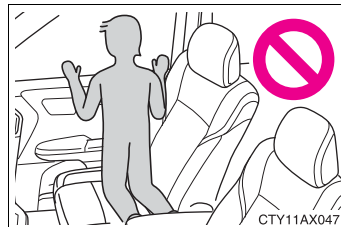

- Ne fixez ni ne posez aucun objet sur le tableau de bord, la garniture du volant de direction et la partie inférieure du tableau de bord.

Au déploiement des coussins gonflables conducteur SRS, passager avant et genoux, tout objet risque de se transformer en projectile.

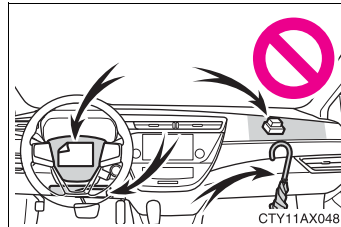

ATTENTION

■ **Précautions concernant les coussins gonflables SRS**

- Ne fixez rien aux portes, à la vitre du pare-brise, aux vitres latérales, aux montants avant et arrière, au rail latéral de toit et à la poignée d'assistance.

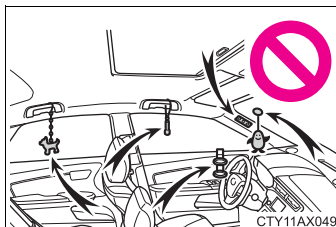

- Ne suspendez aucun cintre ni objet dur aux crochets à vêtements. En cas de déploiement des coussins gonflables rideau SRS, tous ces objets pourraient se transformer en projectiles et causer des blessures graves, voire mortelles.
- Si un cache en vinyle recouvre la partie où le coussin gonflable de genoux SRS se déploie, veuillez à l'enlever.
- N'utilisez aucun accessoire de siège venant recouvrir les zones de déploiement des coussins gonflables latéraux SRS, car il risquerait d'en gêner le déploiement. De tels accessoires peuvent empêcher les coussins gonflables latéraux de fonctionner correctement, désactiver le dispositif ou entraîner le déploiement accidentel des coussins gonflables latéraux, ce qui pourrait entraîner la mort ou des blessures graves.
- Ne faites pas subir de chocs ou de pressions excessives aux zones renfermant les composants des coussins gonflables SRS. En effet, cela pourrait entraîner un fonctionnement anormal des coussins gonflables SRS.
- Ne touchez aucun composant du système immédiatement après le déploiement (gonflage) des coussins gonflables SRS, car ils peuvent être chauds.
- Si vous avez des difficultés à respirer après le déploiement des coussins gonflables SRS, ouvrez une porte ou une vitre pour faire entrer de l'air frais, ou bien descendez du véhicule si cela ne présente pas de danger. Essayez tout résidu dès que possible afin d'éviter d'éventuelles irritations de la peau.
- Si les parties renfermant les coussins gonflables SRS, telles que la garniture du volant et les garnitures de montants avant et arrière, sont abîmées ou craquelées, faites-les remplacer par votre concessionnaire Toyota.

⚠ ATTENTION**■ Modification et mise au rebut des éléments du système de coussins gonflables SRS**

Consultez impérativement votre concessionnaire Toyota avant de mettre votre véhicule au rebut ou de procéder à l'une des modifications suivantes. Les coussins gonflables SRS peuvent être défaillants ou se déployer (se gonfler) accidentellement, provoquant la mort ou de graves blessures.

- Installation, dépose, démontage et réparation des coussins gonflables SRS
- Réparations, modifications, démontage ou remplacement du volant, du tableau de bord, de la planche de bord, des sièges ou de leur garniture, des montants avant, latéraux et arrière ou des rails latéraux de toit
- Réparations ou modifications des ailes avant, du pare-chocs avant ou des flancs de l'habitacle
- Installation d'un protège-calandre (pare-buffles, pare-kangourou, etc.), de chasse-neige, de treuils
- Modifications du système de suspension du véhicule
- Installation d'appareils électroniques, tels qu'un émetteur/récepteur radio mobile ou un lecteur CD
- Aménagements du véhicule visant à permettre sa conduite par une personne atteinte d'un handicap physique

Index

477

What to do if...
(Troubleshooting) 478
Alphabetical index 484

For details of equipment related to the audio/navigation system, refer to the “NAVIGATION AND MULTIMEDIA SYSTEM OWNER’S MANUAL”.

What to do if... (Troubleshooting)

If you have a problem, check the following before contacting your Toyota dealer.

The doors cannot be locked, unlocked, opened or closed



You lose your keys

- If you lose your mechanical keys, new genuine mechanical keys can be made by your Toyota dealer. (→P. 91)
 - If you lose your electronic keys, the risk of vehicle theft increases significantly. Contact your Toyota dealer immediately. (→P. 92)
-



The doors cannot be locked or unlocked

- Is the electronic key battery weak or depleted? (→P. 350)
- Is the engine switch in IGNITION ON mode?
When locking the doors, turn the engine switch off.
(→P. 160)
- Is the electronic key left inside the vehicle?
When locking the doors, make sure that you have the electronic key on your person.
- The function may not operate properly due to the condition of the radio wave. (→P. 102)

**The rear door cannot be opened**

- Is the child-protector lock set?

The rear door cannot be opened from inside the vehicle when the lock is set. Open the rear door from outside and then unlock the child-protector lock. (→P. 112)

**The trunk lid is closed with the electronic key left inside**

- The function to prevent the electronic key from being left inside the trunk will operate and you can open the trunk as usual. Take the key out from the trunk. (→P. 94)

If you think something is wrong



The engine does not start

- Did you press the engine switch while firmly depressing the brake pedal? (→P. 159)
 - Is the shift lever in P? (→P. 162)
 - Is the electronic key anywhere detectable inside the vehicle? (→P. 96)
 - Is the steering wheel unlocked? (→P. 163)
 - Is the electronic key battery weak or depleted?
In this case, the engine can be started in a temporary way.
(→P. 417)
 - Is the battery discharged? (→P. 419)
-



The shift lever cannot be shifted from P even if you depress the brake pedal

- Is the engine switch in IGNITION ON mode?
If you cannot release the shift lever by depressing the brake pedal with the engine switch in IGNITION ON mode
(→P. 415)
-



The steering wheel cannot be turned after the engine is stopped

- It is locked automatically to prevent theft of the vehicle.
(→P. 162)

**The windows do not open or close by operating the power window switches**

- Is the window lock switch pressed?
The power window except for the one at the driver's seat cannot be operated if the window lock switch is pressed. (→P. 134)
-

**The engine switch is turned off automatically**

- The auto power off function will be operated if the vehicle is left in ACCESSORY or IGNITION ON mode (the engine is not running) for a period of time. (→P. 162)
-

**A warning buzzer sounds during driving**

- The seat belt reminder light is flashing
Are the driver and the front passenger wearing the seat belts?
(→P. 391)
 - The brake system warning light is on
Is the parking brake released? (→P. 170)
- Depending on the situation, other types of warning buzzer may also sound. (→P. 388, 399)



An alarm is activated and the horn sounds

- Did anyone inside the vehicle open a door during setting the alarm?

The sensor detects it and the alarm sounds. (→P. 68)

To stop the alarm, turn the engine switch to IGNITION ON mode or start the engine.



A warning buzzer sounds when leaving the vehicle

- Is the electronic key left inside the vehicle or the moon roof opened?

Check the message on the multi-information display.



A warning light turns on or a warning message is displayed

- When a warning light turns on, refer to P. 388.
- When a warning message is displayed, perform the correction procedure appropriate to the message.

When a problem has occurred**If you have a flat tire**

- Stop the vehicle in a safe place and replace the flat tire with the spare tire. (→P. 400)
-

**The vehicle becomes stuck**

- Try the procedure for when the vehicle becomes stuck in mud, dirt, or snow. (→P. 426)

Alphabetical index

A

- A/C** 242
 - Air conditioning filter 348
 - Automatic air conditioning system 242
- ABS**
 - (Anti-lock Brake System)**..... 215
 - Function 215
 - Warning light..... 389
 - Air conditioning filter** 348
 - Air conditioning system**..... 242
 - Air conditioning filter 348
 - Air conditioning system 242
 - Airbags** 34
 - Airbag operating conditions 41
 - Airbag precautions
 - for your child..... 36
 - Airbag warning light 389
 - Correct driving posture 26
 - Curtain shield airbag
 - operating conditions 41
 - Curtain shield airbag precautions..... 38
 - Front passenger occupant classification system..... 44
 - General airbag precautions 36
 - Locations of airbags..... 34
 - Modification and disposal of airbags..... 40
 - Side airbag operating conditions 41
 - Side airbag precautions 36
 - Side and curtain shield airbags
 - operating conditions 41
 - Side and curtain shield airbags precautions 36
 - SRS airbags..... 34
- Alarm** 68
 - Alarm 68
 - Warning buzzer 388
- Anchor brackets**..... 55
- Antennas**
 - (smart key system)** 95
- Anti-lock Brake System (ABS)**..... 215
 - Function..... 215
 - Warning light..... 389
- Approach warning (dynamic radar cruise control)**..... 204
- Armrest**..... 277
- Armrest door**..... 280
- Assist grips**..... 282
- Audio system***
- Automatic headlight leveling system**..... 175
- Automatic high beam**..... 176
- Automatic light control system**..... 172
- Automatic transmission** 165
 - If the shift lever cannot be shifted from P 415
 - Paddle shift switches 166
 - S mode 166
- AUX port***
- Auxiliary boxes**..... 260

B

Back-up lights
 Replacing light bulbs..... 373
 Wattage 438
Battery 330
 Battery checking 330
 If the vehicle battery
 is discharged 419
 Preparing and checking
 before winter..... 236
 Warning light..... 389
Brake
 Fluid 329
 Parking brake..... 170
 Warning light..... 388
Brake assist 215
Break-in tips..... 144
Brightness control
 Instrument panel light
 control..... 79
BSM (Blind Spot Monitor)..... 227

C

Care 302, 306
 Aluminum wheels 303
 Exterior 302
 Interior 306
 Seat belts..... 307
Cargo capacity..... 156
Cargo net..... 265
Chains 238
Child restraint system..... 51
 Booster seats, definition 52
 Booster seats, installation..... 61
 Convertible seats, definition ... 52
 Convertible seats,
 installation 58
 Front passenger occupant
 classification system 44
 Infant seats, definition..... 52
 Infant seats, installation 58
 Installing CRS
 with LATCH anchors 56
 Installing CRS with seat
 belts..... 58
 Installing CRS
 with top tether strap..... 62

*: Refer to the "NAVIGATION AND MULTIMEDIA SYSTEM OWNER'S MANUAL".

Child-protectors..... 112
Child safety 50
 Airbag precautions..... 36
 Battery precautions..... 331, 422
 Child restraint system 51
 How your child should
 wear the seat belt 30
 Installing child restraints 55
 Moon roof precautions 140
 Power window lock switch 134
 Power window precautions ... 136
 Rear door child-protectors 112
 Removed electronic
 key battery precautions 351
 Seat belt extender
 precautions..... 33
 Seat belt precautions 54
 Seat heater precautions..... 276
 Trunk precautions 116
Cleaning 302, 306
 Aluminum wheels..... 303
 Exterior 302
 Interior..... 306
 Seat belts..... 307
Clock..... 268
Coat hooks 281
Compass 296
Condenser..... 328
Console box 258

Cooling system
 Engine overheating..... 423
Cruise control
 Cruise control 194
 Dynamic radar cruise
 control 198
Cup holders 259
Curtain shield airbags..... 34
Customizable features 455

D

**Daytime running light
 system..... 174**
Defogger
 Front windshield 247
 Outside rear view mirrors 252
 Rear window..... 252
Dimension 430
Dinghy towing..... 158
Display
 Cruise control 194
 Dynamic radar cruise
 control 198
 Multi-information display 80
 Trip information..... 81
 Warning message..... 399

Do-it-yourself maintenance	316
Door courtesy lights	
Wattage	438
Doors	111
Automatic door locking and unlocking system.....	113
Door glasses.....	134
Door lock.....	111
Open door warning buzzer	97
Open door warning light.....	391
Outside rear view mirrors.....	131
Rear door child-protector	112
Driver's seat position	
memory	120
Driving	142
Break-in tips.....	144
Correct driving posture	26
Driving mode select switch ...	213
Procedures	142
Winter drive tips.....	236
Dynamic radar cruise	
control.....	198

E

Eco Drive Indicator.....	144
Eco drive mode.....	213
EDR (Event data recorder).....	10
Electric Power Steering	
(EPS)	215
Function.....	215
Warning light.....	390
Electronic key	90
Battery-saving function	101
If the electronic key does not operate properly	416
Replacing the battery.....	350
Emergency flashers	380
Emergency, in case of	
If the electronic key does not operate properly	416
If the engine will not start.....	413
If the shift lever cannot be shifted from P	415
If the trunk opener is not actuated	116
If the vehicle battery is discharged.....	419
If the warning buzzer sounds.....	388

- If the warning light turns on 388
- If the warning message is displayed..... 399
- If you have a flat tire 400
- If you think something is wrong 386
- If your vehicle becomes stuck 426
- If your vehicle has to be stopped in an emergency ... 381
- If your vehicle needs to be towed..... 382
- If your vehicle overheats..... 423
- Engine**
- ACCESSORY mode 160
- Compartment 322
- Engine switch..... 159
- Hood 319
- How to start the engine 159
- Identification number 431
- If the engine will not start 413
- Ignition switch (engine switch) 159
- Overheating 423
- Engine coolant..... 326**
- Capacity..... 434
- Checking..... 326
- Preparing and checking before winter 236
- Engine coolant temperature gauge 77**
- Engine immobilizer system 66**
- Engine oil 323**
- Capacity..... 432
- Checking..... 323
- Preparing and checking before winter 236
- Engine switch 159**
- EPS**
- (Electronic Power Steering) 215**
- Function..... 215
- Warning light..... 390
- Event data recorder (EDR)..... 10**

F

Flat tire..... 400
Floor mats 24
Fluid
 Automatic transmission..... 435
 Brake 436
 Washer 333
Fog lights 181
 Replacing light bulbs..... 366
 Switch 181
 Wattage 438
Front passenger occupant classification system 44
Front personal lights..... 254
Front seats 118
 Adjustment..... 118
 Cleaning..... 306
 Correct driving posture 26
 Driving position memory 120
 Head restraints 125
 Power easy access system 119
 Seat heaters 274
 Seat position memory 120
 Seat ventilators 274
Front side marker lights..... 172
 Light switch 172
 Replacing light bulbs..... 375

Front turn signal lights 169
 Replacing light bulbs 369
 Turn signal lever 169
 Wattage 438
Fuel 432
 Capacity..... 432
 Fuel gauge..... 77
 Fuel pump shut off system ... 387
 Information..... 439
 Refueling 189
 Type..... 189, 432
 Warning light..... 391
Fuel filler door 189
 If the fuel filler door cannot be opened 192
 Refueling 189
Fuel pump shut off system..... 387
Fuses 352

G

Garage door opener 283
Gauges 77
Glove box 257
Grocery bag hooks..... 265

H

Head restraints 125

Headlights 172

 Automatic high beam 176

 Discharge headlights

 precautions..... 378

 Light switch 172

 Replacing light

 bulbs..... 364, 365, 375

 Wattage 438

Heaters

 Air conditioning system..... 242

 Outside rear view mirrors..... 252

 Seat heaters 274

Hood 319

Hooks

 Coat hooks..... 281

 Grocery bag hooks 265

 Retaining hooks (floor mat)..... 24

Horn 171

I

I/M test 315

Identification

 Engine 431

 Vehicle..... 431

Ignition switch

(engine switch)..... 159

Illuminated entry system 255

Immobilizer system 66

Indicators 75

Initialization

 Maintenance 310

 Tire pressure

 warning system 335

Inside rear view mirror..... 129

Instrument panel light

control..... 79

Interior lights 253

J

Jack

 Positioning a floor jack..... 320

 Vehicle-equipped jack 401

Jack handle..... 401

Jam protection function

 Moon roof 138

 Power windows..... 135

K

Keyless entry 93
 Smart key system 93
 Wireless remote control 108
Keys 90
 Battery-saving function 101
 Electronic key 90
 Engine switch 159
 If the electronic key
 does not operate
 properly 416
 Key number plate 90
 Keyless entry 93, 108
 Mechanical key 90
 Replacing the battery 350
 Warning buzzer 97
 Wireless remote control
 key 108
Knee airbags 34

L

**Language
 (multi-information display) 83**
LATCH anchors 56
Lever
 Auxiliary catch lever 319
 Hood lock release lever 319
 Internal trunk release lever ... 115
 Shift lever 165
 Turn signal lever 169
 Wiper lever 183

License plate lights 172
 Light switch 172
 Replacing light bulbs 374
 Wattage 438
Light bulbs
 Replacing 364
 Wattage 438
Lights
 Automatic high beam 176
 Fog light switch 181
 Headlight switch 172
 Illuminated entry system 255
 Interior light 254
 Interior lights list 253
 Personal lights 254
 Replacing light bulbs 364
 Trunk light 115
 Turn signal lever 169
 Vanity lights 267
 Wattage 438
Load capacity 156
Lock steering column 162
Low profile tire 338
Luggage hook 265
Luggage net 265
Luggage security system 115

M**Maintenance**

- Do-it-yourself maintenance... 316
- General maintenance 311
- Maintenance data 430
- Maintenance requirements ... 309
- Resetting the message
indicating maintenance
is required..... 310

Malfunction indicator lamp..... 389**Master warning light..... 391****Meter 77**

- Indicators 75
- Instrument panel light
control..... 79
- Meters..... 77
- Multi-information display 80
- Warning lights 73

Mirrors

- Inside rear view mirror 129
- Outside rear view mirror
defoggers 252
- Outside rear view mirrors..... 131
- Vanity mirrors..... 267

Moon roof 137

- Jam protection function..... 138
- Operation 137

Multi-information display 80

- Cruise control..... 194
- Dynamic radar cruise
control..... 198
- Language..... 83
- Switching the display 81
- Trip information..... 81
- Warning message..... 399

N**Navigation system*****Noise from under vehicle 8****O****Odometer 77****Oil**

- Engine oil..... 432

Opener

- Hood 319
- Trunk 114

Outer foot lights 253**Outside rear view mirrors..... 131**

- Adjusting and folding 131
- Blind spot monitor..... 227
- Linked mirror function
when reversing..... 132
- Mirror position memory 120

- Outside rear view
mirror defoggers..... 252

Overheating, Engine 423

P

Paddle shift switches	166
Parking brake	170
Operation	170
Parking brake engaged warning buzzer	388
Parking lights	172
Light switch	172
Replacing light bulbs	369
PCS (Pre-Collision System)	220
Function	220
PCS OFF switch	221
Warning light	390
Personal lights	254
Power easy access system	119
Power outlets	271
Power steering (Electric Power Steering system)	215
Warning light	390
Power windows	134
Jam protection function	135
Operation	134
Window lock switch	134
Pre-Collision System (PCS)	220
Function	220
PCS OFF switch	221
Warning light	390

R

Radar cruise control (dynamic radar cruise control)	198
Radiator	328
Rear personal lights	254
Rear seat heaters	275
Rear sunshade	278
Rear turn signal lights	169
Replacing light bulbs	371
Turn signal lever	169
Wattage	438
Rear view mirror	
Inside rear view mirror	129
Outside rear view mirrors	131
Rear view monitor system*	
Rear window defoggers	252
Refueling	189
Capacity	432
Fuel types	432
If the fuel filler door cannot be opened	192
Opening the fuel tank cap	191
Replacing	
Electronic key battery	350
Fuses	352
Light bulbs	361
Tires	400
Reporting safety defects for U.S. owners	464
Resetting the message indicating maintenance is required	310

*: Refer to the "NAVIGATION AND MULTIMEDIA SYSTEM OWNER'S MANUAL".

S

Safety Connect	290
Seat belts.....	28
Adjusting the seat belt	29
Automatic Locking	
Retractor.....	30
Child restraint system	
installation	58
Cleaning and maintaining	
the seat belt.....	307
Emergency Locking	
Retractor.....	30
How to wear your seat belt	28
How your child should wear	
the seat belt.....	30
Pre-collision seat belts.....	29
Pregnant women, proper	
seat belt use	31
Reminder light and buzzer....	391
Seat belt extender.....	30
Seat belt pretensioners.....	29
SRS warning light	389
Seat heaters	274
Seat position memory	120
Seat ventilators.....	274
Seating capacity	156

Seats.....	118
Adjustment.....	118
Adjustment precautions	119
Child seats/child restraint	
system installation.....	55
Cleaning	306
Driving position memory	120
Head restraints	125
Power easy access	
system.....	119
Properly sitting in the seat	26
Seat heaters	274
Seat position memory.....	120
Seat ventilators.....	274
Sensor	
Automatic headlight	
system.....	174
Automatic high beam.....	176
Inside rear view mirror	130
Radar sensor	207, 221, 229
Rain-sensing windshield	
wipers.....	187

Service reminder indicators	72
Shift lever	165
Automatic transmission.....	165
If the shift lever cannot be shifted from P	415
Shift lock system	415
Side airbags	34
Side marker lights	172
Light switch	172
Replacing light bulbs.....	375
Side mirrors	131
Adjusting and folding	131
Blind Spot Monitor	227
Linked mirror function when reversing	132
Mirror position memory	120
Side turn signal lights	169
Replacing light bulbs.....	375
Turn signal lever	169
Smart key system	93
Antenna location	95
Entry functions	93
Starting the engine.....	159
Snow tires	239
Spare tire	400
Inflation pressure	437
Storage location.....	401
Spark plug	434
Specifications	430
Speedometer	77
Steering lock	162
Column lock release	163
Steering wheel	128
Stop lights Replacing light bulbs	375
Storage feature	256
Stuck If the vehicle becomes stuck.....	426
Sun shade Rear	278
Roof	138
Sun visors	267

Switches

- | | |
|--------------------------------|-----|
| BSM (Blind spot monitor) | |
| switch | 227 |
| Compass switch..... | 296 |
| Cruise control switch..... | 194 |
| “DISP” button | 81 |
| Door lock switches..... | 111 |
| Driving mode select switch ... | 213 |
| Driving position memory | |
| switches..... | 120 |
| Dynamic radar cruise | |
| control switch..... | 198 |
| Emergency flashers switch ... | 380 |
| Engine switch..... | 159 |
| Fog light switch | 181 |
| Garage door opener | |
| switches..... | 283 |
| Ignition switch | 159 |
| Light switches | 172 |
| Moon roof switches..... | 137 |
| Outside rear view mirror | |
| switches..... | 131 |
| Paddle shift switches | 166 |
| PCS OFF switch | 221 |
| Power door lock switch..... | 111 |
| Power window switches..... | 134 |
| Rear sunshade switch | 278 |
| Rear window and outside | |
| rear view mirror defoggers | |
| switch | 252 |
| Seat heater switches | 274 |
| Seat ventilator switches..... | 274 |
| “SOS” button..... | 290 |
| Tire pressure warning reset | |
| switch | 336 |
| Trunk opener main switch ... | 115 |
| Trunk opener switch | 114 |
| Vehicle-to-vehicle distance | |
| button | 201 |
| VSC/TRAC OFF switch | 216 |
| Window lock switch | 134 |
| Windshield wipers | |
| and washer switch..... | 183 |

T

Tachometer 77
Tail lights 172
 Light switch 172
 Replacing light bulbs..... 375
Theft deterrent system
 Alarm 68
 Engine immobilizer system 66
Tire inflation pressure..... 437
 Maintenance data 437
 Warning light..... 392
Tire information 442
 Glossary..... 449
 Size..... 445
 Tire identification number 444
 Uniform Tire Quality
 Grading..... 447
**Tire pressure warning
 system..... 335**
 Function 335
 Initializing..... 335
 Installing tire pressure
 warning valves and
 transmitters..... 335
 Registering ID codes 337
 Tire pressure warning reset
 switch 336
 Warning light..... 392

Tires..... 334
 Chains 238
 Checking..... 334
 If you have a flat tire 400
 Inflation pressure 437
 Information..... 442
 Replacing..... 400
 Rotating tires 334
 Size..... 437
 Snow tires..... 239
 Spare tire 400
 Tire pressure warning
 system..... 335
 Warning light..... 392
Tools..... 401
Top tether strap 62
Total load capacity 156
Towing
 Dinghy towing 158
 Emergency towing 382
 Trailer towing 157
**TOYOTA PARKING ASSIST
 MONITOR***
TRAC (Traction Control) 215
Transmission 165
 Automatic transmission 165
 Driving mode select switch... 213
 If the shift lever cannot be
 shifted from P 415
 Paddle shift switches 166
 S mode 166
Trip information..... 81
Trip meters..... 77

*: Refer to the "NAVIGATION AND MULTIMEDIA SYSTEM OWNER'S MANUAL".

Trunk.....	114
Internal trunk release lever ...	115
Luggage security system	115
Smart key system	94
Trunk features.....	265
Trunk handle.....	114
Trunk light	115
Trunk opener main switch.....	115
Trunk opener switch	114
Trunk storage extension	280
Wireless remote control	108
Trunk light	
Trunk light	115
Wattage	438
Turn signal lights.....	169
Replacing light bulbs.....	369, 371
Turn signal lever	169
Wattage	438

U

USB port*

V**Vanity lights**

Vanity lights

Wattage

Vanity mirrors

Vehicle data recording.....

Vehicle identification

number

Vehicle Stability Control

(VSC)

Ventilators

(seat ventilators)

VSC

(Vehicle Stability Control)

W

Warning buzzers
 Approach warning..... 204
 Brake system 388
 Downshifting 168
 Seat belt reminder 391

Warning lights..... 73
 ABS..... 389
 Brake system 388
 Charging system..... 389
 Electric power steering 390
 Low engine oil pressure..... 389
 Low fuel level 391
 Malfunction indicator lamp 389
 Master warning light..... 391
 Open door..... 391
 Parking brake indicator 388
 Pre-collision system..... 390
 Seat belt reminder light..... 391
 Slip indicator 390
 SRS 389
 Tire pressure..... 392

Warning messages..... 399

Washer..... 183
 Checking..... 333
 Preparing and checking
 before winter..... 236
 Switch 183

Washing and waxing 302

Weight
 Cargo capacity..... 156
 Load limits 156
 Weight 430

Wheels..... 345
 Replacing wheels 345
 Size..... 437

Window glasses 134

Window lock switch 134

Windows..... 134
 Power windows..... 134
 Rear window defogger..... 252

Windshield wipers..... 183
 Intermittent windshield
 wipers with interval
 adjuster 183
 Rain-sensing windshield
 wipers..... 185

Winter driving tips..... 236

**Wireless remote control
 key..... 108**
 Battery-Saving Function 101
 Locking/Unlocking 108
 Replacing the battery..... 350

*: Refer to the "NAVIGATION AND MULTIMEDIA SYSTEM OWNER'S MANUAL".

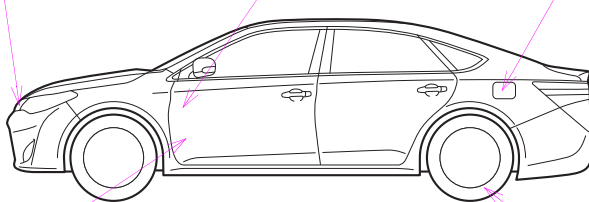
GAS STATION INFORMATION		
Auxiliary catch lever P. 319	Trunk opener P. 114	Fuel filler door P. 191
 <p style="text-align: right; font-size: small;">CTYPIAX004</p>		
Hood lock release lever P. 319	Tire inflation pressure P. 437	
Fuel tank capacity (Reference)	17.0 gal. (64.35 L, 14.2 Imp. gal.)	
Fuel type	Unleaded gasoline only	P. 189, 432
Cold tire inflation pressure		P. 437
Engine oil capacity (Drain and refill — reference)		P. 432
Engine oil type		P. 432